

# 400Amp AC Clamp Meter + NCV

Model MA430

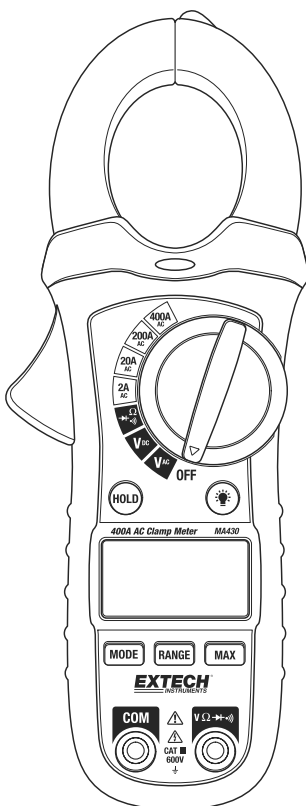

# Introduction

---

Congratulations on your purchase of this Extech MA430 Clamp Meter. This meter measures AC Current, AC/DC Voltage, Resistance, Diode Test, Continuity and Non-Contact Voltage detection. The double molded case is designed for heavy duty use. This device is shipped fully tested and calibrated and, with proper use, will provide years of reliable service. Please visit our website ([www.extech.com](http://www.extech.com)) to check for the latest version of this User Guide, Product Updates, and Customer Support.

## Safety

### International Safety Symbols



This symbol, adjacent to another symbol or terminal, indicates the user must refer to the manual for further information.



This symbol, adjacent to a terminal, indicates that, under normal use, hazardous voltages may be present



Double insulation



This **WARNING** symbol indicates a potentially hazardous situation, which if not avoided, could result in death or serious injury.



This **CAUTION** symbol indicates a potentially hazardous situation, which if not avoided, may result damage to the product.

### PER IEC1010 OVERVOLTAGE INSTALLATION CATEGORY

#### OVERVOLTAGE CATEGORY I

Equipment of OVERVOLTAGE CATEGORY I is equipment for connection to circuits in which measurements are taken to limit the transient overvoltages to an appropriate low level.

Note – Examples include protected electronic circuits.

#### OVERVOLTAGE CATEGORY II

Equipment of OVERVOLTAGE CATEGORY II is energy-consuming equipment to be supplied from the fixed installation.

Note – Examples include household, office, and laboratory appliances.

#### OVERVOLTAGE CATEGORY III

Equipment of OVERVOLTAGE CATEGORY III is equipment in fixed installations.

Note – Examples include switches in the fixed installation and some equipment for industrial use with permanent connection to the fixed installation.

#### OVERVOLTAGE CATEGORY IV

Equipment of OVERVOLTAGE CATEGORY IV is for use at the origin of the installation.

Note – Examples include electricity meters and primary over-current protection equipment

## SAFETY NOTES

- Do not exceed the maximum allowable input range of any function.
- Do not apply voltage to meter when resistance function is selected.
- Set the function switch OFF when the meter is not in use.
- Remove the battery if meter is to be stored for longer than 60 days.

## WARNINGS

- Set function switch to the appropriate position before measuring.
- When measuring volts do not switch to current/resistance modes.
- Do not measure current on a circuit whose voltage exceeds 600V.
- When changing ranges always disconnect the test leads from the circuit under test.

## CAUTIONS

- Improper use of this meter can cause damage, shock, injury or death. Read and understand this user manual before operating the meter.
- Always remove the test leads before replacing the battery or fuses.
- Inspect the condition of the test leads and the meter itself for any damage before operating the meter. Repair or replace any damage before use.
- Use great care when making measurements if the voltages are greater than 25VAC rms or 35VDC. These voltages are considered a shock hazard.
- Always discharge capacitors and remove power from the device under test before performing Diode, Resistance or Continuity tests.
- Voltage checks on electrical outlets can be difficult and misleading because of the uncertainty of connection to the recessed electrical contacts. Other means should be used to ensure that the terminals are not "live".
- If the equipment is used in a manner not specified by the manufacturer, the protection provided by the equipment may be impaired.

Function	Maximum Input
AC Amps,	400A
AC/DC Volts	600V DC/AC
Resistance, Diode Test, Continuity	250V DC/AC



# Description

## Meter Description

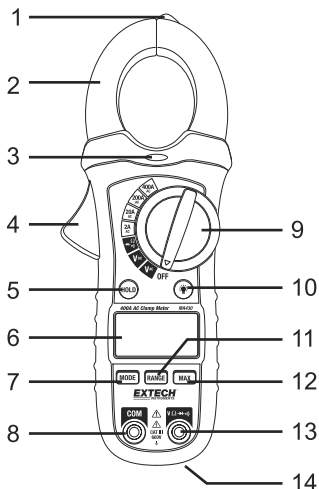
1. NCV sensor
2. Current clamp
3. Non-contact AC voltage indicator light
4. Clamp trigger
5. Data Hold button
6. LCD display
7. MODE select button
8. COM input jack
9. Rotary Function switch
10. Backlight button
11. Range button
12. MAX button
13. V  $\Omega$  Hz jack
14. Battery Cover (rear)



## Display icons Description

HOLD	Data Hold
AUTO	Autoranging
MAX	Max hold
DC	Direct Current
AC	Alternating Current
	Low battery
V	Volts (Voltage)
$\Omega$	Ohms (Resistance)
A	Amperes (Current)
m, M, k	Unit of measure prefixes
•))	Continuity test
	Diode test

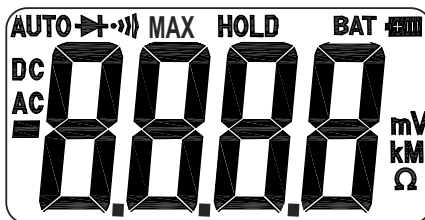

## Operation

**NOTES:** Read and understand all **Warning** and **Caution** statements in this operation manual prior to using this meter. Set the function select switch to the OFF position when the meter is not in use.

### Non-Contact Voltage Detector

**WARNING:** Risk of Electrocution. Before use, always test the Voltage Detector on a known live circuit to verify proper operation.

1. Rotate the Function switch to any position.
2. Place the detector probe tip on the conductor to be tested.
3. If AC voltage is present, the NCV detector light will turn on with a steady red light.

**NOTE:** The conductors in electrical cord sets are often twisted. For best results, move the probe tip along a length of the cord to assure placing the tip in close proximity to the live conductor.

**NOTE:** The detector is designed with high sensitivity. Static electricity or other sources of energy may randomly trip the sensor. This is normal operation.

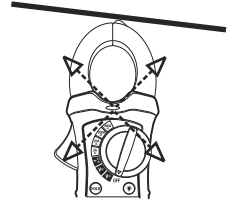

### AC Current Measurements

**WARNING:** Disconnect the test leads before making clamp measurements.

1. Rotate the Function switch to the **400A** position
2. Press the trigger to open jaw. Fully enclose only one conductor.
3. Read the current value in the display.
4. If the value is less than 200A, rotate the function switch to a lower range to improve resolution.

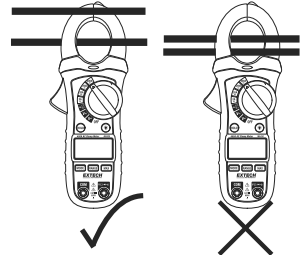

## AC/DC Voltage Measurements

**CAUTION:** Do not measure voltages if a motor on the circuit is being switched ON or OFF. Large voltage surges may occur that can damage the meter.

1. Rotate the function switch to the **VAC** or the **VDC** position.
2. Insert the black test lead banana plug into the negative **COM** jack. Insert the red test lead banana plug into the positive **V** jack.
3. Touch the black test probe tip to the negative side of the circuit. Touch the red test probe tip to the positive side of the circuit.
4. Read the voltage value in the display.



## Resistance, Diode, Continuity Measurements

Note: Remove power from the device under test before making resistance measurements

1. Set the function switch to the  $\Omega$  position.
2. Insert the black test lead banana plug into the negative **COM** jack. Insert the red test lead banana plug into the positive  $\Omega$  jack.
3. Touch the black test probe tip to one side of the device. Touch the red test probe tip to the other side of the device.
4. Read the resistance value in the display.
5. Press the **MODE** button to select the **DIODE** mode. The Diode symbol will appear in the display.
6. Press the **MODE** button to select the **Continuity** mode. The continuity symbol will appear in the display. If the resistance is  $<150$  ohms the tone will sound.



## Data Hold

To freeze the LCD reading, press the **HOLD** button. The **HOLD** icon appears on the LCD. Press the **HOLD** button again to return to normal operation.

## MAX

Press the **MAX** button to display and hold the maximum reading. The display will update if a higher reading is detected. Press the **MAX** button to exit the mode.

## RANGE (Voltage and Resistance functions)

When the meter is first turned on, it automatically goes into Auto-Ranging. This automatically selects the best range for the measurements being made and is generally the best mode for most measurements. For measurement situations requiring that a range be manually selected, perform the following:

1. Press the RANGE button and the "AUTO" icon will turn off.
2. Press the RANGE button to step through the available ranges until the range needed appears.
3. Press and hold the RANGE button for 2 seconds to exit the Manual-Ranging mode and return to Auto-Ranging.

## MODE

Press the **MODE** button in the  $\Omega$ -Diode-Continuity position to select the function to be used.

## Backlight

Press and hold the  button for 2 seconds to turn the backlight on. Repeat the press to turn the backlight off or wait approximately 15 seconds for it to turn off automatically.

## Automatic Power Off

In order to conserve battery life, the meter will automatically turn off after approximately 15 minutes. The meter will "beep" before shutting down. To turn the meter on again, change the position of the function switch.

## Low battery indication

When the  icon appears in the display, the battery should be replaced. Refer to the battery replacement procedure in the maintenance section.

## Maintenance

---

**WARNING:** To avoid electrical shock, disconnect the meter from any circuit, remove the test leads from the input terminals, and turn OFF the meter before opening the case. Do not operate the meter with an open case.

### Cleaning and Storage

Periodically wipe the case with a damp cloth and mild detergent; do not use abrasives or solvents. If the meter is not to be used for 60 days or more, remove the battery and store it separately.

### Battery Replacement

1. Remove the Phillips head screw that secures the rear battery cover
2. Open the battery compartment
3. Replace the 9V battery.
4. Secure the battery compartment door

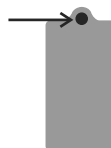

Never dispose of used batteries or rechargeable batteries in household waste. As consumers, users are legally required to take used batteries to appropriate collection sites, the retail store where the batteries were purchased, or wherever batteries are sold.

**Disposal:** Do not dispose of this instrument in household waste. The user is obligated to take end-of-life devices to a designated collection point for the disposal of electrical and electronic equipment.

#### Other Battery Safety Reminders

- Never dispose of batteries in a fire. Batteries may explode or leak.
- Never mix battery types. Always install new batteries of the same type.



## Specifications

Function	Range	Resolution	Accuracy (% of reading + digits)
<b>AC Current</b> 50/60Hz	2.00 A	0.001A	±(2.5% + 10 digits)
	20.00 A	0.01A	±(2.5% + 4 digits)
	200.0 A	0.1A	±(2.5% + 4 digits)
	400 A	1A	±(3.0% + 4 digits)
<b>AC Voltage</b> 50 to 60Hz	200.0mV	0.1mV	±(1.5% + 30 digits)
	2.000 V	0.001V	±(1.8% + 8 digits)
	20.00 V	0.01V	
	200.0 V	0.1V	
	600 V	1V	±(2.5% + 8 digits)
<b>DC Voltage</b>	200.0 mV	0.1mV	±(0.8% + 2 digits)
	2.000 V	0.001V	±(1.5% + 2 digits)
	20.00 V	0.01V	
	200.0 V	0.1V	
	600 V	1V	±(2.0% + 2 digits)
<b>Resistance</b>	200.0Ω	0.1Ω	±(1.0% + 4 digits)
	2.000kΩ	0.001kΩ	±(1.5% + 2 digits)
	20.00kΩ	0.01kΩ	
	200.0kΩ	0.1kΩ	
	2.000MΩ	0.001MΩ	±(2.5% + 3 digits)
	20.00MΩ	0.01MΩ	±(3.5% + 5 digits)

## General Specifications

<b>Clamp jaw opening</b>	30mm (1.18") approx.
<b>Display</b>	2,000 count LCD
<b>Continuity check</b>	Threshold <150Ω; Test current < 0.5mA
<b>Diode test</b>	Test current of 0.3mA typical; Open circuit voltage [ 1.5VDC typical
<b>Low Battery indication</b>	Battery symbol is displayed
<b>Over-range indication</b>	'OL' displayed
<b>Display rate</b>	2 readings per second, nominal
<b>Input Impedance</b>	10MΩ (VDC and VAC)
<b>AC bandwidth</b>	50 to 60Hz (VAC)
<b>AC response</b>	Average responding
<b>Operating Temperature</b>	5°C to 40°C (41°F to 104°F)
<b>Storage Temperature</b>	-20°C to 60°C (-4°F to 140°F)
<b>Operating Humidity</b>	Max 80% up to 31°C (87°F) decreasing linearly to 50% at 40°C (104°F)
<b>Storage Humidity</b>	<80%
<b>Operating Altitude</b>	2000meters (7000ft) maximum.
<b>Battery</b>	9V battery
<b>Auto power OFF</b>	After approx. 15 minutes
<b>Dimensions &amp; Weight</b>	200x66x37mm (7.9x2.6x1.5"); 205g (7.23oz)
<b>Safety</b>	For indoor use and in accordance with the requirements for double insulation to IEC1010-1 (2001); EN61010-1 (2001) Overvoltage Category III 600V, Pollution Degree 2.
<b>Approvals</b>	CE

**Copyright © 2013 FLIR Systems, Inc.**

All rights reserved including the right of reproduction in whole or in part in any form  
ISO-9001 Certified

[www.extech.com](http://www.extech.com)