

P/N: 71201-0101

Copyright

© 2021, FLIR Systems, Inc.

All rights reserved worldwide. Names and marks appearing herein are either registered trademarks or trademarks of FLIR Systems and/or its subsidiaries. All other trademarks, trade names or company names referenced herein are used for identification only and are the property of their respective owners.

Document identity

Publ. No.: 71201-0101

Commit: 78779

Language:

Modified: 2021-08-19

Formatted: 2021-08-19

Website

<http://www.flir.com>

Customer support

<http://support.flir.com>

Disclaimer

Specifications subject to change without further notice. Camera models and accessories subject to regional market considerations. License procedures may apply. Products described herein may be subject to US Export Regulations. Please refer to exportquestions@flir.com with any questions.



General description	
<p>The FLIR AX8 camera/sensor provides an affordable and accurate temperature measurement solution for anyone who needs to solve problems that need built in "smartness" such as analysis, alarm functionality, and autonomous communication using standard protocols. The FLIR AX8 also has all the necessary features and functions to build distributed single- or multi-camera solutions utilizing standard Ethernet hardware and software protocols.</p>	
<p>The FLIR AX8 also has built-in support to connect to industrial control equipment such as PLCs, and allows the sharing of analysis and alarm results and simple control using the Ethernet/IP and Modbus TCP field bus protocols.</p>	
<p>Key features:</p> <ul style="list-style-type: none"> • Support for the EthernetIP field bus protocol (analyze, alarm, and simple camera control). • Support for the Modbus TCP field bus protocol (analyze, alarm, and simple camera control). • Built-in analysis functionality. • Alarm functionality, as a function of analysis and more. • Built-in web server for control and set up. • MJPEG, MPEG-4, or H.264 image streaming. • PoE (Power over Ethernet). • General-purpose output. • 100 Mbps Ethernet (100 m cable). • On alarm: file sending (FTP) or e-mail (SMTP) of analysis results or images. 	
<p>Typical applications:</p> <ul style="list-style-type: none"> • Electrical and mechanical condition-monitoring applications where temperature or temperature trends can be an indication of a potential risk of failure. • Simple process control applications. 	
Imaging and optical data	
IR resolution	80 × 60 pixels
Thermal sensitivity/NETD	< 0.10°C @ +30°C (+86°F) / 100 mK
Field of view (FOV)	48° × 37°
Depth of field	0.1 m (0.33 ft.), infinity
Focal length	1.54 mm (0.061 in.)



FLIR AX8 9 Hz

P/N: 71201-0101

© 2021, FLIR Systems, Inc.

#71201-0101; r. 78779;

Imaging and optical data	
Spatial resolution (IFOV)	11.1 mrad
F-number	1.1
Image frequency	9 Hz
Focus	Fixed

Detector data	
Detector type	Focal plane array (FPA), uncooled microbolometer
Spectral range	7.5–13 μm
Detector pitch	17 μm
Detector time constant	Typical 12 ms

Visual camera	
Built-in digital camera	640 × 480
Digital camera, FOV	Adapts to the IR lens
Sensitivity	Minimum 10 lux without illuminator

Measurement	
Object temperature range	–10 to +150°C (14 to +302°F)
Accuracy	$\pm 2^\circ\text{C}$ ($\pm 3.6^\circ\text{F}$) or $\pm 2\%$ of reading (+10 to +100°C @ +10 to +35°C ambient)

Measurement analysis	
Spotmeter	6
Area	6 boxes with max./min./average
Automatic hot/cold detection	Max./min. temperature value and position shown within box
Measurement presets	Yes
Atmospheric transmission correction	Automatic, based on inputs for distance, atmospheric temperature and relative humidity
Optics transmission correction	Automatic, based on signals from internal sensors
Emissivity correction	Variable from 0.01 to 1.0
Reflected apparent temperature correction	Automatic, based on input of reflected temperature
External optics/windows correction	Automatic, based on input of optics/window transmission and temperature
Measurement corrections	Global object parameters

Alarm	
Alarm functions	Automatic alarms on any selected measurement function. A maximum of 5 alarms can be set.
Alarm output	Digital out, store image, file sending (FTP), email (SMTP), notification

P/N: 71201-0101

© 2021, FLIR Systems, Inc.

#71201-0101; r. 78779;

Set-up	
Color palettes	<ul style="list-style-type: none"> • Arctic • Gray • Iron • Lava • Rainbow • Rainbow HC
Set-up commands	Date/time, Temperature (°C/°F)
Web interface	Yes
Storage of images	
Storage media	Built-in memory for image storage
Image storage mode	IR, visual, MSX
File formats	JPEG + FFF
Image streaming	
Image streaming formats	<ul style="list-style-type: none"> • Motion JPEG stream MJPEG Baseline Process Encoder Baseline ISO/IEC 10918-1 JPEG compliance • MPEG stream Stream format MPEG-4 ISO/IEC 14496-2 Simple Profile level 2 • H.264 stream Stream format H.264 Baseline Profile level 2.0
Image streaming resolution	640 × 480
Image modes	<ul style="list-style-type: none"> • Thermal • Visual • MSX
Automatic image adjustment	Continuous
Multi Spectral Dynamic Imaging (MSX)	IR image with enhanced detail presentation
Ethernet	
Ethernet	Control, result and image
Ethernet, type	100 Mbps
Ethernet, standard	IEEE 802.3
Ethernet, connector type	M12 8-pin X-coded
Ethernet, communication	TCP/IP socket-based FLIR proprietary
Ethernet, video streaming	Yes
Ethernet, power	Power over Ethernet, PoE IEEE 802.3af class 2.
Ethernet, protocols	Ethernet/IP, Modbus TCP, TCP, UDP, SNTP, RTSP, RTP, HTTP, ICMP, IGMP, sftp, SMTP, DHCP, MDNS (Bonjour)
Digital input/output	
Digital input, purpose	NUC, NUC disable, Alarm
Digital input	1 opto-isolated, 10–25 VDC
Digital output, purpose	As function of alarm, output to ext. device (programmatically set)
Digital output	1 opto-isolated, 10–25 VDC, max. 100 mA
Digital I/O, isolation voltage	500 VRMS
Digital I/O, supply voltage	10-25 VDC, max. 200 mA
Digital I/O, connector type	M12 8-pin A-coded (shared with ext. power)



FLIR AX8 9 Hz

P/N: 71201-0101

© 2021, FLIR Systems, Inc.

#71201-0101; r. 78779;

Power system	
External power operation	12/24 VDC, 2 W continuously/ 4.7 W absolute max
External power, connector type	M12 8-pin A-coded (Shared with digital I/O)
Voltage	Allowed range 10.8–30 VDC
Power supply rating	Class 2 / LPS
Environmental data	
Operating temperature range	–0°C to +50°C (+32°F to +122°F)
Storage temperature range	–40°C to +70°C (–40°F to +158°F) according to IEC 68-2-1 and IEC 68-2-2
Humidity (operating and storage)	IEC 60068-2-30/24 h 95% relative humidity +25°C to +40°C (+77°F to +104°F)/ 2 cycles
EMC	<ul style="list-style-type: none">• EN 61000-6-2:2001 (Immunity)• EN 61000-6-3:2001 (Emission)• FCC 47 CFR Part 15 Class B (Emission)
Encapsulation	IP 67 (IEC 60529)
Bump	25 g (IEC 60068-2-29)
Vibration	2 g (IEC 60068-2-6)
Physical data	
Weight	0.125 kg (0.28 lb.)
Camera size (L × W × H)	<ul style="list-style-type: none">• 54 × 25 × 79 mm (2.1 × 1 × 3.1 in.) without connectors• 54 × 25 × 95 mm (2.1 × 1 × 3.7 in.) with connectors
Base mounting	4× mounting hole depth max 4.8 mm for screw type Delta PT 22 (ø2.2 mm)
Housing material	PA6 with 30% GF (glass fiber reinforced)
Shipping information	
Packaging, type	Cardboard box
List of contents	<ul style="list-style-type: none">• Infrared camera with lens• Cardboard box• Printed documentation
Packaging, weight	0.48 kg (1.06 lb.)
Packaging, size	210 × 142 × 70 mm (8.27 × 5.59 × 2.76 in.)
EAN-13	4743254001725
UPC-12	845188009373
Country of origin	Estonia

Supplies & accessories:

- T130086; I/O module MIO-AX8-1
- T130087; I/O module MIO-AX8-7
- T199713; ThermoVision CM Panel, max. 4 cameras
- T199712; ThermoVision CM Panel, max. 9 cameras
- T130169; Thermovision CM, max. 4 cameras
- T130170; Thermovision CM, max. 9 cameras
- T129259ACC; Cable M12 to pigtail, 10 m
- T129258ACC; Cable M12 to pigtail, 5 m
- T129886ACC; Cable M12, FLIR X-Coded to standard X-Coded
- T128391ACC; Cable, M12 to pigtail
- T198821; Cooling bracket



FLIR AX8 9 Hz

P/N: 71201-0101

© 2021, FLIR Systems, Inc.

#71201-0101; r. 78779;

- T129257ACC; Ethernet cable M12 to RJ45, 10 m
- T128390ACC; Ethernet cable M12 to RJ45, 2 m
- T129256ACC; Ethernet cable M12 to RJ45, 5 m
- 71200-0002; FLIR AX8 accessory starter kit
- T199163; Front mounting plate kit (incl. cooling bracket)
- T199342; One-ball joint mounting bracket kit
- T199343; PoE injector, 12/24 V
- T128775ACC; Rear mounting plate kit
- T199341; Two-ball joint mounting bracket kit
- INST-EW-0110; Extended Warranty 1 Year for AX8, E4, E5

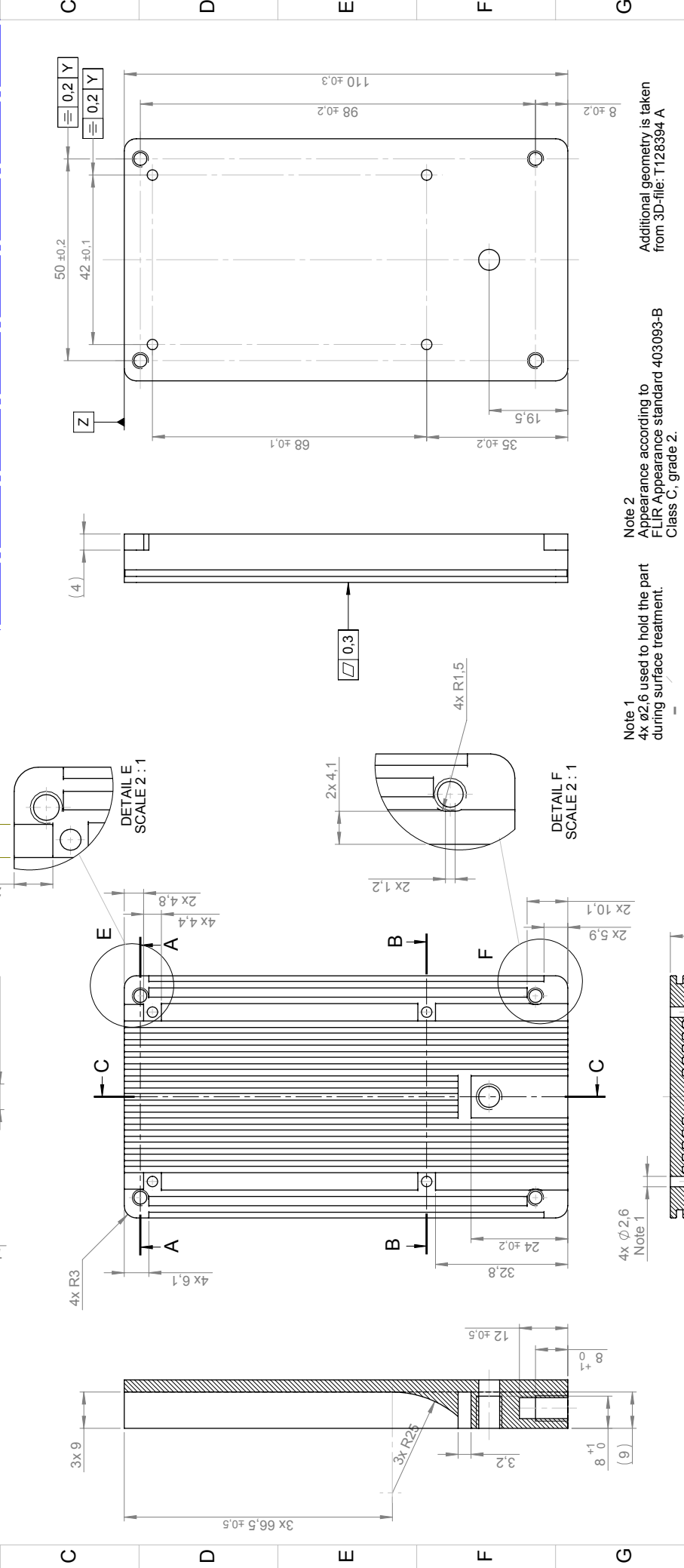
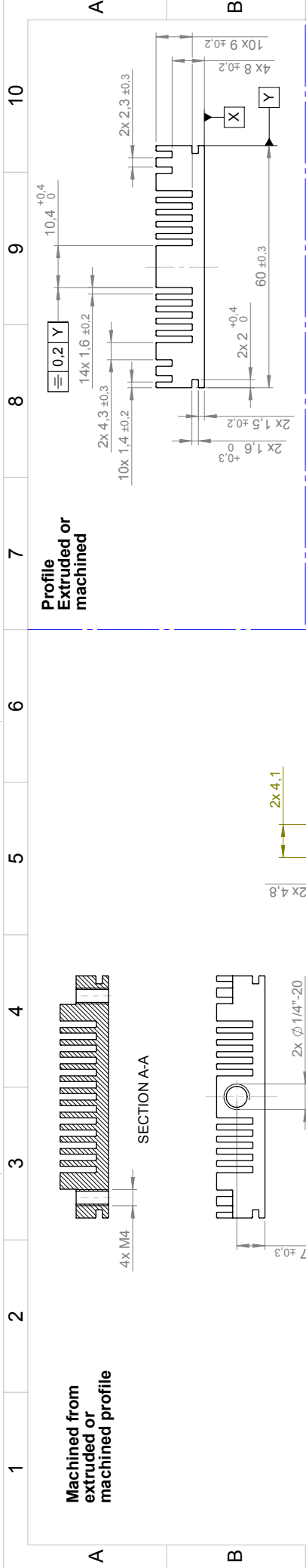

Konsist/Drawn P. MARCUS		Datum/Date 2014-09-18	Kontr/Check JAMA	Material EN AW-6262 R
Ändrad av/Modified by P. MARCUS		Ändrad/Modified 2015-03-10	Ytbehandling/Roughness Ra 3.2 µm	Ytbehandling/Surface treatment Anodized colorless matt
Där ej annat anges/Unless otherwise stated Gen tol ISO 2768-mK Utdrag ur/Excerpt from ISO 2768-m		Benämning/Denomination Bracket cooling		
0.5-6	+0.1	Hålkalibrer 0.1-0.3		
(6)-30	±0.2	Fillet radii		
(120)-400	±0.5	Kanter brutna		
(400)-1000	±0.8	Edges broken		

FLIR

Sheet/Scale
1(1)

Size
A3

Rev
A

Rit nr/Drawing No
T128394

Note 2
Appearance according to FLIR Appearance standard 403093-B Class C, grade 2.
Additional geometry is taken from 3D-file: T128394 A

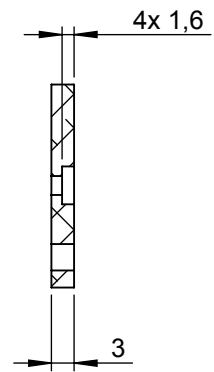
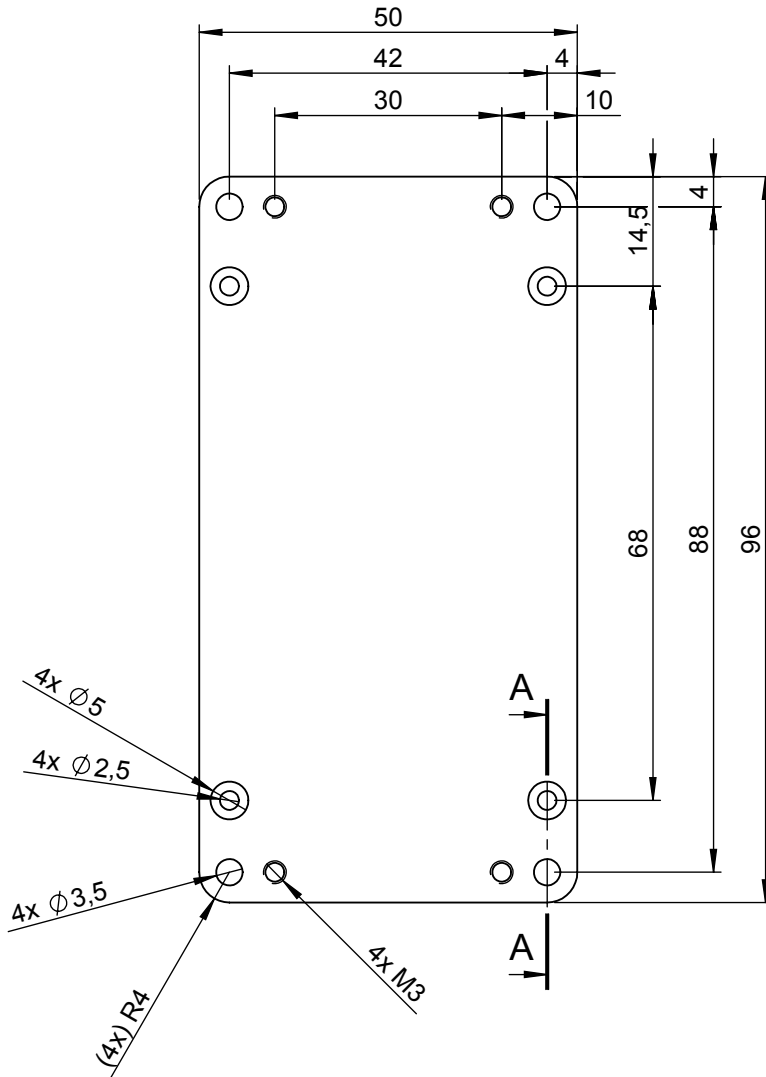

SECTION A-A

Konstr/Drawn J. MÄKINEN	Datum/Date 2015-03-06	Kontr/Check HAOS	Material EN AW-5052 or EN AW-5754	
Ändrad av/Modified by J. MÄKINEN	Ändrad/Modified 2015-05-21	Ytjämnhet/Roughness Ra µm	Ytbehandling/Surface treatment	
Där ej annat anges/Unless otherwise stated Gen tol ISO 2768-mK Utdrag ur/Excerpt from ISO 2768-m	Benämning/Denomination Plate mounting rear		Skala/Scale 1:1	Blad/Sheet 1(1)
0,5-6 ±0,1 Hålkårsradier (6)-30 ±0,2 Fillet radii (30)-120 ±0,3 (120)-400 ±0,5 Kanter brutna (400)-1000 ±0,8 Edges broken			Art.No.	Size A4
			Ritn nr/Drawing No T128775	Rev A

RoHS

IP67

REV.	DESCRIPTION	DATE
A	ISSUE	Dec/23/2013
B	Modify the wire diagram.	Dec/25/2013
C	Modify M12 Pin Assignment.	Dec/25/2013
D	Modify cable length.	Dec/25/2013
D1	Correct key direction.	Jan/22/2014
E	Add note.	Mar/30/2014
F	Modify P/N.	Sep/25/2014
G	Modify connector to shielding type.	Nov/12/2014
G1	Change ring nut to shielding type.	Nov/25/2014

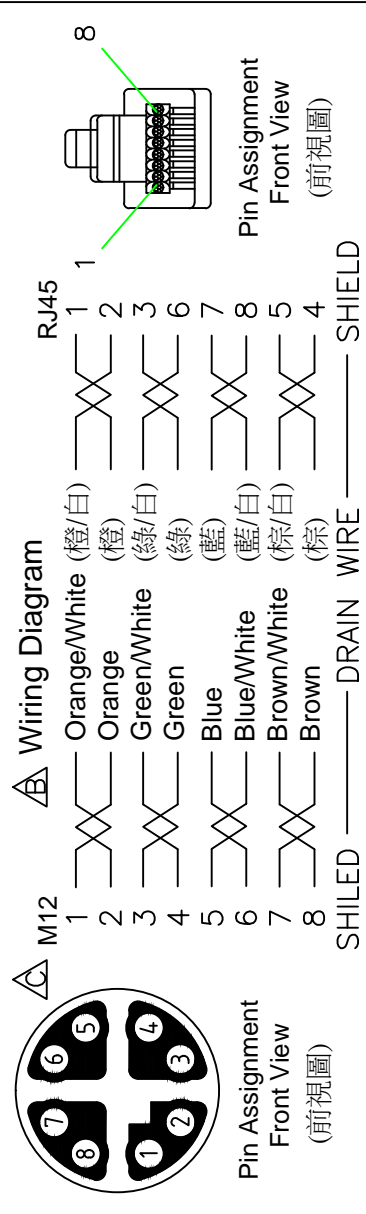
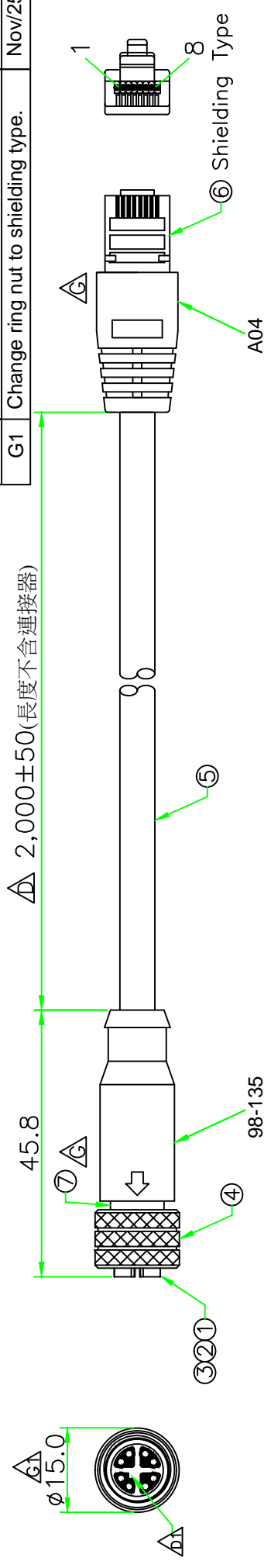

7	SHIELD	Brass, Nickel Plated.	1		
6	RJ45 PLUG	RJ45 8P8C PLUG (shielding type).	1		
5	CABLE	CAT5E FTP 24AWG x 4 PAIR + AL/MY + Drain wire.	1	WAC2B0026	
4	RING NUT	Brass, Nickel Plated.	1	M12S-RN-D985	
3	O-RING	Viton.	1	M12-O-VK	
2	CONTACT	Brass, Female pin, .6 u" Gold plated.	8	AASPF-1008-0.8	
1	CONNECTOR	M12 X-coding Female connector insert. Nylon+GF.	1	M12X-08F	
No.	PART NAME	DESCRIPTION	Q'TY	REMARKS	COLOR

Customer: FLIR	
TITLE	M12 X-Coding Female Molded Cable Assy
UNIT: mm	1:1
SCALE	1:1
UNLESS OTHERWISE SPECIFIED TOLERANCES:	
X ± 0.25	XX ± 0.1
XXX ± 0.05	ANGLE ± 1°
REV.	G1
SHEET	1/1
DWG.NO:	T128390
P/N:	K129351004
DR.	Stanley
CH.	ERIC
AP.	

RoHS

IP67

REV.	DESCRIPTION	DATE
A	ISSUE	Dec/23/2013
B	Modify cable length.	Dec/25/2013
C	Add note.	Mar/20/2014
D	Modify P/N.	Sep/25/2014
E	Modify connector to shielding type.	Nov/12/2014
E1	Change ring nut to shielding type.	Nov/25/2014

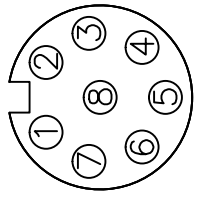
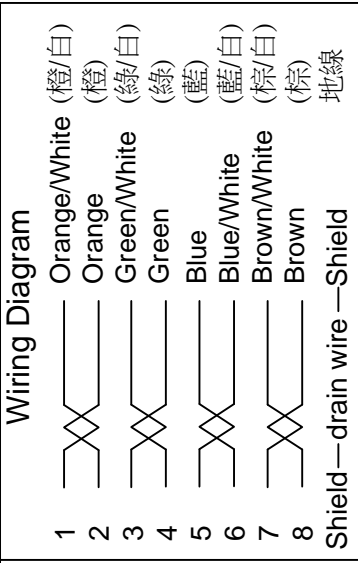
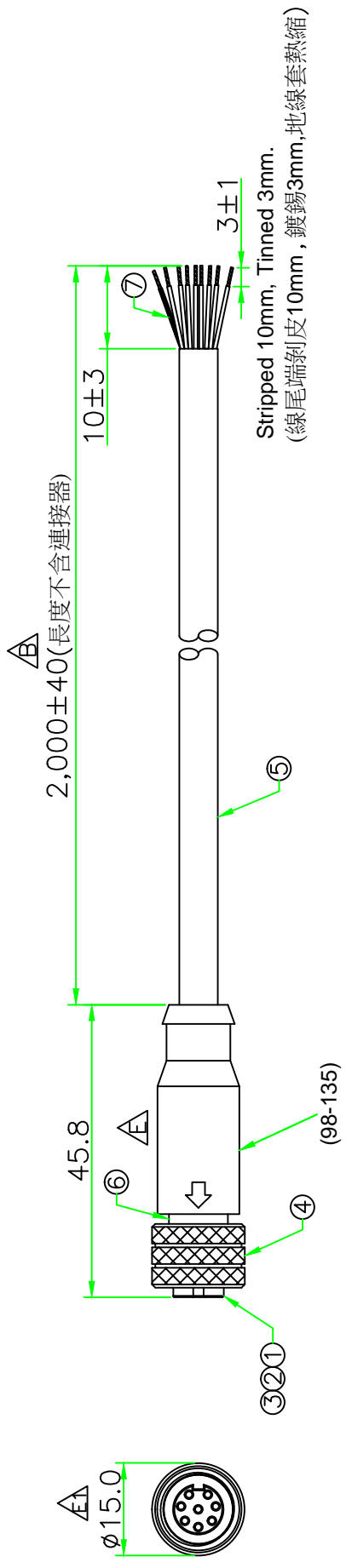

7	TUBE	Heat shrink tube.	BLACK	1		
6	SHIELD	Brass, Nickel Plated. Δ		1		
5	CABLE	CAT5E FTP 24AWG x 4 PAIR + AL/MY + Drain wire.	BLACK	1	WAC2B0026	
4	RING NUT	Brass, Nickel Plated.		1	M12S-RN-D985	
3	O-RING	Viton.	BLACK	1	M12-O-VK	
2	CONTACT	Brass, Female pin, 6 u" Gold plated.		8	AASPF-1008-0.8	
1	CONNECTOR	M12 A-coding Female connector insert. Nylon+GF.	BLACK	1	M12A-08F	
No.	PART NAME	DESCRIPTION	COLOR	Q'TY	REMARKS	

Customer: FLIR

	UNIT: mm	1:1	TITLE	M12 A-Coding 8P Female Molded Cable Assy
	SCALE	1:1	P/N:	K129351003
UNLESS OTHERWISE SPECIFIED TOLERANCES:			DR.	Stanley
x ± 0.25	xx ± 0.1		CH.	ERJC
xxx ± 0.05	ANGLE ± 1°X		DWG. NO:	T128391 Δ
REV.	SHEET	1/1		

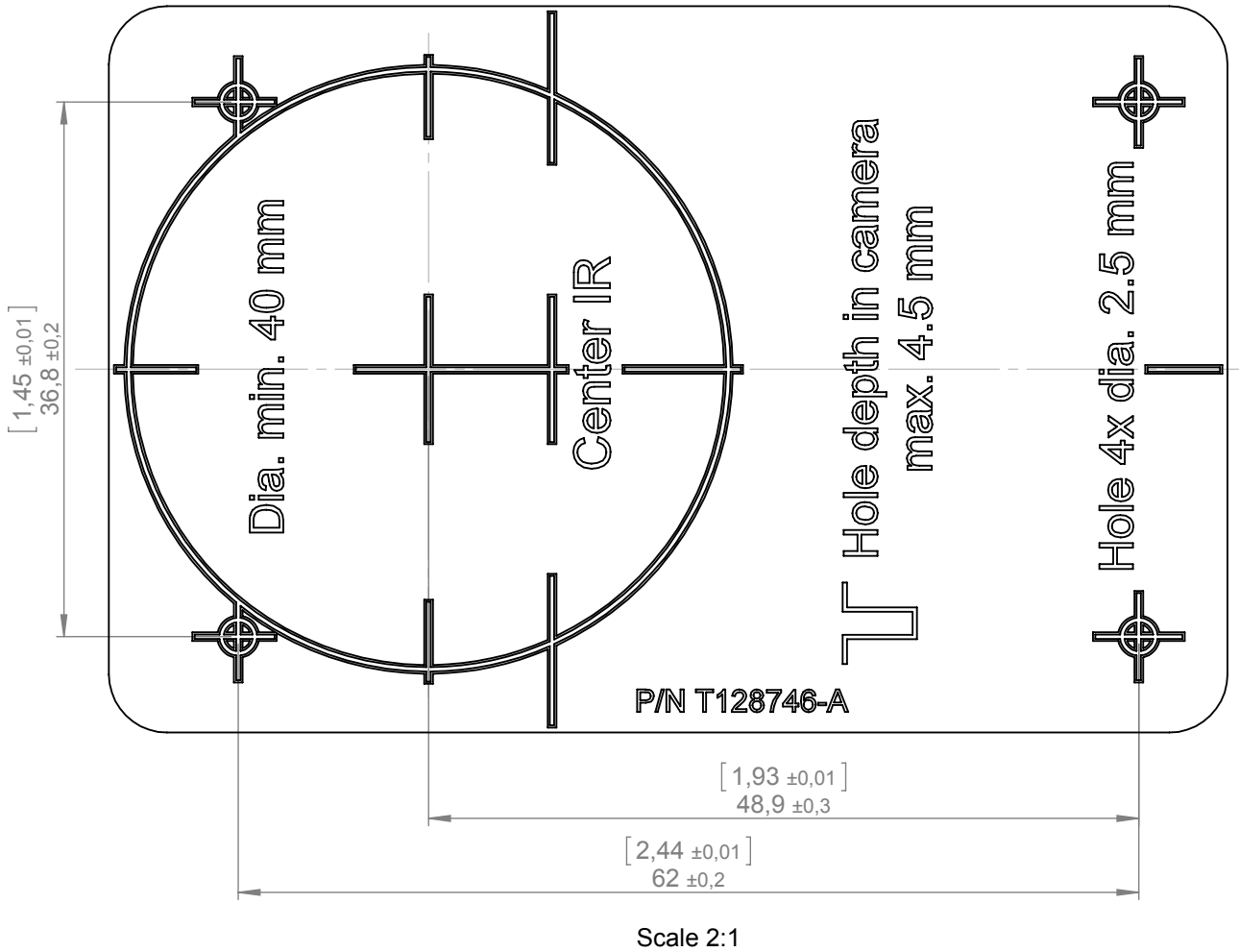
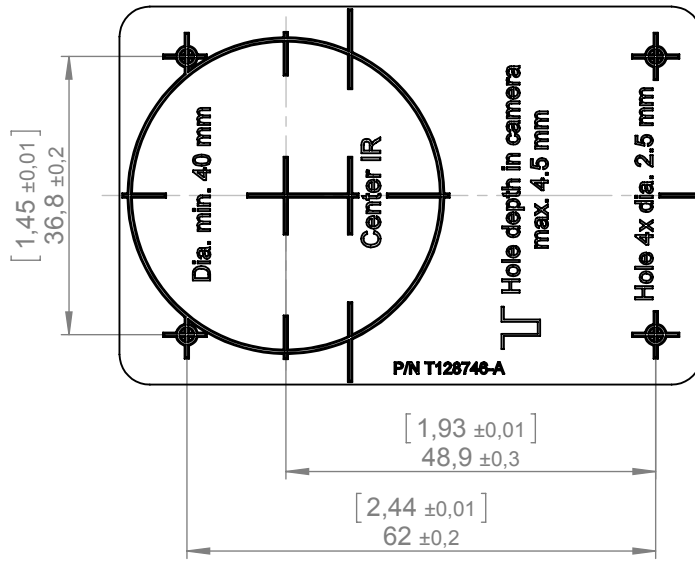

Konstr/Drawn P. MARCUS	Datum/Date 2014-10-06	Kontr/Check JAMA	Material Note 1	
Ändrad av/Modified by P. MARCUS	Ändrad/Modified 2015-03-04	Ytjämnhet/Roughness Ra µm	Ytbehandling/Surface treatment	
Där ej annat anges/Unless otherwise stated Gen tol ISO 2768-mK Utdrag ur/Excerpt from ISO 2768-m	Benämning/Denomination Drilling template front		Skala/Scale 2:1	Blad/Sheet 2(2)
0,5-6 ±0,1 Hålkälsradier (6)-30 ±0,2 Fillet radii (30)-120 ±0,3 (120)-400 ±0,5 Kanter brutna (400)-1000 ±0,8 Edges broken			Art.No.	Size A4
			Ritn nr/Drawing No T128746	Rev A

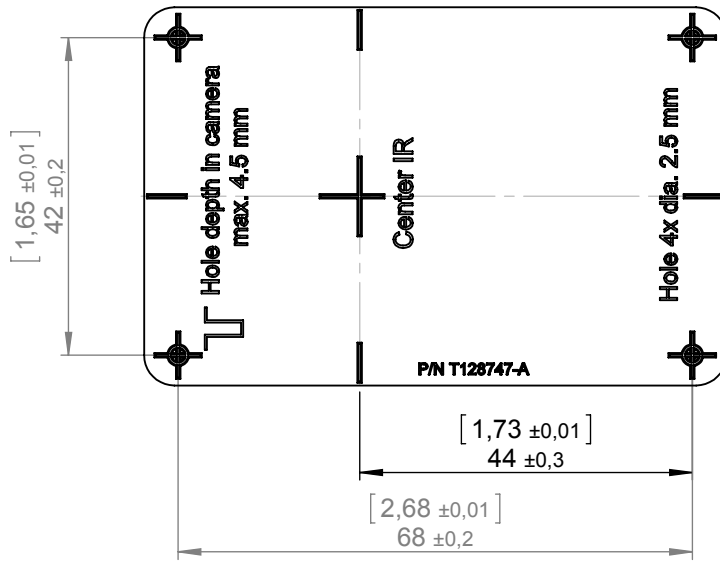

Scale 1:1

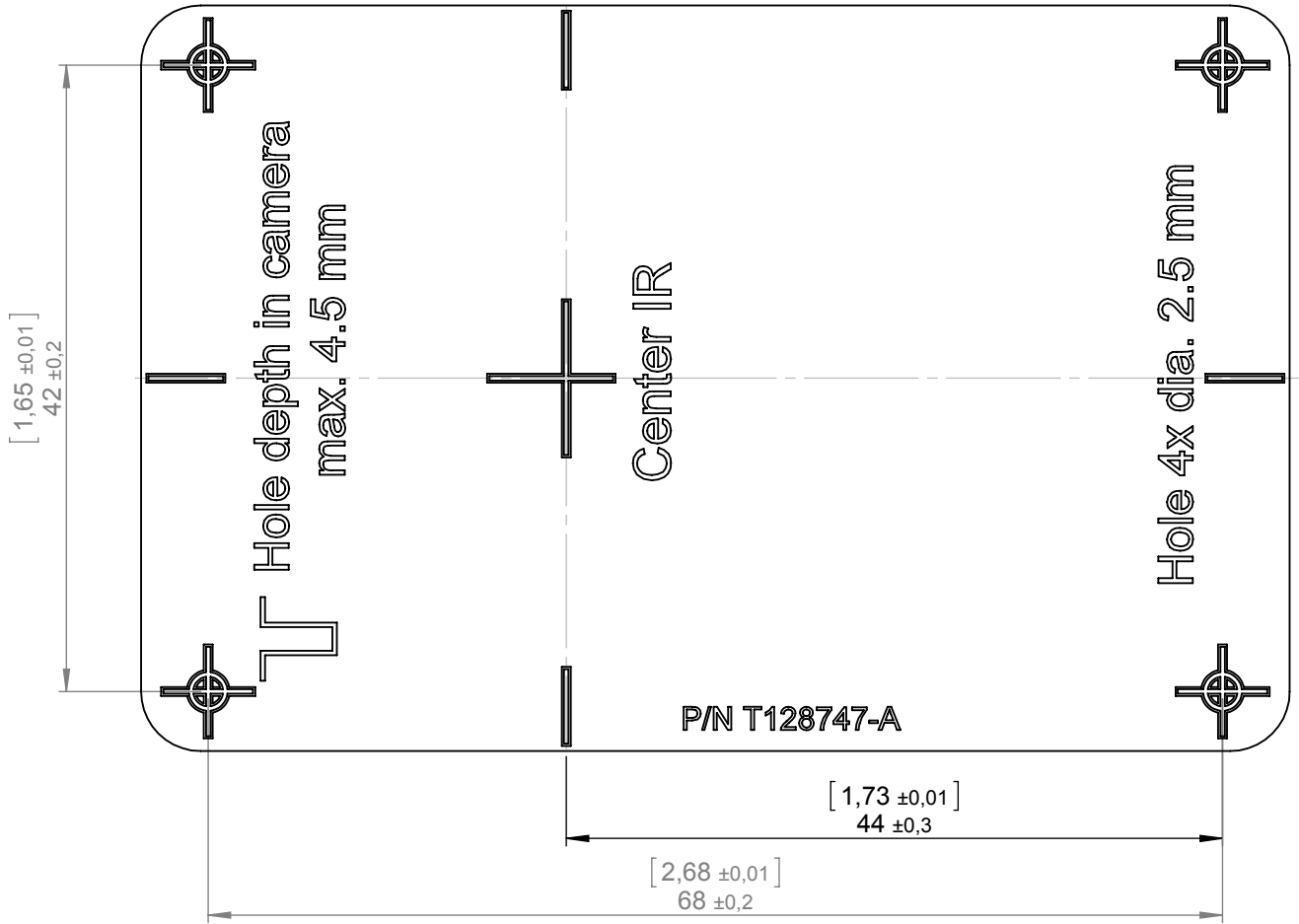

Scale 2:1

Konstr/Drawn P. MARCUS	Datum/Date 2014-10-06	Kontr/Check JAMA	Material Note 1	
Ändrad av/Modified by P. MARCUS	Ändrad/Modified 2015-03-04	Ytjämnhet/Roughness Ra μm	Ytbehandling/Surface treatment	
Där ej annat anges/Unless otherwise stated Gen tol ISO 2768-mK Utdrag ur/Excerpt from ISO 2768-m	Benämning/Denomination Drilling template rear			Skala/Scale 2:1
0,5-6 ±0,1 Hålkälsradier (6)-30 ±0,2 Fillet radii (30)-120 ±0,3 (120)-400 ±0,5 Kanter brutna (400)-1000 ±0,8 Edges broken				Blad/Sheet 2(2)
				Art.No. T128747
				Size A4
				Rev A

Digital I/O connection diagrams FLIR AX8

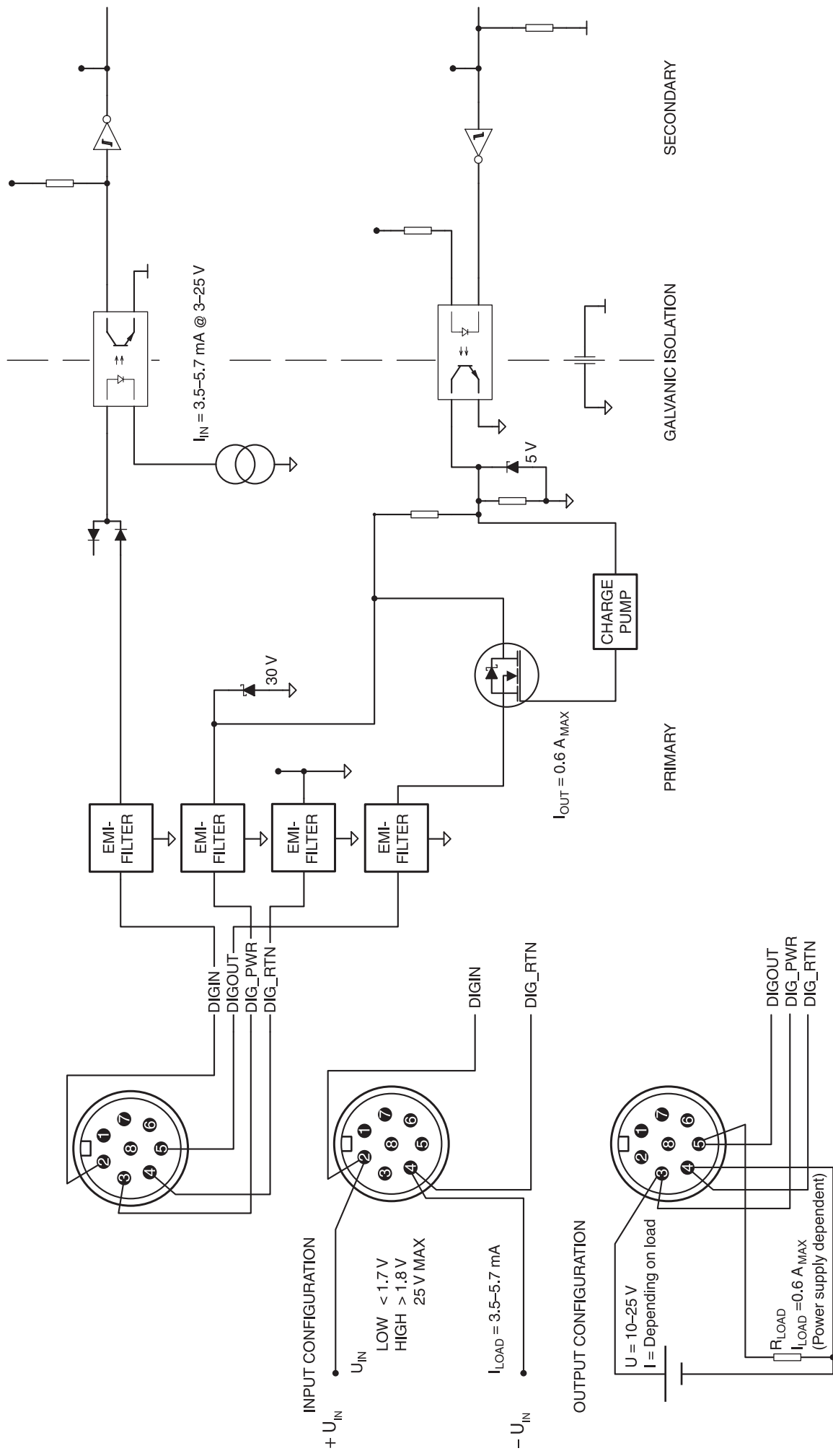



The World's Sixth Sense™

September 29, 2017 Täby, Sweden

AQ320259

CE Declaration of Conformity – EU Declaration of Conformity

Product: FLIR AX8 -series
Name and address of the manufacturer:
FLIR Systems AB
PO Box 7376
SE-187 15 Täby, Sweden

This declaration of conformity is issued under the sole responsibility of the manufacturer.
The object of the declaration: FLIR Ax8 -series.
The object of the declaration described above is in conformity with the relevant Union harmonisation legislation:

Directives:

Directive	2014/30/EU	Electromagnetic Compability
Directive	2012/19/EU	Waste electrical and electric equipment
Directive	2011/65/EU	RoHS

Standards:

Emission:	EN 61000-6-3:2007+A1:2011	EMC – Generic standards Emission
	EN 55022:2010/AC:2011	Radio disturbance characteristics - Limits
Immunity:	EN 61000-6-2:2011	Electromagnetic Compability Generic
	EN 55024:2010	Immunity characteristics - Limits
RoHS	EN 50581:2012	Technical documentation

FLIR Systems AB
Quality Assurance

Lea Dabiri
Quality Manager



The World's Sixth Sense™

October 11, 2017 Täby, Sweden

AQ320260

CE Declaration of Conformity – EU Declaration of Conformity

Product: I/O module MIO -boards
Name and address of the manufacturer:
FLIR Systems AB
PO Box 7376
SE-187 15 Täby, Sweden

This declaration of conformity is issued under the sole responsibility of the manufacturer.
The object of the declaration:

I/O module MIO -boards:

T130087 I/O module MIO-AX8-7
T130089 I/O module MIO-FCR-7
T130091 I/O module MIO-A310-7
T130086 I/O module MIO-AX8-1
T130088 I/O module MIO-FCR-1
T130090 I/O module MIO-A310-1

The object of the declaration described above is in conformity with the relevant Union harmonisation legislation:

Directives:

Directive	2014/30/EU	Electromagnetic Compability
Directive	2011/65/EU	RoHS and 2015/863/EU

Standards:

EMC:	EN 55022:2010	Information technology equipment – radio disturbance
	EN 55024:2010	Information technology equipment - immunity
RoHS	EN 50581:2012	Technical documentation

FLIR Systems AB
Quality Assurance

Lea Dabiri
Quality Manager