

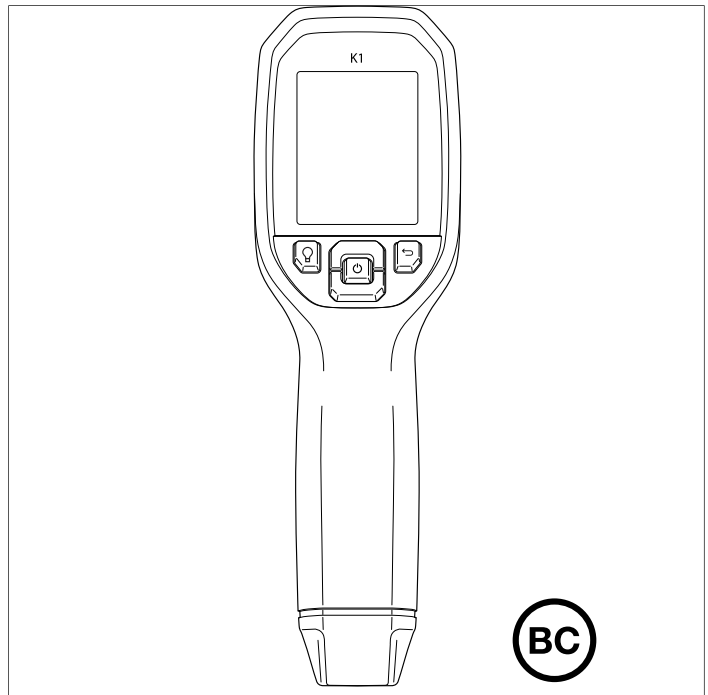

USER MANUAL

Situational Awareness Camera

MODEL K1





USER MANUAL

Situational Awareness

Camera

Table of contents

1	Advisories	1
	1.1 Copyright.....	1
	1.2 Quality Assurance	1
	1.3 Documentation	1
	1.4 Disposal of Electronic Waste	1
2	Introduction	2
3	Safety	3
	3.1 Safety Warnings and Cautions.....	3
4	Description	4
	4.1 Product Description.....	4
	4.2 Control Button Descriptions	5
	4.3 Display Description	5
5	Operation	6
	5.1 Powering the K1	6
	5.2 Thermal Camera	6
	5.3 Visible Spectrum Digital Camera.....	7
	5.4 Capturing and Working with Images.....	7
6	Programming Menu	9
	6.1 Menu System Basics	9
	6.2 Main Menu	9
	6.3 SETTINGS Sub-Menu	13
7	Field Firmware Updates	18
	7.1 System Firmware upgrade	18
8	Maintenance	19
	8.1 Cleaning	19
	8.2 Battery Service	19
	8.3 Disposal of Electronic Waste	19
	8.4 Reset the K1.....	19
9	Specifications	20
	9.1 Imaging and Optical Specifications	20
	9.2 Detector Specifications	20
	9.3 Visual Camera Specifications	20
	9.4 Image Presentation Specifications.....	20
	9.5 Measurement Specifications	21
	9.6 Measurement Analysis Specifications	21
	9.7 USB Specifications	21

Table of contents

9.8	Image Storage Specifications	21
9.9	Flashlight Specifications.....	21
9.10	Battery Power System Specifications	22
9.11	Environmental Specifications	22
9.12	Physical Specifications	23
9.13	List of Package Contents.....	23
10	Appendix	24
10.1	IR Energy and Imaging Overview	24
11	2–10 Extended Warranty	25
12	Customer Support.....	26
12.1	Corporate Headquarters	26

1 Advisories

1.1 Copyright

©2019, FLIR Systems, Inc. All rights reserved worldwide. No parts of the software including source code may be reproduced, transmitted, transcribed or translated into any language or computer language in any form or by any means, electronic, magnetic, optical, manual or otherwise, without the prior written permission of FLIR Systems.

The documentation must not, in whole or part, be copied, photocopied, reproduced, translated or transmitted to any electronic medium or machine-readable form without prior consent, in writing, from FLIR Systems. Names and marks appearing on the products herein are either registered trademarks or trademarks of FLIR Systems and/or its subsidiaries. All other trademarks, trade names or company names referenced herein are used for identification only and are the property of their respective owners.

1.2 Quality Assurance

The Quality Management System under which these products are developed and manufactured has been certified in accordance with the ISO 9001 standard.

FLIR Systems is committed to a policy of continuous development; therefore, we reserve the right to make changes and improvements on any of the products without prior notice.

1.3 Documentation

To access the latest manuals and notifications, go to the Download tab at: <https://support.flir.com>. It only takes a few minutes to register online. In the download area you will also find the latest releases of manuals for our other products, as well as manuals for our historical and obsolete products.

1.4 Disposal of Electronic Waste



As with most electronic products, this equipment must be disposed of in an environmentally friendly way, and in accordance with existing regulations for electronic waste. Please contact your FLIR Systems representative for more details.

2 Introduction

Thank you for selecting the FLIR K1 Situational Awareness Camera. The K1 is a rugged, compact thermal camera that becomes an extra set of eyes on the fire scene, allowing you to easily see in total darkness and through smoke. The K1's bright, integrated flashlight illuminates the scene to help steer and manage your crew more effectively. You can carry the K1 in your pocket, hang it on your belt, or base it in your vehicle for investigations in and around buildings, industrial settings, traffic accidents, wilderness calls, or search and rescue activities.

Visit <https://support.flir.com/prodreg> to register the K1 and extend the standard one-year warranty to the 2-10 Year Warranty.

Features

- Clear thermal imaging.
- Lepton® 160 x 120 pixel microbolometer with integrated shutter.
- Visible spectrum 2M pixel digital camera.
- Adjustable MSX® enhancement (Multi-Spectral Dynamic Imaging) adds perspective and key details from the visible spectrum camera to the IR image in real time.
- Pistol grip for line of sight viewing.
- 3 presets and 1 custom emissivity setting.
- Integrated flashlight with selectable intensity.
- Center Spot display icon for easy targeting.
- Save images in radiometric format.
- Image post-processing and reporting in FLIR Tools™.
- 4 GB internal image memory.
- USB-C connectivity for image transfer and charging.
- Easy to read 320 x 240 2.4" TFT color LCD display.
- Intuitive programming menu system translated in over 21 languages.
- IP67 waterproof rating with lid closed or open.
- Drop-proof to 6.6 ft. (2m).
- Rechargeable lithium battery with up to 5.5 hours battery power.
- Auto power off (APO), user adjustable.
- Accessory mounting for tripods, extender poles, etc.

3 Safety

3.1 Safety Warnings and Cautions

	WARNING
<p>⚠ This symbol, adjacent to another symbol indicates the user must refer to the manual for further information.</p>	

4 Description

4.1 Product Description

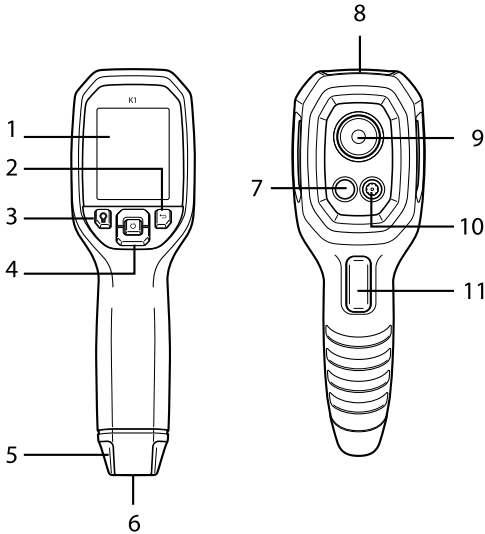







Figure 4.1 K1 Product Description

1. Display area
2. Return button (to back up in the menus)
3. Flashlight button (short presses)
4. Up/Down Navigation buttons and Power (long press)/Menu (short press) button
5. Lanyard post
6. Accessory mount
7. 160 x 120 Lepton® IR thermal camera
8. USB-C jack
9. Flashlight (low/high intensity)
10. 2M pixel visible spectrum digital camera
11. Image capture trigger (also used to exit the menu system)

4.2 Control Button Descriptions

	Long press to power ON or OFF. Short press to access the menu system.
	Return button. Back up/exit in the menu system.
	Scroll up in the menu system.
	Scroll down in the menu system.
	Press to switch ON the Flashlight, press again to dim the light, and press a third time to switch the light OFF.
TRIGGER	Pull and release to capture images and to exit the menu system.

4.3 Display Description

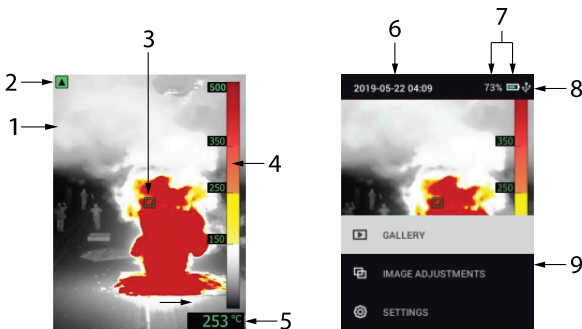

Figure 4.2 K1 Display Description

1. Thermal MSX® Camera image
2. Low Sensitivity range indicator (see *Temperature Scale* menu)
3. Center spot for targeting measurement areas
4. Temperature range bar graph
5. Temperature of targeted spot
6. Date and Time
7. Battery status indicators
8. USB icon (when USB connection active)
9. Main menu

5 Operation

5.1 Powering the K1

The K1 is powered by a rechargeable lithium battery. Long press the power button (center) to switch the K1 ON or OFF. If the K1 does not power ON, charge the battery by connecting the K1 to an AC charger using the supplied USB-C cable. The USB-C jack is located in the compartment at the top of the K1. Do not use the K1 while it is charging. The K1 is rated IP67.

The K1 has an Auto Power OFF (APO) utility that switches it OFF automatically after the programmable APO time has elapsed. Go to the menu system (under *Device Settings*) To set the APO timer. See Section 6, *Programming Menu System*, for more information.

5.2 Thermal Camera

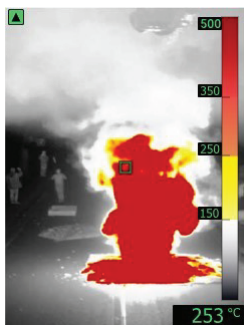

Figure 5.1 Thermal MSX® Camera Image

1. Long press the power button to switch the K1 ON.
2. If not already selected, choose the Thermal plus Visible Image (MSX®) mode in the menu system (*Image Adjustments/Image Mode*). Adjust the MSX® (Multi-Spectral Dynamic Imaging) alignment by first pressing MENU, with the thermal image showing in the menu, and then using the arrow buttons to make the adjustment. Adjust until the thermal and visual images are aligned accurately. See *MSX® alignment* in the Programming Menu System.
3. Point the camera toward the test area and scan as desired. View the camera image on the K1 display.
4. Use the 'center spot' display icon for targeting. If the center spot is not shown on the display, enable it in the menu system (under *Measurement*).

5. The temperature reading on the bottom right represents the measurement of the targeted spot. See **Figure 5.1**.
6. Adjust the Emissivity in the menu system (under *Measurement*).
7. Change the display color palette in the menu system (under *Image Adjustments/colors*).

5.3 Visible Spectrum Digital Camera

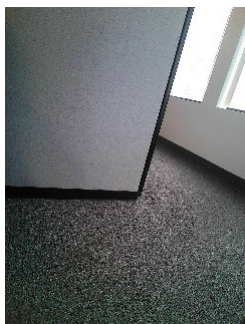

Figure 5.2 Visible Spectrum Digital Camera Image

1. Long press the power button to switch the K1 ON.
2. Select the Visible Image mode in the menu system (under *Image Adjustments/Image Mode*).
3. Point the camera toward the test area and scan as desired.
4. View the image on the display, see **Figure 5.2**. Pull the image capture trigger to save an image. See Section 5.4, *Capturing and Working with Images*, for more information.

5.4 Capturing and Working with Images

1. To capture a camera image, pull and release the trigger. Note that an image cannot be saved if a USB cable is connected to the K1.
2. A display confirmation will briefly appear showing the filename. If the internal memory is full, an error will display; free up space by deleting images in the *Gallery* mode or by connecting the K1 to a PC and moving images out of the K1 memory as explained below.
3. To view or delete the image, open the *Gallery* utility from the main menu. In the Gallery, you can scroll through the stored images with the arrow buttons and select an image with the MENU button. Once selected, press MENU again to open the DELETE/CANCEL menu.

4. Transfer images to your PC by connecting the K1 to a PC using the supplied USB-C cable. The USB jack is located at the top of the K1 under the flap. Once connected to the PC you can use the K1 as you would any external storage drive.

Note: Device is not 100% compatible with Mac OS, please do not format K1 internal memory via Mac OS.

6 Programming Menu

6.1 Menu System Basics

Short press the MENU button to access the menu system. Use the arrow buttons to scroll and use the MENU button to switch settings ON or OFF. Use the Return button to move to the previous screen and use the MENU button, when necessary, to confirm settings. Pull the trigger to exit the menu system.

6.2 Main Menu

- **GALLERY:** Press MENU to access the stored images and use the arrows to scroll through them. Press MENU to open an image and press it again to see the DELETE/CANCEL menu. Connect the K1 to a PC via USB to transfer images (as explained in Section 5.4, *Capturing and Working with Images*).

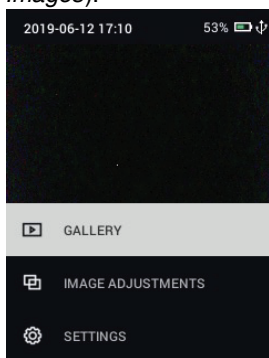

- **IMAGE ADJUSTMENTS:** Press MENU to access IMAGE MODES, MSX® alignment, Colors, and Temperature Scale (LOW and HIGH range sensitivity), see below:

1. Image Modes: Press MENU at IMAGE MODES and use the arrow buttons to select THERMAL PLUS VISIBLE IMAGE (MSX®) as shown below on left, or Visible Image only (as shown on right).

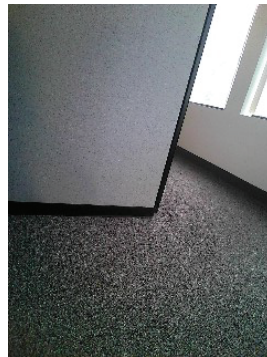
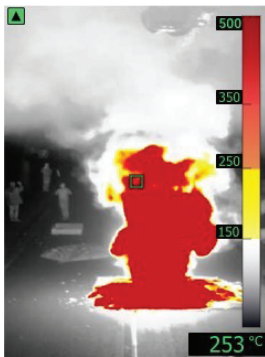
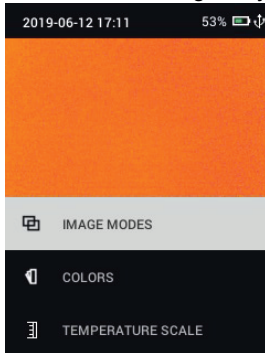

2. MSX® Alignment: While at the Image Mode menu you can adjust the MSX® alignment so that the thermal image and the visible image are superimposed accurately. While viewing the THERMAL PLUS VISIBLE IMAGE screen in the menu, press MENU to see the MSX® adjustment screen (shown below) and then use the arrow buttons to adjust the alignment.

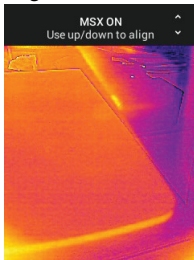

3. Colors: Press MENU at the Colors menu and use the arrow buttons to select a color palette: Iron, White hot, and T1 Basic (default). Note the differences in the bar graph scale for each display type. Press MENU to confirm selection.

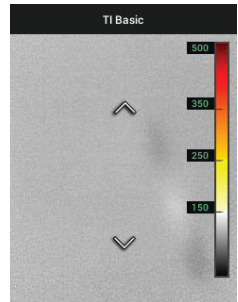
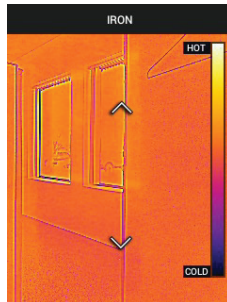
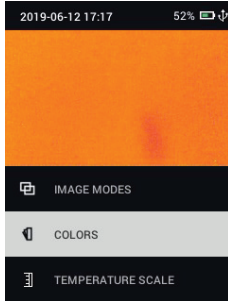

4. Temperature Scale: Set the sensitivity (gain) to LOW, HIGH, or AUTO. With the sensitivity set to LOW, the temperature range is 14 ~ 752°F (–10 ~ 400°C) and the low sensitivity range indicator appears (upper left of display), see **Figure 4.2, Display Description**. With the sensitivity set to HIGH the temperature range is 14 ~ 284°F (–10 ~ 140°C) and the low sensitivity range indicator switches OFF. Set to AUTO to have the camera decide which range is most suitable for any given image.

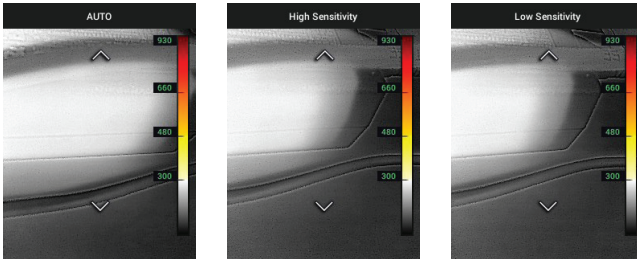

- **SETTINGS:** Press MENU to access the Settings sub-menu (see below):

6.3 SETTINGS Sub-Menu

- **MEASUREMENT**

1. **Center Spot:** Press MENU to enable/disable the target icon. When the center spot is on, you can easily pinpoint objects in the field of view in which to measure temperature.

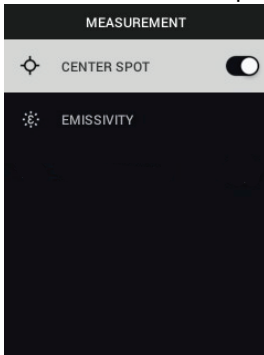

2. Emissivity: Press MENU to open the Emissivity adjustment utility. Use the arrows to scroll through the presets (0.95, 0.80, and 0.60) and use the MENU button to select one. Choose the Custom Value utility (last selection on the list) to select a specific emissivity value. At the Custom Value setting, press MENU and then use the arrows to select the emissivity value; press MENU to confirm.

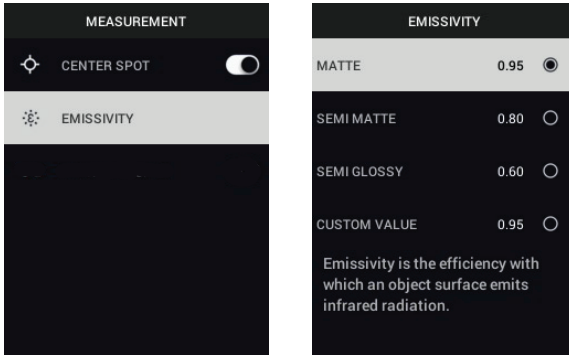

- **DEVICE SETTINGS**

1. Screen brightness: Use the arrows to select the desired display intensity (LOW, MEDIUM, or HIGH).

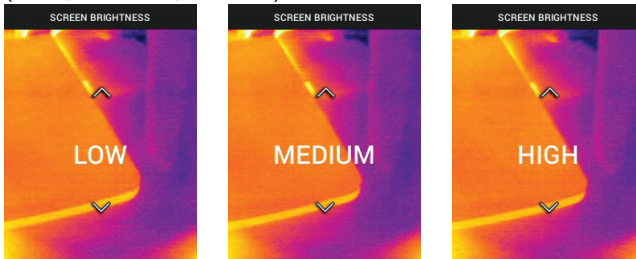

-
- Flashlight settings: You can set the default intensity for the HIGH and LOW flashlight. Press MENU at the Flashlight settings option and then press MENU at the HIGH or LOW option. Then use the arrows to select the desired default intensity in percent (%).

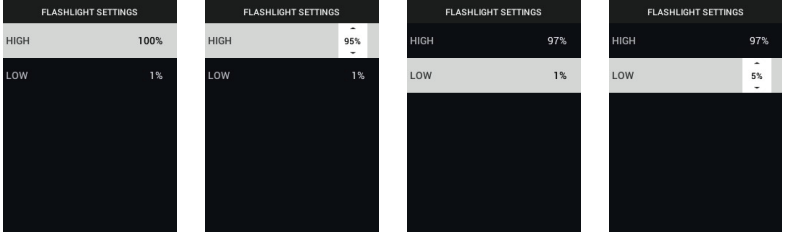

- Auto Power Off (APO): Use the arrows to scroll and MENU to select the desired APO time (5/15/30 minutes). Set to 'NEVER' to disable APO.

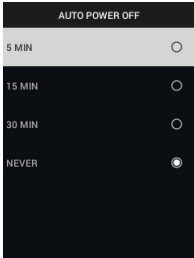

• **GENERAL SETTINGS**

- Temperature Unit: Use the arrows and the MENU button to select °C or °F.

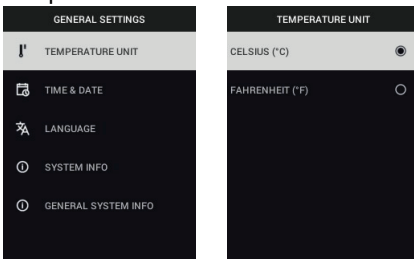

2. Time & Date: Use the arrows to scroll and the MENU button to set TIME, DATE, TIME FORMAT (12- or 24-hour clock), and DATE FORMAT.

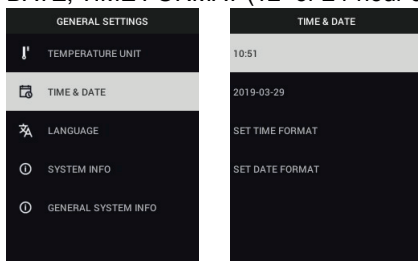

3. Language: Use the arrows to scroll and the MENU button to select a language.

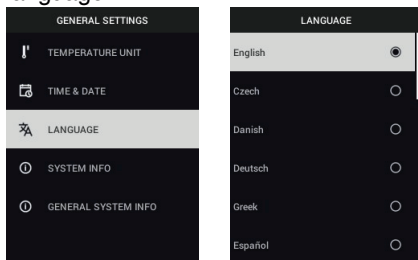

4. System Info: Scroll to desired topic: **Model Number**, **Serial Number**, **Software Level**, **Revision**, **Battery** status (%), remaining Internal **Storage Capacity**, and **Flashlight software** version.

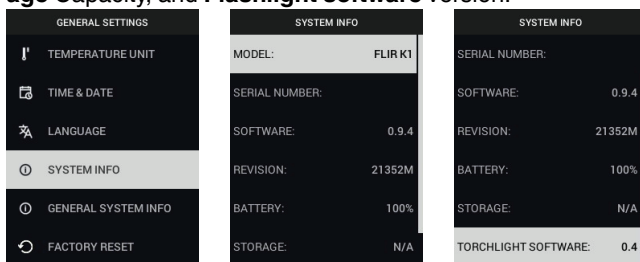

- **GENERAL SYSTEM INFO**: Press MENU to view compliance information.

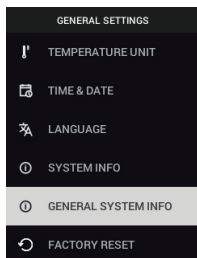

7 Field Firmware Updates

The K1 includes a USB-C port in the top compartment. The USB port allows the user to update the System firmware by first downloading an update file from the FLIR website and then connecting the K1 to a PC to transfer the file. Firmware updates are available from: <https://support.flir.com>.

To update the firmware, you will need:

- Access to the website where the update file(s) are located: <https://support.flir.com>
- The K1 to be updated
- The update file(s). Refer to the steps in the next sections:



NOTE

The K1 must have at least 50% battery power to perform an update.

7.1 System Firmware upgrade

1. Visit <https://support.flir.com> to obtain a firmware update file.
2. Select the 'Downloads' tab and then select 'Instrument Firmware' (Test and Measurement) from the drop-down menu.
3. Select the K1 from the second drop-down menu.
4. Select and download the system firmware update file to the PC.
5. With the K1 **ON**, connect it to the PC via the supplied USB-C cable.
6. Copy the firmware update file to the K1 root directory.
7. Eject the K1 from the PC.
8. Disconnect the K1 from the PC.
9. Follow the on-screen prompts to complete the update.
10. When the update is complete, cycle the power to the K1. If a factory reset was performed, please set the date and time before use.

8 Maintenance

8.1 Cleaning

Wipe the housing with a damp cloth as needed. Do not use abrasives or solvents. Clean the lenses with a high-quality lens cleaner.

8.2 Battery Service

The rechargeable lithium battery is not user-serviceable. Please contact FLIR support for service instructions: <https://support.flir.com>.

If the K1 is not to be used for an extended period (> 3 months), it should be charged to 70% then stored at room temperature and recharged every 6 months. Failure to do so may result in a battery that cannot be recharged and therefore will require service.

If the K1 has not been used for an extended period, and the battery has completely drained, it will require a three-hour safety charge to reach a baseline where regular charging can then begin.

8.3 Disposal of Electronic Waste



This equipment must be disposed of in an environmentally friendly way, and in accordance with existing regulations for electronic waste. Please contact your FLIR Systems representative for additional information.

8.4 Reset the K1

If the K1 display freezes, press and hold the up and down buttons for at least 10 seconds. Release the buttons when the K1 switches off. Restart the K1 to continue use. No data will be lost by resetting the K1. If problems persist, contact FLIR for support.

9 Specifications

9.1 Imaging and Optical Specifications

IR resolution	160 x 120 pixels
Thermal sensitivity /NETD	< 100 mK
Field of view (FOV)	57° x 44°
F-number	1.1
Image frequency	8.7 Hz
Focus	Fixed

9.2 Detector Specifications

Detector type	FLIR Lepton® microbolometer Focal Plane Array (FPA)
Spectral range	8 ~ 13 μm
Pitch	12 μm

9.3 Visual Camera Specifications

Resolution	2M Pixels
Focus	Fixed
Field of View (FOV)	71° x 56° (adapts to IR lens)

9.4 Image Presentation Specifications

Resolution	240 (W) x 320 (H) pixels
Screen size	2.4 inches
Viewing angle	80°
Aspect ratio	4:3
Display technology	Color TFT
Image adjustment	Automatic

9.5 Measurement Specifications

Object temperature range	<ul style="list-style-type: none"> • High Gain Mode: 14 ~ 284°F (–10° ~ +140°C) • Low Gain Mode: 14 ~ 752°F (–10 ~ +400°C) (at room temperature)
Accuracy	<p>Accuracy for ambient temperatures of 50 ~ 95°F (10 ~ 35°C):</p> <ul style="list-style-type: none"> • High Gain Mode: ±9°F (5°C) or ±5% • Low Gain Mode: ±18°F (10°C) or ±10%

9.6 Measurement Analysis Specifications

Spot meter	Center spot
Isotherm	<ul style="list-style-type: none"> • Yellow coloring: 150 ~ 250°C (302 ~ 482°F) • Orange coloring: 250 ~ 350°C (482 ~ 662°F) • Red coloring: > 350°C (662°F)
Colors (palettes)	<ul style="list-style-type: none"> • T1 Basic (white-hot with isotherm) • Iron • White-hot

9.7 USB Specifications

USB type	USB-C
USB standard	USB 2.0 high speed

9.8 Image Storage Specifications

Storage media	<p>Internal memory (4G)</p> <p>Approx. 10 pairs of .jpg images (radiometric and separate visual image)</p>
File format	<p>Approx. 10k pairs of .jpg images (radiometric image and separate visual image)</p>

9.9 Flashlight Specifications

Lighting type	Bright LED
LED CCT	5700
LED CRI	70

Field of View	> 71°
Intensity	300 Lumens

9.10 Battery Power System Specifications

Battery type	Internal Lithium-ion (not user-serviceable)
Battery voltage	3.7 V
Battery capacity	3000 m Ah
Battery operation time	MSX® mode: 5.5 hours Flashlight only: 3.8 hours
Charging time	4 hours to 90% 6 hours to 100%

9.11 Environmental Specifications

Pollution	Degree 2
Altitude	6562 ft. (2000 m) max.
Operating temperature range	Continuous (flashlight ON): 14°F ~ +113°F (10°C ~ +45°C) Continuous (flashlight OFF): 14°F ~ +131°F (10°C ~ +55°C) Flashlight ON < 10 minutes: 14°F ~ +194°F (10°C ~ +90°C) Flashlight ON < 2 minutes: 14°F ~ +239°F (10°C ~ +115°C)
Storage temperature range	-22 ~ +131°F (-30 ~ +55°C)
Humidity range	<ul style="list-style-type: none"> • 0–90% RH 32 to 99°F (0° to 37°C) • 0–65% RH 99 to +113°F (37° to 45°C) • 0–45% RH 113 to +131°F (45 to 55°C)
EMC	<ul style="list-style-type: none"> • EN 61000-6-2:2005 (Immunity) • EN 61000-6-3:2011 (Emission)
Hazardous substance	<ul style="list-style-type: none"> • WEEE 2012/19/EU • RoHs 2011/65/EU • REACH Regulation EC 1907/2006
Magnetic field	EN 61000-4-8 Class 3

Encapsulation	IP67 (IEC 60529). Waterproof with lid open or closed.
Shock	25 g (IEC 60068-2-27)
Vibration	2 g (IEC 60068-2-6)
Drop	6.6 ft. (2 m)
Safety	Camera: IEC/EN61010-1

9.12 Physical Specifications

Weight (incl. battery)	0.9 lbs. (0.4 kg)
Dimensions (L x W x H)	8.2 x 3.3 x 2.6 in. (208 x 85 x 65 mm)
Accessory mounting	¼"-20 threaded mount

9.13 List of Package Contents

- K1 Camera
- Printed Quick Start document
- Wrist-strap lanyard
- USB-C to USB-A cable
- Carry pouch

10 Appendix

10.1 IR Energy and Imaging Overview

A thermal imager generates an image based on temperature differences. In a thermal image the hottest item in the scene appears as white and the coldest item as black, and all other items are represented as a gray scale value between white and black. It may take some time to get used to the thermal imagery. Having a basic understanding of the differences between thermal and daylight cameras can help with getting the best performance from the K1.

One difference between thermal and daylight cameras has to do with where the energy comes from to create an image. When viewing an image with an ordinary camera, there must be some source of visible light (something hot, such as the sun or lights) that reflects off the objects in the scene to the camera. The same is true with human eyesight; what people see is based on reflected light energy. On the other hand, the thermal imager detects energy that is directly radiated from objects in the scene. Therefore, hot objects such as parts on an engines and exhaust pipes appear white, while the sky, puddles of water and other cold objects appear dark (or cool). Scenes with familiar objects will be easy to interpret with some experience.

Infrared energy is part of a complete range of radiation called the electromagnetic spectrum. The electromagnetic spectrum includes gamma rays, X-rays, ultraviolet, visible, infrared, microwaves (RADAR), and radio waves. The only difference is their wavelength or frequency. All these forms of radiation travel at the speed of light. Infrared radiation lies between the visible and RADAR range of the electromagnetic spectrum. The primary source of infrared radiation is heat, or thermal radiation. Any object which has a temperature radiates in the infrared range of the electromagnetic spectrum. Even objects that are very cold, such as an ice cube, emit infrared. When an object is not quite hot enough to radiate visible light, it will emit most of its energy in the infrared. For example, hot charcoal may not give off light, but it does emit infrared radiation, which we feel as heat. The warmer the object, the more infrared radiation it emits.

Infrared imaging devices produce an image of invisible infrared or 'heat' radiation that is unseen by the human eye. There are no colors or 'shades' of gray in infrared, only varying intensities of radiated energy. The infrared imager converts this energy into an image that we can interpret. The Infrared Training Center (ITC) offers training (including online training) and certification in all aspects of thermography: <https://www.infraredtraining.com>.

11 2–10 Extended Warranty

To activate the extended 2–10 warranty, please register your product within 60 days of purchase. Otherwise, the standard one-year warranty will be in affect from date of purchase. The 2–10 warranty covers parts and labor for the camera for 2 years and coverage of the detector for 10 years. Register your product at <https://support.flir.com/prodreg>.

12 Customer Support

Repair, Calibration, and Technical Support: <https://support.flir.com>.

12.1 Corporate Headquarters

FLIR Systems, Inc., 27700 SW Parkway Avenue, Wilsonville OR 97070, USA



Website

<http://www.flir.com>

Customer support

<http://support.flir.com>

Copyright

© 2019, FLIR Systems, Inc. All rights reserved worldwide.

Disclaimer

Specifications subject to change without further notice. Models and accessories subject to regional market considerations. License procedures may apply. Products described herein may be subject to US Export Regulations. Please refer to exportquestions@flir.com with any questions.

Publ. No.: NAS100007
Release: AD
Commit: 61231
Head: 61231
Language: en-US
Modified: 2019-11-12
Formatted: 2019-11-12