



User Manual

Vibration Monitoring Solution

SV88/SV89-KIT





User Manual Vibration Monitoring Solution

Table of contents

1	Advisories	1
	1.1 Copyright.....	1
	1.2 Quality Assurance	1
	1.3 Documentation	1
	1.4 Disposal of Electronic Waste	1
2	Introduction	2
3	Safety	4
	3.1 FCC Class A Caution.....	5
	3.2 IC Caution.....	5
4	Product Descriptions	6
	4.1 GW66 Gateway Description	6
	4.2 Sensor Description	7
	4.3 Sensor Battery Installation and Replacement.....	9
	4.4 Sensor Battery Life	11
	4.5 Web-Server User Interface Overview	12
5	System Architecture	13
6	Conventional and Advanced Applications	15
7	Setting up the GW66 Gateway	16
8	Configuring the Vibration Monitoring System	17
	8.1 Connecting to the GW66 2.4 GHz Network.....	17
	8.2 Preparing Sensors	18
	8.3 Adding Sensors to the GW66	18
	8.4 The Sensor List Field in the Web-Server Interface.....	19
	8.5 Completing the Sensor Connection	19
	8.6 Sensor Reset Button	20
	8.6.1 Reset Button Overview.....	20
	8.6.2 Revert Sensor to Factory Default Status.....	20
	8.6.3 Force Data from the Sensor to the Gateway	20
	8.6.4 Restart the Sensor and Set the Measurement Rate.....	21
9	Connect GW66 to the Local Network	22
	9.1 Connect the GW66 to the 5 GHz Network	22
	9.2 Connect the GW66 using Ethernet.....	25
10	Sensor Installation	27
	10.1 Sensor Placement Considerations.....	27

Table of contents

10.2	Mounting the Sensors.....	27
10.3	Where sensors should not be placed	29
10.4	Determining the Number of Sensors to Place on Equipment	29
10.5	Documenting Sensor Locations	30
11	Web-Server User Interface	31
11.1	Launching the User Interface.....	31
11.2	Dashboard Page	33
11.3	Sensor LIST Page.....	34
11.4	Sensor DATA Page	35
11.5	Sensor ADD Page	36
11.6	Sensor EDIT Page	37
11.7	Configuration OVERVIEW Page.....	38
11.8	Configuration Setup (General) Page	39
11.9	Configuration Setup (TCP/IP) Page.....	40
11.10	Configuration Setup (Wi-Fi) Page	40
11.11	Configuration Setup (ADMIN) Page	41
11.12	Modbus TCP Host Utility	42
11.13	MQTT Host Utility	42
11.14	OPC UA Host Utility	43
12	Mapping a Test Site	44
13	Fast Fourier Transform (FFT)	45
13.1	Background.....	45
13.2	Time-Domain and Frequency-Domain Methods	45
13.3	Determining Machine Defects by Vibration Characteristics	45
14	Specifications	47
14.1	GW66 Specifications	47
14.2	Sensor Specifications	48
15	Firmware Upgrades	50
15.1	Overview	50
15.2	Firmware Update Procedure	50
16	Customer Support.....	52
17	Limited 3–Year Warranty.....	53

1 Advisories

1.1 Copyright

© 2023 FLIR Systems, Inc. All rights reserved worldwide.

No parts of the software including source code may be reproduced, transmitted, transcribed or translated into any language or computer language in any form or by any means, electronic, magnetic, optical, manual or otherwise, without the prior written permission of FLIR.

The documentation must not, in whole or part, be copied, photocopied, reproduced, translated or transmitted to any electronic medium or machine-readable form without prior consent, in writing, from FLIR Systems, Inc. Names and marks appearing on the products herein are either registered trademarks or trademarks of FLIR Systems, Inc. and/or its subsidiaries. All other trademarks, trade names or company names referenced herein are used for identification only and are the property of their respective owners.

1.2 Quality Assurance

The Quality Management System under which these products are developed and manufactured has been certified in accordance with the ISO 9001 standard. FLIR Systems, Inc. is committed to a policy of continuous development; therefore, we reserve the right to make changes and improvements on any of the products without prior notice.

1.3 Documentation

To access the latest manuals and notifications, go to the Download tab at: <https://support.flir.com>. It only takes a few minutes to register online. In the download area you will also find the latest releases of manuals for our other products, as well as manuals for our historical and obsolete products.

1.4 Disposal of Electronic Waste



As with most electronic products, this equipment must be disposed of in an environmentally friendly way, and in accordance with existing regulations for electronic waste. Please contact your FLIR representative for more details.

2 Introduction

The FLIR Vibration Monitoring Solution consists of the GW66 Remote Monitoring Gateway and SV88 (three axis) / SV89 (single axis) Vibration Sensors. This system allows you to monitor vibration and temperature on a variety of machinery and appliances over a local network. The GW66 has a built-in user interface that allows you to configure and control the entire system directly from your Windows® PC and mobile devices.

Accelerometers in the sensors measure changes in vibration. Thermometers in the sensors measure surface temperature. Examples of equipment that can be monitored are shown below.

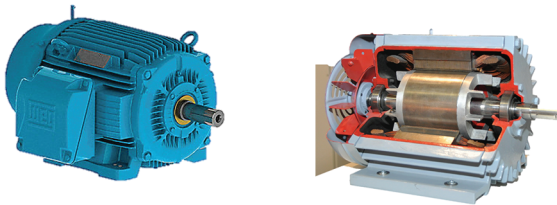

Figure 2.1 Monitoring vibration and temperature in motors.

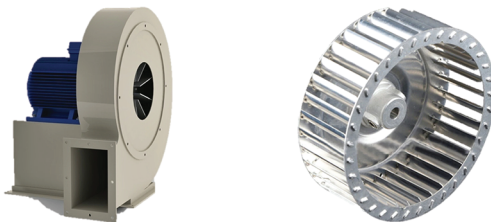

Figure 2.2 Monitoring vibration and temperature in fans.



Figure 2.3 Monitoring vibration and temperature in conveyors.



Figure 2.4 Monitoring vibration and temperature in chillers.

Vibration measurements encompass the frequency (velocity), amplitude (strength), and acceleration (intensity) of the vibration.

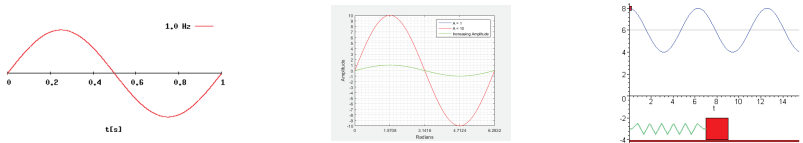

Figure 2.5 Vibration frequency (left), amplitude (centre), and acceleration (right)







Vibration measurements provide insight into potential mechanical issues. This device is well suited for identifying imbalances, eccentricity, loose parts, and misalignment. Surface temperature measurements identify potential overheating issues. Excessive vibration and over-temperature conditions can shorten the life of machinery and components, pose safety hazards, and create excessive noise.

Acceleration is measured in 'g' units (gravitational constant). Velocity is represented in mm/s (millimetres per second) and in/s (inches per second) units and is derived from internal calculations. Temperature measurements are presented in °C and °F units.

3 Safety

Warnings identify conditions that expose the user to danger. For safe operation, and to avoid the potential for electrical shock and fire, read and understand all operational instructions and safety warnings and cautions. Failure to do so can cause personal injury and damage to equipment.

- Please read all safety information and user manual instructions before using these devices.
- No user serviceable equipment. Please contact FLIR for all service and repair inquiries.
- Use these devices only as described in the provided documentation. Failure to do so can impair the devices' built-in protections.
- These devices are intended for indoor use only.
- Do not use any of these devices if they appear damaged or if they do not function normally. Contact FLIR for service.
- Avoid wet or overly damp locations for installation or when using these devices.

	WARNING! Hazardous conditions.
	Double Insulation.
	Certified by ETL to North America safety standards.
	Conforms to European Union directives.
	Conforms to Australian Safety and EMC standards.
	Complies with WEEE Directives.

3.1 FCC Class A Caution

FCC Warnings. Applicability: Class A digital devices.

This equipment has been tested and found to comply with the limits for a Class A digital device, pursuant to part 15 of the FCC Rules. These limits are designed to provide reasonable protection against harmful interference when the equipment is operated in a commercial environment. This equipment generates, uses, and can radiate radio frequency energy and, if not installed and used in accordance with the instruction manual, may cause harmful interference to radio communications. Operation of this equipment in a residential area is likely to cause harmful interference in which case the user will be required to correct the interference at his own expense.

3.2 IC Caution

(15.21): Changes or modifications to this unit not expressly approved by the party responsible for compliance could void the user authority to operate the equipment.

1. To comply with FCC/RSS-102 RF exposure compliance requirements, a separation distance of at least 20 cm must be maintained between the antenna of this device and all persons.
2. This device's transmitter must not be placed near, or in conjunction with, any other antenna or transmitter.

Cet appareil est conforme aux normes RSS exemptes de licence d'Industrie Canada.

Le fonctionnement est soumis aux deux conditions suivantes:

1. Cet appareil ne doit pas causer d'interférences et
2. Cet appareil doit accepter toute interférence, y compris les interférences pouvant entraîner un fonctionnement indésirable de l'appareil.

4 Product Descriptions

4.1 GW66 Gateway Description

The GW66 gateway is first used as a local stand-alone 2.4 GHz network for configuring your monitoring system (adding and connecting sensors, customizing sensor names, etc.).

Once the system is configured, you then connect the GW66 to the local network. You can connect the GW66 to a 5 GHz network either with Wi-Fi or by directly connecting the GW66 to a router or modem with an Ethernet cable (not supplied).

The GW66 has its own web-based user interface that you use to configure the system and to monitor a test area. See the System Architecture diagram in Section 5 for an overview of the system.

The GW66 is powered either by connecting an Ethernet cable to the GW66 LAN 1 input port or using the optional 12 V AC adaptor (1.0 A, minimum; 100 to 240 V AC; 50 / 60 Hz). Multiple gateways can be used for optimum coverage of large test sites. Each GW66 can monitor and control up to eight (8) sensors. The GW66 is compatible with a variety of industry host protocols, including Modbus TCP, MQTT, and OPC UA.

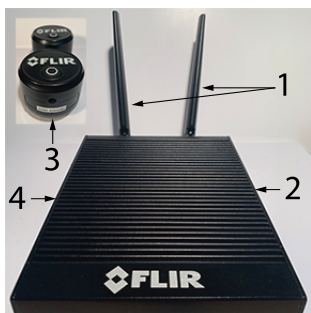

Figure 4.1 The GW66 shown with sensors.

1. Two antennae connect to the posts on the rear of the GW66.
2. Side access panel for power and LAN connections, status LED lamps, reset button, and earth ground connection (on some versions, the earth ground connection is on the opposite side). See Figure 4.2, below, for information on this panel.
3. Sensors (see Sections 4.2 and 4.3 for sensor descriptions).

4. Mounting holes (ground lug also located on this side on some versions).

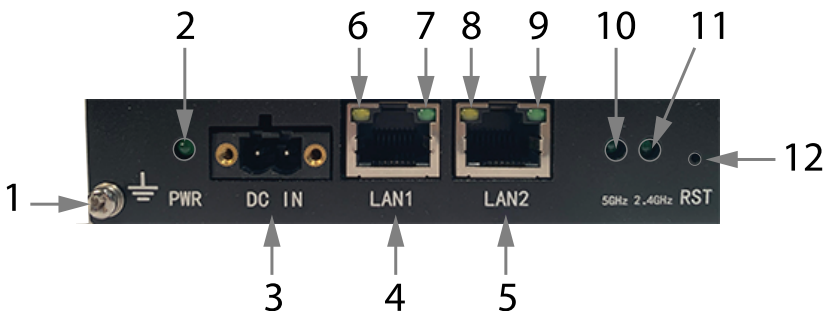

Figure 4.2 GW66 side access panel.

1. Earth ground connection. On some versions the connection is on the opposite side.
2. Power status LED lamp. Blinks green while powering. Solid green when fully powered.
3. Power connection (12 V DC, 1.0 A minimum), optional AC adaptor available.
4. LAN 1 Ethernet connection port. This is a powered device (PD) port. *Power over Ethernet* (PoE) can be supplied on this port.
5. LAN 2 Ethernet connection port (this port can not accept power).
6. LAN 1 Yellow LED (lit when disconnected).
7. LAN 1 Green LED (lit when connected).
8. LAN 2 Yellow LED (lit when disconnected).
9. LAN 2 Green LED (lit when connected).
10. LED is lit solid when not connected. LED blinks when connected to 5.0 GHz network (indicating that data is transferring).
11. LED is lit solid when not connected. LED blinks when connected to 2.4 GHz network (indicating that data is transferring).
12. Reset button (recessed). To reset the unit, long press this button until the power LED blinks rapidly.

4.2 Sensor Description

- **SV88 Remote Sensor.** Attaches to machinery and transmits 3 axis (xyz) measurement data and battery status to the GW66.
- **SV89 Remote Sensor.** Attaches to machinery and transmits single axis (x) measurement data and battery status to the GW66.

Sensors can be bolted onto machinery or the optional mounting base (FLIR TA88) can be used.

Sensors measure Acceleration in gravitational units (g) and surface temperature in °C or °F units. Velocity data are derived from internal calculations and displayed in mm/s or in/s units (millimetres or inches per second). For frequency ranges for the sensors, see the Specifications section.

Measurement data is transmitted from the sensors to the GW66 over the GW66 local 2.4 GHz network. Sensors also transmit battery status. Serial number are printed on the outside and inside of the sensor (and transmitted to the GW66 for identification).



Figure 4.3 Sensor Housing.

1. Sensor reset button.
2. Sensor cover. Removable by unscrewing from its base, after removing set-screw.
3. Set-screw.
4. Sensor transducers (bottom).
5. Serial number.

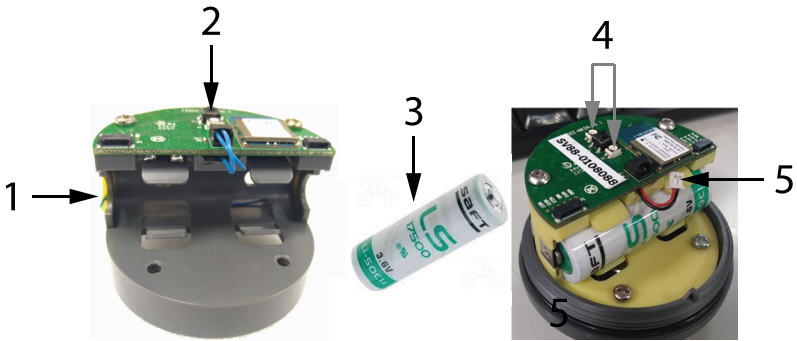

Figure 4.4 Inside view of sensor

1. Battery compartment.
2. Reset button.
3. Battery **SAFT LS17500** (supplied)
4. LED status lamps (see Table 4.1, below).
5. Battery connecting cable. Remove and reattached to cycle power to the sensor.

4.3 Sensor Battery Installation and Replacement

Sensors are battery powered using a **SAFT LS17500** battery type (supplied), the battery holder is located inside the sensor housing, as shown in Fig. 4.4, above. The battery must be installed before the sensor can be used. See steps below for battery installation and replacement. For additional sensor battery installation information, see Section 10.

1. Remove sensor set-screw (shown in Fig. 4.3, above).
2. Unscrew sensor housing cover from its base.
3. Remove an existing battery by pushing it out of its holder using a nonconducting tool (plastic or wood), through the access hole indicated by the arrow in Fig. 4.5, below.
4. Insert new battery, following correct polarity.
5. Refer to Table 4.1, below, to interpret the color-coded sensor LED lamps.

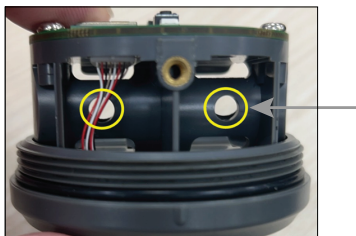

Figure 4.5 To remove the battery, push it out of its holder through the access hole, indicated by the arrow, using a nonconducting tool (plastic or wood).

Table 4.1 Color-coded sensor LED lamp activity when powering the sensor.

Blue	The two LED lamps blink twice in blue if the sensor is new and has never been connected to a GW66.
Green	The two LED lamps blink twice in green if the sensor was previously paired with a GW66. Note that if you are pairing a sensor that was previously paired, and you're now using a different GW66, you must first reset the sensor to its factory default condition, per Section 8.6. After the reset, the LED lamps will blink twice in blue when powered.
Yellow	The two LED lamps blink twice in yellow if it fails to send data to the GW66 successfully.
Red	The two LED lamps blink red, at the data logger sample rate, when battery power is < 20%

4.4 Sensor Battery Life

Sensors are powered when a **SAFT LS17500** battery (supplied) is installed in the sensor. To install or replace the battery, refer to Section 4.3.

Refer to the graphs, below, for battery life estimation.

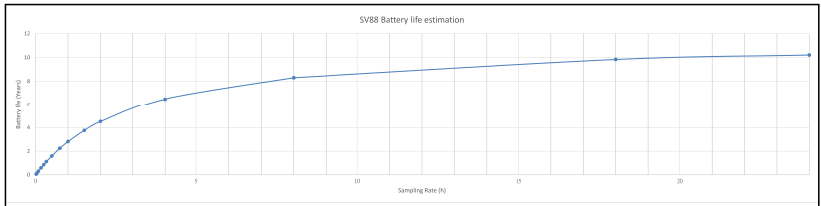

Figure 4.6 SV88 battery life estimation. The shorter the measurement sampling rate, the more the drain on the battery.

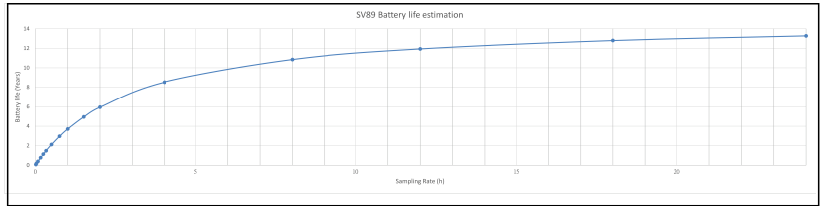

Figure 4.7 SV89 battery life estimation. The shorter the measurement sampling rate, the more the drain on the battery.

4.5 Web-Server User Interface Overview

The vibration monitoring system is controlled from your PC and mobile devices using the web-server application built-in to the GW66, accessible via the Microsoft® Edge® browser (using *New InPrivate Window* mode), Google® Chrome® (using *New Incognito Window*), or Firefox® (using *New Private Window*). These window modes are accessible by right-clicking the browser's program icon.

The interface screens are interactive and available on your PC and mobile devices. The user interface Dashboard is shown below, in Figure 4.8. For complete information on this web-based user interface, please refer to Section 11.

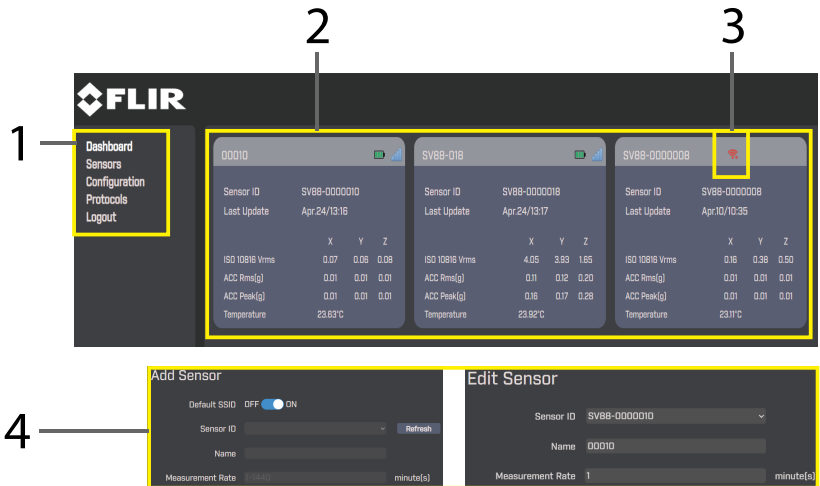

Figure 4.8 The main Dashboard.

1. Select the page to view (Dashboard page is shown).
2. View sensor information.
3. Check communication status. A red icon indicates communication is lost.
4. To Add or Edit a sensor, click SENSOR from the list on the left of the screen. You can set a sensor's name and measurement sample rate from either the Add or Edit window.

5 System Architecture

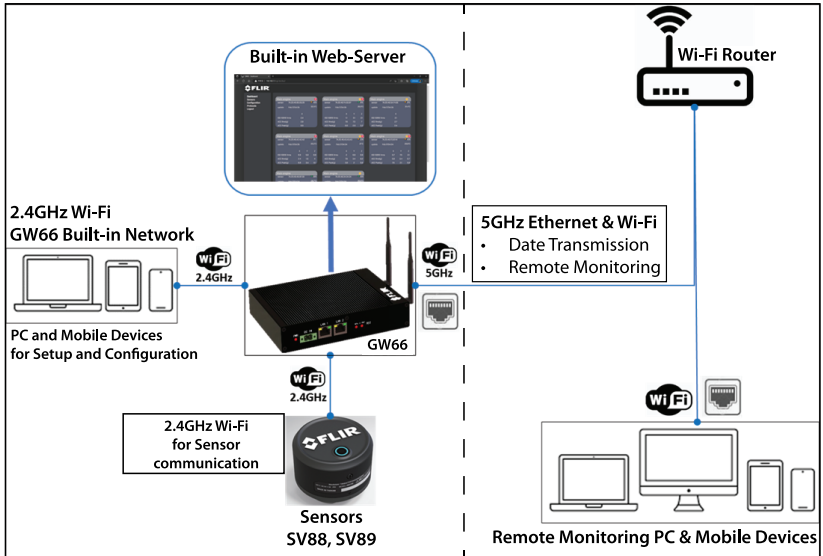

Figure 5.1 System Architecture.

Figure 5.1, above, is divided by the vertical dashed line to illustrate the difference between the configuration stage (left) and the in-practice stage (right).

- The left side of Figure 5.1, above, shows the local GW66 2.4 GHz network, which your PC and mobile devices initially connect with while configuring the system. After configuration, the PC and mobile devices will connect to your network. Note that the sensors always communicate with the GW66 on this 2.4 GHz network, even later when you connect the GW66 with your network.
- Above the GW66 you can see the web-server user interface screen. This interface is available during the setup stage and, later, in practice, controlling and monitoring your test system. You access this interface using a browser on your PC and mobile devices, as explained in Section 11.
- The right side of Figure 5.1 shows the GW66 connected to your network, in use at the facility where your equipment will be monitored. The GW66 can connect to a 5 GHz network with Wi-Fi or with an Ethernet cable connected to your modem or router.

- On the bottom, right, of Figure 5.1, the PC and mobile devices are shown communicating over your network. It's important to understand that, first, the PC and mobile devices connect to the GW66's local network for configuring and adding sensors, etc. (left side of Figure 5.1). and, second, the mobile devices and PC connect to your network (Wi-Fi or Ethernet) in actual use, with the sensors always communicating over the GW66's own network.

6 Conventional and Advanced Applications

For general use, you connect the GW66 to your network, the sensors communicate with the GW66, and your PC and mobile devices are used to access the web-based user interface for full control of the system.

For advanced use, the GW66 can be connected to an Industry Host such as Modbus, MQTT, or OPC UA. These systems offer advanced vibration data analysis and database management.

Sections 11.12, 11.13, and 11.14 provide basic information on these hosts, but separate application notes should be obtained from the FLIR support site for complete information.

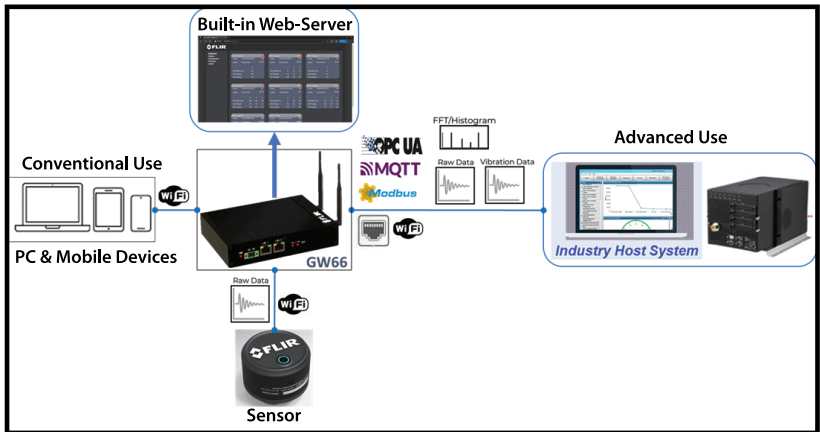

Figure 6.1 Conventional and advanced use.

7

Setting up the GW66 Gateway



CAUTION

The GW66 should not be mounted at a height exceeding 6.6 ft. (2 m).

Refer to the Product Descriptions, in Section 4, when following the steps below.

For the initial setup you do not need to be in the area where the system will ultimately be used. The setup stage is where you can verify proper communication between the GW66, sensors, PC and mobile devices, name sensors, change settings, and more. This is done using the 2.4 GHz local network and user interface built-in to the GW66. Once verified and configured, you can install the GW66 and sensors at the intended test site and connect to the site's local network.

1. Carefully remove the GW66 and its accessories from the packaging.
2. Place the GW66 on a flat surface. Do not place it on or near a source of heat.
3. Connect the two antennae to the GW66 by carefully attaching them to the threaded posts (back of GW66). Do not overtighten.
4. The GW66 is powered either by connecting an Ethernet cable to the GW66 LAN 1 input port or using the optional 12 V AC adaptor (1.0 A, minimum; 100 V to 240 V AC 50 / 60 Hz). The power LED (PWR) will blink green while booting. Once fully booted, the power LED (and the 2.4 and 5 GHz LED lamps) will glow green steadily.
5. The GW66 earth ground connection does not necessarily need to be made at this stage, unless there is a concern for ground loops and other safety issues during the configuration.
6. To perform a factory default reset, use a paper clip, or other pointed tool, to press the reset (RST) button until the power LED blinks rapidly. The GW66 will automatically reboot and power up in the factory default state.

8 Configuring the Vibration Monitoring System

8.1 Connecting to the GW66 2.4 GHz Network

As mentioned, the GW66 has its own 2.4 GHz network that you use to configure the system by adding/naming sensors, and other tasks. Note that the sensors always communicate over this network, and communicate only through the GW66, even when the GW66 is later connected to your network. See Section 5, *System Architecture*, for a graphic illustration of this concept.

1. The GW66 is powered either by connecting an Ethernet cable to the GW66 LAN 1 input port or using the optional 12 V AC adaptor, as explained in Section 7. The user interface is generated by the GW66, so you cannot access the interface if the GW66 is not powered.
2. With the GW66 powered, it should appear on list of available networks on your PC, as shown here.

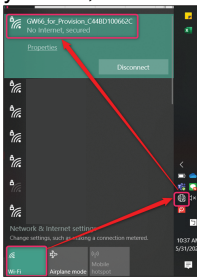

3. Click on the network named '**GW66_for_Provision**'.
4. Enter the default password (**FLIRPROV**) when prompted (change the password per Section 11.11).
5. If the connection is successful, the 2.4 GHZ LED on the GW66 will blink.
6. Right click on the Microsoft Edge browser (or other browser of choice) to open a **New InPrivate window**, as shown here.

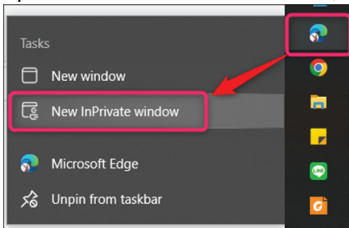

7. Type **192.168.2.1** in the address bar, as shown here.

- Type the default password (**admin**) when prompted. Change the password per Section 11.11.

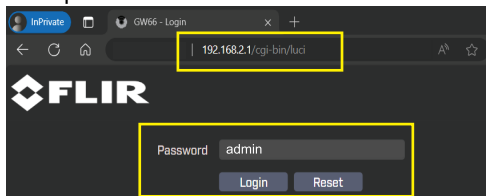

- When you successfully connect with the GW66 network the Configuration window will appear in the browser. Customize the system using this window, refer to Section 11 for detailed information on the Configuration window.



Figure 8.1 The GW66 user interface Configuration window. See Section 11 for complete details.

8.2 Preparing Sensors

Before proceeding, please follow the instructions, provided above in Section 8.1, for connecting to the GW66 local network and accessing the web-server user interface. Refer to Sections 4.2 and 4.3 for sensor battery information, including battery installation and replacement instructions.

8.3 Adding Sensors to the GW66

Refer to Figure 8.2, below, for these instructions.

- Power only one sensor, as described in Sections 4.2 and 4.3 (only one sensor can be added at a time).
- From the web-server screen, select **Sensor** and then select **Add Sensor**.
- Set the Default SSID to the **ON** state. Set to **OFF** if using more than one GW66, otherwise all of the GW66 units will attempt to connect to the same sensor.

- The GW66 will recognize the sensor and the web-server interface will show the detected sensor in the ID field. If you do not see the sensor listed, press **F5** on the PC to refresh the web-server page (or click **Refresh** in the ID field). If the sensor still does not appear, disconnect and reconnect the battery cable inside the sensor (per Section 4.2).
- When you see the sensor listed in the ID field, type a unique sensor name that will assist in later identification.
- Type the preferred measurement sample rate, from 1 to 1440 minutes (24 hours).

Figure 8.2 Adding sensors to the GW66.

8.4 The Sensor List Field in the Web-Server Interface

When a sensor is successfully connected to a GW66, it will appear on the Sensor List page (see Figure 8.3, below) and its status will update at the sample (measurement) rate selected in Section 8.3, above. It may require several minutes for the GW66 to update the status of the sensor when first connected.

The sensor's LED lamps will blink green twice, at the selected sample rate, indicating that data is being transferred to the GW66. You can press **F5** on the PC at any time to refresh the web-server interface screen.

Sensor ID	Name	Last Measure Time	Measure Status	Battery	Signal	Status
SV88-0000010	00010	2024-04-24 14:27:57	Normal	🔋	📶	Export Remove
SV88-0000018	SV88-018	2024-04-24 14:26:38	Normal	🔋	📶	Export Remove
SV88-0000008	SV88-0000008		Updating			Remove

Figure 8.3 The Sensor List in the user interface shown with one sensor actively updating.

8.5 Completing the Sensor Connection

After the steps above have been followed, reattach the sensor cover to the sensor, if you have not already done so. Align the hole on the side of the

sensor cover with the set screw mounting hole and reattach the set screw to secure the sensor housing.

8.6 Sensor Reset Button

8.6.1 Reset Button Overview

As covered in the following sections, the sensor's reset button can be used to revert the sensor to its factory default state, force data to the gateway, and to restart in order to change the measurement rate. The reset button is located on the top of the sensor, refer to Section 4.2.

The reset button is not operational while the sensor is activating or running intensive operations. Wait for the sensor to complete its current task before pressing it. When you press the reset button, the sensor's status LED lamps will glow white when it is not busy. If the LED lamps do not light when you press the reset button, this indicates that the sensor is busy.

8.6.2 Revert Sensor to Factory Default Status

Press and hold the reset button at the top of the sensor for 10 seconds, until the two LED lamps glow green, then blue, and finally red. The sensor will automatically restart and the lamps will blink twice in blue, if the reset is successful.

To manually reset the sensor, disconnect and reconnect the battery cable, inside the sensor housing, per Sections 4.2 and 4.3. The lamps will blink twice in blue if the reset is successful. If the lamps blinks red, the battery power is < 20% (see Section 4.3 for battery replacement instructions).

This procedure is used primarily to pair a sensor with a new GW66, after the GW66, with which it was previously paired, has been replaced. You can also use this procedure if a sensor stops communicating with a GW66 or otherwise behaves abnormally.

8.6.3 Force Data from the Sensor to the Gateway

Press and hold the reset button for 3 seconds, release the button when the LED lamps turn from white to green. After several seconds, the lamps should blink twice (green), indicating that the sensor has started sending its data to the gateway. If the lamps blink yellow twice, the operation has failed. Contact FLIR support if problems persist.

8.6.4 Restart the Sensor and Set the Measurement Rate

Press and hold the reset button for 5 seconds, release the button when the LED lamps turn from white to green to blue. Wait several seconds and if the LED lamps blink green twice, the sensor has been successfully reset. The measurement rate can now be reprogrammed, per Section 8.3.

9 Connect GW66 to the Local Network

Once the system has been configured, as covered in previous sections, it's time to move the components of the system to its permanent location. In this section we'll connect to the local 5 GHz network, place sensors, and more. You can connect over the 5 GHz network using Wi-Fi, or directly to the router or modem using the GW66 LAN1 or LAN2 Ethernet port. Note that the GW66 can be powered through the LAN1 port, but not the LAN2 port, as mentioned earlier.

Place the GW66 in the area where it will be permanently installed. Set it up, as described in earlier sections, and place the sensors near the equipment where they will be used. At this stage you may want to wait until communication with the sensors is again verified before permanently affixing them to machinery.

9.1 Connect the GW66 to the 5 GHz Network

As explained in Section 8.1, above, launch the GW66 user interface in Microsoft Edge browser's **New InPrivate Window** mode (you can also use Google Chrome or Firefox browsers using their *incognito* or *private network* modes, respectively). To open Microsoft Edge (or other browser) in this mode, right-click the browser program icon and select **New InPrivate Window**. Once you have the user interface open on your browser, follow the steps below.

1. From the main interface page, click on **SETUP**, as shown in Figure 9.1, below.
2. Click the **Wi-Fi** tab.
3. Select Wi-Fi **ON**.

4. Type your local Wi-Fi router's ESSID (network) username and password and then click **SAVE & APPLY**.

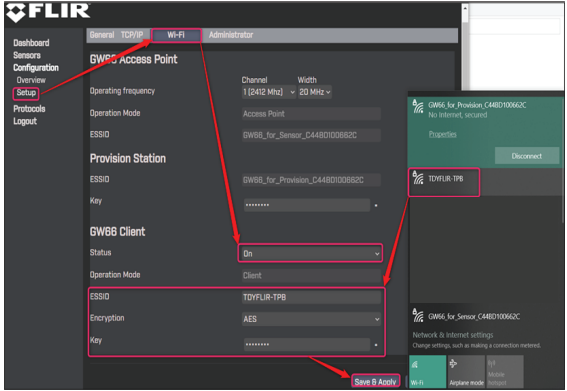
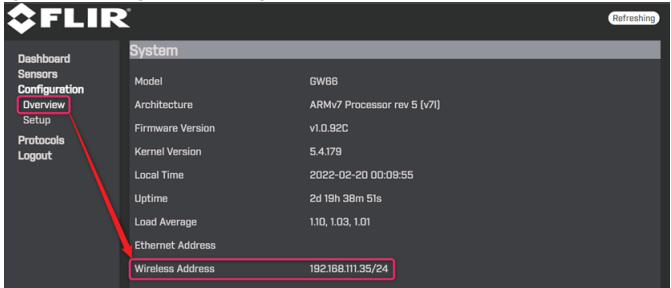
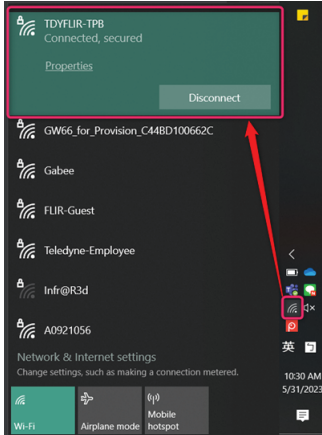

Figure 9.1 Connecting to the 5 GHz Wi-Fi Network.

5. If connection is successful, the 5 GHz LED lamp on the GW66 will blink, indicating data transfer.
6. Take note of the floating IP address assigned from the local Wi-Fi network as shown below. In this example, the address is 192.168.111.35/24; ignore the digits to the right of the forward slash (24, in this case).



- 7. Reconnect Wi-Fi to the assigned SSID (in the example, below: TDYFLIR-TPB), right-click the Microsoft Edge browser icon, and select NEW InPrivate window.



- 8. Enter the assigned floating IP address noted earlier, in the browser's address bar, and type the password (admin) in the password field. Change the password per Section 11.11

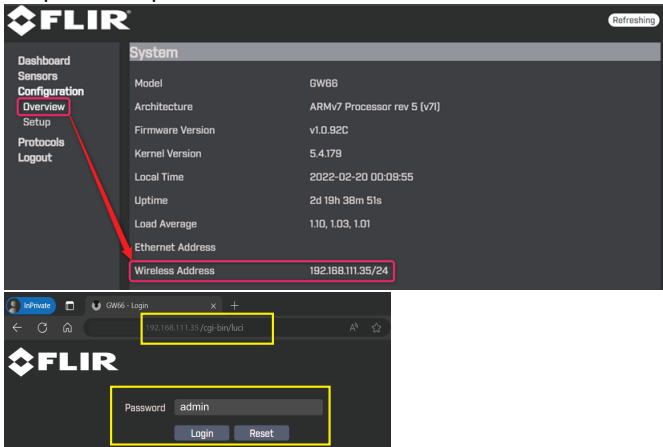

9.2 Connect the GW66 using Ethernet

Connect an Ethernet cable (not supplied) from the GW66 LAN1 or LAN2 port to your internet modem or router. The LAN2 port can not accept power, while the LAN1 port can (Power Over Ethernet, or PoE).



Figure 9.2 Connecting an Ethernet cable to the GW66.

1. From the main web-server screen, click **Configuration** and then click **Setup**, as shown below.

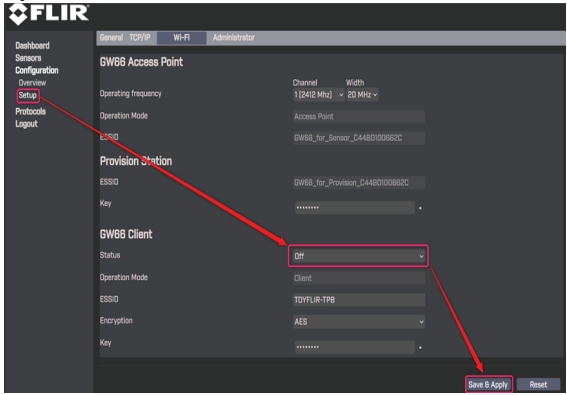

2. If communication is successful, the LED for LAN1 or LAN2 will begin blinking.
3. Take note of the floating IP address assigned from the local Wi-Fi network, as shown below. In this example, the address is 10.44.10.15/24. However, ignore the digits to the right of the forward slash (24, in this case).
4. Right click the Microsoft Edge browser icon and select **New InPrivate window**.

5. Enter the assigned floating IP address (minus the digits to the right of the forward slash), noted earlier, in the browser's address bar and type the password (**admin**) in the password field. Change the password per Section 11.11.

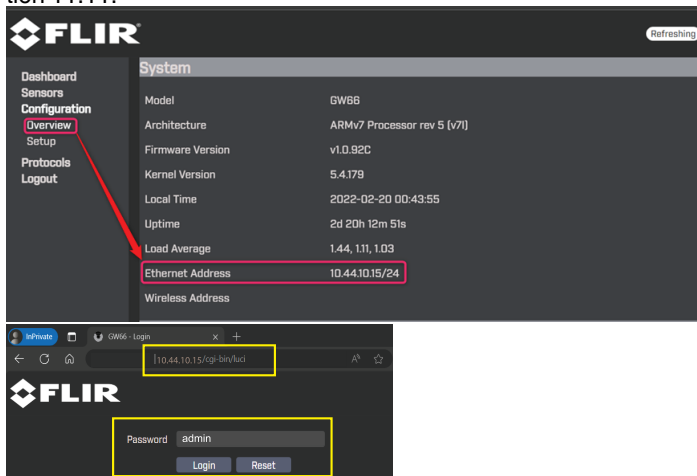

6. Refer to Section 11 for details regarding the web-server user interface.

10 Sensor Installation

NOTE

Do not permanently affix sensors to assets until you have ensured stable communication between the sensors and the GW66 in their temporary positions.

Sensors should not be mounted at a height exceeding 6.6 ft. (2 m).

10.1 Sensor Placement Considerations

When considering test point sensor locations, the individual parts of the equipment and its operation should be well understood. Basic rotating equipment will have a combination of bearings, shafts, shaft coupling, fans, pumps, compressors, etc. Note that the sensors may not be suitable for monitoring bearing or gearbox vibration, depending upon frequency. The sensor's linear frequency response range is from DC to 6 kHz (3 dB point) for the SV88, and DC to 11 kHz (3 dB point) for the SV89.

For personal and equipment safety, do not affix sensors where they can interfere with machine operation. Refer to the dedicated section below for a list of areas where sensors should not be affixed.

10.2 Mounting the Sensors

Sensors have a mounting socket on their base. You can bolt the sensor to the equipment or purchase an optional magnetic mounting base (FLIR TA88) that mates to the threaded hole on the base (bottom) of the sensor. Sensors should be mounted on solid metal, meaning structural parts of the equipment that significantly respond to the overall vibration and dynamic forces (example photos below).

For best results, clean the area where the sensor is to be attached. Sensors must be installed where they cannot interfere with the operation of machinery or where they will interfere with machine operators

Confirm stable communication between sensors and the GW66 before committing to a permanent installation. Move the GW66 closer to the sensors if necessary and use multiple gateways if greater coverage is required.

Although the maximum distance between sensors and gateway is 164 ft. (50 m), the range is affected by concrete, metal, etc. in the line-of-sight.

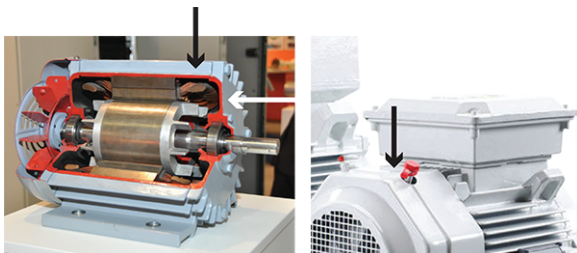



Figure 10.1 Examples of areas to place sensors.



Figure 10.2 Sensors shown mounted on machinery.

10.3 Where sensors should not be placed

	CAUTION
<p>Do not mount sensors on the following locations:</p> <ul style="list-style-type: none"> • Motor winding areas • Middle of motor • Pump casing • Cooling fan fins/covers • Coupling belt guards, gearboxes • Seal locations 	

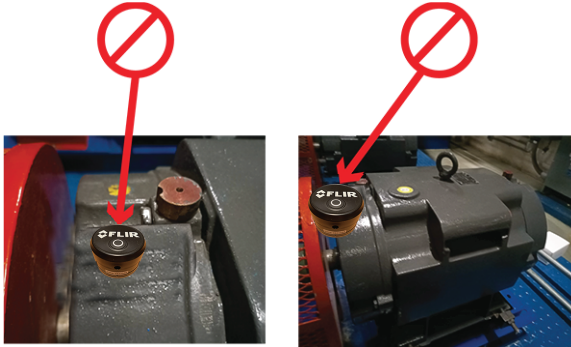

Figure 10.3 Examples of places you should not mount sensors.

10.4 Determining the Number of Sensors to Place on Equipment

The larger the equipment under test, the greater the number of sensors required; this is because vibrations can go undetected if the sensors are positioned too far from the source of vibration. Vibration is absorbed by the equipment after travelling approximately 1 m (3.3 ft.), so situate sensors strategically, to maximize coverage.

Determine the number of sensors needed, for adequate monitoring. Eight (8) sensors will work in most circumstances, given no obstruction between the GW66 and the sensors. The key factor is obstruction since, with no obstruction, it is possible to have more than eight sensors operating normally. Use multiple gateways to accommodate more sensors and to ensure proper coverage of a test site. Note that only eight sensors can be paired with each GW66.

10.5 Documenting Sensor Locations

It is important to document the sensor information and test point locations for all equipment in a test system, as discussed in Section 12.

Having accurate documentation helps locate, track, and assess equipment easily for preventive maintenance programs and servicing.

11 Web-Server User Interface

The user interface has been discussed briefly in previous sections. In this section each page of the interface is explained in detail.

The user interface is built into the GW66 and is accessed by right-clicking the Microsoft Edge browser icon and selecting **New InPrivate Window** (you can also use Google Chrome's *New Incognito Window* or Firefox's *New Private Window*). In this section, for convenience, we'll connect to the 2.4 GHz network that the GW66 supplies. However, it is the same interface you'll encounter when you go 'live' on your network.

11.1 Launching the User Interface

1. The GW66 is powered either by connecting an Ethernet cable to the GW66 LAN 1 input port or using the optional 12 V AC adaptor, as explained in Section 7. The user interface is generated by the GW66, so you cannot access the interface if the GW66 is not powered.
2. With the GW66 powered, it should appear on list of available networks on your PC, as shown here.

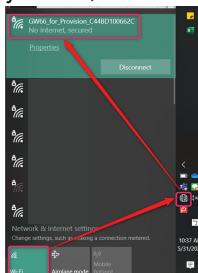

3. Click on the network named 'GW66_for_Provision'.
4. Enter the default password (**FLIRPROV**) when prompted (change the password per Section 11.11).
5. If the connection is successful, the 2.4 GHZ LED on the GW66 will blink.

- Right click on the Microsoft Edge browser (or other browser) to open a **New InPrivate window**, as shown here.

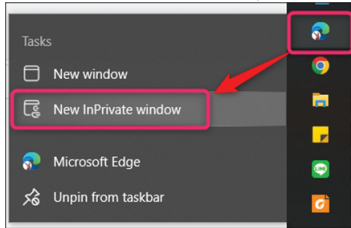

- Type **192.168.2.1** in the address bar, as shown here.
- Type the default password (**admin**) when prompted. Change the password per Section 11.11.

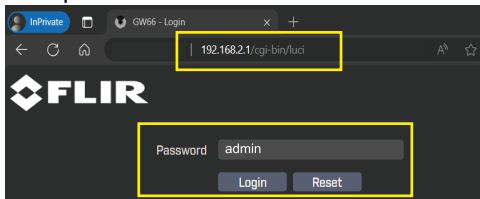

- When you successfully connect with the GW66 Wi-Fi network and access the user interface, the Dashboard screen, shown below, in Figure 11.1.

11.2 Dashboard Page

The Dashboard is the first page that appears in the interface. Here you can select other pages and view connected sensor data. Refer to Figure 11.1, below for details.

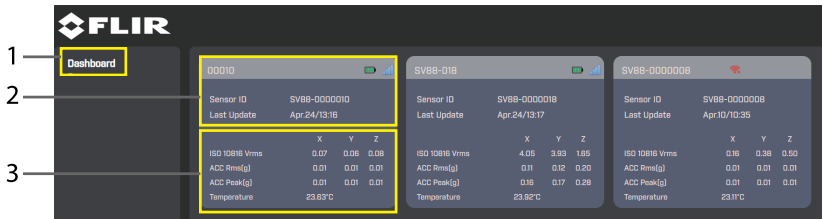

Figure 11.1 The main Dashboard for the web-based user interface, built-in to the GW66.

1. The Dashboard, and other pages, are selected on the left side of the page.
2. View the sensor name and ID, last sensor update, battery status, and communication status (a red icon, as shown in the right most sensor block, indicates that communication is lost).
3. View measurement data.

11.3 Sensor LIST Page

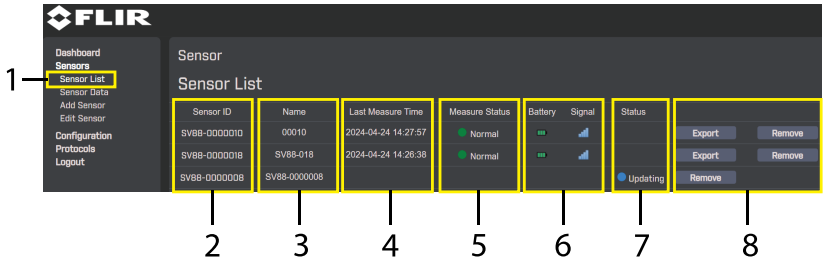

Figure 11.2 Sensor LIST page.

1. Select Sensor > Sensor List to open this page.
2. Sensors currently connected.
3. Sensor names.
4. Most recent measurement date and time.
5. Sensor alarm status. Green is normal, Red is a high (danger) alarm, Yellow is a moderate alarm.
6. Sensor battery status and communication status.
7. Sensor update status. In this example, one sensor is actively updating.
8. Click REMOVE to clear a sensor from the list. Click EXPORT to Open or Save the sensor's data, a prompt will appear.

11.4 Sensor DATA Page

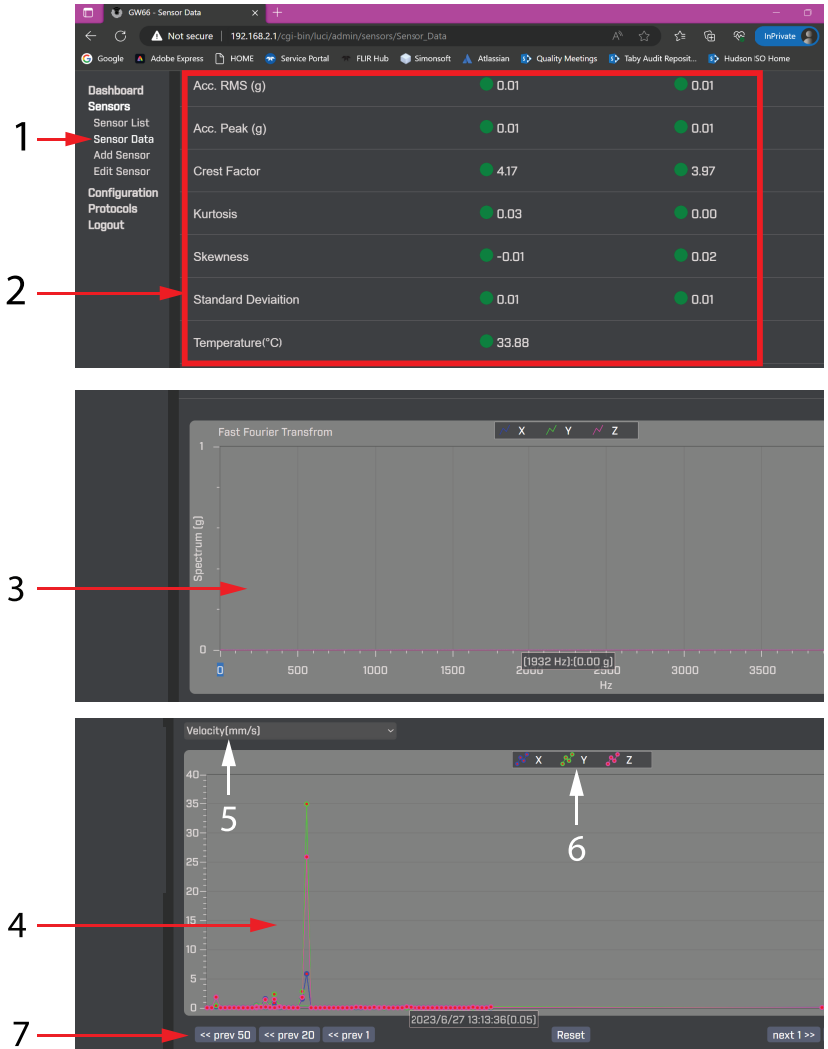

Figure 11.3 Sensor DATA page.

1. Click Sensor > Sensor Data to open this page.
2. View sensor readings. Each column represents one sensor's reading and alarm status.
3. The FFT graph (see Section 13 for details).
4. Graphical representation of readings separated by axis (x,y,z).
5. Select the measurement type to display.
6. Select the axis to view.
7. Move to the previous or next readings on the graph, and reset the graph.

11.5 Sensor ADD Page

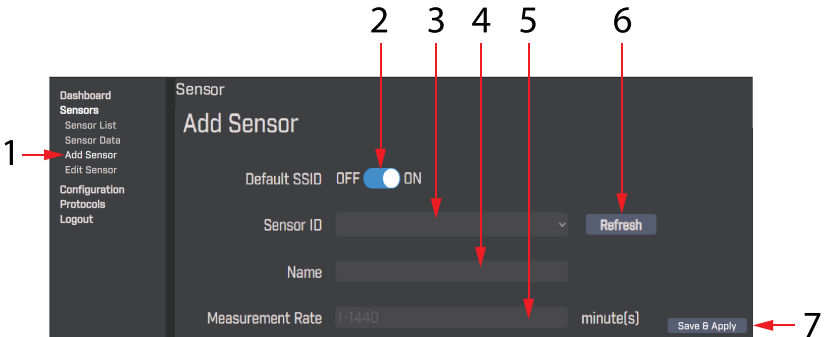

Figure 11.4 Sensor ADD page.

1. Click Sensor > Add Sensor to open this page and add a sensor to the system (only one sensor can be added at a time). See Sections 8.2 and 8.3 for additional information on adding sensors. A sensor that is powered, and not already in the system (and that has not been paired with any GW66 previously) will appear on this page. If you have a sensor that has been paired with a GW66 previously, it will need to be reset before it can be added to the current GW66, see Section 8.6 for Reset instructions.
2. Set **SSID** ON or OFF.
3. The sensor ID (serial number) will appear here.
4. The sensor name will appear here.
5. Set the rate at which this sensor will record a reading, from 1 to 1440 minutes (24 hours).
6. Refresh the page to search for a sensor again.
7. Click **Save & Apply** when the sensor has been successfully recognized and configured.

11.6 Sensor EDIT Page

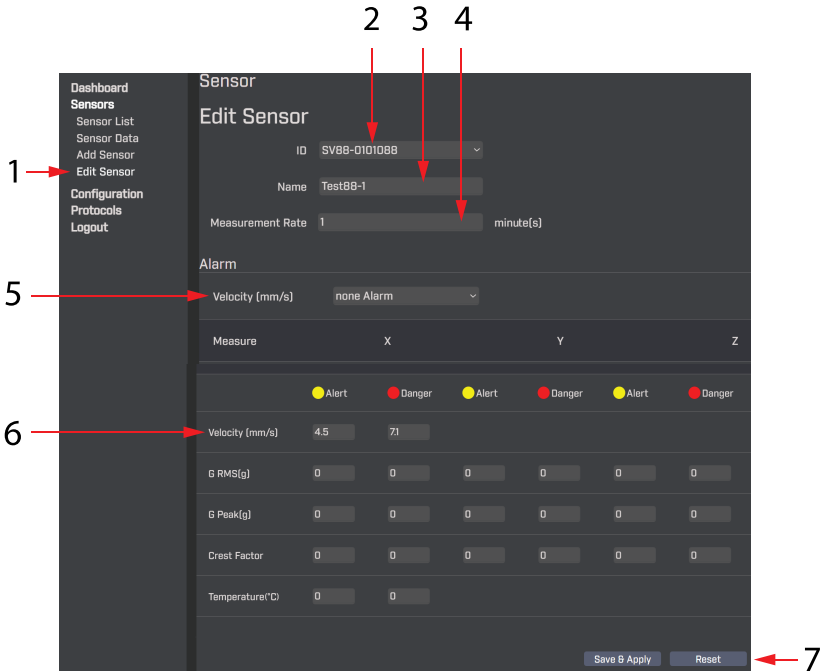

Figure 11.5 Sensor EDIT page.

1. Click Sensor > Edit Sensor to open this page.
2. Select the sensor to edit from the drop-down menu.
3. Rename the sensor, if desired.
4. Change the sensor's measurement rate.
5. Set the main measurement type that you want the alarm to track.
6. Set the value for each measurement type that will trigger an Alert (yellow) alarm or a Danger (red) alarm. These color alarms will appear next to the displayed measurement readings.
7. Click **Save & Apply** to save your settings or click **Reset** to abort.

11.7 Configuration OVERVIEW Page

The screenshot shows the FLIR Configuration Overview page. The interface is dark-themed with a sidebar on the left and a main content area on the right. The sidebar contains a menu with items: Dashboard, Sensors, Configuration (highlighted), Overview, Setup, Protocols, and Logout. The main content area is divided into three sections: System, Network, and Associated Wi-Fi Clients. The System section displays various system parameters. The Network section shows details for two radio interfaces. The Associated Wi-Fi Clients section lists connected devices with their network names, hostnames, and signal/noise levels. A 'Refresh' button is located in the top right corner, and a 'Disconnect' button is located in the bottom right corner of the Associated Wi-Fi Clients section.

System

Model	GW66
Architecture	ARMv7 Processor rev 5 (v7l)
Firmware Version	v1.0.94
Kernel Version	5.4.178
Local Time	2023-06-27 23:53:01
Uptime	2h 38m 57s
Load Average	0.01, 0.05, 0.05
Ethernet Address	
Wireless Address	

Network

radio0 - ②	radio1																
Type: Qualcomm Atheros IPQ4019 802.11bgn	Type: Qualcomm Atheros IPQ4019 802.11nac																
Channel: 1 (2.412 GHz)	Channel: 0 (0.000 GHz)																
Bitrate: 144 Mbit/s	Bitrate: -																
<table border="1"> <tr> <td>SSID: GW66_for_Sense</td> <td>SSID: GW66_for_Prov</td> </tr> <tr> <td>Mode: Master</td> <td>Mode: Master</td> </tr> <tr> <td>BSSID: C4:4B:01:00:AA:AA</td> <td>BSSID: C2:4B:01:00:AA:AA</td> </tr> <tr> <td>Encryption: mixed WPA</td> <td>Encryption: mixed WPA</td> </tr> <tr> <td>Associations: -</td> <td>Associations: 1</td> </tr> </table>	SSID: GW66_for_Sense	SSID: GW66_for_Prov	Mode: Master	Mode: Master	BSSID: C4:4B:01:00:AA:AA	BSSID: C2:4B:01:00:AA:AA	Encryption: mixed WPA	Encryption: mixed WPA	Associations: -	Associations: 1	<table border="1"> <tr> <td>SSID: Teledyna-Guest</td> </tr> <tr> <td>Mode: Client</td> </tr> <tr> <td>BSSID: C4:4B:01:00:AA:0B</td> </tr> <tr> <td>IPv4:</td> </tr> <tr> <td>Encryption: -</td> </tr> <tr> <td>Associations: -</td> </tr> </table>	SSID: Teledyna-Guest	Mode: Client	BSSID: C4:4B:01:00:AA:0B	IPv4:	Encryption: -	Associations: -
SSID: GW66_for_Sense	SSID: GW66_for_Prov																
Mode: Master	Mode: Master																
BSSID: C4:4B:01:00:AA:AA	BSSID: C2:4B:01:00:AA:AA																
Encryption: mixed WPA	Encryption: mixed WPA																
Associations: -	Associations: 1																
SSID: Teledyna-Guest																	
Mode: Client																	
BSSID: C4:4B:01:00:AA:0B																	
IPv4:																	
Encryption: -																	
Associations: -																	

Associated Wi-Fi Clients

Network	Host	Signal / Noise	RX Rate / TX Rate	
GW66_for_Prov	GW66.lan (192.168.2.1, fe80:a01c:433f:846f:916b)	-38/-102 dBm	144.4 Mbit/s, 20 MHz, MCS 15, Short GI 144.4 Mbit/s, 20 MHz, MCS 15, Short GI	Disconnect

Figure 11.6 Configuration Overview page.

1. Click Configuration > Overview to open this page.
2. View system settings.
3. View Network settings.
4. View Wi-Fi data, signal-to-noise ratio, and transmit/receive rates.
5. Click to refresh the page.
6. Click to disconnect from the network.

11.8 Configuration Setup (General) Page

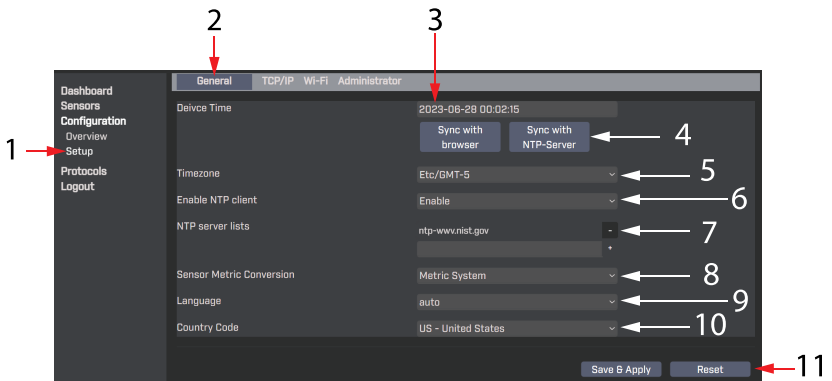

Figure 11.7 Configuration Setup — GENERAL page.

1. Click Configuration > Setup to open this page.
2. Click the **General** tab.
3. View the device date/time.
4. Click to sync the clock with the browser or the server.
5. Pick your time zone from the menu.
6. Enable or Disable the NTP (network time protocol) client.
7. Select the NTP server list.
8. Choose to show measurements in metric or imperial units.
9. Select the desired language to show in the user interface.
10. Select your country code.
11. Click **Save & Apply** to save your changes or click **Reset** to abort.

11.9 Configuration Setup (TCP/IP) Page

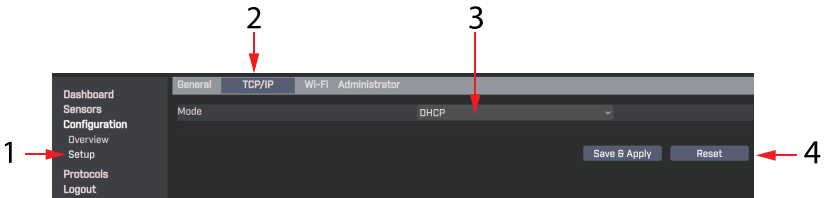

Figure 11.8 Configuration Setup (TCP/IP) page.

1. Click Configuration > Setup to open this page.
2. Click **TCP/IP**.
3. Select **DHCP** (dynamic host configuration protocol).
4. Click **Save & Apply** to save your changes or click **Reset** to abort.

11.10 Configuration Setup (Wi-Fi) Page

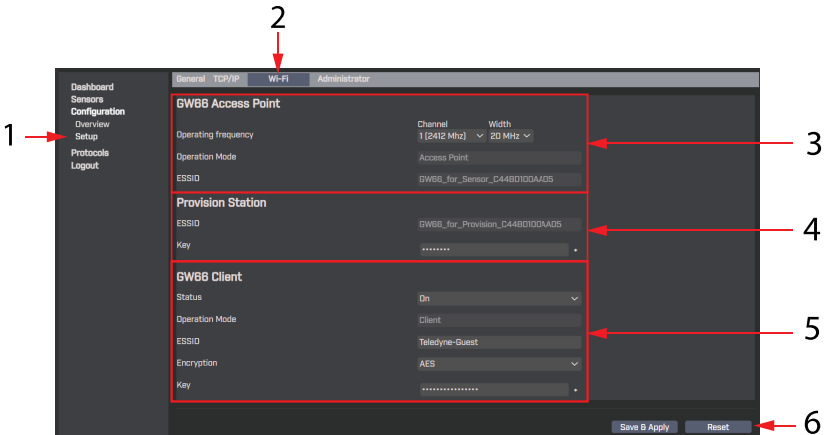

Figure 11.9 Configuration Setup (Wi-Fi) page.

1. Click Configuration > Setup to open this page.
2. Click the **Wi-Fi** tab.
3. Review or edit GW66 data.
4. Review or edit ESSID data.
5. Review or edit the GW66 Client data.
6. Click **Save & Apply** to save your changes or click **Reset** to abort.

11.11 Configuration Setup (ADMIN) Page

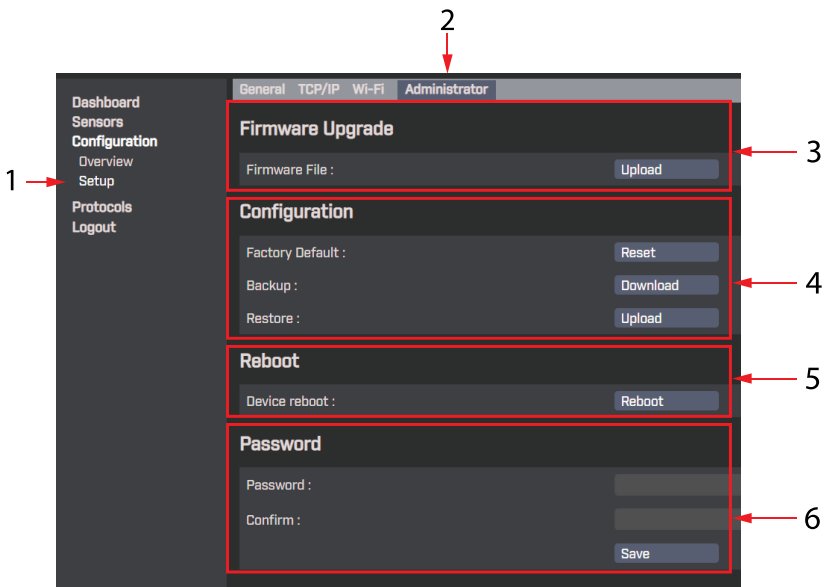

Figure 11.10 Configuration Setup (Administration) page.

1. Click Configuration > Setup to open this page.
2. Click the **Administrator** tab.
3. Upload a firmware update file to upgrade the GW66.
4. Download a data backup file or upload a previously saved data backup file.
5. Reboot the system.
6. Set a new password, confirm it, and click **Save**.

11.12 Modbus TCP Host Utility

Basic setting information is supplied below, but complete instructions for using this host are available as a separate application note. Download a copy of the application note from the FLIR support site.

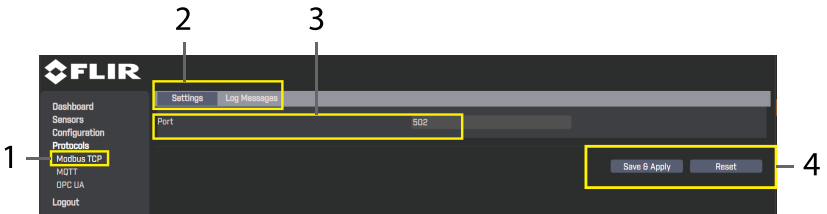

Figure 11.11 Modbus TCP Host Settings.

1. Click Protocol > Modbus TCP to open this page.
2. Click **Settings** (click **Log Messages** to view the automated message log).
3. Set the port number.
4. Click **Save & Apply** to save your changes or click **Reset** to abort.

11.13 MQTT Host Utility

Basic setting information is supplied below, but complete instructions for using this host are available as a separate application note. Download a copy of the application note from the FLIR support site.

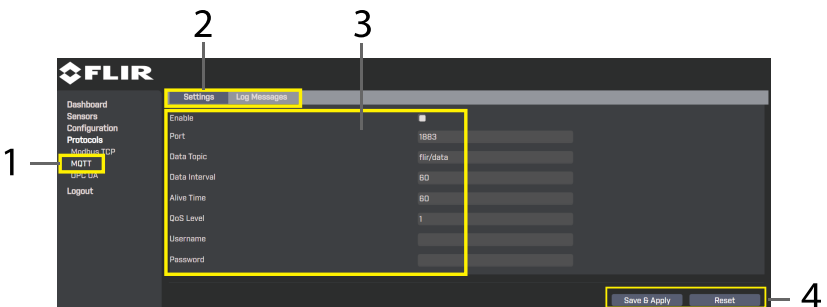

Figure 11.12 MQTT Host Settings.

1. Click Protocol > MQTT to open this page.
2. Click **Settings** (click **Log Messages** to view the automated message log).
3. View or edit the MQTT industry host settings.

4. Click **Save & Apply** to save your changes or click **Reset** to abort.

11.14 OPC UA Host Utility

Basic setting information is supplied below, but complete instructions for using this host are available as a separate application note. Download a copy of the application note from the FLIR support site

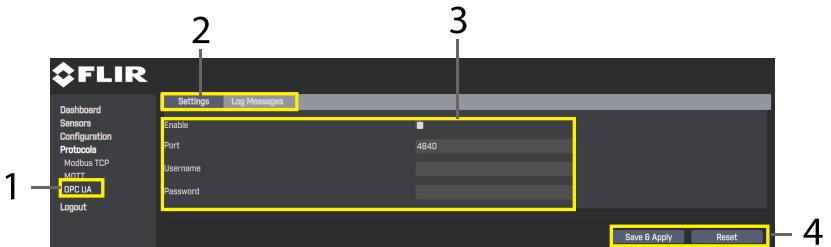

Figure 11.13 OPC UA Host Settings.

1. Click Protocol > OPC UA to open this page.
2. Click **Settings** (click **Log Messages** to view the automated message log).
3. Set the port number and host username and password. Check the Enable box to enable the utility.
4. Click **Save & Apply** to save your changes or click **Reset** to abort.

12 Mapping a Test Site

To best maintain a test site, it is important to keep a list of machinery under test, including their types, classifications, and locations. Depending on the size of the operation, a site map may also be needed to show machine locations and the test points where sensors are attached.

Sensor serial numbers are printed on the outside and inside of sensor housings. The web-server user interface displays the serial number of sensors. Names of sensors can be customized as explained in Section 11.6.

13 Fast Fourier Transform (FFT)

13.1 Background

In simple terms, FFT is a mathematical algorithm that converts a data presentation (graph, for example), shown as a function of time, into a data presentation shown as a function of frequency and vice versa.

This is useful in the representation of vibration measurements. For example, Velocity graphs, in this system are derived from FFT analysis of Acceleration measurements.

See section 11.4 for the location of the FFT graph in the GW66 web-server user interface.

13.2 Time-Domain and Frequency-Domain Methods

Time and frequency domain vibration measurement methods can both be employed to study vibration measurements.

The time domain method provides a glimpse into the source of vibration but not ideal for analyzing multiple frequency vibration signals.

The frequency domain method is more effective; especially when evaluating amplitude and phase characteristics of vibration signals. The frequency domain method is effective finding bearing defects and identifying shock pulses and friction activity.

13.3 Determining Machine Defects by Vibration Characteristics

Each defect causes vibrations having unique characteristics. You can determine, more easily, the root cause of a problem if you understand these characteristics, and that's where FFT comes in handy.

You can determine a lot about an asset, even when it is working normally, by looking at FFT data graphs. For example, in normal operation, the shaft rotation frequency (fundamental) will be represented on the graph on the left followed by a series of harmonics whose amplitude will be approximately a third the amplitude of the fundamental.

Additional signals are present in a normal system representing the vibrations of the structure that the machine is mounted on.

For faulty systems, the following changes in FFT graphs may appear.

- Shaft balance issues cause large radial variations and marked increase in amplitude of the fundamental frequency.
- Misalignments are shown as an increase in frequency amplitude at the 2nd harmonic.
- Looseness is evidenced by a marked increase in the number of harmonics. If there is looseness in the main support of the asset, an increase in the fundamental frequency amplitude will also be noticed.

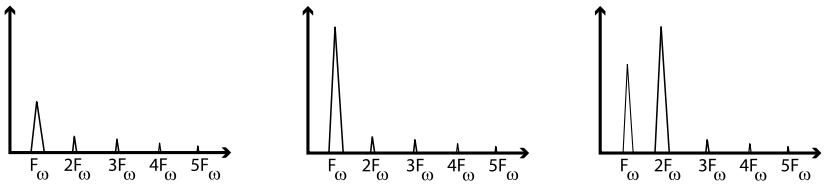

Figure 13.1 Graph on left shows a normal system; Centre graph shows a balance issue; Graph on right shows a misalignment issue.

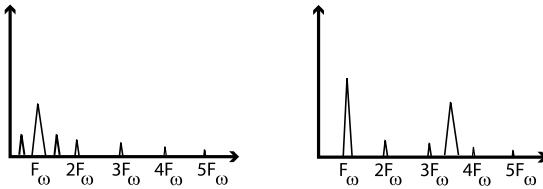

Figure 13.2 Graph on left shows a loose equipment issue (additional frequencies near the fundamental); Graph on right shows an impulse vibration (between 3rd and 4th harmonic) . Frequency of the impulse will vary from machine to machine (speed, size, etc.).

14 Specifications

14.1 GW66 Specifications

System	
Memory	DDR 512 MB
Storage	32 MB NOR Flash
Clock	On chip RTC with super capacitor backup, with RTC/WDT
LED Indicators	WAN, LAN, 2.4GHz, 5GHz, Power/Status
Wi-Fi	2.4GHz and 5GHz dual band
Software	
Operating System	Built-in web-server (Linux)
Communication Protocol	MQTT, Modbus TCP, and OPC UA
Vibration analysis	G rms & Peak V rms (ISO10816) Crest factor FFT Kurtosis, Skewness, Standard deviation
Input/Output	
Ethernet	1 x 10/100/1000 Base-TX MDI/MDIX for LAN 1 x 10/100/1000 Base-TX MDI/MDIX for WAN
Power Supply	
Power connector	Terminal block
PoE (Power over Ethernet)	802.3 at standard PoE (PD) @ WAN port (LAN 1 port only)
Power input	12 V DC (1.0 A, minimum) using optional AC adaptor (100 to 240 V AC 50/60 Hz)
Environmental and Mechanical	
Dimensions	6.3 x 4.6 x 1.2 in. (16 x 11.8 x 3.1 cm)
Weight	1.42 lbs. (645 g)
Mounting	Wall mount or DIN-rail mount GW66 should not be mounted at a height > 6.6 ft. (2 m)
Operating Temperature	-40 to 167°F (-40 to 75°C) Altitude: 9842 ft. (3000 m) max.

Storage Temperature	-40 to 185°F (-40 to 85°C)
Operating Humidity	10% to 95% relative humidity, non-condensing
Certifications	EU (CE & UKCA) FCC (US), IC (Canada) RCM (AUS & NZ)

14.2 Sensor Specifications

	SV88	SV89
System		
Axis	Three axis (x,y,z)	Single axis (x)
Acceleration	±16 g	±50 g
Linear frequency response range	10 Hz to 5 kHz (3 dB point)	10 Hz to 10 kHz (3 dB point)
Temperature sensor	Internal thermistor	
Sampling (measurement) rate	1 to 1440 minutes (24 hours) programmable	
Radio Frequency		
Wi-Fi	2.4 GHz, 11b/g/n	
Distance	164 ft. (50 m)	
Power Supply		
Battery	SAFT LS17500 3.6V 3600 mAh lithium-ion battery (not rechargeable)	
Software		
Firmware upgrade	Available in the field (see Section 15)	
Environmental and Mechanical		
Dimensions	2.6 x 2.6 x 2.2 in. (6.5 x 6.5 x 5.5 cm)	
Weight	6.6 oz. (187 g)	
IP rating	IP66	
Mounting	Bolt/screw (1/4" x 28 UNF) or optional magnetic base mount (FLIR TA88) Sensors should not be mounted at a height > 6.6 ft. (2 m)	
Operating temperature	-4 to 176°F (-20 to 80°C)	

Storage temperature	-4 to 176°F (-20 to 80°C)
Operating humidity	10% to 95% relative humidity, non-condensing
Certifications	EU (CE & UKCA) FCC (US), IC (Canada) RCM (AUS & NZ)
Warranty	Three-Year Limited Warranty

15 Firmware Upgrades

15.1 Overview

The system firmware can be updated in the field by the user. The firmware update files are available on the FLIR support website. Follow the steps in the procedure below to perform the update, contact FLIR support if you need assistance.

15.2 Firmware Update Procedure

1. Go to the FLIR support site (<https://support.flir.com>) and download the firmware file from the Downloads area.
2. Refer to the accompanying image, and follow this menu sequence: Configuration > Setup > Administrator > Firmware Upgrade.

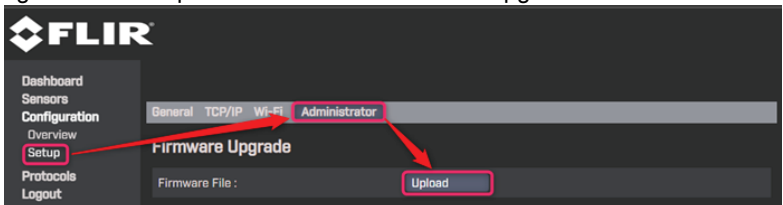

3. Click the UPLOAD box in the Administrator window, and then browse to the file that you downloaded from the support site.

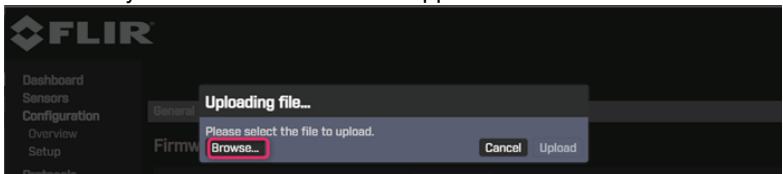

4. When prompted, deselect the box that states 'Keep settings and retain the current configuration'. This will ensure no conflicts are created by the new firmware, and then click CONTINUE.

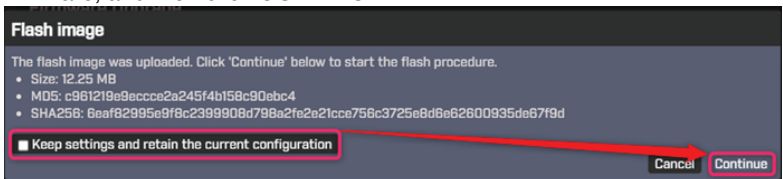

5. The GW66 will automatically reboot after you click CONTINUE.

6. Reconnect the GW66 through Wi-Fi (2.4 GHz) to complete the process.

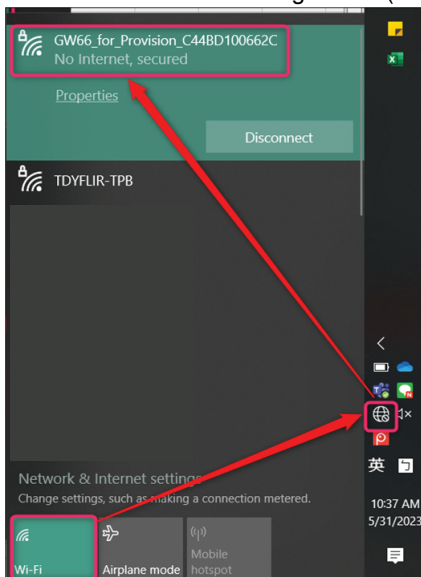

16 Customer Support

Customer Support Telephone List	https://support.flir.com/contact
Repair, Calibration, and Technical Support	https://support.flir.com

17 Limited 3–Year Warranty

This product is protected by FLIR's Limited 3-Year Warranty. Visit www.flir.com/testwarranty to read the warranty document.



Website

<http://www.flir.com>

Customer support

<http://support.flir.com>

Copyright

© 2024, FLIR Systems, Inc. All rights reserved worldwide.

Disclaimer

Specifications subject to change without further notice. Models and accessories subject to regional market considerations. License procedures may apply. Products described herein may be subject to US Export Regulations. Please refer to exportquestions@flir.com with any questions.

Publ. No.: NAS100162
Release: AG
Commit: 98094
Head: 98104
Language: en-US
Modified: 2024-05-24
Formatted: 2024-05-24

