

FLX-8X8A Installation and Operation Guide



Important Safety Instructions

- **Please completely read and verify you understand all instructions in this manual before operating this equipment.**
- Keep these instructions in a safe, accessible place for future reference.
- Heed all warnings.
- Follow all instructions.
- Do not use this apparatus near water.
- Clean only with a dry cloth.
- Do not install near any heat sources such as radiators, heat registers, stoves, or other apparatus (including amplifiers) that produce heat.
- Use only accessories specified or recommended by Intelix.
- Explanation of graphical symbols:
 - Lightning bolt/flash symbol: the lightning bolt/flash and arrowhead within an equilateral triangle symbol is intended to alert the user to the presence of uninsulated “dangerous voltage” within the product enclosure which may be of sufficient magnitude to constitute a risk of shock to a person or persons.
 - Exclamation point symbol: the exclamation point within an equilateral triangle symbol is intended to alert the user to the presence of important operating and maintenance (servicing) instructions in the literature accompanying the product.
- **WARNING: TO REDUCE THE RISK OF FIRE OR ELECTRIC SHOCK, DO NOT EXPOSE THIS APPARATUS TO RAIN OR MOISTURE AND OBJECTS FILLED WITH LIQUIDS, SUCH AS VASES, SHOULD NOT BE PLACED ON THIS APPARATUS.**
- Use the mains plug to disconnect the apparatus from the mains.
- **THE MAINS PLUG OF THE POWER CORD MUST REMAIN READILY ACCESSIBLE.**
- Do not defeat the safety purpose polarized or grounding-type plug. A polarized plug has two blades with one wider than the other. A grounding-type plug has two blades and a third grounding prong. The wide blade or the third prong is provided for your safety. If the provided plug does not fit into your outlet, consult an electrician for replacement of your obsolete outlet. **Caution! To reduce the risk of electrical shock, grounding of the center pin of this plug must be maintained.**
- Protect the power cord from being walked on or pinched particularly at the plugs, convenience receptacles, and the point where they exit from the apparatus.
- Do not block the air ventilation openings. Only mount the equipment per Intelix’s instructions.
- Use only with the cart, stand, table, or rack specified by Intelix or sold with the equipment. When/if a cart is used, use caution when moving the cart/equipment combination to avoid injury from tip-over.
- Unplug this apparatus during lightning storms or when unused for long periods of time.
- **Caution! Shock Hazard.** Do not open the unit.
- Refer to qualified service personnel. Servicing is required when the apparatus has been damaged in any way, such as power-supply cord or plug is damaged, liquid has been spilled or objects have fallen into the apparatus, the apparatus has been exposed to rain or moisture, does not operate normally, or has been dropped.

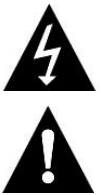

Table of Contents

Important Safety Instructions	2
Overview	5
Package Contents.....	5
Front Panel.....	6
Rear Panel	7
IR Remote.....	7
Input Cards.....	8
Analog Video (FLX-RI4).....	8
DVI (FLX-DI4)	8
HDBaseT (FLX-BI4).....	8
HDMI (FLX-HI4)	9
Output Cards.....	10
DVI (FLX-DO4)	10
HDBaseT (FLX-BO4).....	10
HDMI (FLX-HO4).....	10
Installation Instructions	11
Shelf Mounting Instructions	11
Rack Mounting Instructions.....	11
General I/O Card Installation	11
FLX-BI4 and FLX-BO4 Wiring	12
FLX-RI4 Wiring.....	13
Analog Audio Wiring	14
EDID Management.....	15
Copy EDID.....	15
Front Panel and IR Remote Operation.....	16
Basic Routing.....	16
Advanced Routing.....	16
IR Remote Operation	16
Third Party Control Setup	17
IP Address Setup via Web Browser	17
Access the Web Browser with Defined IP Address.....	19
Additional Options in Web Browser	19
RS232 Connection	19

RS232 and TCP/IP Commands..... 20

 Video and Audio Routing Commands 20

 Video Only Routing Commands 20

 Audio Only Routing Commands 21

 System Commands..... 21

 EDID Commands 21

 Preset Commands..... 22

 FLX-RI4 Specific Commands 22

Troubleshooting..... 23

 Matrix does not power on 23

 Cannot view 3D content 23

 Cannot hear surround sound audio 23

Technical Specifications 24

 FLX-8X8A Chassis..... 24

 FLX-BI4 25

 FLX-HI4 26

 FLX-RI4 27

 FLX-DI4 28

 FLX-BO4..... 29

 FLX-HO4 30

 FLX-DO4 31

 DIGIB-EMT..... 32

 DIGIB-EMT..... 32

Overview

The Intelix FLX-8X8A is a modular eight input by eight output video matrix switcher with a built-in eight input by eight output stereo audio matrix switcher. Each modular input or output card supports up to four device connections. In addition to front panel control, the FLX-8X8A can be controlled via IR, RS232, or TCP/IP connections.

The modular input cards include the following connections: HDMI, DVI, HDBaseT (with RS232 and bi-directional wide-band IR), and analog video with digital scaling via HD15 (VGA-UXGA, RGBHV, RGsB, RsGsBs, component video, S-video and composite video). The modular output cards include the following connections: HDMI, DVI, and HDBaseT.

The analog stereo audio inputs and outputs on the FLX-8X8A can connect to balanced or unbalanced audio devices. In addition to audio following video, the audio and video signals can be switched independently.

Clear button caps provide legible text on the front panel, which can be customized for each installation. IR, RS232, and TCP/IP provide a wide range of options for third party control systems. Ten programmable presets provide an efficient means of configuring the video and audio distribution for common usage patterns.

The FLX-8X8A was designed with flexibility in mind. There are over 80 possible input card to output card combinations. Since the system is modular, the system integrator can customize their installation per their customer's needs and not the limitations of available hardware.

Package Contents

Please verify the following items are in the shipping box prior to installation of the FLX-8X8A.

- 1 ea FLX-8X8A Flexible Matrix Switcher
- 2 ea Modular Input Metal Blank (installed on FLX-8X8A)
- 2 ea Modular Output Metal Blank (installed on FLX-8X8A)
- 4 ea Rubber Feet
- 1 ea Power Cable
- 1 ea RS232 Cable
- 1 ea Infrared Remote Control
- 1 ea FLX-8X8A Installation and Operation Guide
- 1 ea Intelix Pocket Screwdriver

Front Panel

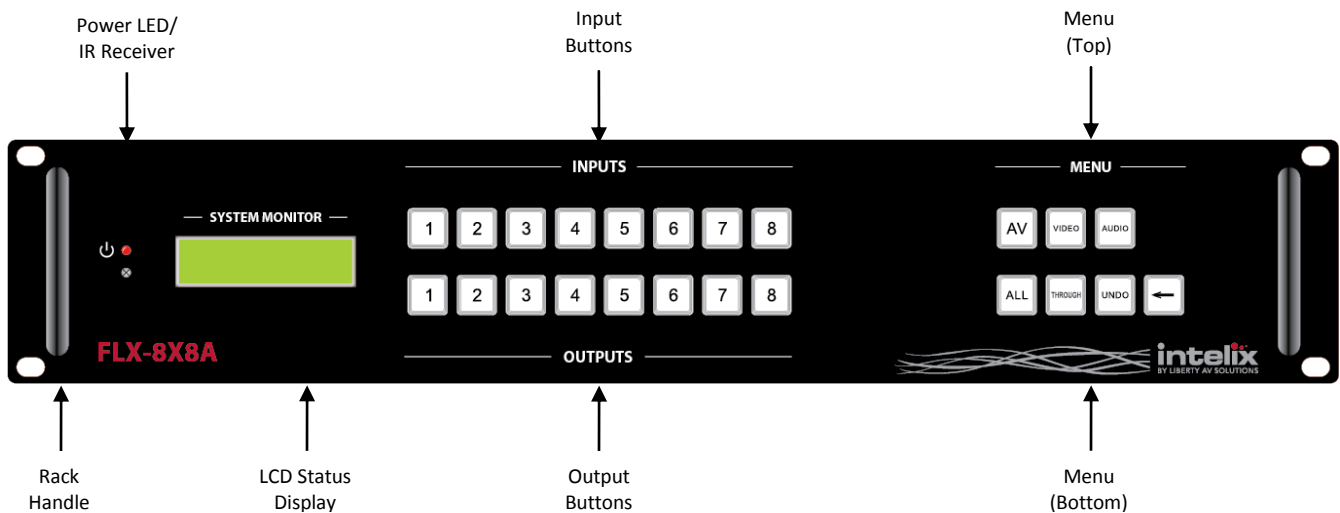

Power LED – Indicates the matrix has proper input power.

IR Receiver – For use with the included IR remote.

Input Buttons –Buttons labeled “1” through “8”.

Menu Buttons (Top Row) –Buttons labeled “AV”, “VIDEO”, and “AUDIO”.

AV – Used to route Video and Audio inputs to outputs

VIDEO – Used to route Video inputs to outputs

AUDIO – Used to route Audio inputs to outputs

Rack Handle – Eases installation in an equipment rack.

LCD Status Display – Displays matrix name and status when changing video and/or audio routes.

Output Buttons –Buttons labeled “1” through “8”.

Menu Buttons (Bottom Row) –Buttons labeled “ALL”, “THROUGH”, “UNDO”, and “←”.

ALL – Used to route one input AV pair to all outputs or to route each AV input to its corresponding output.

THROUGH – Used to route the selected AV input to its corresponding output.

UNDO – Used to remove the last button press in a routing sequence

← – Used to clear the input source select.

Explanation of use for the front panel control is located in the section *Front Panel Operation* (page 14).

Rear Panel

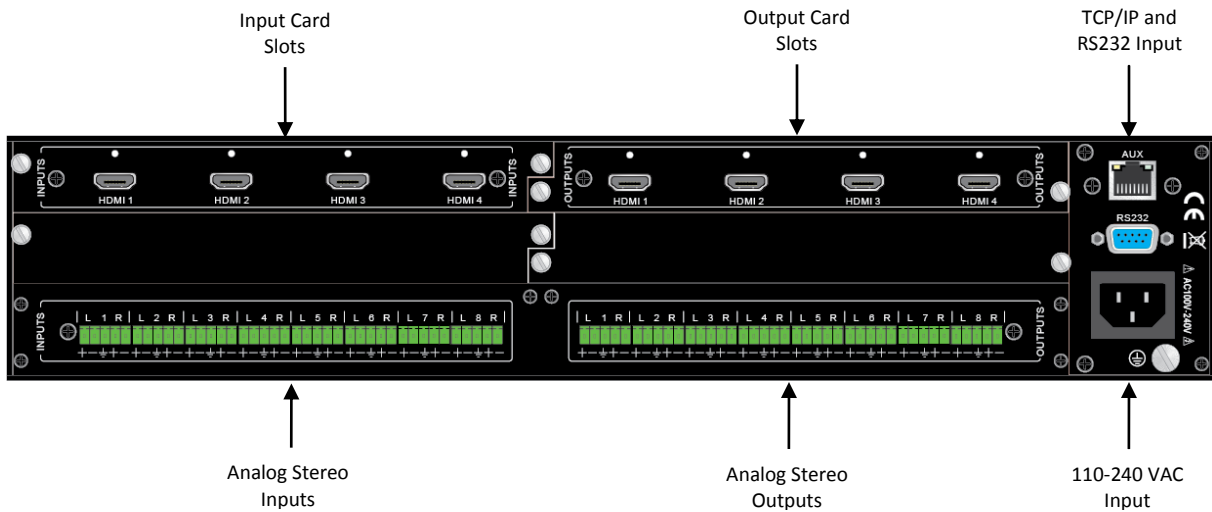

Input Card Slots – Two card slots to accommodate compatible input cards.

Output Card Slots – Two card slots to accommodate compatible output cards.

TCP/IP Input – Allows control via third party control system and web browser access.

RS232 Input – Allows control via third party control system.

Analog Stereo Inputs – Eight balanced analog stereo inputs.

Analog Stereo Outputs – Eight balanced analog stereo outputs.

AC Input – Standard IEC C14 inlet.

IR Remote

The included IR remote performs all of the functions available on the front panel of the FLX-8X8A.



Input Cards

The modular input cards are keyed on the right side to line up with the output cards and ensure they are installed correctly in the matrix.

Analog Video (FLX-RI4)

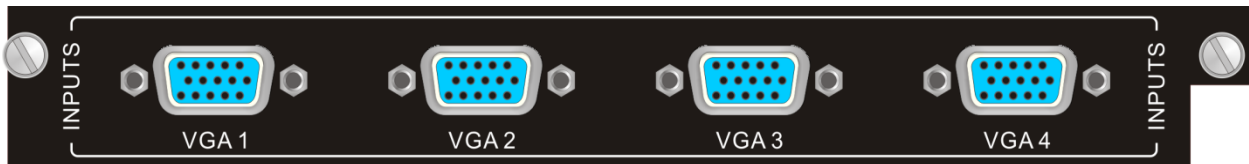

The HD15 inputs on the FLX-RI4 scale and convert a wide range of analog video signals to HD video resolutions, which can be routed to any available output. The individual scaler engine on each input can accommodate VGA to UXGA, RGBHV, RGB, RsGsBs, component video, S-video, and composite video signals. Two FLX-RBOCA (component video breakout cable) and two FLX-RBOCB (composite and S-video breakout cable) cables are included with each FLX-RI4.

DVI (FLX-DI4)

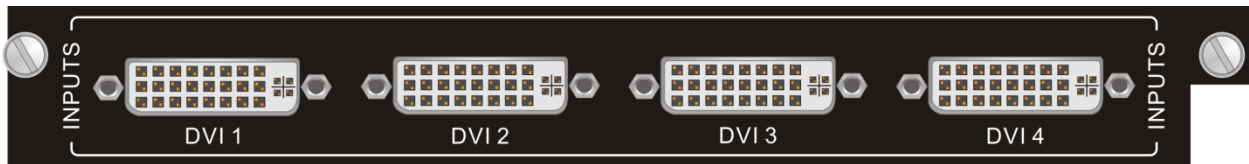

The FLX-DI4 DVI-D inputs are HDMI and HDCP compliant and support CEC and DDC standards. Each input is a single link DVI-D connection that can support video resolutions up to 1920x1200.

HDBaseT (FLX-BI4)

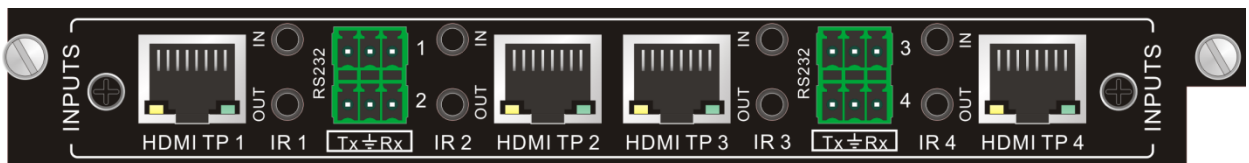

The FLX-BI4 takes advantage of HDBaseT inputs to allow sources from remote locations, from up to 70 m away, to be routed to any of the available outputs utilizing standard Cat 5e cable with a TIA-568B crimp. The RS232 and wide-band IR connections for each input allow bi-directional control signals at the equipment rack to interface with source equipment when used with the DIGI-HD70C-S or DIGI-HDE-S HDBaseT transmitters. The optional DIGIB-EMT (IR emitter) and DIGIB-EYE (IR receiver) are required for IR control functionality.

HDMI (FLX-HI4)



The FLX-HI4 HDMI inputs can be routed to any available outputs. The HDMI inputs can accept video signals up to 4k x 2k, including 3D and 48-bit Deep Color at 1080p. Additionally, audio signals from stereo up to 7.1 audio streams will pass through the matrix to supported outputs.

Output Cards

The modular output cards are keyed on the left side to line up with the input cards and ensure they are installed correctly in the matrix.

DVI (FLX-DO4)

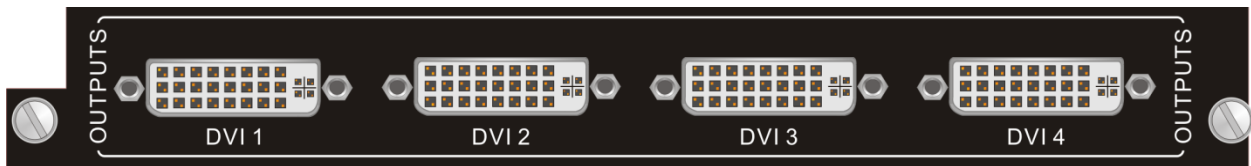

The FLX-DO4 DVI-D outputs are HDMI and HDCP compliant and support CEC and DDC standards. Each output is a single link DVI-D connection that can support video resolutions up to 1920x1200.

HDBaseT (FLX-BO4)

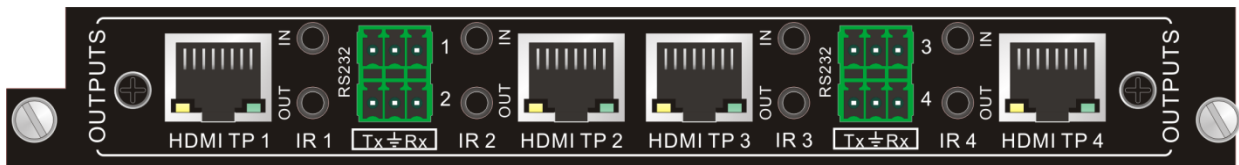

The FLX-BO4 takes advantage of HDBaseT outputs connect any source device to a remote display, up to 70 m away, utilizing standard Cat 5e cable with a TIA-568B crimp. The RS232 and wide-band IR connections for each output allow bi-directional control signals at the equipment rack to interface with display devices when used with the DIGI-HD70C-R or DIGI-HDE-R HDBaseT receivers. The optional DIGIB-EMT (IR emitter) and DIGIB-EYE (IR receiver) are required for IR control functionality.

HDMI (FLX-HO4)



The FLX-HO4 HDMI outputs can be routed from any input in the matrix. The HDMI outputs can pass video signals up to 4k x 2k, including 3D and 48-bit Deep Color at 1080p. Additionally, audio signals from stereo up to 7.1 audio streams will pass to supported output devices.

Installation Instructions

Shelf Mounting Instructions

Attach the supplied rubber feet to the bottom of the FLX-8X8A matrix. Follow the instructions in *General I/O Card Installation* to install the I/O cards.

Rack Mounting Instructions

The FLX-8X8A requires two rack units (2 RU) of space. At least 2 inches of free air space is required on both sides of the FLX-8X8A for proper side ventilation. Avoid mounting the FLX-8X8A near a power amplifier or any other source of significant heat. It is recommended that you leave an empty rack space above and below the FLX-8X8A for additional cooling.

General I/O Card Installation

1. Power off the matrix.
2. Remove the metal blank.



3. Slide the I/O card between the guide rails until it is firmly seated.



- Secure the I/O card by tightening the thumb screws.



- Connect the appropriate cabling to the I/O card.
- Power on the matrix.

FLX-BI4 and FLX-BO4 Wiring

A compatible HDBaseT with control transmitter or receiver is required to pass the control signals to the source or display devices.

To connect the FLX-BI4 to a compatible transmitter or the FLX-BO4 to a compatible receiver, a Cat 5e or greater cable with a TIA-568B crimp termination on the RJ45 connector must be used. The Cat 5e cable must not exceed 40 meters for 3D content. The Cat 5e cable must not exceed 70 meters for 2D content.

To use the IR extension capabilities of the FLX-BI4 and FLX-BO4, the DIGIB-EYE (wideband IR receiver) and DIGIB-EMT (wideband IR emitter) will need to be connected to the appropriate IR ports. These parts are not included with the HDBaseT I/O cards.

To use the RS232 extension capabilities of the FLX-BI4 and FLX-BO4, connect the TX, ground, and RX control signal wires to the removable 3-pole terminal block. Consult the manual of the control device(s) to determine which pins the TX/RX signals are carried on. Be sure to always connect TX to RX and RX to TX.

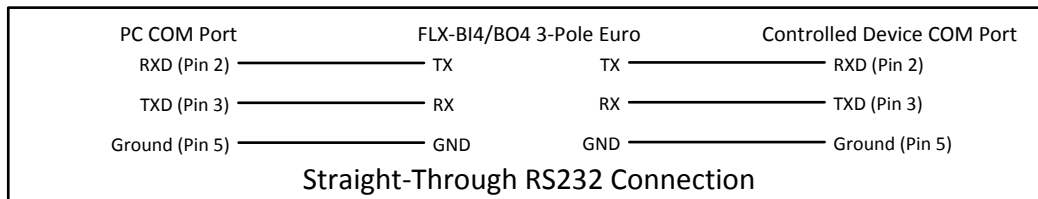

FLX-RI4 Wiring

For VGA signals, use a standard VGA male to VGA male cable.

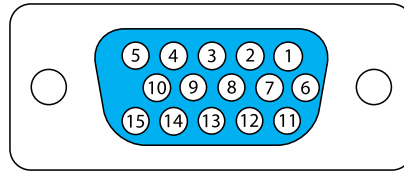

VGA PORT ON FLX-RI4

For RGBHV signals, use a standard VGA to RGBHV cable. Below is a common pinout of this type of cable.

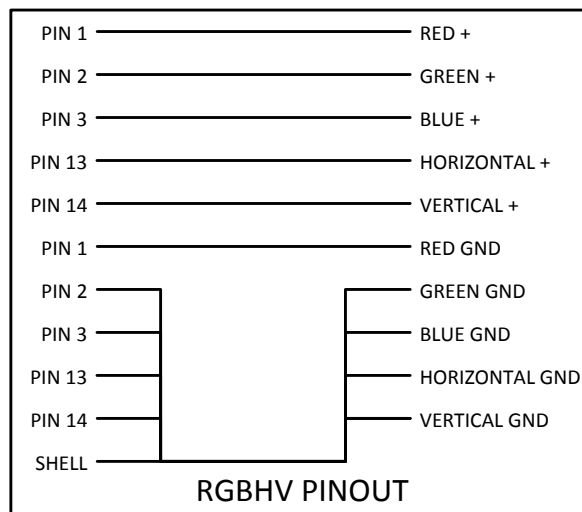

For component video, S-video, and composite video, a VGA to breakout cable is recommended. The FLX-RI4 comes with two FLX-RBOCA (component video breakout cable) and two FLX-RBOCB (composite and S-video breakout cable) cables. See *FLX-RI4 Specific Commands* on page 20 to define the operation of the inputs.

- Component video, RGsB, and RsGsBs connect to the appropriate red, green, and blue connections on the FLX-RBOCA cable.

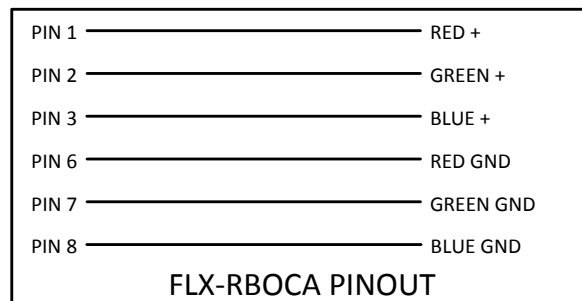

- S-video connects to the purple connector on the FLX-RBOCB cable.
- Composite video connects to the yellow connector on the FLX-RBOCB cable.

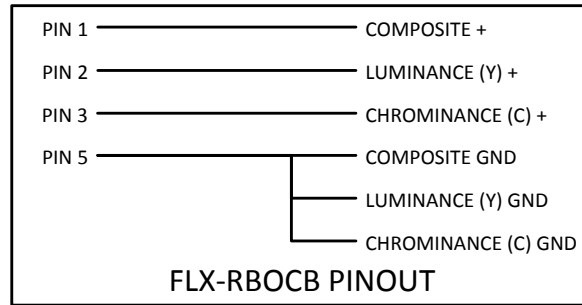

Analog Audio Wiring

The analog audio inputs and outputs support 20 Hz to 20 kHz balanced stereo audio. A signal that goes in on the left audio channel will exit on the left audio channel. The analog audio is separate from HDMI-based audio that may pass through the video portion of the matrix.

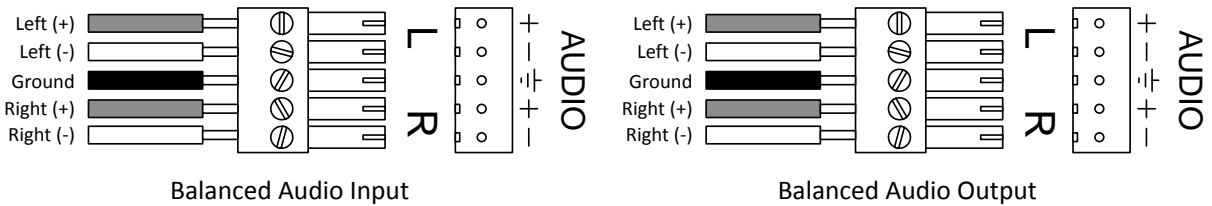

For balanced audio inputs and outputs, the ground wires will need to be connected together.

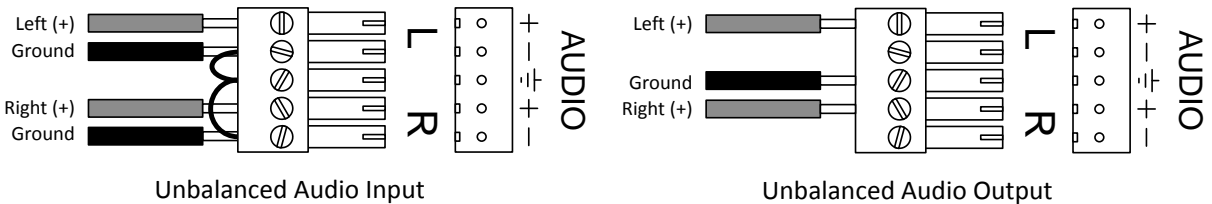

For unbalanced audio inputs, a jumper wire is required between the Ground input and the Left (-) and Right (-) inputs to limit noise from the signal. For unbalanced audio outputs, the ground wires going to the output device will need to be connected together.

EDID Management

The stock EDID for the inputs of the FLX-8X8A is 1280x1024 (computer video input) and 1080p with stereo audio (consumer video input). In order to change the EDID information for an input, the EDID copy command will need to be sent to the matrix via RS232 or TCP/IP.

EDIDM[Y]B[X].	Copy EDID of output [Y] to input [X]
EDIDMInit.	Restore factory EDID information

The FLX-RI4 input card ignores the EDID settings since there is a scaler engine on each input to output a pre-defined video resolution.

Copy EDID

To copy the EDID information from output 3 to input 1, transmit the following command:

```
EDIDM3B1.
```

Front Panel and IR Remote Operation

Basic Routing

To set a route using the front panel of the FLX-8X8A,

1. Press the appropriate AV button (AV, VIDEO, or AUDIO).
2. Press the desired input button (source).
3. Press the desired output button (display).

To route video and audio from input 4 to output 5:

1. Press AV.
2. Press input 4.
3. Press output 5.

To route video from input 2 to output 7:

1. Press VIDEO.
2. Press input 2.
3. Press output 7.

To route audio from input 6 to output 1:

1. Press AUDIO.
2. Press input 6.
3. Press output 1.

Advanced Routing

To route video and audio from input 3 to all outputs:

1. Press input 3.
2. Press ALL.

To route video and audio from each input to its corresponding output (1 to 1, 2 to 2, through 8 to 8):

1. Press ALL.
2. Press THROUGH.

IR Remote Operation

The buttons on the IR remote are identical to the buttons on the front panel of the FLX-8X8A. The IR routing commands are identical to the front panel commands.

Third Party Control Setup

IP Address Setup via Web Browser

Configuring the TCP/IP port is done via a web browser interface. A crossover cable is required for the initial setup. The default IP address is printed on a sticker on the side of the FLX-8X8A.

1. Configure the computer to use the same network prefix as the IP address assigned to the matrix. For example, the IP address of the matrix is 192.168.0.178. Set the computer to use a static IP address within the same network range, such as 192.168.0.42.
2. Connect the crossover cable to the computer and to the TCP/IP port on the FLX-8X8A.
3. Open up Internet Explorer (Firefox, Chrome, and Safari crop the configuration options).

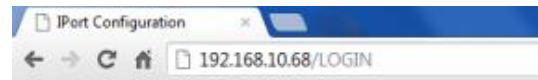
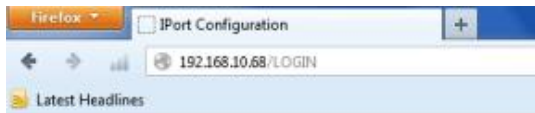

Welcome to IPort Web Server!

Welcome to IPort Web Server!

4. Go to the IP address printed on the sticker, which will take you to the Login screen.

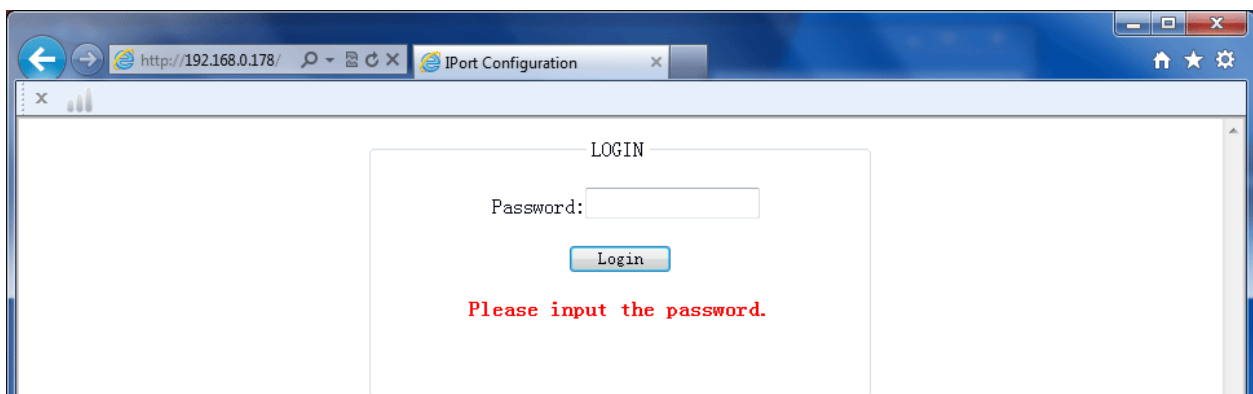

5. The Default password is “88888”.
6. Press the LOGIN button. **Pressing the Enter key will give a bad password error.**
7. Click the System Info button to change the IP address.

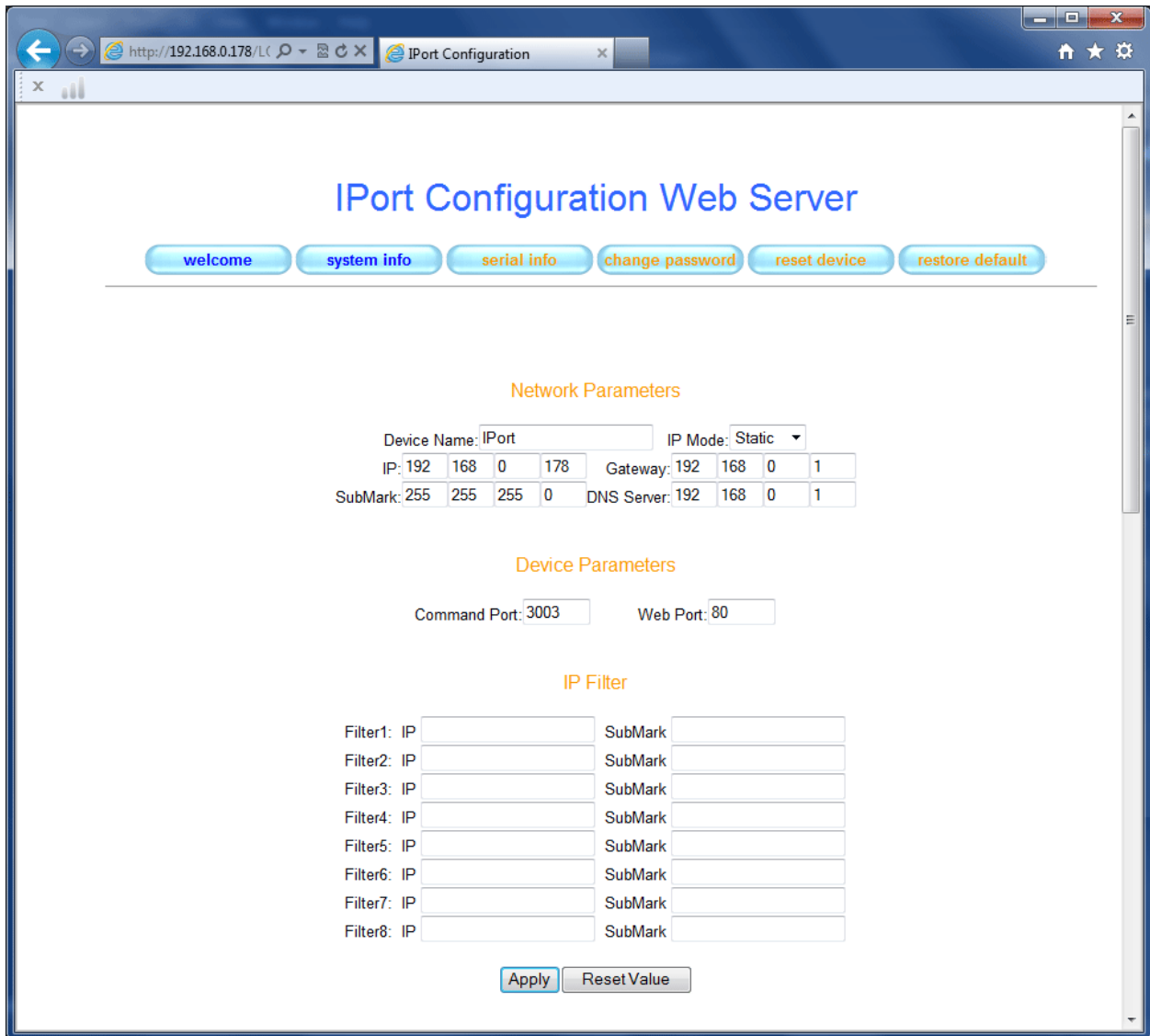

8. Changing the dropdown option from Static to DHCP will allow the FLX-8X8A to automatically obtain an IP address from a DHCP server on the network.
9. For a static IP, enter the IP address, Gateway, and DNS Server information provided by your Network Administrator.
10. Click Apply for the changes to take effect.

Access the Web Browser with Defined IP Address

1. Remove the crossover cable between the computer and the FLX-8X8A.
2. Restore the computer to the previous network settings.
3. Connect the computer and the matrix to the network.
4. Using Internet Explorer, enter the IP address for the matrix to access the browser interface.

Additional Options in Web Browser

1. Serial Info – Adjusts TCP/IP specific settings, including the default port (4001).
 - a. Changing the baud rate settings has no effect on the RS232 port of the FLX-8X8A.
 - b. The baud rate setting must remain at 9600.
2. Change Password – Changes the password of the matrix.
3. Reset Device – Resets all changes to the default settings except for the IP address of the matrix.
4. Restore Default – Resets all changes to the default settings including the IP address.

RS232 Connection

The RS232 control port requires a standard straight-through serial cable for operation. The default settings for the RS232 port are:

- 9600 baud
- 8 Data Bits
- 1 Stop Bit
- Parity = none

RS232 and TCP/IP Commands

RS232 Settings: 9600 baud, 8 Data bits, 1 Stop bit, Parity = None

TCP/IP Settings: User defined IP address, port 4001

There is either a period (.) or a semicolon (;) at the end of each command. These characters must be present for the command to process correctly.

There are no spaces between any of the characters in the command string.

Video and Audio Routing Commands

[X]All.	Route Video and Audio from input [X] to all outputs
All#.	Route Video and Audio from each input to its corresponding output
All\$.	Turn off all Video and Audio outputs
[Y]\$.	Turn off Video and Audio for output [Y]
[X]B [Y].	Route Video and Audio from input [X] to output [Y]
[X]B [Y1], [Y2].	Route Video and Audio from input [X] to outputs [Y1], [Y2] Number of outputs is unlimited; each output must be separated by a comma (,)

Examples:

2All.	Route Video and Audio from input 2 to all outputs
4\$.	Turn off Video and Audio for output 4
6B3.	Route Video and Audio from input 6 to output 3
3B2, 8.	Route Video and Audio from input 3 to outputs 2 and 8

Video Only Routing Commands

[X]V [Y].	Route Video from input [X] to output [Y]
[X]V [Y1], [Y2].	Route Video from input [X] to outputs [Y1], [Y2] Number of outputs is unlimited; each output must be separated by a comma (,)

Examples:

6V3.	Route Video from input 6 to output 3
3V2, 8.	Route Video from input 3 to outputs 2 and 8

Audio Only Routing Commands

<code>[X]A [Y].</code>	Route Audio from input <code>[X]</code> to output <code>[Y]</code>
<code>[X]A [Y1], [Y2].</code>	Route Audio from input <code>[X]</code> to outputs <code>[Y1], [Y2]</code> Number of outputs is unlimited; each output must be separated by a comma (,)

Examples:

<code>6A3.</code>	Route Audio from input 6 to output 3
<code>3A2, 8.</code>	Route Audio from input 3 to outputs 2 and 8

System Commands

<code>/*Type;</code>	Retrieve matrix model information
<code>/%Lock;</code>	Lock the front panel keys
<code>/%Unlock;</code>	Unlock the front panel keys
<code>/^Version;</code>	Retrieve matrix firmware version number
<code>/:MessageOff;</code>	Turn off matrix command feedback
<code>/:MessageOn;</code>	Turn on matrix command feedback
<code>Status [X].</code>	Input <code>[X]</code> routing status
<code>Status.</code>	Routing status of all inputs.

Example:

<code>Status8.</code>	Input 8 routing status
-----------------------	------------------------

EDID Commands

<code>EDIDM [Y]B [X].</code>	Copy EDID of output <code>[Y]</code> to input <code>[X]</code>
<code>EDIDMInit.</code>	Restore factory EDID information

Example:

<code>EDIDM5B1.</code>	Copy EDID of output 5 to input 1
------------------------	----------------------------------

Preset Commands

Save [X] .	Save the current routing as a preset. Values range from 0 through 9
Recall [X] .	Recall preset [X]
Clear [X] .	Clear preset [X]

Examples:

Save4 .	Save the current routing as preset 4.
Recall4 .	Recall preset 4
Clear4 .	Clear preset 4

FLX-RI4 Specific Commands

The input number values are dependent upon which slot the FLX-RI4 is inserted. If the input card is in the first input card slot, the input number values range from 1 through 4. If the input card is in the second input card slot, the input number values range from 5 through 8. [X] is the input number value.

PTNI [X]0622% .	Set input [X]to VGA input mode
PTNI [X]0606% .	When input [X]is in VGA mode, auto adjusts the input signal
PTNI [X]0623% .	Set input [X]to component video input mode
PTNI [X]0624% .	Set input [X]to S-video input mode
PTNI [X]0625% .	Set input [X]to composite video input mode
PTNI [X]0626% .	Set input [X]to scale to XGA output (1024x768)
PTNI [X]0627% .	Set input [X]to scale to 720p output (1280x720)
PTNI [X]0628% .	Set input [X]to scale to WXGA output (1280x800)
PTNI [X]0629% .	Set input [X]to scale to 1080p output (1920x1080)

Examples:

PTNI50622% .	Set input 5 to VGA input mode
PTNI50606% .	Auto adjust input 5 VGA source
PTNI20623% .	Set input 2 to component video input mode

Troubleshooting

Matrix does not power on

Verify power outlet is active.
Verify continuity in power cable.

Cannot view 3D content

Copy EDID from output to input.
Verify display is 3D compatible.
Verify source device can output 3D content.
Verify twisted pair cable does not exceed 40 meters if using the FLX-BI4 or FLX-BO4.

Cannot hear surround sound audio

Copy EDID from output to input.
Verify output can broadcast surround sound audio.
Verify source device is configured to output surround sound audio.

No video from HDBaseT input or output

Verify the green link LED on the HDBaseT card is lit solid.



Technical Specifications

FLX-8X8A Chassis

I/O Connections	
Supported Input Cards	FLX-BI4, FLX-DI4, FLX-HI4, FLX-RI4
Supported Output Cards	FLX-BO4, FLX-DO4, FLX-HO4
Input and Output Card Securing Mechanism	Thumb Screw
Analog Audio Input	Eight (8) 3.5 mm, 5 pole Euroblock Connectors
Analog Audio Output	Eight (8) 3.5 mm, 5 pole Euroblock Connectors
Control, Rear Panel	RS232 via DE-9, TCP/IP via RJ45
Control, Front Panel	Push Button, IR
Analog Audio	
Performance per Channel	Balanced or Unbalanced Stereo Audio (20 Hz to 20 kHz)
Pinout (Left to Right)	Left (+), Left (-), Ground, Right (+), Right (-)
Input Impedance	>10K Ω
Output Impedance	50 Ω
Frequency Response	20 Hz to 20 kHz, \pm 0.5 dB
Common Mode Rejection Ratio	>90dB at 20 Hz to 20 kHz
Crosstalk	>80 dB at 1 kHz
THD + Noise	1% at 1 kHz, 0.3% at 20 kHz
Chassis and Environmental	
Internal Power Supply Rating	110-240 VAC, 50/60 Hz at 50 W
Material	Black Painted Aluminum
Dimensions	88 mm x 444.5 mm x 320 mm (3.47 in. x 17.5 in. x 12.6 in.) (2RU)
Shipping Weight	6.26 kg (13.8 lbs.)
Operating Temperature	0° to +40° C (+32° to +104° F)
Operating Humidity	20% to 90%, Non-condensing
Storage Temperature	-10° to +60° C (+14° to +140° F)
Storage Humidity	20% to 90%, Non-condensing
Other	
Warranty	2 years
What's in the Box	FLX-8X8A (1 ea), Modular Metal Blank (4 ea), Rubber Feet (4 ea), Power Cable (1 ea), RS232 Cable (1 ea), Infrared Remote Control (1 ea), FLX-8X8A Installation and Operation Guide (1 ea), Intelix Pocket Screwdriver (1 ea)

FLX-B14

I/O Connections	
HDBaseT Port	Four (4) Shielded RJ45 Female
IR In	Four (4) 3.5 mm TS (Requires DIGIB-EYE)
IR Out	Four (4) 3.5 mm TRS (Requires DIGIB-EMT)
RS232	Four (4) 3 pole Euroblock Connectors
Supported Audio and Video	
Maximum Video Compatibility at 70 m	Deep Color 36/30/24 Bit at 1080p
Maximum Video Compatibility at 40 m	Deep Color 48 Bit at 1080p, 3D, and 4k x 2k
Video Compliance	HDMI and HDCP
Embedded Audio	Up to PCM 8 channel, Dolby Digital TrueHD, and DTS-HD Master Audio
HDBaseT Signal Characteristics	
Maximum Distance	70 m
Bandwidth	10.2 Gbps
Gain	0 dB – 10 dB at 100 MHz
Resolution Range	800x600 – 1920x1200
Signal to Noise Ratio (SNR)	> 70 dB at 100 MHz over 100 m
Return Loss	< -30 dB at 5 KHz
Total Harmonic Distortion (THD)	< 0.005% at 1 KHz
Min-Max Signal Level	< 0.3 V – 1.45 Vp-p
Differential Phase Error	±10° at 135 MHz over 100 m
Chassis and Environmental	
Construction	Plug-in card with keyed black metal plate
Shipping Weight	0.43 kg (0.95 lbs.)
Operating Temperature	0° to +40° C (+32° to +104° F)
Operating Humidity	20% to 90%, Non-condensing
Storage Temperature	-10° to +60° C (+14° to +140° F)
Storage Humidity	20% to 90%, Non-condensing
Other	
Warranty	2 years
HDMI Matrix Switcher Compatibility	FLX-8X8A
HDBaseT Transmitter (Video and Control) Compatibility	DIGI-HD70C-S, DIGI-HDE-S
HDBaseT Transmitter (Video Only) Compatibility	DIGI-HD70-S
Infrared (IR) Emitter	DIGIB-EMT
Infrared (IR) Receiver	DIGIB-EYE

FLX-HI4

I/O Connections	
HDMI Input	HDMI Type A Receptacle Connector
Supported Audio and Video	
Maximum Video Compatibility	Deep Color 48/36/30/24 Bit at 1080p, 3D, and 4k x 2k
Video Compliance	HDMI and HDCP
Embedded Audio	Up to PCM 8 channel, Dolby Digital TrueHD, and DTS-HD Master Audio
HDMI Signal Characteristics	
Maximum Distance	70 m
Bandwidth	340 MHz (10.2 Gbps)
Gain	0 dB
Resolution Range	Up to 4k x 2k
Crosstalk	< -50 dB at 5 KHz
Input Level	TMDS 2.9V/3.3V
Chassis and Environmental	
Construction	Plug-in card with keyed black metal plate
Shipping Weight	0.35 kg (0.78 lbs.)
Operating Temperature	0° to +40° C (+32° to +104° F)
Operating Humidity	20% to 90%, Non-condensing
Storage Temperature	-10° to +60° C (+14° to +140° F)
Storage Humidity	20% to 90%, Non-condensing
Other	
Warranty	2 years
HDMI Matrix Switcher Compatibility	FLX-8X8A

FLX-R14

I/O Connections	
Analog Video Input	Four (4) Female HD15
Supported Video	
Input Signal Types	VGA-UXGA, RGBHV, RGB, RsGsBs, Component Video, S-Video, & Composite Video
Output Scaling Resolutions	XGA (1024x768), WXGA (1280x800), 720p (1280x720), and 1080p (1920x1080)
Analog Video Input Characteristics	
Bandwidth	340 MHz (10.2 Gbps)
Gain	0 dB
Resolution Range	640x480 – 1920x1080
Crosstalk	< -50 dB at 5 MHz
Input Coupling	AC Coupling Only
Input Level	0.5V – 2.0Vp-p
Chassis and Environmental	
Construction	Plug-in card with keyed black metal plate
Shipping Weight	0.67 kg (1.36 lbs.)
Operating Temperature	0° to +40° C (+32° to +104° F)
Operating Humidity	20% to 90%, Non-condensing
Storage Temperature	-10° to +60° C (+14° to +140° F)
Storage Humidity	20% to 90%, Non-condensing
Included Accessories	
FLX-RBOCA (2 ea)	40 mm (15.75 in.) Male HD15 to three (3) Female RCA Connectors (Red, Green, Blue)
FLX-RBOCB (2 ea)	40 mm (15.75 in.) Male HD15 to one (1) Female RCA Connector (Yellow) and one (1) Female S-Video Connector
Other	
Warranty	2 years
HDMI Matrix Switcher Compatibility	FLX-8X8A

FLX-DI4

I/O Connections	
Single Link DVI Input	Four (4) Female DVI 24+5
Supported Video	
Input Signal Types	Single Link DVI-D up to 1920x1200
Video Compliance	HDMI and HDCP
EDID and DDC	Actively Buffered; Supports DVI and HDMI standards
DVI Signal Characteristics	
Bandwidth	340 MHz (10.2 Gbps)
Gain	0 dB
Resolution Range	640x480 – 1920x1200
Crosstalk	< -50 dB at 5 KHz
Input Level	TMDS 2.9V/3.3V
Chassis and Environmental	
Construction	Plug-in card with keyed black metal plate
Shipping Weight	0.37 kg (0.81 lbs.)
Operating Temperature	0° to +40° C (+32° to +104° F)
Operating Humidity	20% to 90%, Non-condensing
Storage Temperature	-10° to +60° C (+14° to +140° F)
Storage Humidity	20% to 90%, Non-condensing
Other	
Warranty	2 years
HDMI Matrix Switcher Compatibility	FLX-8X8A

FLX-BO4

I/O Connections	
HDBaseT Port	Four (4) Shielded RJ45 Female
IR In	Four (4) 3.5 mm TS (Requires DIGIB-EYE)
IR Out	Four (4) 3.5 mm TRS (Requires DIGIB-EMT)
RS232	Four (4) 3 pole Euroblock Connectors
Supported Audio and Video	
Maximum Video Compatibility at 70 m	Deep Color 36/30/24 Bit at 1080p
Maximum Video Compatibility at 40 m	Deep Color 48 Bit at 1080p, 3D, and 4k x 2k
Video Compliance	HDMI and HDCP
Embedded Audio	Up to PCM 8 channel, Dolby Digital TrueHD, and DTS-HD Master Audio
HDBaseT Signal Characteristics	
Maximum Distance	70 m
Bandwidth	10.2 Gbps
Gain	0 dB – 10 dB at 100 MHz
Resolution Range	800x600 – 1920x1200
Signal to Noise Ratio (SNR)	> 70 dB at 100 MHz over 100 m
Return Loss	< -30 dB at 5 KHz
Total Harmonic Distortion (THD)	< 0.005% at 1 KHz
Min-Max Signal Level	< 0.3 V – 1.45 Vp-p
Differential Phase Error	±10° at 135 MHz over 100 m
Chassis and Environmental	
Construction	Plug-in card with keyed black metal plate
Shipping Weight	0.43 kg (0.95 lbs.)
Operating Temperature	0° to +40° C (+32° to +104° F)
Operating Humidity	20% to 90%, Non-condensing
Storage Temperature	-10° to +60° C (+14° to +140° F)
Storage Humidity	20% to 90%, Non-condensing
Other	
Warranty	2 years
HDMI Matrix Switcher Compatibility	FLX-8X8A
HDBaseT Transmitter (Video and Control) Compatibility	DIGI-HD70C-R, DIGI-HDE-R
HDBaseT Transmitter (Video Only) Compatibility	DIGI-HD70-R
Infrared (IR) Emitter	DIGIB-EMT
Infrared (IR) Receiver	DIGIB-EYE

FLX-HO4

I/O Connections	
HDMI Output	HDMI Type A Receptacle Connector
Supported Audio and Video	
Maximum Video Compatibility	Deep Color 48/36/30/24 Bit at 1080p, 3D, and 4k x 2k
Video Compliance	HDMI and HDCP
Embedded Audio	Up to PCM 8 channel, Dolby Digital TrueHD, and DTS-HD Master Audio
HDMI Signal Characteristics	
Maximum Distance	70 m
Bandwidth	340 MHz (10.2 Gbps)
Gain	0 dB
Resolution Range	Up to 4k x 2k
Crosstalk	< -50 dB at 5 KHz
Input Level	TMDS 2.9V/3.3V
Chassis and Environmental	
Construction	Plug-in card with keyed black metal plate
Shipping Weight	0.35 kg (0.78 lbs.)
Operating Temperature	0° to +40° C (+32° to +104° F)
Operating Humidity	20% to 90%, Non-condensing
Storage Temperature	-10° to +60° C (+14° to +140° F)
Storage Humidity	20% to 90%, Non-condensing
Other	
Warranty	2 years
HDMI Matrix Switcher Compatibility	FLX-8X8A

FLX-DO4

I/O Connections	
Single Link DVI Output	Four (4) Female DVI 24+5
Supported Video	
Output Signal Types	Single Link DVI-D up to 1920x1200
Video Compliance	HDMI and HDCP
EDID and DDC	Actively Buffered; Supports DVI and HDMI standards
DVI Signal Characteristics	
Bandwidth	340 MHz (10.2 Gbps)
Gain	0 dB
Resolution Range	640x480 – 1920x1200
Crosstalk	< -50 dB at 5 KHz
Input Level	TMDS 2.9V/3.3V
Chassis and Environmental	
Construction	Plug-in card with keyed black metal plate
Shipping Weight	0.37 kg (0.81 lbs.)
Operating Temperature	0° to +40° C (+32° to +104° F)
Operating Humidity	20% to 90%, Non-condensing
Storage Temperature	-10° to +60° C (+14° to +140° F)
Storage Humidity	20% to 90%, Non-condensing
Other	
Warranty	2 years
HDMI Matrix Switcher Compatibility	FLX-8X8A

DIGIB-EMT

Signal Characteristics	
Wide-Band Infrared (IR)	30 KHz to 56 KHz at 5V DC reference
Physical Characteristics	
Material, Emitter Housing	Deep red translucent plastic
Dimensions, Emitter Housing	6 mm x 9.5 mm x 15 mm (0.24 in. x 0.37 in. x 0.59 in.)
Cable Length	2 m (6.56 ft)
Cable Connector	3.5 mm (1/8 in.) mono (TS) plug
Shipping Weight	0.5 lbs. (0.23kg)
Other	
Warranty	2 years
What's in the Box	(4) DIGIB-EMT
Compatible Devices	FLX-BI4, FLX-BO4, DIGI-HDE-S, DIGI-HDE-R, DIGI-HD70C-S, DIGI-HD70C-R, DIGI-HD-IR3-S, DIGI-HD-IR3-R, DIGI-HD-IR3-WP-S, DIGI-HD-IR3-WP-R, DIGI-HD-8X8, DIGI-HD-4X8, DIGI-HD-4X4, DIGI-HD-4X2, DIGI-VGASD2-S, DIGI-VGASD2-R, DIGI-VGASD2-T4, DIGI-VGASD2-T8

DIGIB-EMT

Signal Characteristics	
Wide-Band Infrared (IR)	30 KHz to 56 KHz at 5V DC reference
Physical Characteristics	
Material, Emitter Housing	Black plastic housing; smoke gray lens housing
Dimensions, Emitter Housing	13.5 mm x 9 mm x 29.5 mm (0.53 in. x 0.35 in. x 1.16 in.)
Cable Length	1 m (3.28 ft)
Cable Connector	3.5 mm (1/8 in.) stereo (TRS) plug
Shipping Weight	0.5 lbs. (0.23kg)
Other	
Warranty	2 years
What's in the Box	(1) DIGIB-EYE (hardware not included)
Compatible Devices	FLX-BI4, FLX-BO4, DIGI-HDE-S, DIGI-HDE-R, DIGI-HD70C-S, DIGI-HD70C-R, DIGI-HD-IR3-S, DIGI-HD-IR3-R, DIGI-HD-IR3-WP-S, DIGI-HD-IR3-WP-R