

R&S® Spectrum Rider FPH Handheld Spectrum Analyzer Getting Started

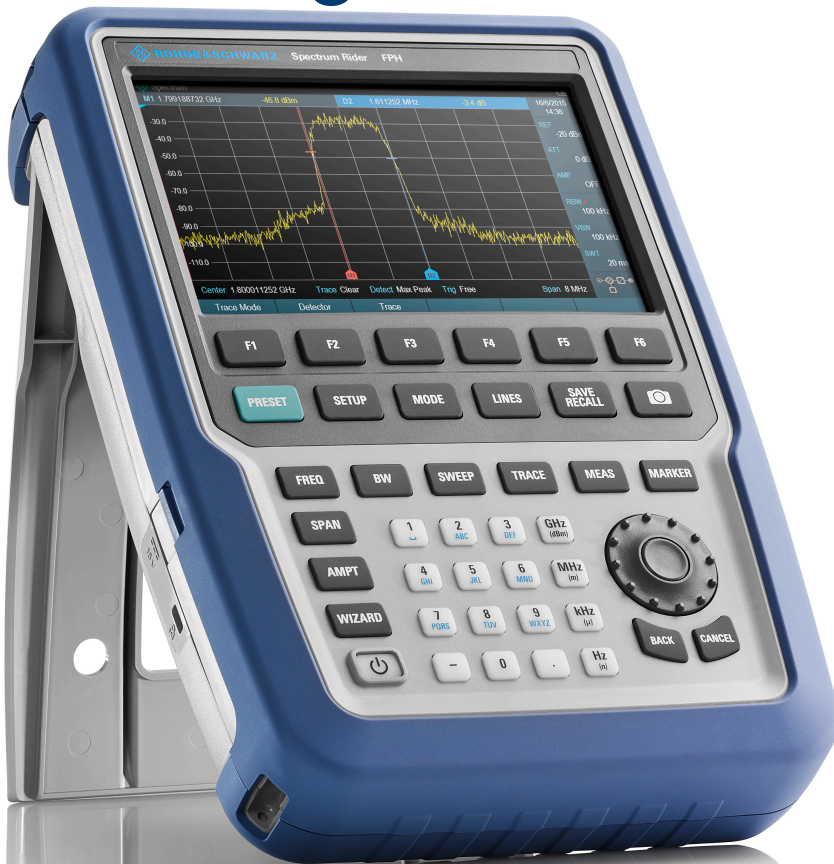

1321099602
Version 10

ROHDE & SCHWARZ
Make ideas real



This manual describes the following R&S®FPH models with firmware version 2.00 and higher:

- R&S®FPH (1321.1111.02)
- R&S®FPH (1321.1111.06)
- R&S®FPH (1321.1111.13)
- R&S®FPH (1321.1111.26)

- R&S®FPH (1321.1111.52, equivalent to 1321.1111.02)
- R&S®FPH (1321.1111.56, equivalent to 1321.1111.06)
- R&S®FPH (1321.1111.63, equivalent to 1321.1111.13)
- R&S®FPH (1321.1111.76, equivalent to 1321.1111.26)

© 2020 Rohde & Schwarz GmbH & Co. KG

Mühlldorfstr. 15, 81671 München, Germany

Phone: +49 89 41 29 - 0

Email: info@rohde-schwarz.com

Internet: www.rohde-schwarz.com

Subject to change – data without tolerance limits is not binding.

R&S® is a registered trademark of Rohde & Schwarz GmbH & Co. KG.

Trade names are trademarks of the owners.

1321.0996.02 | Version 10 | R&S®Spectrum Rider FPH

Throughout this manual, products from Rohde & Schwarz are indicated without the ® symbol, e.g. R&S®Spectrum Rider is indicated as R&S Spectrum Rider.

Safety Instructions

Instrucciones de seguridad

Sicherheitshinweise

Consignes de sécurité

WARNING

Risk of injury and instrument damage

The instrument must be used in an appropriate manner to prevent electric shock, fire, personal injury or instrument damage.

- Do not open the instrument casing.
 - Read and observe the "Basic Safety Instructions" delivered as printed brochure with the instrument.
 - Read and observe the safety instructions in the following sections. Note that the data sheet may specify additional operating conditions.
 - Keep the "Basic Safety Instructions" and the product documentation in a safe place and pass them on to the subsequent users.
-

ADVERTENCIA

Riesgo de lesiones y daños en el instrumento

El instrumento se debe usar de manera adecuada para prevenir descargas eléctricas, incendios, lesiones o daños materiales.

- No abrir la carcasa del instrumento.
 - Lea y cumpla las "Instrucciones de seguridad elementales" suministradas con el instrumento como folleto impreso.
 - Lea y cumpla las instrucciones de seguridad incluidas en las siguientes secciones. Se debe tener en cuenta que las especificaciones técnicas pueden contener condiciones adicionales para su uso.
 - Guarde bien las instrucciones de seguridad elementales, así como la documentación del producto, y entréguelas a usuarios posteriores.
-



WARNUNG

Gefahr von Verletzungen und Schäden am Gerät

Betreiben Sie das Gerät immer ordnungsgemäß, um elektrischen Schlag, Brand, Verletzungen von Personen oder Geräteschäden zu verhindern.

- Öffnen Sie das Gerätegehäuse nicht.
 - Lesen und beachten Sie die "Grundlegenden Sicherheitshinweise", die als gedruckte Broschüre dem Gerät beiliegen.
 - Lesen und beachten Sie die Sicherheitshinweise in den folgenden Abschnitten; möglicherweise enthält das Datenblatt weitere Hinweise zu speziellen Betriebsbedingungen.
 - Bewahren Sie die "Grundlegenden Sicherheitshinweise" und die Produktdokumentation gut auf und geben Sie diese an weitere Benutzer des Produkts weiter.
-



AVERTISSEMENT

Risque de blessures et d'endommagement de l'appareil

L'appareil doit être utilisé conformément aux prescriptions afin d'éviter les électrocutions, incendies, dommages corporels et matériels.

- N'ouvrez pas le boîtier de l'appareil.
 - Lisez et respectez les "consignes de sécurité fondamentales" fournies avec l'appareil sous forme de brochure imprimée.
 - Lisez et respectez les instructions de sécurité dans les sections suivantes. Il ne faut pas oublier que la fiche technique peut indiquer des conditions d'exploitation supplémentaires.
 - Gardez les consignes de sécurité fondamentales et la documentation produit dans un lieu sûr et transmettez ces documents aux autres utilisateurs.
-

Safety instructions for rechargeable lithium ion batteries

WARNING

Risk of serious personal injury or even death.

You must fully observe the following instructions in order to avoid serious personal injury – or even death – due to an explosion and/or fire.

1. Do not dismantle, open or crush the batteries or drop them from a great height. If mechanical damage occurs, there is a risk that chemicals may be released. Gases that are released can cause breathing difficulties. Immediately ventilate the area and in serious cases consult a doctor.
Irritation can occur if the chemicals that are released come in contact with the skin or eyes. If this happens, immediately and thoroughly rinse the skin or eyes with water and consult a doctor.
2. Do not expose cells or batteries to heat or fire. Do not store them in direct sunlight. If overheating occurs, there is the risk of an explosion or a fire, which can lead to serious personal injuries.
3. Keep the batteries clean and dry. If the terminals become soiled, clean them with a dry, clean cloth.
4. Charge the batteries prior to using them.
Only use the appropriate Rohde & Schwarz charger to charge the batteries. See the device manual or data sheet for the exact designation of the charger.
If the batteries are improperly charged, there is a risk of explosion, which can cause serious personal injury.
5. The charging temperature must be between 0 °C and 45 °C (see manual for information on possible restrictions).
6. Discharging may take place only at temperatures between 0 °C and 50 °C (see manual for information on possible restrictions).
7. Only charge batteries until they are fully charged. Frequent overcharging can reduce the battery lifetime.
8. Remove the battery from the device when the battery is not being used. Following a longer period of storage, it may be necessary to charge and discharge the battery several times in order to obtain the full capacity.
9. Only use the battery with designated Rohde & Schwarz devices. See the device manual for details.
10. Do not dispose of the batteries with unsorted municipal waste. The batteries must be collected separately. After the end of their life, dispose of the batteries at a suitable collection point or via a Rohde & Schwarz customer service center.



EU labeling for batteries and secondary cells

11. Follow the transport stipulations of the carrier (IATA-DGR, IMDG-Code, ADR, RID) when returning lithium batteries to Rohde & Schwarz subsidiaries.
12. Keep this safety information for future reference.

Instrucciones de seguridad para baterías recargables de ión litio

⚠ ADVERTENCIA

Posibilidad de lesiones graves que en determinadas circunstancias puede causar la muerte.

Tenga en cuenta los siguientes avisos en caso de explosión y/o incendio para impedir lesiones graves en personas que, en determinadas circunstancias, podrían incluso causar la muerte.

1. No desarme las baterías, no las abra, no las triture ni las deje caer desde una gran altura.
En caso de daños mecánicos existe el riesgo de salida de sustancias químicas. En caso de salida de gases pueden producirse dificultades respiratorias. Ventile inmediatamente la habitación y acuda a un médico en casos graves.
Si sustancias químicas provenientes de la batería entran en contacto con la piel o los ojos pueden producirse irritaciones. Enjuague en estos casos la piel y los ojos inmediatamente con abundante agua y acuda a un médico.
2. No exponga las celdas o baterías al calor ni al fuego. No las almacene bajo la luz solar directa. En caso de sobrecalentamiento existe peligro de explosión o de incendio, lo que puede provocar lesiones graves en personas.
3. Mantenga las baterías limpias y secas. Si los conectores están sucios, límpielos con un paño seco y limpio.
4. Cargue las baterías antes de su uso.
Solamente está permitido cargar la batería con el correspondiente cargador de Rohde & Schwarz. Consulte en el manual o en las especificaciones técnicas del equipo la denominación exacta del cargador.
Si las baterías se cargan de forma incorrecta existe peligro de explosión, lo que podría causar lesiones graves en personas.
5. La temperatura de carga debe encontrarse entre 0 °C y 45 °C (consulte el manual para posibles restricciones).
6. La descarga solamente puede efectuarse entre 0 °C y 50°C (consulte el manual para posibles restricciones).
7. Cargue las baterías solamente el tiempo necesario hasta que se hayan cargado por completo. La sobrecarga frecuente reduce la vida útil de la batería.
8. Extraiga la batería del equipo si no se va a utilizar. Después de un periodo de almacenamiento prolongado puede ser necesario cargar y descargar varias veces la batería para recuperar su capacidad completa.
9. Utilice la batería exclusivamente con los equipos Rohde & Schwarz correspondientes. Consulte para ello el manual del equipo.
10. No elimine las baterías junto con los residuos urbanos sin clasificar, sino por separado. Para eliminar la batería una vez finalizada su vida útil, diríjase a un punto de recogida de residuos adecuado o a una oficina de representación de Rohde & Schwarz.
Etiquetado de la UE para baterías y acumuladores
11. En caso de devolver baterías de litio a las filiales de Rohde & Schwarz, debe cumplirse las normativas sobre los modos de transporte (IATA-DGR, código IMDG, ADR, RID).
12. Conserve estas instrucciones de seguridad para fines de información y consulta posterior.

Sicherheitshinweise für wiederaufladbare Li-Ion-Batterien

WARNUNG

Mögliche schwere Verletzungen, unter Umständen mit Todesfolge.

Beachten Sie die folgenden Hinweise vollständig, um schwere Verletzungen von Personen - unter Umständen mit Todesfolge - durch Explosion und/oder Brand zu verhindern.

1. Batterien nicht zerlegen, öffnen, zerkleinern oder aus großer Höhe fallen lassen. Bei mechanischer Beschädigung besteht die Gefahr des Austritts von Chemikalien. Austretende Gase können zu Atembeschwerden führen. Sofort lüften, in schweren Fällen einen Arzt konsultieren.
Bei Haut- oder Augenkontakt mit austretenden Chemikalien können Hautirritationen und Reizungen auftreten. In diesen Fällen die Haut oder Augen sofort gründlich mit Wasser ausspülen und einen Arzt konsultieren.
2. Zellen oder Batterien weder Hitze noch Feuer aussetzen. Nicht im direkten Sonnenlicht lagern. Bei Überhitzung besteht die Gefahr einer Explosion oder eines Brandes, was zu schweren Verletzungen bei Personen führen kann.
3. Batterien sauber und trocken halten. Falls die Anschlüsse verschmutzt sind, mit einem trockenen, sauberen Tuch reinigen.
4. Batterien vor dem Gebrauch laden.
Die Batterie darf ausschließlich mit dem entsprechenden Rohde & Schwarz Ladegerät geladen werden. Siehe Handbuch oder Datenblatt des Gerätes für die genaue Bezeichnung des Ladegerätes.
Wenn Batterien unsachgemäß geladen werden, besteht Explosionsgefahr, was zu schweren Verletzungen bei Personen führen kann.
5. Die Ladetemperatur muss zwischen 0 °C und 45 °C betragen (für mögliche Einschränkungen siehe Handbuch).
6. Ein Entladen darf nur zwischen 0 °C und 50 °C erfolgen (für mögliche Einschränkungen siehe Handbuch).
7. Batterien nur so lange laden, bis sie vollständig aufgeladen sind. Ein häufiges Überladen führt zu einer geringeren Lebensdauer der Batterie.
8. Die Batterie aus dem Gerät entfernen, wenn sie nicht benutzt wird. Nach längerer Lagerzeit kann es erforderlich sein, die Batterie mehrmals zu laden und zu entladen, um die volle Leistungsfähigkeit zu erlangen.
9. Die Batterie nur mit dafür vorgesehenen Rohde & Schwarz-Geräten betreiben. Siehe dazu das Handbuch des Gerätes.
10. Die Batterien nicht über unsortierten Siedlungsabfall entsorgen, sondern getrennt sammeln. Nach Ende der Lebensdauer über eine geeignete Sammelstelle oder eine Rohde&Schwarz-Kundendienststelle entsorgen.
EU - Kennzeichnung für Batterien und Akkumulatoren
11. Bei Rücksendungen von Lithiumbatterien zu Rohde & Schwarz - Niederlassungen müssen die Transportvorschriften der Verkehrsträger (IATA-DGR, IMDG-Code, ADR, RID) befolgt werden.
12. Diese Sicherheitsinformationen für zukünftige Informations- und Nachschlagezwecke aufbewahren.



Consignes de sécurité pour batteries rechargeables lithium-ion

AVERTISSEMENT

Risque de blessures graves pouvant entraîner la mort.

Respecter intégralement les consignes ci-dessous afin d'éliminer tout risque de blessures graves voire mortelles par suite d'explosion et/ou d'incendie.

1. Ne pas démonter, ouvrir ou découper les batteries ni les faire tomber d'une hauteur importante. Des produits chimiques peuvent s'écouler en cas de détérioration mécanique et les gaz libérés peuvent provoquer des difficultés respiratoires. Aérer immédiatement les locaux. Dans les cas graves, consulter un médecin. Si la peau ou les yeux entrent en contact avec les produits chimiques libérés, des irritations peuvent se produire. Rincer immédiatement et abondamment la peau ou les yeux à l'eau claire et consulter un médecin.
2. Ne pas exposer les cellules ou les batteries à la chaleur ou au feu. Ne pas les stocker dans un endroit exposé à la lumière directe du soleil. Toute surchauffe risque de provoquer une explosion ou un incendie, ce qui peut entraîner des blessures graves.
3. Conserver les batteries dans un lieu sec et propre. Nettoyer les points de contact sales à l'aide d'un chiffon sec et propre.
4. Charger les batteries avant utilisation. Utiliser seulement le chargeur Rohde & Schwarz approprié pour recharger les batteries. Les références exactes du chargeur sont indiquées dans le manuel ou la fiche technique de l'appareil. Une recharge incorrecte des batteries peut entraîner des explosions susceptibles de causer des blessures graves.
5. Recharger impérativement à des températures comprises entre 0 °C et 45 °C (restrictions éventuelles : voir le manuel).
6. Décharger impérativement à des températures comprises entre 0 °C et 50 °C (restrictions éventuelles : voir le manuel).
7. Terminer la charge dès que les batteries sont complètement rechargées. Une surcharge répétée diminue la longévité des batteries.
8. Retirer les batteries de l'appareil lorsqu'elles ne sont pas utilisées. Après un stockage prolongé, plusieurs cycles de recharge et de décharge peuvent s'avérer nécessaires pour rétablir la pleine capacité des batteries.
9. Utiliser les batteries exclusivement dans les appareils Rohde & Schwarz auxquels elles sont destinées. Voir le manuel fourni avec chaque appareil.



10. Ne pas éliminer les batteries avec les déchets municipaux non triés mais s'assurer qu'elles soient collectées séparément. Recycler les batteries en fin de vie en les confiant à un point de collecte compétent ou à un point de service après-vente Rohde & Schwarz.

Marquage UE pour batteries et accumulateurs

11. Lors des renvois de batteries au lithium à des filiales Rohde & Schwarz, il convient de respecter les prescriptions de transport (IATA-DGR, code IMDG, ADR, RID) fixées par les transporteurs.
12. Conserver ces consignes de sécurité de sorte à pouvoir vous y reporter ou vérifier ultérieurement certains points.

Customer Support

Technical support – where and when you need it

For quick, expert help with any Rohde & Schwarz product, contact our customer support center. A team of highly qualified engineers provides support and works with you to find a solution to your query on any aspect of the operation, programming or applications of Rohde & Schwarz products.

Contact information

Contact our customer support center at www.rohde-schwarz.com/support, or follow this QR code:



QR code to the Rohde & Schwarz support page

Contents

1 Preface	7
1.1 Documentation Overview	7
1.1.1 Manuals.....	7
1.1.2 Data Sheet.....	8
1.1.3 Calibration Certificate.....	8
1.1.4 Release Notes, Open Source Acknowledgment.....	8
1.1.5 Application Notes, Application Cards, Videos.....	8
1.2 Conventions Used in the Documentation	9
1.2.1 Typographical Conventions.....	9
1.2.2 Conventions for Procedure Descriptions.....	9
1.2.3 Other Conventions.....	9
2 Welcome to the R&S Spectrum Rider	10
3 Preparing for Use	11
3.1 Putting into Operation	11
3.1.1 Unpacking and Checking the Instrument.....	12
3.1.2 Accessory List.....	13
3.1.3 Setting up the R&S Spectrum Rider.....	13
3.1.4 Using the AC Adapter.....	15
3.1.5 Battery Operation.....	16
3.1.6 Battery Maintenance.....	18
3.1.6.1 Handling.....	18
3.1.6.2 Storage.....	18
3.1.6.3 Transportation.....	19
3.1.6.4 End of Life.....	19
3.2 Switching the Instrument On and Off	19

3.3 Checking the Supplied Options.....	20
4 Instrument Tour.....	23
4.1 Overview Control.....	23
4.2 Connectors of the R&S Spectrum Rider.....	24
4.2.1 RF Input.....	25
4.2.2 BNC Connector.....	26
4.2.3 Headphone Jack.....	27
4.2.4 USB Port.....	27
4.2.5 DC Port.....	27
4.2.6 Mechanical Locking Device.....	28
4.2.7 Mini USB and LAN Port.....	28
4.2.8 SD Card Slot.....	29
4.3 Touchscreen Display.....	30
4.3.1 Title Bar.....	32
4.3.2 Measurement Result View.....	33
4.3.3 Measurement Trace Window.....	34
4.3.4 Parameter View.....	35
4.3.4.1 Configuration Overview.....	36
4.4 On-screen Keyboard.....	39
4.5 Front Panel Keys.....	39
4.5.1 POWER Key.....	39
4.5.2 Screenshot Key.....	40
4.5.3 Softkey.....	40
4.5.4 System Keys.....	40
4.5.5 Function Keys.....	41
4.5.6 Keypad.....	42
4.5.7 Navigation Controls.....	43

4.6 Managing Options	44
4.6.1 Enabling Options.....	44
4.6.2 Checking Options.....	45
4.6.3 Managing Options with R&S License Manager.....	45
4.7 Configuring the R&S Spectrum Rider	47
4.7.1 Configuring the Hardware.....	48
4.7.2 Configuring Antennas.....	49
4.7.3 Using the GPS Receiver.....	54
4.7.4 Configuring Date and Time.....	57
4.7.5 Selecting Regional Settings.....	58
4.7.6 Configuring the Display.....	59
4.7.7 Configuring the Audio Output.....	62
4.7.8 Configuring Power Supply.....	63
4.7.9 Internal Alignment.....	65
4.7.10 Resetting the R&S Spectrum Rider.....	67
4.8 Connecting the R&S Spectrum Rider to a PC	68
4.8.1 LAN Connection.....	69
4.8.2 USB Connection.....	74
5 Trying Out the Instrument	76
5.1 Using the Spectrum Analyzer	76
5.1.1 Attenuating the Signal.....	76
5.1.2 Using the Preamplifier.....	77
5.1.3 Measuring CW Signals.....	78
5.1.4 Measuring Harmonics.....	82
5.2 Using a Power Sensor	84
5.2.1 Measuring the Power with a Power Sensor.....	85

5.2.2 Measuring Power and Return Loss.....	88
5.3 Saving and Recalling Results and Settings.....	91
Index.....	93

1 Preface

1.1 Documentation Overview

This section provides an overview of the R&S Spectrum Rider user documentation.

1.1.1 Manuals

You find the documents on the R&S Spectrum Rider product page at:

<http://www.rohde-schwarz.com/manual/fph>

Getting started manual

Introduces the R&S Spectrum Rider and describes how to set up and start working with the product. The printed document is delivered with the instrument.

User manual

Contains the description of all instrument modes and functions. It also provides an introduction to remote control, a complete description of the remote control commands with programming examples, and information on maintenance and instrument interfaces. Includes the contents of the getting started manual.

The *online version* of the user manual provides the complete contents for immediate display on the internet.

Basic safety instructions

Contains safety instructions, operating conditions and further important information. The printed document is delivered with the instrument.

Instrument security procedures manual

Deals with security issues when working with the R&S Spectrum Rider in secure areas.

Service manual

Describes the performance test for checking the rated specifications, module replacement and repair, firmware update, troubleshooting and fault elimination, and contains mechanical drawings and spare part lists. The service manual is available for registered users on the global Rohde & Schwarz information system (GLORIS, <https://gloris.rohde-schwarz.com>).

1.1.2 Data Sheet

The data sheet contains the technical specifications of the R&S Spectrum Rider. It also lists the options and their order numbers as well as optional accessories.

The brochure provides an overview of the R&S Spectrum Rider and shows its specific characteristics.

<http://www.rohde-schwarz.com/brochure-datasheet/fph>

1.1.3 Calibration Certificate

The document is available on <https://gloris.rohde-schwarz.com/calcert>. You need the device ID of your instrument, which you can find on a label on the rear panel.

1.1.4 Release Notes, Open Source Acknowledgment

The release notes list new features, improvements and known issues of the current firmware version, and describe the firmware installation.

The open source acknowledgment document provides verbatim license texts of the used open source software.

<http://www.rohde-schwarz.com/firmware/fph>

1.1.5 Application Notes, Application Cards, Videos

These documents contain information about possible applications and background information on various topics, see www.rohde-schwarz.com/appnotes

1.2 Conventions Used in the Documentation

The following conventions are used throughout the R&S Spectrum Rider manual.

1.2.1 Typographical Conventions

The following text markers are used throughout this documentation:

Convention	Description
"Graphical user interface elements"	All names of graphical user interface elements on the screen, such as dialog boxes, menus, options, buttons, and softkeys are enclosed by quotation marks.
[KEYS]	Key names are written in capital letters.
File names, commands, program code	Filenames, commands, coding samples and screen output are distinguished by their font.
<i>Input</i>	Input to be entered by the user is displayed in italics.
Links	Links that you can click are displayed in underline blue font.
"References"	References to other parts of the documentation are enclosed by quotation marks.

1.2.2 Conventions for Procedure Descriptions

When describing how to operate the instrument, several alternative methods may be available to perform the same task. In this case, the procedure using the touchscreen is described. The alternative procedure using the keys on the instrument or the on-screen keyboard is only described if it deviates from the standard operating procedures.

The term "select" may refer to any of the described methods, i.e. using a finger on the touchscreen or a key on the instrument or on a keyboard.

1.2.3 Other Conventions

Remote commands may include abbreviations to simplify input. In the description of such commands, all parts that have to be entered are written in capital letters. Additional text in lower-case characters is for information only.

2 Welcome to the R&S Spectrum Rider

The R&S Spectrum Rider is a new generation Rohde & Schwarz signal and spectrum analyzer developed to meet demanding customer requirements. Offering touchscreen input, the analyzer enhances user experience in making measurements fast and easy.

This user manual contains a description of the functionality that the instrument provides. The latest version is available for download at the product homepage (<http://www.rohde-schwarz.com/product/fph.html>).

3 Preparing for Use

3.1 Putting into Operation

This chapter describes the basic steps to be taken when setting up the R&S Spectrum Rider for the first time.

⚠ WARNING**Risk of injury due to disregarding safety information**

Observe the information on appropriate operating conditions provided in the data sheet to prevent personal injury or damage to the instrument. Read and observe the basic safety instructions provided with the instrument, in addition to the safety instructions in the following sections. In particular:

- Do not open the instrument casing.
-

NOTICE**Risk of instrument damage due to inappropriate operating conditions**

Specific operating conditions are required to ensure accurate measurements and to avoid damage to the instrument. Observe the information on appropriate operating conditions provided in the basic safety instructions and the instrument's data sheet.

NOTICE**Instrument damage caused by electrostatic discharge**

Electrostatic discharge (ESD) can damage the electronic components of the instrument and the device under test (DUT). Electrostatic discharge is most likely to occur when you connect or disconnect a DUT or test fixture to the instrument's test ports. To prevent electrostatic discharge, use a wrist strap and cord and connect yourself to the ground, or use a conductive floor mat and heel strap combination.

NOTICE**Risk of instrument damage during operation**

An unsuitable operating site or test setup can cause damage to the instrument and to connected devices. Ensure the following operating conditions before you switch on the instrument:

- The instrument is dry and shows no sign of condensation.
- The instrument is positioned as described in the following sections.
- The ambient temperature does not exceed the range specified in the data sheet.
- Signal levels at the input connectors are all within the specified ranges.
- Signal outputs are correctly connected and are not overloaded.

 **EMI impact on measurement results**

Electromagnetic interference (EMI) may affect the measurement results.

To suppress generated electromagnetic interference (EMI):

- Use suitable shielded cables of high quality. For example, use double-shielded RF and LAN cables.
- Always terminate open cable ends.
- Note the EMC classification in the data sheet.

3.1.1 Unpacking and Checking the Instrument

Check the equipment for completeness using the delivery note and the accessory lists for the various items. Check the instrument for any damage. If there is damage, immediately contact the carrier who delivered the instrument. Make sure not to discard the box and packing material.

 **Packing material**

Retain the original packing material. If the instrument needs to be transported or shipped later, you can use the material to protect the control elements and connectors.

NOTICE**Risk of damage during transportation and shipment**

Insufficient protection against mechanical and electrostatic effects during transportation and shipment can damage the instrument.

- Always make sure that sufficient mechanical and electrostatic protection is provided.
- When shipping an instrument, the original packaging should be used. If you do not have the original packaging, use sufficient padding to prevent the instrument from moving around inside the box. Pack the instrument in antistatic wrap to protect it from electrostatic charging.
- Secure the instrument to prevent any movement and other mechanical effects during transportation.

3.1.2 Accessory List

The instrument comes with the following accessories:

- Power supply cable and adapter set
- Li-ion rechargeable battery
- USB2.0 cable A-Mini
- Side strap
- "Getting Started" printed manual
- Document folder containing safety instructions, KC and CE certificate

Optional accessories and their order numbers are listed in the data sheet.

3.1.3 Setting up the R&S Spectrum Rider

The R&S Spectrum Rider is designed for lab operation as well as for service and maintenance applications on-site.

Depending on the environment, you can adjust the viewing angle of the display and either lay it out horizontally or prop it up using the support on the back of the R&S Spectrum Rider.

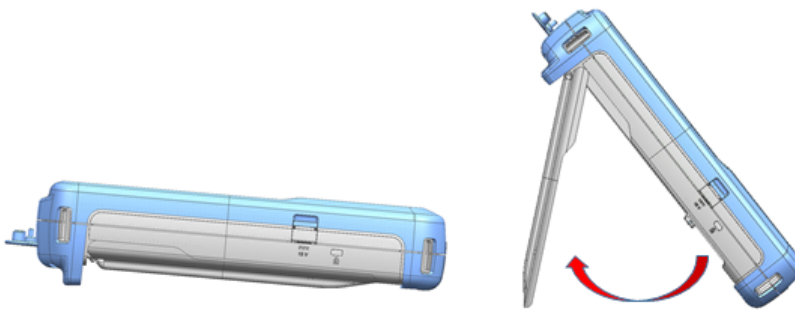

When laid out horizontally for operation from above, the R&S Spectrum Rider is tilted slightly due to the micro-stand at the back. This position provides the optimum viewing angle for the display.

To allow easy operation from the front and still be able to read the display, you can swing out the support on the back of the R&S Spectrum Rider.

Before you turn on the R&S Spectrum Rider, you should insert the lithium ion battery included in the delivery into the battery compartment located at the back of the R&S Spectrum Rider.

Insert battery

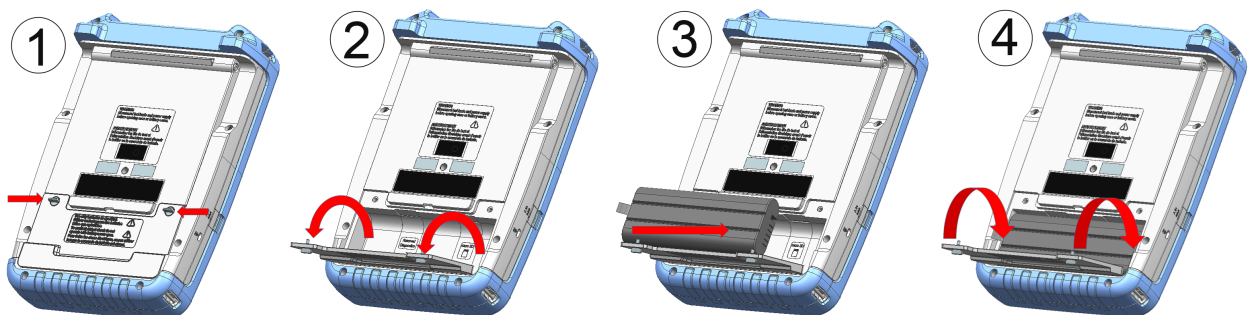

1. Unscrew the two thumb screws located on the battery compartment.
2. Open the cover.
3. Insert the battery into the R&S Spectrum Rider.
4. Close the cover and screw back the thumb screws.

You can operate the R&S Spectrum Rider with the AC adapter or the battery. Both are included in the delivery.

3.1.4 Using the AC Adapter

NOTICE

Risk of instrument damage

To avoid instrument damage:

- Only use the power supply (R&S HA-Z301, order number 1321.1386.02) included in the delivery.
- Make sure that the AC supply voltage is compatible to the voltage specified on the power supply unit.
- Attach the appropriate adapter to the power supply.

Connect the AC adapter to the DC port on the left side of the R&S Spectrum Rider (item 1 of [Figure 3-1](#)). Make sure to fully insert the AC adapter plug into the DC port.

Depending on the system you need, firmly connect the appropriate power cable included in the delivery to the AC adapter (item 2 of [Figure 3-1](#)).

Finally, connect the power cable plug to an AC power outlet.



Figure 3-1: AC adapter

- 1 = AC adapter
2 = Power cable

The voltage range of the AC power supply is 100 V to 240 V AC.

After the R&S Spectrum Rider is connected to the power supply, you can turn it on with the [Power] key on the front panel.

3.1.5 Battery Operation

The R&S Spectrum Rider has a smart battery indicator which displays the battery charging status on the [Power] key as well as the battery icon shown at the top right corner of the display screen. See [Chapter 4.3.1, "Title Bar"](#), on page 32.

The lithium ion battery has a capacity of 6.4 Ah and it allows operation of up to eight hours when it is fully charged.

The actual operation time depends on the current charged status (see [Figure 3-2](#)), the ambient temperature and the operating mode of the R&S Spectrum Rider.

For a summary of the LED indication of the [Power] key, see [Table 3-1](#).

The battery charging and discharging process of the battery icon indicated in the display screen is illustrated below:

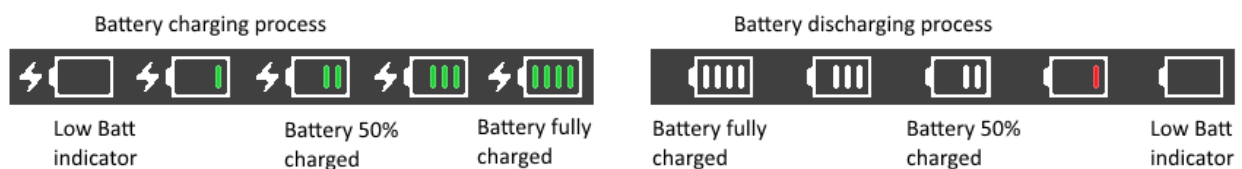

Figure 3-2: Battery charging and discharging process

Charging time is about three hours when the R&S Spectrum Rider is in inactive mode (i.e. R&S Spectrum Rider is switched off). If the instrument is in active mode (i.e. R&S Spectrum Rider is switched on), the charging time is extended to about four hours because the charging current is reduced as the power is partially drained by the usage of the R&S Spectrum Rider.

During operation in the field, you can also charge the battery with the car adapter (R&S HA-Z302, order number 1321.1340.02). You can connect the car adapter to the DC port. With the car adapter, you are able to charge the R&S Spectrum Rider via the car's cigarette lighter socket. A replacement battery (R&S HA-Z306, order number 1321.1334.02) with the same capacity and charging time as the battery included in the standard delivery is also available if necessary.

i Battery dispatched during delivery is not fully charged, for battery operation you have to charge it first.

To charge the battery, connect the charger to AC power adapter included in the delivery. For more information, see "[Using an external battery charger](#)" on page 17.

Using an external battery charger

You can also use an external battery charger (R&S HA-Z303, order number 1321.1328.02) to charge the battery.

To charge the battery externally, put the battery into the external charger and supply it with power via the AC power adapter.

An amber LED on the charger indicates the charging process. The LED turns to green when the battery is fully charged. A red LED on the charger indicates that the battery is not charging or the charging failed.

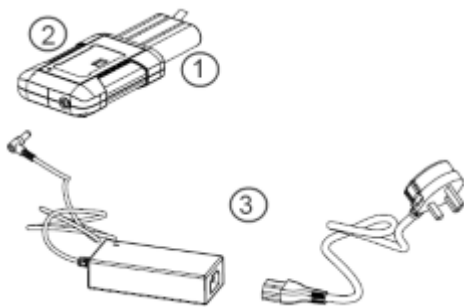

Figure 3-3: External battery charger

1 = Lithium ion battery R&S HA-Z306

2 = External charger R&S HA-Z303

3 = Power supply unit R&S HA-Z301 or car adapter R&S HA-Z302

⚠ WARNING

Risk of traffic accidents, physical injury and property damage

- Turn off the R&S Spectrum Rider while driving or while the engine is on.
- Operation of the R&S Spectrum Rider via the cigarette lighter socket while driving or while the engine on is prohibited.

3.1.6 Battery Maintenance

The R&S Spectrum Rider comes with a lithium-ion battery. In general, these batteries are easy to handle. When you handle the battery, follow the instruction mentioned in the safety instructions and in the following chapters.

3.1.6.1 Handling

- The battery has been designed for a specific application. Do not use it for any other applications.
- Do not connect batteries in series or parallel as it can cause serious damage.
- Observe correct polarities during installation and charging.
- Do not heat over 70°C. The battery contains thermal fuses that could activate and render the battery inoperable.
- The battery contains an electronic device for protection against deep discharge, overcharge and short-circuiting between the terminals.
 - If you cannot discharge the battery, it may be deep discharged. Charge the battery for 0.5 hours and check again.
 - If you cannot charge the battery, it may be overcharged. Discharge the battery and check again.
 - If the battery has been short-circuited, charge it to reset the electronics.
 - If the battery still does not work, contact the Rohde & Schwarz customer support.
- Do not allow metallic objects to come into contact with the terminals.
- Do not solder directly to the battery.

3.1.6.2 Storage

The battery self-discharges while not in use. When storing the battery for an extended period of time, make sure to

- Handle the battery carefully to avoid short circuits. Make sure that leads and terminals are insulated.
- Keep the battery in the supplied packaging before use. The temperature should not exceed 30°C.
- Store the battery at an initial state of charge between 15% and 50% of its capacity. When calculating the initial state of charge, consider

Switching the Instrument On and Off

- The maximum consumption of electronic devices
- The self-discharge of the battery - the higher the state of charge, the higher the rate of self-discharge
- Avoid a deep discharge of the battery. A deep discharge occurs when the state of charge falls below 5% of the battery's capacity.
- Recharge the battery at least every six months.

Should the battery voltage be low or even 0 V, the battery protection circuit may have gone into a sleep mode. In that case, reset the battery with an approved charger.

3.1.6.3 Transportation

No special regulations apply for transporting the battery. The battery cells contain no metallic lithium.

3.1.6.4 End of Life

The capacity of the battery decreases after it has gone through numerous charge cycles and nearing its end of life. When the battery is dead, do not open the battery. Do not dispose battery in fire.

3.2 Switching the Instrument On and Off

The instrument can be powered with an AC or DC (battery operated or via car adapter) input. See [Chapter 3.1.4, "Using the AC Adapter"](#), on page 15.

- ▶ Press [Power] key to switch on the instrument.
During booting, the R&S Spectrum Rider displays a splash screen to indicate the operable frequency range of the instrument. Depending on the frequency upgrade option installed, the respective splash screen is loaded.
After booting, the instrument is ready for operation.
Refer to the instrument brochure for the list of options available.
- ▶ Press [Power] key to switch off the instrument.





NOTICE**Risk of losing data**

If a running instrument (without battery) is disconnected directly from the power cord, the instrument loses its current settings. Furthermore, program data may be lost.

Press [Power] key first to shut down the application properly.

The following shows the [POWER] key behavior in different operation modes.

Table 3-1: Summary of LED indication on POWER key

LED indication on [Power] key		Descriptions
Green LED		Instrument is in operation mode.
Blue LED		Instrument is in switch off mode with a fully charged battery. A blinking blue LED indicates that the battery charging is in process.
Amber LED		Instrument is in switch off mode with AC supply and there is no battery in it.
Red LED		There is an error in the battery charging.
LED "OFF"		This is an indication that there is no AC or DC supply to the instrument. The instrument is in a switch off mode.

3.3 Checking the Supplied Options

The instrument can be equipped with different hardware and installed options. For a list of R&S Spectrum Rider supported hardware and installed options, refer to the instrument brochure for the list of options available.

In order to check whether the installed options correspond to the options indicated in the delivery note, proceed as follows.

1. Press [SETUP] key.
2. Select "Installed Options" softkey.
A list of all available options and the current status of the options are displayed.

Checking the Supplied Options



3. Check the availability of the installed options as indicated in the delivery note.
4. Check the availability of the hardware options as indicated in the delivery note.
5. Press "HW/SW Info" softkey.
A list with hardware and firmware information is displayed.

Checking the Supplied Options

Spectrum					
Hardware	Instrument Model	FPH			
	Instrument Serial Number	101053			
	Mainboard Part Number	1320.8841.02			
	Mainboard Revision	02.00			
	Mainboard Serial Number	100581			
	Frontboard Part Number	1320.8993.02			
	Frontboard Revision	05.03			
	Frontboard Serial Number	100977			
	Controller Version	V4.0.0.0			
<hr/>					
Software	Software Version	X0.09.1097			
Config Overview	Instrument Setup	User Preference	HW/SW Info	Installed Options	Exit

4 Instrument Tour

This chapter describes the front panel, including all function keys and connectors.

It also contains general system configuration on the R&S Spectrum Rider as well as the connectivity of the instrument to PC.

• Overview Control.....	23
• Connectors of the R&S Spectrum Rider.....	24
• Touchscreen Display.....	30
• On-screen Keyboard.....	39
• Front Panel Keys.....	39
• Managing Options.....	44
• Configuring the R&S Spectrum Rider.....	47
• Connecting the R&S Spectrum Rider to a PC.....	68

4.1 Overview Control



Figure 4-1: Front panel of R&S Spectrum Rider

- 1 = RF input (N-connector or RPC 3.5 mm connector)
- 2 = BNC connectors
- 3 = Headphone jack

Connectors of the R&S Spectrum Rider

- 4 = USB ports
- 5 = Touch-sensitive screen area
- 6 = Softkey labels (on display)
- 7 = Softkey
- 8 = System Keys
- 9 = DC port (behind protective cap)
- 10 = Kensington lock
- 11 = Function Keys
- 12 = Power key
- 13 = Alphanumeric key
- 14 = Unit keys
- 15 = Back key
- 16 = Cancel key
- 17 = Rotary knob
- 18 = Screenshot key
- 19 = LAN and mini USB ports (behind protective cap)
- **20 = SD Card Slot (not visible as it is located behind the battery compartment)

NOTICE**Instrument damage caused by cleaning agents**

Cleaning agents contain substances that may damage the instrument. For example, cleaning agents that contain a solvent may damage the front panel labeling, plastic parts, or the display.

Never use cleaning agents such as solvents (thinners, acetone, etc.), acids, bases, or other substances.

The outside of the instrument can be cleaned sufficiently using a soft, lint-free dust cloth.

4.2 Connectors of the R&S Spectrum Rider

The R&S Spectrum Rider has several connectors. The connectors are either on the upper, left or right side of the instrument.

- RF Input..... 25
- BNC Connector..... 26
- Headphone Jack..... 27
- USB Port..... 27
- DC Port..... 27

Connectors of the R&S Spectrum Rider

- [Mechanical Locking Device](#).....28
- [Mini USB and LAN Port](#).....28
- [SD Card Slot](#).....29

4.2.1 RF Input

The RF input 50 Ω is located on the top of the R&S Spectrum Rider.



Depending on the instrument models, different RF connector is used.

For model 02, model 06 and model 13, N type connector is used. For model 26, RPC 3.5 mm connector is used.

Connect a cable or DUT to the RF input. Use a cable to connect the DUT to the R&S Spectrum Rider, if necessary.

Make sure not to overload the R&S Spectrum Rider when a DUT is connected.

The maximum power that is permissible at the RF input is 20 dBm (or 100 mW).

The RF input is protected from static discharges and voltage pulses by a limiting circuit.

NOTICE

RF power overload

The R&S Spectrum Rider maybe loaded with up to 30 dBm (or 1 W) for up to three minutes. If you apply 1 W for a longer period, the R&S Spectrum Rider may be destroyed.

⚠ WARNING

Risk of electric shock

To avoid electrical shock the DC input voltage, you must never exceed the value specified on the housing.

NOTICE**Risk of damage of the R&S Spectrum Rider**

To avoid damage to the coupling capacitor, input attenuator or the mixer, the DC input voltage must never exceed the value specified in the data sheet.

4.2.2 BNC Connector

The BNC connector is located on the top of the R&S Spectrum Rider.

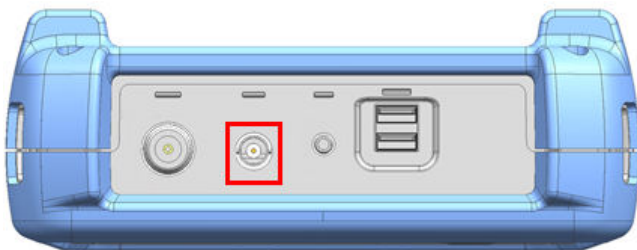

You can connect the BNC connector for various applications. It supports an external trigger signal or an external reference signal.

When the BNC connector is configured as a trigger input, it controls the start of a measurement. The trigger mode is selected in the "Sweep" menu, see [Chapter 4.5.5, "Function Keys"](#), on page 41. The trigger threshold is similar to that of TTL signals.

When the BNC connector is configured as reference input, you can apply a 10 MHz external reference signal to it for frequency synchronization. The external reference label **Ext Ref** is displayed at the top right corner of the trace window to indicate that the reference signal is supplied via external signal input. The label turns green when the reference signal is detected.

The level of the reference signal must be larger than 0 dBm. If there is no reference signal present at the BNC connector, the R&S Spectrum Rider displays an appropriate message. Thus, measurements without a valid reference can be avoided.

For more information on configuring the BNC connector for the appropriate signal, see ["Configuring the BNC connector"](#) on page 49 and [Chapter 4.7.3, "Using the GPS Receiver"](#), on page 54.

4.2.3 Headphone Jack

The 3.5 mm connector for headphones is located on the top of the R&S Spectrum Rider.

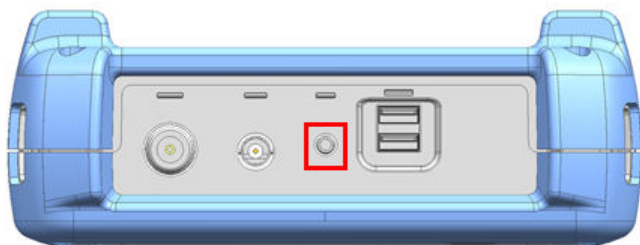

The internal impedance of the connector is approximately 10 Ω .

4.2.4 USB Port

The two USB ports are located on top of the R&S Spectrum Rider.

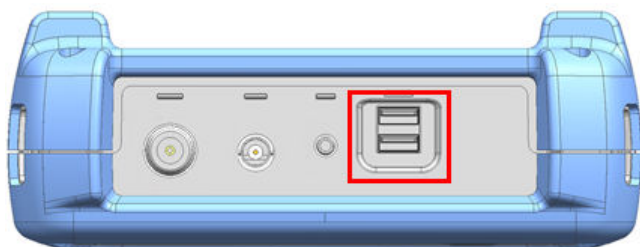

You can use the USB interface to connect a memory stick and store data sets or screenshots.

The USB connector can also be used to control the operation of the power sensor and GPS receiver. See [Chapter 5.2, "Using a Power Sensor"](#), on page 84 and [Chapter 4.7.3, "Using the GPS Receiver"](#), on page 54.

4.2.5 DC Port

The DC port is located behind a protective cap on the left side of the R&S Spectrum Rider.

Connectors of the R&S Spectrum Rider

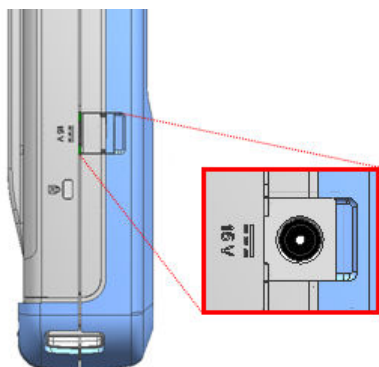

The R&S Spectrum Rider is supplied with power by the AC/DC transformer power supply via the DC connector. You can also use the DC connector to charge the battery.

4.2.6 Mechanical Locking Device

The Kensington lock is located behind a protective cap on the left side of the R&S Spectrum Rider.

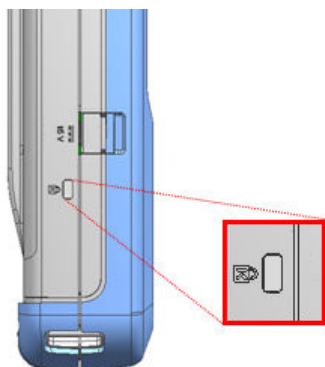

A Kensington lock can be anchored to the R&S Spectrum Rider housing to secure it to a workstation mechanically.

4.2.7 Mini USB and LAN Port

The mini USB and LAN ports are located behind a protective cap on the right side of the R&S Spectrum Rider.

Connectors of the R&S Spectrum Rider

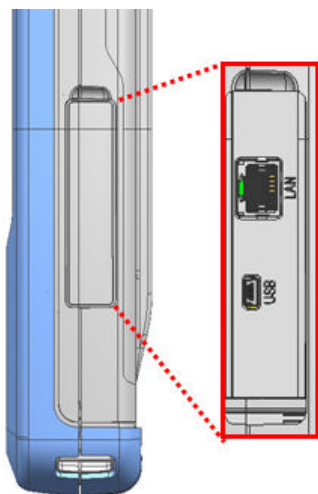

You can connect the R&S Spectrum Rider to a PC via USB or LAN and transfer data in both directions.

Configure the USB and LAN connection via the "Instrument Setup" menu. For more information, see [Chapter 4.7.1, "Configuring the Hardware"](#), on page 48.

4.2.8 SD Card Slot

The SD card slot is located behind the battery compartment of the R&S Spectrum Rider.

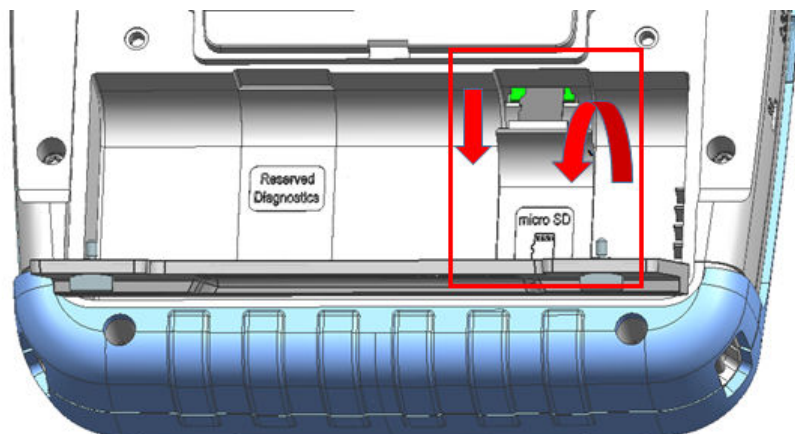

Peel open the SD card protective cap to access to the SD card slot. You can use the SD card to store data sets or screenshots.

4.3 Touchscreen Display

All measurement results are displayed on the screen. Additionally, the screen display provides status and setting information and you can change the parameters setting with touchscreen gesture.

The touch-sensitive screen offers an alternative means of user interaction for quick and easy handling of the instrument.

NOTICE**Risk of touchscreen damage during operation**

The touchscreen may be damaged by inappropriate tools or excessive force.

Observe the following instructions when operating or cleaning the touchscreen:

- Never touch the screen with ball point pens or other pointed objects with sharp edges.
 - It is recommended that you operate the touchscreen by finger only. As an alternative, you may use a stylus pen with a smooth soft tip.
 - Never apply excessive force to the screen. Touch it gently.
 - Never scratch the screen surface, e.g. with a finger nail. Never rub it strongly, for example with a dust cloth.
-

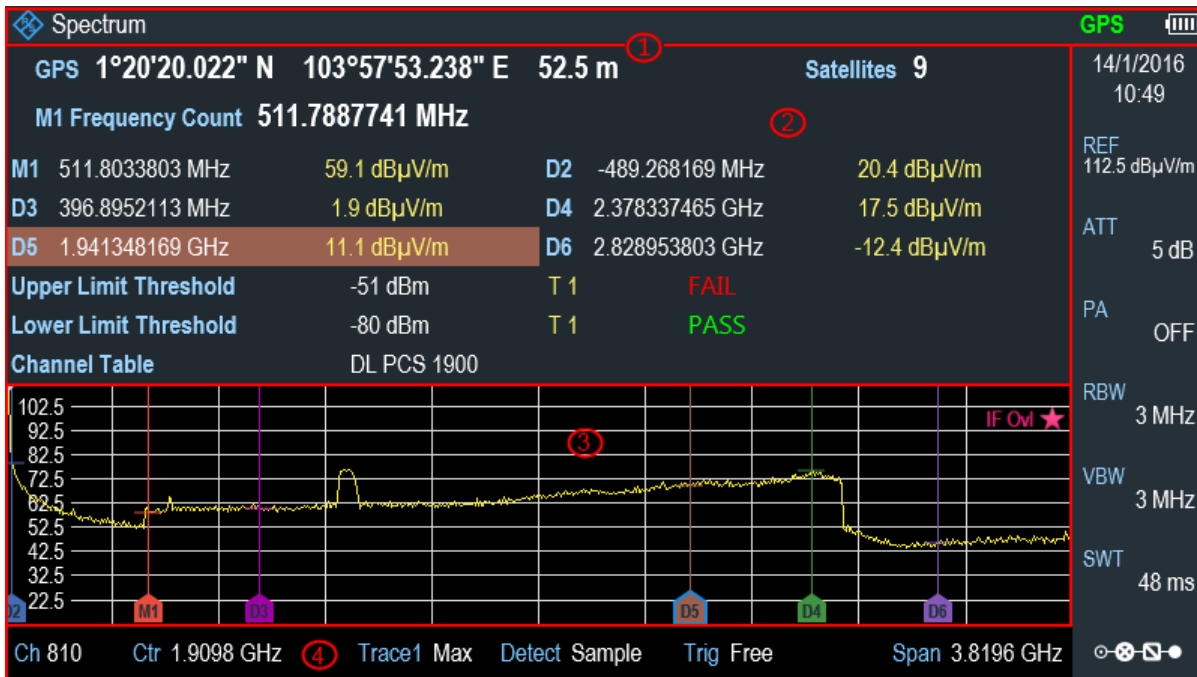

Figure 4-2: R&S Spectrum Rider touchscreen element

The touchscreen display can be divided into several sections:

1. Title Bar
2. Measurement Result View
3. Measurement Trace Window
4. Parameter View

A touchscreen is a screen that is touch-sensitive, i.e. it reacts in a specified way when a particular element on the screen is tapped by a finger.

Touchscreen gesture

Special touchscreen features are provided to enhance user experience in using the instrument:

- Swipe horizontally in the trace window, the gesture is used to change the center frequency.
- Swipe vertically in the trace window, the gesture is used to change reference level.
- Pinch and stretch to change the span parameter.
- Double tap on the trace window to add a new marker.
- Tap and drag on the marker icon, the gesture is used to change the marker position.
- Draw a "x" to delete all markers.
- Swipe up or down vertically in the **"Measurement Result View"** to hide or unhide the measurement result view display.
- In the file manager dialog, swipe horizontally to the left or right direction to preview screenshots.
- In the wizard measurement mode, swipe horizontally to the left direction to skip a wizard measurement.

4.3.1 Title Bar

The "Title bar" is located on top of the layout.



It is used to display static content:

- Basic information such as R&S logo, measurement mode name (i.e. "Spectrum", "Power Meter") and battery status.
- Accessories name connected to the instrument, i.e power sensor, GPS receiver.
- Standard information such as measurement standard name and channel table name.

4.3.2 Measurement Result View

Special touchscreen gesture

You can swipe vertically up or down in the "Measurement result view" to hide or unhide the measurement result view display.

For more information, see the "Touchscreen Gesture Element" in the R&S Spectrum Rider user manual

The "Measurement result view" is located below the "Title bar".

GPS	1°20'20.022" N	103°57'53.238" E	52.5 m	Satellites	9
M1 Frequency Count	511.7887741 MHz				
M1	511.8033803 MHz	59.1 dB μ V/m	D2	-489.268169 MHz	20.4 dB μ V/m
D3	396.8952113 MHz	1.9 dB μ V/m	D4	2.378337465 GHz	17.5 dB μ V/m
D5	1.941348169 GHz	11.1 dB μ V/m	D6	2.828953803 GHz	-12.4 dB μ V/m
Upper Limit Threshold	-51 dBm	T 1	FAIL		
Lower Limit Threshold	-80 dBm	T 1	PASS		
Channel Table	DL PCS 1900				



It displays measurement results of the followings:

- [GPS information](#)
- Marker values
 - Including marker function such as marker noise measurement, frequency counter and N dB down bandwidth measurement when activated.
- Limit lines
- Channel table

When the marker measurement is enabled and selected in the "Measurement result view", an entry box for marker positioning is displayed. On the selected marker, you can also see that the function measurement result is displayed in the "Measurement result view", e.g. "Frequency Count".

The selected marker is highlighted in the "Measurement result view", it is also reflected on the marker in the "Measurement trace window".

Table 4-1: Highlighted marker

Highlighted marker in the "Measurement result view"	Highlighted marker in the "Measurement trace window"
	 Note: There is a blue frame on the highlighted "M1" marker.

For more information on marker measurement, see ["Using markers"](#) on page 80.

4.3.3 Measurement Trace Window

The "Measurement trace window" is the main user interface window in R&S Spectrum Rider. It displays the measurement traces where markers and limit lines are also displayed.

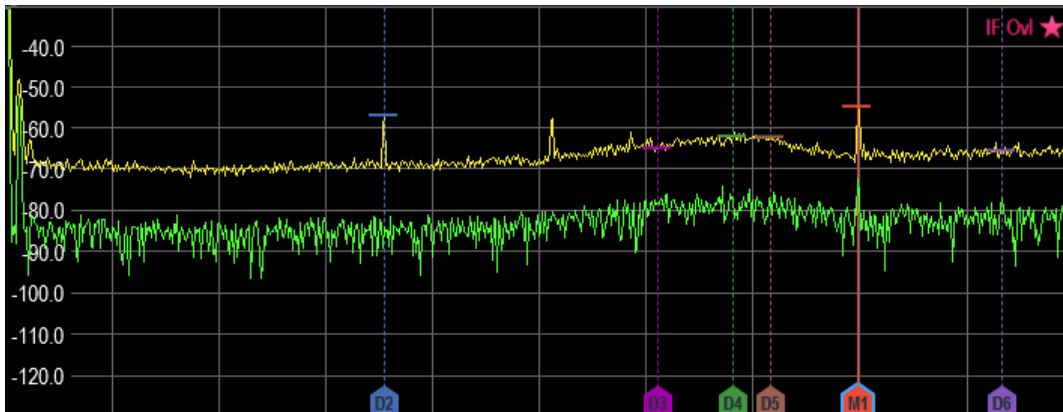

Device warning messages (e.g IF Ovl) are displayed at the top right-hand corner of the window.

NOTICE

Device Warning Message







- IF Ovl: This message indicates that the downconverter of the intermediate frequency (IF) is overloaded in R&S Spectrum Rider.
- In general, a star ★ indicates that the measurement is still in progress.





4.3.4 Parameter View

The "Parameter view" contains the important trace setting parameters for the spectrum measurement.

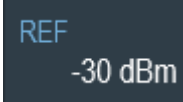
It is located at the right side and bottom section of the layout . See [Figure 4-2](#).

You can select any parameter in the "Parameter view" to adjust the configurations of the spectrum measurement. See details of each of the parameter in the R&S Spectrum Rider user manual.

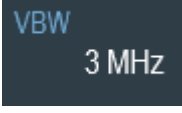
Parameter settings	Description
"Center", "Start", "Stop" 	This display setting is function-specific depending on the softkey ("Center Freq", "Start Freq", "Stop Freq") indicated in the softkey label. See Chapter 4.5.3, "Softkey" , on page 40. It displays an entry box to configure the center frequency, start or stop frequency for the spectrum measurement.
"Trace" 	Select "Trace" to display the trace menu with a list of settings ("Clear/Write", "Average", "Min Hold", "Max Hold").
"Detect" 	Select "Detect" to display the trace detector menu with a list of settings ("Auto Peak", "Max Peak", "Min Peak", "Sample", "RMS").
"Trig" 	Select "Trig" to display the gate trigger menu with a list of settings ("Free Run", "Ext. Rise", "Ext. Fall").
"Span" 	Select "Span" to display an entry box to configure the span of the spectrum measurement.
"Time & Date" 	Time and date of the instrument. This field is a read-only field. See Chapter 4.7.4, "Configuring Date and Time" , on page 57.
"REF" 	Select "REF" to display an entry box to configure the reference level for the spectrum measurement.

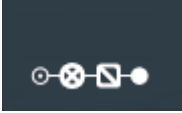
<p>"ATT"</p> 	<p>Select "ATT" to display an entry box to configure the attenuation setting for the spectrum measurement.</p>
<p>"PA"</p> 	<p>Select "PA" to toggle between the "ON" and "OFF" status for the optional preamplifier (R&S FPH-B22) of the spectrum measurement.</p> <p>Note: When the optional preamplifier (R&S FPH-B22) is absent, this menu is not available.</p>
<p>"RBW"</p> 	<p>Select "RBW" to display an entry box to configure the resolution bandwidth of the spectrum measurement.</p>
<p>"VBW"</p> 	<p>Select "VBW" to display an entry box to configure the video bandwidth of the spectrum measurement.</p>
<p>"SWT"</p> 	<p>Select "SWT" to display an entry box to configure the sweep time of the spectrum measurement.</p>
<p>"Config Overview"</p> 	<p>Select "Config Overview" to display the configuration overview window for more configuration options for the spectrum measurement. See Chapter 4.3.4.1, "Configuration Overview", on page 36.</p>

4.3.4.1 Configuration Overview

The "Config Overview" is a dedicated button located at the bottom of the "Parameter View", it is operation mode dependent. See [Figure 4-2](#).

When you select this button, it opens the "Config Overview" window. Accessing it without the touchscreen input is possible via the [SETUP] key. See [Chapter 4.5.4, "System Keys"](#), on page 40.

The "Config Overview" illustrates the flow of spectrum measurement at different stages and the relevant parameters which have impact on the measurement at each stage.

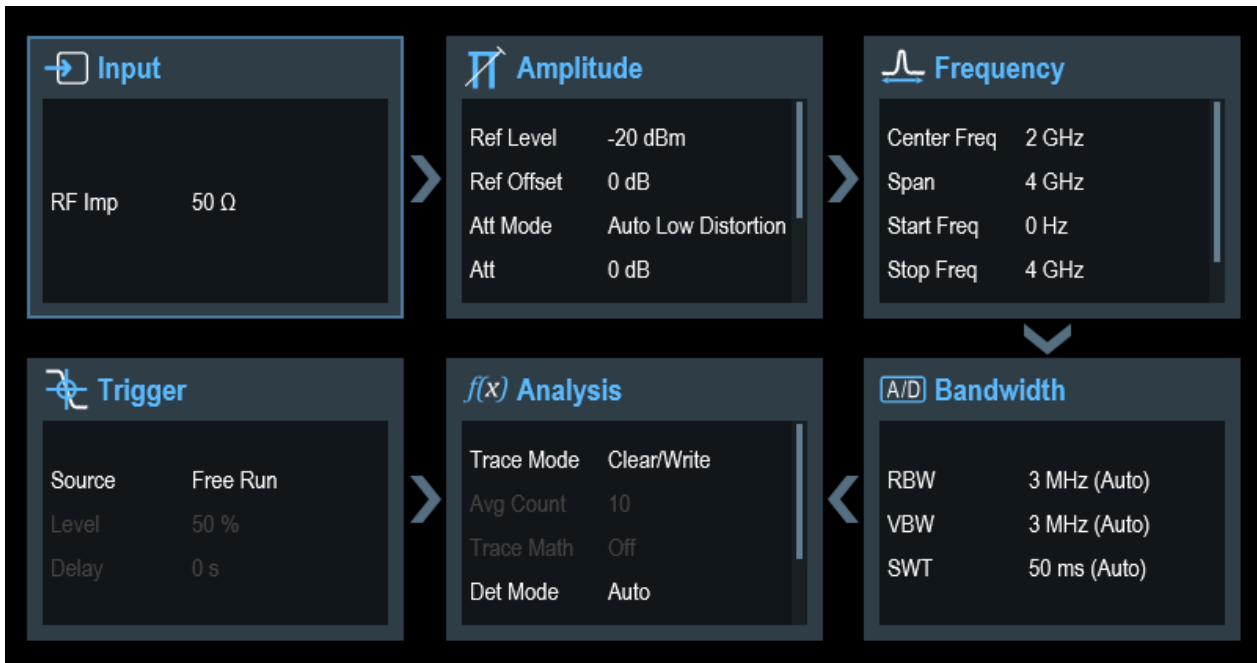

The "Config Overview" window is divided into six categories:

Table 4-2: Corresponding dialog box of "Config Overview" window

"Config Overview" block	Corresponding dialog box	Description
		Select "Input" to configure RF impedance.
		Select "Amplitude" to configure reference level, reference offset, preamplifier (R&S FPH-B22, order number 1321.0680.02), RF attenuation level and mode. It also provides configuration to set the transducer table used in the signal measurement. Note: When the optional preamplifier (R&S FPH-B22) is absent, the menu item "RF Preamplifier" is not available.

Touchscreen Display

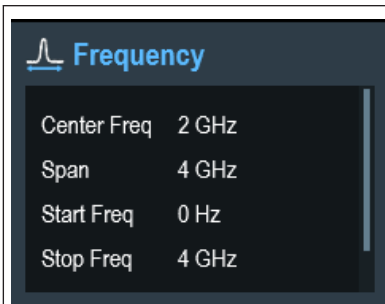

Frequency

- Center Freq 2 GHz
- Span 4 GHz
- Start Freq 0 Hz
- Stop Freq 4 GHz

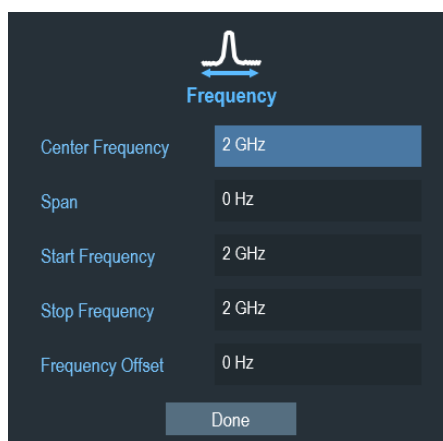

Frequency

- Center Frequency 2 GHz
- Span 0 Hz
- Start Frequency 2 GHz
- Stop Frequency 2 GHz
- Frequency Offset 0 Hz

Done

Select "Frequency" to configure the center frequency, frequency offset and span of the spectrum measurement.



A/D Bandwidth

- RBW 3 MHz (Manual)
- VBW 300 kHz (Manual)
- SWT 102 ms (Manual)

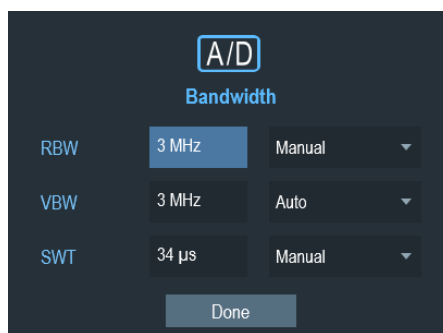

A/D Bandwidth

- RBW 3 MHz Manual
- VBW 3 MHz Auto
- SWT 34 μ s Manual

Done

Select "Bandwidth" to configure resolution bandwidth, video bandwidth and sweep time for the spectrum measurement.

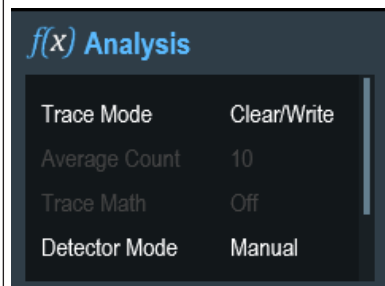

f(x) Analysis

- Trace Mode Clear/Write
- Average Count 10
- Trace Math Off
- Detector Mode Manual

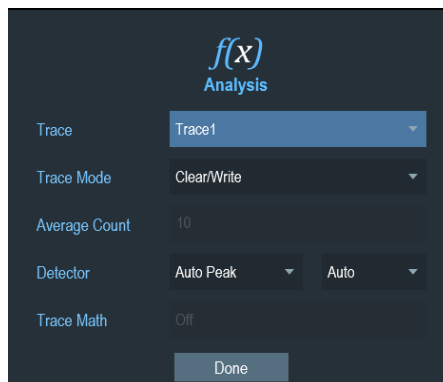

f(x) Analysis

- Trace Trace 1
- Trace Mode Clear/Write
- Average Count 10
- Detector Auto Peak Auto
- Trace Math Off

Done

Select "Analysis" to configure trace mode, trace detector and the number of count used to average up the measurement for the trace display.

It also provides configuration to set the "Trace Math" method used to calculate the differences in the current trace measurement and measurement saved in the memory.



Trigger

- Source External Rise
- Level 50 %
- Delay 0 s

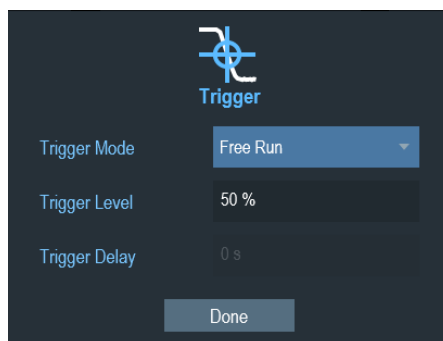

Trigger

- Trigger Mode Free Run
- Trigger Level 50 %
- Trigger Delay 0 s

Done

Select "Trigger" to configure the trigger source, trigger level and the trigger delay setting on the spectrum measurement.

4.4 On-screen Keyboard

The on-screen keyboard is an additional means of interacting with the instrument. It provides convenience of usage with the touchscreen input.

Accessing the on-screen keyboard is only available for text-based entry, e.g. save or open a filename.

Touchscreen interface

If the [touchscreen interface](#) is not activated, the on-screen keyboard is disabled.



The on-screen keyboard display can be switched on and off using the on-screen keyboard  icon highlighted at the top right-hand corner.

4.5 Front Panel Keys

The following chapters illustrate the function of the front panel keys.

4.5.1 POWER Key

The [POWER]  key is located on the lower left of the front panel. It starts up and shuts down the instrument.

See [Chapter 3.2, "Switching the Instrument On and Off"](#), on page 19.

See also [Chapter 4.1, "Overview Control"](#), on page 23.

4.5.2 Screenshot Key

The screenshot  key provides a quick way to capture screenshot of the current screen at anytime.

For more information, see "Taking Screenshots" in the R&S Spectrum Rider user manual.

4.5.3 Softkey

The six softkeys on the front panel are used to access the softkey label. See [Chapter 4.1, "Overview Control"](#), on page 23.



The softkey label is function-specific depending on the key selected on the front panel of the instrument. See [Chapter 4.5.5, "Function Keys"](#), on page 41.

4.5.4 System Keys

System keys provide settings affecting the general instrument settings, result evaluation settings and save and recall functions.



For more information, see the corresponding functions in the R&S Spectrum Rider user manual.

SYSTEM keys	Descriptions
[PRESET]	Resets the instrument to the default state.
[SETUP]	Provides basic instrument configuration functions: <ul style="list-style-type: none"> • Reference frequency (external/internal) and hardware selection • Date, time, display, audio and regional configuration • Battery low indicator • LAN interface • Disabling and enabling of options • Information about instrument configuration including firmware version and system error messages • Internal alignment
[MODE]	Provides the selection between applications. <ul style="list-style-type: none"> • "Spectrum" • "Digital Demo" • "Analog Demo" • "Receiver" • "Power Meter" • "Maps"
[LINES]	Configures display line and limit lines.
[SAVE RECALL]	Provides a file manager function to facilitate the saving and recalling of result and instrument settings.

4.5.5 Function Keys

Function keys provide access to the most common measurement settings and functions in the instrument.

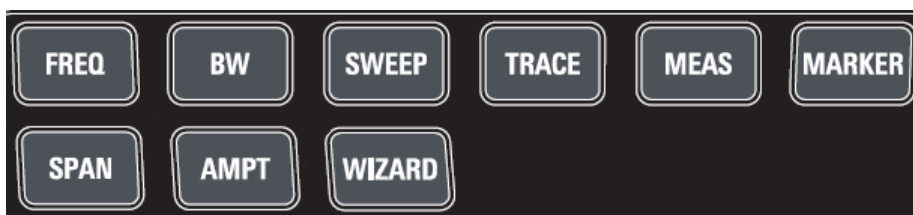

For more information, see the corresponding functions in the R&S Spectrum Rider user manual.

FUNCTION keys	Descriptions
[FREQ]	Sets the center frequency, frequency step size, frequency offset as well as the start and stop frequencies for the frequency range under consideration.
[SPAN]	Sets the frequency span to be analyzed.

FUNCTION keys	Descriptions
[AMPT]	<p>Sets the reference level, the displayed dynamic range, the RF attenuation and the unit for the level display.</p> <p>Sets the level offset and the input impedance.</p> <p>Activates the preamplifier (R&S FPH-B22, order number 1321.0680.02).</p> <p>Sets transducer tables to compensate primary and secondary RF path losses.</p>
[WIZARD]	Performs a sequence of standardized and recurring measurements.
[BW]	Sets the resolution bandwidth and the video bandwidth.
[SWEEP]	<p>Sets the sweep time.</p> <p>Sets the trigger mode, trigger threshold and the trigger delay of the external trigger signal.</p> <p>Selects continuous measurement or single measurement.</p>
[TRACE]	Configures the measured data acquisition and the analysis of the measurement data.
[MEAS]	<p>Mode-dependent button.</p> <p>This key provides functionality to select and configure measurements in the available measurement modes.</p> <p>For more information, see the corresponding measurement modes in the R&S Spectrum Rider user manual.</p>
[MARKER]	<p>Mode-dependent button.</p> <p>Sets and positions the absolute and relative measurement markers (markers and delta markers).</p> <p>Marker positioning using peak, next peak, minimum level, reference level and center frequency.</p> <p>Marker search limit function.</p> <p>Enables or disables checkbox for "View List" function.</p> <p>Provides the following marker functions:</p> <ul style="list-style-type: none"> • Marker mode function which provides capability to measure noise, measure frequency using frequency counter and measure bandwidth using the N dB down setting. • Marker display setting using the frequency or channel table. • AM and FM marker demodulation.

4.5.6 Keypad

The keypad is used to enter alphanumeric parameters, including the corresponding units.

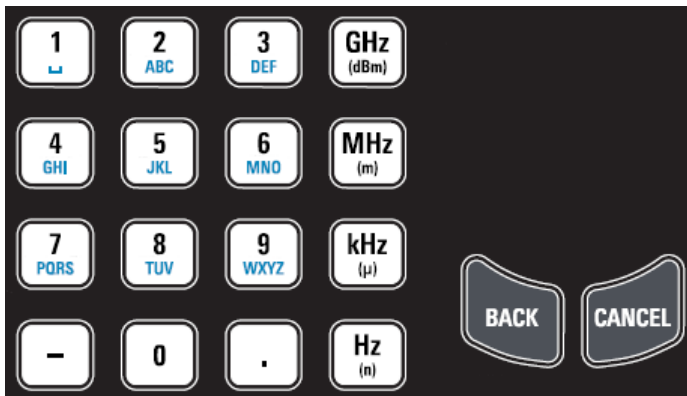

It contains the following keys:

Type of key	Description
Alphanumeric keys	Enter numbers and (special) characters in edit dialog boxes.
Decimal point	Inserts a decimal point "." at the cursor position.
Sign key	Changes the sign of a numeric parameter. In the case of an alphanumeric parameter, inserts a "-" at the cursor position.
Unit keys (GHz/-dBm MHz/ dBm, kHz/dB and Hz/dB)	These keys add the selected unit to the entered numeric value and complete the entry. In the case of level entries (e.g. in dB) or dimensionless values, all units have the value "1" as multiplying factor. Thus, they also act like an enter key function.
CANCEL key	Closes all kinds of dialog boxes, if the edit mode is not active. Quits the edit mode, if the edit mode is active. In dialog boxes that contain a "Cancel" button it activates that button. For "Edit" dialog boxes the following mechanism is used: <ul style="list-style-type: none"> • If data entry has been started, it retains the original value and closes the dialog box. • If data entry has not been started or has been completed, it closes the dialog box.
BACK key	If an alphanumeric entry has already been started, this key deletes the character to the left of the cursor. Note: If an entry is confirmed with enter key, this key restores the value entered before. This action can be used to toggle, for example, between two frequencies.

4.5.7 Navigation Controls

The rotary knob provides navigation controls in the display or within dialog boxes.



The rotary knob has several functions:

- Increments (clockwise direction) or decrements (counter-clockwise direction) the instrument parameters at a defined step width in the case of a numeric entry
- Shifts markers, limit lines and display line on the screen
- Acts like a cursor key in dialog boxes or softkey submenus.
- Moves the scroll bar vertically if the scroll bar is in focused
- Acts as an enter key when pressed

4.6 Managing Options

For special measurement tasks, you can equip the R&S Spectrum Rider with various firmware options.

4.6.1 Enabling Options

To enable options, you have to enter a key code. The key code is based on the unique serial number of the R&S Spectrum Rider.

1. Press [SETUP] key.
2. Select "Installed Options" softkey.
A list of all available options and the current status of the options is displayed. See [Chapter 3.3, "Checking the Supplied Options"](#), on page 20.
3. Select the "Install Option" menu item from the dialog box.
The R&S Spectrum Rider opens an entry field to enter the option key.

4. Enter in the appropriate option key.
5. Confirm the entry with the rotary knob.
If you have entered the correct code, the instrument displays a "installation successful" message.
If incorrect code is entered, the instrument displays a "invalid key code!" message.
6. Enter the correct code again.

4.6.2 Checking Options

In the "Setup" menu, the R&S Spectrum Rider shows all options that are currently installed.

1. Press [SETUP] key.
2. Select "Installed Options" softkey.
The R&S Spectrum Rider shows a list of all available options and the current status of the option:
 - "Installed": This means that the option is installed and working.
 - "Demo": This means that the option is for demo purposes and it has an expiry date.
 - "Removed:<option key>": This indicates that a portable license has been removed and is ready to be transferred to another R&S Spectrum Rider.

4.6.3 Managing Options with R&S License Manager

If you are using the R&S Spectrum Rider in a local area network (LAN), you can manage the firmware options with a web browser (e.g. Microsoft Internet Explorer or Mozilla Firefox).

For more information on connecting the R&S Spectrum Rider to a LAN, see [Chapter 4.8.1, "LAN Connection"](#), on page 69.

After you have connected the R&S Spectrum Rider, open your web browser.

1. Enter the IP address of the R&S Spectrum Rider in the address bar of the web browser.



Managing Options

The browser accesses the R&S License Manager. In this part of the R&S License Manager, you can install and activate licenses on the R&S Spectrum Rider.

This page features three areas:

- The first area shows the details of the connected device including the device ID and the IP address.

Connected Device

FPH	Device ID:	1321.1111K02-900188-nK
FPH	IP Address:	10.113.10.184
Version: V1.00	Host Name:	localhost

- The second area provides functionality to install and activate licenses.

What do you want to do?

- [Install Registered License Keys and Activate Licenses](#) ⓘ
- [Register Licenses, Install License Keys and Activate Licenses](#) ⓘ
- [Reboot Device](#) ⓘ

- "Install Registered License Keys and Activate Licenses"
Follow this link if you have purchased a registered license. Registered licenses only work in combination with a specific device ID.
 - "Register Licenses, Install License Keys and Activate Licenses"
Follow this link if you have purchased an unregistered license. Unregistered licenses are not connected to a specific device ID.
 - "Reboot Device"
Follow this link to reboot the R&S Spectrum Rider.
 - Online help icon ⓘ
Opens a detailed online help to the corresponding topic.
- The third area provides hints on using the license manager when you move the mouse over one of the options.

Help

Reboot Device:

Many devices need to be rebooted, before newly installed license keys can activate the licenses on these devices.

Use "Reboot Device" to allow the R&S License Manager to remotely reboot a device, which is accessible via LXI. You will be requested to select the Device ID of the applicable device.

If you already have one or more R&S Spectrum Rider equipped with options, you can manage the licenses of these options on the license manager web page.

2. Select the **Manage Licenses** button.

Configuring the R&S Spectrum Rider

The browser accesses another part of the R&S License Manager. In this part of the license manager, you can manage licenses already installed on your R&S Spectrum Rider.

This page features two areas:

- The first area provides functionality to manage licenses already installed on a device.

What do you want to do?

- [Register Licenses](#) 
- [Unregister License](#)  
- [Move Portable License](#) 

- "Register Licenses"
Follow this link if you have purchased an unregistered license. Unregistered licenses only work in combination with a specific device ID.
- "Unregister License"
Follow this link if you have installed a portable license. Portable licenses work in combination with several device IDs. However, you have to unregister it on one device before you can use it on another.
- "Move Portable License"
Follow this link if you want to move a portable license. Moving a portable license is possible without unregistering the license.
- Online help icon 
Opens a detailed online help to the corresponding topic.
- The second area provides hints on using the R&S License Manager when you move the mouse over one of the options.

After you have followed one of the links, follow the instructions displayed in the browser. If you encounter any problems during the licensing procedure, you can access the online help at any time with the online help icon . The online help contains an extensive description of all functionality that the license manager features.

4.7 Configuring the R&S Spectrum Rider

SETUP

In the "Instrument Setup" dialog box, the R&S Spectrum Rider provides various general settings that are independent of the operating mode of the R&S Spectrum Rider.

Configuring the R&S Spectrum Rider

1. Press [SETUP] key.
 2. Select "Instrument Setup" softkey.
A corresponding dialog box to configure the instrument opens.
 3. Select the item you want to modify.
- [Configuring the Hardware](#)..... 48
 - [Configuring Antennas](#).....49
 - [Using the GPS Receiver](#)..... 54
 - [Configuring Date and Time](#)..... 57
 - [Selecting Regional Settings](#)..... 58
 - [Configuring the Display](#)..... 59
 - [Configuring the Audio Output](#)..... 62
 - [Configuring Power Supply](#)..... 63
 - [Internal Alignment](#)..... 65
 - [Resetting the R&S Spectrum Rider](#)..... 67

4.7.1 Configuring the Hardware

The hardware settings provide settings that control internal and connected hardware.

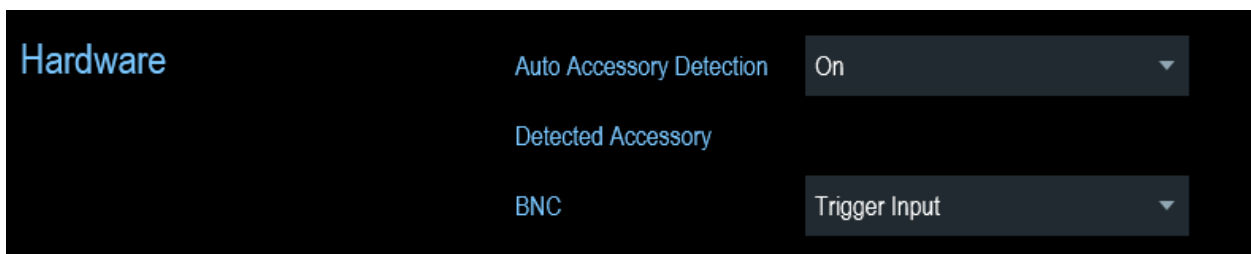

Using auto accessory detection

If you are using any accessories while working with the R&S Spectrum Rider, the instrument is able to identify the connected hardware. To enable this setting:

1. In the "Instrument Setup" dialog box, select the "Auto Accessory Detection" item.
A drop-down menu to select the accessory detection opens.
2. Set "Auto Accessory Detection" to "On".
When this feature is on, the name of the connected accessory is displayed in the "Detected Accessory" field.

Configuring the BNC connector

You can use the BNC connectors for various applications. For more information on the supported applications, see [Chapter 4.2.2, "BNC Connector"](#), on page 26.

1. In the "Instrument Setup" dialog box, select the "BNC" item.
A drop-down menu to select the BNC connector application opens.

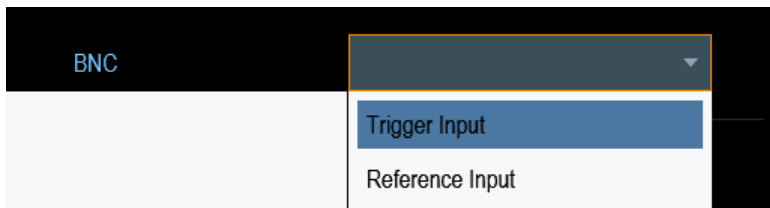

2. Select the required application.

4.7.2 Configuring Antennas

You can use the log-periodic antenna (R&S HL300, order number 4097.3005.02), active directional antenna (R&S HE300, order number 4067.5900.02) or the directional antenna (R&S HE400, order number 4104.6000.02) with the R&S Spectrum Rider to locate potential interfering sources.

For a comprehensive description of the antennas and their functionality, refer to the user manuals delivered with the product.

Both antennas are embedded with a GPS receiver and an electronic compass. You can control the GPS receiver of the antennas as described in [Chapter 4.7.3, "Using the GPS Receiver"](#), on page 54.

To work with both antennas, you need a USB adapter (R&S HE300USB, order number 4080.9440.02) to connect the antennas control cable to the USB interface of the R&S Spectrum Rider.

The "Instrument Setup" dialog box provides all settings necessary to control the antenna.

Configuring the R&S Spectrum Rider

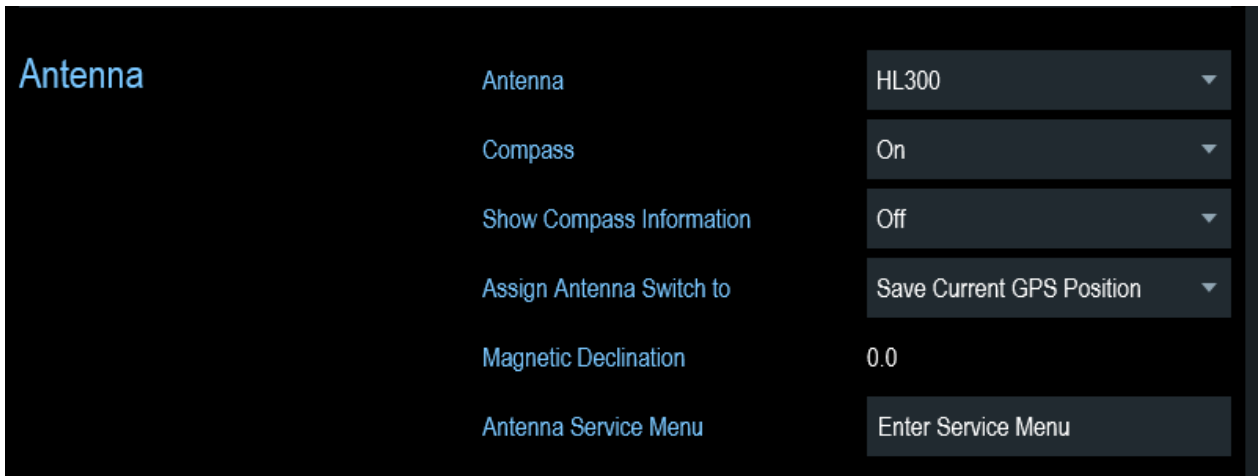

Enabling the antenna

1. In the "Instrument Setup" dialog box, select the "Antenna" menu item. A drop-down menu to select the antenna opens.

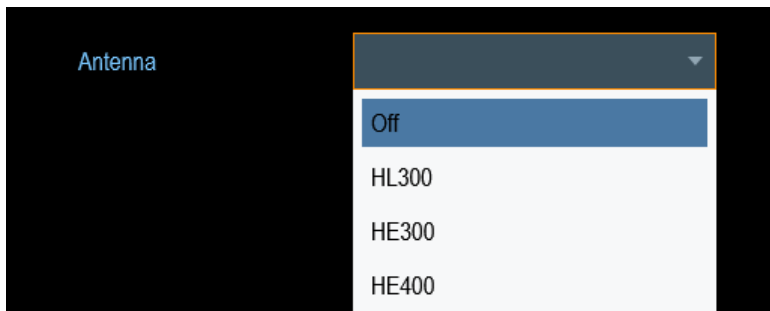

2. Select the "HL300", "HE300" or "HE400" "Antenna" menu item. The R&S Spectrum Rider enables the selected antenna.
Note: The "Auto Accessory Detection" menu item in the "Hardware" section turns off when an antenna is selected.

Enabling the compass

The antennas feature an electronic compass to determine directions precisely.

1. In the "Instrument Setup" dialog box, select the "Compass" item. A drop-down menu to enable or disable the compass opens.

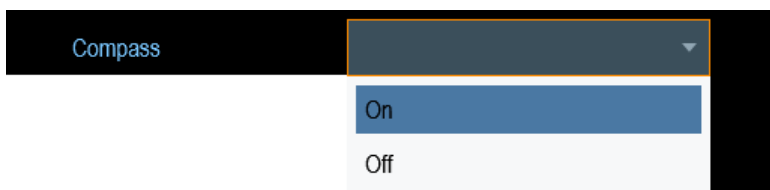

Configuring the R&S Spectrum Rider

2. Select "On" to enable the compass.

The R&S Spectrum Rider shows the magnetic declination of your current position in the "Magnetic Declination" menu item when you turn on the compass.

Showing compass information

1. In the "Instrument Setup" dialog box, select the "Showing Compass Information" menu item.

A drop-down menu to enable or disable the display of compass information opens.

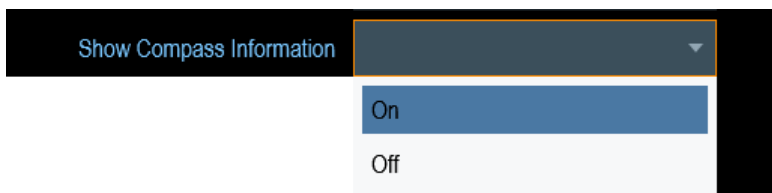

2. Select "On" to enable the display of compass information.

The R&S Spectrum Rider displays the compass information at the top of the map display.

Assigning functions to the toggle switch

The R&S HL300 and HE400 has a toggle switch on its handle that you can assign to one of the following functions:

1. In the "Instrument Setup" dialog box, select the "Assign Antenna Switch" menu item.

A drop-down menu to select the function of the antenna toggle switch opens.

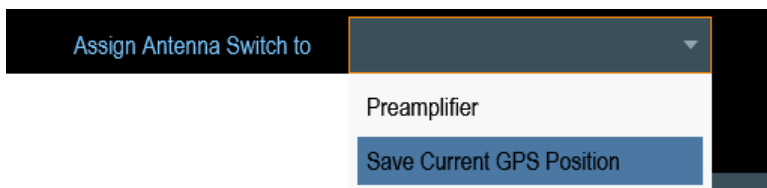

- a) "Preamplifier"

Using the toggle switch turns the preamplifier on and off.

- b) "Save current GPS position"

Using the toggle switch tags your current position in the map material.

2. Select the required function.

Calibrating the antenna

-  If you need to know technical specification about the antenna, for example for service or support, you can get the necessary information from the "Antenna Service Menu" provided in the R&S Spectrum Rider.

The "Antenna Service Menu" contains functionality to calibrate the antenna.

1. In the "Instrument Setup" dialog box, select the "Antenna Service Menu" item to activate the antenna service menu.

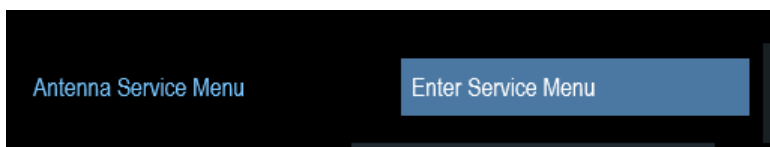

The R&S Spectrum Rider informs you that the antenna is disabled to determine the antenna information.

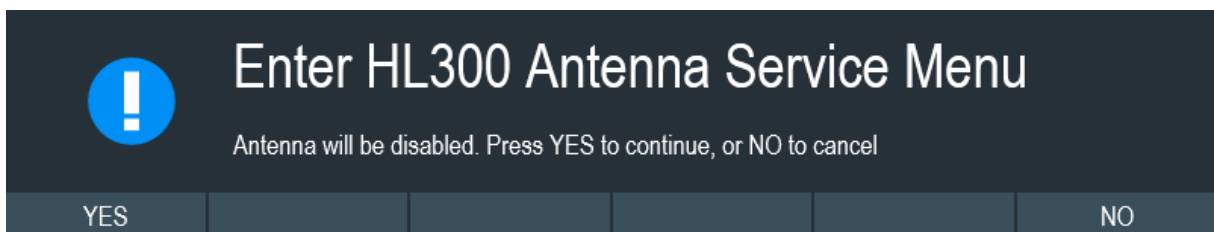

2. Select "YES" softkey.
The R&S Spectrum Rider tries to determine the antenna characteristics. It shows the results in a dialog box.

Current Antenna		
Antenna Name		HL300
Antenna Code		25
Software Version		V3.00

3. Select the "Calibrate" softkey.

Configuring the R&S Spectrum Rider

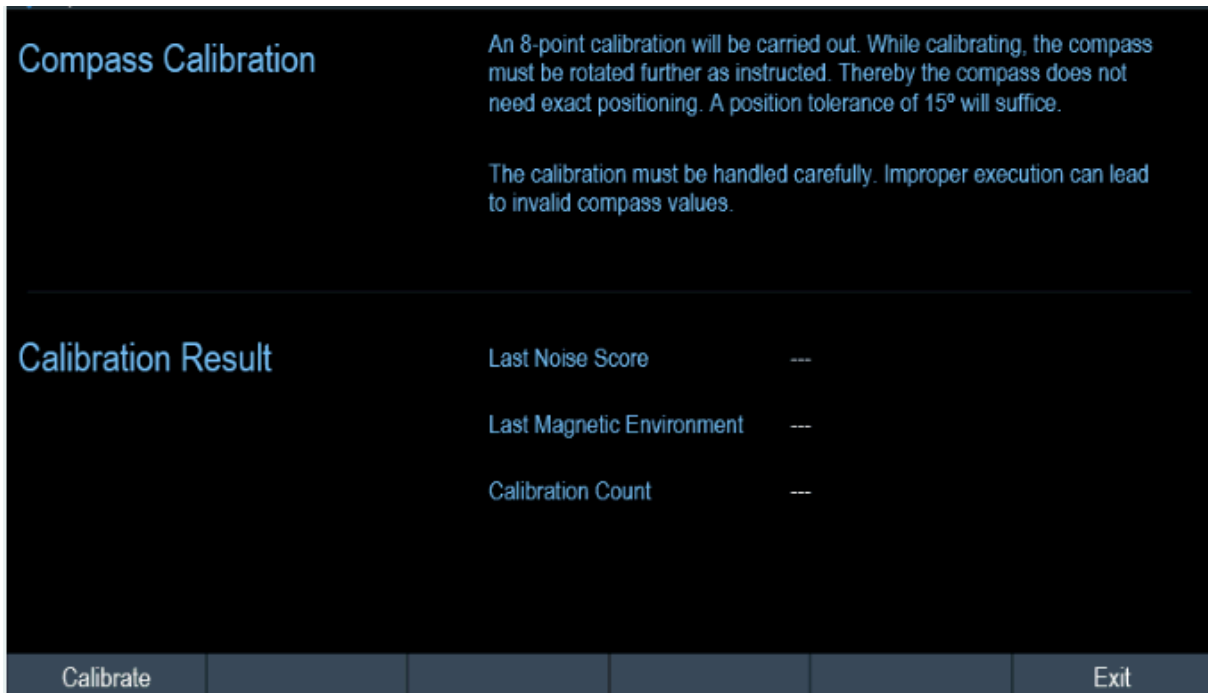

The R&S Spectrum Rider starts the calibration.

For antenna calibration, it is necessary to move the antenna according to the direction as instructed on the screen.

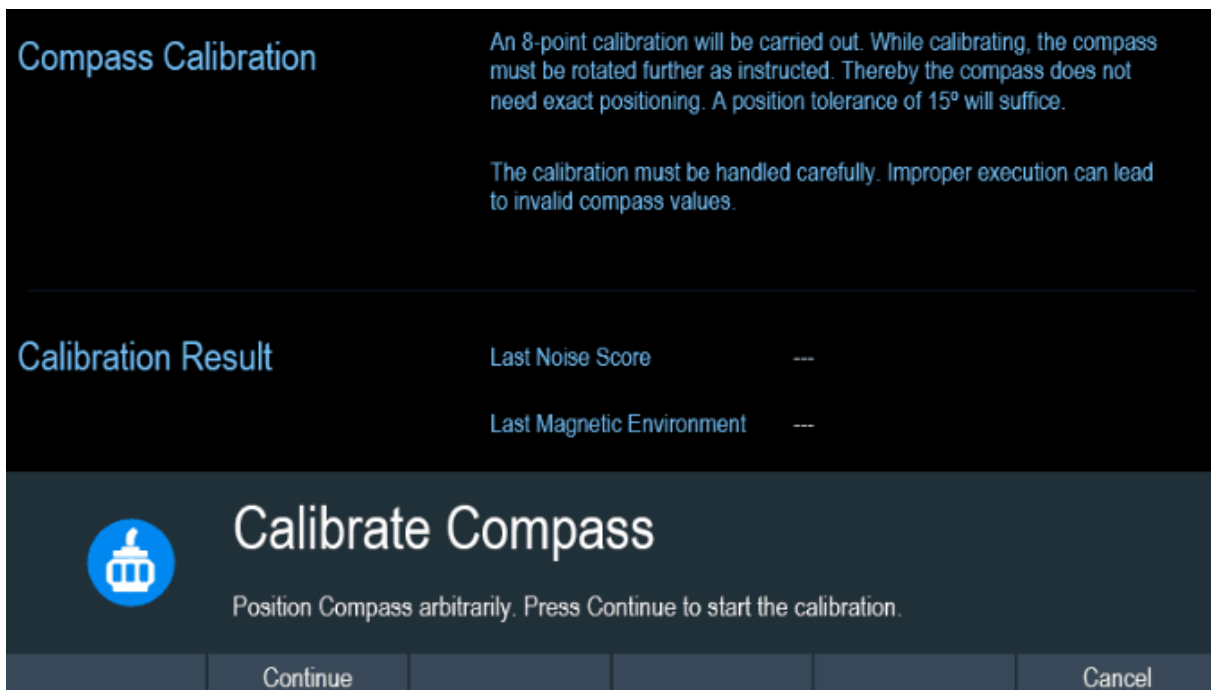

- When calibration completes, the R&S Spectrum Rider displays a "Calibration Successful" message.
The R&S Spectrum Rider displays the calibration result.

Configuring the R&S Spectrum Rider

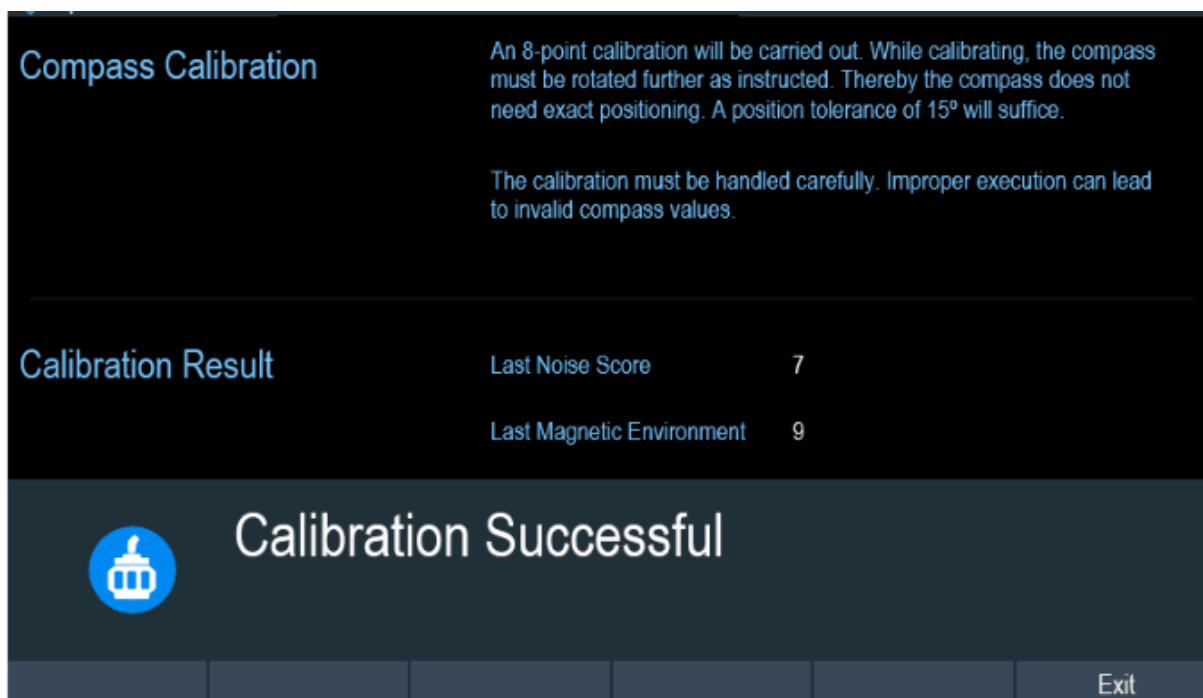

4.7.3 Using the GPS Receiver

The R&S Spectrum Rider can locate your exact position if you connect the GPS receiver (R&S HA-Z340, order number 1321.1392.02) to the USB connector.

Location to secure GPS receiver (R&S HA-Z340)

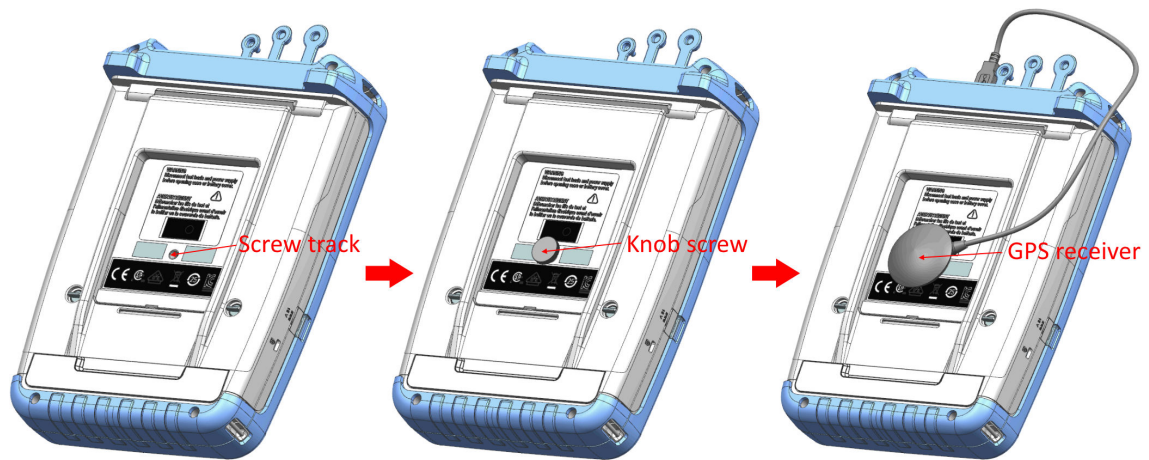
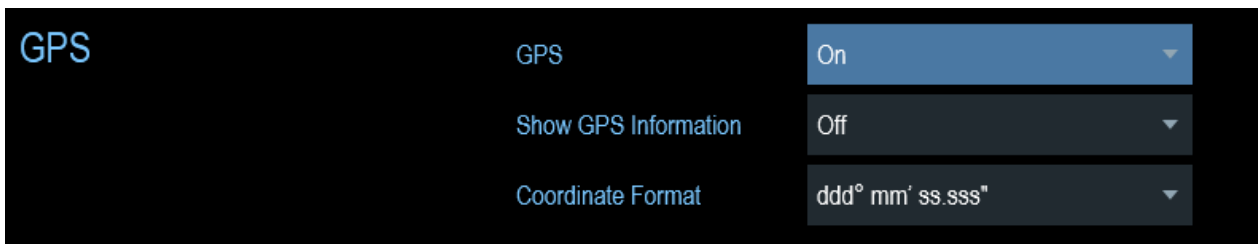

Figure 4-3: Location of GPS receiver

- Tighten the knob screw supplied with the GPS receiver to the screw track at the back of R&S Spectrum Rider.
- The GPS receiver can be conveniently attached to the knob screw as shown in [Figure 4-3](#).

The "Instrument Setup" dialog box provides all settings necessary to configure the GPS receiver.



Enabling the GPS receiver

1. In the "Instrument Setup" dialog box, select the "GPS" item. A drop-down menu opens to turn the GPS receiver on or off.
2. Turn the GPS receiver on or off as required.

When "GPS" item is turned on, the R&S Spectrum Rider is ready to receive GPS data.

Displaying GPS information

1. In the "Instrument Setup" dialog box, select the "Show GPS Information" item. A drop-down menu opens to turn the display of the GPS information on and off.
2. Turn the display of GPS information on or off as required.

When the "Show GPS Information" item is set on, the R&S Spectrum Rider displays the GPS coordinates and number of satellites in the [Measurement Result View](#) when sufficient connection is established to the GPS satellites.

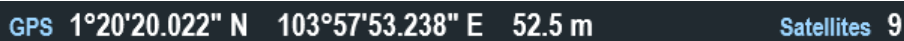

GPS 1°20'20.022" N 103°57'53.238" E 52.5 m Satellites 9

When the satellite connection is lost, the GPS coordinates and number of satellites are displayed with a white bar.

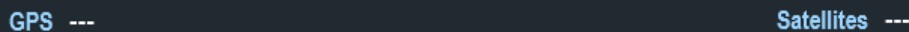

GPS --- Satellites ---

When the GPS receiver is not connected or enabled, a message "GPS Not Connected" is displayed in the [measurement result view](#).

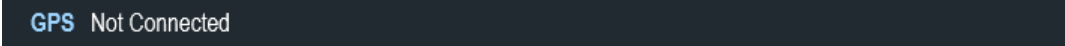

GPS Not Connected

The state of the satellite lock shown in the title bar is illustrated as follows.

- **GPS** indicates that the GPS receiver is enabled and that there is a fix connection with enough satellites for the GPS receiver to provide the coordinates.
- **GPS** indicates that the GPS receiver is enabled but that there is no fix connection to a satellite.
- **GPS** indicates that the GPS receiver is enabled but that there is no GPS receiver connection.
- The title bar shows no symbol if the GPS receiver is not enabled

Selecting the coordinate format

1. In the "Instrument Setup" dialog box, select the "Coordinate Format" item. A drop-down menu opens to select the coordinate format.

Configuring the R&S Spectrum Rider

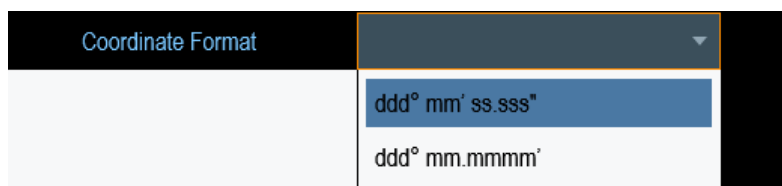

2. Select the coordinate format from the drop-down menu.

4.7.4 Configuring Date and Time

The R&S Spectrum Rider has an internal clock that can apply a date and time-stamp. In the "Instrument Setup" dialog box, you can set both date and time.

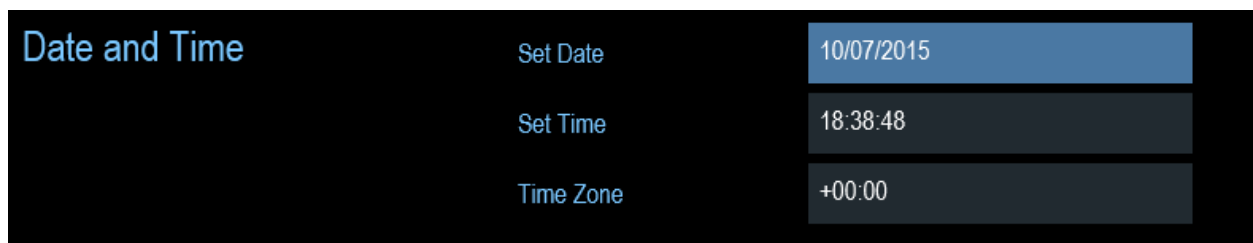

Setting the date

1. In the "Instrument Setup" dialog box, select the "Set Date" item.
2. Enter the date you want with the numeric keys. The sequence depends on the selected date format. See ["Setting the date format"](#) on page 59.



3. Confirm the entry with the rotary knob.

Setting the time

1. In the "Instrument Setup" dialog box, select the "Set Time" item.
2. Enter the time you want with the numeric keys.

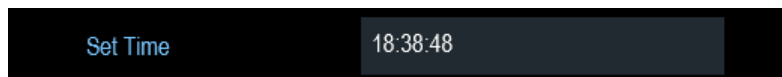

3. Confirm the entry with the rotary knob.
After you have entered the time, the R&S Spectrum Rider verifies the validity of the time. If it is not a valid time, it sets to the next valid time.

Selecting the time zone

1. In the "Instrument Setup" dialog box, select the "Time Zone" item.
2. Enter a positive or negative time offset relative to the system time with the numeric keys.

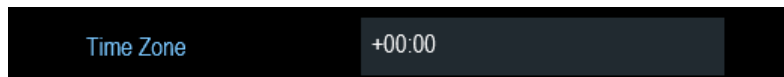

3. Confirm the entry with the rotary knob.
After you have confirmed the time zone, the R&S Spectrum Rider adjusts the displayed time accordingly without changing the system time.

4.7.5 Selecting Regional Settings

The regional setting allows you to select a different language and date format.

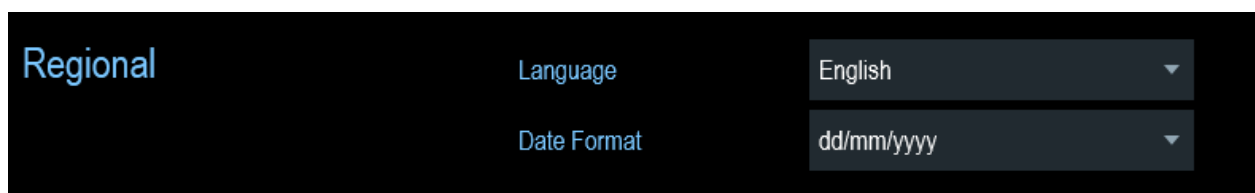

Setting the language

The R&S Spectrum Rider supports several languages for the user interface.

The following is a list of languages that the instrument supports:

English	Spanish	Japanese	Russian
French	Italian	Chinese	Hungarian
German	Portuguese	Korean	Traditional Chinese

1. In the "Instrument Setup" dialog box, select the "Language" item.
A drop-down menu opens to select the language.

Configuring the R&S Spectrum Rider



2. Select the desired language from the drop-down menu.
3. Reboot the device to activate the choice of selected language.

Setting the date format

The R&S Spectrum Rider provides two different formats to display the date.

1. In the "Instrument Setup" dialog box, select the "Date Format" item. A drop-down menu opens to select the date format.



2. Select the required date format from the drop-down menu.

4.7.6 Configuring the Display

The display setting configures the display characteristics and the touch interface.

Configuring the R&S Spectrum Rider

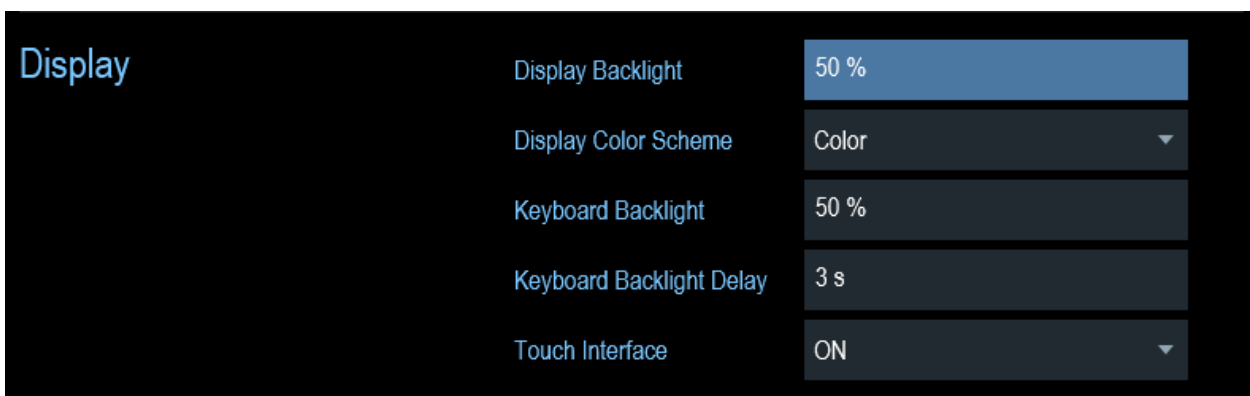

The display of the R&S Spectrum Rider is a TFT color LCD display.

The ideal brightness of the display depends on the intensity of the backlight. To strike a balance between battery operating time and screen display quality, set the backlight intensity to the minimum brightness needed.

To optimize the viewing angle, adjust the display color scheme settings. To achieve the maximum contrast, the screen can be switched from color display to black-and-white display.

The intensity of the keyboard backlight is adjustable with a time delay setting to turn off the backlight. The keyboard backlight remains on until the time specified by the "Keyboard Backlight Delay" or a subsequent key is pressed.

Adjusting the display backlight

1. In the "Instrument Setup" dialog box, select the "Display Backlight" item.
2. Enter the backlight intensity you want with the numeric keys.



The backlight intensity is a percentage from 0% to 100% with 100% being the brightest.

3. Confirm the entry with the rotary knob.

Adjusting the display color scheme

1. In the "Instrument Setup" dialog box, select the "Display Color Scheme" item. A drop-down menu opens to select the display color scheme.

Configuring the R&S Spectrum Rider

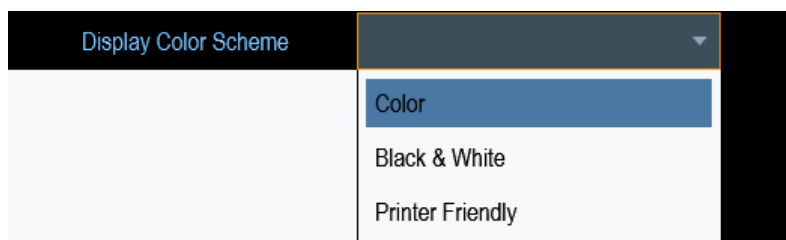

2. Select the color scheme from the drop-down menu.
 - a) "Color" selects a color display.
 - b) "Black & White" selects monochrome display.
 - c) "Printer Friendly" inverts the colors.

Adjusting the keyboard backlight

1. In the "Instrument Setup" dialog box, select the "Keyboard Backlight" item.
2. Enter the backlight intensity you want with the numeric keys.

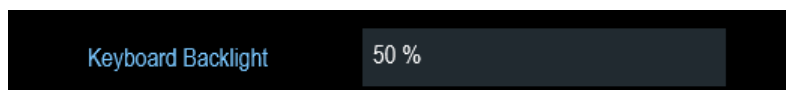

The backlight intensity is a percentage from 0% to 100% with 100% being the brightest.

3. Confirm the entry with the rotary knob.

Adjusting the keyboard backlight delay

1. In the "Instrument Setup" dialog box, select the "Display Backlight" item.
2. Enter the time you want to turn off the keyboard backlight with the numeric keys.



The time delay has a range of 1s to 10s.

3. Confirm the entry with the rotary knob.

Activating the touchscreen interface

1. In the "Instrument Setup" dialog box, select the "Touch Interface" item.
2. Select "ON" to activate the touchscreen interface with R&S Spectrum Rider.

Configuring the R&S Spectrum Rider

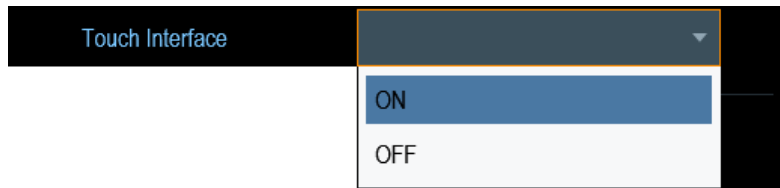

3. Select "OFF" to deactivate the touchscreen interface.
Note: If the touch interface is not activated, the [On-screen keyboard](#) is disabled.

4.7.7 Configuring the Audio Output

The audio settings control the audio output of the system.

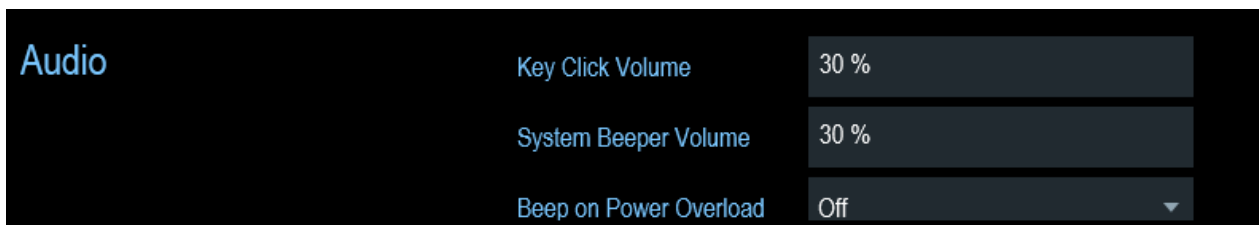

Setting the key click volume

The key click volume sets the volume of the sound that the R&S Spectrum Rider produces when you press a key or select a softkey.

1. In the "Instrument Setup" dialog box, select the "Key Click Volume" item.
2. Enter the volume you want with the numeric keys.

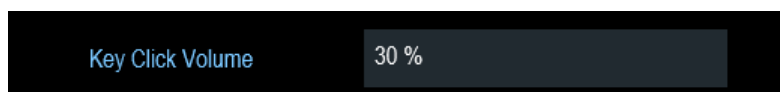

The key click volume is a percentage from 0% to 100% with 100% being the loudest.

3. Confirm the entry with the rotary knob.

Setting the system beeper volume

The system beeper volume sets the volume of the system beeper of the R&S Spectrum Rider used, i.e. if a message box pops up.

1. In the "Instrument Setup" dialog box, select the "System Beeper Volume" item.

Configuring the R&S Spectrum Rider

2. Enter the volume you want with the numeric keys.



The system beeper volume is a percentage from 0% to 100% with 100% being the loudest.

3. Confirm the entry with the rotary knob.

Activating / Deactivating audio alert for power overload

In case the R&S Spectrum Rider detects an overload at one of its inputs, you can configure the alert audible

1. In the "Instrument Setup" dialog box, select the "Beep on Power Overload" item.
2. Select "Beep on Power Overload" to "On".
When this beeper turns on, the R&S Spectrum Rider makes a sound every time it detects an overload.



4.7.8 Configuring Power Supply

The "Current Power Source" shows the source that the R&S Spectrum Rider is powered by.

When you are using the battery to power up the R&S Spectrum Rider, the remaining "Battery Level" is displayed as a percentage with 100 % representing a full charge.

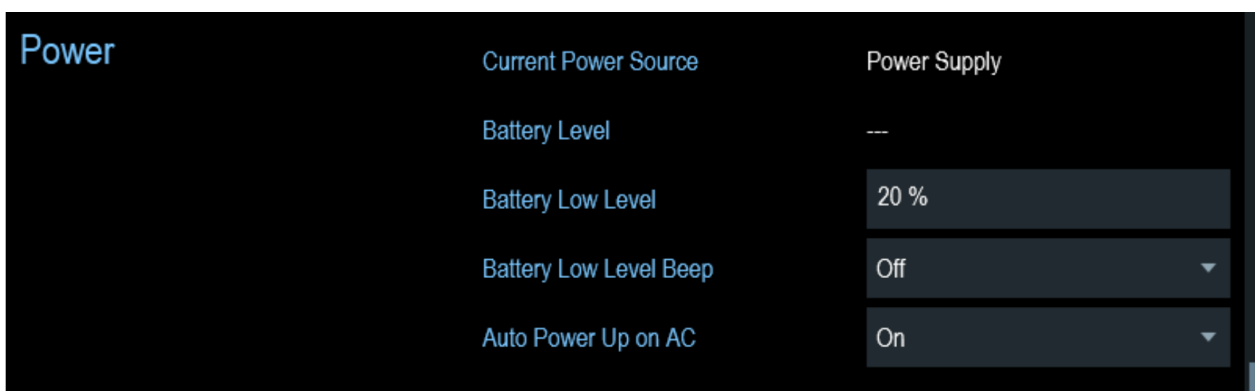

Setting the battery low level

The battery low level is a reminder that the remaining battery charge might be used up soon.

When the battery low level is reached, the battery symbol in the [title bar](#) turns red and starts blinking. See [Chapter 3.1.5, "Battery Operation"](#), on page 16.

1. In the "Instrument Setup" dialog box, select the "Battery Low Level" item.
2. Enter the charge level in percent of a fully charged battery with the numeric keys.



3. Confirm the entry with the rotary knob.

Activating / Deactivating audio alert for battery low-level state

The R&S Spectrum Rider also allows you to turn on an audio signal that indicates that the battery has reached its low-level state.

1. In the "Instrument Setup" dialog box, select the "Battery Low Level Beep" item.

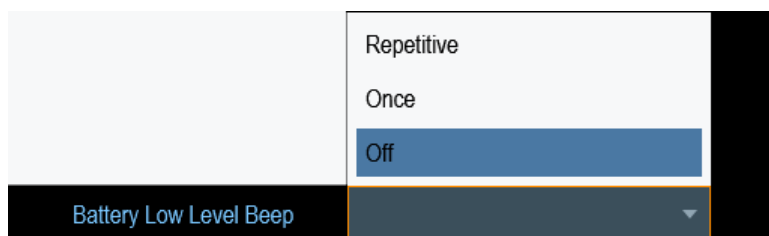

2. Select either "Repetitive" or "Once" to turn on the audio signal. If you have selected "Once", the R&S Spectrum Rider beeps once if the battery runs out of power. For a continuous beep, select "Repetitive".
3. Select "Off" to turn off the beeper.

Auto power up

The R&S Spectrum Rider allows you to auto power up the instrument when supplying with an AC power, without pressing the [POWER] key button.

1. In the "Instrument Setup" dialog box, select the "Auto Power Up on AC" menu item.

Configuring the R&S Spectrum Rider

Auto Power Up on AC

On

- Select "On" to turn on the auto power up mode.
On the next power up cycle, the R&S Spectrum Rider goes into the auto power up mode when supplying with an AC power.

4.7.9 Internal Alignment



R&S Spectrum Rider option

R&S FPH-K35 (order number: 1321.1563.02) option is required to operate the R&S Spectrum Rider internal frequency clock and reference level adjustment.



Operating mode

The frequency clock and reference level alignment can only be performed in "Spectrum" mode. If wrong operating mode is detected, a warning message is displayed before alignment is performed.

For more information on the operating mode of the R&S Spectrum Rider, see [Chapter 4.5.4, "System Keys"](#), on page 40.

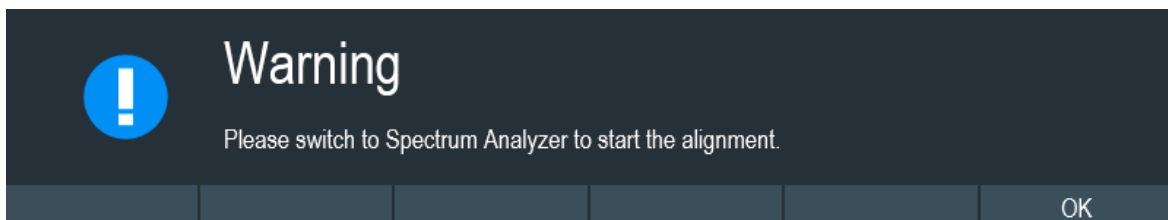

- In the "Instrument Setup" dialog box, select frequency clock or reference level "Align" item to perform alignment.

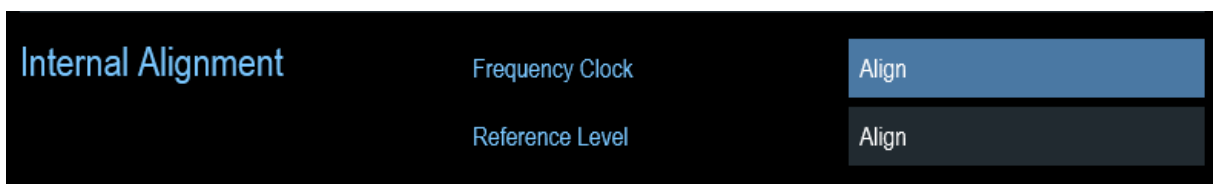

- The R&S Spectrum Rider displays the "Perform Alignment" dialog.

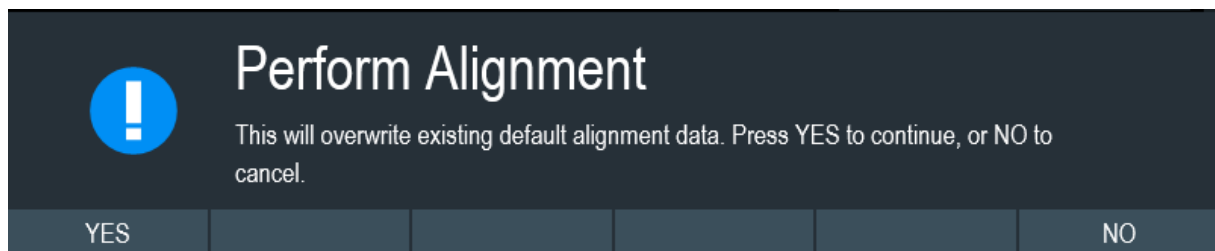

3. Select "Yes" to overwrite existing default alignment data and proceed to perform alignment. The R&S Spectrum Rider displays the "Alignment" dialog. Depending on the selected alignment item, different input signal is required. See [Figure 4-4](#) and [Figure 4-5](#).

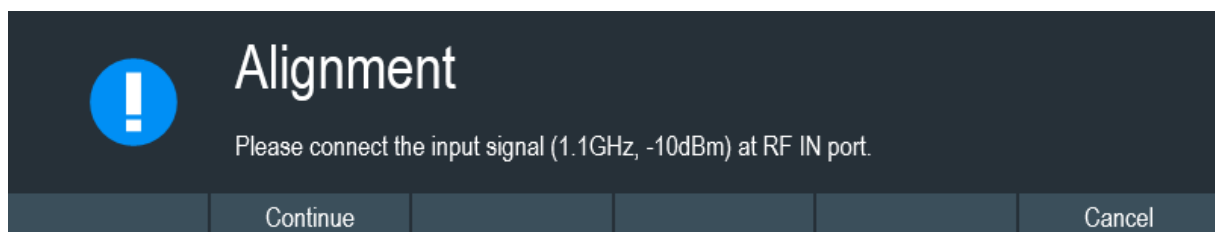

Figure 4-4: Input signal for frequency clock alignment

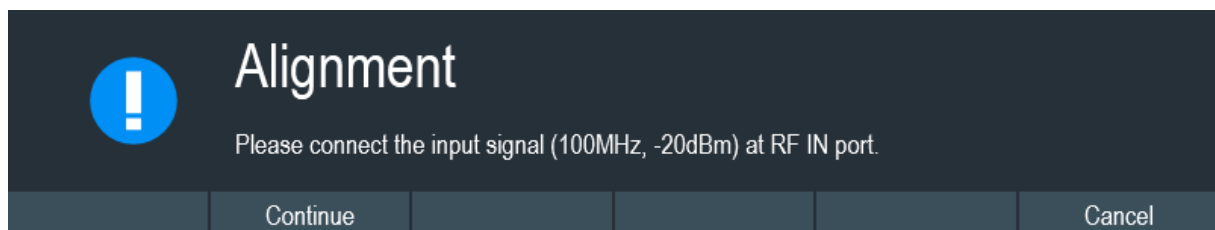
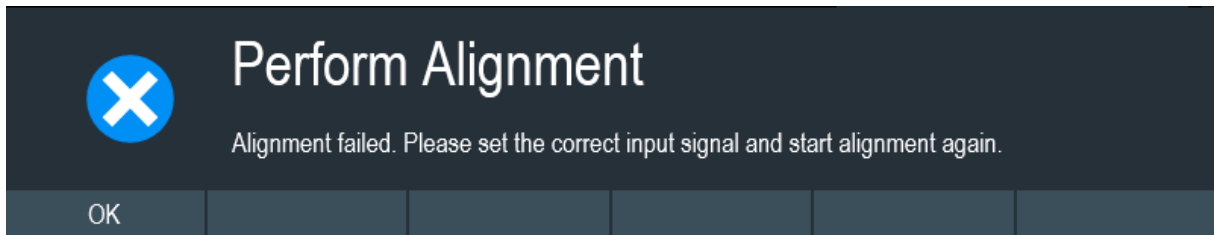

Figure 4-5: Input signal for reference level alignment

4. Connect an input signal of 1.1 GHz, -10dBm at the "RF IN" port for frequency alignment or 100 MHz, -20 dBm at the "RF IN" port for reference level alignment.
5. Select "Continue" to start the internal alignment on the instrument. The R&S Spectrum Rider overwrites existing adjustment data and performs the internal alignment. If wrong input signal is detected, the R&S Spectrum Rider displays a message of a failed alignment dialog.



4.7.10 Resetting the R&S Spectrum Rider

You can either preset the R&S Spectrum Rider or reset it to factory settings.

Presetting the R&S Spectrum Rider

The [PRESET] key resets the R&S Spectrum Rider to the default setup of the currently active operating mode.

This default setup allows you to define the instrument with a new configuration based on a defined measurement parameters without using parameters from a previous measurement unintentionally still being active.

► Press the [PRESET]  key.

Resetting the R&S Spectrum Rider

A "Reset to Factory Settings" resets the R&S Spectrum Rider to the factory defaults.

During a reset, the R&S Spectrum Rider restores the original configuration. It also deletes all customized datasets (limit lines, standards, channel tables, transducer tables etc.). Instead, it will reinstall all the datasets that have been available after delivery.

Risk of data loss

All datasets you have saved are deleted during a factory reset.

1. In the "Instrument Setup" dialog box, select the "Reset to Factory Settings" item.
2. Confirm the entry with the rotary knob.



Connecting the R&S Spectrum Rider to a PC

The R&S Spectrum Rider initiates the reset procedure and shows a warning message box.

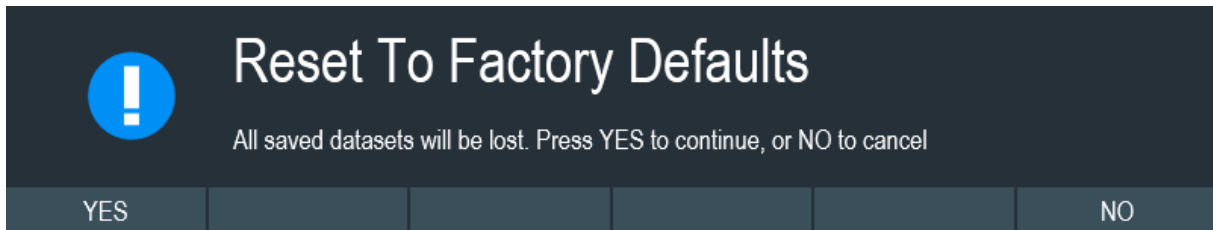

3. A corresponding dialog box opens for selection.
 - Select "Yes" to perform the reset. During the reboot, it shows a corresponding message.
 - Select "No" to cancel the reset.

4.8 Connecting the R&S Spectrum Rider to a PC

The R&S Spectrum Rider comes with the R&S InstrumentView software package. This software package features several tools that allow you to document measurement results, create and edit the different datasets necessary for the instrument. For more information, see the R&S InstrumentView software manual.

The .NET Framework 2.0 (or higher) is required to run the software properly.

You can set up a connection between the R&S Spectrum Rider and R&S InstrumentView either via its [LAN port](#) or its [mini USB port](#).

You have to install the R&S InstrumentView software on the PC before you are able to establish a connection.

Download the latest R&S InstrumentView from <http://www.rohde-schwarz.com/product/fph.html>.

Firewall settings

If no connection can be established between the software and the R&S Spectrum Rider after successful configuration, check the firewall settings on your PC.

- [LAN Connection](#)..... 69
- [USB Connection](#)..... 74

4.8.1 LAN Connection

You can connect the R&S Spectrum Rider directly to the PC with a LAN cable. The **LAN port** is located behind a protective cap on the right side of the R&S Spectrum Rider.

You can set up the LAN connection in the "Instrument Settings" dialog box.

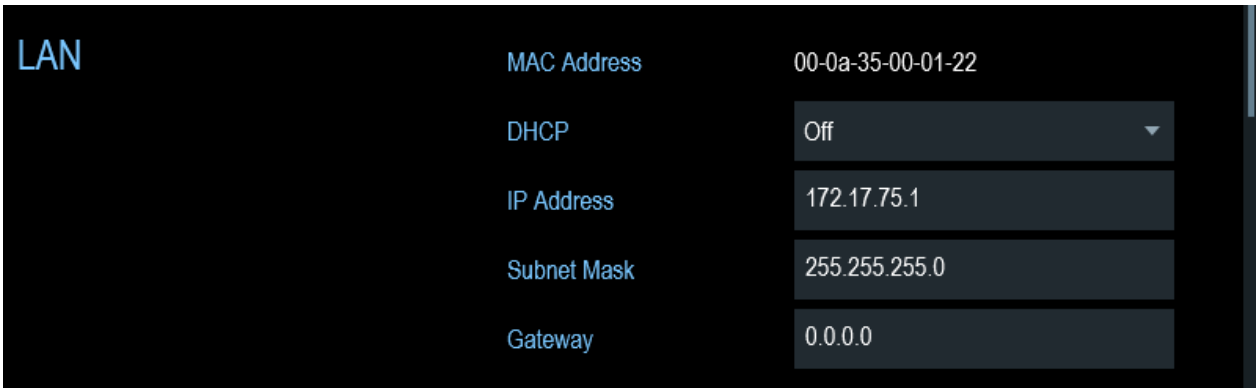

LAN	
MAC Address	00-0a-35-00-01-22
DHCP	Off
IP Address	172.17.75.1
Subnet Mask	255.255.255.0
Gateway	0.0.0.0

For a direct connection between the PC and R&S Spectrum Rider, the DHCP (Dynamic Host Configuration Protocol) of the R&S Spectrum Rider has to be turned off (which is the default state).

1. In the "Instrument Settings" dialog box, select the "DHCP" item. A drop-down menu opens to select the DHCP state.
2. Select "DHCP" to "On" or "Off" as required.

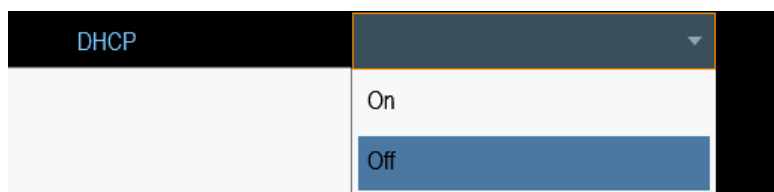

Setting an IP address and subnet mask

To establish a connection, the PC and R&S Spectrum Rider have to be in the same subnet.

Subnet mask

1. Identify the subnet mask of your PC, i.e. in the Microsoft Windows "TCP/IP Properties".

Connecting the R&S Spectrum Rider to a PC

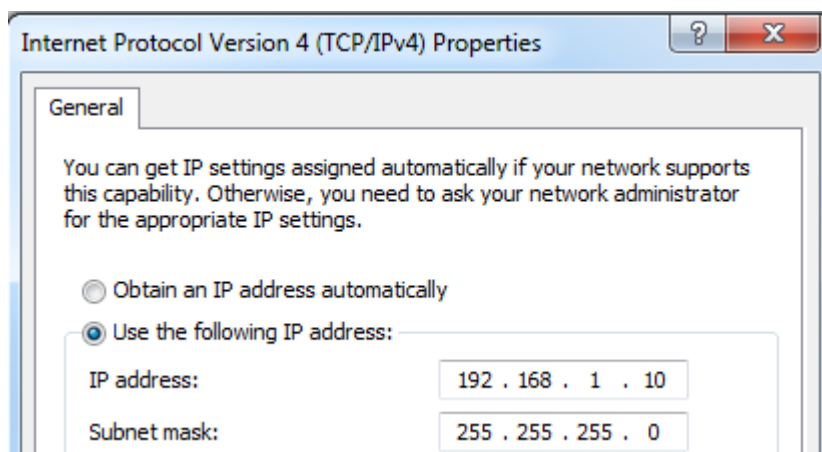

2. In the "Instrument Settings" dialog box, select the "Subnet Mask" item.
3. Enter the subnet mask of the PC with the numeric keys.



After you have matched the subnet mask, you can define the IP address. When both devices are in the same subnet, the first three digits of the IP address are usually the same. See example below:

Example:

IP address for PC: 192.168.1.10

IP address for R&S Spectrum Rider: 192.168.1.20

IP address

1. Identify the IP address of your PC, i.e. in the Microsoft Windows "TCP/IP Properties".

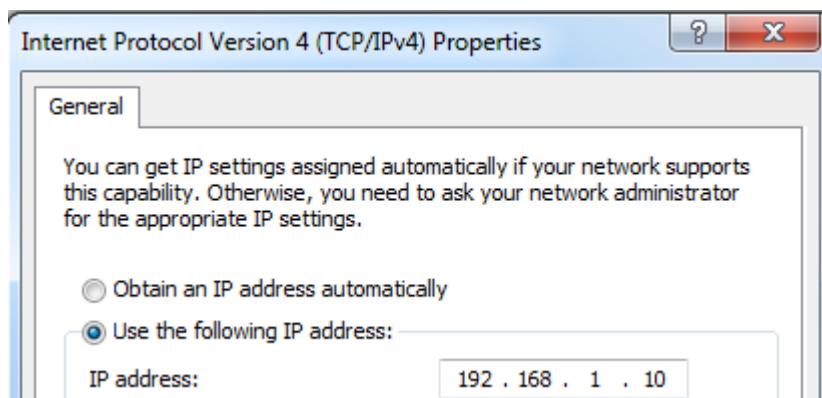

2. In the "Instrument Settings" dialog box, select the "IP Address" item.

Connecting the R&S Spectrum Rider to a PC



3. Confirm the entry with the rotary knob.
4. Enter the IP address of the PC with the numeric keys.



Configuring the R&S InstrumentView software package

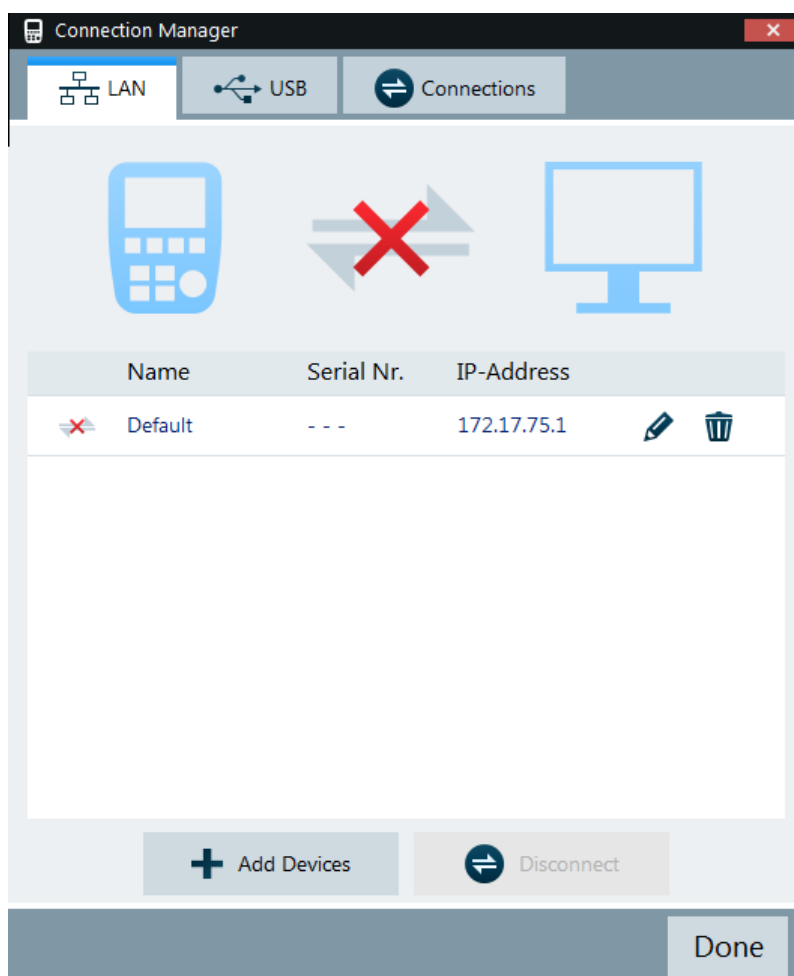

1. Start the R&S InstrumentView software.
2. Select the "LAN" tab in the screen layout.

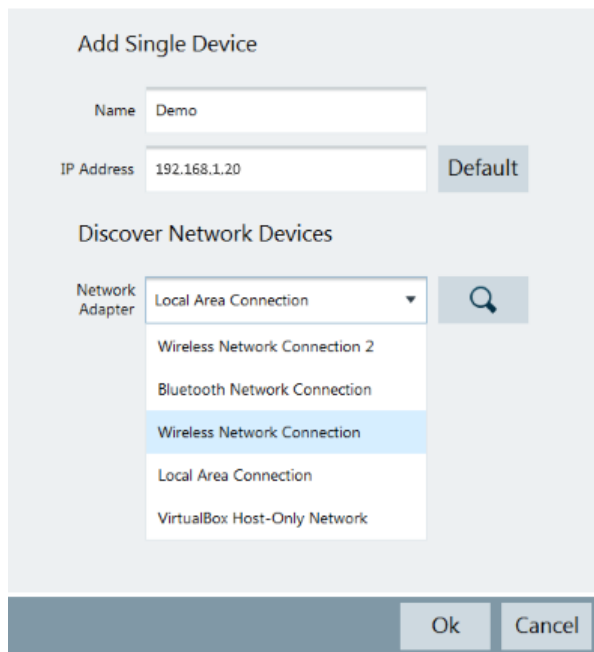

3. During the initial startup, the "IP-Address" field is set to default "172.17.75.1". You can edit the IP address using the   icons
4. Select the "Add Devices" button to create a new network connection.

Connecting the R&S Spectrum Rider to a PC



5. Specify a name and the IP address for the new network connection.
6. Select "Local Area Connection" for the "Network Adapter".
7. Confirm the entry with the "OK" button to add the new instrument to the connection manager list.
8. Depending on the connection status icon,   you can connect or disconnect an instrument from the connection manager list

Connecting the R&S Spectrum Rider to a PC

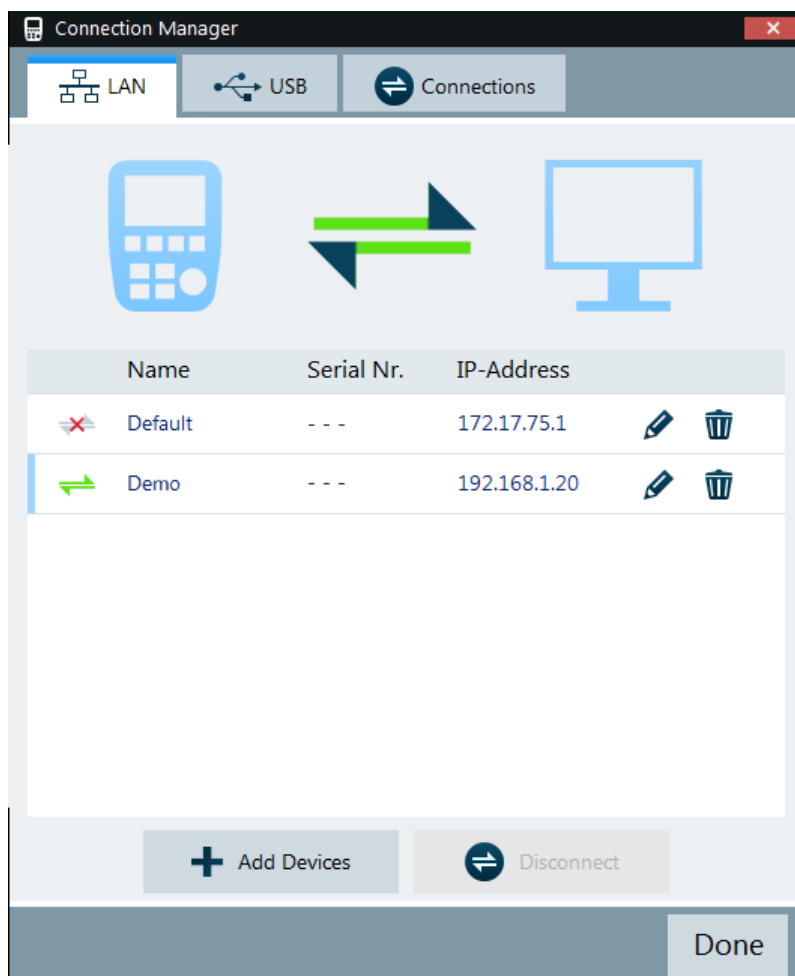

Connecting the R&S Spectrum Rider in an existing LAN

You can either get the R&S Spectrum Rider IP address automatically from the DHCP server or manually assign a fixed address.

With manual allocation, a fixed IP address and subnet mask must be assigned to the R&S Spectrum Rider as described in [Chapter 4.8.1, "LAN Connection"](#), on page 69. After setting up the R&S Spectrum Rider, configure the R&S InstrumentView software with the assigned IP address as described in ["Configuring the R&S InstrumentView software package"](#) on page 71.



Free IP address

Contact your IT system administrator to get a free IP address.

In networks with a DHCP server, the DHCP permits automatic allocation of the network configuration to the R&S Spectrum Rider connected via LAN cable. For this purpose, the DHCP has to be active on the R&S Spectrum Rider.

Connecting the R&S Spectrum Rider to a PC

The DHCP is off by default. Turn it on like this:

1. In the "Instrument Setup" dialog box, select the "DHCP" item.
2. Select "DHCP" to "On" to activate the DHCP.

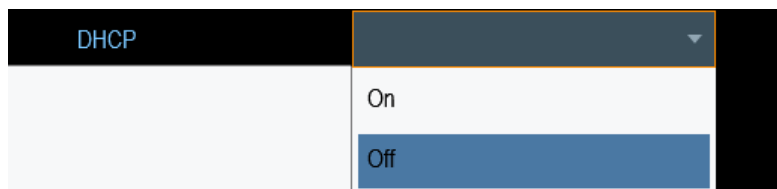

The R&S Spectrum Rider is now allocated an IP address and the subnet mask by the DHCP server. This can take several seconds.

The IP address and subnet mask are automatically set in the corresponding input fields and are no longer available for editing.

Configure the R&S InstrumentView software with the IP address and subnet mask as defined by the DHCP server. For more information, see [Chapter 4.8.1, "LAN Connection"](#), on page 69.



4.8.2 USB Connection

Alternatively, you can connect the R&S Spectrum Rider to the PC with a USB cable. The [mini USB interface](#) is located behind a protective cap on the right side of the R&S Spectrum Rider.

When you connect the R&S Spectrum Rider to a computer for the first time, Windows tries to install the new hardware automatically. The required drivers are installed along with the R&S InstrumentView software package.

When the drivers have been found on your system and the hardware has been successfully installed, Windows shows a corresponding message.

1. Connect the R&S Spectrum Rider via the mini USB port to your computer.
2. Start the R&S InstrumentView on the PC.
3. There is only one USB instance in the connection manager list. See [Figure 4-6](#).

Depending on the connection status icon,   you can connect or disconnect an instrument from the connection manager list

Connecting the R&S Spectrum Rider to a PC

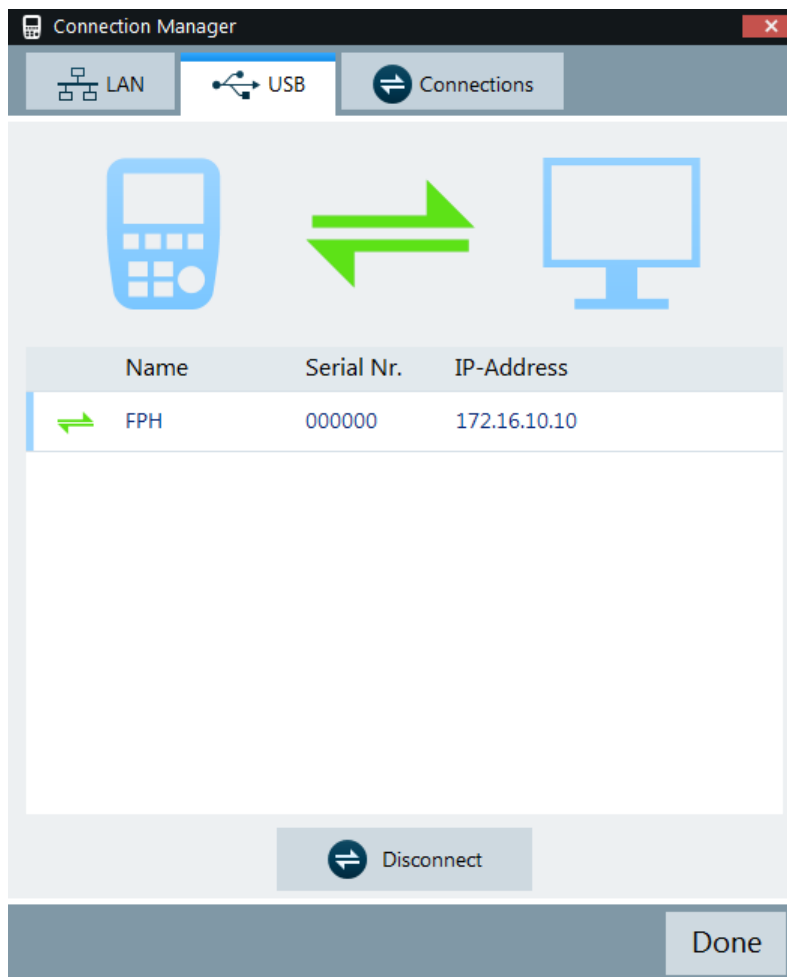

Figure 4-6: USB connection

5 Trying Out the Instrument

This chapter provides a short overview of the first steps of the measurements you can perform with the R&S Spectrum Rider.

- [Using the Spectrum Analyzer](#).....76
- [Using a Power Sensor](#)..... 84
- [Saving and Recalling Results and Settings](#)..... 91

5.1 Using the Spectrum Analyzer

This chapter provides a short overview of the first steps of the measurements you can perform with the R&S Spectrum Rider.

5.1.1 Attenuating the Signal

You can attenuate the signal to a suitable level either manually or automatically.

In case of automatic attenuation, the level of attenuation at the RF input depends on the current reference level. The R&S Spectrum Rider provides two ways of automatic attenuation.

For the highest possible sensitivity, it provides the "Auto Low Noise" attenuation mode. For the lowest possible intermodulation, it provides the "Auto Low Distortion" mode.

The main difference between the two modes is that the attenuation level is 5 dB to 10 dB higher in case of "Auto Low Distortion" than it is for "Auto Low Noise". In the default state, "Auto Low Distortion" is active.

1. Press [AMPT] key.
2. Select "Att/Amp/Imp" softkey.
3. Select either the "Auto Low Noise" or "Auto Low Distortion" menu item. The R&S Spectrum Rider shows the current attenuation level in the "Parameter view". The currently active menu item has a blue background and the selected parameters is indicated with a blue dot in the menu item.

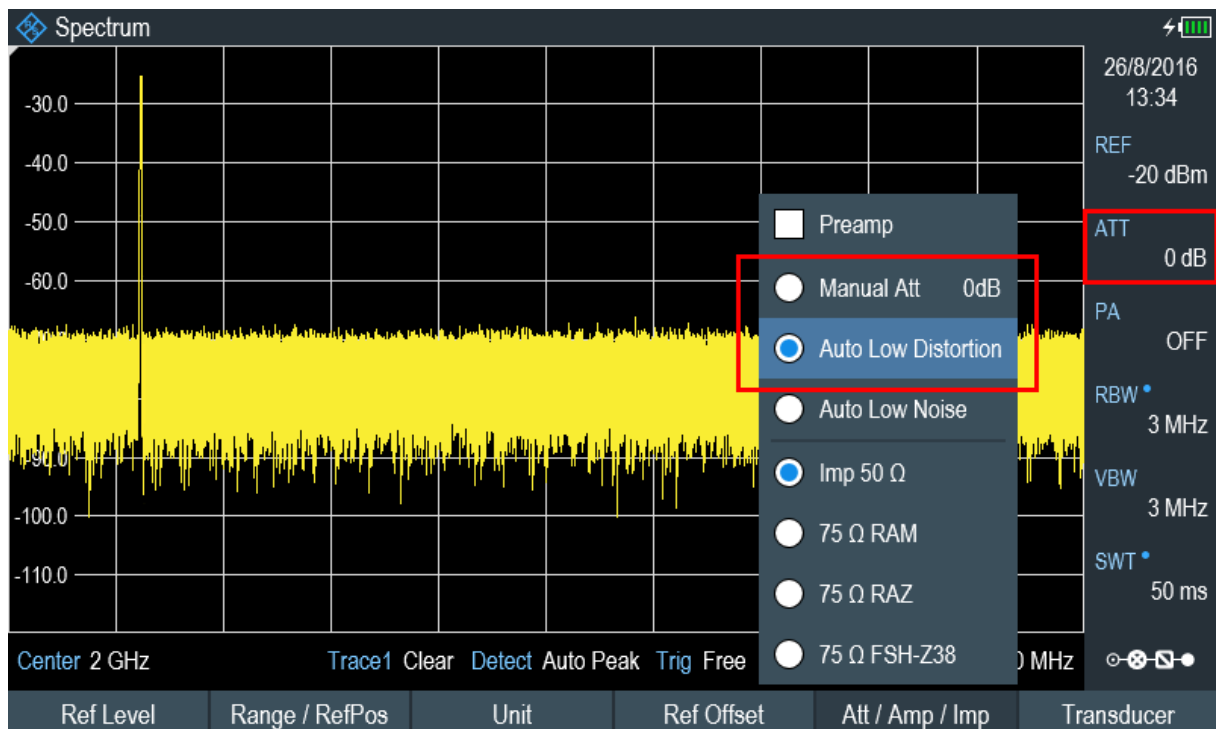

You can also set the attenuation manually. The R&S Spectrum Rider provides attenuation in the range from 0 dB to 40 dB in 5 dB steps.

4. Press [AMPT] key.
5. Select "Att/Amp/Imp" softkey.
6. Select the "Manual Att" menu item.
The R&S Spectrum Rider opens an entry box to define the attenuation. Two methods are provided to fill in the input fields:

- Directly with the number keys
- Using rotary knob

While you can enter any number you want with the number keys, using the rotary knob is coupled to a certain step size in most cases.

If you use the rotary knob to change the attenuation, i.e. the step size is 5 dB.

7. Enter the attenuation you need.
The R&S Spectrum Rider shows the current attenuation level in the "Parameter View".

5.1.2 Using the Preamplifier

The R&S Spectrum Rider has an optional preamplifier (R&S FPH-B22, order number 1321.0680.02) to increase sensitivity. Depending on the frequency, the

Using the Spectrum Analyzer

gain of the amplifier is in the range from 15 dB to 20 dB and increases the sensitivity by 10 dB to 15 dB.

In the signal path, the preamplifier comes after the input protection circuit and before the RF attenuator of the R&S Spectrum Rider to provide excellent sensitivity when the preamplifier is switched on.

1. Press [AMPT] key.
2. Select "Att/Amp/Imp" softkey.
3. Enable or disable the "Preamp" checkbox to turn on or off the preamplifier of the R&S Spectrum Rider.

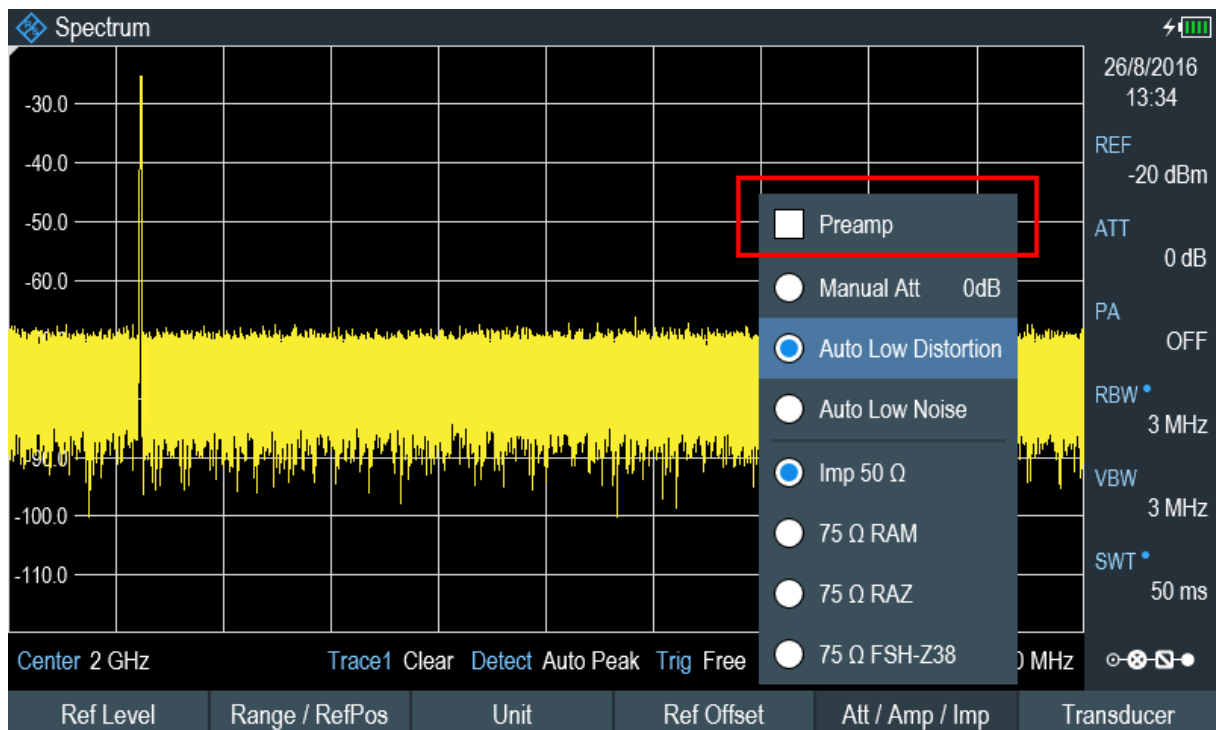

The magnitude of amplification depends on the reference level. This coupling to the reference level makes sure that the dynamic range is at an optimum.

5.1.3 Measuring CW Signals

A basic task for spectrum analyzers is to measure the level and frequency of sine-wave signals. The following examples illustrate an effective way of performing these measurements.

A signal generator, e.g. R&S SMBV provides the signal source.

Test setup

Connect the RF output of the signal generator to the RF input of the R&S Spectrum Rider.

Signal generator settings:

- Frequency: 500 MHz
- Level: -25 dBm

Measuring the level

1. Press [PRESET] key.

The R&S Spectrum Rider is reset to its default state.

After the preset, the R&S Spectrum Rider displays the frequency spectrum over its full frequency span.

At 500 MHz, the generator signal is displayed as a vertical line. To analyze the generator signal at 500 MHz in more detail, reduce the frequency span.

2. Select the "Center" softkey at the "Parameter view".

The R&S Spectrum Rider opens an entry box to define the center frequency.

3. Enter a center frequency of 500 MHz.

The signal is now in the center of the display.

4. Select the "Span" softkey at the "Parameter view".

The R&S Spectrum Rider opens an entry box to specify the span.

5. Enter a span of 20 MHz.

The R&S Spectrum Rider now displays the generator signal with a higher resolution.

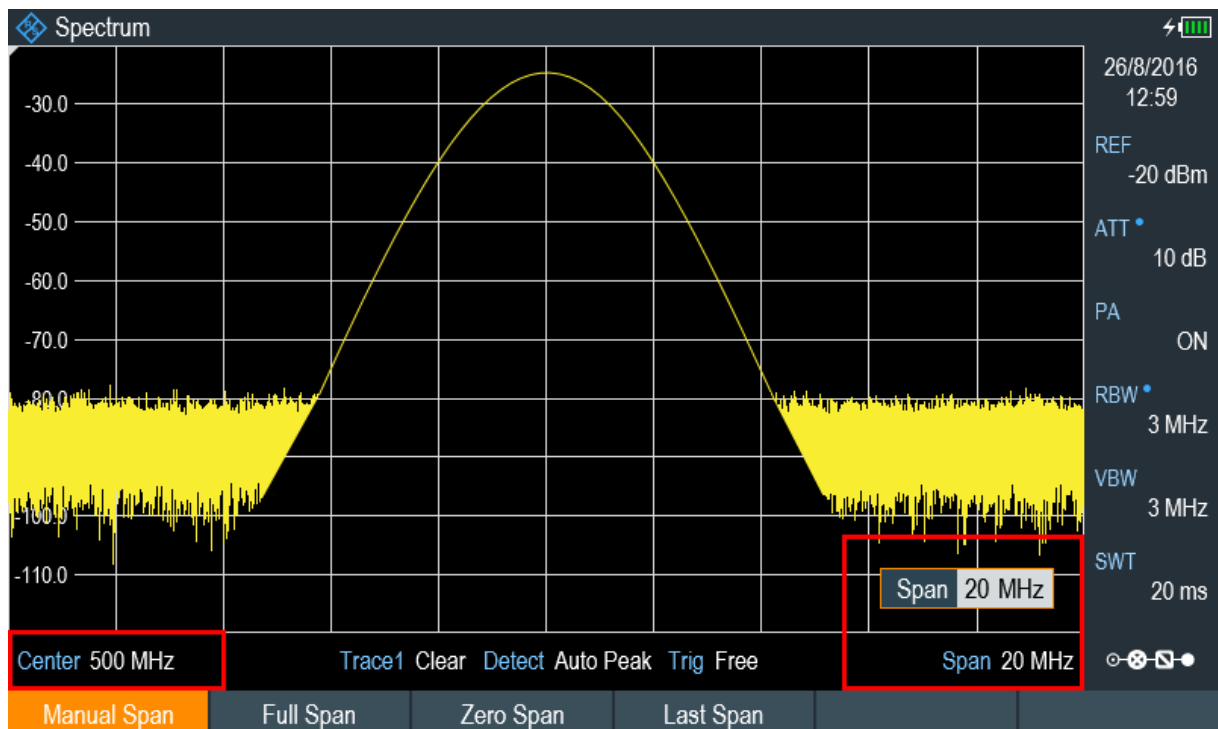

Setting the reference level

The level at the top of the measurement diagram is called the reference level. To obtain the best dynamic range from the R&S Spectrum Rider, you should use its full level range. That means that the maximum level value should be at or close to the top of the measurement diagram (= reference level).

1. Press "REF" softkey at the "Parameter view".
The R&S Spectrum Rider opens an entry box to enter the reference level.
2. Enter a reference level of -25 dBm.
The R&S Spectrum Rider reduces the reference level by 5 dB.

The maximum trace value is close to the maximum scale value of the measurement diagram. The increase in the displayed noise floor is minimal. The difference between the signal maximum and the displayed noise (i.e. the dynamic range) has, however, been increased.

Using markers

The R&S Spectrum Rider has markers to read out signal levels and frequencies. Markers are always positioned on the trace. Both the level and frequency at their current positions are displayed on the screen.

- ▶ Press [MARKER] key.

The R&S Spectrum Rider activates a marker and puts it on the maximum value on the trace. The coordinates of the marker are shown in a table above the measurement diagram.

A red vertical line represents the position of the marker on the horizontal axis (i.e. the frequency). A small red horizontal dash represents the marker position on the vertical axis (i.e. the level).

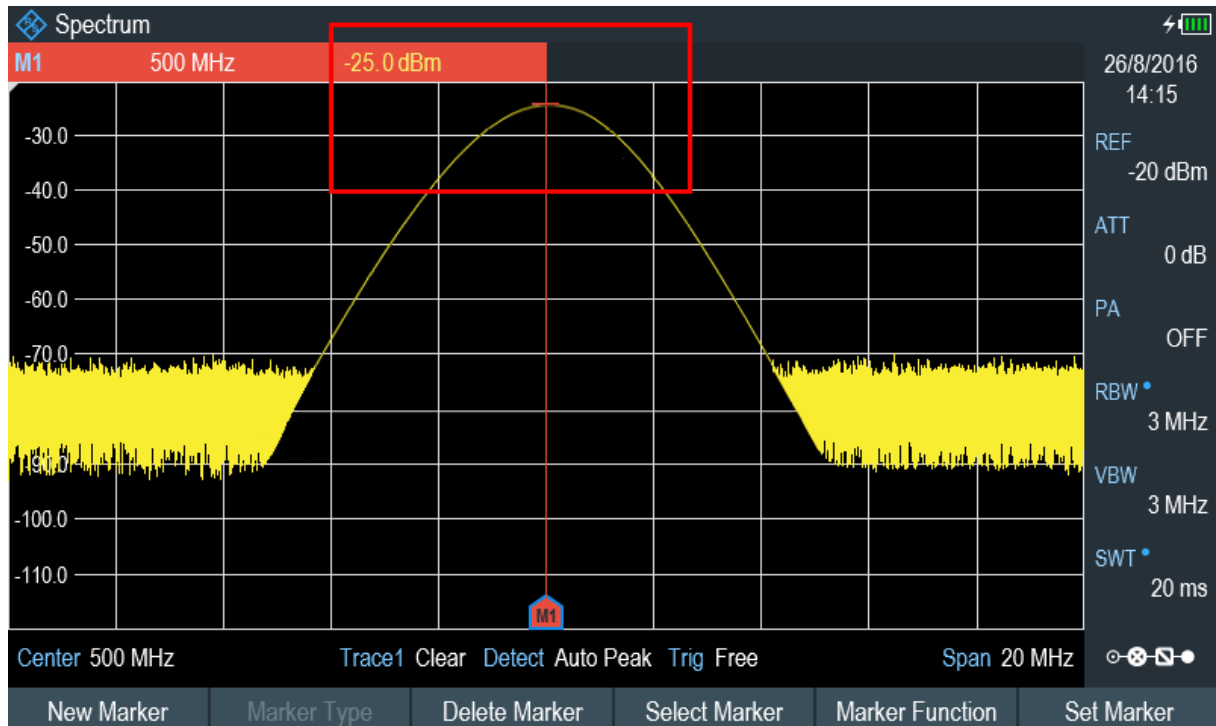

Measuring the frequency

The trace consists of 711 measurement points (frequency points). The marker is always positioned on one of these measurement points. The R&S Spectrum Rider calculates the marker frequency from the frequency of the measurement point, the center frequency and the frequency span that have been set. The measurement-point resolution, and consequently the accuracy of the marker frequency readout, therefore depend on the frequency span that has been selected.

The R&S Spectrum Rider has a frequency counter to increase the accuracy of the marker-frequency readout. It completes the sweep, then counts the frequency at the marker position.

1. Press the "Marker Function" softkey at the "Parameter view".
2. Select the "Frequency Count" from the menu item.

Using the Spectrum Analyzer

The measurement result of the frequency counter is displayed at the "Measurement result view". When the frequency counter is active, the highest resolution of the frequency readout that can be achieved is 0.0001 Hz. The accuracy is determined by the internal reference frequency which is far more exact than the pixel-oriented marker readout.

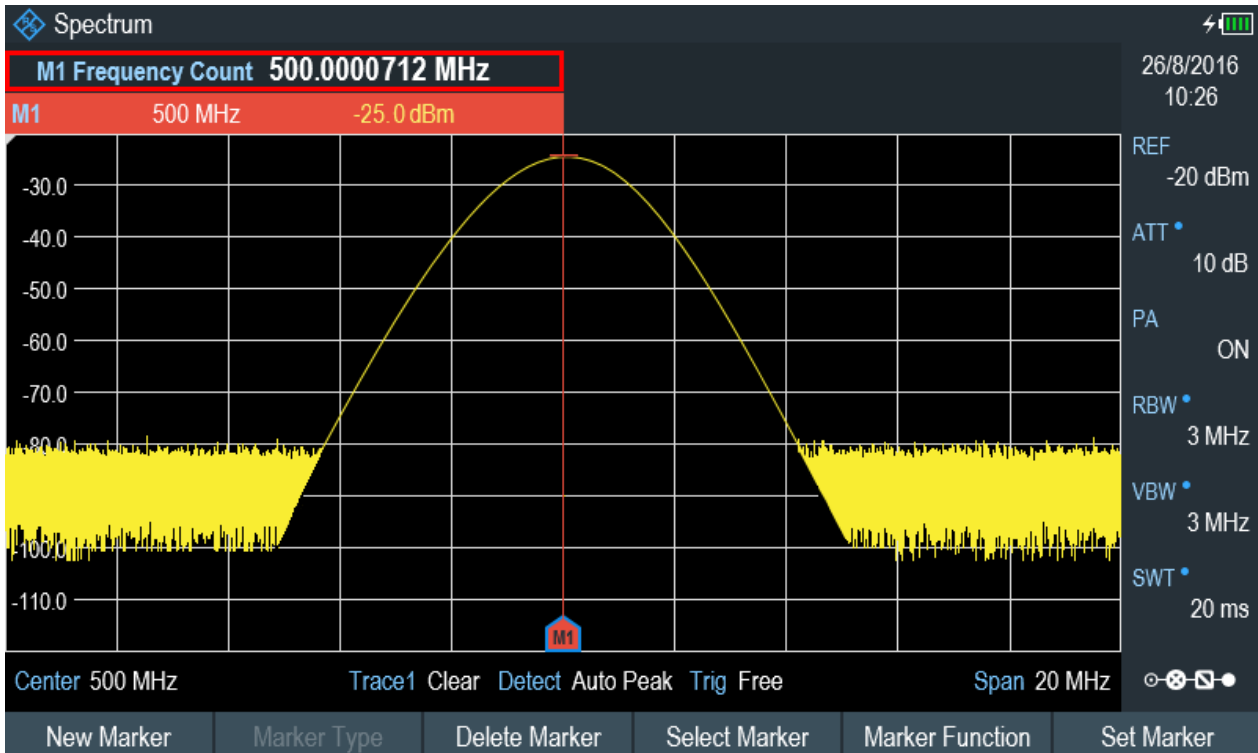

5.1.4 Measuring Harmonics

A spectrum analyzer is ideal to measure harmonic levels or harmonic ratios, because it can resolve different signals in the frequency domain.

With marker functions, you can speed up the measurement tasks.

A signal generator, e.g. R&S SMBV provides the signal source.

Test setup

Connect the RF output of the signal generator to the RF input of the R&S Spectrum Rider.

Signal generator settings:

- Frequency: 100 MHz
- Level: -20 dBm

Detecting harmonics

1. Press [PRESET] key.
The R&S Spectrum Rider is reset to its default state.
After the preset, the R&S Spectrum Rider displays the frequency spectrum over its full frequency span.
At 100 MHz, the generator signal is displayed as a vertical line. In addition, you can see the harmonics as smaller vertical lines at frequencies that are multiples of 100 MHz. To measure the second harmonic ratio, decrease the span.
2. Press [FREQ] key.
3. Select the "Start" softkey at the "Measurement footer bar".
The R&S Spectrum Rider opens an entry box to enter the start frequency.
4. Enter a start frequency of 50 MHz.
5. Confirm the entry with one of the unit keys.
6. Select the "Stop" softkey at the "Measurement footer bar".
The R&S Spectrum Rider opens an entry box to enter the stop frequency.
7. Enter a stop frequency of 250 MHz.
8. Confirm the entry with one of the unit keys.
The R&S Spectrum Rider displays the frequency spectrum in the range from 50 MHz to 250 MHz. This frequency range visualizes the signal itself at 100 MHz and the second harmonic at 200 MHz.

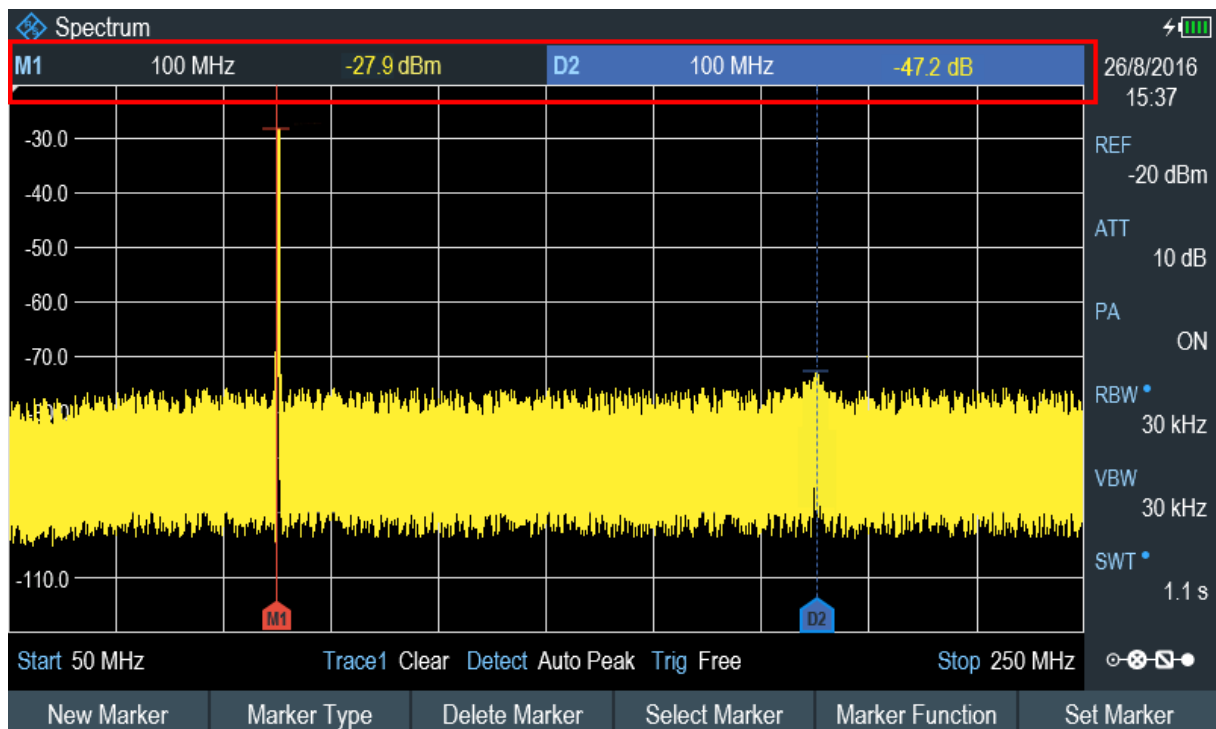

To measure the harmonic ratio, set the marker on the signal and a delta marker on the second harmonic.

9. Press [MARKER] key.
The R&S Spectrum Rider sets a marker on the trace maximum. The trace maximum corresponds to the signal.
10. Select the "New Marker" softkey at the "Measurement footer bar".
The R&S Spectrum Rider activates a delta marker and places it on the next trace maximum. This corresponds to the second harmonic.
The harmonic ratio is the vertical distance of the marker and the delta marker.
The R&S Spectrum Rider displays this value in the "Measurement result view".

5.2 Using a Power Sensor



R&S Spectrum Rider option

R&S FPH-K9 (order number: 1321.0709.02) option is required to operate the R&S Spectrum Rider in the power sensor mode.

For highly accurate power measurements, you can connect one of the power sensors that are supported by the R&S Spectrum Rider.

For a list of R&S Spectrum Rider supported power sensors, see the datasheet of the R&S Spectrum Rider.

You can connect the list of supported power sensors to the USB port of the R&S Spectrum Rider. This connector allows you to control the power sensor and supplies it with power. For more information, see [Chapter 4.2.4, "USB Port"](#), on page 27.

5.2.1 Measuring the Power with a Power Sensor

For more information about the characteristics of the supported power sensors, refers to their datasheet.

NOTICE

Risk of damaging the power sensor

Because of high input power,

- The continuous power applied to the power sensor's input must not exceed 400 mW (26 dBm).
- Use an attenuator for measurements on high-power transmitters.

However, brief power peaks $\leq 10 \mu\text{s}$ up to 1 W (30 dBm) are permissible.

Test setup

Connect the power sensor cable to the USB port of R&S Spectrum Rider. If the power sensor is having the binder connector (i.e R&S FSH-Z1, R&S FSH-Z18), the FSH-Z101 adaptor cable is needed.

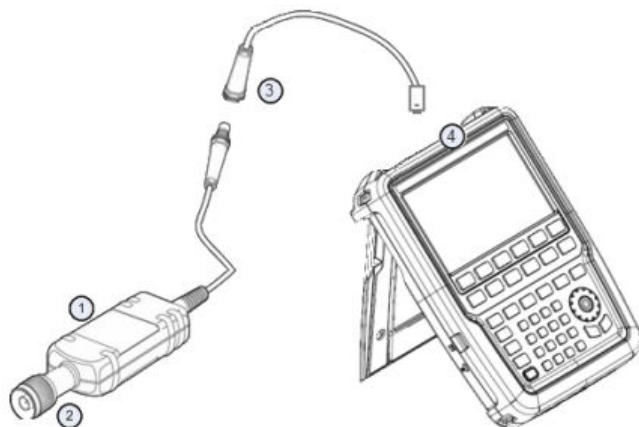

- 1 = Supported power sensor (e.g R&S FSH-Z1, R&S NRP-Z11)
- 2 = Power sensor connector (DUT)
- 3 = USB binder adaptor (R&S FSH-Z101)
- 4 = USB port connector

Measuring the power

1. Press [MODE] key.
2. Select "Power Meter" softkey.
The R&S Spectrum Rider switches its operating mode.

If the R&S Spectrum Rider recognizes a power sensor, it sets up a connection via the USB interface. After a few seconds, the R&S Spectrum Rider shows the measured power.

If no power sensor has been connected or is not connected appropriately, the R&S Spectrum Rider shows nothing.

If there are communication problems between the R&S Spectrum Rider and the power sensor, the R&S Spectrum Rider displays an error message that indicates a possible cause.

For more information on the error messages, see the "Power Meter" in the R&S Spectrum Rider user manual.

Zeroing the power sensor

To compensate internal offsets of the power meter, a **zeroing** for the power sensor is required before starting the measurement.

1. Select "Zero" softkey.

Do not to apply any signals to the power sensor while zeroing is active. A popup message box is displayed to provide instructions during the zeroing of the power sensor.



Please Remove All Signals

From the sensor input and press Continue to start zeroing

2. Disconnect the power sensor from any signal sources.
3. Select "Continue" softkey to start zeroing.
The R&S Spectrum Rider starts the zeroing process.



Zeroing Power Sensor

Please wait while the system is zeroing the power sensor

4. Wait for the zeroing process to finish.
After zeroing, the R&S Spectrum Rider displays the message "Power sensor zero done" and again shows the power sensor softkey menu.



Power sensor zero done

5. Connect the DUT to the power sensor.
The R&S Spectrum Rider shows the measured power level in dBm. For more information on the power meter measurement, see "Power Meter" in the R&S Spectrum Rider user manual.

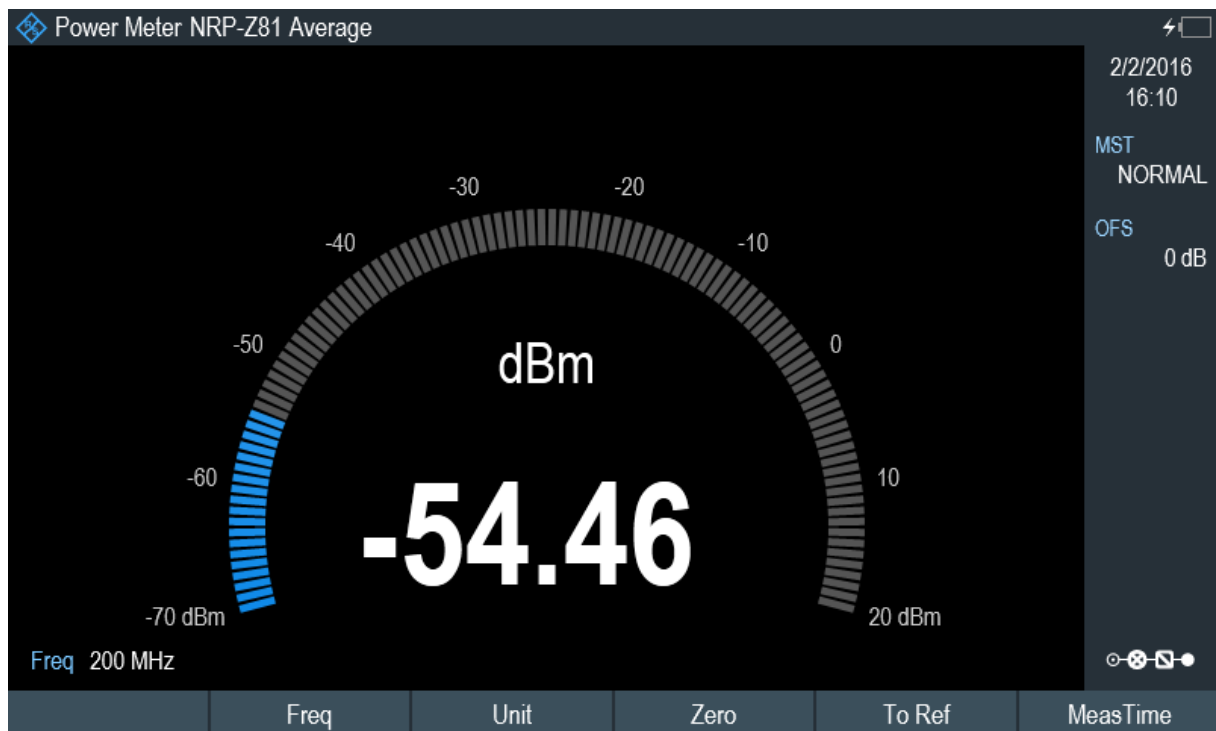

Set the frequency

To get the best results, enter the frequency of the signal under test.

1. Select "Freq" softkey.
The R&S Spectrum Rider opens an entry box to enter the frequency.
2. Enter the frequency of the signal.
3. Confirm the entry with one of the unit keys.

The R&S Spectrum Rider transfers the new frequency to the power sensor which then corrects the measured power readings.

5.2.2 Measuring Power and Return Loss

With the directional power sensors R&S FSH-Z14 and R&S FSH-Z44, you can measure the power in both directions.

When you connect the directional power sensor between the source and the load, the R&S Spectrum Rider measures the power from the source to load (forward power) and from the load to source (reverse power).

The ratio between the forward and reverse power is a measure of the load matching. The R&S Spectrum Rider displays it as the return loss or standing wave ratio.

The power sensors for the R&S Spectrum Rider have an asymmetrical design. Therefore, they have to be inserted into the test setup in such a way that the "Forward" arrow on the sensor points toward the load (in the direction of the power flux).

When measuring high powers, pay strict attention to the following instructions to avoid personal injury and to prevent the power sensor from being destroyed.

⚠ CAUTION**Danger of skin burns and damage to the instrument**

- Never exceed the permissible continuous power.
 - See diagram on the rear of the sensor for the permissible continuous power.
 - Turn off the RF power to connect the sensor.
 - Screw the RF connectors tightly.
-

Test setup

Connect the power sensor cable to the USB port of R&S Spectrum Rider. If the power sensor is having the binder connector (i.e R&S FSH-Z14, R&S FSH-Z44), the FSH-Z144 adaptor cable is needed. Insert the directional power sensor between the source and the load.

The power sensors for the R&S Spectrum Rider have an asymmetrical design. Hence, you have to insert them into the test setup in such a way that the "Forward" arrow (1→2) on the sensor points toward the load (= in the direction of the power flux).

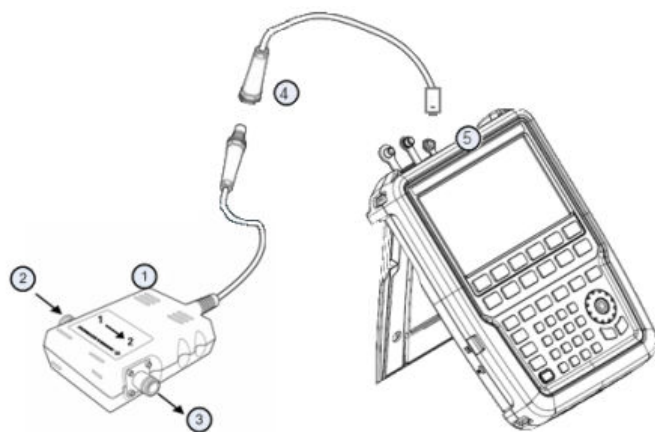

- 1 = Directional power sensor R&S FSH-Z14 or Z44
- 2 = Source
- 3 = Load
- 4 = USB binder adaptor (R&S FSH-Z144)
- 5 = USB port connector

Measuring the power

1. Press [MODE] key.
2. Select "Power Meter" softkey.

As soon as the R&S Spectrum Rider recognizes the power sensor, it displays the type of the directional power sensor that is connected in the "Title bar" (see [Figure 4-2](#)). After a few seconds, it also shows the forward power and return loss currently measured at the load.

Zeroing the power sensor

Before performing the power measurement, you should zeroing the power sensor.

After zeroing is done, the R&S Spectrum Rider displays the message "Power sensor zero done" and again shows the power sensor softkey menu.

- ▶ Connect the R&S FSH-Z14 or R&S FSH-Z44 between the source and the load. The R&S Spectrum Rider displays the measured forward power in dBm and the SWR of the load. For more information on using the directional power sensor, see "Power Meter" in the R&S Spectrum Rider user documentation.

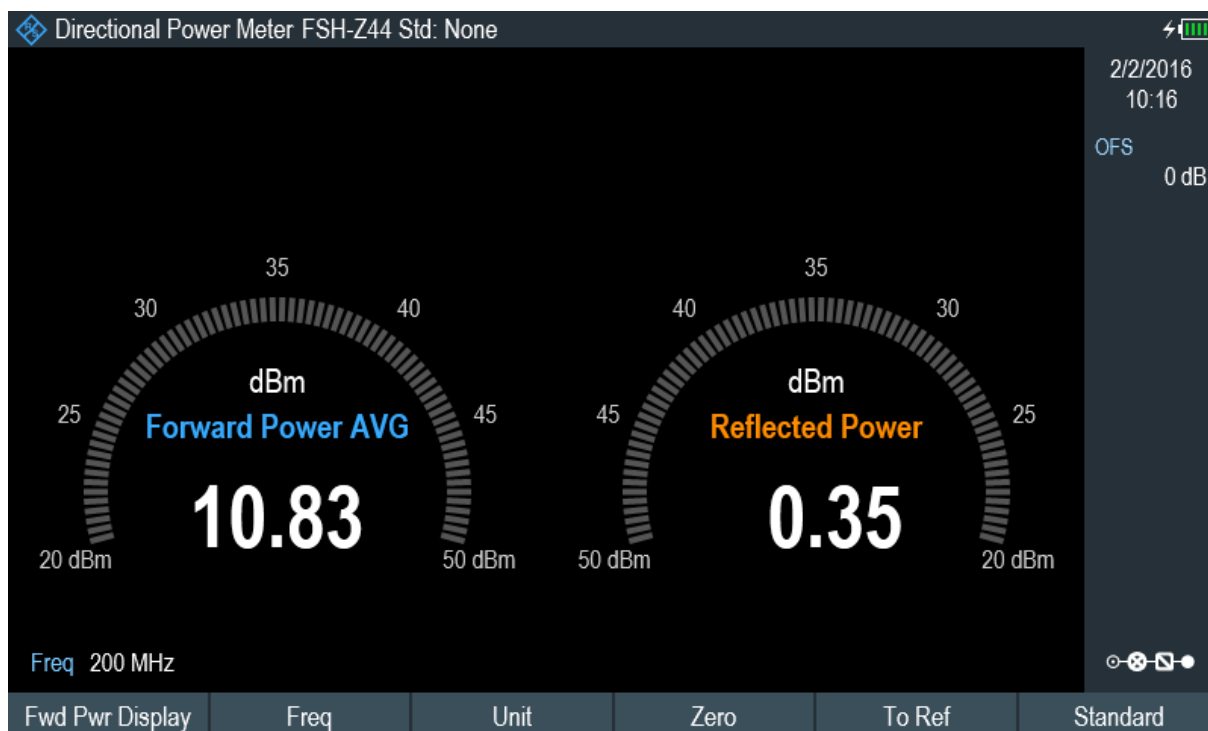

To get the best results, you should also define the frequency of the signal. For more information on the measuring power and return loss, see "Power Meter" in the R&S Spectrum Rider user manual.

5.3 Saving and Recalling Results and Settings

Storage device

If both USB flash drive and micro-SD card are connected to the instrument, the USB flash drive takes precedent over SD card as a storage device.

If both storage devices are not connected, the internal memory of the instrument is used for storage.

The R&S Spectrum Rider can store measurement results and settings in the internal memory, removable micro-SD card or on a USB flash drive via the USB interface.

Results and settings are always stored together, allowing them to be interpreted in context when recalled. The R&S Spectrum Rider can store at least 100 data records in the internal memory which are differentiated by their names.

Saving and Recalling Results and Settings

The R&S Spectrum Rider provides two [USB ports](#) and one [micro-SD card slot](#).

For more information on saving measurement results and settings, see "Saving Datasets" in the R&S Spectrum Rider user manual.

For more information on recalling measurement results and settings, see "Restoring Datasets" in the R&S Spectrum Rider user manual.

Index

- A**
- AC adapter 15
 - Accessory detection 48
 - Antenna
 - Configuring 48
 - Application cards 8
 - Application notes 8
 - Attenuation 76
 - Audio settings 62
 - Auto low distortion 76
 - Auto low noise 76
 - Auto power up 63
- B**
- Backlight 59
 - Battery insertion 13
 - Battery low level 63
 - Battery maintenance 18
 - Battery operation
 - Battery (car adapter) 16
 - Battery (charging) 16
 - Battery (external charger) 16
 - Battery (replacement) 16
 - BNC connector 26
 - Configuring 48
 - Brochure 8
- C**
- Calibration certificate 8
 - Connectors 24
 - Controls 23
 - Conventions 9
- D**
- Data sheet 8
 - Date & time 57
 - Date format 58
 - DC port 27
 - Directional power sensor
 - Zeroing 88
 - Display settings 59
 - Documentation overview 7
- E**
- Electrostatic discharge 11
 - ESD 11
 - External reference 26
 - External trigger 26
- F**
- Frequency 78
 - Front panel keys 39
 - Function keys 41
- G**
- Getting started 7
 - GPS receiver 54
- H**
- Hardware settings 48
 - Harmonics 82
 - Headphone jack 27
- K**
- Kensington lock 28
 - Keypad 42
- L**
- LAN connection with R&S Spectrum Rider 69
 - LAN port 28
 - Languages 58
 - Length unit 58
- M**
- Marker
 - Frequency counter 78
- N**
- Navigation controls
 - Rotary knob 43
- O**
- On-screen keyboard 39
 - Open source acknowledgment (OSA) 8
 - Options 44
 - Checking options 45
 - Enabling options 44
 - Managing options with R&S License Manager 45

P

Package contents	13
Positioning	
Support	13
Power key	39
Power overload beep	63
Power sensor	
Zeroing	84
Power sensor port	27
Power settings	63
Preamplifier	77
Preset	67
Putting into operation	11

R

Reference level	78
Regional settings	58
Release notes	8
Reset	67
RF input	25

S

Safety instructions	7
Screenshot key	40
SD card slot	29
Signal attenuation	76
Softkey key	40
Spectrum analyzer	76
Supplied options	20
Switching on and off the instrument	19
System keys	40

T

Touchscreen	30
Configuration overview	36
Measurement result view	33, 34
Parameter view	35
Title bar	32
Touchscreen gesture	30

U

Unpacking and checking the instrument .	12
USB connection with R&S Spectrum Rider	74
USB port	27, 28
User interface	23
User manual	7

V

Volume	
Key clock volume	62
System beeper	62

W

White papers	8
--------------------	---