

Operating Manual



Spectrum Analyzer

R&S[®] FSL3

1300.2502K03

1300.2502K13

R&S[®] FSL6

1300.2502K06

1300.2502K16

R&S[®] FSL18

1300.2502K18

1300.2502K28



Dear Customer,

Throughout this manual, the Spectrum Analyzer R&S[®] FSL is abbreviated as R&S FSL.

R&S[®] is a registered trademark of Rohde & Schwarz GmbH & Co. KG
Trade names are trademarks of the owners

Basic Safety Instructions

Always read through and comply with the following safety instructions!

All plants and locations of the Rohde & Schwarz group of companies make every effort to keep the safety standards of our products up to date and to offer our customers the highest possible degree of safety. Our products and the auxiliary equipment they require are designed, built and tested in accordance with the safety standards that apply in each case. Compliance with these standards is continuously monitored by our quality assurance system. The product described here has been designed, built and tested in accordance with the attached EC Certificate of Conformity and has left the manufacturer's plant in a condition fully complying with safety standards. To maintain this condition and to ensure safe operation, you must observe all instructions and warnings provided in this manual. If you have any questions regarding these safety instructions, the Rohde & Schwarz group of companies will be happy to answer them.

Furthermore, it is your responsibility to use the product in an appropriate manner. This product is designed for use solely in industrial and laboratory environments or, if expressly permitted, also in the field and must not be used in any way that may cause personal injury or property damage. You are responsible if the product is used for any intention other than its designated purpose or in disregard of the manufacturer's instructions. The manufacturer shall assume no responsibility for such use of the product.

The product is used for its designated purpose if it is used in accordance with its product documentation and within its performance limits (see data sheet, documentation, the following safety instructions). Using the product requires technical skills and a basic knowledge of English. It is therefore essential that only skilled and specialized staff or thoroughly trained personnel with the required skills be allowed to use the product. If personal safety gear is required for using Rohde & Schwarz products, this will be indicated at the appropriate place in the product documentation. Keep the basic safety instructions and the product documentation in a safe place and pass them on to the subsequent users.

Observing the safety instructions will help prevent personal injury or damage of any kind caused by dangerous situations. Therefore, carefully read through and adhere to the following safety instructions before and when using the product. It is also absolutely essential to observe the additional safety instructions on personal safety, for example, that appear in relevant parts of the product documentation. In these safety instructions, the word "product" refers to all merchandise sold and distributed by the Rohde & Schwarz group of companies, including instruments, systems and all accessories.

Symbols and safety labels

							
Notice, general danger location Observe product documentation	Caution when handling heavy equipment	Danger of electric shock	Warning! Hot surface	PE terminal	Ground	Ground terminal	Be careful when handling electrostatic sensitive devices

					
ON/OFF supply voltage	Standby indication	Direct current (DC)	Alternating current (AC)	Direct/alternating current (DC/AC)	Device fully protected by double (reinforced) insulation

Tags and their meaning

The following signal words are used in the product documentation in order to warn the reader about risks and dangers.



indicates a hazardous situation which, if not avoided, will result in death or serious injury.



indicates a hazardous situation which, if not avoided, could result in death or serious injury.



indicates a hazardous situation which, if not avoided, could result in minor or moderate injury.



indicates the possibility of incorrect operation which can result in damage to the product.

In the product documentation, the word ATTENTION is used synonymously.

These tags are in accordance with the standard definition for civil applications in the European Economic Area. Definitions that deviate from the standard definition may also exist in other economic areas or military applications. It is therefore essential to make sure that the tags described here are always used only in connection with the related product documentation and the related product. The use of tags in connection with unrelated products or documentation can result in misinterpretation and in personal injury or material damage.

Operating states and operating positions

The product may be operated only under the operating conditions and in the positions specified by the manufacturer, without the product's ventilation being obstructed. If the manufacturer's specifications are not observed, this can result in electric shock, fire and/or serious personal injury or death. Applicable local or national safety regulations and rules for the prevention of accidents must be observed in all work performed.

1. Unless otherwise specified, the following requirements apply to Rohde & Schwarz products: predefined operating position is always with the housing floor facing down, IP protection 2X, pollution severity 2, overvoltage category 2, use only indoors, max. operating altitude 2000 m above sea level, max. transport altitude 4500 m above sea level. A tolerance of $\pm 10\%$ shall apply to the nominal voltage and $\pm 5\%$ to the nominal frequency.
2. Do not place the product on surfaces, vehicles, cabinets or tables that for reasons of weight or stability are unsuitable for this purpose. Always follow the manufacturer's installation instructions when installing the product and fastening it to objects or structures (e.g. walls and shelves). An installation that is not carried out as described in the product documentation could result in personal injury or death.
3. Do not place the product on heat-generating devices such as radiators or fan heaters. The ambient temperature must not exceed the maximum temperature specified in the product documentation or in the data sheet. Product overheating can cause electric shock, fire and/or serious personal injury or death.

Electrical safety

If the information on electrical safety is not observed either at all to the extent necessary, electric shock, fire and/or serious personal injury or death may occur.

1. Prior to switching on the product, always ensure that the nominal voltage setting on the product matches the nominal voltage of the AC supply network. If a different voltage is to be set, the power fuse of the product may have to be changed accordingly.
2. In the case of products of safety class I with movable power cord and connector, operation is permitted only on sockets with an earthing contact and protective earth connection.
3. Intentionally breaking the protective earth connection either in the feed line or in the product itself is not permitted. Doing so can result in the danger of an electric shock from the product. If extension cords or connector strips are implemented, they must be checked on a regular basis to ensure that they are safe to use.
4. If the product does not have a power switch for disconnection from the AC supply network, the plug of the connecting cable is regarded as the disconnecting device. In such cases, always ensure that the power plug is easily reachable and accessible at all times (corresponding to the length of connecting cable, approx. 2 m). Functional or electronic switches are not suitable for providing disconnection from the AC supply network. If products without power switches are integrated into racks or systems, a disconnecting device must be provided at the system level.
5. Never use the product if the power cable is damaged. Check the power cable on a regular basis to ensure that it is in proper operating condition. By taking appropriate safety measures and carefully laying the power cable, you can ensure that the cable will not be damaged and that no one can be hurt by, for example, tripping over the cable or suffering an electric shock.
6. The product may be operated only from TN/TT supply networks fused with max. 16 A (higher fuse only after consulting with the Rohde & Schwarz group of companies).
7. Do not insert the plug into sockets that are dusty or dirty. Insert the plug firmly and all the way into the socket. Otherwise, sparks that result in fire and/or injuries may occur.
8. Do not overload any sockets, extension cords or connector strips; doing so can cause fire or electric shocks.
9. For measurements in circuits with voltages $V_{\text{rms}} > 30 \text{ V}$, suitable measures (e.g. appropriate measuring equipment, fusing, current limiting, electrical separation, insulation) should be taken to avoid any hazards.
10. Ensure that the connections with information technology equipment, e.g. PCs or other industrial computers, comply with the IEC60950-1/EN60950-1 or IEC61010-1/EN 61010-1 standards that apply in each case.
11. Unless expressly permitted, never remove the cover or any part of the housing while the product is in operation. Doing so will expose circuits and components and can lead to injuries, fire or damage to the product.
12. If a product is to be permanently installed, the connection between the PE terminal on site and the product's PE conductor must be made first before any other connection is made. The product may be installed and connected only by a licensed electrician.
13. For permanently installed equipment without built-in fuses, circuit breakers or similar protective devices, the supply circuit must be fused in such a way that anyone who has access to the product, as well as the product itself, is adequately protected from injury or damage.

Basic Safety Instructions

14. Use suitable overvoltage protection to ensure that no overvoltage (such as that caused by a bolt of lightning) can reach the product. Otherwise, the person operating the product will be exposed to the danger of an electric shock.
15. Any object that is not designed to be placed in the openings of the housing must not be used for this purpose. Doing so can cause short circuits inside the product and/or electric shocks, fire or injuries.
16. Unless specified otherwise, products are not liquid-proof (see also section "Operating states and operating positions", item 1. Therefore, the equipment must be protected against penetration by liquids. If the necessary precautions are not taken, the user may suffer electric shock or the product itself may be damaged, which can also lead to personal injury.
17. Never use the product under conditions in which condensation has formed or can form in or on the product, e.g. if the product has been moved from a cold to a warm environment. Penetration by water increases the risk of electric shock.
18. Prior to cleaning the product, disconnect it completely from the power supply (e.g. AC supply network or battery). Use a soft, non-linting cloth to clean the product. Never use chemical cleaning agents such as alcohol, acetone or diluents for cellulose lacquers.

Operation

1. Operating the products requires special training and intense concentration. Make sure that persons who use the products are physically, mentally and emotionally fit enough to do so; otherwise, injuries or material damage may occur. It is the responsibility of the employer/operator to select suitable personnel for operating the products.
2. Before you move or transport the product, read and observe the section titled "Transport".
3. As with all industrially manufactured goods, the use of substances that induce an allergic reaction (allergens) such as nickel cannot be generally excluded. If you develop an allergic reaction (such as a skin rash, frequent sneezing, red eyes or respiratory difficulties) when using a Rohde & Schwarz product, consult a physician immediately to determine the cause and to prevent health problems or stress.
4. Before you start processing the product mechanically and/or thermally, or before you take it apart, be sure to read and pay special attention to the section titled "Waste disposal", item 1.
5. Depending on the function, certain products such as RF radio equipment can produce an elevated level of electromagnetic radiation. Considering that unborn babies require increased protection, pregnant women must be protected by appropriate measures. Persons with pacemakers may also be exposed to risks from electromagnetic radiation. The employer/operator must evaluate workplaces where there is a special risk of exposure to radiation and, if necessary, take measures to avert the potential danger.
6. Should a fire occur, the product may release hazardous substances (gases, fluids, etc.) that can cause health problems. Therefore, suitable measures must be taken, e.g. protective masks and protective clothing must be worn.
7. If a laser product (e.g. a CD/DVD drive) is integrated into a Rohde & Schwarz product, absolutely no other settings or functions may be used as described in the product documentation. The objective is to prevent personal injury (e.g. due to laser beams).

Repair and service

1. The product may be opened only by authorized, specially trained personnel. Before any work is performed on the product or before the product is opened, it must be disconnected from the AC supply network. Otherwise, personnel will be exposed to the risk of an electric shock.
2. Adjustments, replacement of parts, maintenance and repair may be performed only by electrical experts authorized by Rohde & Schwarz. Only original parts may be used for replacing parts relevant to safety (e.g. power switches, power transformers, fuses). A safety test must always be performed after parts relevant to safety have been replaced (visual inspection, PE conductor test, insulation resistance measurement, leakage current measurement, functional test). This helps ensure the continued safety of the product.

Batteries and rechargeable batteries/cells

If the information regarding batteries and rechargeable batteries/cells is not observed either at all or to the extent necessary, product users may be exposed to the risk of explosions, fire and/or serious personal injury, and, in some cases, death. Batteries and rechargeable batteries with alkaline electrolytes (e.g. lithium cells) must be handled in accordance with the EN 62133 standard.

1. Cells must not be taken apart or crushed.
2. Cells or batteries must not be exposed to heat or fire. Storage in direct sunlight must be avoided. Keep cells and batteries clean and dry. Clean soiled connectors using a dry, clean cloth.
3. Cells or batteries must not be short-circuited. Cells or batteries must not be stored in a box or in a drawer where they can short-circuit each other, or where they can be short-circuited by other conductive materials. Cells and batteries must not be removed from their original packaging until they are ready to be used.
4. Keep cells and batteries out of the hands of children. If a cell or a battery has been swallowed, seek medical aid immediately.
5. Cells and batteries must not be exposed to any mechanical shocks that are stronger than permitted.
6. If a cell develops a leak, the fluid must not be allowed to come into contact with the skin or eyes. If contact occurs, wash the affected area with plenty of water and seek medical aid.
7. Improperly replacing or charging cells or batteries that contain alkaline electrolytes (e.g. lithium cells) can cause explosions. Replace cells or batteries only with the matching Rohde & Schwarz type (see parts list) in order to ensure the safety of the product.
8. Cells and batteries must be recycled and kept separate from residual waste. Rechargeable batteries and normal batteries that contain lead, mercury or cadmium are hazardous waste. Observe the national regulations regarding waste disposal and recycling.

Transport

1. The product may be very heavy. Therefore, the product must be handled with care. In some cases, the user may require a suitable means of lifting or moving the product (e.g. with a lift-truck) to avoid back or other physical injuries.

2. Handles on the products are designed exclusively to enable personnel to transport the product. It is therefore not permissible to use handles to fasten the product to or on transport equipment such as cranes, fork lifts, wagons, etc. The user is responsible for securely fastening the products to or on the means of transport or lifting. Observe the safety regulations of the manufacturer of the means of transport or lifting. Noncompliance can result in personal injury or material damage.
3. If you use the product in a vehicle, it is the sole responsibility of the driver to drive the vehicle safely and properly. The manufacturer assumes no responsibility for accidents or collisions. Never use the product in a moving vehicle if doing so could distract the driver of the vehicle. Adequately secure the product in the vehicle to prevent injuries or other damage in the event of an accident.

Waste disposal

1. If products or their components are mechanically and/or thermally processed in a manner that goes beyond their intended use, hazardous substances (heavy-metal dust such as lead, beryllium, nickel) may be released. For this reason, the product may only be disassembled by specially trained personnel. Improper disassembly may be hazardous to your health. National waste disposal regulations must be observed.
2. If handling the product releases hazardous substances or fuels that must be disposed of in a special way, e.g. coolants or engine oils that must be replenished regularly, the safety instructions of the manufacturer of the hazardous substances or fuels and the applicable regional waste disposal regulations must be observed. Also observe the relevant safety instructions in the product documentation. The improper disposal of hazardous substances or fuels can cause health problems and lead to environmental damage.

Informaciones elementales de seguridad

Es imprescindible leer y observar las siguientes instrucciones e informaciones de seguridad!

El principio del grupo de empresas Rohde & Schwarz consiste en tener nuestros productos siempre al día con los estándares de seguridad y de ofrecer a nuestros clientes el máximo grado de seguridad. Nuestros productos y todos los equipos adicionales son siempre fabricados y examinados según las normas de seguridad vigentes. Nuestro sistema de garantía de calidad controla constantemente que sean cumplidas estas normas. El presente producto ha sido fabricado y examinado según el certificado de conformidad adjunto de la UE y ha salido de nuestra planta en estado impecable según los estándares técnicos de seguridad. Para poder preservar este estado y garantizar un funcionamiento libre de peligros, el usuario deberá atenerse a todas las indicaciones, informaciones de seguridad y notas de alerta. El grupo de empresas Rohde & Schwarz está siempre a su disposición en caso de que tengan preguntas referentes a estas informaciones de seguridad.

Además queda en la responsabilidad del usuario utilizar el producto en la forma debida. Este producto está destinado exclusivamente al uso en la industria y el laboratorio o, si ha sido expresamente autorizado, para aplicaciones de campo y de ninguna manera deberá ser utilizado de modo que alguna persona/cosa pueda sufrir daño. El uso del producto fuera de sus fines definidos o sin tener en cuenta las instrucciones del fabricante queda en la responsabilidad del usuario. El fabricante no se hace en ninguna forma responsable de consecuencias a causa del mal uso del producto.







Informaciones elementales de seguridad

Se parte del uso correcto del producto para los fines definidos si el producto es utilizado conforme a las indicaciones de la correspondiente documentación del producto y dentro del margen de rendimiento definido (ver hoja de datos, documentación, informaciones de seguridad que siguen). El uso del producto hace necesarios conocimientos técnicos y ciertos conocimientos del idioma inglés. Por eso se debe tener en cuenta que el producto solo pueda ser operado por personal especializado o personas instruidas en profundidad con las capacidades correspondientes. Si fuera necesaria indumentaria de seguridad para el uso de productos de Rohde & Schwarz, encontraría la información debida en la documentación del producto en el capítulo correspondiente. Guarde bien las informaciones de seguridad elementales, así como la documentación del producto, y entréguelas a usuarios posteriores.

Tener en cuenta las informaciones de seguridad sirve para evitar en lo posible lesiones o daños por peligros de toda clase. Por eso es imprescindible leer detalladamente y comprender por completo las siguientes informaciones de seguridad antes de usar el producto, y respetarlas durante el uso del producto. Deberán tenerse en cuenta todas las demás informaciones de seguridad, como p. ej. las referentes a la protección de personas, que encontrarán en el capítulo correspondiente de la documentación del producto y que también son de obligado cumplimiento. En las presentes informaciones de seguridad se recogen todos los objetos que distribuye el grupo de empresas Rohde & Schwarz bajo la denominación de "producto", entre ellos también aparatos, instalaciones así como toda clase de accesorios.

Símbolos y definiciones de seguridad

							
Aviso: punto de peligro general Observar la documentación del producto	Atención en el manejo de dispositivos de peso elevado	Peligro de choque eléctrico	Advertencia: superficie caliente	Conexión a conductor de protección	Conexión a tierra	Conexión a masa	Aviso: Cuidado en el manejo de dispositivos sensibles a la electrostática (ESD)

					
Tensión de alimentación de PUESTA EN MARCHA / PARADA	Indicación de estado de espera (Standby)	Corriente continua (DC)	Corriente alterna (AC)	Corriente continua / Corriente alterna (DC/AC)	El aparato está protegido en su totalidad por un aislamiento doble (reforzado)

Palabras de señal y su significado

En la documentación del producto se utilizan las siguientes palabras de señal con el fin de advertir contra riesgos y peligros.



PELIGRO identifica un peligro inminente con riesgo elevado que provocará muerte o lesiones graves si no se evita.



ADVERTENCIA identifica un posible peligro con riesgo medio de provocar muerte o lesiones (graves) si no se evita.



ATENCIÓN identifica un peligro con riesgo reducido de provocar lesiones leves o moderadas si no se evita.



AVISO indica la posibilidad de utilizar mal el producto y, como consecuencia, dañarlo.

En la documentación del producto se emplea de forma sinónima el término CUIDADO.

Las palabras de señal corresponden a la definición habitual para aplicaciones civiles en el área económica europea. Pueden existir definiciones diferentes a esta definición en otras áreas económicas o en aplicaciones militares. Por eso se deberá tener en cuenta que las palabras de señal aquí descritas sean utilizadas siempre solamente en combinación con la correspondiente documentación del producto y solamente en combinación con el producto correspondiente. La utilización de las palabras de señal en combinación con productos o documentaciones que no les correspondan puede llevar a interpretaciones equivocadas y tener por consecuencia daños en personas u objetos.

Estados operativos y posiciones de funcionamiento

El producto solamente debe ser utilizado según lo indicado por el fabricante respecto a los estados operativos y posiciones de funcionamiento sin que se obstruya la ventilación. Si no se siguen las indicaciones del fabricante, pueden producirse choques eléctricos, incendios y/o lesiones graves con posible consecuencia de muerte. En todos los trabajos deberán ser tenidas en cuenta las normas nacionales y locales de seguridad del trabajo y de prevención de accidentes.

1. Si no se convino de otra manera, es para los productos Rohde & Schwarz válido lo que sigue: como posición de funcionamiento se define por principio la posición con el suelo de la caja para abajo, modo de protección IP 2X, grado de suciedad 2, categoría de sobrecarga eléctrica 2, uso solamente en estancias interiores, utilización hasta 2000 m sobre el nivel del mar, transporte hasta 4500 m sobre el nivel del mar. Se aplicará una tolerancia de $\pm 10\%$ sobre el voltaje nominal y de $\pm 5\%$ sobre la frecuencia nominal.
2. No sitúe el producto encima de superficies, vehículos, estantes o mesas, que por sus características de peso o de estabilidad no sean aptos para él. Siga siempre las instrucciones de instalación del fabricante cuando instale y asegure el producto en objetos o estructuras (p. ej. paredes y estantes). Si se realiza la instalación de modo distinto al indicado en la documentación del producto, pueden causarse lesiones o incluso la muerte.
3. No ponga el producto sobre aparatos que generen calor (p. ej. radiadores o calefactores). La temperatura ambiente no debe superar la temperatura máxima especificada en la documentación del producto o en la hoja de datos. En caso de sobrecalentamiento del producto, pueden producirse choques eléctricos, incendios y/o lesiones graves con posible consecuencia de muerte.

Seguridad eléctrica

Si no se siguen (o se siguen de modo insuficiente) las indicaciones del fabricante en cuanto a seguridad eléctrica, pueden producirse choques eléctricos, incendios y/o lesiones graves con posible consecuencia de muerte.

1. Antes de la puesta en marcha del producto se deberá comprobar siempre que la tensión preseleccionada en el producto coincida con la de la red de alimentación eléctrica. Si es necesario modificar el ajuste de tensión, también se deberán cambiar en caso dado los fusibles correspondientes del producto.
2. Los productos de la clase de protección I con alimentación móvil y enchufe individual solamente podrán enchufarse a tomas de corriente con contacto de seguridad y con conductor de protección conectado.
3. Queda prohibida la interrupción intencionada del conductor de protección, tanto en la toma de corriente como en el mismo producto. La interrupción puede tener como consecuencia el riesgo de que el producto sea fuente de choques eléctricos. Si se utilizan cables alargadores o regletas de enchufe, deberá garantizarse la realización de un examen regular de los mismos en cuanto a su estado técnico de seguridad.
4. Si el producto no está equipado con un interruptor para desconectarlo de la red, se deberá considerar el enchufe del cable de conexión como interruptor. En estos casos se deberá asegurar que el enchufe siempre sea de fácil acceso (de acuerdo con la longitud del cable de conexión, aproximadamente 2 m). Los interruptores de función o electrónicos no son aptos para el corte de la red eléctrica. Si los productos sin interruptor están integrados en bastidores o instalaciones, se deberá colocar el interruptor en el nivel de la instalación.
5. No utilice nunca el producto si está dañado el cable de conexión a red. Compruebe regularmente el correcto estado de los cables de conexión a red. Asegúrese, mediante las medidas de protección y de instalación adecuadas, de que el cable de conexión a red no pueda ser dañado o de que nadie pueda ser dañado por él, p. ej. al tropezar o por un choque eléctrico.
6. Solamente está permitido el funcionamiento en redes de alimentación TN/TT aseguradas con fusibles de 16 A como máximo (utilización de fusibles de mayor amperaje solo previa consulta con el grupo de empresas Rohde & Schwarz).
7. Nunca conecte el enchufe en tomas de corriente sucias o llenas de polvo. Introduzca el enchufe por completo y fuertemente en la toma de corriente. La no observación de estas medidas puede provocar chispas, fuego y/o lesiones.
8. No sobrecargue las tomas de corriente, los cables alargadores o las regletas de enchufe ya que esto podría causar fuego o choques eléctricos.
9. En las mediciones en circuitos de corriente con una tensión $U_{\text{eff}} > 30 \text{ V}$ se deberán tomar las medidas apropiadas para impedir cualquier peligro (p. ej. medios de medición adecuados, seguros, limitación de tensión, corte protector, aislamiento etc.).
10. Para la conexión con dispositivos informáticos como un PC o un ordenador industrial, debe comprobarse que éstos cumplan los estándares IEC60950-1/EN60950-1 o IEC61010-1/EN 61010-1 válidos en cada caso.
11. A menos que esté permitido expresamente, no retire nunca la tapa ni componentes de la carcasa mientras el producto esté en servicio. Esto pone a descubierto los cables y componentes eléctricos y puede causar lesiones, fuego o daños en el producto.

12. Si un producto se instala en un lugar fijo, se deberá primero conectar el conductor de protección fijo con el conductor de protección del producto antes de hacer cualquier otra conexión. La instalación y la conexión deberán ser efectuadas por un electricista especializado.
13. En el caso de dispositivos fijos que no estén provistos de fusibles, interruptor automático ni otros mecanismos de seguridad similares, el circuito de alimentación debe estar protegido de modo que todas las personas que puedan acceder al producto, así como el producto mismo, estén a salvo de posibles daños.
14. Todo producto debe estar protegido contra sobretensión (debida p. ej. a una caída del rayo) mediante los correspondientes sistemas de protección. Si no, el personal que lo utilice quedará expuesto al peligro de choque eléctrico.
15. No debe introducirse en los orificios de la caja del aparato ningún objeto que no esté destinado a ello. Esto puede producir cortocircuitos en el producto y/o puede causar choques eléctricos, fuego o lesiones.
16. Salvo indicación contraria, los productos no están impermeabilizados (ver también el capítulo "Estados operativos y posiciones de funcionamiento", punto 1). Por eso es necesario tomar las medidas necesarias para evitar la entrada de líquidos. En caso contrario, existe peligro de choque eléctrico para el usuario o de daños en el producto, que también pueden redundar en peligro para las personas.
17. No utilice el producto en condiciones en las que pueda producirse o ya se hayan producido condensaciones sobre el producto o en el interior de éste, como p. ej. al desplazarlo de un lugar frío a otro caliente. La entrada de agua aumenta el riesgo de choque eléctrico.
18. Antes de la limpieza, desconecte por completo el producto de la alimentación de tensión (p. ej. red de alimentación o batería). Realice la limpieza de los aparatos con un paño suave, que no se deshilache. No utilice bajo ningún concepto productos de limpieza químicos como alcohol, acetona o diluyentes para lacas nitrocelulósicas.

Funcionamiento

1. El uso del producto requiere instrucciones especiales y una alta concentración durante el manejo. Debe asegurarse que las personas que manejen el producto estén a la altura de los requerimientos necesarios en cuanto a aptitudes físicas, psíquicas y emocionales, ya que de otra manera no se pueden excluir lesiones o daños de objetos. El empresario u operador es responsable de seleccionar el personal usuario apto para el manejo del producto.
2. Antes de desplazar o transportar el producto, lea y tenga en cuenta el capítulo "Transporte".
3. Como con todo producto de fabricación industrial no puede quedar excluida en general la posibilidad de que se produzcan alergias provocadas por algunos materiales empleados, los llamados alérgenos (p. ej. el níquel). Si durante el manejo de productos Rohde & Schwarz se producen reacciones alérgicas, como p. ej. irritaciones cutáneas, estornudos continuos, enrojecimiento de la conjuntiva o dificultades respiratorias, debe avisarse inmediatamente a un médico para investigar las causas y evitar cualquier molestia o daño a la salud.
4. Antes de la manipulación mecánica y/o térmica o el desmontaje del producto, debe tenerse en cuenta imprescindiblemente el capítulo "Eliminación", punto 1.

5. Ciertos productos, como p. ej. las instalaciones de radiocomunicación RF, pueden a causa de su función natural, emitir una radiación electromagnética aumentada. Deben tomarse todas las medidas necesarias para la protección de las mujeres embarazadas. También las personas con marcapasos pueden correr peligro a causa de la radiación electromagnética. El empresario/operador tiene la obligación de evaluar y señalar las áreas de trabajo en las que exista un riesgo elevado de exposición a radiaciones.
6. Tenga en cuenta que en caso de incendio pueden desprenderse del producto sustancias tóxicas (gases, líquidos etc.) que pueden generar daños a la salud. Por eso, en caso de incendio deben usarse medidas adecuadas, como p. ej. máscaras antigás e indumentaria de protección.
7. En caso de que un producto Rohde & Schwarz contenga un producto láser (p. ej. un lector de CD/DVD), no debe usarse ninguna otra configuración o función aparte de las descritas en la documentación del producto, a fin de evitar lesiones (p. ej. debidas a irradiación láser).

Reparación y mantenimiento

1. El producto solamente debe ser abierto por personal especializado con autorización para ello. Antes de manipular el producto o abrirlo, es obligatorio desconectarlo de la tensión de alimentación, para evitar toda posibilidad de choque eléctrico.
2. El ajuste, el cambio de partes, el mantenimiento y la reparación deberán ser efectuadas solamente por electricistas autorizados por Rohde & Schwarz. Si se reponen partes con importancia para los aspectos de seguridad (p. ej. el enchufe, los transformadores o los fusibles), solamente podrán ser sustituidos por partes originales. Después de cada cambio de partes relevantes para la seguridad deberá realizarse un control de seguridad (control a primera vista, control del conductor de protección, medición de resistencia de aislamiento, medición de la corriente de fuga, control de funcionamiento). Con esto queda garantizada la seguridad del producto.

Baterías y acumuladores o celdas

Si no se siguen (o se siguen de modo insuficiente) las indicaciones en cuanto a las baterías y acumuladores o celdas, pueden producirse explosiones, incendios y/o lesiones graves con posible consecuencia de muerte. El manejo de baterías y acumuladores con electrolitos alcalinos (p. ej. celdas de litio) debe seguir el estándar EN 62133.

1. No deben desmontarse, abrirse ni triturarse las celdas.
2. Las celdas o baterías no deben someterse a calor ni fuego. Debe evitarse el almacenamiento a la luz directa del sol. Las celdas y baterías deben mantenerse limpias y secas. Limpiar las conexiones sucias con un paño seco y limpio.
3. Las celdas o baterías no deben cortocircuitarse. Es peligroso almacenar las celdas o baterías en estuches o cajones en cuyo interior puedan cortocircuitarse por contacto recíproco o por contacto con otros materiales conductores. No deben extraerse las celdas o baterías de sus embalajes originales hasta el momento en que vayan a utilizarse.
4. Mantener baterías y celdas fuera del alcance de los niños. En caso de ingestión de una celda o batería, avisar inmediatamente a un médico.
5. Las celdas o baterías no deben someterse a impactos mecánicos fuertes indebidos.

Informaciones elementales de seguridad

6. En caso de falta de estanqueidad de una celda, el líquido vertido no debe entrar en contacto con la piel ni los ojos. Si se produce contacto, lavar con agua abundante la zona afectada y avisar a un médico.
7. En caso de cambio o recarga inadecuados, las celdas o baterías que contienen electrolitos alcalinos (p. ej. las celdas de litio) pueden explotar. Para garantizar la seguridad del producto, las celdas o baterías solo deben ser sustituidas por el tipo Rohde & Schwarz correspondiente (ver lista de recambios).
8. Las baterías y celdas deben reciclarse y no deben tirarse a la basura doméstica. Las baterías o acumuladores que contienen plomo, mercurio o cadmio deben tratarse como residuos especiales. Respete en esta relación las normas nacionales de eliminación y reciclaje.

Transporte

1. El producto puede tener un peso elevado. Por eso es necesario desplazarlo o transportarlo con precaución y, si es necesario, usando un sistema de elevación adecuado (p. ej. una carretilla elevadora), a fin de evitar lesiones en la espalda u otros daños personales.
2. Las asas instaladas en los productos sirven solamente de ayuda para el transporte del producto por personas. Por eso no está permitido utilizar las asas para la sujeción en o sobre medios de transporte como p. ej. grúas, carretillas elevadoras de horquilla, carros etc. Es responsabilidad suya fijar los productos de manera segura a los medios de transporte o elevación. Para evitar daños personales o daños en el producto, siga las instrucciones de seguridad del fabricante del medio de transporte o elevación utilizado.
3. Si se utiliza el producto dentro de un vehículo, recae de manera exclusiva en el conductor la responsabilidad de conducir el vehículo de manera segura y adecuada. El fabricante no asumirá ninguna responsabilidad por accidentes o colisiones. No utilice nunca el producto dentro de un vehículo en movimiento si esto pudiera distraer al conductor. Asegure el producto dentro del vehículo debidamente para evitar, en caso de un accidente, lesiones u otra clase de daños.

Eliminación

1. Si se trabaja de manera mecánica y/o térmica cualquier producto o componente más allá del funcionamiento previsto, pueden liberarse sustancias peligrosas (polvos con contenido de metales pesados como p. ej. plomo, berilio o níquel). Por eso el producto solo debe ser desmontado por personal especializado con formación adecuada. Un desmontaje inadecuado puede ocasionar daños para la salud. Se deben tener en cuenta las directivas nacionales referentes a la eliminación de residuos.
2. En caso de que durante el trato del producto se formen sustancias peligrosas o combustibles que deban tratarse como residuos especiales (p. ej. refrigerantes o aceites de motor con intervalos de cambio definidos), deben tenerse en cuenta las indicaciones de seguridad del fabricante de dichas sustancias y las normas regionales de eliminación de residuos. Tenga en cuenta también en caso necesario las indicaciones de seguridad especiales contenidas en la documentación del producto. La eliminación incorrecta de sustancias peligrosas o combustibles puede causar daños a la salud o daños al medio ambiente.

Kundeninformation zur Batterieverordnung (BattV)

Dieses Gerät enthält eine schadstoffhaltige Batterie. Diese darf nicht mit dem Hausmüll entsorgt werden.

Nach Ende der Lebensdauer darf die Entsorgung nur über eine Rohde&Schwarz-Kundendienststelle oder eine geeignete Sammelstelle erfolgen.

Safety Regulations for Batteries (according to BattV)

This equipment houses a battery containing harmful substances that must not be disposed of as normal household waste.

After its useful life, the battery may only be disposed of at a Rohde & Schwarz service center or at a suitable depot.

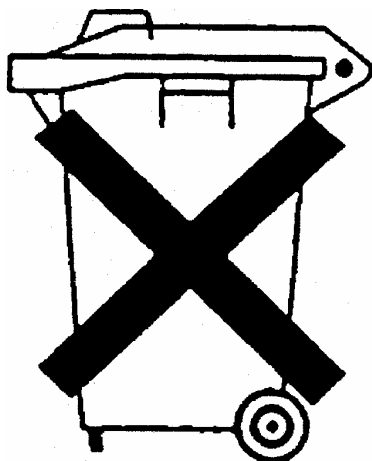

Normas de Seguridad para Baterías (Según BattV)

Este equipo lleva una batería que contiene sustancias perjudiciales, que no se debe desechar en los contenedores de basura domésticos.

Después de la vida útil, la batería sólo se podrá eliminar en un centro de servicio de Rohde & Schwarz o en un depósito apropiado.

Consignes de sécurité pour batteries (selon BattV)

Cet appareil est équipé d'une pile comprenant des substances nocives. Ne jamais la jeter dans une poubelle pour ordures ménagères.

Une pile usagée doit uniquement être éliminée par un centre de service client de Rohde & Schwarz ou peut être collectée pour être traitée spécialement comme déchets dangereux.

Customer Information Regarding Product Disposal

The German Electrical and Electronic Equipment (ElektroG) Act is an implementation of the following EC directives:

- 2002/96/EC on waste electrical and electronic equipment (WEEE) and
- 2002/95/EC on the restriction of the use of certain hazardous substances in electrical and electronic equipment (RoHS).

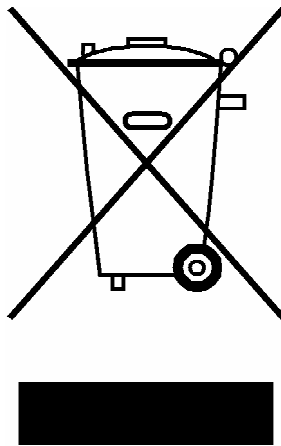

Product labeling in accordance with EN 50419

Once the lifetime of a product has ended, this product must not be disposed of in the standard domestic refuse. Even disposal via the municipal collection points for waste electrical and electronic equipment is not permitted.

Rohde & Schwarz GmbH & Co. KG has developed a disposal concept for the environmental-friendly disposal or recycling of waste material and fully assumes its obligation as a producer to take back and dispose of electrical and electronic waste in accordance with the ElektroG Act.

Please contact your local service representative to dispose of the product.



Certified Quality System

DIN EN ISO 9001 : 2000
DIN EN 9100 : 2003
DIN EN ISO 14001 : 2004

DQS REG. NO 001954 QM UM

QUALITÄTSZERTIFIKAT

Sehr geehrter Kunde,
Sie haben sich für den Kauf eines Rohde & Schwarz-Produktes entschieden. Hiermit erhalten Sie ein nach modernsten Fertigungsmethoden hergestelltes Produkt. Es wurde nach den Regeln unseres Managementsystems entwickelt, gefertigt und geprüft. Das Rohde & Schwarz Managementsystem ist zertifiziert nach:

DIN EN ISO 9001:2000
DIN EN 9100:2003
DIN EN ISO 14001:2004

CERTIFICATE OF QUALITY

Dear Customer,
you have decided to buy a Rohde & Schwarz product. You are thus assured of receiving a product that is manufactured using the most modern methods available. This product was developed, manufactured and tested in compliance with our quality management system standards. The Rohde & Schwarz quality management system is certified according to:

DIN EN ISO 9001:2000
DIN EN 9100:2003
DIN EN ISO 14001:2004

CERTIFICAT DE QUALITÉ

Cher Client,
vous avez choisi d'acheter un produit Rohde & Schwarz. Vous disposez donc d'un produit fabriqué d'après les méthodes les plus avancées. Le développement, la fabrication et les tests respectent nos normes de gestion qualité. Le système de gestion qualité de Rohde & Schwarz a été homologué conformément aux normes:

DIN EN ISO 9001:2000
DIN EN 9100:2003
DIN EN ISO 14001:2004





ROHDE & SCHWARZ
EC Certificate of Conformity



Certificate No.: 2005-06

This is to certify that:

Equipment type	Stock No.	Designation
FSL3	1300.2502.03/.13	Spectrum Analyzer
FSL6	1300.2502.06/.16	
FSL18	1300.2502.18/.28	
FSL-B4	1300.6008.02	OCXO Reference Frequency
FSL-B5	1300.6108.02	Additional Interfaces
FSL-B7	1300.5601.02	Narrow Resolution Filters
FSL-B8	1300.5701.02	Gated Sweep Function
FSL-B10	1300.6208.02	GPIB Interface
FSL-B22	1300.5953.02	RF Amplifier
FSL-B30	1300.6308.02	DC Power Supply
FSL-B31	1300.6408.02	NIMH Battery Pack
FSL-Z4	1300.5430.02	Additional Charger Unit

complies with the provisions of the Directive of the Council of the European Union on the approximation of the laws of the Member States

- relating to electrical equipment for use within defined voltage limits (2006/95/EC)
- relating to electromagnetic compatibility (2004/108/EC)

Conformity is proven by compliance with the following standards:

EN61010-1 : 2001-12
EN55011 : 1998 + A1 : 1999 + A2 : 2002, Class B
EN61326 : 1997 + A1 : 1998 + A2 : 2001 + A3 : 2003

For the assessment of electromagnetic compatibility, the limits of radio interference for Class B equipment as well as the immunity to interference for operation in industry have been used as a basis.

Affixing the EC conformity mark as from 2005

Munich, 2008-12-02

ROHDE & SCHWARZ GmbH & Co. KG
Mühldorfstr. 15, D-81671 München

Central Quality Management MF-QZ / Radde

Customer Support

Technical support – where and when you need it

For quick, expert help with any Rohde & Schwarz equipment, contact one of our Customer Support Centers. A team of highly qualified engineers provides telephone support and will work with you to find a solution to your query on any aspect of the operation, programming or applications of Rohde & Schwarz equipment.

Up-to-date information and upgrades

To keep your instrument up-to-date and to be informed about new application notes related to your instrument, please send an e-mail to the Customer Support Center stating your instrument and your wish. We will take care that you will get the right information.

USA & Canada

Monday to Friday (except US public holidays)
8:00 AM – 8:00 PM Eastern Standard Time (EST)

Tel. from USA 888-test-rsa (888-837-8772) (opt 2)
From outside USA +1 410 910 7800 (opt 2)
Fax +1 410 910 7801
E-mail CustomerSupport@rohde-schwarz.com

East Asia

Monday to Friday (except Singaporean public holidays)
8:30 AM – 6:00 PM Singapore Time (SGT)

Tel. +65 6 513 0488
Fax +65 6 846 1090
E-mail CustomerSupport@rohde-schwarz.com

Rest of the World

Monday to Friday (except German public holidays)
08:00 – 17:00 Central European Time (CET)

Tel. from Europe +49 (0) 180 512 42 42*
From outside Europe +49 89 4129 13776
Fax +49 (0) 89 41 29 637 78
E-mail CustomerSupport@rohde-schwarz.com

* 0.14 €/Min within the German fixed-line telephone network, varying prices for the mobile telephone network and in different countries.



Address List

Headquarters, Plants and Subsidiaries

Headquarters

ROHDE & SCHWARZ GmbH & Co. KG
Mühlendorfstraße 15 · D-81671 München
P.O.Box 80 14 69 · D-81614 München

Phone +49 (89) 41 29-0
Fax +49 (89) 41 29-121 64
info.rs@rohde-schwarz.com

Plants

ROHDE & SCHWARZ Messgerätebau GmbH
Riedbachstraße 58 · D-87700 Memmingen
P.O.Box 16 52 · D-87686 Memmingen

Phone +49 (83 31) 1 08-0
+49 (83 31) 1 08-1124
info.rsmb@rohde-schwarz.com

ROHDE & SCHWARZ GmbH & Co. KG
Werk Teisnach
Kaikenrieder Straße 27 · D-94244 Teisnach
P.O.Box 11 49 · D-94240 Teisnach

Phone +49 (99 23) 8 50-0
Fax +49 (99 23) 8 50-174
info.rsdt@rohde-schwarz.com

ROHDE & SCHWARZ závod
Vimperk, s.r.o.
Location Spidrova 49
CZ-38501 Vimperk

Phone +420 (388) 45 21 09
Fax +420 (388) 45 21 13

ROHDE & SCHWARZ GmbH & Co. KG
Dienstleistungszentrum Köln
Graf-Zeppelin-Straße 18 · D-51147 Köln
P.O.Box 98 02 60 · D-51130 Köln

Phone +49 (22 03) 49-0
Fax +49 (22 03) 49 51-229
info.rsd@rohde-schwarz.com
service.rsd@rohde-schwarz.com

Subsidiaries

R&S BICK Mobilfunk GmbH
Fritz-Hahne-Str. 7 · D-31848 Bad Münder
P.O.Box 20 02 · D-31844 Bad Münder

Phone +49 (50 42) 9 98-0
Fax +49 (50 42) 9 98-105
info.bick@rohde-schwarz.com

ROHDE & SCHWARZ FTK GmbH
Wendenschloßstraße 168, Haus 28
D-12557 Berlin

Phone +49 (30) 658 91-122
Fax +49 (30) 655 50-221
info.ftk@rohde-schwarz.com

ROHDE & SCHWARZ SIT GmbH
Am Studio 3
D-12489 Berlin

Phone +49 (30) 658 84-0
Fax +49 (30) 658 84-183
info.sit@rohde-schwarz.com

R&S Systems GmbH
Graf-Zeppelin-Straße 18
D-51147 Köln

Phone +49 (22 03) 49-5 23 25
Fax +49 (22 03) 49-5 23 36
info.rssys@rohde-schwarz.com

GEDIS GmbH
Sophienblatt 100
D-24114 Kiel

Phone +49 (431) 600 51-0
Fax +49 (431) 600 51-11
sales@gedis-online.de

HAMEG Instruments GmbH
Industriestraße 6
D-63533 Mainhausen

Phone +49 (61 82) 800-0
Fax +49 (61 82) 800-100
info@hameg.de

Locations Worldwide

Please refer to our homepage: www.rohde-schwarz.com

- ◆ Sales Locations
- ◆ Service Locations
- ◆ National Websites

Documentation Overview

The user documentation for the R&S FSL is divided as follows:

- Quick Start Guide
- Online Help
- Operating Manual
- Internet Site
- Service Manual
- Release Notes

Quick Start Guide

This manual is delivered with the instrument in printed form and in PDF format on the CD. It provides the information needed to set up and start working with the instrument. Basic operations and basic measurements are described. Also a brief introduction to remote control is given. The manual includes general information (e.g. Safety Instructions) and the following chapters:

Chapter 1	Front and Rear Panel
Chapter 2	Putting into Operation
Chapter 3	Firmware Update and Installation of Firmware Options
Chapter 4	Basic Operations
Chapter 5	Basic Measurement Examples
Chapter 6	Brief Introduction to Remote Control
Appendix A	Printer Interface
Appendix B	LAN Interface

Online Help

The Online Help is part of the firmware. It provides a quick access to the description of the instrument functions and the remote control commands. For information on other topics refer to the Quick Start Guide, Operating Manual and Service Manual provided in PDF format on CD or in the Internet. For detailed information on how to use the Online Help, refer to the chapter "Basic Operations" in the Quick Start Guide.

Operating Manual

This manual is a supplement to the Quick Start Guide and is available in PDF format on the CD delivered with the instrument. To retain the familiar structure that applies to all operating manuals of Rohde&Schwarz Test & Measurement instruments, the chapters 1 and 3 exist, but only in form of references to the corresponding Quick Start Guide chapters.

In this manual, all instrument functions are described in detail. For additional information on default settings and parameters, refer to the data sheets. The set of measurement examples in the Quick Start Guide is expanded by more advanced measurement examples. In addition to the brief introduction to remote control in the Quick Start Guide, a description of the commands and programming examples is given. Information on maintenance, instrument interfaces and error messages is also provided.

The manual includes the following chapters:

Chapter 1	Putting into Operation, see Quick Start Guide chapters 1 and 2
Chapter 2	Advanced Measurement Examples
Chapter 3	Manual Operation, see Quick Start Guide chapter 4
Chapter 4	Instrument Functions
Chapter 5	Remote Control - Basics
Chapter 6	Remote Control - Commands
Chapter 7	Remote Control - Programming Examples
Chapter 8	Maintenance
Chapter 9	Error Messages

This manual is delivered with the instrument on CD only. The printed manual can be ordered from Rohde & Schwarz GmbH & Co. KG.

Internet Site

The Internet site at: [R&S FSL Spectrum Analyzer](#) provides the most up to date information on the R&S FSL. The current operating manual at a time is available as printable PDF file in the download area. Also provided for download are firmware updates including the associated release notes, instrument drivers, current data sheets and application notes.

Service Manual

This manual is available in PDF format on the CD delivered with the instrument. It informs on how to check compliance with rated specifications, on instrument function, repair, troubleshooting and fault elimination. It contains all information required for repairing the R&S FSL by the replacement of modules. The manual includes the following chapters:

Chapter 1	Performance Test
Chapter 2	Adjustment
Chapter 3	Repair
Chapter 4	Software Update / Installing Options
Chapter 5	Documents

Release Notes

The release notes describe the installation of the firmware, new and modified functions, eliminated problems, and last minute changes to the documentation. The corresponding firmware version is indicated on the title page of the release notes. The current release notes are provided in the Internet.

Conventions Used in the Documentation

To visualize important information quickly and to recognize information types faster, a few conventions has been introduced. The following character formats are used to emphasize words:

Bold	All names of graphical user interface elements as dialog boxes, softkeys, lists, options, buttons etc. All names of user interface elements on the front and rear panel as keys, connectors etc.
Courier	All remote commands (apart from headings, see below)
Capital letters	All key names (front panel or keyboard)

The description of a softkey (Operating Manual and Online Help) always starts with the softkey name, and is followed by explaining text and one or more remote control commands framed by two lines. Each remote command is placed in a single line.

The description of remote control commands (Operating Manual and Online Help) always starts with the command itself, and is followed by explaining text including an example, the characteristics and the mode (standard or only with certain options) framed by two grey lines. The remote commands consist of abbreviations to accelerate the procedure. All parts of the command that have to be entered are in capital letters, the rest is added in small letters to complete the words and transport their meaning.

1 Putting into Operation

For details refer to the Quick Start Guide chapters 1, "Front and Rear Panel", and 2, "Preparing for Use".

Contents of Chapter 2

2	Advanced Measurement Examples	2.1
	Test Setup	2.2
	Measurement of Harmonics	2.2
	High-Sensitivity Harmonics Measurements	2.4
	Measuring the Spectra of Complex Signals	2.6
	Separating Signals by Selecting an Appropriate Resolution Bandwidth	2.6
	Intermodulation Measurements	2.7
	Measurement example - Measuring the R&S FSL's intrinsic intermodulation.....	2.9
	Measuring Signals in the Vicinity of Noise	2.12
	Measurement example - Measuring level at low S/N ratios	2.13
	Noise Measurements	2.16
	Measuring Noise Power Density.....	2.16
	Measurement example - Measuring the intrinsic noise power density of the R&S FSL at 1 GHz and calculating the R&S FSL's noise figure	2.16
	Measurement of Noise Power within a Transmission Channel.....	2.18
	Measurement example - Measuring the intrinsic noise of the R&S FSL at 1 GHz in a 1.23 MHz channel bandwidth with the channel power function.....	2.19
	Measuring Phase Noise.....	2.22
	Measurement example - Measuring the phase noise of a signal generator at a carrier offset of 10 kHz	2.22
	Measurements on Modulated Signals	2.24
	Measuring Channel Power and Adjacent Channel Power	2.24
	Measurement example 1 - ACPR measurement on an CDMA 2000 signal.....	2.25
	Measurement example 2 - Measuring adjacent channel power of a W-CDMA uplink signal.....	2.29
	Amplitude Distribution Measurements.....	2.32
	Measurement example - Measuring the APD and CCDF of white noise generated by the R&S FSL	2.33
	Bluetooth Measurements (Option K8).....	2.35
	Bluetooth Overview.....	2.35
	Bluetooth technical parameters	2.35
	Power classes	2.36
	Structure of a Bluetooth data packet	2.36
	Supported Tests	2.37
	Overview of Transmitter Tests.....	2.37
	Functional Description - Block Diagram	2.39
	Bandwidths	2.39
	Measurement Filter (Meas Filter On).....	2.40
	Oversampling.....	2.40
	Determining Average or Max/Min Values	2.41
	Impact of the sweep count on the measurement results.....	2.42
	Trigger Concepts	2.42
	Cable TV Measurements (Option K20)	2.44

Analog TV Basics	2.44
Analog TV Measurement Examples	2.46
Analog TV settings	2.46
Analog TV test setup	2.47
Spectrum measurement	2.48
Carriers measurement	2.49
Video Scope measurement	2.50
Vision Modulation measurement	2.51
Hum measurement	2.52
C/N measurement	2.53
CSO measurement	2.58
CTB measurement	2.61
Digital TV Basics	2.62
Digital TV Measurement Examples	2.68
Digital TV settings	2.68
Digital TV test setup	2.69
Spectrum measurement	2.69
Overview measurement	2.70
Constellation Diagram measurement (modulation analysis)	2.72
Modulation Errors measurement (modulation analysis)	2.73
Echo Pattern measurement (channel analysis)	2.74
Channel Power measurement	2.76
APD measurement	2.77
CCDF measurement	2.78
TV Analyzer Measurements	2.79
Tilt measurement	2.79
Channel Tables and Modulation Standards	2.80
Channel tables	2.81
Modulation standards	2.82
Example: Creating a channel table	2.87
Example: Restoring the default channel tables	2.93
Performing a Measurement without a Channel Table	2.93
Performing a Measurement Using a Channel Table	2.95
Noise Figure Measurements Option (K30)	2.99
Direct Measurements	2.99
Basic Measurement Example	2.99
DUTs with very Large Gain	2.101
Frequency-Converting Measurements	2.102
Fixed LO Measurements	2.102
Image-Frequency Rejection (SSB, DSB)	2.102
3GPP Base Station Measurements (Option K72)	2.106
Measuring the Signal Channel Power	2.106
Measuring the Spectrum Emission Mask	2.108
Measuring the Relative Code Domain Power	2.109
Synchronization of the reference frequencies	2.110
Behavior with deviating center frequency setting	2.110

Behavior with incorrect scrambling code	2.111
Measuring the Relative Code Domain Power Triggered	2.111
Trigger offset	2.112
Setup for Base Station Tests	2.112
Standard test setup	2.113
Basic settings	2.113
CDMA2000 Base Station Measurements (Option K82)	2.114
Measuring the Signal Channel Power	2.114
Measuring the Spectrum Emission Mask	2.116
Measuring the Relative Code Domain Power and the Frequency Error	2.117
Synchronization of the reference frequencies	2.119
Behavior with deviating center frequency setting	2.119
Measuring the triggered Relative Code Domain Power	2.120
Adjusting the trigger offset	2.121
Behaviour with the wrong PN offset	2.122
Measuring the Composite EVM	2.123
Measuring the Peak Code Domain Error and the RHO Factor	2.124
Displaying RHO	2.125
Test Setup for Base Station Tests	2.126
WLAN TX Measurements (Option K91 / K91n)	2.128
Signal Processing of the IEEE 802.11a application	2.128
Abbreviations	2.128
Literature	2.133
Signal Processing of the IEEE 802.11b application	2.133
Abbreviations	2.133
Literature	2.137
802.11b RF carrier suppression	2.137
Definition	2.137
Measurement with the R&S FSL	2.137
Comparison to IQ offset measurement in K91 / K91n list mode	2.138
IQ Impairments	2.139
IQ Offset	2.139
Gain Imbalance	2.139
Quadrature Error	2.140
WiMAX, WiBro Measurements (Options K92/K93)	2.141
Basic Measurement Example	2.141
Setting up the measurement	2.141
Performing the level detection	2.143
Performing the main measurement	2.143
Signal Processing of the IEEE 802.16-2004 OFDM Measurement Application	2.143
Analysis Steps	2.147
Subchannelization	2.148
Synchronization	2.148
Channel Results	2.148
Frequency and Clock Offset	2.149
EVM	2.149

IQ Impairments	2.150
RSSI	2.151
CINR	2.151
Literature	2.151
Signal Processing of the IEEE802.16-2005 OFDMA/WiBro Measurement Application	2.152
Introduction	2.153
Signal Processing Block Diagram	2.154
Synchronization	2.154
Channel Estimation / Equalization	2.155
Analysis	2.155
Literature	2.157

2 Advanced Measurement Examples

This chapter explains how to operate the R&S FSL using typical measurements as examples. Additional background information on the settings is given. Examples of more basic character are provided in the Quick Start Guide, chapter 5, as an introduction. The following topics are included in the Quick Start Guide:

- Performing a Level and Frequency Measurement
- Measuring a Sinusoidal Signal
 - Measuring the Level and Frequency Using Markers
 - Measuring the Signal Frequency Using the Frequency Counter
- Measuring Harmonics of Sinusoidal Signals
 - Measuring the Suppression of the First and Second Harmonic of an Input Signal
- Measuring Signal Spectra with Multiple Signals
 - Separating Signals by Selecting the Resolution Bandwidth
 - Measuring the Modulation Depth of an AM-Modulated Carrier (Span > 0)
 - Measuring of AM-Modulated Signals
- Measurements with Zero Span
 - Measuring the Power Characteristic of Burst Signals
 - Measuring the Signal-to-Noise Ratio of Burst Signals
 - Measurement of FM-Modulated Signals
- Storing and Loading Instrument Settings
 - Storing an Instrument Configuration (without Traces)
 - Storing Traces
 - Loading an Instrument Configuration (with Traces)
 - Configuring Automatic Loading

Test Setup

All of the following examples are based on the standard settings of the R&S FSL. These are set with the **PRESET** key. A complete listing of the standard settings can be found in chapter "Instrument Functions", section "Initializing the Configuration - PRESET Key".

In the following examples, a signal generator is used as a signal source. The RF output of the signal generator is connected to the RF input of R&S FSL.

If a 65 MHz signal is required for the test setup, as an alternative to the signal generator, the internal 65 MHz reference generator can be used:

1. Switch on the internal reference generator.
 - Press the **SETUP** key.
 - Press the **Service** softkey.
 - Press the **Input RF/Cal/TG** softkey, until **Cal** is highlighted.

The internal 65 MHz reference generator is now on. The R&S FSL's RF input is switched off.
2. Switch on the RF input again for normal operation of the R&S FSL. Two ways are possible:
 - Press the **PRESET** key
 - Press the **SETUP** key.
 - Press the **Service** softkey.
 - Press the **Input RF/Cal/TG** softkey, until **RF** is highlighted.

The internal signal path of the R&S FSL is switched back to the RF input in order to resume normal operation.

Measurement of Harmonics

Measuring the harmonics of a signal is a frequent problem which can be solved best by means of a spectrum analyzer. In general, every signal contains harmonics which are larger than others. Harmonics are particularly critical regarding high-power transmitters such as transceivers because large harmonics can interfere with other radio services.

Harmonics are generated by nonlinear characteristics. They can often be reduced by lowpass filters. Since the spectrum analyzer has a nonlinear characteristic, e.g. in its first mixer, measures must be taken to ensure that harmonics produced in the spectrum analyzer do not cause spurious results. If necessary, the fundamental wave must be selectively attenuated with respect to the other harmonics with a highpass filter.

When harmonics are being measured, the obtainable dynamic range depends on the second harmonic intercept of the spectrum analyzer. The second harmonic intercept is the virtual input level at the RF input mixer at which the level of the 2nd harmonic becomes equal to the level of the fundamental wave. In practice, however, applying a level of this magnitude would damage the mixer. Nevertheless the available dynamic range for measuring the harmonic distance of a DUT can be calculated relatively easily using the second harmonic intercept.

As shown in [Fig. 2-1](#), the level of the 2nd harmonic drops by 20 dB if the level of the fundamental wave is reduced by 10 dB.

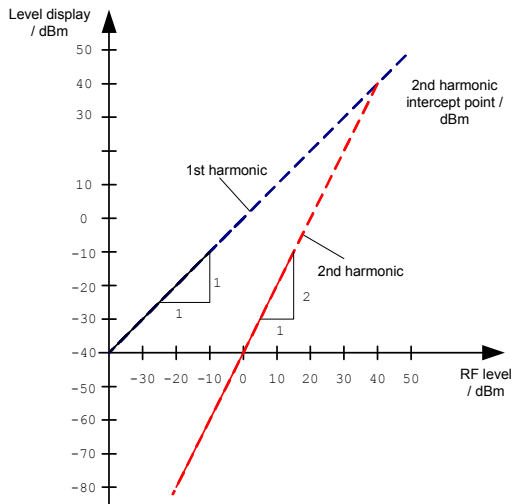

Fig. 2-1 Extrapolation of the 1st and 2nd harmonics to the 2nd harmonic intercept at 40 dBm

The following formula for the obtainable harmonic distortion d_2 in dB is derived from the straight-line equations and the given intercept point:

$$d_2 = S.H.I - P_1 \quad (1)$$

d_2 = harmonic distortion

P_1 = mixer level/dBm

S.H.I. = second harmonic intercept



The mixer level is the RF level applied to the RF input minus the set RF attenuation.

The formula for the internally generated level P_1 at the 2nd harmonic in dBm is:

$$P_1 = 2 \cdot P_I - S.H.I. \quad (2)$$

The lower measurement limit for the harmonic is the noise floor of the spectrum analyzer. The harmonic of the measured DUT should - if sufficiently averaged by means of a video filter - be at least 4 dB above the noise floor so that the measurement error due to the input noise is less than 1 dB.

The following rules for measuring high harmonic ratios can be derived:

- Select the smallest possible IF bandwidth for a minimal noise floor.
- Select an RF attenuation which is high enough to just measure the harmonic ratio.

The maximum harmonic distortion is obtained if the level of the harmonic equals the intrinsic noise level of the receiver. The level applied to the mixer, according to (2), is:

$$P_I = \frac{P_{noise} \text{ / dBm} + IP2}{2} \quad (3)$$

At a resolution bandwidth of 10 Hz (noise level -143 dBm, S.H.I. = 40 dBm), the optimum mixer level is - 51.5 dBm. According to (1) a maximum measurable harmonic distortion of 91.5 dB minus a minimum S/N ratio of 4 dB is obtained.



If the harmonic emerges from noise sufficiently (approx. >15 dB), it is easy to check (by changing the RF attenuation) whether the harmonics originate from the DUT or are generated internally by the spectrum analyzer. If a harmonic originates from the DUT, its level remains constant if the RF attenuation is increased by 10 dB. Only the displayed noise is increased by 10 dB due to the additional attenuation. If the harmonic is exclusively generated by the spectrum analyzer, the level of the harmonic is reduced by 20 dB or is lost in noise. If both - the DUT and the spectrum analyzer - contribute to the harmonic, the reduction in the harmonic level is correspondingly smaller.

High-Sensitivity Harmonics Measurements

If harmonics have very small levels, the resolution bandwidth required to measure them must be reduced considerably. The sweep time is, therefore, also increased considerably. In this case, the measurement of individual harmonics is carried out with the R&S FSL set to a small span. Only the frequency range around the harmonics will then be measured with a small resolution bandwidth.

Signal generator settings (e.g. R&S SMU):

Frequency: 128 MHz

Level: -25 dBm

Procedure:

1. Set the R&S FSL to its default state.
 - Press the **PRESET** key.
The R&S FSL is set to its default state.
2. Set the center frequency to 128 MHz and the span to 100 kHz.
 - Press the **FREQ** key.
The frequency menu is displayed.
 - In the dialog box, enter *128* using the numeric keypad and confirm with the **MHz** key.
 - Press the **SPAN** key.
 - In the dialog box, enter *100* using the numeric keypad and confirm with the **kHz** key.
The R&S FSL displays the reference signal with a span of 100 kHz and resolution bandwidth of 3 kHz.
3. Switching on the marker.
 - Press the **MKR** key.
The marker is positioned on the trace maximum.
4. Set the measured signal frequency and the measured level as reference values
 - Press the Phase Noise/Ref Fixed softkey.

The position of the marker becomes the reference point. The reference point level is indicated by a horizontal line, the reference point frequency with a vertical line. At the same time, the delta marker 2 is switched on.

- Press the **Ref Fixed** softkey.

The mode changes from phase noise measurement to reference fixed, the marker readout changes from dB/Hz to dB.

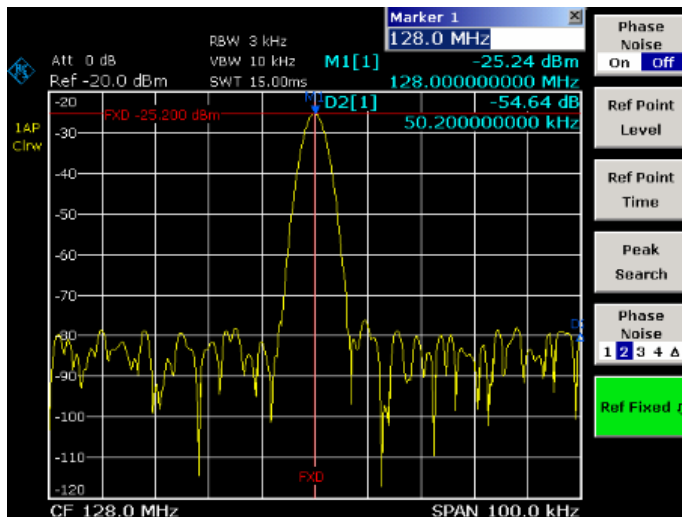

Fig. 2-2 Fundamental wave and the frequency and level reference point

5. Make the step size for the center frequency equal to the signal frequency
 - Press the **FREQ** key.
The frequency menu is displayed.
 - Press the **CF-Stepsize** softkey and press the = **Marker** softkey in the submenu.
The step size for the center frequency is now equal to the marker frequency.
6. Set the center frequency to the 2nd harmonic of the signal
 - Press the **FREQ** key.
The frequency menu is displayed.
 - Press the **UPARROW** key once.
The center frequency is set to the 2nd harmonic.
7. Place the delta marker on the 2nd harmonic.
 - Press the **MKR->** key.
 - Press the **Peak** softkey.
The delta marker moves to the maximum of the 2nd harmonic. The displayed level result is relative to the reference point level (= fundamental wave level).

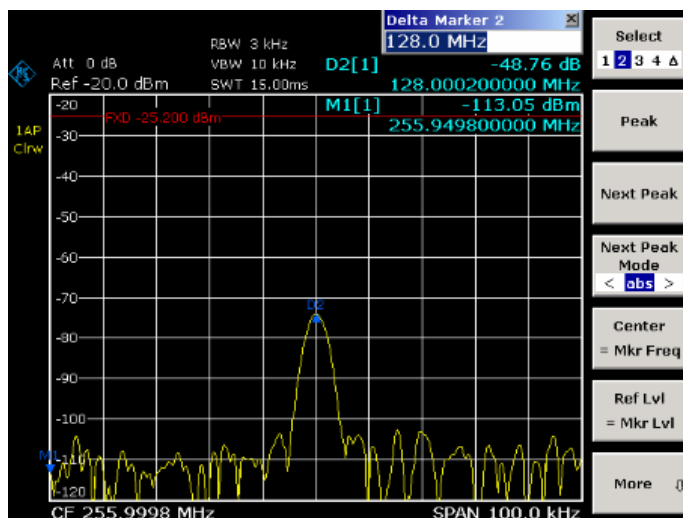

Fig. 2-3 Measuring the level difference between the fundamental wave (= reference point level) and the 2nd harmonic

The other harmonics are measured with steps 5 and 6, the center frequency being incremented or decremented in steps of 128 MHz using the **UPARROW** or **DNARROW** key.

Measuring the Spectra of Complex Signals

Separating Signals by Selecting an Appropriate Resolution Bandwidth

A basic feature of a spectrum analyzer is being able to separate the spectral components of a mixture of signals. The resolution at which the individual components can be separated is determined by the resolution bandwidth. Selecting a resolution bandwidth that is too large may make it impossible to distinguish between spectral components, i.e. they are displayed as a single component.

An RF sinusoidal signal is displayed by means of the passband characteristic of the resolution filter (RBW) that has been set. Its specified bandwidth is the 3 dB bandwidth of the filter.

Two signals with the same amplitude can be resolved if the resolution bandwidth is smaller than or equal to the frequency spacing of the signal. If the resolution bandwidth is equal to the frequency spacing, the spectrum display screen shows a level drop of 3 dB precisely in the center of the two signals. Decreasing the resolution bandwidth makes the level drop larger, which thus makes the individual signals clearer.

If there are large level differences between signals, the resolution is determined by selectivity as well as by the resolution bandwidth that has been selected. The measure of selectivity used for spectrum analyzers is the ratio of the 60 dB bandwidth to the 3 dB bandwidth (= shape factor).

For the R&S FSL, the shape factor for bandwidths is < 5, i.e. the 60 dB bandwidth of the 30 kHz filter is < 150 kHz.

The higher spectral resolution with smaller bandwidths is won by longer sweep times for the same span. The sweep time has to allow the resolution filters to settle during a sweep at all signal levels and frequencies to be displayed. It is given by the following formula.

$$SWT = k \cdot \text{Span} / \text{RBW}^2 \quad (4)$$

- SWT = max. sweep time for correct measurement
- k = factor depending on type of resolution filter
= 1 for digital IF filters
- Span = frequency display range
- RBW = resolution bandwidth

If the resolution bandwidth is reduced by a factor of 3, the sweep time is increased by a factor of 9.



The impact of the video bandwidth on the sweep time is not taken into account in (4). For the formula to be applied, the video bandwidth must be $\geq 3 \times$ the resolution bandwidth.

FFT filters can be used for resolution bandwidths up to 30 kHz. Like digital filters, they have a shape factor of less than 5 up to 30 kHz. For FFT filters, however, the sweep time is given by the following formula:

$$SWT = k \cdot \text{span} / \text{RBW} \quad (5)$$

If the resolution bandwidth is reduced by a factor of 3, the sweep time is increased by a factor of 3 only.

Intermodulation Measurements

If several signals are applied to a transmission two-port device with nonlinear characteristic, intermodulation products appear at its output by the sums and differences of the signals. The nonlinear characteristic produces harmonics of the useful signals which intermodulate at the characteristic. The intermodulation products of lower order have a special effect since their level is largest and they are near the useful signals. The intermodulation product of third order causes the highest interference. It is the intermodulation product generated from one of the useful signals and the 2nd harmonic of the second useful signal in case of two-tone modulation.

The frequencies of the intermodulation products are above and below the useful signals. Fig. 2-4 shows intermodulation products P_{U1} and P_{U2} generated by the two useful signals P_{U1} and P_{U2} .

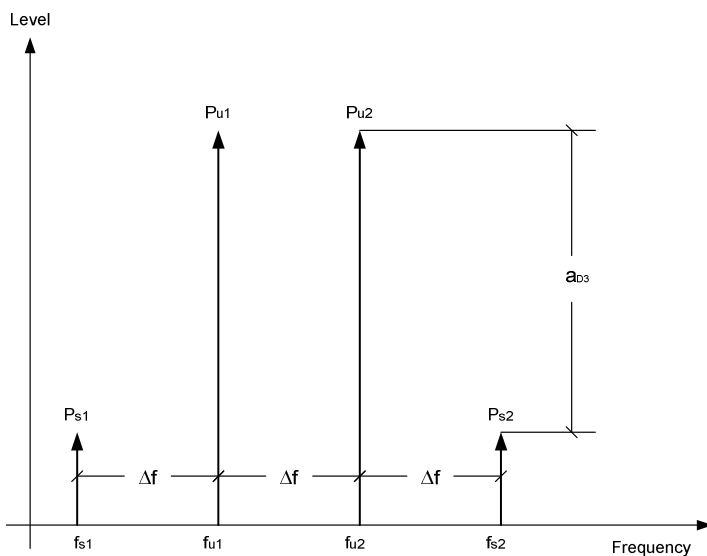

Fig. 2-4 Intermodulation products P_{U1} and P_{U2}

The intermodulation product at f_{i2} is generated by mixing the 2nd harmonic of useful signal P_{U2} and signal P_{U1} , the intermodulation product at f_{i1} by mixing the 2nd harmonic of useful signal P_{U1} and signal P_{U2} .

$$f_{i1} = 2 \times f_{U1} - f_{U2} \quad (6)$$

$$f_{i2} = 2 \times f_{U2} - f_{U1} \quad (7)$$

The level of the intermodulation products depends on the level of the useful signals. If the two useful signals are increased by 1 dB, the level of the intermodulation products increases by 3 dB, which means that spacing a_{D3} between intermodulation signals and useful signals are reduced by 2 dB. This is illustrated in Fig. 2-5.

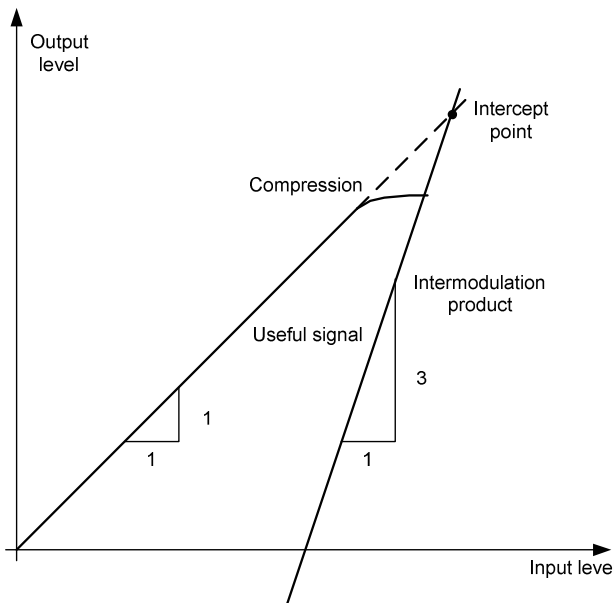

Fig. 2-5 Dependence of intermodulation level on useful signal level

The useful signals at the two-port output increase proportionally with the input level as long as the two-port is in the linear range. A level change of 1 dB at the input causes a level change of 1 dB at the output. Beyond a certain input level, the two-port goes into compression and the output level stops increasing. The intermodulation products of the third order increase three times as much as the useful signals. The intercept point is the fictitious level where the two lines intersect. It cannot be measured directly since the useful level is previously limited by the maximum two-port output power.

It can be calculated from the known line slopes and the measured spacing a_{D3} at a given level according to the following formula.

$$IP3 = \frac{a_{D3}}{2} + P_N \quad (8)$$

The 3rd order intercept point (TOI), for example, is calculated for an intermodulation of 60 dB and an input level P_U of -20 dBm according to the following formula:

$$IP3 = \frac{60}{2} + (-20dBm) = 10dBm \quad (9)$$

Measurement example - Measuring the R&S FSL's intrinsic intermodulation

Test setup:

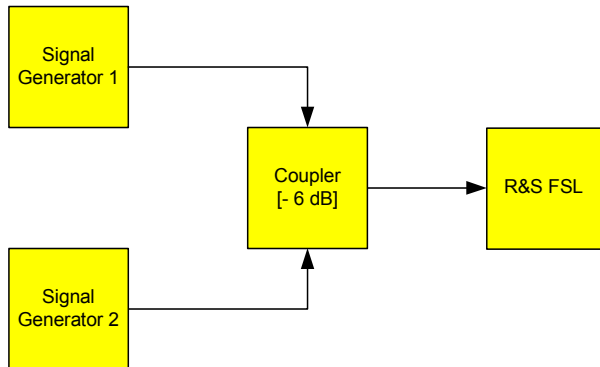

Signal generator settings (e.g. R&S SMU):

	Level	Frequency
Signal generator 1	-4 dBm	999.7 MHz
Signal generator 2	-4 dBm	1000.3 MHz

Procedure:

1. Set the R&S FSL to its default settings.
 - Press the **PRESET** key.
 - The R&S FSL is in its default state.
2. Set center frequency to 1 GHz and the frequency span to 3 MHz.
 - Press the **FREQ** key and enter *1 GHz*.
 - Press the **SPAN** key and enter *3 MHz*.
3. Set the reference level to -10 dBm and RF attenuation to 0 dB.
 - Press the **AMPT** key and enter *-10 dBm*.
 - Press the **RF Atten Manual** softkey and enter *0 dB*.
4. Set the resolution bandwidth to 10 kHz.
 - Press the **BW** key.
 - Press the **Res BW Manual** softkey and enter *10 kHz*.
 - The noise is reduced, the trace is smoothed further and the intermodulation products can be clearly seen.
 - Press the **Video BW Manual** softkey and enter *1 kHz*.
5. Measuring intermodulation by means of the 3rd order intercept measurement function
 - Press the **MEAS** key.
 - Press the **TOI** softkey.

The R&S FSL activates four markers for measuring the intermodulation distance. Two markers are positioned on the useful signals and two on the intermodulation products. The 3rd order intercept is calculated from the level difference between the useful signals and the intermodulation products. It is then displayed on the screen:

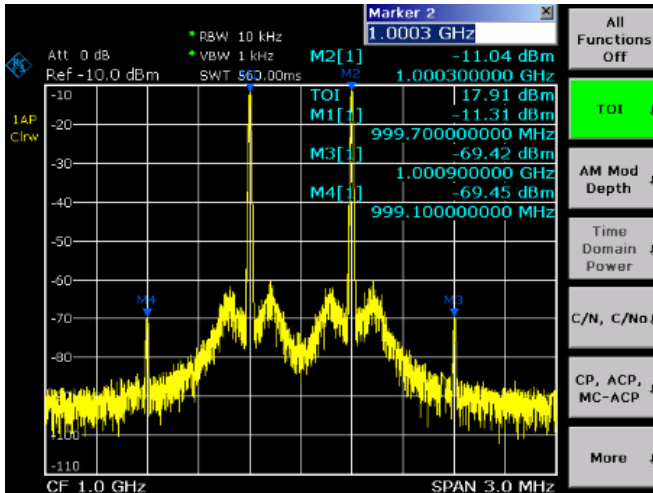

Fig. 2-6 Result of intrinsic intermodulation measurement on the R&S FSL. The 3rd order intercept (TOI) is displayed at the top right corner of the grid.

The level of a spectrum analyzer's intrinsic intermodulation products depends on the RF level of the useful signals at the input mixer. When the RF attenuation is added, the mixer level is reduced and the intermodulation distance is increased. With an additional RF attenuation of 10 dB, the levels of the intermodulation products are reduced by 20 dB. The noise level is, however, increased by 10 dB.

6. Increasing RF attenuation to 10 dB to reduce intermodulation products.

- Press the **AMPT** key.
- Press the **RF Atten Manual** softkey and enter *10 dB*.

The R&S FSL's intrinsic intermodulation products disappear below the noise floor.

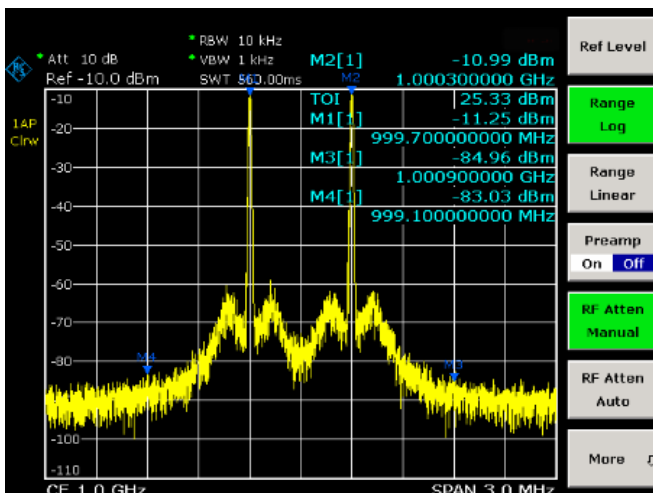

Fig. 2-7 If the RF attenuation is increased, the R&S FSL's intrinsic intermodulation products disappear below the noise floor.

Calculation method:

The method used by the R&S FSL to calculate the intercept point takes the average useful signal level P_u in dBm and calculates the intermodulation d_3 in dB as a function of the average value of the levels of the two intermodulation products. The third order intercept (TOI) is then calculated as follows:

$$TOI/dBm = \frac{1}{2} d_3 + P_u$$

Intermodulation- free dynamic range

The **Intermodulation - free dynamic range**, i.e. the level range in which no internal intermodulation products are generated if two-tone signals are measured, is determined by the 3rd order intercept point, the phase noise and the thermal noise of the spectrum analyzer. At high signal levels, the range is determined by intermodulation products. At low signal levels, intermodulation products disappear below the noise floor, i.e. the noise floor and the phase noise of the spectrum analyzer determine the range. The noise floor and the phase noise depend on the resolution bandwidth that has been selected. At the smallest resolution bandwidth, the noise floor and phase noise are at a minimum and so the maximum range is obtained. However, a large increase in sweep time is required for small resolution bandwidths. It is, therefore, best to select the largest resolution bandwidth possible to obtain the range that is required. Since phase noise decreases as the carrier-offset increases, its influence decreases with increasing frequency offset from the useful signals.

The following diagrams illustrate the intermodulation-free dynamic range as a function of the selected bandwidth and of the level at the input mixer (= signal level - set RF attenuation) at different useful signal offsets.

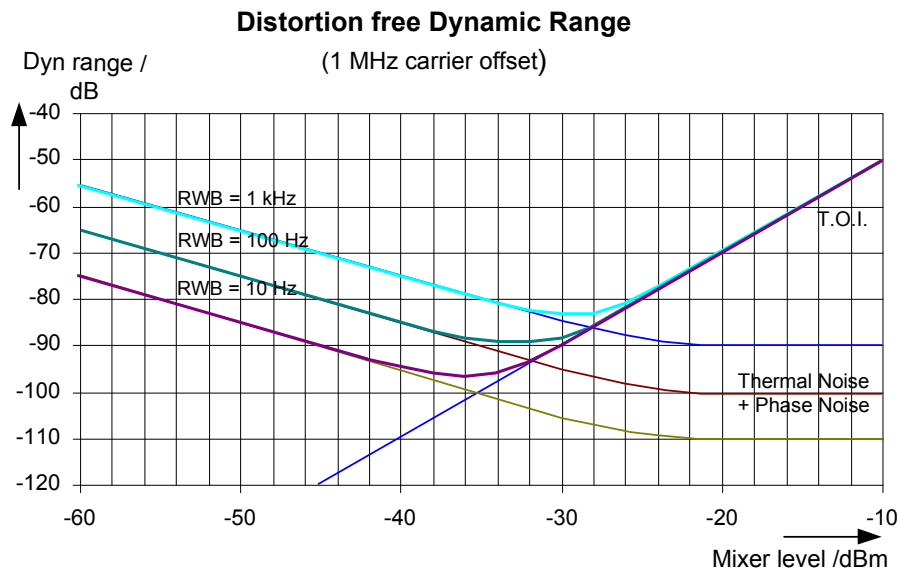

Fig. 2-8 Intermodulation-free range of the R&S FSL as a function of level at the input mixer and the set resolution bandwidth (useful signal offset = 1 MHz, DANL = -145 dBm /Hz, TOI = 15 dBm; typical values at 2 GHz)

The optimum mixer level, i.e. the level at which the intermodulation distance is at its maximum, depends on the bandwidth. At a resolution bandwidth of 10 Hz, it is approx. -35 dBm and at 1 kHz increases to approx. -30 dBm.

Phase noise has a considerable influence on the intermodulation-free range at carrier offsets between 10 and 100 kHz (Fig. 2-9). At greater bandwidths, the influence of the phase noise is greater than it would be with small bandwidths. The optimum mixer level at the bandwidths under consideration becomes almost independent of bandwidth and is approx. -40 dBm.

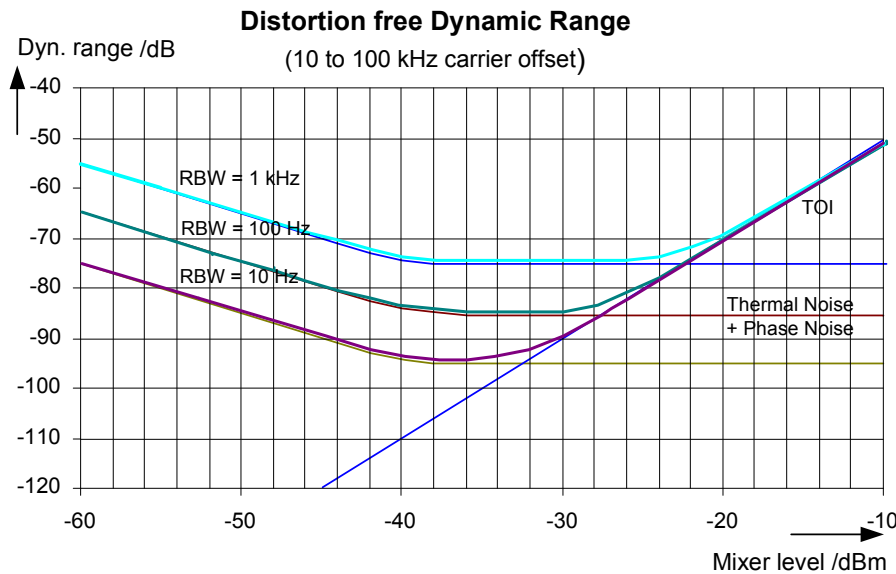

Fig. 2-9 Intermodulation-free dynamic range of the R&S FSL as a function of level at the input mixer and of the selected resolution bandwidth (useful signal offset = 10 to 100 kHz, DANL = -145 dBm /Hz, TOI = 15 dBm; typical values at 2 GHz).



If the intermodulation products of a DUT with a very high dynamic range are to be measured and the resolution bandwidth to be used is therefore very small, it is best to measure the levels of the useful signals and those of the intermodulation products separately using a small span. The measurement time will be reduced- in particular if the offset of the useful signals is large. To find signals reliably when frequency span is small, it is best to synchronize the signal sources and the R&S FSL.

Measuring Signals in the Vicinity of Noise

The minimum signal level a spectrum analyzer can measure is limited by its intrinsic noise. Small signals can be swamped by noise and therefore cannot be measured. For signals that are just above the intrinsic noise, the accuracy of the level measurement is influenced by the intrinsic noise of the spectrum analyzer.

The displayed noise level of a spectrum analyzer depends on its noise figure, the selected RF attenuation, the selected reference level, the selected resolution and video bandwidth and the detector. The effect of the different parameters is explained in the following.

Impact of the RF attenuation setting

The sensitivity of a spectrum analyzer is directly influenced by the selected RF attenuation. The highest sensitivity is obtained at a RF attenuation of 0 dB. The attenuation can be set in 10 dB steps up to 70 dB. Each additional 10 dB step reduces the sensitivity by 10 dB, i.e. the displayed noise is increased by 10 dB.

Impact of the resolution bandwidth

The sensitivity of a spectrum analyzer also directly depends on the selected bandwidth. The highest sensitivity is obtained at the smallest bandwidth (for the R&S FSL: 10 Hz, for FFT filtering: 1 Hz). If the bandwidth is increased, the reduction in sensitivity is proportional to the change in bandwidth. The R&S FSL has bandwidth settings in 1, 3, 10 sequence. Increasing the bandwidth by a factor of 3 increases the displayed noise by approx. 5 dB (4.77 dB precisely). If the bandwidth is increased by a factor of 10, the displayed noise increases by a factor of 10, i.e. 10 dB.

Impact of the video bandwidth

The displayed noise of a spectrum analyzer is also influenced by the selected video bandwidth. If the video bandwidth is considerably smaller than the resolution bandwidth, noise spikes are suppressed, i.e. the trace becomes much smoother. The level of a sinewave signal is not influenced by the video bandwidth. A sinewave signal can therefore be freed from noise by using a video bandwidth that is small compared with the resolution bandwidth, and thus be measured more accurately.

Impact of the detector

Noise is evaluated differently by the different detectors. The noise display is therefore influenced by the choice of detector. Sinewave signals are weighted in the same way by all detectors, i.e. the level display for a sinewave RF signal does not depend on the selected detector, provided that the signal-to-noise ratio is high enough. The measurement accuracy for signals in the vicinity of intrinsic spectrum analyzer noise is also influenced by the detector which has been selected. For details on the detectors of the R&S FSL refer to chapter "Instrument Functions", section "Detector overview" or the Online Help.

Measurement example - Measuring level at low S/N ratios

The example shows the different factors influencing the S/N ratio.

Signal generator settings (e.g. R&S SMU):

Frequency: 128 MHz
Level: - 80 dBm

Procedure:

1. Set the R&S FSL to its default state.
 - Press the **PRESET** key.
The R&S FSL is in its default state.
2. Set the center frequency to 128 MHz and the frequency span to 100 MHz.
 - Press the **FREQ** key and enter *128 MHz*.
 - Press the **SPAN** key and enter *100 MHz*.
3. Set the RF attenuation to 60 dB to attenuate the input signal or to increase the intrinsic noise.
 - Press the **AMPT** key.
 - Press the **RF Atten Manual** softkey and enter *60 dB*.

The RF attenuation indicator is marked with an asterisk (*Att 60 dB) to show that it is no longer coupled to the reference level. The high input attenuation reduces the reference signal which can no longer be detected in noise.

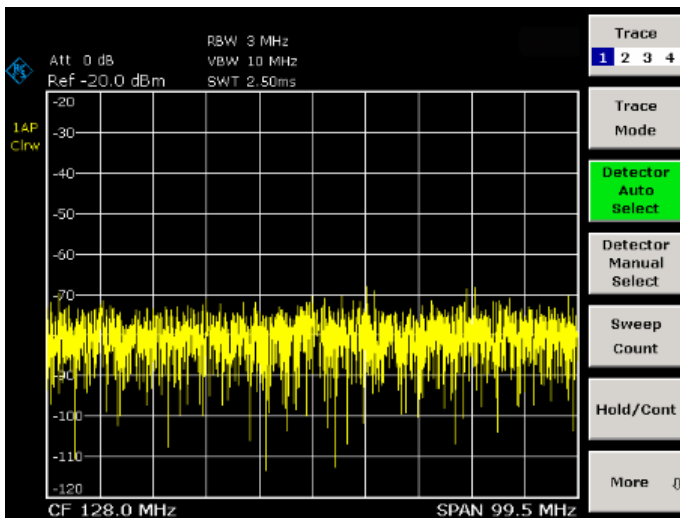

Fig. 2-10 Sinewave signal with low S/N ratio. The signal is measured with the auto peak detector and is completely hidden in the intrinsic noise of the R&S FSL.

4. To suppress noise spikes the trace can be averaged.

- Press the **TRACE** key.
- Press the **Trace Mode** key.
- Press the **Average** softkey.

The traces of consecutive sweeps are averaged. To perform averaging, the R&S FSL automatically switches on the sample detector. The RF signal, therefore, can be more clearly distinguished from noise.

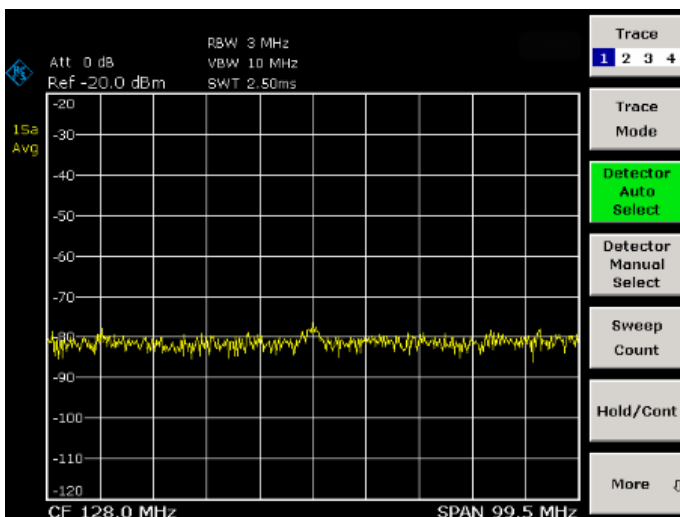

Fig. 2-11 RF sinewave signal with low S/N ratio if the trace is averaged.

5. Instead of trace averaging, a video filter that is narrower than the resolution bandwidth can be selected.

- Press the **Trace Mode** key.
- Press the **Clear Write** softkey.
- Press the **BW** key.

- Press the **Video BW Manual** softkey and enter *10 kHz*.

The RF signal can be more clearly distinguished from noise.

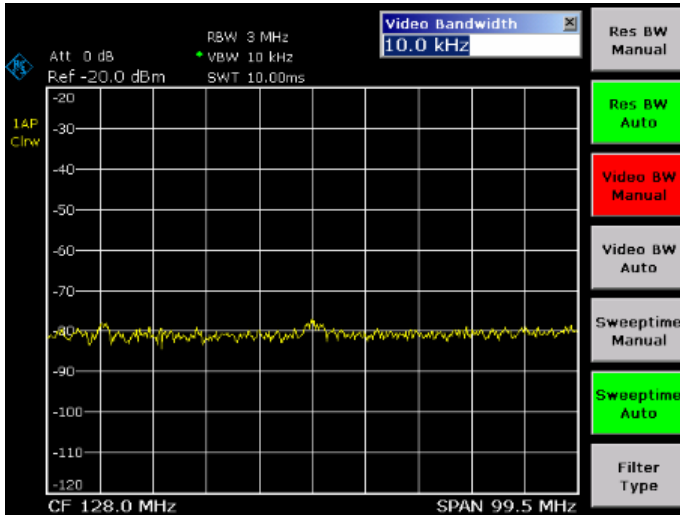

Fig. 2-12 RF sinewave signal with low S/N ratio if a smaller video bandwidth is selected.

- By reducing the resolution bandwidth by a factor of 10, the noise is reduced by 10 dB.

- Press the **Res BW Manual** softkey and enter *300 kHz*.

The displayed noise is reduced by approx. 10 dB. The signal, therefore, emerges from noise by about 10 dB. Compared to the previous setting, the video bandwidth has remained the same, i.e. it has increased relative to the smaller resolution bandwidth. The averaging effect of the video bandwidth is therefore reduced. The trace will be noisier.

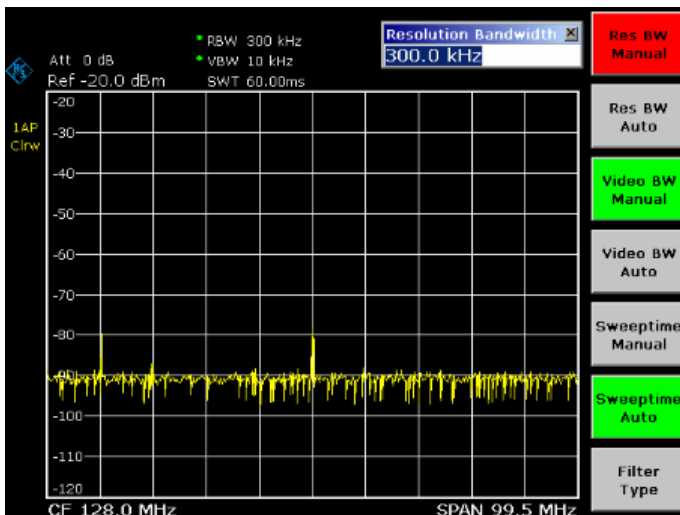

Fig. 2-13 Reference signal at a smaller resolution bandwidth

Noise Measurements

Noise measurements play an important role in spectrum analysis. Noise e.g. affects the sensitivity of radio communication systems and their components.

Noise power is specified either as the total power in the transmission channel or as the power referred to a bandwidth of 1 Hz. The sources of noise are, for example, amplifier noise or noise generated by oscillators used for the frequency conversion of useful signals in receivers or transmitters. The noise at the output of an amplifier is determined by its noise figure and gain.

The noise of an oscillator is determined by phase noise near the oscillator frequency and by thermal noise of the active elements far from the oscillator frequency. Phase noise can mask weak signals near the oscillator frequency and make them impossible to detect.

Measuring Noise Power Density

To measure noise power referred to a bandwidth of 1 Hz at a certain frequency, the R&S FSL provides marker function. This marker function calculates the noise power density from the measured marker level.

Measurement example - Measuring the intrinsic noise power density of the R&S FSL at 1 GHz and calculating the R&S FSL's noise figure

Test setup:

- Connect no signal to the RF input; terminate RF input with 50 Ω .

Procedure:

1. Set the R&S FSL to its default state.
 - Press the **PRESET** key.
The R&S FSL is in its default state.
2. Set the center frequency to 1.234 GHz and the span to 1 MHz.
 - Press the **FREQ** key and enter *1.234 GHz*.
 - Press the **SPAN** key and enter *1 MHz*.
3. Switch on the marker and set the marker frequency to 1.234 GHz.
 - Press the **MKR** key and enter *1.234 GHz*.
4. Switch on the noise marker function.
 - Switch on the **Noise Meas** softkey.
The R&S FSL displays the noise power at 1 GHz in dBm (1 Hz).



Since noise is random, a sufficiently long measurement time has to be selected to obtain stable measurement results. This can be achieved by averaging the trace or by selecting a very small video bandwidth relative to the resolution bandwidth.

5. The measurement result is stabilized by averaging the trace.

- Press the **TRACE** key.
- Press the **Trace Mode** key.
- Press the **Average** softkey.

The R&S FSL performs sliding averaging over 10 traces from consecutive sweeps. The measurement result becomes more stable.

Conversion to other reference bandwidths

The result of the noise measurement can be referred to other bandwidths by simple conversion. This is done by adding $10 \cdot \log(\text{BW})$ to the measurement result, BW being the new reference bandwidth.

Example

A noise power of -150 dBm (1 Hz) is to be referred to a bandwidth of 1 kHz.

$$P_{[1\text{kHz}]} = -150 + 10 \cdot \log(1000) = -150 + 30 = -120 \text{ dBm (1 kHz)}$$

Calculation method for noise power

If the noise marker is switched on, the R&S FSL automatically activates the sample detector. The video bandwidth is set to 1/10 of the selected resolution bandwidth (RBW).

To calculate the noise, the R&S FSL takes an average over 17 adjacent pixels (the pixel on which the marker is positioned and 8 pixels to the left, 8 pixels to the right of the marker). The measurement result is stabilized by video filtering and averaging over 17 pixels.

Since both video filtering and averaging over 17 trace points is performed in the log display mode, the result would be 2.51 dB too low (difference between logarithmic noise average and noise power). The R&S FSL, therefore, corrects the noise figure by 2.51 dB.

To standardize the measurement result to a bandwidth of 1 Hz, the result is also corrected by $-10 \cdot \log(\text{RBW}_{\text{noise}})$, with $\text{RBW}_{\text{noise}}$ being the power bandwidth of the selected resolution filter (RBW).

Detector selection

The noise power density is measured in the default setting with the sample detector and using averaging. Other detectors that can be used to perform a measurement giving true results are the average detector or the RMS detector. If the average detector is used, the linear video voltage is averaged and displayed as a pixel. If the RMS detector is used, the squared video voltage is averaged and displayed as a pixel. The averaging time depends on the selected sweep time ($=\text{SWT}/501$). An increase in the sweep time gives a longer averaging time per pixel and thus stabilizes the measurement result. The R&S FSL automatically corrects the measurement result of the noise marker display depending on the selected detector (+1.05 dB for the average detector, 0 dB for the RMS detector). It is assumed that the video bandwidth is set to at least three times the resolution bandwidth. While the average or RMS detector is being switched on, the R&S FSL sets the video bandwidth to a suitable value.

The Pos Peak, Neg Peak, Auto Peak and Quasi Peak detectors are not suitable for measuring noise power density.

Determining the noise figure

The noise figure of amplifiers or of the R&S FSL alone can be obtained from the noise power display. Based on the known thermal noise power of a 50Ω resistor at room temperature (-174 dBm (1Hz)) and the measured noise power P_{noise} the noise figure (NF) is obtained as follows:

$$NF = P_{\text{noise}} + 174 - g,$$

where g = gain of DUT in dB

Example

The measured internal noise power of the R&S FSL at an attenuation of 0 dB is found to be -143 dBm/1 Hz. The noise figure of the R&S FSL is obtained as follows

$$NF = -143 + 174 = 31 \text{ dB}$$



If noise power is measured at the output of an amplifier, for example, the sum of the internal noise power and the noise power at the output of the DUT is measured. The noise power of the DUT can be obtained by subtracting the internal noise power from the total power (subtraction of linear noise powers). By means of the following diagram, the noise level of the DUT can be estimated from the level difference between the total and the internal noise level.

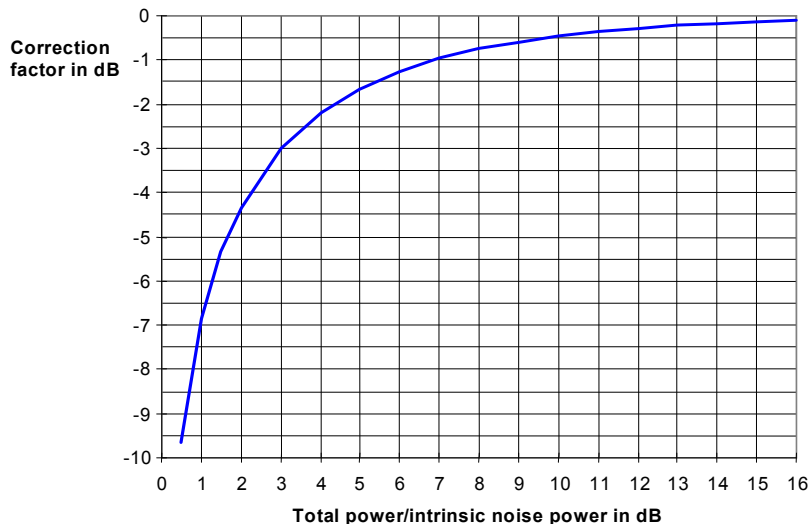

Fig. 2-14 Correction factor for measured noise power as a function of the ratio of total power to the intrinsic noise power of the spectrum analyzer

Measurement of Noise Power within a Transmission Channel

Noise in any bandwidth can be measured with the channel power measurement functions. Thus the noise power in a communication channel can be determined, for example. If the noise spectrum within the channel bandwidth is flat, the noise marker from the previous example can be used to determine the noise power in the channel by considering the channel bandwidth. If, however, phase noise and noise that normally increases towards the carrier is dominant in the channel to be measured, or if there are discrete spurious signals in the channel, the channel power measurement method must be used to obtain correct measurement results.

Measurement example - Measuring the intrinsic noise of the R&S FSL at 1 GHz in a 1.23 MHz channel bandwidth with the channel power function**Test setup:**

- Leave the RF input of the R&S FSL open-circuited or terminate it with 50 Ω.

Procedure:

1. Set the R&S FSL to its default state.
 - Press the **PRESET** key.
The R&S FSL is in its default state.
2. Set the center frequency to 1 GHz and the span to 1 MHz.
 - Press the **FREQ** key and enter *1 GHz*.
 - Press the **SPAN** key and enter *2 MHz*.
3. To obtain maximum sensitivity, set RF attenuation on the R&S FSL to 0 dB.
 - Press the **AMPT** key.
 - Press the **RF Atten Manual** softkey and enter *0 dB*.
4. Switch on and configure the channel power measurement.
 - Press the **MEAS** key.
 - Press the **CP, ACP, MC-ACP** softkey.
The R&S FSL activates the channel or adjacent channel power measurement according to the currently set configuration.
 - Press the **CP/ACP Config** softkey.
The submenu for configuring the channel is displayed.
 - Press the **Channel Settings** softkey.
The submenu for channel settings is displayed.
 - Press the **Channel Bandwidth** softkey and enter *1.23 MHz*.
The R&S FSL displays the 1.23 MHz channel as two vertical lines which are symmetrical to the center frequency.
 - Press the **Adjust Settings** softkey.
The settings for the frequency span, the bandwidth (RBW and VBW) and the detector are automatically set to the optimum values required for the measurement.

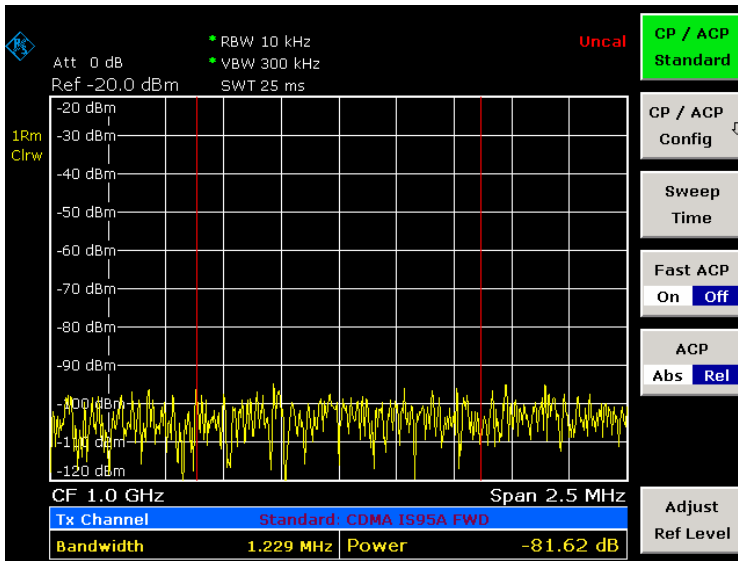

Fig. 2-15 Measurement of the R&S FSL's intrinsic noise power in a 1.23 MHz channel bandwidth.

5. Stabilizing the measurement result by increasing the sweep time

- Press the **▲** key twice.

The main menu for channel and adjacent channel power measurement is displayed.

- Press the **Sweep Time** softkey and enter 1 s.

The trace becomes much smoother because of the RMS detector and the channel power measurement display is much more stable.

Method of calculating the channel power

When measuring the channel power, the R&S FSL integrates the linear power which corresponds to the levels of the pixels within the selected channel. The spectrum analyzer uses a resolution bandwidth which is far smaller than the channel bandwidth. When sweeping over the channel, the channel filter is formed by the passband characteristics of the resolution bandwidth (see Fig. 2-16).

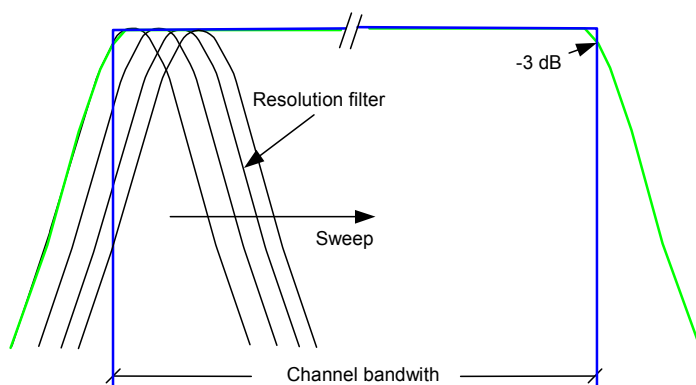

Fig. 2-16 Approximating the channel filter by sweeping with a small resolution bandwidth

The following steps are performed:

- The linear power of all the trace pixels within the channel is calculated.

$$P_i = 10^{(L_i/10)}$$

where P_i = power of the trace pixel i

L_i = displayed level of trace point i

- The powers of all trace pixels within the channel are summed up and the sum is divided by the number of trace pixels in the channel.
- The result is multiplied by the quotient of the selected channel bandwidth and the noise bandwidth of the resolution filter (RBW).

Since the power calculation is performed by integrating the trace within the channel bandwidth, this method is also called the IBW method (Integration Bandwidth method).

Parameter settings

For selection of the sweep time, see next section. For details on the parameter settings refer to chapter "Instrument Functions", section "Settings of the CP / ACP test parameters" or the Online Help.

Sweep time selection

The number of A/D converter values, N , used to calculate the power, is defined by the sweep time. The time per trace pixel for power measurements is directly proportional to the selected sweep time.

If the sample detector is used, it is best to select the smallest sweep time possible for a given span and resolution bandwidth. The minimum time is obtained if the setting is coupled. This means that the time per measurement is minimal. Extending the measurement time does not have any advantages as the number of samples for calculating the power is defined by the number of trace pixels in the channel.

If the RMS detector is used, the repeatability of the measurement results can be influenced by the selection of sweep times. Repeatability is increased at longer sweep times.

Repeatability can be estimated from the following diagram:

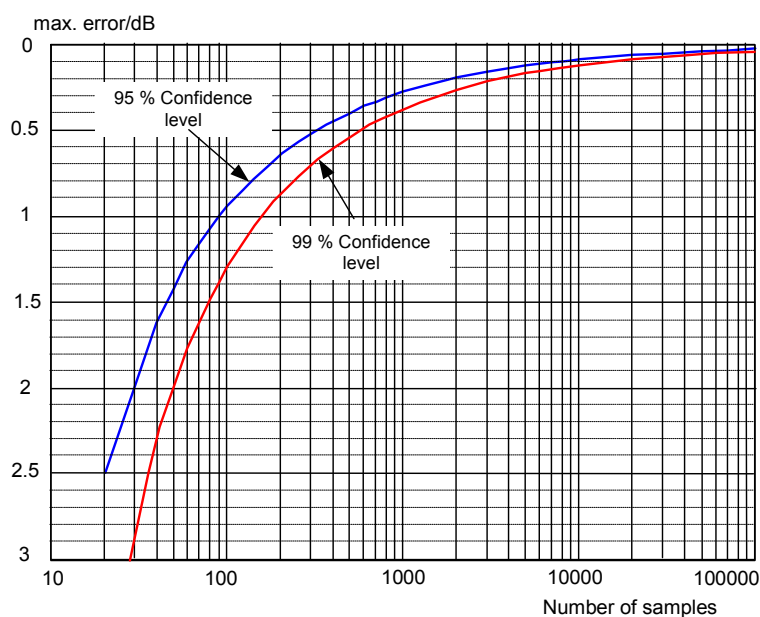

Fig. 2-17 Repeatability of channel power measurements as a function of the number of samples used for power calculation

The curves in Fig. 2-17 indicate the repeatability obtained with a probability of 95% and 99% depending on the number of samples used.

The repeatability with 600 samples is ± 0.5 dB. This means that - if the sample detector and a channel bandwidth over the whole diagram (channel bandwidth = span) is used - the measured value lies within ± 0.5 dB of the true value with a confidence level of 99%.

If the RMS detector is used, the number of samples can be estimated as follows:

Since only uncorrelated samples contribute to the RMS value, the number of samples can be calculated from the sweep time and the resolution bandwidth.

Samples can be assumed to be uncorrelated if sampling is performed at intervals of $1/RBW$. The number of uncorrelated samples is calculated as follows:

$$N_{decorr} = SWT \cdot RBW \quad (N_{decorr} \text{ means uncorrelated samples})$$

The number of uncorrelated samples per trace pixel is obtained by dividing N_{decorr} by 501 (= pixels per trace).

Example

At a resolution bandwidth of 30 kHz and a sweep time of 100 ms, 3000 uncorrelated samples are obtained. If the channel bandwidth is equal to the frequency display range, i.e. all trace pixels are used for the channel power measurement, a repeatability of 0.2 dB with a probability of 99% is the estimate that can be derived from Fig. 2-17.

Measuring Phase Noise

The R&S FSL has an easy-to-use marker function for phase noise measurements. This marker function indicates the phase noise of an RF oscillator at any carrier in dBc in a bandwidth of 1 Hz.

Measurement example - Measuring the phase noise of a signal generator at a carrier offset of 10 kHz

Test setup:

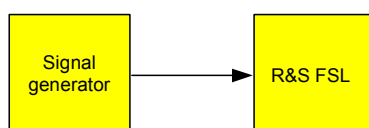

Signal generator settings (e.g. R&S SMU):

Frequency: 100 MHz

Level: 0 dBm

Procedure:

1. Set the R&S FSL to its default state.
 - Press the **PRESET** key.
 - R&S FSL is in its default state.

2. Set the center frequency to 100 MHz and the span to 50 kHz.
 - Press the **FREQ** key and enter *100 MHz*.
 - Press the **SPAN** key and enter *50 kHz*.
3. Set the R&S FSL's reference level to 0 dBm (=signal generator level).
 - Press the **AMPT** key and enter *0 dBm*.
4. Enable phase noise measurement.
 - Press the **MKR** key.
 - Press the Phase Noise/Ref Fixed softkey.

The R&S FSL activates phase noise measurement. Marker 1 (=main marker) and marker 2 (=delta marker) are positioned on the signal maximum. The position of the marker is the reference (level and frequency) for the phase noise measurement. A horizontal line represents the level of the reference point and a vertical line the frequency of the reference point. The dialog box for the delta marker is displayed so that the frequency offset at which the phase noise is to be measured can be entered directly.

5. Set the frequency offset to 10 kHz for determining phase noise.
 - Enter *10 kHz*.

The R&S FSL displays the phase noise at a frequency offset of 10 kHz. The magnitude of the phase noise in dBc/Hz is displayed in the delta marker output field at the top right of the screen (Phn2).

6. Stabilize the measurement result by activating trace averaging.
 - Press the **TRACE** key.
 - Press the **Trace Mode** key.
 - Press the **Average** softkey.

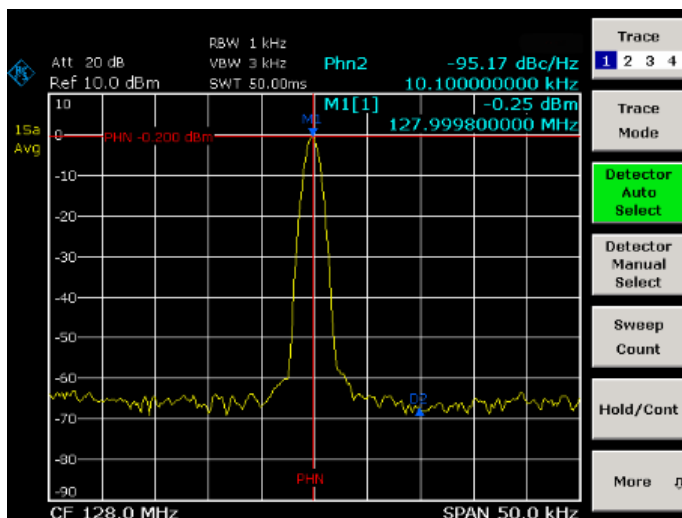

Fig. 2-18 Measuring phase noise with the phase-noise marker function

The frequency offset can be varied by moving the marker with the rotary knob or by entering a new frequency offset as a number.

Measurements on Modulated Signals

For measurements on AM and FM signals refer to the Quick Start Guide, chapter 5, "Basic Measurements Examples".

Measuring Channel Power and Adjacent Channel Power

Measuring channel power and adjacent channel power is one of the most important tasks in the field of digital transmission for a spectrum analyzer with the necessary test routines. While, theoretically, channel power could be measured at highest accuracy with a power meter, its low selectivity means that it is not suitable for measuring adjacent channel power as an absolute value or relative to the transmit channel power. The power in the adjacent channels can only be measured with a selective power meter.

A spectrum analyzer cannot be classified as a true power meter, because it displays the IF envelope voltage. However, it is calibrated such as to correctly display the power of a pure sinewave signal irrespective of the selected detector. This calibration cannot be applied for non-sinusoidal signals. Assuming that the digitally modulated signal has a Gaussian amplitude distribution, the signal power within the selected resolution bandwidth can be obtained using correction factors. These correction factors are normally used by the spectrum analyzer's internal power measurement routines in order to determine the signal power from IF envelope measurements. These factors apply if and only if the assumption of a Gaussian amplitude distribution is correct.

Apart from this common method, the R&S FSL also has a true power detector, i.e. an RMS detector. It correctly displays the power of the test signal within the selected resolution bandwidth irrespective of the amplitude distribution, without additional correction factors being required. The absolute measurement uncertainty of the R&S FSL is < 1.5 dB and a relative measurement uncertainty of < 0.5 dB (each with a confidence level of 95%).

There are two possible methods for measuring channel and adjacent channel power with a spectrum analyzer:

- **IBW method (Integration Bandwidth Method)**
The spectrum analyzer measures with a resolution bandwidth that is less than the channel bandwidth and integrates the level values of the trace versus the channel bandwidth. This method is described in section "[Method of calculating the channel power](#)".
- **Using a channel filter**
For a detailed description, refer to the following section.

Measurement using a channel filter

In this case, the spectrum analyzer makes zero span measurements using an IF filter that corresponds to the channel bandwidth. The power is measured at the output of the IF filter. Until now, this method has not been used for spectrum analyzers, because channel filters were not available and the resolution bandwidths, optimized for the sweep, did not have a sufficient selectivity. The method was reserved for special receivers optimized for a particular transmission method. It is available in R&S FSQ, FSU, FSP, FSL and ESL series.

The R&S FSL has test routines for simple channel and adjacent channel power measurements. These routines give quick results without any complex or tedious setting procedures.

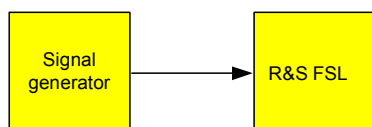
Measurement example 1 - ACPR measurement on an CDMA 2000 signal**Test setup:****Signal generator settings (e.g. R&S SMU):**

Frequency: 850 MHz

Level: 0 dBm

Modulation: CDMA 2000

Procedure:

1. Set the R&S FSL to its default state.
 - Press the **PRESET** key.
The R&S FSL is in its default state.
2. Set the center frequency to 850 MHz and span to 4 MHz.
 - Press the **FREQ** key and enter *850 MHz*.
 - Press the **SPAN** key and enter *4 MHz*.
3. Set the reference level to +10 dBm.
 - Press the **AMPT** key and enter *10 dBm*.
4. Configuring the adjacent channel power for the CDMA 2000 MC1.
 - Press the **MEAS** key.
 - Press the **CP, ACP, MC-ACP** softkey.
 - Press the **CP / ACP Standard** softkey.
 - In the standards list, mark **CDMA 2000 MC1** using the rotary knob or the arrow keys and confirm pressing the rotary knob or the **ENTER** key.

The R&S FSL sets the channel configuration according to the 2000 MC1 standard for mobile stations with 2 adjacent channels above and below the transmit channel. The spectrum is displayed in the upper part of the screen, the numeric values of the results and the channel configuration in the lower part of the screen. The various channels are represented by vertical lines on the graph.

The frequency span, resolution bandwidth, video bandwidth and detector are selected automatically to give correct results. To obtain stable results - especially in the adjacent channels (30 kHz bandwidth) which are narrow in comparison with the transmission channel bandwidth (1.23 MHz) - the RMS detector is used.

5. Set the optimal reference level and RF attenuation for the applied signal level.
 - Press the **Adjust Ref Level** softkey.

The R&S FSL sets the optimal RF attenuation and the reference level based on the transmission channel power to obtain the maximum dynamic range. Fig. 2-19 shows the result of the measurement.

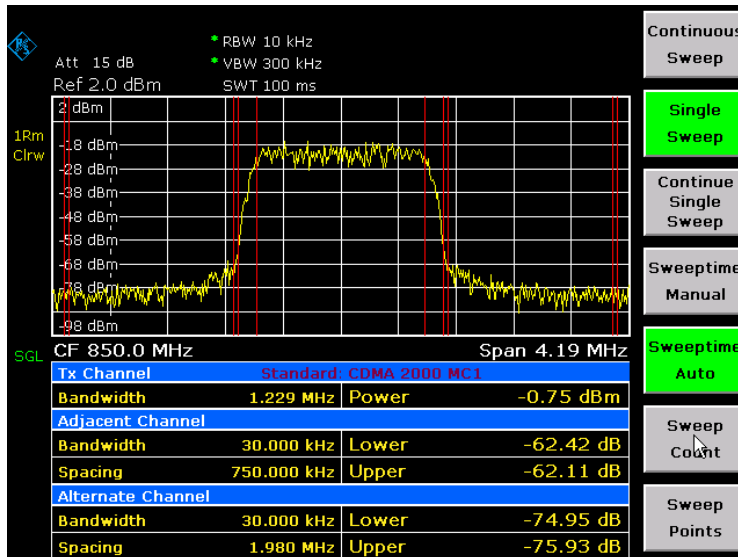

Fig. 2-19 Adjacent channel power measurement on a CDMA 2000 MC1 signal

The repeatability of the results, especially in the narrow adjacent channels, strongly depends on the measurement time since the dwell time within the 30 kHz channels is only a fraction of the complete sweep time. A longer sweep time may increase the probability that the measured value converges to the true value of the adjacent channel power, but this increases measurement time.

To avoid long measurement times, the R&S FSL measures the adjacent channel power with zero span (fast ACP mode). In the fast ACP mode, the R&S FSL measures the power of each channel at the defined channel bandwidth, while being tuned to the center frequency of the channel in question. The digital implementation of the resolution bandwidths makes it possible to select filter characteristics that is precisely tailored to the signal. In case of CDMA 2000 MC1, the power in the useful channel is measured with a bandwidth of 1.23 MHz and that of the adjacent channels with a bandwidth of 30 kHz. Therefore the R&S FSL changes from one channel to the other and measures the power at a bandwidth of 1.23 MHz or 30 kHz using the RMS detector. The measurement time per channel is set with the sweep time. It is equal to the selected measurement time divided by the selected number of channels. The five channels from the above example and the sweep time of 100 ms give a measurement time per channel of 20 ms.

Compared to the measurement time per channel given by the span (= 5 MHz) and sweep time (= 100 ms, equal to 0.600 ms per 30 kHz channel) used in the example, this is a far longer dwell time on the adjacent channels (factor of 12). In terms of the number of uncorrelated samples this means $20000/33 \mu s = 606$ samples per channel measurement compared to $600/33 \mu s = 12.5$ samples per channel measurement.

Repeatability with a confidence level of 95% is increased from ± 1.4 dB to ± 0.38 dB as shown in Fig. 2-17. For the same repeatability, the sweep time would have to be set to 1.2 s with the integration method. Fig. 2-20 shows the standard deviation of the results as a function of the sweep time.

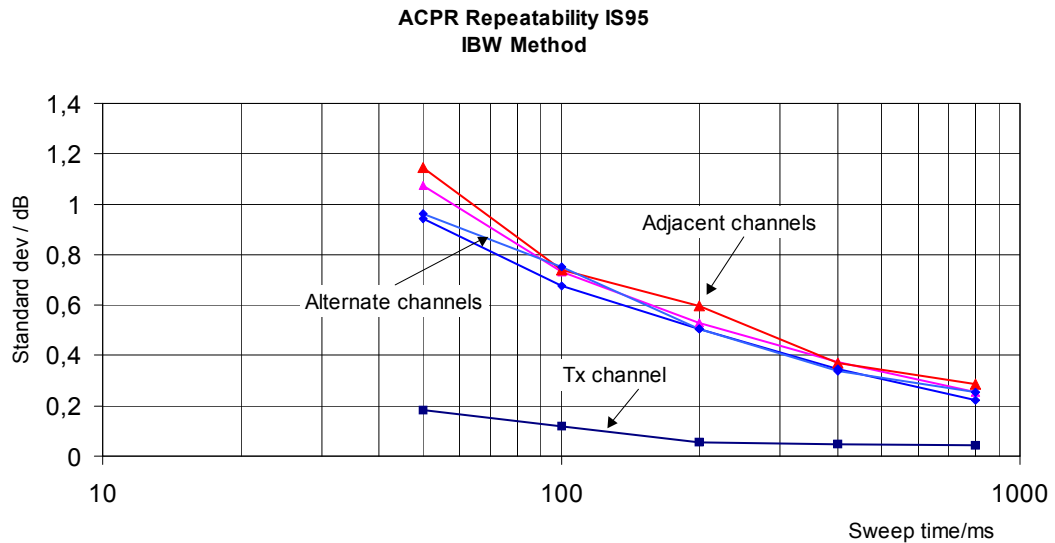

Fig. 2-20 Repeatability of adjacent channel power measurement on CDMA 2000 standard signals if the integration bandwidth method is used

6. Switch to fast ACP mode to increase the repeatability of results.
 - Switch the **Fast ACP** softkey to **On**.

The R&S FSL measures the power of each channel with zero span. The trace represents power as a function of time for each channel (see Fig. 2-23). The numerical results over consecutive measurements become much more stable.

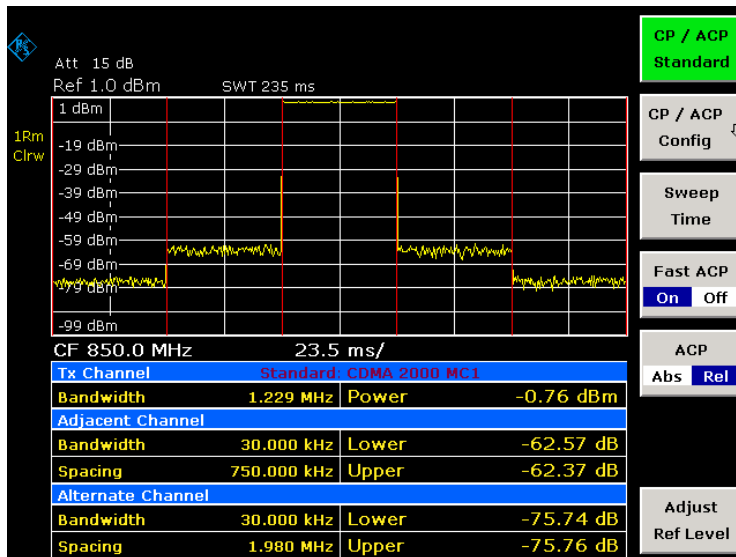

Fig. 2-21 Measuring the channel power and adjacent channel power ratio for 2000 MC1 signals with zero span (Fast ACP)

Fig. 2-22 shows the repeatability of power measurements in the transmit channel and of relative power measurements in the adjacent channels as a function of sweep time. The standard deviation of measurement results is calculated from 100 consecutive measurements as shown in Fig. 2-22. Take scaling into account if comparing power values.

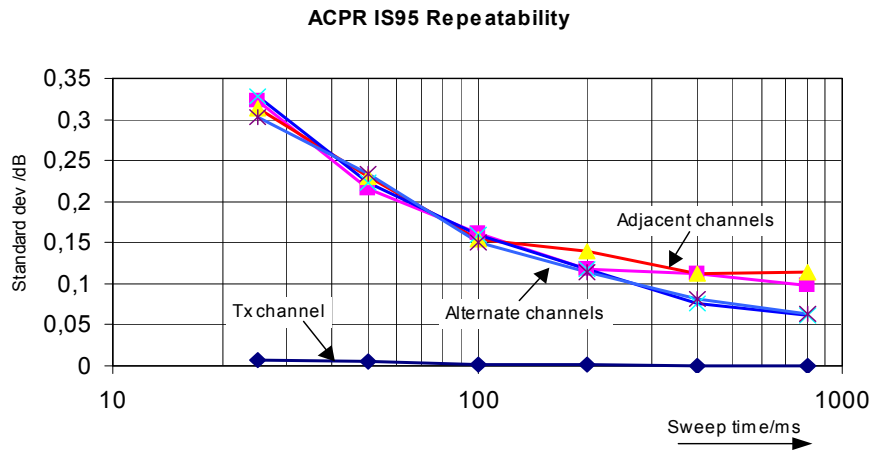

Fig. 2-22 Repeatability of adjacent channel power measurements on CDMA 2000 signals in the fast ACP mode



Note on adjacent channel power measurements on 2000 MC1 base-station signals:

When measuring the adjacent channel power of 2000 MC1 base-station signals, the frequency spacing of the adjacent channel to the nominal transmit channel is specified as ± 750 kHz. The adjacent channels are, therefore, so close to the transmit channel that the power of the transmit signal leaks across and is also measured in the adjacent channel if the usual method using the 30 kHz resolution bandwidth is applied. The reason is the low selectivity of the 30 kHz resolution filter. The resolution bandwidth, therefore, must be reduced considerably, e.g. to 3 kHz to avoid this. This causes very long measurement times (factor of 100 between a 30 kHz and 3 kHz resolution bandwidth).

This effect is avoided with the zero span method which uses steep IF filters. The 30 kHz channel filter implemented in the R&S FSL has a very high selectivity so that even with a ± 750 kHz spacing to the transmit channel the power of the useful modulation spectrum is not measured.

The following figure shows the passband characteristics of the 30 kHz channel filter in the R&S FSL.

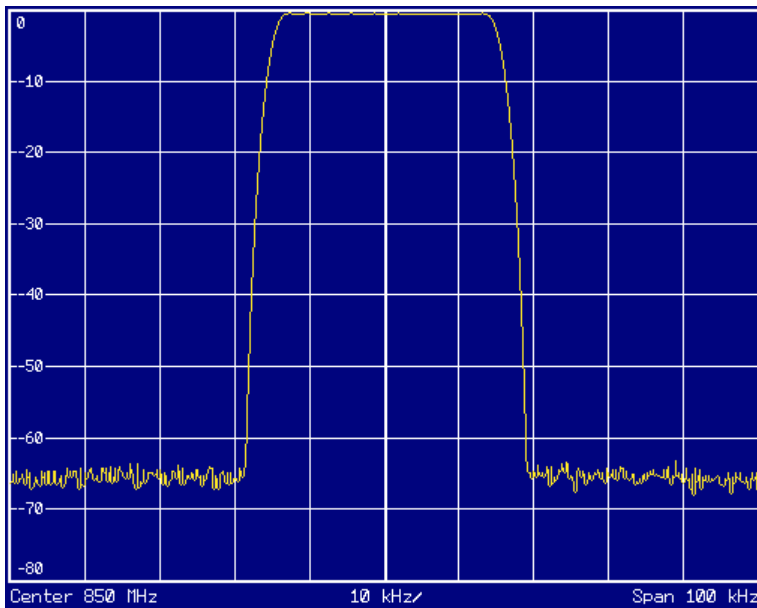
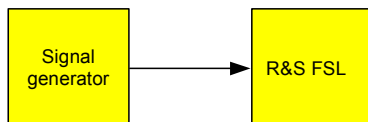

Fig. 2-23 Frequency response of the 30 kHz channel filter for measuring the power in the 2000 MC1 adjacent channel

Measurement example 2 - Measuring adjacent channel power of a W-CDMA uplink signal

Test setup:



Signal generator settings (e.g. R&S SMU):

Frequency: 1950 MHz
 Level: 4 dBm
 Modulation: 3 GPP W-CDMA Reverse Link

Procedure:

1. Set the R&S FSL to its default state.
 - Press the **PRESET** key.
 - The R&S FSL is in its default state.
2. Set the center frequency to 1950 MHz.
 - Press the **FREQ** key and enter *1950 MHz*.

3. Switch on the ACP measurement for W-CDMA.

- Press the **MEAS** key.
- Press the **CP, ACP, MC-ACP** softkey.
- Press the **CP / ACP Standard** softkey.
- In the standards list, mark **W-CDMA 3GPP REV** using the rotary knob or the arrow keys and confirm pressing the rotary knob or the **ENTER** key.

The R&S FSL sets the channel configuration to the 3GPP W-CDMA standard for mobiles with two adjacent channels above and below the transmit channel. The frequency span, the resolution and video bandwidth and the detector are automatically set to the correct values. The spectrum is displayed in the upper part of the screen and the channel power, the level ratios of the adjacent channel powers and the channel configuration in the lower part of the screen. The individual channels are displayed as vertical lines on the graph.

4. Set the optimum reference level and the RF attenuation for the applied signal level.

- Press the **Adjust Ref Level** softkey.

The R&S FSL sets the optimum RF attenuation and the reference level for the power in the transmission channel to obtain the maximum dynamic range. The following figure shows the result of the measurement.

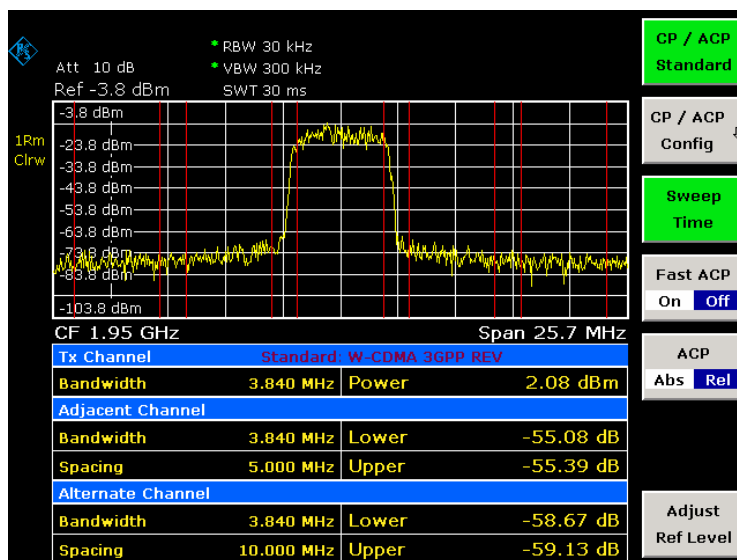

Fig. 2-24 Measuring the relative adjacent channel power on a W-CDMA uplink signal

5. Measuring adjacent channel power with the fast ACP mode.

- Set **Fast ACP** softkey to **On**.
- Press the **Adjust Ref Level** softkey.

The R&S FSL measures the power of the individual channels with zero span. A root raised cosine filter with the parameters $\alpha = 0.22$ and chip rate 3.84 Mcps (= receive filter for 3GPP W-CDMA) is used as channel filter.

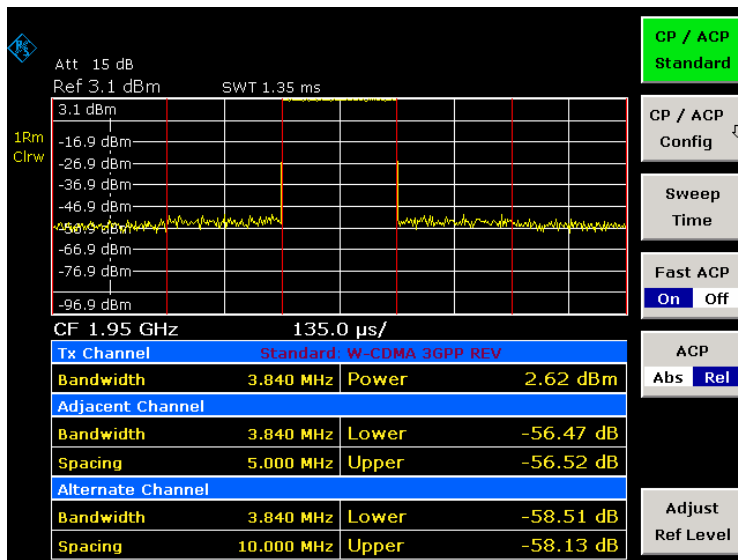

Fig. 2-25 Measuring the adjacent channel power of a W-CDMA signal with the fast ACP mode



With W-CDMA, the R&S FSL's dynamic range for adjacent channel measurements is limited by the 12-bit A/D converter. The greatest dynamic range is, therefore, obtained with the IBW method.

Optimum Level Setting for ACP Measurements on W-CDMA Signals

The dynamic range for ACP measurements is limited by the thermal noise floor, the phase noise and the intermodulation (spectral regrowth) of the spectrum analyzer. The power values produced by the R&S FSL due to these factors accumulate linearly. They depend on the applied level at the input mixer. The three factors are shown in the figure below for the adjacent channel (5 MHz carrier offset).

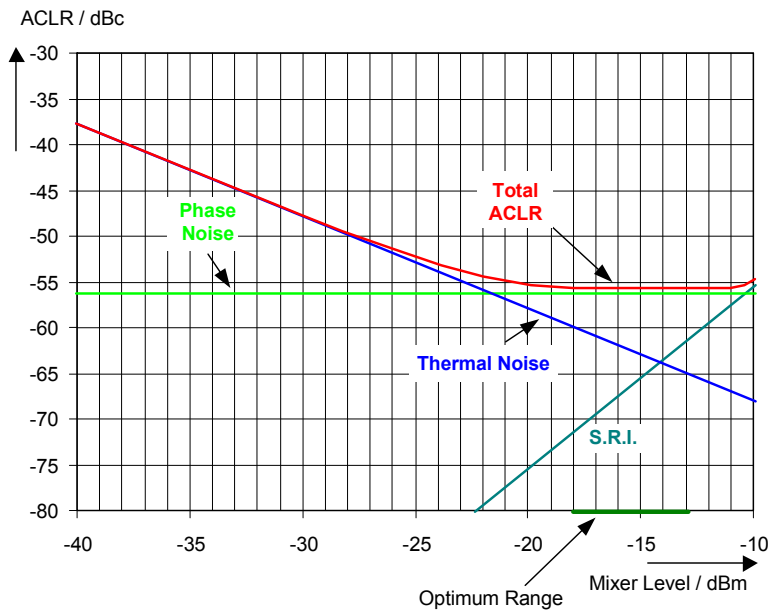

Fig. 2-26 The R&S FSL's dynamic range for adjacent channel power measurements on W-CDMA uplink signals is a function of the mixer level.

The level of the W-CDMA signal at the input mixer is shown on the horizontal axis, i.e. the measured signal level minus the selected RF attenuation. The individual components which contribute to the power in the adjacent channel and the resulting relative level (total ACPR) in the adjacent channel are displayed on the vertical axis. The optimum mixer level is -21 dBm. The relative adjacent channel power (ACPR) at an optimum mixer level is -65 dBc. Since, at a given signal level, the mixer level is set in 10 dB steps with the 10 dB RF attenuator, the optimum 10 dB range is shown in the figure: it spreads from -16 dBm to -26 dBm. In this range, the obtainable dynamic range is 62 dB.

To set the attenuation parameter manually, the following method is recommended:

- Set the RF attenuation so that the mixer level (= measured channel power - RF attenuation) is between -11 dBm and -21 dBm.
- Set the reference level to the largest possible value where no overload (IFOVL) is indicated.

This method is automated with the **Adjust Ref Level** function. Especially in remote control mode, e.g. in production environments, it is best to correctly set the attenuation parameters prior to the measurement, as the time required for automatic setting can be saved.



To measure the R&S FSL's intrinsic dynamic range for W-CDMA adjacent channel power measurements, a filter which suppresses the adjacent channel power is required at the output of the transmitter. A SAW filter with a bandwidth of 4 MHz, for example, can be used.

Amplitude Distribution Measurements

If modulation types are used that do not have a constant zero span envelope, the transmitter has to handle peak amplitudes that are greater than the average power. This includes all modulation types that involve amplitude modulation -QPSK for example. CDMA transmission modes in particular may have power peaks that are large compared to the average power.

For signals of this kind, the transmitter must provide large reserves for the peak power to prevent signal compression and thus an increase of the bit error rate at the receiver.

The peak power or the crest factor of a signal is therefore an important transmitter design criterion. The crest factor is defined as the peak power / mean power ratio or, logarithmically, as the peak level minus the average level of the signal.

To reduce power consumption and cut costs, transmitters are not designed for the largest power that could ever occur, but for a power that has a specified probability of being exceeded (e.g. 0.01%).

To measure the amplitude distribution, the R&S FSL has simple measurement functions to determine both the APD = Amplitude Probability Distribution and CCDF = Complementary Cumulative Distribution Function.

In the APD display mode, the probability of occurrence of a certain level is plotted against the level.

In the CCDF display mode, the probability that the mean signal power will be exceeded is shown in percent.

Measurement example - Measuring the APD and CCDF of white noise generated by the R&S FSL

1. Set the R&S FSL to its default state.

- Press the **PRESET** key.
The R&S FSL is in its default state.

2. Configure the R&S FSL for APD measurement

- Press the **AMPT** key and enter *-60 dBm*.
The R&S FSL's intrinsic noise is displayed at the top of the screen.
- Press the **MEAS** key.
- Press the **More** softkey.
- Press the **APD** softkey.

The R&S FSL sets the frequency span to 0 Hz and measures the amplitude probability distribution (APD). The number of uncorrelated level measurements used for the measurement is 100000. The mean power and the peak power are displayed in dBm. The crest factor (peak power - mean power) is output as well.

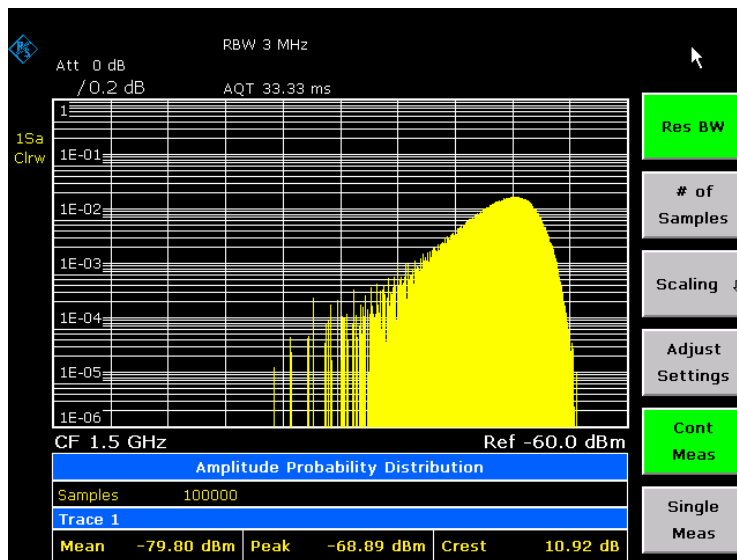

Fig. 2-27 Amplitude probability distribution of white noise

3. Switch to the CCDF display mode.

- Press the **▲** key.
- Press the **CCDF** softkey.
The CCDF display mode is switched on.

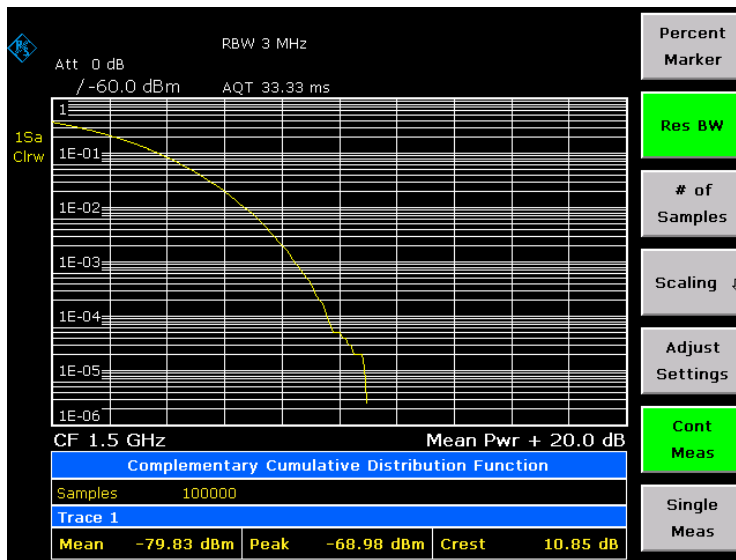

Fig. 2-28 CCDF of white noise

The CCDF trace indicates the probability that a level will exceed the mean power. The level above the mean power is plotted along the x-axis of the graph. The origin of the axis corresponds to the mean power level. The probability that a level will be exceeded is plotted along the y-axis.

4. Bandwidth selection

When the amplitude distribution is measured, the resolution bandwidth must be set so that the complete spectrum of the signal to be measured falls within the bandwidth. This is the only way of ensuring that all the amplitudes will pass through the IF filter without being distorted. If the resolution bandwidth which is selected is too small for a digitally modulated signal, the amplitude distribution at the output of the IF filter becomes a Gaussian distribution according to the central limit theorem and so corresponds to a white noise signal. The true amplitude distribution of the signal therefore cannot be determined.

5. Selecting the number of samples

For statistics measurements with the R&S FSL, the number of samples $N_{Samples}$ is entered for statistical evaluation instead of the sweep time. Since only statistically independent samples contribute to statistics, the measurement or sweep time is calculated automatically and displayed. The samples are statistically independent if the time difference is at least $1/RBW$. The sweep time SWT is, therefore, expressed as follows:

$$SWT = N_{Samples} / RBW$$

Bluetooth Measurements (Option K8)

This section gives background information on Bluetooth Measurements (option K8). It provides information on the following topics:

- [Bluetooth Overview](#)
- [Supported Tests](#)
- [Overview of Transmitter Tests](#)
- [Functional Description - Block Diagram](#)
- [Bandwidths](#)
- [Measurement Filter \(Meas Filter On\)](#)
- [Oversampling](#)
- [Determining Average or Max/Min Values](#)
- [Trigger Concepts](#)

For further information on measurement examples refer also to the Quick Start Guide, chapter 5 "Basic Measurement Examples".

This option is available from firmware version 1.30.

Bluetooth Overview

This section provides the following general information on Bluetooth measurements:

- [Bluetooth technical parameters](#)
- [Power classes](#)
- [Structure of a Bluetooth data packet](#)

Bluetooth technical parameters

Table 2-1 Common Parameters

frequency bands	2402 + (0...78) MHz
channel spacing	1 MHz
symbol rate	1 Msym/s
slot length (frequency hopping)	625 μ sec
packet sizes	1, 3, 5 slot packets

Table 2-2 Modulation Parameters Basic Rate

modulation	GFSK
TX filter	Gaussian
BT /	0.5
modulation index	0.28 - 0.35 nominal 0.32
frequency deviation	160 kHz settled 141 kHz 010101 suite

bandwidth -3dB -20dB	220 kHz 1 MHz
bit rate	1 Mbps

Table 2-3 Modulation Parameters Enhanced Data Rate

modulation	$\pi/4$ -DQPSK	8DPSK
TX filter	RRC	RRC
roll-off factor	0.4	0.4
bandwidth -3dB	\pm 500kHz	\pm 500kHz
bit rate	2 Mbps	3 Mbps

Power classes

Power Class	Maximum (P _{max})	Nominal	Minimum (P _{min})	Power Control
1	100 mW (20 dBm)		1 mW (0 dBm)	from P _{min} (< +4 dBm) to P _{max}
2	2.5 mW (4dBm)	1 mW (0 dBm)	0.25 mW (-6dBm)	optional
3	1 mW (0dBm)			optional

Structure of a Bluetooth data packet

Every Bluetooth data packet is divided into 3 basic section: access code, header and payload. The following figures show the order and bit lengths of the individual sections:

access code 72 bits			54 bits header	240 / 1496 / 2744 bits payload*)
4 bits preamble	64 bits sync word	4 bits trailer		

*) During EUT evaluation the payload contains certain bit sequences: PRBS9 (Pseudo Random Bit Sequence) or 11110000 or 10101010.

The sync word is transmitted as the major part of the access code. For this purpose, the LAP (lower address part) of the BD address is expanded to 64 bit by adding the BCH code and baker.

sync word 64 bits		
BCH code 34 bits	LAP 24 bits	Barker 6 bits

The LAP (lower address part) of the BD address serves as a basis for the sync word.

BD - address 48 bits		
NAP 16 bits	UAP 8 bits	LAP 24 bits

In case of EDR packets the payload is divided into 6 other sections:

DPSK					
guard 5 μ s	SYNC	payload header	user payload 0-2723Symb	CRC code	trailer

Supported Tests

The Bluetooth Measurements Option supports measurements according to the Bluetooth RF Test Specification (Bluetooth SIG) , Revision 2.0.E.3, Mar 2005, on the R&S FSL. The following tests are currently implemented according to this specification:

- Output Power
- TX Output Spectrum - Adjacent Channel Power
- Modulation Characteristics
- Initial Carrier Frequency Tolerance (ICFT)
- Carrier Frequency Drift
- EDR Relative Transmit Power
- EDR Carrier Frequency Stability and Modulation Accuracy
- EDR Differential Phase Encoding
- EDR In-band Spurious Emissions

Overview of Transmitter Tests

Table 2-4 Basic Rate Measurements

	Output Power	TX Output Spectrum - Adjacent Channel Power	Modulation Characteristics	Initial Carrier Frequency Tolerance	Carrier Frequency Drift
Hop	on	off	off	on / off	on / off
Trigger	extern	-	-	-	-
Synchronization	Yes (p0), but also possible without	no	yes (p0)	yes (p0)	yes (p0)
Packet Type	longest supported	DH1	longest supported	DH1	all supported packets (DH1/3/5)
Payload	PRBS 9	PRBS 9	11110000 10101010	PRBS 9	10101010
Test Mode	loop back	loop back	loop back	loop back	loop back
Operating Mode	IQ mode	analyzer zero span	IQ mode	IQ mode	IQ mode
RBW	3 MHz	100 kHz	-	-	-
VBW	3 MHz	300 kHz	-	-	-
Power	supported maximum	supported maximum	supported maximum	supported maximum	not specified
Sweep Time	one complete packet	79s per sweep (= 100ms * 10 * 79)	one complete packet	-	one complete packet
Sweep Count	-	10	10 (extern)	10	10
Trace Mode	Maxh	Maxh	-	-	-
Detector	Peak	Aver	-	-	-
Frequency in MHz	low / middle / high	each channel	low / middle / high	low / middle / high	low / middle / high

	Output Power	TX Output Spectrum - Adjacent Channel Power	Modulation Characteristics	Initial Carrier Frequency Tolerance	Carrier Frequency Drift
Span	-	-	-	-	-
Test cond	norm / ext	norm / ext	norm / ext	norm / ext	norm / ext
Results	peak and average power 1) $P_{AV} < 100$ mW (20 dBm) 2) $P_{PK} < 200$ mW (23 dBm) 3) $P_{max} > P_{AV} > P_{min}$ at maximum power step $P_{AV} < 1$ mW (0 dBm)	channel power of all channels 1) $P_{TX}(f) \leq -20$ dBm for $ M-N = 2$ 2) $P_{TX}(f) \leq -40$ dBm for $ M-N \geq 3$	all 8 bit peak deviations and average deviations	carrier offset within the 4 preamble bits	carrier offsets of the 4 bit preamble, of all 10 bit payload sequences; maximum drift rate of all 10 bit payload sequences at 50 μ s offset

Table 2-5 Enhanced Data Rate Measurements

	EDR Relative TX Power	EDR Carrier Frequency Stability and Modulation Accuracy	EDR Differential Phase Encoding	EDR In-band Spurious Emissions
Hop	off	off	off	off
Trigger	-	-	-	extern/ IF power
Synchronization	yes	yes	yes	yes, needed for gate adjustment
Packet Type	longest supported	longest supported	longest supported	longest supported
Payload	PRBS 9	PRBS9	PRBS9	PRBS9
Test Mode	loop back	loop back	TX mode	loop back
Operating Mode	IQ mode	IQ mode	IQ mode	analyzer zero span
RBW	3 MHz	-	-	100 kHz
VBW	3 MHz	-	-	300 kHz
Power	supported minimum/ maximum	supported minimum/ maximum	supported minimum/ maximum	supported minimum/ maximum
Sweep Time	one complete packet	one complete packet	one complete packet	10*79* gate length
Sweep Count	10	200 blocks	100	10
Trace Mode	ClrWr	-	-	Maxh
Detector	Aver	-	-	Aver
Frequency in MHz	low / middle / high	low / middle / high	low / middle / high	each channel
Span	-	-	-	79 MHz
Test cond	norm / ext	norm / ext	norm / ext	norm / ext
Results	ratio of DPSK and GFSK power	carrier frequency stability and error vector magnitude	number of failed packets	channel power of all channels

Functional Description - Block Diagram

The Adjacent Channel Power and EDR In-band Spurious Emissions measurements are performed in the **Spectrum Analyzer** mode. For this test case the complete frequency band is scanned using a sequence of zero span measurements.

All other test cases are based on a digital I/Q demodulator which determines the temporal characteristics of power and frequency. The output data of the demodulator are the basis for calculation of all relevant measurement results like modulation characteristics or output power. The demodulator reaches a maximum in accuracy and temperature stability by sampling the IF signal and converting it digitally down into the base band (I/Q area).

The measurements are performed by passing the following signal processing steps:

- LAP (Lower Address Part) trigger detection
- Resampling
- Channel filtering
- Automated packet and bit pattern detection
- Limit check
- Parallel display of measurement curves and numeric results on the screen

Fig. 2-1 shows the R&S FSL hardware from the IF to the processor. The analog IF filter is fixed to 20MHz. The A/D converter samples the 20 MHz IF signal with a sampling frequency of 65.83 MHz.

Low pass filtering is performed after the signal has been down-converted into the complex base band and the data rate is reduced in the sequence. The amount of decimation depends on the selected oversampling factor = points / symbol. The default setting is 4, resulting in a 4 MHz sampling rate. For EDR-measurements, the oversampling factor is always fixed to 4. The resulting I/Q data are stored in a memory of 512 k words for I and Q respectively. The hardware trigger (external or IF power) controls the memory access.

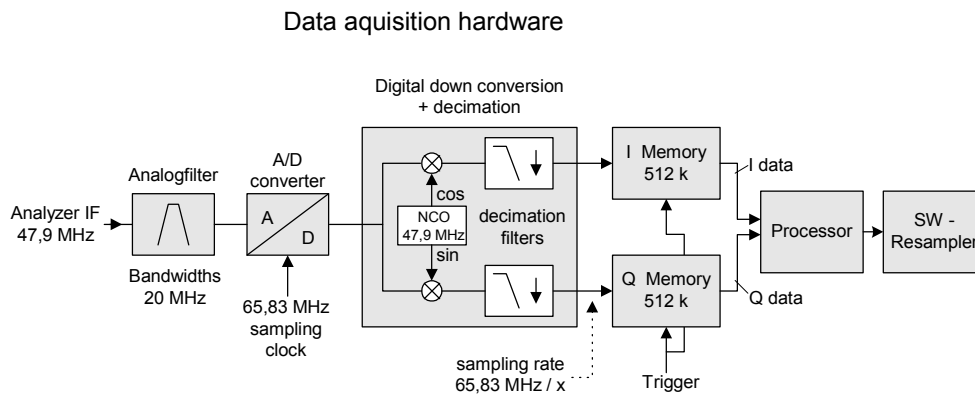

Fig. 2-29 Block diagram of the signal processing architecture of the R&S FSL

Bandwidths

The Bluetooth RF Specification defines a minimal bandwidth of 3 MHz. The digital bandwidth depends on the selected oversampling factor (= points / symbol). With the default setting of 4, the digital bandwidth is 3 MHz. This digital filter has a flat amplitude characteristics and does not affect the frequency deviation of the signal.

Measurement Filter (Meas Filter On)

The RF Specification allows high distortion power in the first adjacent channels. The 3 MHz filter does not suppress this kind of distortion, which leads to a high interference in modulation. Therefore a precise measurement of the frequency deviation is not possible.

In order to obtain correct deviation results, the spectrum analyzer supplies an optional filter with a passband only appropriate for the channel to measure. This filter is used by default. The Bluetooth spectrum has a bandwidth of 1 MHz. The filter is flat within 1.04 MHz (ripple: only 0.02 dB) and has steep edges. This measurement filter is not dependent on the selected oversampling factor. As a result the displayed deviation value is increased by 3.2%, but without the filter the displayed deviation value can increase dramatically due to interference from adjacent channels. Generally the result is more precise, if the displayed deviation is lower with filtering than without filtering. In these cases the inaccuracy caused by the adjacent channel interference is higher than the systematic inaccuracy caused by the filter.

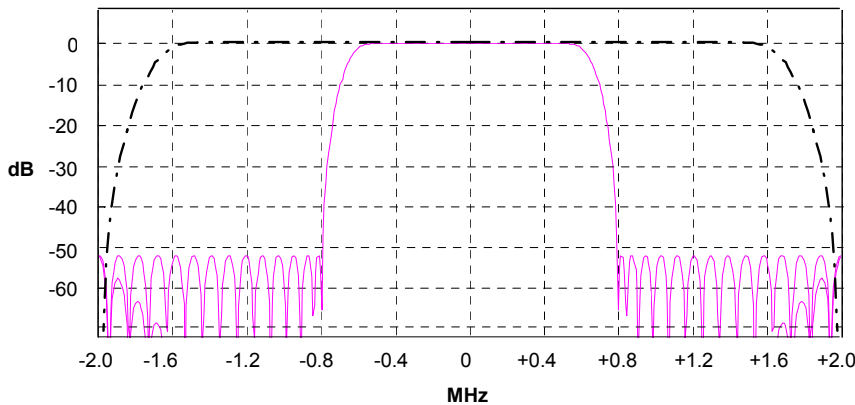

Fig. 2-30 Selection of digital filters

Dashed-dotted curve: Standard filter with 4 points / symbol

Solid curve: Optional measurement filter, independent of the points / symbol setting

Oversampling

The number of samples per symbol is equivalent to the sampling rate in MHz (due to the symbol length of 1 μ s).

Digital bandwidth (flat area)	Points per Symbol	Sampling rate
10 MHz	32	32 MHz
8 MHz	16	16 MHz
5 MHz	8	8 MHz
3.0 MHz	4	4 MHz
1.6 MHz	2	2 MHz

According to the RF Test Specification an oversampling factor of 4 is required at minimum. For Basic Rate measurements, this oversampling factor can be selected as oversampling factor in a range from 2 to 32. For EDR-measurements, the oversampling factor is fixed to 4 which is also the default value.

Although possible but not recommended is a value > 4 . It increases the measurement time due to the extended calculation effort. Additionally the resulting bandwidth will be larger than required, which leads to lower measurement accuracy, unless the optional measurement filter (Meas Filter On) is used as described in section [Bandwidths](#).

The spectrum analyzer uses a timing offset correction in order to move the samples to the zero crossing points. As a result there is one sample per symbol time, which is especially important for a 0101 symbol sequence in order to obtain the precise value for the peak frequency deviation.

Sampling times before timing offset correction

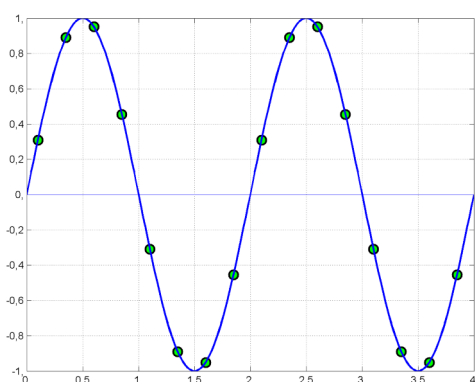

Sampling times after timing offset correction

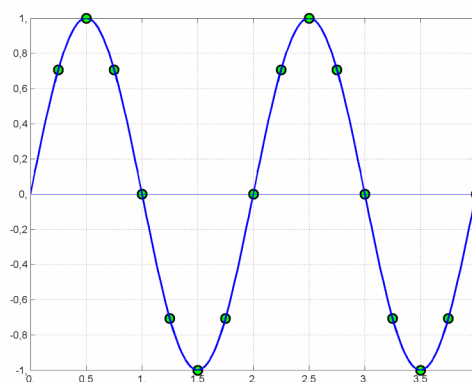

Fig. 2-31 Operation of the timing offset correction

Advantages of the timing offset correction:

- No jitter with low sampling rates
- With one sample per zero, the trespassing point is always a sample in the middle of the bit length. Therefore the maximum values in the frequency deviation of 0101 bit patterns can be detected precisely also with low sampling rates.
- The immunity to interference when determining the data bits is improved.
- Higher suppression of the distortion during peak detection.

Determining Average or Max/Min Values

These functions are very useful in order to obtain more stable results or to find sporadic spurious signals not included in every burst. In many cases the RF Test Specification defines measurements over a 10 burst period.

The number of measurements can be selected using sweep count function, thus adapting the measurement to the individual requirements.

In single sweep mode, the calculation of average or maximum / minimum values is performed over a well-defined number of sweeps (= sweep count).

Continuous sweep mode yields continuous averaging and calculation of maximum / minimum values over the whole measurement time.

Modulation measurements

They are performed in the **Clear Write** trace mode.

In continuous sweep mode, a "live" display is obtained, which allows e.g. an instant view of changes during alignment of a DUT.

In single sweep mode and with the sweep count set to 10, the spectrum analyzer will evaluate 10 bursts as required by the RF Test Specification. This means that a result is obtained after exactly 10 bursts.

Power measurements

They are performed in the **Maxhold** trace mode in relation with the defined measurement time. The measurement time is selected in order to make sure that always one complete burst is acquired. In this case, several sweeps are combined to one trace before this result trace is evaluated.

Impact of the sweep count on the measurement results

Trace Mode	Continuous Sweep	Single Sweep & Sweep Count
Clear Write	All measurement results (min., max., average) are updated with every sweep. The corresponding values are calculated based on the current curve.	Starts a measurement with n sweeps (n = sweep count). All measurement results (min., max., average) are calculated based on these n sweeps.
AVG, MaxHold, MinHold	All measurement results (min., max., average) are updated with every sweep. The corresponding values are calculated based on the current curve. The trace is the continuous average value (AVG) or the extreme value (MaxHold, MinHold) since the start of the measurement.	Starts a measurement with n sweeps (n = sweep count). n defines the number of sweeps that are taken into account for the trace math functions (AVG, MaxHold, MinHold). The n sweeps result in one trace and the measurement results (Min, Max, Average) are calculated based on this summarized trace.

The functions described above differ from the detector functions of the instrument:

- Detectors combine the measurement data obtained by oversampling to *one measurement point* on the screen. The kind of combination (Max Peak, Min Peak, Average, RMS) can be selected.
- The trace functions affect complete measurement curves: A resulting curve is calculated from *several subsequent sweeps*. The method of calculation (Average, Maxhold, Minhold) can be selected here as well.

Thus the detector is the arithmetic rule for how sample data collected with a high data rate are combined to a measurement point of one individual measurement curve, whereas the trace mode is the rule of how samples taken from several measurement curves are to be combined to a new resulting curve.

For the ACP measurement, the Average detector is set.

Trigger Concepts

As the DUT (Device Under Test) uses frequency hopping, a trigger method is necessary for two reasons:

- A measurement is only possible during the period of time, when there is a TX signal (burst) at the frequency under request.
- In order to determine the modulation characteristics correctly, a synchronization with the preamble of the signal must be supplied.

If the **Find Sync** softkey is activated, the synchronization is supplied towards the 64 bit sync word. For this purpose, in a first step a burst is searched automatically within the RF signal, or, if selected, the external trigger or the IF power trigger are used to determine the burst position.

In a second step the sync word position is searched by correlation of the signal with the sync word defined in the initialization phase. The correlation is performed directly with the FM signal, not with the data bits, which are only available after the phase shifter has been processed. The find burst process is continued as long as no sync word is found.

After the position of the sync word has been determined, the position of the p0 bit is calculated from the average value of all zero trespassing points, as defined in the RF test specification. Finally the samples are moved in a way that each sample matches one zero trespassing point (phase shifting).

The only measurement possible without synchronization is the Output Power measurement. The specified measurement time is 20% to 80% of the burst length. Without synchronization the burst length is defined via the -3dB points of the power curve. With synchronization the burst starts with the p0 bit. Therefore varying measurement results is possible if the power of the EUT is not constant within the burst.

In order to supply stable synchronization the EUT must be operated in reduced hopping mode. The EUT is only allowed to toggle between two frequencies, because otherwise the repetition time for the same frequency would become higher than the record length.

If the test environment supplies an external trigger that marks the channel to be measured a synchronization is also possible with normal hopping operation.

Cable TV Measurements (Option K20)

This section describes measurement examples for the Cable TV Measurements option (K20), and is divided into the following topics:

- [Analog TV Basics](#)
gives an introduction into the fundamentals of analog modulated TV signals.
- [Analog TV Measurement Examples](#)
describes the test setup, settings for analog TV measurements and gives examples for the different measurement type.
- [Digital TV Basics](#)
gives an introduction into the fundamentals of digital modulated TV signals.
- [Digital TV Measurement Examples](#)
gives an introduction into the fundamentals of digital modulated TV signals.
- [Channel Tables and Modulation Standards](#)
explains the use of channel tables and modulation standards.
- [Performing a Measurement without a Channel Table](#)
shows how to perform a measurement without using a channel table.
- [Performing a Measurement Using a Channel Table](#)
gives an example how to perform a measurement using a channel table.

For further information on measurement examples refer also to the Quick Start Guide, chapter 5 "Basic Measurement Examples".

This option is available from firmware version 1.30.

Analog TV Basics

This section gives an introduction into the fundamentals of analog modulated TV signals. A special focus is laid on the parameters that the Cable TV Measurements option (K20) uses to characterize signals.

For analog modulated TV signals based on PAL, SECAM, and NTSC, [Fig. 2-32](#) shows the situation in principle: the components of the signal, and both frequency and level at the output of a TV transmitter (RF range).

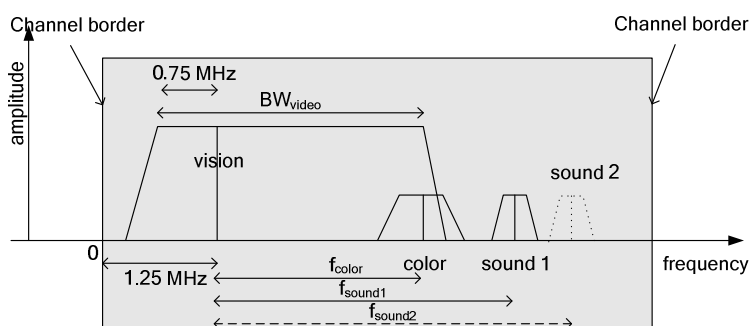

Fig. 2-32 Analog modulated signals in the RF range

The gray area marks the TV channel. Inside this area, all components of a TV signal are located. A TV signal consists of the following:

- The vision carrier, indicated in Fig. 2-32 with "vision", is located 1.25 MHz above the channel start. The vision carrier has the highest level and mainly assesses the total power of the channel. It transmits the luminance information and is amplitude modulated. The amplitude modulation is mostly negative (the smaller the luminance signal the larger the vision carrier level), apart from SECAM/L (large vision carrier level combined with a large luminance signal). Only a part (around 0.75 MHz) of the lower sidebands of the vision carrier is transmitted. Therefore it is called "residual sideband modulation". The video bandwidth BW_{video} amounts to, depending on the standard, approx. 5 MHz (e.g. PAL B/G) or approx. 4 MHz (e.g. M/NTSC).
- The color carrier, indicated in Fig. 2-32 with "color", is shifted by f_{color} to a higher frequency value in respect to the vision carrier. The magnitude of f_{color} depends on the standard. The level of the color carrier is by far smaller than that of the vision carrier. Depending on the standard, the signal is analog quadrature amplitude modulated (e.g. PAL B/G) or frequency modulated (SECAM).
The color carrier is not considered in the measurements of the Cable TV Measurements option.
- One or two sound carriers, indicated in Fig. 2-32 with "sound 1" and "sound 2", are shifted by f_{sound1} or f_{sound2} to a higher frequency value in respect to the vision carrier. The magnitude of f_{sound1} or f_{sound2} depends on the standard. The level of the sound carriers is by far smaller than that of the vision carrier. Depending on the standard, the sound carriers are frequency, amplitude, or NICAM (digitally) modulated. The sound carriers do not need to possess the same modulation. For example, a combination of a frequency modulated carrier with a NICAM modulated carrier is possible.

The large diversity of TV standards based on PAL, SECAM und NTSC differ not only in the parameter described above. Some other parameter are for example:

- number of picture lines and their duration
- form and group delay of the residual sideband filter
- parameters of the used AM / FM / NICAM modulations (e.g. modulation depth, frequency deviation, symbol rate)
- channel width and frequency range of the channels (different from country to country)
- stereo and mono sound signals, stereo transmission type

Analog TV Measurement Examples

These measurements are set up to carry out single channel measurements of analog TV signals. The settings for analog TV measurements are described in section [Analog TV settings](#). The test setup for the following measurement types is provided in section [Analog TV test setup](#).

- [Spectrum measurement](#)
- [Carriers measurement](#)
- [Video Scope measurement](#)
- [Vision Modulation measurement](#)
- [Hum measurement](#)
- [C/N measurement](#)
- [CSO measurement](#)
- [CTB measurement](#)

Analog TV settings

The Cable TV Measurements option needs to know some of the parameters described in section [Analog TV Basics](#) to perform correct measurements. It therefore stores these parameters in the so-called "modulation standard". Refer to section [Modulation standards](#) for the creation and usage of a modulation standard. Section [Analog TV modulation standards](#) contains the description of the parameters that have to be characterized for an analog TV signal. The following list explains the meaning of the parameters:

- **Name:** Choose an arbitrary name for the new modulation standard.
- **Signal Type:** If you want to characterize an analog TV signal, select **Analog TV**.
- **TV Standard:** The standard used to modulate the luminance information. Can be "B/G", "M", "D/K" and so on.
- **Sound System:** Are one or two sound carriers in use? What type of modulation is used for each of them? What are their frequencies, relative to the vision carrier?

The selection "FM 5.5/ FM 5.742" for example specifies, that two frequency modulated sound carriers are used. One is 5.5 MHz and is about 5.472 MHz above the vision carrier.

The values you can choose depend on the selected TV standard. Not all combinations are allowed!

- **Group Delay:** What group delay shall the residual sideband filter have?
- **Color System:** The color information of the video signal is transmitted according to either the PAL or NTSC or SECAM standard. The values you can choose depend on the selected TV standard. Not all combinations are allowed!
- **Bar Line:** The Vision Modulation measurement needs a special test signal, containing a peak white value. You must specify the type and the number of the horizontal line that contains the peak white value.
- **Quiet Line:** Some measurements need a horizontal line with no video information in it. You must specify the number of this horizontal line here. For further information see also [Example: Creating a channel table](#).
- **Sideband Position:** Is the signal in normal position or inverted?



In the dialog boxes, set the parameters always from top to bottom, since all parameters depend on the parameters above them. Otherwise your input might be rejected, e.g. if it specifies an unusual TV standard.

Analog TV test setup

This section describes the setup used for the analog TV measurement examples. All analog measurement examples are performed in the **Cable TV Analyzer** mode.

1. Press the **MENU** key to display the cable TV measurements main menu.
2. Press the **Channel Setup** softkey.
3. In the **Channel Tables** dialog box, select channel table **<none>**.
4. Press the **Activate** softkey.

The TV standard is automatically set to the default analog TV modulation standard, which has the following parameters (see also [Analog TV settings](#)).

- **Signal Type** = *Analog TV*
- TV Standard = *B/G*
- Sound System = *FM 5.5 / FM 5.742*
What kind of sound carrier(s) are used.
- **Group Delay** = *General*
This setting has no effect on the measurements in this firmware release.
- Color System = *PAL*
- **Bar Line** = *18*
Type = *CCIR 17*
Where is the "white reference" and of what kind is it? The Vision Modulation measurement demands correct settings!
- **Quiet Line** = *22*
Which horizontal line shall be used for "Quiet Line" based CNR / CSO measurement. This line shall have no video information!
- **Sideband Position** = *Normal*
Only change this setting if you have inverted sidebands.

As long as you measure without a channel table, the Cable TV Measurements option expects a signal with these parameters. If your signal does not fit, some measurements may fail.

5. If you use an analog TV test transmitter, configure it to transmit a suitable signal:
 - Choose a reasonable, not too high output level.
 - Set the transmitters's vision carrier frequency to *210.25 MHz*.
6. If your test transmitter is not capable of this or if you want to connect the R&S FSL to your CATV network, which does not contain a suitable signal, change the default analog TV modulation standard:
 - Press the **MEAS** key.
 - Press the **Analog TV** softkey.
 - Press the **Analog TV Settings** softkey.

- Change the default analog TV modulation standard as described in section [Analog TV modulation standards](#) in order to adapt it to the signal you provide for the R&S FSL.

Spectrum measurement

This measurement gives an overview of the active measurement channel. It is a swept measurement like in the **Spectrum Analyzer** mode. All parameters are set automatically according to the used modulation standard. The spectrum is displayed in a full screen trace.

Test setup:

Refer to the section [Analog TV test setup](#).

Procedure:

1. Press the **MEAS** key.
2. Press the **Analog TV** softkey.
3. Press the **Spectrum** softkey.
4. To adjust the input attenuator, press the **Adjust Attenuation** softkey.
5. Press the **FREQ** key.
6. Enter *210.25 MHz* for the vision carrier frequency of the input signal. Note that this frequency is not the middle of the shown span.
7. Press the **RUN** key.

The spectrum of the input signal is displayed.

The vertical lines mark the vision carrier (VC) and sound carrier (SC1 and SC2) frequencies. They mark the ideal frequencies according to the chosen standard and RF frequency, not the measured ones.

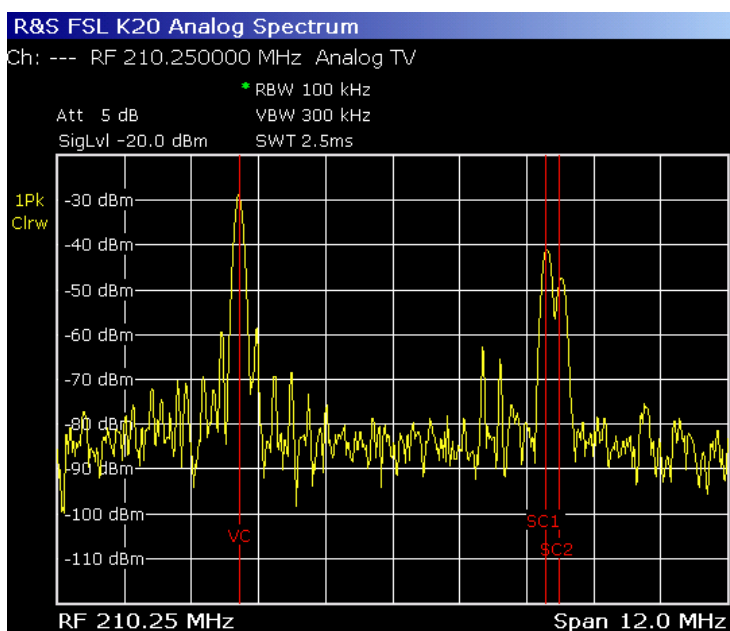

Fig. 2-33 Analog TV Spectrum measurement

Carriers measurement

This measurement determines the carrier power (vision carrier, one or two sound carriers) and the frequency distances. It also compares them against the default values. The sound carrier power is displayed relative to the measured vision carrier power.

The measurement display is split into two panes. In the upper pane, the spectrum as in the corresponding Spectrum measurement is displayed. In the lower pane, the result table for the measurement is displayed.

Test setup:

Refer to the section [Analog TV test setup](#).

Procedure:

1. Press the **MEAS** key.
2. Press the **Analog TV** softkey.
3. Press the **Carriers** softkey.
4. To change the limits, press the **Edit Table** softkey.
5. To adjust the input attenuator, press the **Adjust Attenuation** softkey.
6. Press the **FREQ** key.
7. Enter *210.25 MHz* for the vision carrier frequency of the input signal.
8. Press the **RUN** key.

The upper pane gives a quick overview of the channel, just like in the Spectrum measurement.

In the lower pane, you can check whether the signal meets the requirements. Absolute and relative powers and frequencies are measured and compared against the limits. The result is either **Pass** or **Fail**.

In the measurement example, all results were within the chosen limits, except the absolute power of the vision carrier. This is indicated by red color and a star.

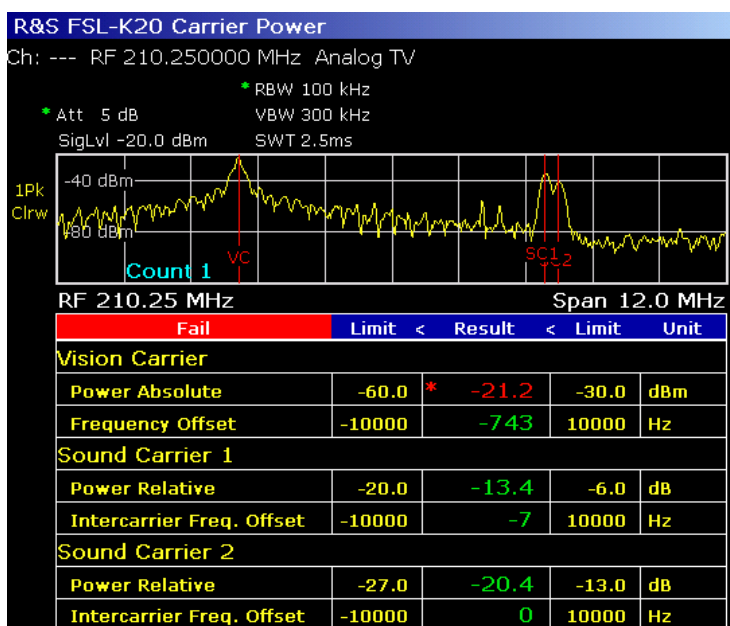

Fig. 2-34 Analog TV Carriers measurement



The "frequency offsets" are measured in this way:

For sound carriers:

The TV standard demands that the sound carrier frequency shall be f_1 Hz greater than the vision carrier frequency. The actual frequency distance might be measured to be f_2 .

The value "Intercarrier frequency offset" is therefore: $f_2 - f_1$.

For the vision carrier:

The value "frequency offset" is the measured vision carrier frequency minus the RF frequency.

Video Scope measurement

This measurement determines the luminance signal in dependence of the time. The video scope is triggered by the chosen trigger event, i.e. the line to be analyzed. From the result trace, the effects of hum are eliminated ("back porch clamping").

Test setup:

Refer to the section [Analog TV test setup](#).

Procedure:

1. Press the **MEAS** key.
2. Press the **Analog TV** softkey.
3. Press the **More** softkey.
4. Press the **Video Scope** softkey.
5. For the TV standard **M** in combination with another color system than **PAL**, press the **Field 1/2** softkey to select field 1 or 2.
6. Press the **Line** softkey to enter the line number.
7. To change the sweep time, press the **Sweptime Manual** softkey and enter a value (25 μ s up to 100 μ s).
8. To define a trigger offset, press the **Trigger Offset** softkey and enter a value (-50 μ s up to 50 μ s). Choose 0 μ s to make the display start with the horizontal sync of the specified line. Negative values make the display start earlier.
9. To adjust the input attenuator, press the **Adjust Attenuation** softkey.
10. Press the **FREQ** key.
11. Enter *210.25 MHz* for the vision carrier frequency of the input signal.
12. Press the **RUN** key.

The trace shows the luminance signal during the selected period versus time. The group delay is not compensated internally.

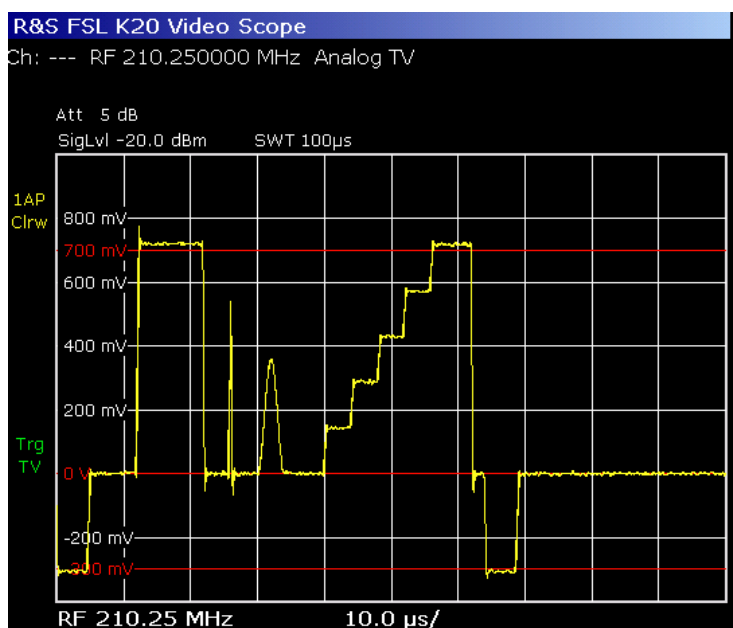

Fig. 2-35 Video Scope measurement

Vision Modulation measurement

This measurement determines the "residual picture carrier" and the modulation depth of the vision carrier.

The vision carrier is amplitude modulated (AM). To be more precise, it uses the residual sideband amplitude modulation. Most standards use negative amplitude modulation. Therefore, the vision carrier has its highest level when the luminance signal is equal to the "synchronizing level". And it has its lowest level when the luminance signal is equal to the "peak white level". The "synchronizing level" can be measured in every horizontal synchronizing pulse. The "peak white level" can be measured in special test lines ("bar line"), where a white reference is transmitted.

The residual picture carrier is the ratio of the "peak white level" to the "synchronizing level". The sum of the vision carrier's modulation depth and the residual picture carrier value must equal 1.

The measurement display is split into two panes. In the upper pane, the RF level of the vision carrier during one horizontal line is displayed. In the lower pane, the result table for the measurement is displayed.

Test setup:

Refer to the section [Analog TV test setup](#).

Procedure:

1. Press the **MEAS** key.
2. Press the **Analog TV** softkey.
3. Press the **More** softkey.
4. Press the **Vision Modulation** softkey.
5. To change the limits, press the **Edit Table** softkey. A limit change in the lower two lines leads to a change of the other limits, since the measurement results depend on each other.
6. To adjust input attenuator, press the **Adjust Attenuation** softkey.
7. Press the **FREQ** key.

8. Enter 210.25 MHz for the vision carrier frequency of the input signal.
9. Press the **RUN** key.

The upper pane shows the RF level of the vision carrier versus time in the "bar line". The "bar line" is a specific horizontal line, that holds a white reference. The number of this line is specified in the modulation standard of the measured channel. To be more exactly: It is specified in the analog TV default modulation standard, since no channel table is used right now.

If the input signal does not contain a white reference in the specified line, the results are not correct!

The lower pane shows the numeric results and whether they are within the limits or not.

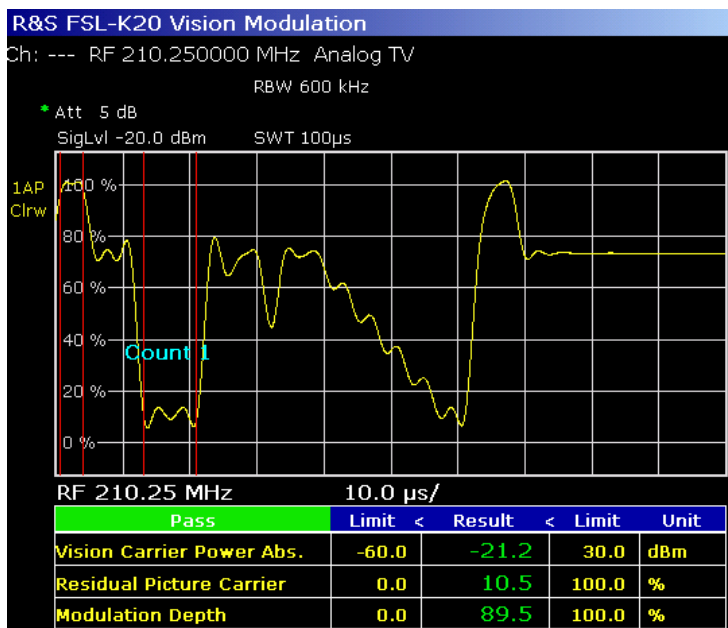

Fig. 2-36 Vision Modulation measurement

Hum measurement

This measurement determines whether the signal comprises hum, a not-wanted amplitude modulation of the analog TV signal, mostly due to defective amplifiers. For the Hum measurement, the AM modulated frequency must be below 1 kHz and is typically equal to the power line frequency times one or two, e.g. 50 Hz, 60 Hz, 100 Hz, 120 Hz.

Test setup:

Refer to the section [Analog TV test setup](#).

Procedure:

1. Press the **MEAS** key.
2. Press the **Analog TV** softkey.
3. Press the **More** softkey.
4. Press the **Hum** softkey.
5. If you want to adjust the range of the y-axis, press the **Auto Range** softkey.
6. To change the limits, press the **Edit Table** softkey.
7. To adjust the input attenuator, press the **Adjust Attenuation** softkey.

8. Press the **FREQ** key.
9. Enter *210.25 MHz* for the vision carrier frequency of the input signal.
10. Press the **RUN** key.

In case you use a TV test transmitter or your CATV network is in good condition, you will see a rather flat line, since there will be little hum.

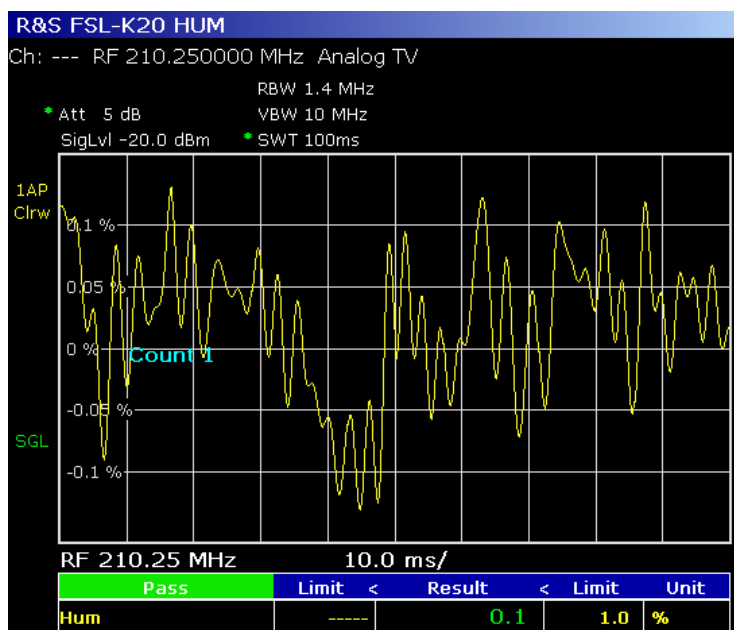

Fig. 2-37 Hum measurement

C/N measurement

This measurement determines the ratio of signal power and noise power (carrier to noise), a very important figure of merit.

The signal power is normally the peak power of the modulated vision carrier, which is the power of the unmodulated vision carrier. You can modify this default setting with the **Reference Power** softkey (for details refer to chapter 4, section "Cable TV Measurements (Option K20)").

The power of the noise is internally measured with a small resolution filter, and then translated to a user-defined bandwidth, the so-called reference noise bandwidth. This bandwidth should normally be as large as the video signal bandwidth, i.e. 4 MHz for M/NTSC and 5 MHz otherwise.

The measurement can be performed in 3 different ways, as shown in the following examples:

- [C/N Off-Service measurement](#)
- [C/N In-Service measurement](#)
- [C/N Quiet Line measurement](#)

The measurement display is split into two panes. The upper pane displays the spectrum of the measured noise. The lower pane displays the result table for the measurement and whether the limits are passed or failed.

C/N Off-Service measurement**Test setup:**

Refer to the section [Analog TV test setup](#).

Procedure:

1. Press the **SWEEP** key.
2. Press the **Single Sweep** softkey.
3. Press the **FREQ** key.
4. Enter *210.25 MHz* for the vision carrier frequency of the input signal.
5. Press the **MEAS** key.
6. Press the **Analog TV** softkey.
7. Press the **C/N** softkey.
8. To change the limits, press the **Edit Table** softkey.
9. To adjust the input attenuator, press the **Adjust Attenuation** softkey.
10. Press the **C/N Setup** softkey to open the **C/N Setup** dialog box.
 - Make sure, that **Off-Service** is chosen as measurement mode.
 - Set the **Reference Noise Bandwidth** to *5 MHz* (or another value).
 - Specify the span for the noise measurement in the table: Change the **CF** value to *2.5 MHz* (denotes the middle of the span relative to the vision carrier) and the **Span** value to *5 MHz*.
 - If desired, activate the **Noise Floor Correction** option.
11. Press the **RUN** key.
12. Turn on the signal when prompted and confirm by pressing the **ENTER** key.

The R&S FSL will measure the carrier power. This is not visible on the screen.
13. Turn off the test transmitter or remove the cable when prompted and confirm by pressing the **ENTER** key.

The R&S FSL will measure the noise sweeping with a small resolution filter in the span specified in the **C/N Setup** dialog box.
14. Press the **MKR** key and, using the rotary knob, move the marker to the frequency you want to measure the noise at. The noise density at this marker is measured and translated to the reference noise bandwidth you specified in step 10.

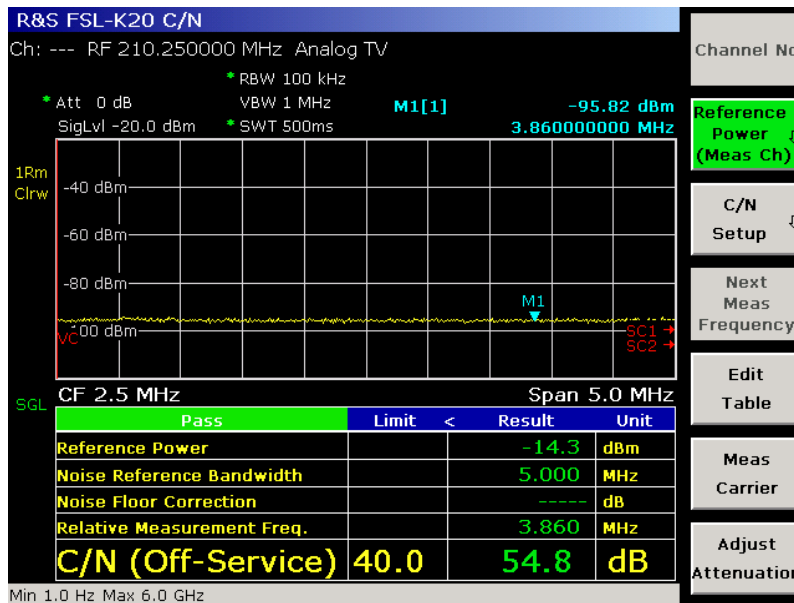

Fig. 2-38 C/N Off-Service measurement

The lower pane shows the final C/N ratio and whether it is passed or failed. It also shows the most important correction factors used to calculate the C/N ratio. The **Off-Service** mode is the most accurate way to measure C/N, but you must turn off the active channel.

C/N In-Service measurement

Test setup:

Refer to the section [Analog TV test setup](#).

Procedure:

1. Press the **SWEEP** key.
2. Press the **Single Sweep** softkey.
3. Press the **FREQ** key.
4. Enter *210.25 MHz* for the vision carrier frequency of the input signal.
5. Press the **MEAS** key.
6. Press the **Analog TV** softkey.
7. Press the **C/N** softkey.
8. To change the limits, press the **Edit Table** softkey.
9. To adjust the input attenuator, press the **Adjust Attenuation** softkey.
10. Press the **C/N Setup** softkey to open the **C/N Setup** dialog box.
 - Make sure, that **In-Service** is chosen as measurement mode.
 - Set the **Reference Noise Bandwidth** to *5 MHz* (or another value).
 - Specify the span for the noise measurement: Change the **CF** value, which denotes the middle of the span relative to the vision carrier and the **Span** value in this table. Chose the value CF in a way, that the span is centered on the gap between 2 analog TV signals. The default value of *-1.25 MHz* should be suitable in most cases.

- If desired, activate the **Noise Floor Correction** option.
- 11. Press the **RUN** key.
 The R&S FSL will first measure the carrier power. This is not visible on the screen. In contrast to the **Off-Service** mode, the R&S FSL will *not* ask you to turn off the signal in the measurement channel. The noise spectrum is measured in the gap between two active channels. The R&S FSL measures the noise by sweeping with a small resolution filter in the span you defined in step 10.
- 12. A marker was automatically set by the R&S FSL. To move this marker, press the **MKR** key and turn the rotary knob. The noise density at this marker is measured and translated to the reference noise bandwidth you specified in step 10.

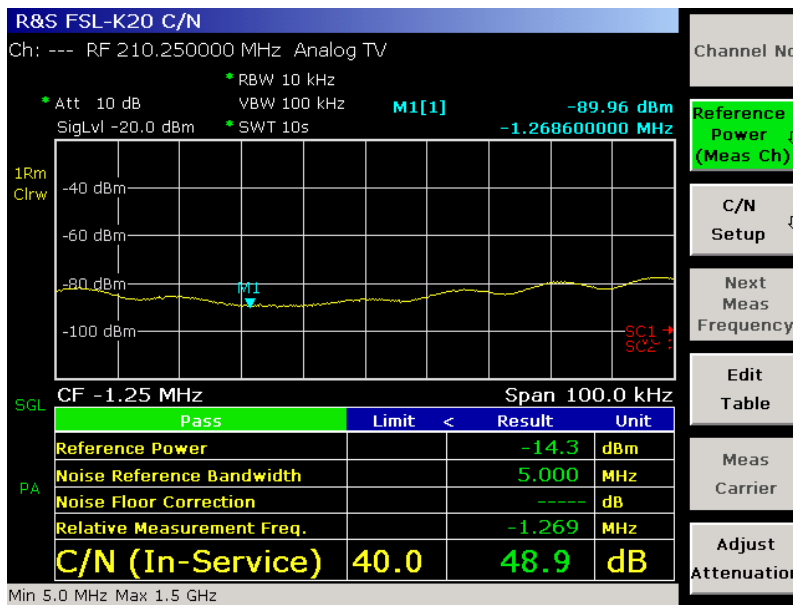

Fig. 2-39 C/N In-Service measurement

The lower pane shows the final C/N ratio and whether it is passed or failed. It also shows the most important correction factors used to calculate the C/N ratio.

In **In-Service** mode the noise reading will be higher and therefore the C/N ratio lower and not as accurate as in **Off-Service** mode, due to the active channels. The resulting C/N ratio is just an upper bound of the real value: If your network passes this quick measurement, it should also pass the more accurate Off-Service-measurement.

C/N Quiet Line measurement

Test setup:

Refer to the section [Analog TV test setup](#).

Procedure:

1. Press the **SWEEP** key.
2. Press the **Single Sweep** softkey.
3. Press the **FREQ** key.
4. Enter *210.25 MHz* for the vision carrier frequency of the input signal.
5. Press the **MEAS** key.

6. Press the **Analog TV** softkey.
7. Press the **C/N** softkey.
8. To change the limits, press the **Edit Table** softkey.
9. To adjust the input attenuator, press the **Adjust Attenuation** softkey.
10. Press the **C/N Setup** softkey to open the **C/N Setup** dialog box.
 - Make sure, that **Quiet Line** is chosen as measurement mode.
 - Set the **Reference Noise Bandwidth** to 5 MHz (or another value).
 - If desired, activate the **Noise Floor Correction** option.
11. Press the **RUN** key.

The R&S FSL will first measures the carrier power. This is not visible on the screen. In contrast to the **Off-Service** mode, the R&S FSL will *not* ask you to turn off the signal in the measurement channel. The noise spectrum is measured by a gated FFT.



The active modulation standard contains a **Quiet Line** parameter. It tells, in which video line the vision carrier is not modulated. Be sure to set this parameter correctly (for details refer to [Modulation standards](#))! The R&S FSL captures IQ data during this line and calculates an FFT. The result is shown in the upper pane as noise measurement trace.

You do not have to choose the noise measurement frequency by moving a marker like in the **Off-Service** mode, instead the R&S FSL automatically calculates the mean noise power. Measurement values close to any typical CSO beat frequency are omitted in this process (vision carrier and vision carrier $\pm n \cdot 0.25$ MHz).

This automatically calculated average noise level is translated to the reference noise bandwidth you specified in step 10.

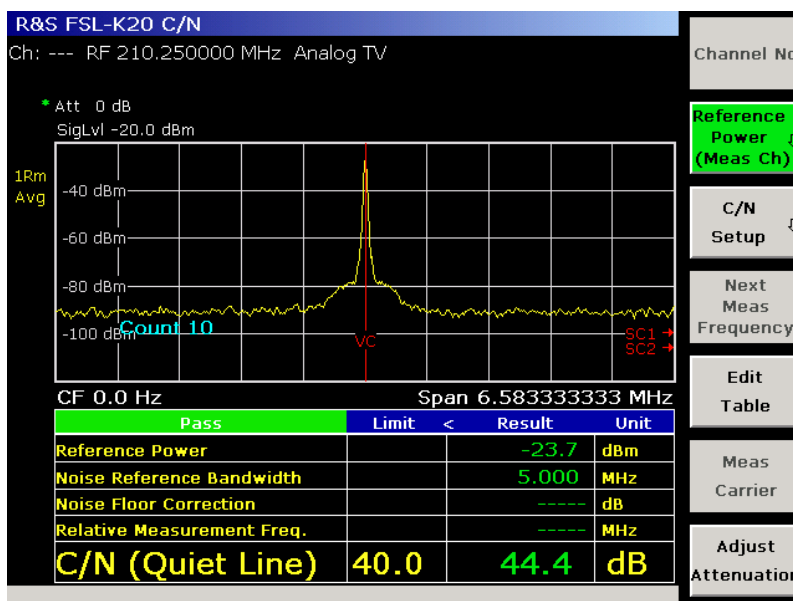

Fig. 2-40 C/N Quiet Line measurement

The lower pane shows the final C/N ratio and whether it is passed or failed. It also shows the most important correction factors used to calculate the C/N ratio.

In **Quiet Line** mode the noise reading will be not as accurate as in **Off-Service** mode, due to the still active channel. But you don't have to turn off channels for a quick check.

CSO measurement

This measurement determines the ratio of signal power and the level of second order beats.

The signal power is normally the peak power of the modulated vision carrier, which is the power of the unmodulated vision carrier. You can modify this default setting with the softkey **Reference Power** (for details refer to chapter 4, section "Cable TV Measurements (Option K20)").

The measurement can be performed in 2 different ways, as shown in the following examples:

- [CSO Off-Service measurement](#)
- [CSO Quiet Line measurement](#)

The measurement display is split into two panes. The upper pane displays the spectrum of the measured beats. The lower pane displays the result table for the measurement and whether the limits are passed or failed.

CSO Off-Service measurement

Test setup:

Refer to the section [Analog TV test setup](#).

Procedure:

1. Press the **SWEEP** key.
2. Press the **Single Sweep** softkey.
3. Press the **FREQ** key.
4. Enter *210.25 MHz* for the vision carrier frequency of the input signal.
5. Press the **MEAS** key.
6. Press the **Analog TV** softkey.
7. Press the **CSO** softkey.
8. To change the limits, press the **Edit Table** softkey.
9. To adjust the input attenuator, press the **Adjust Attenuation** softkey.
10. Press the **CSO Setup** softkey to open the **CSO Setup** dialog box.
 - Make sure, that **Off-Service** is chosen as measurement mode.
 - Specify one or multiple spans for the beat measurements, as shown in the figure below. Change the **CF** value, which denotes the middle of the span relative to the vision carrier and the **Span** value in this table. The measurement ranges should be centered around frequencies where you expect second order beats in your network.

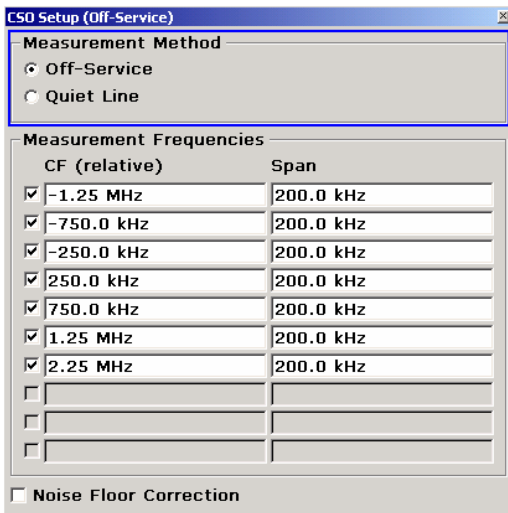

– If desired, activate the **Noise Floor Correction** option.

11. Press the **RUN** key.

12. Turn on the signal when prompted and confirm by pressing the **ENTER** key.

The R&S FSL will measure the carrier power. This is not visible on the screen.

13. Turn off the test transmitter or remove the cable when prompted and confirm by pressing the **ENTER** key.

The R&S FSL will measure the beats by sweeping with a small resolution filter in the span specified in the **CSO Setup** dialog box.

14. A marker is automatically set. Press the **MKR** key and, using the rotary knob, move the marker to the frequency you want to measure the beats at. You should take care not to measure a CTB beat instead of a CSO beat.

15. Activate all possible second order beat frequencies by pressing the **Next Meas Frequency** softkey and then the **RUN** key. This measures beats in the next span, that is defined in the **CSO Setup** dialog box.

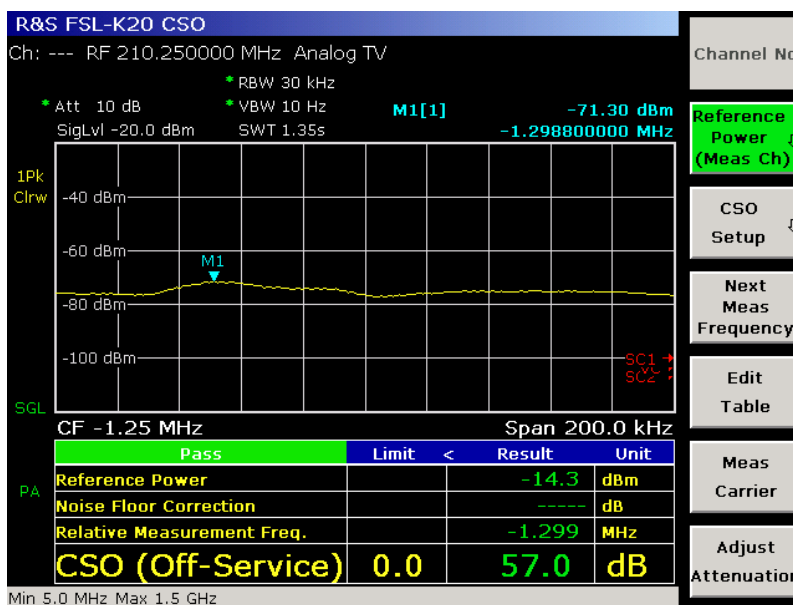

Fig. 2-41 CSO Off-Service measurement

The lower pane shows the final C/N ratio and whether it is passed or failed. It also shows the most important correction factors used to calculate the CSO ratio. The **Off-Service** mode is the most accurate way to measure CSO, but you must turn off the active channel.

CSO Quiet Line measurement

Test setup:

Refer to the section [Analog TV test setup](#).

Procedure:

1. Press the **SWEEP** key.
2. Press the **Single Sweep** softkey.
3. Press the **FREQ** key.
4. Enter *210.25 MHz* for the vision carrier frequency of the input signal.
5. Press the **MEAS** key.
6. Press the **Analog TV** softkey.
7. Press the **CSO** softkey.
8. To change the limits, press the **Edit Table** softkey.
9. To adjust the input attenuator, press the **Adjust Attenuation** softkey.
10. Press the **CSO Setup** softkey to open the **CSO Setup** dialog box.
 - Make sure, that **Quiet Line** is chosen as measurement mode.
 - If desired, activate the **Noise Floor Correction** option.
11. Press the **RUN** key.

The R&S FSL will first measure the carrier power. This is not visible on the screen. In contrast to the **Off-Service** mode, the R&S FSL will *not* ask you to turn off the signal in the measurement channel. The spectrum of the noise and beats is measured by a gated FFT.

12. A marker is automatically set. Press the **MKR** key and, using the rotary knob, move the marker to the frequency you want to measure the beat at. You should take care not to measure a CTB beat instead of a CSO beat.



The active modulation standard contains a **Quiet Line** parameter. It tells, in which video line the vision carrier is not modulated. Be sure to set this parameter correctly ([Modulation standards](#))! The R&S FSL captures IQ data during this line and calculates an FFT.

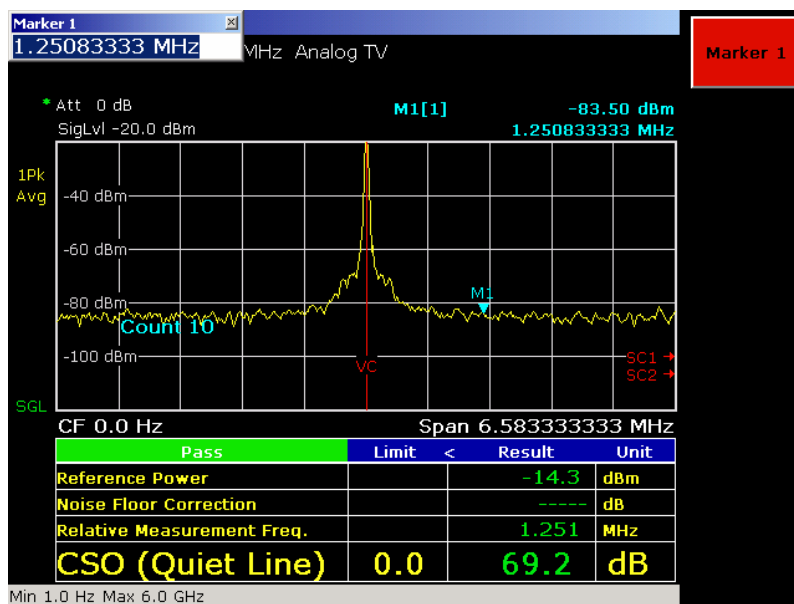

Fig. 2-42 CSO Quiet Line measurement

The lower pane shows the final CSO ratio and whether it is passed or failed. It also shows the most important correction factors used to calculate the CSO ratio.

In **Quiet Line** mode the beat reading will be not as accurate as in **Off-Service** mode, due to the still active channel. But you do not have to turn off channels for a quick check.

CTB measurement

This measurement determines the ratio of signal power and the level of composite triple (order) beats. These beats normally fall onto the vision carrier.

The signal power is normally the peak power of the modulated vision carrier, which is the power of the unmodulated vision carrier. You can modify this default setting with the softkey **Reference Power** (for details refer to chapter 4, section "Cable TV Measurements (Option K20)").

The measurement display is split into two panes. The upper pane displays the spectrum of the measured beats. The lower pane displays the result table for the measurement and whether the limits are passed or failed.

Test setup:

Refer to the section [Analog TV test setup](#).

Procedure:

1. Press the **SWEEP** key.
2. Press the **Single Sweep** softkey.
3. Press the **FREQ** key.
4. Enter *210.25 MHz* for the vision carrier frequency of the input signal.
5. Press the **MEAS** key.
6. Press the **Analog TV** softkey.
7. Press the **CTB** softkey.
8. To change the limits, press the **Edit Table** softkey.

9. To adjust the input attenuator, press the **Adjust Attenuation** softkey.
10. Press the **CTB Setup** softkey to open the **CTB Setup** dialog box.
 - Specify a single span for the beat measurement: Change the **CF** value, which denotes the middle of the span relative to the vision carrier and the **Span** value in the table. The measurement range should be centered around frequencies where you expect triple order beats in your network, i.e. the **CF** value should normally be about *0 Hz*.
 - If desired, activate the **Noise Floor Correction** option.
11. Press the **RUN** key.
12. Turn on the signal when prompted and confirm by pressing the **ENTER** key.

The R&S FSL will measure the carrier power. This is not visible on the screen.
13. Turn off the test transmitter or remove the cable when prompted and confirm by pressing the **ENTER** key.

The R&S FSL will measure the beats in the span specified in the **CTB Setup** dialog box.
14. Using the rotary knob, move the marker to the frequency you want to measure the beat at. The beat level at this marker is measured and used to compute the CTB ratio. You should take care not to measure a CSO beat instead of a CTB beat.

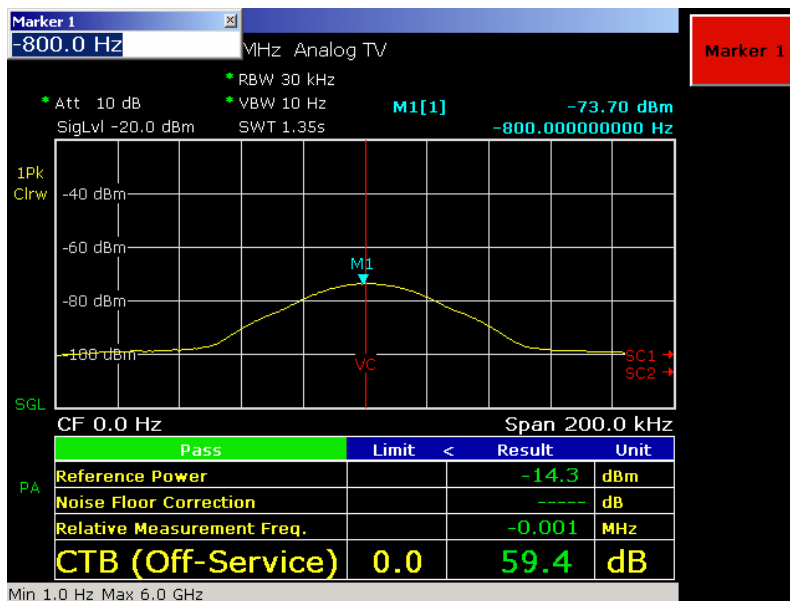

Fig. 2-43 CTB measurement

The lower pane shows the final CTB ratio and whether it is passed or failed. It also shows the most important correction factors used to calculate the CTB ratio.

Digital TV Basics

Cable TV networks use single carrier QAM signals. These signals are continuously modulated. The Cable TV Measurements option does not support burst signals as used in cable modems (e.g. DOCSIS) which rely on TDMA techniques that share the same channel with several subscribers. To get a better understanding, we now want to have a closer look at an ideal QAM transmitter.

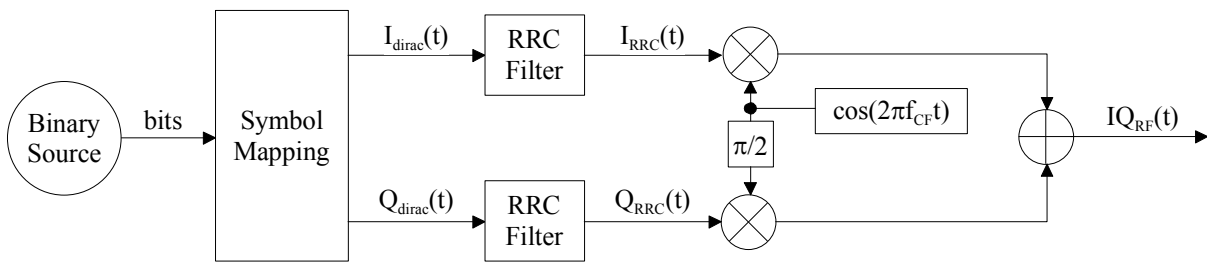

Fig. 2-44 Ideal QAM transmitter

To keep things simple we start with a *binary source* providing a never ending bit stream. Please keep in mind that in reality these bits originate from a video stream which will be source encoded e.g. by a MPEG encoder. To allow errors during the transmission via the cable channel coding (e.g. convolutional coding) will be applied. Finally we get something like "...010010111101010101110110101111010..."

The *symbol mapping* block transforms the digital information (bits) into the continuous signals $I_{dirac}(t)$ and $Q_{dirac}(t)$. $I_{dirac}(t)$ and $Q_{dirac}(t)$ (see Fig. 2-45) consist of dirac pulses that appear at times $t=n \cdot T_{symbol}$ and that can be distinguished by their in-phase "I" and quadrature "Q" levels. For example a 16QAM constellation has 16 different I and Q combinations and 4 different I and Q levels ($4 \cdot 4 = 16$). Typically this is visualized in a constellation diagram (see Fig. 2-46). With $16 = 2^4$ we are able to transmit 4 bits per symbol. Therefore we can calculate:

$$bit_rate = symbol_rate * 4 = 4 / T_{symbol} [bits/second]$$

or more general:

$$bit_rate = symbol_rate * \log_2(M) [bits/second] \text{ for MQAM.}$$

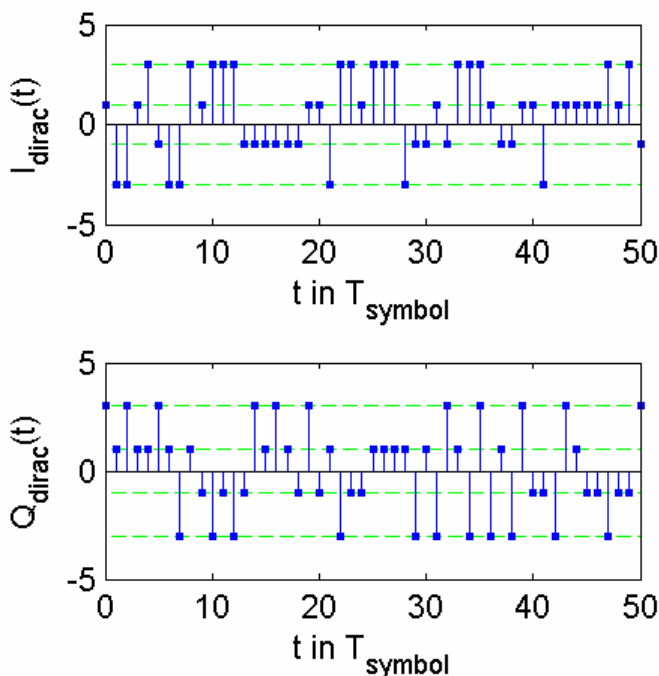

Fig. 2-45 Pulse signals $I_{dirac}(t)$ and $Q_{dirac}(t)$ for 16QAM

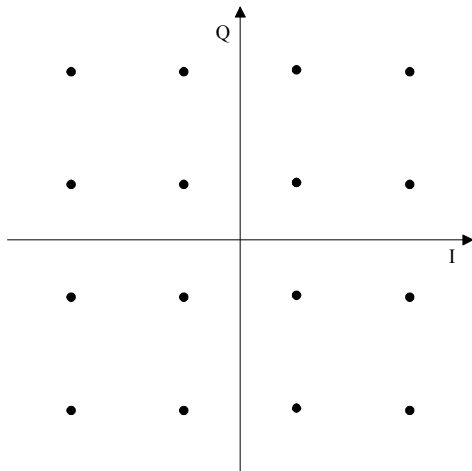

Fig. 2-46 16QAM constellation diagram

Unfortunately the required bandwidth for transmitting dirac pulses is infinite. Let's reduce the bandwidth by applying a so-called pulse shaping filter (as referred to as TX filters). In most QAM systems root raised cosine filters are used. Root raised cosine filters are exclusive supported by the Cable TV Measurements option. Via the filter's roll-off factor the occupied bandwidth can be controlled.

$$OccupiedBandwidth = SymbolRate (1 + RollOff)$$

In a cable TV receiver, a filter of the same shape is used as RX filter. The combination of two root raised cosine filters, one in the transmitter (TX) and another one in the receiver (RX), has a very strong property: There will be no inter-symbol interference at the RX filter's output. Due to this property it is very easy for the receiver to retrieve the transmitted symbols. Please note, that in a real-world scenario the channel (causing echoes / multipath propagation) causes inter-symbol interference. In that case the use of an equalizer is recommendable. Fig. 2-47 shows the signals $I_{RRC}(t)$ and $Q_{RRC}(t)$ that result from filtering $I_{dirac}(t)$ and $Q_{dirac}(t)$ with the root raised cosine filter **RRC**.

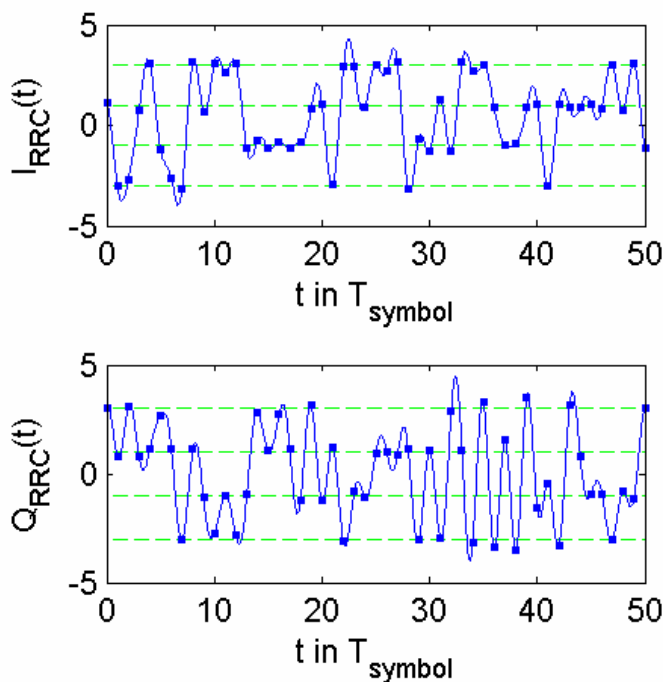

Fig. 2-47 Root raised cosine filtered dirac signals $I_{RRC}(t)$ and $Q_{RRC}(t)$

We notice that the symbol instants (highlighted with squares) are not on the horizontal lines (possible symbol levels) anymore. This is due to the inter-symbol interference introduced by the root raised cosine TX filter. Contrary to the signal filtered with two root raised cosine filters (TX and RX) the one filtered with a single root raised cosine filter (TX) does not satisfy the condition for zero inter-symbol interference. Fig. 2-48 shows the signal obtained by filtering the dirac signals with two root raised cosine filters. The convolution of two root raised cosine filters is also called raised cosine filter and it results in an overall inter-symbol interference free system. We observe that all symbol instants (highlighted with squares) of $I_{RC}(t)$ and $Q_{RC}(t)$ have exactly the same levels as the signals $I_{dirac}(t)$ and $Q_{dirac}(t)$ in Fig. 2-45. Please note that this is only true for the signals $I_{RC}(t)$ and $Q_{RC}(t)$ if there is no noise present in the receiver. In the case of noise points will turn into clouds, that is what can be seen in the Constellation Diagram measurement (modulation analysis).

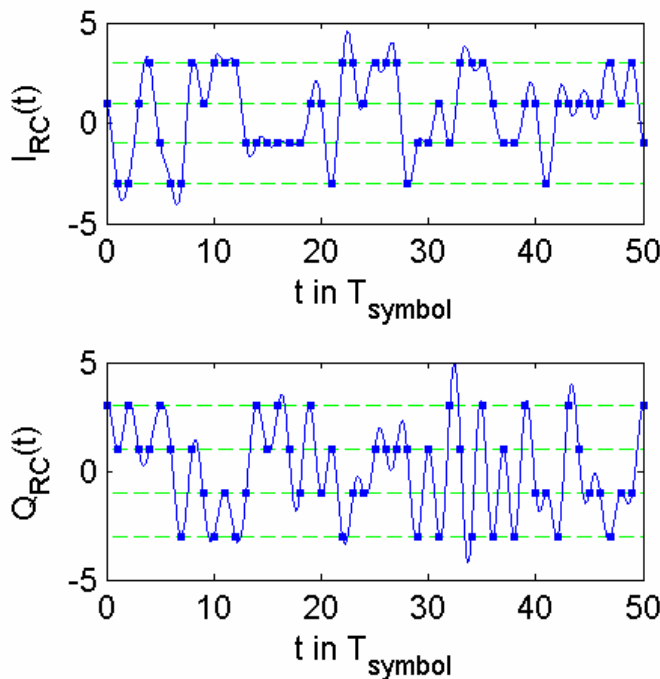

Fig. 2-48 Raised cosine filtered dirac signals $I_{RC}(t)$ and $Q_{RC}(t)$

Let us get back to the ideal transmitter from Fig. 2-44. The next task is to modulate the base band signals $I_{RC}(t)$ and $Q_{RC}(t)$ onto a carrier. The carrier frequency f_{CF} stands for the center of a given TV channel. Fig. 2-49 shows the modulated signal $I_{Q_{RF}}(t)$ with a carrier frequency $f_{CF}=4*\text{symbol_rate}$. Please note that in real system the carrier frequency is much higher than here in our example.

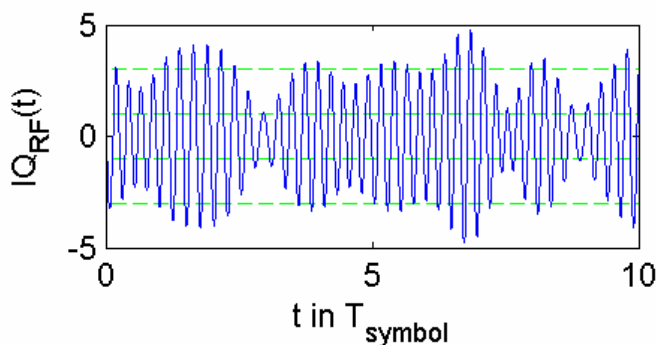

Fig. 2-49 QAM modulated RF signal $I_{Q_{RF}}(t)$

In a real cable TV transmission system however, the receiver would encounter a much worse situation. The measurement signal, i.e. the signal fed into the R&S FSL's RF input, suffers from distortion. Some of it is caused by a non-ideal transmitter, some originates from the TV cable and last but not least there is thermal noise in every transmission system. Very often it is even not possible to find out from which component the distortion comes from. Luckily this can be found out by driving measurements starting at the transmitters location and continuing at different test points in the cable TV network up to the plug at the subscriber's home.

The objective of the digital TV measurements offered by the Cable TV Measurements option is to analyze and separate different sources of distortion and erroneous parameters.

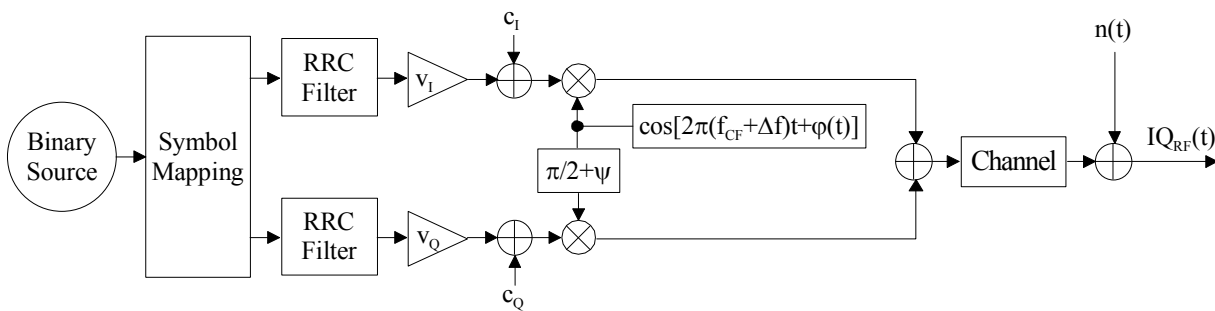

Fig. 2-50 Real-world QAM transmitter and distortion model

Fig. 2-50 shows the transmitter and distortion model assumed by the measurement demodulator of the Cable TV Measurements option. The error parameters and signals are given in the table below.

Table 2-6: Error parameters and signals in a QAM transmission system

Parameter	Ideal Value	Description
v_I, v_Q	$v_I = v_Q$	Gains of I and Q path
c_I, c_Q	$c_I = c_Q = 0$	Carrier leakage in I and Q path
ψ	$\psi = 0$	Quadrature error
Δf	$\Delta f = 0$	Carrier frequency error
$\varphi(t)$	$\varphi(t) = 0$	Phase noise signal
Channel $h(t)$	$h(t) = \delta(t)$	Channel impulse response
$n(t)$	$n(t) = 0$	Thermal noise

Instead of directly displaying the parameters from the table above, derived parameters are displayed in the result table of the [Overview measurement](#) and the [Modulation Errors measurement \(modulation analysis\)](#). To give an example: The ratio between v_I and v_Q represents the gain imbalance which is a more reasonable measure for a transmitter than the absolute values of v_I and v_Q .

The amplitude imbalance can be calculated as follows:

$$amplitude_imbalance = \left(v_I / v_Q - 1 \right) \cdot 100\%$$

Please note that the $2\pi/4$ rad (90 deg) rotational symmetry of the QAM constellation (see [Fig. 2-46](#)) leads to an ambiguity in the calculation of the amplitude imbalance. Ambiguity means that the QAM demodulator of the Cable TV Measurements option has no knowledge of the absolute phase in the transmitter but chooses one out of four possible phase angles (0, $\pi/2$, π , or $3\pi/2$ rad). It can be shown that the phase ambiguity leads to two possible amplitude imbalance values. For the amplitude imbalance the ambiguity can be resolved by using the definition as follows:

$$\text{amplitude_imbalance} = \left(\frac{\max\{V_I, V_Q\}}{\min\{V_I, V_Q\}} - 1 \right) \cdot 100\%$$

In real-world analog IQ modulators there is never perfect carrier suppression. Carrier suppression is modeled by adding the constants c_I and c_Q to the in-phase (I) and quadrature (Q) signal paths respectively. It is calculated with respect to the peak envelope power (PEP).

Quadrature error is the effect that appears if the IQ modulator's cosine and sine waves have not exactly a phase difference of $\pi/2$ rad. The ideal value for the quadrature error thus is 0 rad.

If the transmitter's (DUT) local oscillator does not provide the exact nominal carrier frequency (CF), a carrier frequency error results. The carrier frequency error is displayed in the result table of the [Overview measurement](#).

$$\text{carrier_frequency_error} = f_{CF\ ideal} - f_{CF\ measured}$$

Good local oscillators have low phase noise. Phase noise causes an unwanted phase modulation. The Cable TV Measurements option measures the phase jitter that corresponds to the variance of the phase error. $\varphi(v)$ represents the phase difference between the (noisy) measurement $\text{meas}(v)$ signal and the ideal transmit signal $\text{ref}(v)$. The phase jitter is only evaluated at symbol instants, i.e. for $t = v \cdot T_{\text{symbol}}$

$$\text{phase_jitter} = E \left\{ \left(\angle \left\{ \text{meas}(v) \cdot \text{ref}^*(v) \right\} \right)^2 \right\} = E \left\{ \varphi^2(v) \right\}$$

A non-flat frequency response of the analog hardware (amplifiers) or the transmit channel (reflections or echoes in the TV cable) causes inter-symbol interference (ISI). Too much ISI leads to wrong symbol decisions in the QAM measurement demodulator. The QAM measurement demodulator can suppress the channel's influence by filtering the receive signal with the inverse of the channel's response. This operation is done by the so-called equalizer. With the equalizer activated (see **Digital TV Settings** dialog box in [Fig. 2-51](#)), the EVM and MER values decrease by the ISI which was removed by the equalizer. Activating the equalizer leads to two things: First of all the equalizer is trained based on the received data of the current measurement (**Freeze Equalizer** option deactivated). Furthermore, the measured signal will be filtered / "equalized" with the previously estimated equalizer filter. If the equalizer has reached a stable state and the channel does not change (time invariant channel) the equalizer can be frozen by activating the **Freeze Equalizer** option. By this means the equalizer will not be trained anymore but will still equalize the signal. Please also refer to the [Echo Pattern measurement \(channel analysis\)](#).

The term $n(v)$ is the synonym for any kind of distortion and thermal noise that has not been covered by the transmitter and distortion model of [Fig. 2-50](#) yet. In classical communication theory $n(v)$ is modeled as additive white Gaussian noise (AWGN).

EVM and MER result parameters are calculated based on the error vector signal, which corresponds to the difference between the measurement signal $\text{meas}(v)$ and the ideal transmit signal $\text{ref}(v)$. The error vector signal is only evaluated at symbol instants, i.e. for $t = v \cdot T_{\text{symbol}}$.

To a certain extent the QAM measurement demodulator is insensitive to distortion, but if there is too much of it, erroneous symbol decisions may occur and the results will not be valid anymore. A possibility to check this is to have a look at the constellation diagram. If the clouds around the constellation points are getting much bigger than the (horizontal and vertical) decision borders or if there is even only one single big cloud, this will be a strong indication for a faulty QAM analysis. The QAM measurement demodulator of the Cable Measurements option was designed by taking the transmitter and distortion model from above (see [Fig. 2-50](#)) into account.

Digital TV Measurement Examples

These measurements are set up to carry out single channel measurements of digital TV signals. The settings for digital TV measurements are described in section [Digital TV settings](#). The test setup for the following measurement types is provided in section [Digital TV test setup](#).

The digital TV measurements offered by the Cable TV Measurements option can be divided into two groups:

- spectrum analyzer measurements
- measurements based on the measurement QAM demodulator

Measurements of the first group can also be done in the **Spectrum Analyzer** mode. The advantage of the measurements of the Cable TV Measurements option is that they are automatically parameterized with information according to the channel table and the modulation standards. Measurements of this type are:

- [Spectrum measurement](#)
- [Channel Power measurement](#)
- [APD measurement](#)
- [CCDF measurement](#)

Digital TV measurements that base on output of the QAM measurement demodulator are:

- [Overview measurement](#)
- [Constellation Diagram measurement \(modulation analysis\)](#)
- [Modulation Errors measurement \(modulation analysis\)](#)
- [Echo Pattern measurement \(channel analysis\)](#)

Digital TV settings

The Cable TV Measurements option needs to know some of the parameters described in section [Digital TV Basics](#) to perform correct measurements. It therefore stores these parameters in the so-called "modulation standard". Refer to section [Modulation standards](#) for the creation and usage of a modulation standard. Section [Digital TV modulation standards](#) contains the description of the parameters that have to be characterized for a digital TV signal. The following list explains the meaning of the parameters:

- **Name:** Choose an arbitrary name for the new modulation standard.
- **Signal Type:** If you want to characterize an digital TV signal, select **Digital TV**.
- **TV Standard:** Select a TV standard to initialize the following parameters.
- **Constellation** used in the transmitter, e.g. 64QAM.
- **Symbol Rate** of QAM signal.
- **Roll-Off** factor of root raised cosine TX filter.
- **Sideband Position:** Is the signal in normal position or inverted?



In the dialog boxes, set the parameters always from top to bottom, since all parameters depend on the parameters above them. Otherwise your input might be rejected, e.g. if it specifies an unusual TV standard.

Digital TV test setup

- Perform all measurement examples in the **Cable TV Analyzer** mode.
- Use a digital TV generator as signal source.
- Connect the generator directly to the R&S FSL.
- Set the TV generator to the following parameters:
 - center frequency = 100 MHz
 - single carrier 64QAM modulation.
 - root raised cosine transmit filter with a roll-off factor of 0.15.
 - symbol rate = 6.9 MSymbols/s.

This test setup is used throughout all digital TV measurement examples.

Spectrum measurement

This measurement gives an overview of the active measurement channel. All parameters are set according to the modulation standard, referenced in the channel table or by the default digital TV modulation standard. The spectrum is displayed in a full screen trace.

Test setup:

Refer to the section [Digital TV test setup](#).

Procedure:

1. Press the **FREQ** key and enter *100 MHz* for the center frequency.
2. Press the **MEAS** key.
3. Press the **Digital TV** softkey.
4. Press the **Digital TV Settings** softkey and compare the modulation parameters.

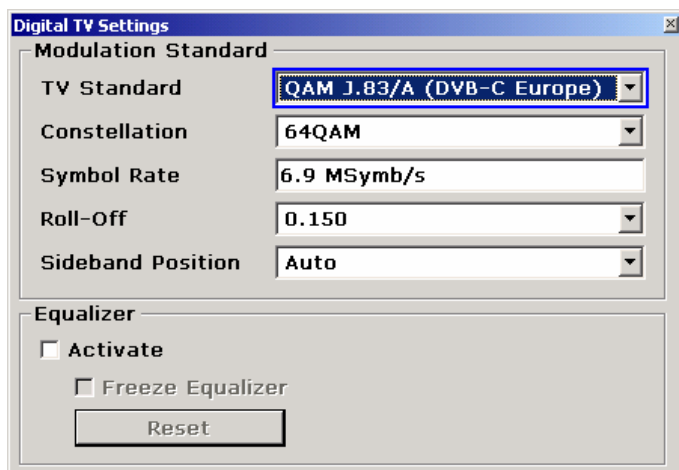

Fig. 2-51 **Digital TV Settings** dialog box

5. Press the **Spectrum** softkey.
6. To adjust the input attenuator, press the **Adjust Attenuation** softkey.
7. Press the **RUN** key.

The spectrum of the input signal is displayed.

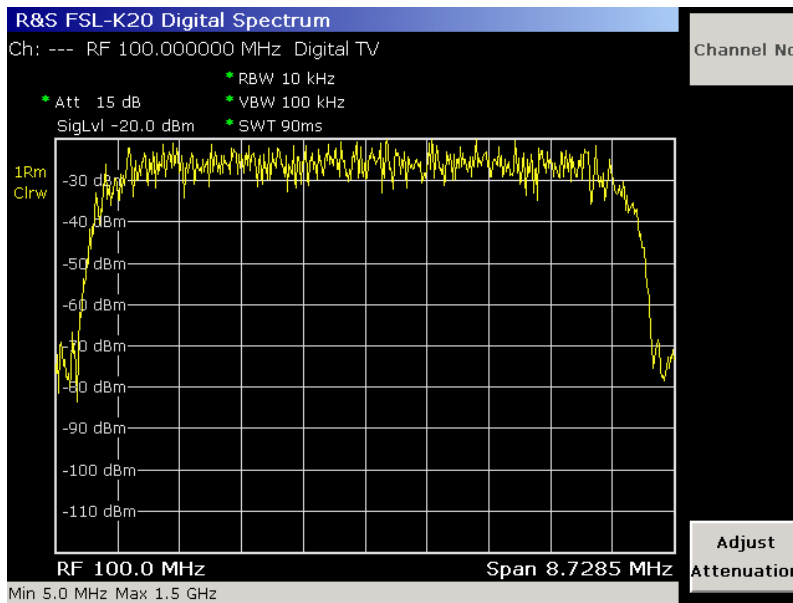

Fig. 2-52 Digital TV Spectrum measurement

Overview measurement

This measurement determines the modulation accuracy of a digitally modulated single carrier QAM signals. The measurement results are checked against the limits and displayed in a table. In this table, only the important result parameters of digital TV signals are displayed. Less important result parameters are provided by the [Modulation Errors measurement \(modulation analysis\)](#).

Result parameters that failed the check are displayed in red and bold characters, the table cell is marked with a star. Result parameters that passed the checks are displayed in green characters. A global pass or fail comment is displayed in the upper left table corner on a green (for passed) or red (for failed) background.

Table 2-7: Result parameters - Overview

Parameter	Description	Definition
MER (rms)	root mean square of modulation error rate	$\sqrt{\frac{1}{N} \sum_{\nu=0}^{N-1} meas(\nu) - ref(\nu) ^2}{E\{ ref(\nu) ^2\}}} \cdot 100 \%$
		$-10 \log_{10} \frac{\frac{1}{N} \sum_{\nu=0}^{N-1} meas(\nu) - ref(\nu) ^2}{E\{ ref(\nu) ^2\}} \text{ dB}$
MER (peak)	peak of modulation error rate	$\sqrt{\frac{\max_{\nu} meas(\nu) - ref(\nu) ^2}{E\{ ref(\nu) ^2\}}} \cdot 100 \%$
		$-10 \log_{10} \frac{\max_{\nu} meas(\nu) - ref(\nu) ^2}{E\{ ref(\nu) ^2\}} \text{ dB}$
EVM (rms)	root mean square of error vector magnitude	$\sqrt{\frac{1}{N} \sum_{\nu=0}^{N-1} meas(\nu) - ref(\nu) ^2}{\max_{\nu} ref(\nu) ^2}} \cdot 100 \%$

Parameter	Description	Definition
		$-10 \log_{10} \frac{\frac{1}{N} \sum_{\nu=0}^{N-1} meas(\nu) - ref(\nu) ^2}{\max_{\nu} ref(\nu) ^2} \quad dB$
EVM (peak)	peak of error vector magnitude	$\sqrt{\frac{\max_{\nu} meas(\nu) - ref(\nu) ^2}{\max_{\nu} ref(\nu) ^2}} \cdot 100 \quad \%$
		$-10 \log_{10} \frac{\max_{\nu} meas(\nu) - ref(\nu) ^2}{\max_{\nu} ref(\nu) ^2} \quad dB$
Carrier Frequency Offset	frequency offset between the received digital TV signal and the frequency setting	
Symbol Rate Offset	frequency offset between the measured symbol rate of the received TV signal and the set symbol rate	

Test setup:

Refer to the section [Digital TV test setup](#).

Procedure:

1. Press the **MEAS** key.
2. Press the **Digital TV** softkey.
3. Press the **Overview** softkey.
4. To magnify one parameter, press the **Zoom** softkey and activate the parameter. To go back to the default setting, activate **None**.
5. To change the limits, press the **Edit Table** softkey.
6. To adjust the input attenuator, press the **Adjust Attenuation** softkey.
7. Press the **RUN** key.

The [Table 2-7](#) lists the result parameters: $meas(\nu)$ is the measured signal and $ref(\nu)$ the ideal transmit signal that is used for comparison; ν means that the continuous signals are sampled at symbol instants $t = \nu \cdot T_{symbol}$. The result of the measurement is shown below.



Fig. 2-53 Digital TV Overview measurement

8. To form the average over a defined number of sweeps:
 - Press the **TRACE** key.
 - Press the **Result Mode** softkey and select the **Average** trace mode.
 - Press the **Sweep Count** softkey and enter the number of sweeps used for averaging.

Every result parameter in the table is averaged by a suitable averaging method over the number of sweeps set.

Constellation Diagram measurement (modulation analysis)

This measurement displays the constellation diagram of the demodulated signal. Amplitude imbalance, quadrature error and carrier leakage (see. [Modulation Errors measurement \(modulation analysis\)](#)) are still present in the used data. The probability of occurrence of points in the complex I/Q plane is represented by different colors. The constellation results are provided only graphically, i.e. reading results via remote control returns only a hardcopy of the display, but not a list of I/Q samples.

Test setup:

Refer to the section [Digital TV test setup](#).

Procedure:

1. Press the **MEAS** key.
2. Press the **Digital TV** softkey.
3. Press the **Modulation Analysis** softkey.
4. Press the **Const Diagram** softkey.
5. To zoom in on one single quadrant, press the **Zoom** softkey and choose the desired quadrant. To go back to the complete constellation, select **None**.
6. To display the constellation diagram unchanged, while the I/Q samples are collected in the background, press the **Freeze** softkey. To switch back to the continual update of the display, press the **Freeze** softkey again.

7. To adjust the input attenuator, press the **Adjust Attenuation** softkey.
8. Press the **RUN** key.

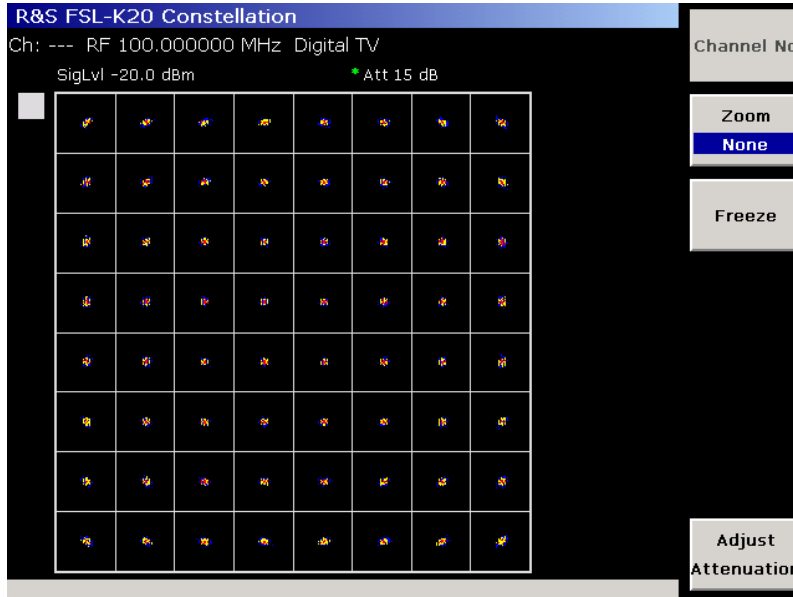

Fig. 2-54 Digital TV constellation measurement

Modulation Errors measurement (modulation analysis)

This measurement determines the modulation accuracy. The measurement results are checked against the limits and displayed in a table. In this table, only the less important result parameters of digital TV signals are displayed (for details see [Table 2-8](#)). The important result parameters are provided by the [Overview](#) measurement.

Result parameters that failed the check are displayed in red and bold characters, the table cell is marked with a star. Result parameters that passed the checks are displayed in green characters. A global pass or fail comment is displayed in the upper left table corner on a green (for passed) or red (for failed) background.

Table 2-8: Result parameters - Modulation Errors

Parameter	Description	Definition
Amplitude Imbalance	Measure for unequal amplitude gains of in-phase and quadrature signal paths of the transmitter's IQ mixer. An ideal IQ mixer results in 0 %.	$\left(\frac{\max\{v_I, v_Q\}}{\min\{v_I, v_Q\}} - 1 \right) \cdot 100\%$ v_I : amplification of in-phase signal path v_Q : amplification of quadrature signal path
Quadrature Error	Phase offset relative to the ideal phase difference (i.e. 90 deg) between the in-phase and quadrature signal paths. An ideal IQ mixer results in 0 deg.	
Carrier Suppression	Suppression of carrier; perfect suppression results in $-\infty$ dB.	
Phase Jitter (rms)	Root mean square of phase jitter in deg. An ideal IQ mixer results in 0 deg.	

Test setup:

Refer to the section [Digital TV test setup](#).

Procedure:

1. Press the **MEAS** key.
2. Press the **Digital TV** softkey.
3. Press the **Modulation Analysis** softkey.
4. Press the **Modulation Errors** softkey.
5. To magnify one parameter, press the **Zoom** softkey and activate the parameter. To go back to the default setting, select **None**.
6. To change the limits, press the **Edit Table** softkey.
7. To adjust the input attenuator, press the **Adjust Attenuation** softkey.
8. Press the **RUN** key.

Pass	Limit	<	Result	<	Limit	Unit
Amplitude Imbalance			0.07		2.00	%
Quadrature Error			0.03		2.00	deg
Carrier Suppression	35.0		49.6			dB
Phase Jitter			0.91		2.00	deg
MER (rms)	24.0		37.1		-----	dB
MER (peak)	10.0		28.3		-----	dB
EVM (rms)	-----		0.91		4.40	%
EVM (peak)	-----		2.53		22.00	%

Fig. 2-55 Digital TV Modulation Errors measurement

9. To form the average over a defined number of sweeps:
 - Press the **TRACE** key.
 - Press the **Result Mode** softkey and select the **Average** trace mode.
 - Press the **Sweep Count** softkey and enter the number of sweeps used for averaging.

Every result parameter in the table is averaged by a suitable averaging method over the number of sweeps set.

Echo Pattern measurement (channel analysis)

This measurement determines the magnitude of the channel impulse response in respect to the corresponding time delay. Damage of TV cables causes unwanted reflections of the TV signal. These reflections lead to echoes in the TV receiver. These echoes can be seen by looking at the echo pattern trace. If the unit of the x-axle is changed into meters or miles (this requires knowledge of the propagation speed of the cable, i.e. the velocity factor) the location of the cable damage can be

measured. This kind of measurement is sometimes referred to as distance-to-fault measurement: as the position of a peak in the echo pattern trace represents the distance between the faulty part of the cable and the location of the R&S FSL.

Test setup:

Refer to the section [Digital TV test setup](#).

Procedure:

1. Press the **MEAS** key.
2. Press the **Digital TV** softkey.
3. Press the **Channel Analysis** softkey.
4. Press the **Echo Pattern** softkey.
5. To change the unit from μs to km or miles:
 - Press the **Velocity Factor** softkey to define the velocity of propagation for the unit conversion.
 - Press the **Unit** softkey to select the unit.
6. To zoom into the echo pattern, press the **Zoom** softkey.
7. To adjust the input attenuator, press the **Adjust Attenuation** softkey.
8. Press the **RUN** key.

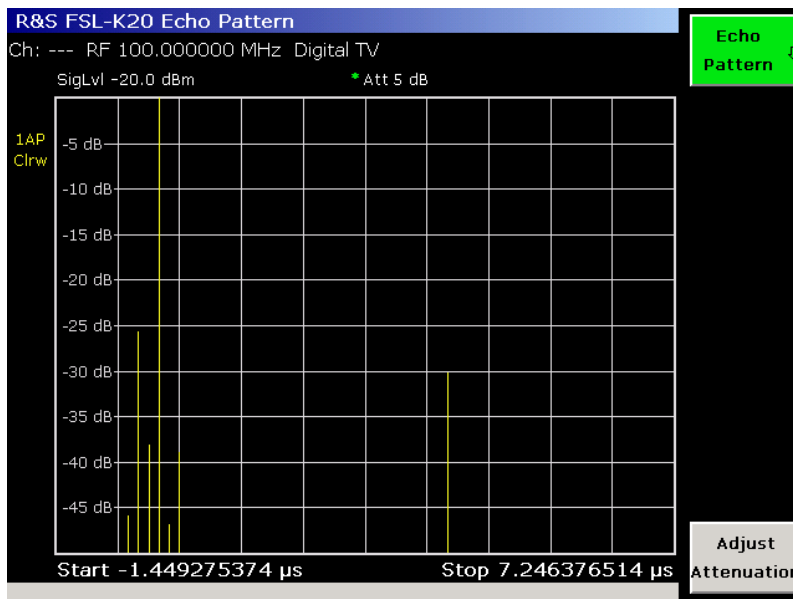

Fig. 2-56 Digital TV Echo Pattern measurement

9. To get correct measurement results the equalizer should be activated. A non-flat frequency response of the cable channel may cause demodulation errors and thus corrupt the measurement results. Inter-symbol interference can be suppressed by the use of the equalizer.

Please note that the Echo Pattern can also be measured with the equalizer switched off. As long as there are only few decision errors in the QAM demodulator this will lead to the same echo pattern.

- Press the **PREVIOUS** key twice to go two menu levels up.
- Press the **Digital TV Settings** softkey (see [Fig. 2-51](#)).

- If the equalizer should get into an instable state (e.g. if the signal was removed), press the **Reset** button.
- If the equalizer was properly trained and the channel does not change anymore, activate the **Freeze Equalizer** option. Freezing the equalizer can speed up all demodulation-based digital TV measurements.
- Close the Digital TV Settings dialog with the **ESC** key.

What is the difference between the equalizer filter and the echo pattern?

The echo pattern is the amplitude of the channel impulse response. The equalizer in contrast estimates the inverse of the channel response which is required to remove the channel's influence from the measurement signal.

Channel Power measurement

This measurement determines the channel power of a digital TV channel.

For details on the applied measurement modes refer to section [Measuring Channel Power and Adjacent Channel Power](#).

The measurement is setup automatically with data relating to the modulation standard.

The measurement display is split into two panes. In the upper pane, the spectrum trace is displayed. In the lower pane, the result table for the measurement is displayed.

Test setup:

Refer to the section [Digital TV test setup](#).

Procedure:

1. Press the **MEAS** key.
2. Press the **Digital TV** softkey.
3. Press the **More** softkey.
4. Press the **Channel Power** softkey.
5. To change the limits, press the **Edit Table** softkey.
6. To adjust the input attenuator, press the **Adjust Attenuation** softkey.
7. Press the **RUN** key.

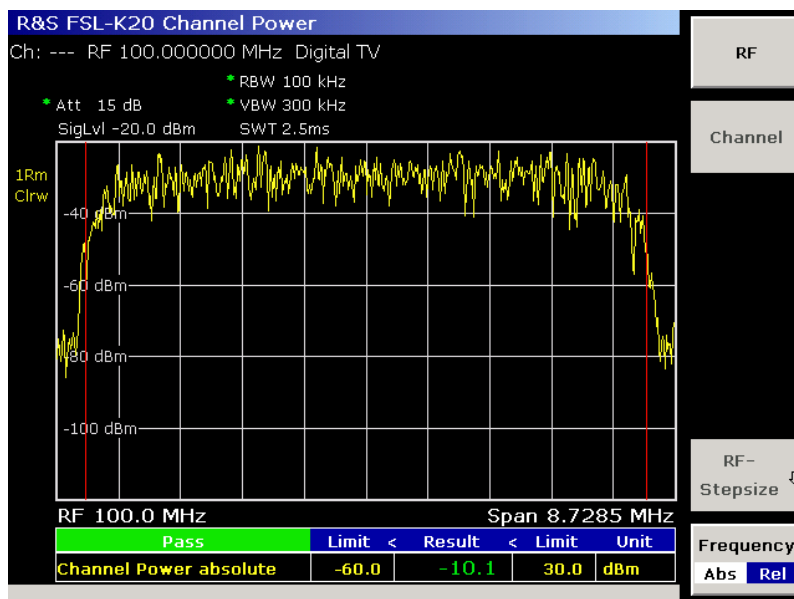

Fig. 2-57 Digital TV Channel Power measurement

APD measurement

This measurement determines the amplitude probability density function (APD). The measurement can also be performed in **Spectrum Analyzer** mode, but in the **Cable TV Analyzer** mode most of the parameters are set automatically. For details on the background refer to section [Amplitude Distribution Measurements](#).

Test setup:

Refer to the section [Digital TV test setup](#).

Procedure:

1. Press the **MEAS** key.
2. Press the **Digital TV** softkey.
3. Press the **More** softkey.
4. Press the **APD** softkey.
5. To change the scaling parameters of the x- and y-axis:
 - Press the **Scaling** softkey.
 - Press the corresponding softkey to change the parameters: x-Axis Signal Level, x-Axis Range, y-Axis Max. Value, y-Axis Min. Value, Default Settings.
6. To adjust the input attenuator, press the **Adjust Attenuation** softkey.
7. Press the **RUN** key.

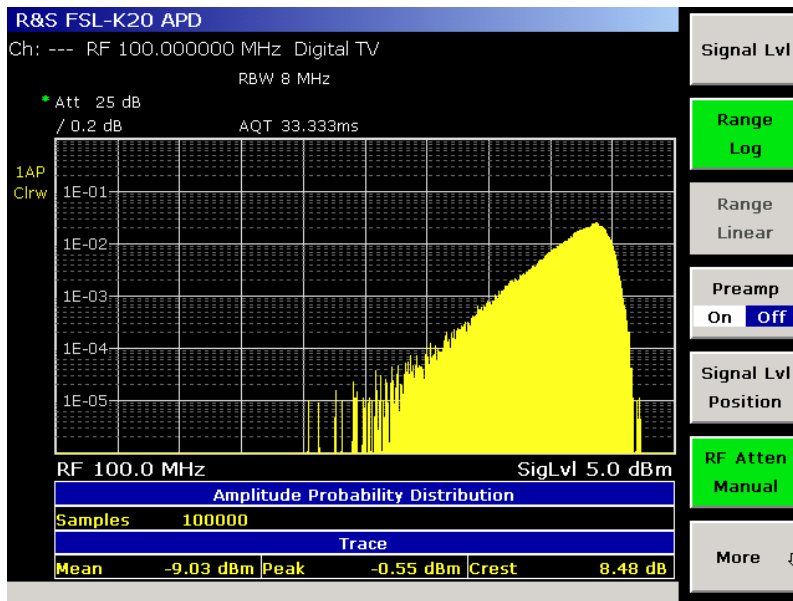

Fig. 2-58 Digital TV APD measurement

CCDF measurement

This measurement determines the complementary cumulative distribution function (CCDF) of the complex base band signal. The measurement can also be performed in **Spectrum Analyzer** mode, but in the **Cable TV Analyzer** mode most of the parameters are set automatically. For details on the measurement background refer to chapter section [Amplitude Distribution Measurements](#).

Test setup:

Refer to the section [Digital TV test setup](#).

Procedure:

1. Press the **MEAS** key.
2. Press the **Digital TV** softkey.
3. Press the **More** softkey.
4. Press the **CCDF** softkey.
5. To determine the power exceeded with a given probability, press the **Percent Marker** softkey.
6. To change the scaling parameters of the x- and y-axis:
 - Press the **Scaling** softkey.
 - Press the corresponding softkey to change the parameters: x-Axis Signal Level, x-Axis Range, y-Axis Max. Value, y-Axis Min. Value, Default Settings.
7. To adjust the input attenuator, press the **Adjust Attenuation** softkey.
8. Press the **RUN** key.

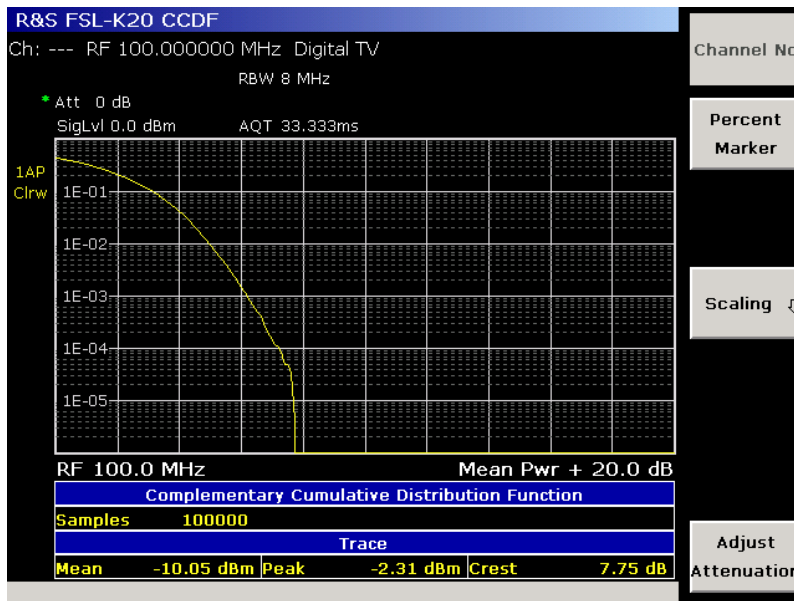

Fig. 2-59 Digital TV CCDF measurement

TV Analyzer Measurements

The measurement here is set up to carry out multiple channel measurements of TV networks. The measurement provides a fast, automatic change of the measurement channel in order to support a quick succession of measurements.

The following measurement type is provided:

- [Tilt measurement](#)

Tilt measurement

This measurement can determine the amplitude response of the CATV network by measuring the channel power of every channel. Both analog and digital TV channels can be measured. The setup configuration allows to limit the frequency range or to choose particular modulation standards in order to measure only a channel subset of the TV network.

The channel levels are measured in a series of zero-span measurements. Each channel is measured using the information stored in the channel table (modulation standard). Therefore the use of a channel table is mandatory. Channels with the modulation standard **< unused >** are not measured (for details on modulation standards refer to chapter "Instrument Functions", section "Cable TV Measurements Option (K20)". Depending on the set modulation standard one of the following measurements is used internally by the firmware:

- analog TV: [Carriers measurement](#)
- digital TV: [Channel Power measurement](#)

The measurement result is displayed in form of a bar graph. The colors of the bars indicate the signal type of the modulation standard.

Test setup:

- Connect the R&S FSL to your CATV network.

It is not possible to work without a channel table. You cannot even enter the TV Analyzer sub menu, if you have not activated a channel table before. Create a channel table according to your CATV network

(or a subset of your network). This task is described in section [Example: Creating a channel table](#). If you do not want to create your own channel table, you can use the example channel table from section [Example: Creating a channel table](#), which is delivered with the Cable TV Measurements option.

Procedure:

1. Press the **MENU** key.
2. Press the **Channel Setup** softkey.
3. Select the appropriate channel table and activate it by pressing the **Activate** softkey.
4. Press the **MEAS** key.
5. Press the **TV Analyzer** softkey.
6. Press the **Tilt** softkey.
7. To restrict the channels to be measured, press the **Tilt Setup** softkey:
The **Tilt Setup** dialog box is displayed.
 - To limit the frequency range, under **Span**, enter a start and stop frequency. Be sure that at least one channel's RF frequency is in this range. Otherwise the measurement display will be empty!
 - To select certain modulation standards for the measurement, under **Modulation Standards**, activate the modulation standards to be included in the measurement.
8. To adjust the range of the y-axis, if logarithmic, press the **Auto Range** softkey.
9. Press the **RUN** key.
10. Observe the exact levels of different channels by turning the rotary knob.
11. Check your network:
 - Do all signals of the same type (e.g. all analog TV signals) have similar levels?
You can do this by selecting the modulation standards to measure before the measurement. Or you can measure all kinds of signals and distinguish different modulation standards after the measurement by their different colors.
 - You can measure the amplitude response of the network (or of an amplifier) by looking at the levels of signals at different frequencies. Prerequisite is either that you measure before and after the amplifier and compare the results. Or that you know, that the levels are equal at the transmitter.

Channel Tables and Modulation Standards

Measurements with the Cable TV Measurements option can be speeded up significantly if a channel table is used. First of all a channel table, sometimes also referred as channel plan, contains the frequency plan of a cable TV network. Furthermore, for every channel it contains the information about the service broadcast or the information that the channel is **< unused >**.

Typically every country has its own regulations concerning the frequency plan, i.e. the channel locations and the channel widths. Unfortunately the services or programs assigned to this frequency plan differ from one CATV network to another. For example the CATV network of the city of Munich offers different programs than Erding which is only about 40 kilometers away. Therefore the Cable TV Measurements option provides empty channel tables for most countries in the world, where empty means, that all channels are marked as **< unused >**. However, it is not possible to do measurements without any precise information about the services. Therefore the Cable TV Measurements option introduces the concept of the so-called modulation standard.

Modulation standards describe the signal characteristics, or physical layer, transmitted via a channel. The Cable TV Measurements option supports modulation standards that characterize analog TV signals

(e.g. NTSC, SECAM, PAL) or digital TV signals (single carrier QAM as for example in DVB-C). Every channel table can comprise several modulation standards. Once defined, every channel can reference one of these modulation standards. Provided that at least one channel references a modulation standard, measurements based on a channel table can easily be done.

You can create numerous channel tables (e.g. for different locations in the network / different measurement tasks) and save them on the R&S FSL. But there can always be only one channel table active at a time. Working without a channel table is realized by activating the special, pseudo channel table called **< none >**.

Normally, the easiest way is not to create a channel table from the scratch, but to load pre-defined channel tables delivered with the Cable TV Measurements option. They already hold the typical frequency plans for many countries. You only have to fill in the modulation standards.

For detailed information on channel tables refer to section [Channel tables](#), for modulation standards refer to section [Modulation standards](#). A detailed example is provided in section [Example: Creating a channel table](#). [Fig. 2-60](#) gives an example of a channel table that references the modulation standard "PAL_BG_STEREO". [Fig. 2-62](#) shows that modulation standard.

Channel tables

This section gives a detailed description of channel tables and their properties.

- Channel tables (see [Fig. 2-60](#)) have a **Name**. The name should comprise geographical information, e.g. "SOUTHAMPTON" or "EXAMPLE_WIPFING".
- If desired, a **Description** giving further information on the channel table can be entered.
- Channel tables consist of **Channels**. The Cable TV Measurements option displays one channel per line. A channel table must contain at least one channel.

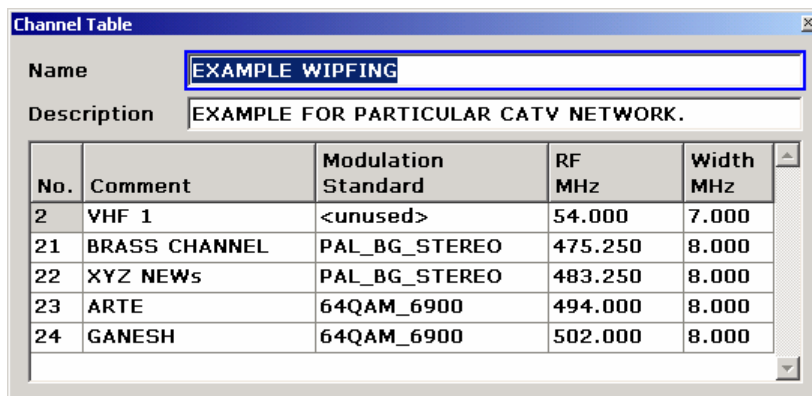

No.	Comment	Modulation Standard	RF MHz	Width MHz
2	VHF 1	<unused>	54.000	7.000
21	BRASS CHANNEL	PAL_BG_STEREO	475.250	8.000
22	XYZ NEWS	PAL_BG_STEREO	483.250	8.000
23	ARTE	64QAM_6900	494.000	8.000
24	GANESH	64QAM_6900	502.000	8.000

Fig. 2-60 The channel table and its properties

Every channel has the following properties:

- The unique channel number **No.** can be used within measurements to change over from one channel to another quickly.
- A **Comment** can be specified, e.g. the name of the program or the frequency band.
- A **Modulation Standard** is referenced. In case of an empty channel, the modulation standard is set to **< unused >**. Be aware that modulation standards have to be created before making use of them. For details refer to section [Create modulation standards](#) Note, that in order to perform channel table based measurements, there must be at least one channel, that references a modulation standard. It is not possible to do any measurements, if in all channels the modulation standard equals **< unused >**.

- The **RF** frequency represents the characteristic frequency of a channel. For analog TV channels RF is equal to the vision carrier frequency. For digital TV channels and **< unused >** channels it equals the center frequency.
- **Width** stands for the channel's bandwidth.

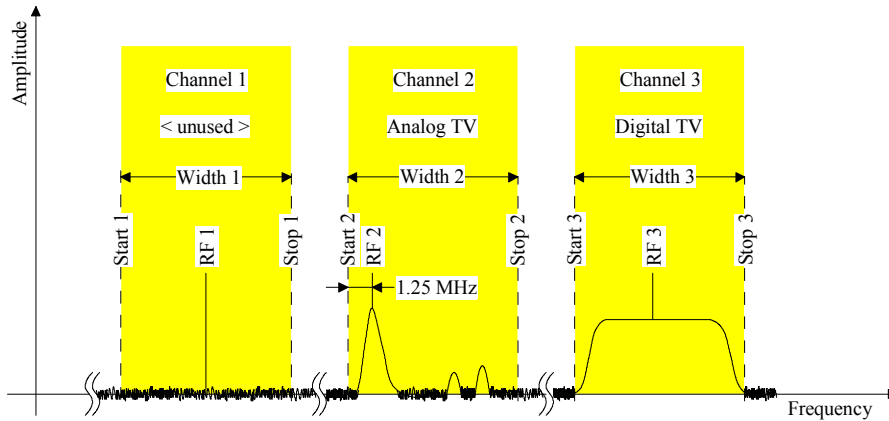

Fig. 2-61 Channel start and stop frequencies versus RF frequency and channel width

Except for **< unused >** channels the calculation of the start and stop frequencies depends on the signal type property (digital or analog TV) of the referenced modulation standard. All corresponding formulae are listed in the table below.

Table 2-9: Channel start and stop frequencies versus RF frequency and channel width

Signal type	Analog TV	Digital TV	< unused >
RF frequency	Start + 1.25 MHz	Start + (Stop - Start) / 2	
Channel Width	Stop - Start		
Start frequency	RF - 1.25 MHz	RF - Width/2	
Stop frequency	Start + Width		



The Cable TV Measurements option automatically adapts the RF frequency if the user changes the modulation standard of a channel (e.g. from an analog to digital modulation standard). This is done in order to keep the channels start and stop frequencies constant.

Modulation standards

All over the world many different transmission standards for TV signals exist. As a guide through the jungle of parameters that describe TV signals (including video and sound sub-signals) the concept of the modulation standard has been introduced.

Most important when dealing with modulation standards is the order of the parameters. Modulation standards (see Fig. 2-62) have always to be created and edited from top to bottom of the **Modulation Standard Options** dialog box. The most important parameters are located at the top of the dialog box. For example, changing the signal type from **Analog TV** to **Digital TV** also alters the complete set of parameters below. Whereas the modulation technique for transmitting the color information is essential

in analog TV systems (see **Color System** in Fig. 2-62), it does not exist for digital TV systems. The constellation instead is crucial in digital TV systems (see Fig. 2-63). For that reason the Cable TV Measurements option automatically guides you through the whole process of creating a new modulation standard and only confronts you with mandatory parameters.

A modulation standard is structured as follows:

- The **Name** is arbitrary, but should refer to the main properties of the TV signal, e.g. "PAL_BG_STEREO".
- The **Signal Type** specifies whether the signal is an analog TV or a digital TV signal.

As mentioned above, all described parameters below depend on the chosen signal type. Therefore the remaining parameters will be discussed separately in the sequel.

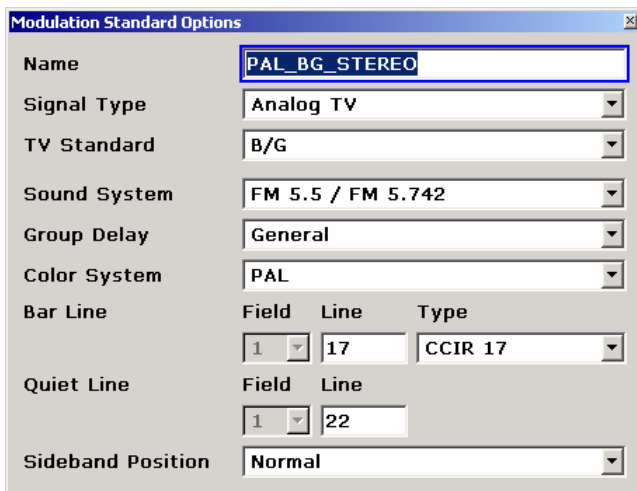

Fig. 2-62 **Modulation Standard Options** dialog box for analog TV

Analog TV modulation standards

This section describes the parameters that characterize analog cable TV signals. Refer to section [Analog TV Basics](#) to learn more about analog cable TV signals. The parameters discussed here can also be modified (temporarily) in the **Analog TV Settings** dialog box.

For analog TV the **Modulations Standard Options** dialog box (see Fig. 2-62) is structured as follows:

- The channel table references modulation standards by their **Name**. Its name (see Fig. 2-63) should comprise information about the used TV standard, the color system and the sound system, e.g. "PAL_BG_STEREO".
- Here the **Signal Type** is always set to **Analog TV**.
- The **TV Standard** characterizes the way the luminance information is modulated. The following analog TV standards exist:
 - B/G
 - D/K
 - I
 - K1
 - L
 - M
 - N

- The **Sound System** parameter specifies how the audio will be transmitted. The possible values depend on the TV Standard selected in the **TV Standard** list. The sound systems are named in the form "sound carrier 1 / sound carrier 2", e.g. "FM 6.5 / FM 6.258". Information about the sound modulation format and the carrier frequency with respect to the vision carrier is included.

Table 2-10: Possible values for the sound systems

TV Standard	Sound System
B/G	FM 5.5 / NICAM 5.85
	FM 5.5 / FM 5.742
	FM 5.5 MONO
D/K K1	FM 6.5 / NICAM 5.85
	FM 6.5 / FM 6.258
	FM 6.5 / FM 6.742
	FM 6.5 MONO
I	FM 6.0 / NICAM 6.552
	FM 6.0 MONO
L	AM 6.5 / NICAM 5.85
	AM 6.5 MONO
M N	FM 4.5 BTSC
	FM 4.5 EIA-J
	FM 4.5 / FM 4.724
	FM 4.5 MONO

- What **Group Delay** shall the residual sideband filter have? The Group Delay setting has no effect on the measurements in this firmware release.
- The **Color System** parameter specifies how color information will be transmitted. The possible values depend on the TV Standard selected in the **TV Standard** list.

Table 2-11: Possible values for the Color Systems

TV Standard	Color System
B/G	PAL
D/K	SECAM
I N	PAL
K1 L	SECAM
M	NTSC
	PAL

- **Bar Line:** The Vision Modulation measurement needs a special test signal, containing a peak white value. You must specify the type and the number of the horizontal line that contains the peak white value.
- **Quiet Line:** Some measurements need a horizontal line with no video information in it. You must specify the number of this horizontal line here. For further information see also [Example: Creating a channel table](#).
- **Sideband Position:** Is the signal in normal position or inverted?

Sometimes the analog TV signal to be analyzed is only available with an inverted sideband. This can for example happen if the cable operator feeds - for some reason - an inverted signal into the network. It may also happen in R&D labs where measurements on different IF stages of a new TV

transmitter or a receiver hardware are to be performed. Please be aware, that these two applications also lead to two different cases when measuring with the Cable TV Measurements option:

- Measurements with channel tables
- Measurements without a channel table, i.e. < none >.

The sideband position can either be altered in the modulation standard or in the **Analog TV settings** dialog box. When measuring with a channel table, switching the sideband position (from normal to inverse or vice versa) keeps the channel's start and stop frequencies constant. As a consequence the RF frequency will be modified.

Example:

Channel Information:

RF frequency = 401.25 MHz

Width = 8 MHz

Modulation standard = analog TV with sideband position = normal.

This leads to the following channel borders:

Start frequency = RF - 1.25 MHz = 400 MHz

Stop frequency = Start frequency + Width = 408 MHz.

Next, the sideband position of the referenced modulation standard will be set to inverse. In order to keep the start and stop frequencies constant the RF frequency will be adapted as follows:

RF frequency = Stop frequency - 1.25 MHz = 206.75 MHz.

In case of measurements without a channel table, i.e. < none >, we realize that there are no start and stop frequencies existing. Hence, changing the sideband position keeps the RF frequency constant. As a consequence you will analyze different parts of the spectrum depending on the selected sideband position.

Digital TV modulation standards

In the Cable TV Measurements option, digital TV is used as a synonym for quadrature amplitude modulated (QAM) signals. In digital Cable TV networks exclusively single carrier modulated signals are used. The Cable TV Measurements option does not support multicarrier techniques such as OFDM in terrestrial TV networks.

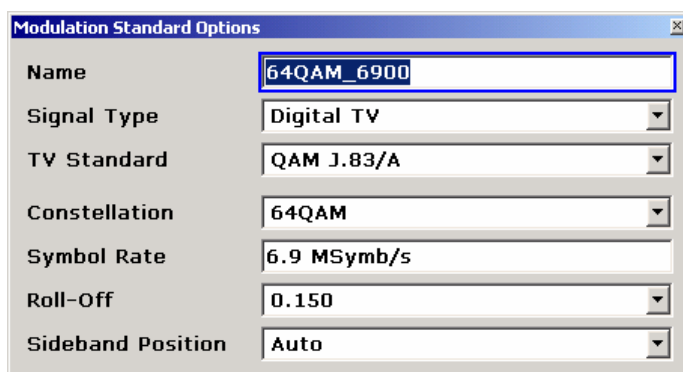

Fig. 2-63 **Modulation Standard Options** dialog box for digital TV

This section describes the parameters that characterize digital cable TV signals. Refer to section [Digital TV Basics](#) to learn more about digital TV signals. The parameters discussed here can also be modified (temporarily) in the **Digital TV Settings** dialog box.

For digital TV the **Modulations Standard Options** dialog box is structured as follows:

- The channel table references modulation standards by their **Name**. Its name (see Fig. 2-63) should comprise information about the used constellation and the symbol rate, e.g. "64QAM_6900".
- Here the **Signal Type** is always set to **Digital TV**.
- Depending on the **TV Standard** the default values of the parameters below are set. The following digital TV standards exist:
 - QAM J.83/A (DVB-C Europe)
 - QAM J.83/B (US Cable)
 - QAM J.83/C (Japanese Cable)
- The **Constellation** parameter supports the values below:
 - 4QAM
 - 16QAM
 - 32QAM
 - 64QAM
 - 128QAM
 - 256QAM
 - 512QAM
 - 1024QAM

Fig. 2-64 shows ideal 16QAM and 32QAM constellation diagrams. 4QAM, 16QAM, 64QAM, 256QAM and 1024QAM have a square structure, whereas 32QAM, 128QAM and 512QAM have a cross structure.

- The **Symbol Rate** and the **Roll-off** factor of the pulse shaping filter determine the occupied bandwidth of the digital TV signal. In the Cable TV Measurements option only root raised cosine filters are supported. The bandwidth can be calculated by the following formula:

$$\text{OccupiedBandwidth} = \text{SymbolRate} (1 + \text{RollOff})$$

The symbol rate can be entered in MHz. For the roll-off factor, the following values are supported:

- 0.120
 - 0.130
 - 0.150
 - 0.180
- The **Sideband Position** parameter can be used to invert the sidebands. The following values are supported:
 - Auto
 - Inverse
 - Normal

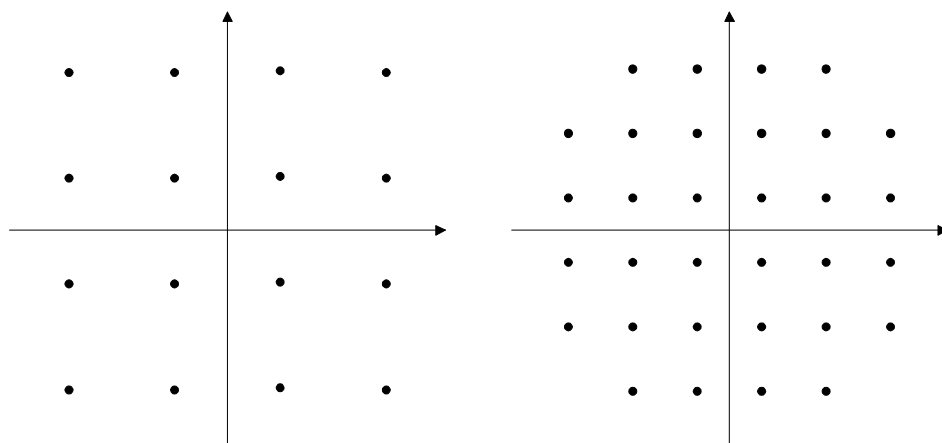

Fig. 2-64 16QAM (square) and 32QAM (cross) constellation diagrams

Example: Creating a channel table

This section gives an exemplary step-by-step instruction for creating a channel table. The basic procedure consists of three steps:

1. [Enter frequency plan](#), i.e. a channel table solely containing < unused > channels.
2. [Create modulation standards](#).
3. [Assign modulation standards to channels](#).

The following sections address these steps.

The channel tables described in this example are delivered with the Cable TV Measurements option. Please note, that contrary to the example here, their names are as follows.

- RS_EXAMPLE_BAVARIA (in example: "EXAMPLE BAVARIA")
- RS_EXAMPLE_WIPFING (in example: "EXAMPLE WIPFING")

Enter frequency plan

Typically every country has its own regulations concerning the frequency plan, i.e. the channel locations and the channel widths. That is what we call a country-specific frequency plan. [Table 2-12](#) shows the frequency plan of "Bavaria". This plan applies to all cable TV networks of Bavaria. Hence, there is no information about the programs included yet, as this information depends on the (local) operator of a particular network. In the first step, we merely want to enter this frequency plan with the Cable TV Measurements option and call this channel table "EXAMPLE BAVARIA".

Table 2-12: Frequency plan example of channel table "EXAMPLE BAVARIA"

Channel No.	Band name	Start frequency in MHz	Width in MHz
2	VHF 1	50.5	7
21	UHF	474	8
22	UHF	482	8
23	UHF	490	8
24	UHF	498	8

1. Press the **MENU** key.
2. Press the **Channel Setup** softkey.
3. Press the **New** softkey to create a new channel table.
4. In the **Name** field, enter *EXAMPLE BAVARIA* as channel table name with the keypad, and press **ESC**.
5. In the **Description** field, enter in the same way *EXAMPLE FOR COUNTRY SPECIFIC FREQUENCY PLAN*.
6. To enter the first channel (line 2 of [Table 2-12](#)):
 - Use the knob or the cursor keys to move to the **No.** column of the existing channel.
 - Enter 2 for the channel number.
 - Enter *VHF 1* as **Comment**.
 - Set the **Modulation Standard** to **< unused >**.
Therefore RF represents the center frequency and can be calculated as
 $RF = \text{Start} + \text{Width} / 2 = 50.5 \text{ MHz} + 7 \text{ MHz} / 2 = 54 \text{ MHz}$.
 - Set the **RF** frequency to *54 MHz*.
 - Set the channel **Width** to *7 MHz*.
7. To enter the second channel (line 3 of [Table 2-12](#)):
 - Move down to focus the last channel.
 - Press the **Copy Channel** softkey to copy the last channel.
 - Move down to the copied channel.
 - Set the channel number **No.** to *21*.
 - Enter *UHF* as **Comment**.
 - Set the **Modulation Standard** to **< unused >**,
i.e. $RF = 474 \text{ MHz} + 8 \text{ MHz} / 2 = 478 \text{ MHz}$.
 - Set the **RF** frequency to *478 MHz*.
 - Set the channel **Width** to *8 MHz*.
8. To enter the remaining channels proceed as in step 7
 - Channel 22: $RF = 486 \text{ MHz}$
 - Channel 23: $RF = 494 \text{ MHz}$
 - Channel 24: $RF = 502 \text{ MHz}$
9. To save your work, press the **Save Changes** softkey.

Having finished the first step, you have build a channel table as shown in [Fig. 2-65](#). Please note, that it is not possible yet, to do any measurements, as all channels are marked as **< unused >**. Nevertheless, you can use the *EXAMPLE BAVARIA* channel table as a base model for all channel tables required all over Bavaria.

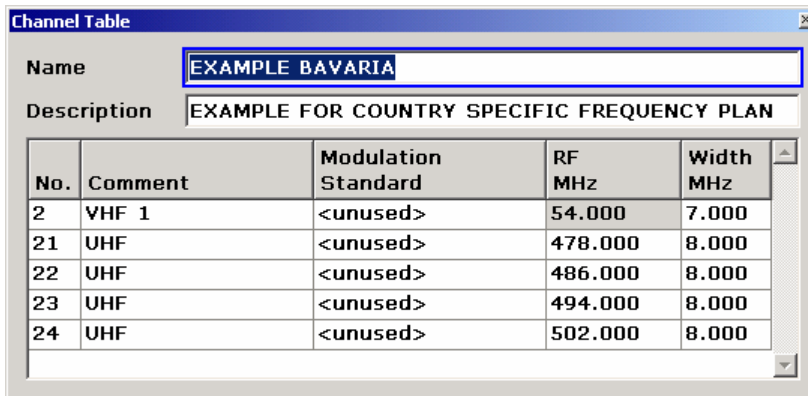

Fig. 2-65 Channel table "EXAMPLE BAVARIA" with entered frequency plan

Create modulation standards

For detailed information on channel tables refer to section [Channel tables](#), for modulation standards refer to section [Modulation standards](#). A worked out example can be found in [Example: Creating a channel table](#).

The second and third steps require knowledge about a particular network. Thus, information about the programs (see [Channel tables](#)) and the possible services (see [Modulation standards](#)) has to be collected. For our example, we retrieved this information from the operator of the small cable TV network of Wipfing, a village in Bavaria. We found out, that there is a traditional TV chain, broadcasting their TV program using analog transmission techniques with stereo sound. The technical details are summarized in [Table 2-13](#). Besides, another TV chain, equipped with state-of-the-art Bavarian broadcast technology, feeds two digital DVB-C programs into Wipfing's cable TV network. The parameters are listed in [Table 2-14](#).

Table 2-13: Analog TV service data for PAL_BG_STEREO modulation standard

Video	PAL B/G
Sound	Stereo: FM 5.5 MHz / FM 5.7421875 MHz
Group delay profile	general
VITS: Bar line	CCIR17, line 17
VITS: Quiet line	line 22
Sideband position	normal

Table 2-14: Digital TV service data for 64QAM_6900 modulation standard

Standard	QAM J.83/A (DVB-C Europe)
Constellation	64QAM
Symbol rate	6.9 MSymbols/s
Roll-off factor of root raised cosine filter	0.15
Sideband position	normal

First of all in the second step, we will copy the EXAMPLE BAVARIA channel table to a new channel table EXAMPLE WIPFING. We do this, because we want to keep the pure frequency plan (as EXAMPLE BAVARIA channel table), and create an additional channel table EXAMPLE WIPFING for our measurements in Wipfing.

1. Press the previous key, to go back to the **Channel Tables** dialog box.
2. Focus the channel table **EXAMPLE BAVARIA** via the knob or cursor keys.

3. Press the **Copy** softkey to copy the **EXAMPLE BAVARIA** channel table.
4. The **Channel Table** dialog box is displayed (see [Fig. 2-65](#)).
5. In the field **Name**, enter *EXAMPLE WIPFING* as channel table name, with the keypad.
6. In the field **Description**, enter in the same way *EXAMPLE FOR PARTICULAR CATV NETWORK*.
7. To save the new channel table, press the **Save Changes** softkey. You will be prompted if any errors are encountered. In that case, please correct all errors. If you followed the steps above everything should be fine.

We will then create the analog modulation standard, which we will call PAL_BG_STEREO and which is based on the information of [Table 2-13](#): We will continue with the channel table EXAMPLE WIPFING from above.

8. Press the **Modulation Options** softkey.
The appearing list of all existing modulation standards is empty right now.
9. In the **Modulation Options** submenu, press the **New** softkey.
The **Modulation Standard Options** dialog box appears (see for example [Fig. 2-66](#)).
10. Enter the parameters for the modulation standard:
 - In the field **Name**, enter *PAL_BG_STEREO* as modulation standard name with the keypad.
 - Select **Analog TV** as **Signal Type** from the list.
This is done, because PAL B/G is an analog TV standard.
 - Select **B/G** as **TV Standard**.
This means that the luminance information of the video signal is transmitted via an AM modulated carrier according to the standard B/G.
 - Select **FM 5.5 / FM 5.742** as **Sound System** from the list.
That means that there are two sound carriers present, one 5.5 MHz and the other 5.7421875 MHz above (for a normal sideband position) the vision carrier frequency.
 - Select **General** for the **Group Delay** from the list.
 - Select **PAL** for the **Color System** from the list.
The color information of the video signal is transmitted according to the PAL standard.
 - For the **Bar Line**, set **Line** to 17 and the **Type** to **CCIR17**.
That means, that a special test signal, the so called bar line, is transmitted in the horizontal line 17 of the TV signal.
 - For the **Quiet Line**, set **Line** to 22.
That means, that the horizontal line 22 transmits no luminance information.
 - Select **Normal** as **Sideband Position** from the list.
 - The **Modulation Standard Options** dialog box should now look as in [Fig. 2-66](#).
11. Press the previous key twice to go back to the **Channel Table** dialog box.
12. Press the **Save Changes** softkey to save the channel table and the new modulation standard.

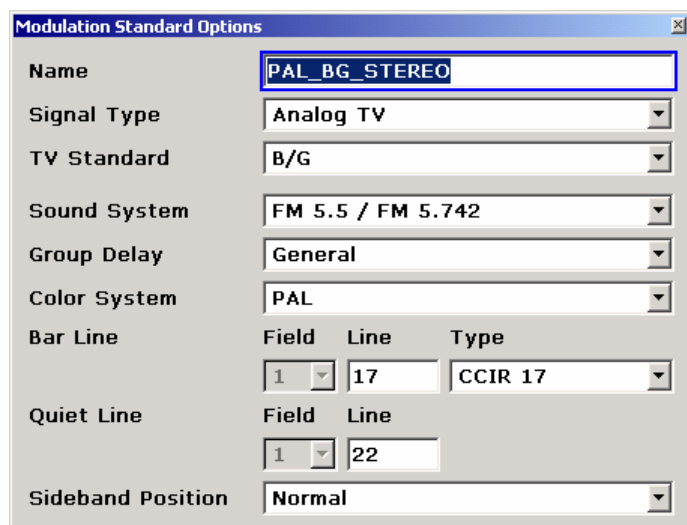

Fig. 2-66 Analog TV modulation standard PAL_BG_STEREO

Up to now, we successfully created the channel table EXAMPLE WIPFING, which contains a frequency plan and the analog TV modulation standard PAL_BG_STEREO. Next, we will create the digital modulation standard 64QAM_6900 based on the information of [Table 2-14](#).

13. Press the **Modulation Options** softkey.

A list with one modulation standard **PAL_BG_STEREO** is displayed.

14. In the **Modulation Options** submenu, press the **New** softkey.

The **Modulation Standard Options** dialog box is displayed (see for example [Fig. 2-66](#)).

15. Enter the parameters for the modulation standard:

- In the field **Name**, enter *64QAM_6900* as modulation standard name with the keypad.
- Select **Digital TV** as **Signal Type** from the list.
This is done, because the desired QAM DVB-C signal is a digital TV signal.
- Select **QAM J.83/A (DVB-C Europe)** as **TV Standard**.
By this means, all parameters below are set to their default values.
- Set Constellation to 64QAM.
- Set the **Symbol Rate** value to *6.9 MSyms/s*.
This can be done by entering 6.9 via the keypad and confirming the input with the MHz key.
- Set the **Roll-off** factor to **0.150**.
- Select **Auto** as **Sideband Position** from the list.
- The **Modulation Standard Options** dialog box should now look as in [Fig. 2-67](#).

16. Press the previous key twice to go back to the **Channel Table** dialog box.

17. Press the **Save Changes** softkey to save the channel table and the new modulation standard.

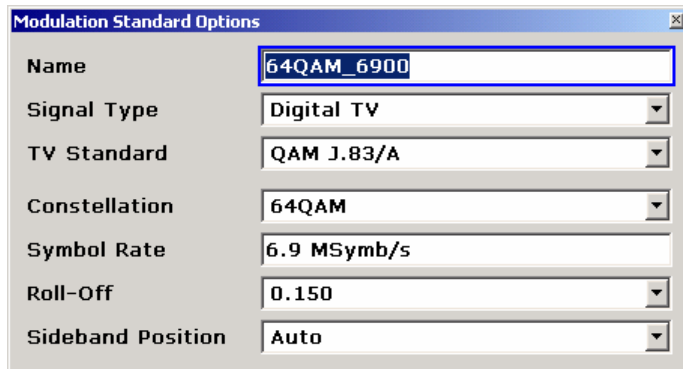

Fig. 2-67 Digital TV modulation standard 64QAM_6900

We have now finished step two, i.e. the channel table EXAMPLE WIPFING contains a frequency plan, the analog modulation standard PAL_BG_STEREO and the digital modulation standard 64QAM_6900.

Assign modulation standards to channels

Finally, in step three, the links between the frequency plan and the modulation standards have to be set. [Table 2-15](#) shows the desired combinations.

Table 2-15: Assignment of programs and services to channels

Channel No.	Program Name	Modulation Standard
2	-	< unused >
21	BRASS CHANNEL	PAL_BG_STEREO
22	XYZ NEWS	PAL_BG_STEREO
23	ARTE	64QAM_6900
24	GANESH	64QAM_6900

- Do not change channel 2, as no service is available (< unused >).
- To edit channel 21:
 - Enter *BRASS CHANNEL* into the **Comment** field of channel 21. The band name, entered before, is now replaced by the more meaningful program name.
 - Select **PAL_BG_STEREO** as **Modulation Standard** from the list. The list now offers: < unused >, **64QAM_6900** and **PAL_BG_STEREO**. Furthermore, the RF frequency will be automatically changed from 478 MHz to 475.25 MHz.
- To edit the channels 22, 23, and 24, proceed to step 2 using the information from [Table 2-15](#).
- Press the **Save Changes** softkey, to save the channel table.

The complete channel table is shown in [Fig. 2-68](#).

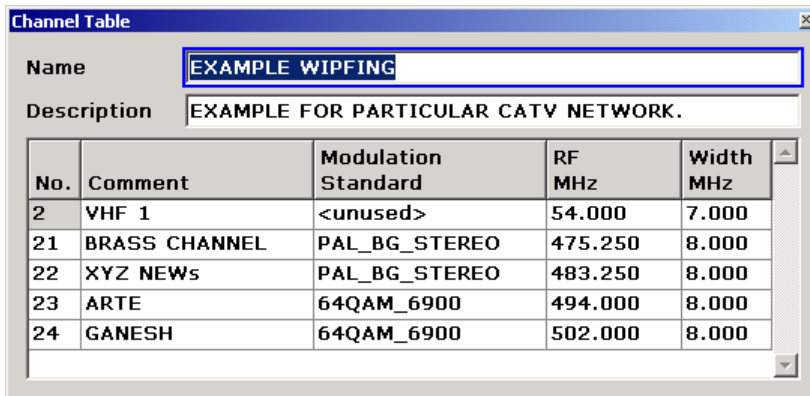

No.	Comment	Modulation Standard	RF MHz	Width MHz
2	VHF 1	<unused>	54.000	7.000
21	BRASS CHANNEL	PAL_BG_STEREO	475.250	8.000
22	XYZ NEWS	PAL_BG_STEREO	483.250	8.000
23	ARTE	64QAM_6900	494.000	8.000
24	GANESH	64QAM_6900	502.000	8.000

Fig. 2-68 Digital Channel table "EXAMPLE WIPFING"

We now have successfully finished the creation of the channel table "EXAMPLE WIPFING". Please refer to section [Performing a Measurement without a Channel Table](#) to learn more about measurements based on a channel table.

Example: Restoring the default channel tables

The Cable TV Measurements option brings several channel tables with it:

- The typical frequency plans used in different countries, e.g.
 - TV-CHINA
 - TV-EUROPE
 - TV-USA-CATV
 - etc...
- Example channel tables (see [Example: Creating a channel table](#)), e.g.
 - RS_EXAMPLE_BAVARIA
 - RS_EXAMPLE_WIPFING

If you have modified or deleted one of these channel tables, you can restore them in the following way:

1. Press the **MENU** key.
2. Press the **Channel Setup** softkey.
3. Press the **Restore Default Tables** softkey.

Only missing channel tables will be restored. If you want to replace an existing channel table by its default channel table, you have to delete it before.

Performing a Measurement without a Channel Table

The Cable TV Measurements option intends to help network engineers. Network engineers will once create a channel table, and then use it to visit many, many test points, all located in the same cable TV network. If you are a network engineer please see section [Performing a Measurement Using a Channel Table](#). If you work in R&D or you do not have a cable TV network at all (all you have is a single TV transmitter or a frequency where you want to do a measurement ignoring any signals apart), this section describes how to setup an analog TV Spectrum measurement without a channel table.

Test setup:

- Connect a analog TV generator to your R&S FSL. Set the TV generator to send an analog TV PAL B/G signal with a vision carrier frequency of 210.25 MHz.

Procedure:

1. Press the **MENU** key.
2. Press the **Channel Setup** softkey.
The **Channel Tables** dialog box is displayed. It lists all available channel tables.
3. Select no channel table < **none** > and press the **ENTER** key.
You should always select < **none** > if you do not have a channel table. In this mode you can do all kind of measurements except the **Tilt measurement**.
4. Press the **MEAS** key.
5. Press the **Analog TV** softkey.
By pressing this softkey you tell the Cable TV Measurements option, that your signal is an analog TV signal and that the **Default Analog Modulation Standard** has to be used. This modulation standard is used for all analog TV measurements knowing the fact that there is no channel table where a modulation standard can be retrieved from.
6. Press the **Spectrum** softkey.
In our example we want to check the spectrum of our analog TV source.
7. Press the **FREQ** key.
8. Press the **RF** softkey.
9. Enter **210.35 MHz** as the **RF** frequency.
10. To adjust the input attenuator, press the **Adjust Attenuation** softkey.

The following figure is displayed:

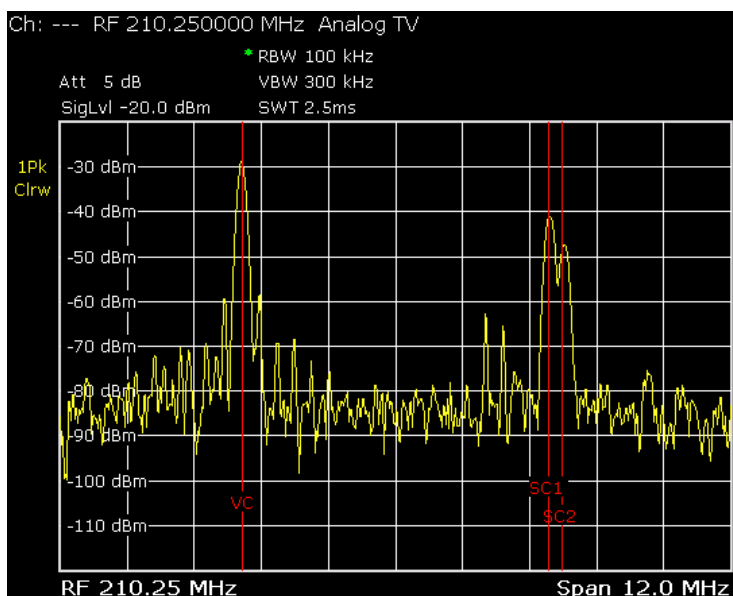

Fig. 2-69 Example for a measurement without a channel table

In practice you would now continue to adapt the modulation settings in depth, i.e. the sound system the test lines and so on. For our example we will stop here.

For further details on analog TV modulation parameters please refer to section [Analog TV settings](#).

Performing a Measurement Using a Channel Table

The use of a channel table can speed up most of the routine measurement tasks. This section will demonstrate how to perform measurements using channel tables.

Test setup:

- No special test setup is required. You do not need to supply a signal. We do not need meaningful measurement results here, since the focus is on the operation only.

Procedure:

1. Press the **MENU** key.
2. Press the **Channel Setup** softkey.
3. You should now see a list of Channel Tables, including the example channel table **RS_EXAMPLE_WIPFING**, that was used in section [Example: Creating a channel table](#). If you have deleted it, you must first restore it as shown in section [Example: Restoring the default channel tables](#).
4. Move the cursor to **RS_EXAMPLE_WIPFING** and press the **Activate** softkey.
The Cable TV Measurements option automatically switched to the first channel in the Channel Table.
5. Press the **MEAS** key.
6. Press the **Analog TV** softkey.
7. Press the **Carriers** softkey.

The resulting measurement is displayed (see [Fig. 2-70](#)).

The Cable TV Measurements option configures the measurement according to the information stored in the channel table:

- It automatically sets the span to measure the channel with number 21. The channel borders are marked with red vertical lines.
- It also knows how large the ideal intercarrier frequency offset (vision carrier to audio carriers) should be. This information is needed to calculate the deviation from the ideal value. The ideal sound carrier positions are also marked via red vertical lines.
- The measurement principle is chosen according to the modulation standard given for the current measurement channel. For example: The powers of a NICAM and a FM sound carrier must be measured in different ways.
- The display tells you the actual RF frequency and what modulation standard the channel contains.

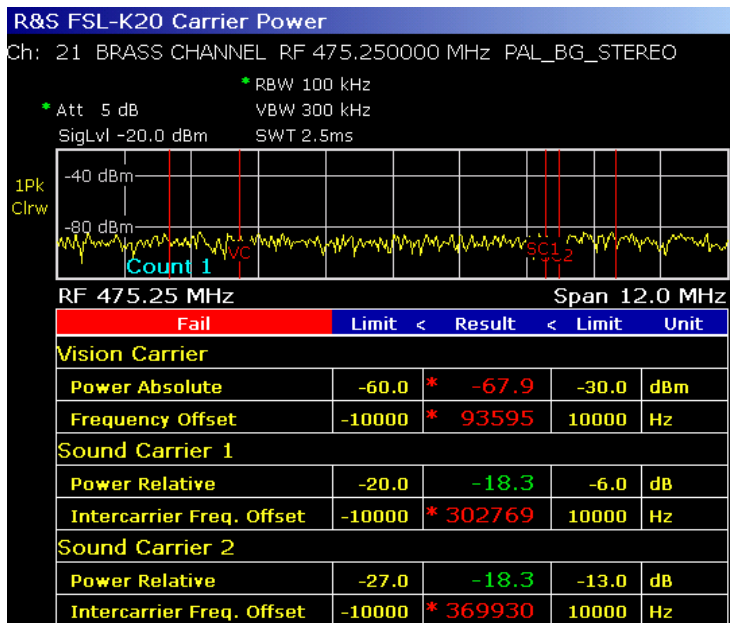

Fig. 2-70 Carriers measurement using a Channel Table. No input signal!

8. Press the **Channel No** softkey.
9. Input a channel number via the numeric keyboard. The Cable TV Measurements option will only allow analog TV channels defined in the active channel table, since we are in a measurement for analog TV channels and digital TV signals would not make sense! The same is true when you use the rotary knob for changing the measurement channel. So, the very small example channel table only allows us to switch to channel 22. Observe how the RF frequency changes.
10. Press the **MEAS** key.
11. Press the **Digital TV** softkey.
This switches to measurements for Digital TV signals.
12. Press the **Spectrum** softkey.
The resulting measurement is displayed (see Fig. 2-71).
The Cable TV Measurements option once again configures the measurement automatically and gives you information about the channel borders and the modulation standard.

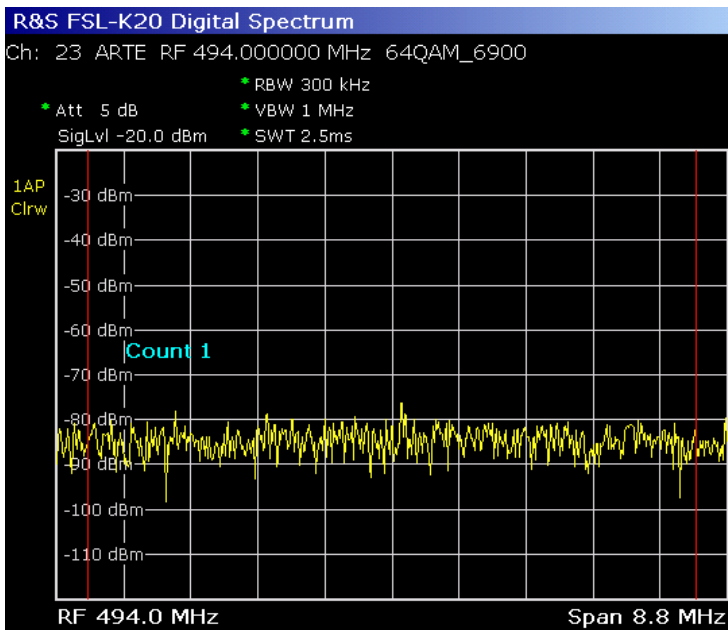

Fig. 2-71 Digital TV spectrum using a Channel Table. No input signal!

13. Press the **Channel No** softkey.
14. Choose one of the digital TV channels that are present in the channel table, because we are in a measurement designed for digital TV signals.
15. Press the **MEAS** key.
16. Press the **TV Analyzer** softkey.
17. Press the **Tilt** softkey.
18. Press the **Auto Range** softkey.

The resulting measurement is displayed (see Fig. 2-72).

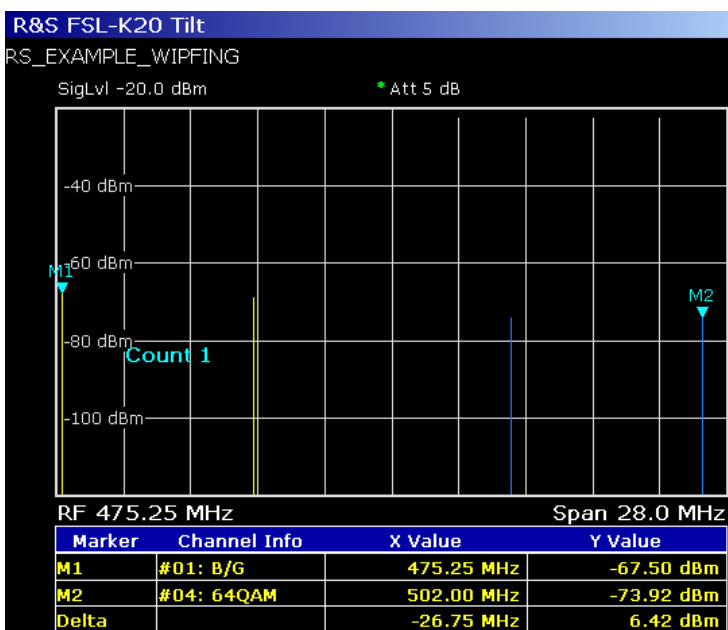

Fig. 2-72 Tilt measurement using a Channel Table. No input signal!

The use of a channel table is mandatory for the Tilt measurement. Because the Cable TV Measurements option must know where a channel's power has to be measured and how it has to be done. Each vertical line represents a channel. The blue ones are digital TV channels, the yellow ones are analog TV.

Noise Figure Measurements Option (K30)

This section describes measurement examples for the Noise Figure Measurements option (K30). For further information on measurement examples refer to the Quick Start Guide, chapter 5 "Basic Measurement Examples", or the Operating Manual on CD, chapter "Advanced Measurement Examples".

This option is available from firmware version 1.50.

Direct Measurements

Direct measurements are designed for DUTs without frequency-conversion, e.g. amplifiers. For details refer also to the Operating Manual on CD, chapter "Instrument Functions", section "Noise Figure Measurements Option (K30)".

Basic Measurement Example

This section provides step-by-step instructions for working through an ordinary noise figure measurement. The following steps are described:

1. Setting up the measurement
2. Performing the calibration
3. Performing the main measurement

The gain and noise figure of an amplifier are to be determined in the range from 220 MHz to 320 MHz.

Setting up the measurement

1. Activate the **Noise** mode (for details refer to chapter "Instrument Functions", section "Measurement Mode Selection - MODE Key").
2. Press the **Freq Settings** softkey to open the **Frequency Settings** dialog box.

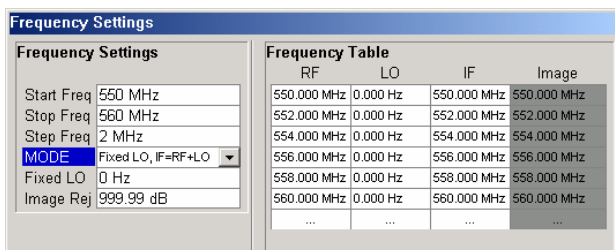

- In the **Start Freq** field, enter *550 MHz*.
- In the **Stop Freq** field, enter *560 MHz*.
- In the **Step Freq** field, enter *2 MHz*.

A measurement at 6 frequency points is performed: 550 MHz, 552 MHz, 554 MHz, ..., 560 MHz.

- Press the **ENR Settings** softkey to open the **ENR** dialog box.

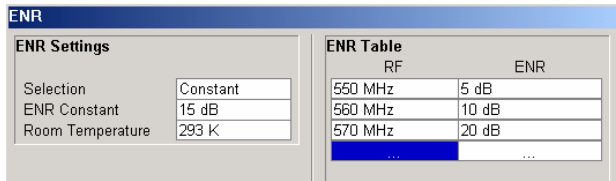

- In the **ENR Constant** field, enter the average ENR value of the used noise source for the frequency range of interest, for example *15 dB*.

- Press the **Meas Settings** softkey to open the **Measurement Settings** dialog box.

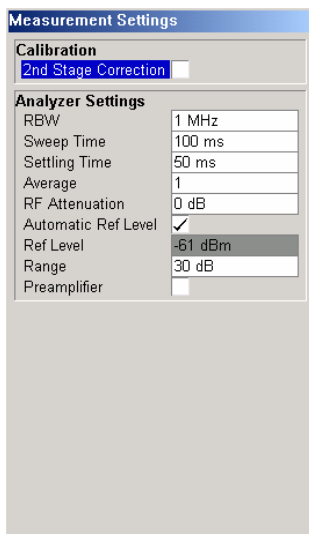

- Activate the **2nd Stage Correction** option to perform the measurement as accurately as possible.

Performing the calibration

- Connect the noise source to the RF input of the R&S FSL (see Fig. 2-73).
- If you perform the measurement in an environment with radiated emissions, you may consider to connect a lowpass filter to the voltage supply input of the noise source.
- Provide the voltage supply for the noise source by connecting it to the +28 V connector of the R&S FSL (labeled NOISE SOURCE CONTROL on the rear panel of the instrument) via a coax cable and the lowpass filter. Connect the lowpass filter between the noise source itself and the NOISE SOURCE CONTROL connector of the R&S FSL as shown in Fig. 2-73.

The purpose of the lowpass filter is to suppress any interference (e.g. due to RF interference), including interference from the supply line. This makes it possible to perform very precise measurements.

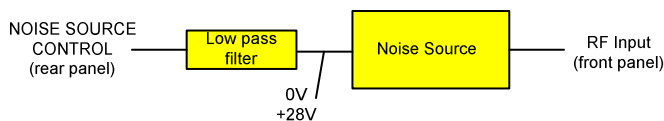

Fig. 2-73: Preparation for calibration

- Start the calibration for the Noise Figure Measurements option.
 - Press the **SWEEP** key.

- Press the **Cal** softkey.

The progress bar indicates the progress of the calibration measurement. After successful calibration, in the status bar, a corresponding message is displayed and the title bar at the top of the screen shows the status on the right-hand-side.

Performing the main measurement

1. Insert the DUT (in this example, the amplifier) into the test setup between the noise source and RF input of the R&S FSL (see Fig. 2-74).

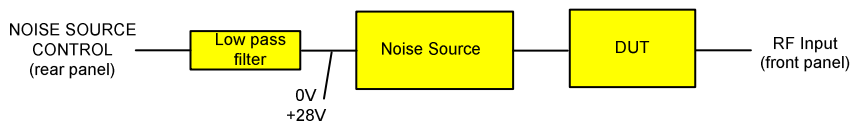

Fig. 2-74: Test setup for the main measurement

2. To select the sweep mode, press the **SWEEP** key.
3. Press the **RUN** key to start the measurement.

Measurement results are updated as the measurement is in progress. The results are displayed in graphical form. There are two traces, one for noise figure/temperature and one for the gain of the DUT.

4. To change the display from the graphical form to a tabular list of measurement points, press the **Display List/Graph** softkey.



If a measurement is started while another measurement is still in progress, the first measurement is aborted and the new measurement started immediately.

DUTs with very Large Gain

If the gain of the DUT exceeds 60 dB, the total gain must be reduced by an external attenuator. The total gain of the DUT together with the external attenuator should lie within the range from 10 dB to 60 dB. A total gain of 20 dB to 30 dB is recommended. For a DUT with a gain of e.g. 64 dB, it is recommended to use an external 40 dB-attenuator.

If an external attenuator is used, in the **Measurement Settings** dialog box, the entry in the **Range** field should be modified according to the total gain ($= G_{DUT} - \text{external attenuator}$).

The attenuation values of the external attenuator are entered in the **Loss Settings** dialog box under **Loss Output Settings**.

Inaccuracies when entering this attenuation mainly influence the measured gain. The noise figure remains to a large extent unaffected.

Calibration**Measurement**

Fig. 2-75: Calibration and measurement on DUTs with a high gain

Frequency-Converting Measurements

The frequency-converting measurement is used for DUTs with an output frequency that differs from the input frequency, e.g. mixers and frequency converters. The frequency-converting measurement allows many variations, which differ from each other in two criteria:

- Fixed LO Measurements
- Image-Frequency Rejection (SSB, DSB)

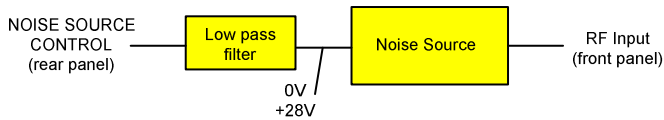
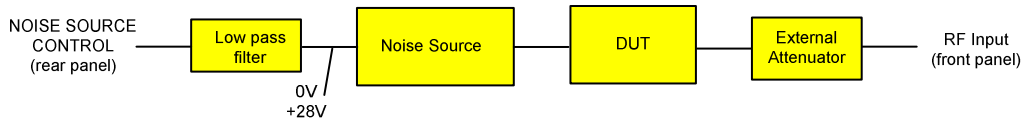
Fixed LO Measurements

In the **Frequency Settings** dialog box, select one of the following settings for the **Mode** parameter:

- fixed LO, $IF=RF+LO$, for up-converting devices
- fixed LO, $IF=abs(RF-LO)$, for down converters or image measurements

Image-Frequency Rejection (SSB, DSB)

Frequency-converting DUTs often do not only convert the desired input frequency but also the image frequency. A broadband noise source offers noise to the DUT not only at the input frequency but also at the image frequency. If the noise power at the IF gate is measured, the origin of the noise can no longer be determined. It may have been converted both from the input and from the image frequency range.

Test setup

- Set the following parameters:
 - IF (intermediate frequency): 100 MHz
 - RF (input frequency): 400 MHz
 - LO (local oscillator frequency): 500 MHz
 - image (image frequency): 600 MHz

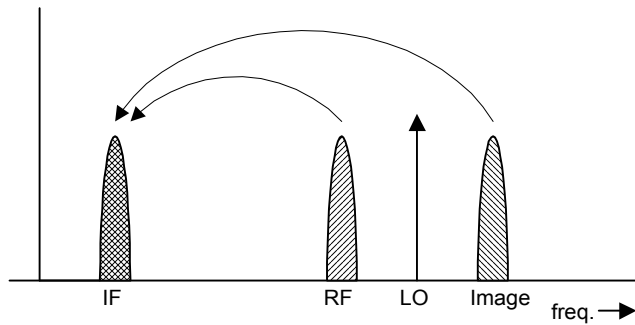

If a DUT, which equally converts the useful signal and the image to the IF frequency, is measured using the conventional y factor method or with the 2nd stage correction switched on, a measuring error of 3 dB is produced. The noise figure is displayed 3 dB lower and the gain 3 dB higher. The following examples help to configure the test setup in order to measure the actual values.

Measurement on a single-sideband mixer

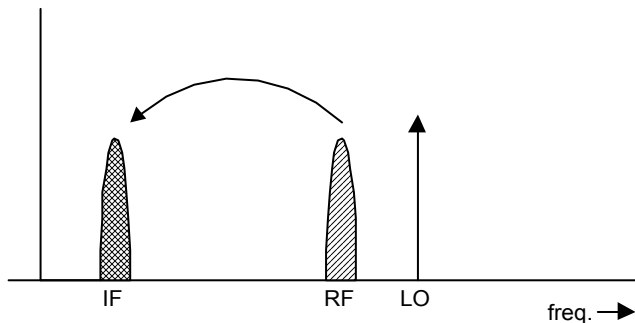

In general, a single-sideband mixer with a very high image rejection causes very few problems. The measurement is analogous to an amplifier. In this case, set the image rejection in the **Frequency Settings** dialog box to a large value (e.g. 999.99 dB).

Measurement on a mixer without sideband suppression

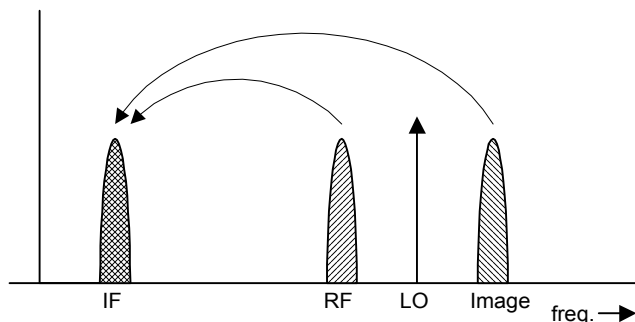

If the input and image frequencies are converted with the same application, an error of 3 dB occurs in the measurement results if the image rejection is not taken into account. In this case, set the image rejection in the **Frequency Settings** dialog box to a small value (e.g. 0.0 dB).

Measurement on a mixer with an average sideband suppression

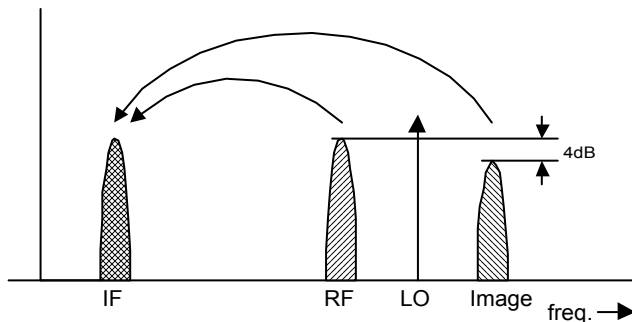

For measurements on a mixer with a low image-frequency rejection, a measuring error of 0 to 3 dB is obtained if the image-frequency rejection is not taken into account. In this case, set the image rejection in the **Frequency Settings** dialog box to 4 dB to produce the correct results.

Measurement on a mixer with unknown sideband suppression

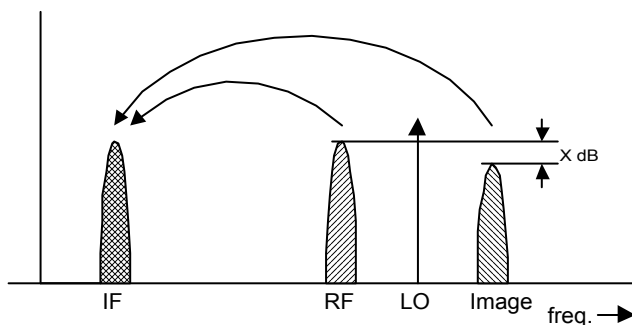

If the image rejection is not known, accurate noise results can still be produced. However, the gain of the DUT must be known and an additional filter is required.

Test setup

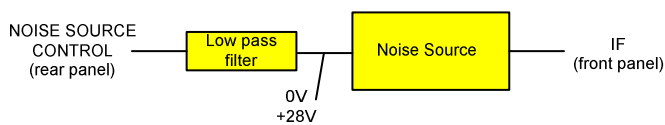

Fig. 2-76: Preparation for calibration

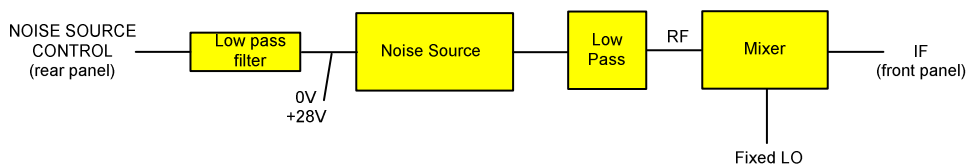

Fig. 2-77: Test setup for the main measurement

In this test setup, a low pass filter prevents noise from the noise source from being fed in at the image frequency. Depending on the position of the frequency bands, a highpass or bandpass filter may also be necessary for the RF frequency instead of the lowpass filter. The important point is that noise from

the noise source is not converted by a further receive path of the mixer. The noise of the noise source at the receive frequency must not be reduced. The insertion loss must be considered, if applicable.

With this test setup, the measurement on a mixer without sideband suppression corresponds to the measurement on a single-sideband mixer. As in that case, set the image rejection in the **Frequency Settings** dialog box to a large value (e.g. 999.99 dB) to produce accurate results.

To take the characteristics of the filter into account, in the **Loss Settings** dialog box, enter the insertion loss of the filter at the RF frequency. To consider the actual filter suppression at the image frequency, do not enter 999 dB but the actual attenuation for the image rejection.

Measurement on a harmonics mixer

For a harmonics mixer, the input signals are not only converted to the IF by the wanted harmonic, but also by the harmonic of the LO signal produced in the mixer. In many cases, the mixer even features a lower conversion loss in the case of unwanted harmonics. For measurements on this type of mixer, a bandpass filter must be used to make sure that there is only noise at the desired input frequency at the input of the DUT. This measurement is similar to measurements on a mixer with an average sideband suppression.

3GPP Base Station Measurements (Option K72)

This section explains basic 3GPP FDD base station tests by means of a setup with a signal generator, e.g. an R&S SMU. It describes how operating and measurement errors can be avoided using correct settings. The measurements are performed with an R&S FSL equipped with the 3GPP Base Station Measurements option (K72).

The following measurements are described:

- [Measuring the Signal Channel Power](#)
- [Measuring the Spectrum Emission Mask](#)
- [Measuring the Relative Code Domain Power](#)
 - [Synchronization of the reference frequencies](#)
 - [Behavior with deviating center frequency setting](#)
 - [Behavior with incorrect scrambling code](#)
- [Measuring the Relative Code Domain Power](#)
 - [Trigger offset](#)

Furthermore, the test setup for base station tests is given:

- [Setup for Base Station Tests](#)

For measurements on base-station signals in line with 3GPP, test models with different channel configurations are specified in the document "Base Station (BS) conformance testing (FDD)" (3GPP TS 25.141 V7.4.0).

For further information on measurement examples refer also to the Quick Start Guide, chapter 5 "Basic Measurement Examples".

This option is available from firmware version 1.60.

Measuring the Signal Channel Power

The R&S FSL measures the unweighted RF signal power in a bandwidth of

$$f_{BW} = 5 \text{ MHz} \geq (1 + \alpha) \cdot 3.84 \text{ MHz} \quad | \quad \alpha = 0.22$$

The power is measured in zero span using a digital channel filter of 5 MHz in bandwidth. According to the 3GPP standard, the measurement bandwidth (5 MHz) is slightly larger than the minimum required bandwidth of 4.7 MHz.

Test setup:

- Connect the RF output of the signal generator to the RF input of the R&S FSL (coaxial cable with N connectors).

Signal generator settings (e.g. R&S SMU):

Frequency: 2.1175 GHz
 Level: 0 dBm
 Standard: WCDMA/3GPP
 Test model: 1, 32 DPCH channels

Procedure:

1. Set the R&S FSL to its default state.
 - Press the **PRESET** key.
 - The R&S FSL is set to its default state.
2. Change into the **3G FDD BTS** mode.
 - Press the **MODE** key and activate the **3G FDD BTS** option.
3. Set the center frequency to 2.1175 GHz.
 - Press the **FREQ** key.
 - The frequency menu is displayed.
 - In the dialog box, enter 2.1175 using the numeric keypad and confirm with the **GHz** key.
4. Set the reference level to 0 dBm.
 - Press the **AMPT** key and enter 0 dBm.
5. Start the Power measurement.
 - Press the **MEAS** key.
 - Press the **Power** softkey.
 - The signal channel power of the WCDMA signal is displayed.

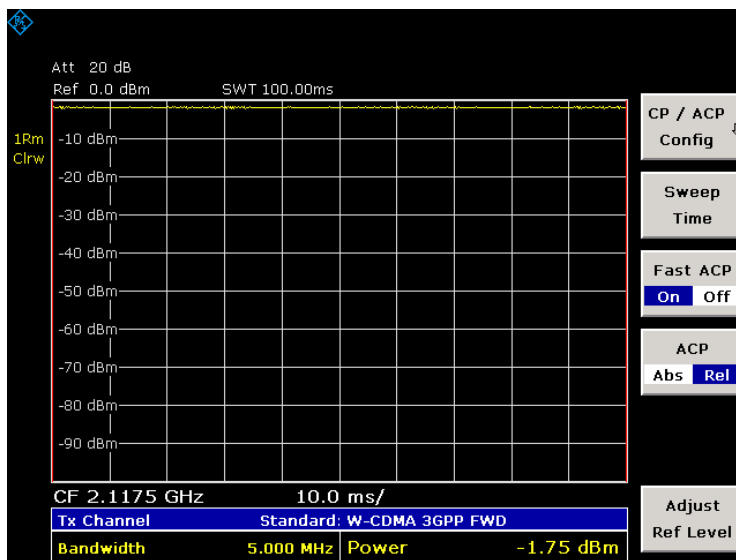

Fig. 2-78 Power measurement

Measuring the Spectrum Emission Mask

The 3GPP specification defines a measurement that monitors compliance with a spectral mask in a range of at least ± 12.5 MHz around the WCDMA carrier. To assess the power emissions in the specified range, the signal power is measured in the range near the carrier by means of a 30 kHz filter, and in the ranges far away from the carrier by means of a 1 MHz filter. The resulting trace is compared to a limit line defined in the 3GPP specification.

Test setup:

- Connect the RF output of the signal generator to the RF input of the R&S FSL (coaxial cable with N connectors).

Signal generator settings (e.g. R&S SMU):

Frequency: 2.1175 GHz
Level: 0 dBm
Standard: WCDMA/3GPP
Test model: 1, 32 DPCH channels

Procedure:

1. Set the R&S FSL to its default state.
 - Press the **PRESET** key.
The R&S FSL is set to its default state.
2. Change into the **3G FDD BTS** mode.
 - Press the **MODE** key and activate the **3G FDD BTS** option.
3. Set the center frequency to 2.1175 GHz.
 - Press the **FREQ** key.
The frequency menu is displayed.
 - In the dialog box, enter *2.1175* using the numeric keypad and confirm with the **GHz** key.
4. Set the reference level to 0 dBm.
 - Press the **AMPT** key and enter *0 dBm*.
5. Start the Spectrum Emission Mask measurement.
 - Press the **MEAS** key.
 - Press the Spectrum Emission Mask softkey.
The spectrum of the 3GPP FDD signal is displayed.

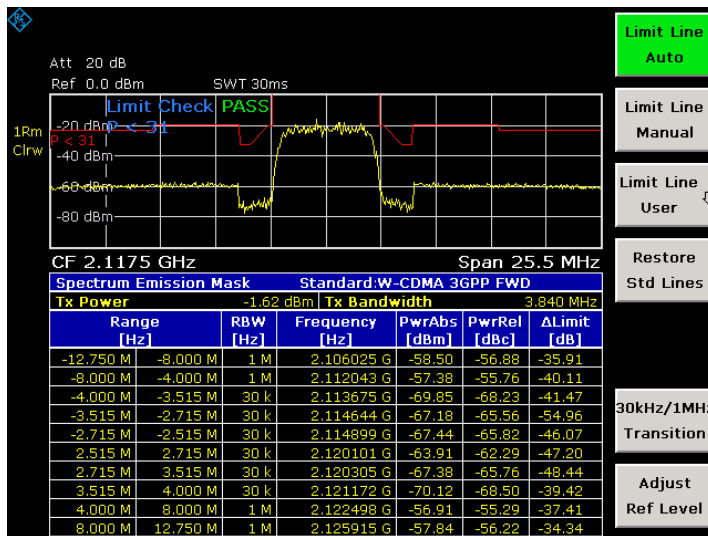

Fig. 2-79 Spectrum Emission Mask measurement

Measuring the Relative Code Domain Power

A code domain power measurement on one of the test models (model 1 with 32 channels) is shown in the following. To demonstrate the effects, the basic parameters of the Code Domain Power measurements permitting an analysis of the signal are changed one after the other from values adapted to the measurement signal to non-adapted values.

Test setup:

- Connect the RF output of the signal generator to the input of the R&S FSL.
- Connect the reference input (EXT REF) on the rear panel of the R&S FSL to the reference input of the signal generator (coaxial cable with BNC connectors).

Signal generator settings (e.g. R&S SMU):

Frequency: 2.1175 GHz
 Level: 0 dBm
 Standard: WCDMA/3GPP
 Test model: 1, 32 DPCH channels

Procedure:

1. Set the R&S FSL to its default state.
 - Press the **PRESET** key.
 - The R&S FSL is set to its default state.
2. Change into the **3G FDD BTS** mode.
 - Press the **MODE** key and activate the **3G FDD BTS** option.
3. Set the center frequency to 2.1175 GHz.
 - Press the **FREQ** key.

The frequency menu is displayed.

- In the dialog box, enter 2.1175 using the numeric keypad and confirm with the **GHz** key.

4. Adjust the reference level and scrambling code.

- Press the **MEAS** key.

The measurement menu is displayed.

- Press the **Auto Level & Code** softkey.

The firmware adjusts the reference level and then searches the scrambling code automatically.

5. Select the Code Domain Power measurement.

- Press the **MEAS** key.
- Press the Code Dom Power Diagram softkey.

The Code Domain Power of signal according to test model 1 with 32 channels is displayed.

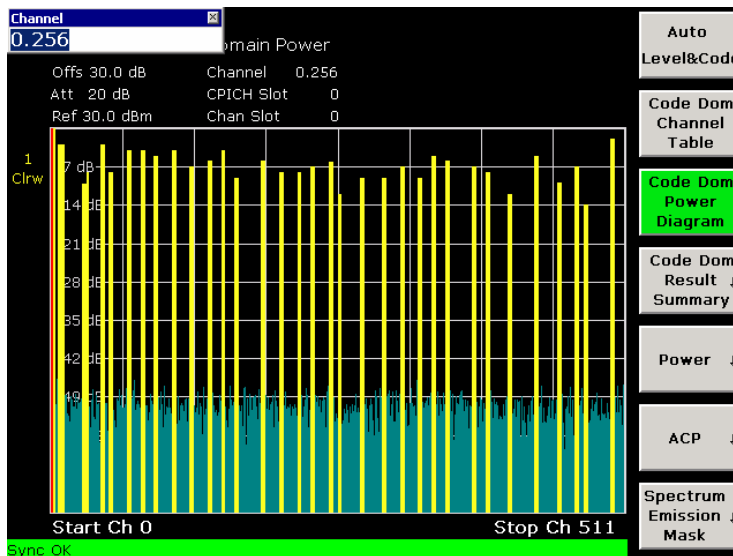

Fig. 2-80 Relative Code Domain Power measurement

Synchronization of the reference frequencies

Synchronization of the reference oscillators both of the DUT and the R&S FSL strongly reduces the measured frequency error.

1. Press the **SETUP** key.
2. Press the **Reference Int/Ext** softkey to switch to external reference.

The displayed frequency error should be <10 Hz.

Behavior with deviating center frequency setting

In the following, the behavior of the DUT and the R&S FSL with an incorrect center frequency setting is shown.

1. Tune the center frequency of the signal generator in 0.5 kHz steps.
2. Watch the R&S FSL screen.

A Code Domain Power measurement on the R&S FSL is still possible with a frequency error of up to approx. 1 kHz. Up to 1 kHz, a frequency error causes no apparent difference in the accuracy of the Code Domain Power measurement.

Above a frequency error of 1 kHz, the probability of impaired synchronization increases. With continuous measurements, all channels are at times displayed in blue with almost the same level.

Above a frequency error of approx. 2 kHz, a Code Domain Power measurement cannot be performed. The R&S FSL displays all possible codes in blue with a similar level.

3. Set the signal generator center frequency to 2.1175 GHz again.

Behavior with incorrect scrambling code

A correct Code Domain Power measurement can be carried out only if the scrambling code set on the R&S FSL is identical to that of the transmitted signal.

1. Set the scrambling code of the signal generator to 0001.

With the scrambling code still set to 0 (default setting), the Code Domain Power Diagram result display of the R&S FSL shows all possible codes with approximately the same level.

2. Set the correct scrambling code on the R&S FSL.

- Press the **MENU** key.
- Press the **Scrambling Code** softkey.
- In the submenu, press the **Scrambling Code** softkey and enter *1* using the numeric keypad.

The Code Domain Power display again shows the test model.

Measuring the Relative Code Domain Power Triggered

If the code domain power measurement is performed without external triggering, a section of approximately 20 ms of the test signal is recorded at an arbitrary moment to detect the start of a 3GPP FDD frame in this section. Depending on the position of the frame start, the required computing time can be quite long. Applying an external (frame) trigger can reduce the computing time.

Test setup:

- Connect the RF output of the signal generator to the input of the R&S FSL.
- Connect the reference input (EXT REF) on the rear panel of the R&S FSL to the reference input of the signal generator (coaxial cable with BNC connectors).
- Connect the external trigger input on the rear panel of the R&S FSL (EXT TRIGGER/GATE IN) to the external trigger output of the signal generator.

Signal generator settings (e.g. R&S SMU):

Frequency: 2.1175 GHz
Level: 0 dBm
Standard: WCDMA/3GPP
Test model: 1, 32 DPCH channels

Procedure:

1. Set the R&S FSL to its default state.
 - Press the **PRESET** key.
The R&S FSL is set to its default state.
2. Change into the **3G FDD BTS** mode.
 - Press the **MODE** key and activate the **3G FDD BTS** option.
3. Set the center frequency to 2.1175 GHz.
 - Press the **FREQ** key.
The frequency menu is displayed.
 - In the dialog box, enter *2.1175* using the numeric keypad and confirm with the **GHz** key.
4. Adjust the reference level and scrambling code.
 - Press the **MEAS** key.
The measurement menu is displayed.
 - Press the **Auto Level & Code** softkey.
The firmware adjusts the reference level and then searches the scrambling code automatically.
5. Select the Code Domain Power measurement.
 - Press the **MEAS** key.
 - Press the Code Dom Power Diagram softkey.
6. Select an external trigger source.
 - Press the **TRIG** key.
 - Press the **Trigger Source** softkey and select the **External** option.
The Code Domain Power of signal according to test model 1 with 32 channels is displayed.
The repetition rate of the measurement increases considerably compared to the repetition rate of a measurement without an external trigger.

Trigger offset

A delay of the trigger event referenced to the start of the 3GPP FDD frame can be compensated by modifying the trigger offset.

1. Press the **TRIG** key.
2. Press the **Trigger Offset** softkey and enter *100* using the numeric keypad and confirm with the **µs** key.

Setup for Base Station Tests

This section describes how to set up the R&S FSL for 3GPP FDD base station tests. As a prerequisite for starting the test, the instrument must be correctly set up and connected to the AC power supply as described in the Quick Start Guide, chapter 1. Furthermore, the R&S FSL must be equipped with the 3GPP Base Station Measurements option (R&S FSL-K72). Installation instructions are provided in the Quick Start Guide, chapter 3.:

Standard test setup

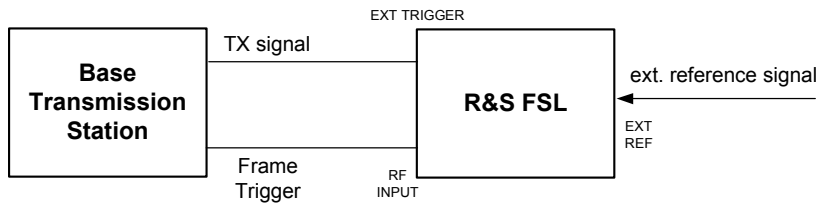

Fig. 2-81 Base Transmission station test setup

- Connect the antenna output (or TX output) of the base transmission station to RF input of the R&S FSL via a power attenuator of suitable attenuation.

The following values are recommended for the external attenuator to ensure that the RF input of the R&S FSL is protected and the sensitivity of the R&S FSL is not reduced too much.

Max. power	Recommended ext. attenuation
≥55 to 60 dBm	35 to 40 dB
≥50 to 55 dBm	30 to 35 dB
≥45 to 50 dBm	25 to 30 dB
≥40 to 45 dBm	20 to 25 dB
≥35 to 40 dBm	15 to 20 dB
≥30 to 35 dBm	10 to 15 dB
≥25 to 30 dBm	5 to 10 dB
≥20 to 25 dBm	0 to 5 dB
<20 dBm	0 dB

- For signal measurements at the output of two-port networks, connect the reference frequency of the signal source to the reference input of the R&S FSL (*EXT REF*).
- To ensure that the error limits specified by the 3GPP standard are met, the R&S FSL should use an external reference frequency for frequency measurements on base stations. For instance, a rubidium frequency standard may be used as a reference source.
- If the base station is provided with a trigger output, connect this output to the trigger input of the R&S FSL (*EXT TRIGGER/GATE IN*).

Basic settings

1. Enter the external attenuation).
2. Enter the reference level.
3. Enter the center frequency.
4. Set the trigger.
5. Select the standard and measurement.

CDMA2000 Base Station Measurements (Option K82)

This section explains basic CDMA2000 base station tests by means of a setup with a signal generator, e.g. an R&S SMU. It describes how operating and measurement errors can be avoided using correct settings. The measurements are performed with an R&S FSL equipped with the CDMA2000 Base Station Measurements option (K82).

The following measurements are described:

- [Measuring the Signal Channel Power](#)
- [Measuring the Spectrum Emission Mask](#)
- [Measuring the Relative Code Domain Power and the Frequency Error](#)
 - [Synchronization of the reference frequencies](#)
 - [Behavior with deviating center frequency setting](#)
- [Measuring the triggered Relative Code Domain Power](#)
 - [Adjusting the trigger offset](#)
 - [Behaviour with the wrong PN offset](#)
- [Measuring the Composite EVM](#)
- [Measuring the Peak Code Domain Error and the RHO Factor](#)
 - [Displaying RHO](#)

Furthermore, the test setup for base station tests is given:

- [Test Setup for Base Station Tests](#)

As the CDMA2000 Base Station Measurements option also supports the CDMA2000 Standard, the examples are performed on an CDMA2000 signal.

General test setup:

The measurements are performed with the following units and accessories:

R&S FSL equipped with the CDMA2000 Base Station Measurements option

R&S SMU signal generator equipped with option SMU-B9 / B10 / B11 baseband generator and SMU-K46 CDMA2000 incl. 1xEVDV.

1 coaxial cable, 50 Ω , approximately 1 m, N connector

2 coaxial cables, 50 Ω , approximately 1 m, BNC connector

This option is available from firmware version 1.90.

Measuring the Signal Channel Power

In the Power measurement, the total channel power of the CDMA2000 signal is displayed. The measurement also displays spurious emissions like harmonics or intermodulation products that occur close to the carrier.

Test setup:

- Connect the RF output of the signal generator to the RF input of the R&S FSL (coaxial cable with N connectors).

Signal generator settings:

Frequency: 878.49 MHz

Level: 0 dBm

Standard: CDMA2000

Procedure:

1. Set the R&S FSL to its default state.
 - Press the **PRESET** key.
2. Activate the CDMA2000 BTS Analyzer mode.
 - Press the **MODE** key and activate the **CDMA2000 BTS Analyzer** option.
3. Start the Power measurement
 - Press the **MEAS** key.
 - Press the **Power** softkey.
4. Set the center frequency.
 - Press the **FREQ** key and enter *878.49 MHz*.
5. Set the reference level.
 - Press the **AMPT** key and enter *0 dBm*.

On the screen, the spectrum of the signal and the corresponding power levels within the 1.2288 MHz channel bandwidth are displayed. In the table below the diagram, the numeric values of the channel bandwidth of the TX channel and power level of the analyzed signal are listed.



Abbildung 2-82: Measurement of the signal channel power

Measuring the Spectrum Emission Mask

To detect spurious emissions such as harmonics or intermodulation products, the R&S FSL offers a spectrum emission mask measurement. The measurement compares the power against the spectrum emissions mask in the range from -4 MHz to 4 MHz around the carrier. The exact measurement settings like the filter that is used depend on the Band Class parameter. For a list of supported bandclasses refer to chapter 4 "Instrument Functions".

Test setup:

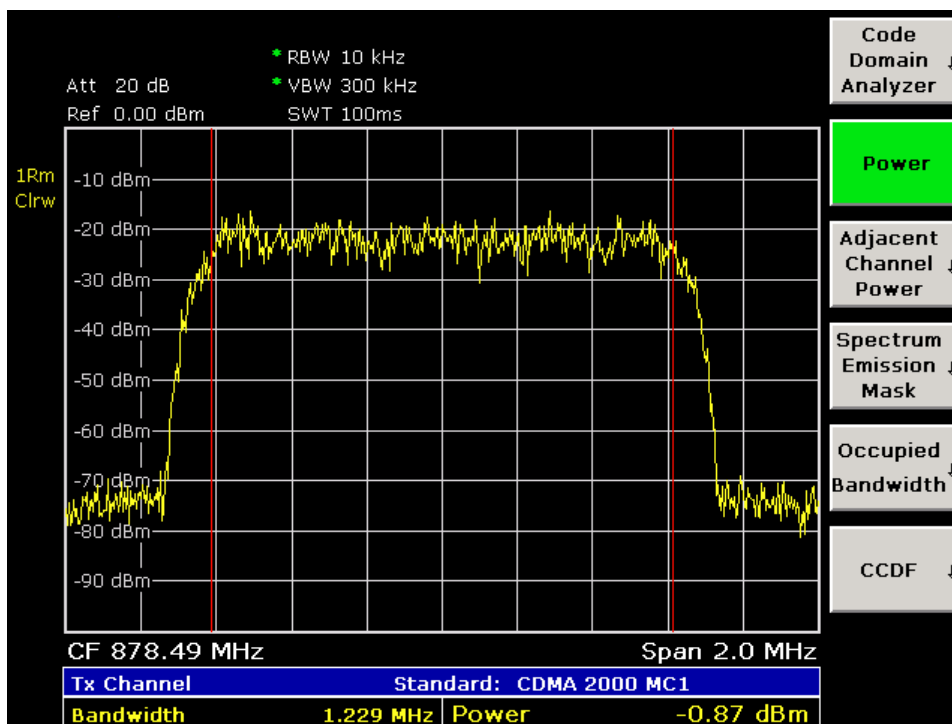
- Connect the RF output of the signal generator to the RF input of the R&S FSL (coaxial cable with N connectors).

Signal generator settings:

Frequency: 878.49 MHz
Level: 0 dBm
Standard: CDMA2000

Procedure:

1. Set the R&S FSL to its default state.
 - Press the **PRESET** key.
2. Activate the CDMA2000 BTS Analyzer mode.
 - Press the **MODE** key and activate the **CDMA2000 BTS Analyzer** option.
3. Start the measurement.
 - Press the **MEAS** key.
 - Press the **Spectrum Emission Mask** softkey.
4. Set the center frequency.
 - Press the **FREQ** key and enter *878.49 MHz*.
5. Set the reference level.
 - Press the **AMPT** key and enter *0 dBm*.
6. Select a bandclass
 - Press the **Bandclass** softkey and select **BandClass 0: 800 MHz Cellular Band** from the list.

On the screen, the spectrum of the signal is displayed, including the limit line defined in the standard. To understand where and about how much the measurement has failed, the List Evaluation table shows the frequencies, where spurious emissions occur.



Abbildung 2-83: Measurement of the Spectrum Emission Mask

Measuring the Relative Code Domain Power and the Frequency Error

A Code Domain Power measurement analyses the signal over a single Power Control Group (PCG). It also determines the power of all channels.

A Code Domain Power measurement on a test model (having 9 channels) is performed. The basic parameters of the Code Domain Power measurements are changed one after the other to demonstrate the ensuing effects: values adapted to the measurement signal are changed to non-adapted values.

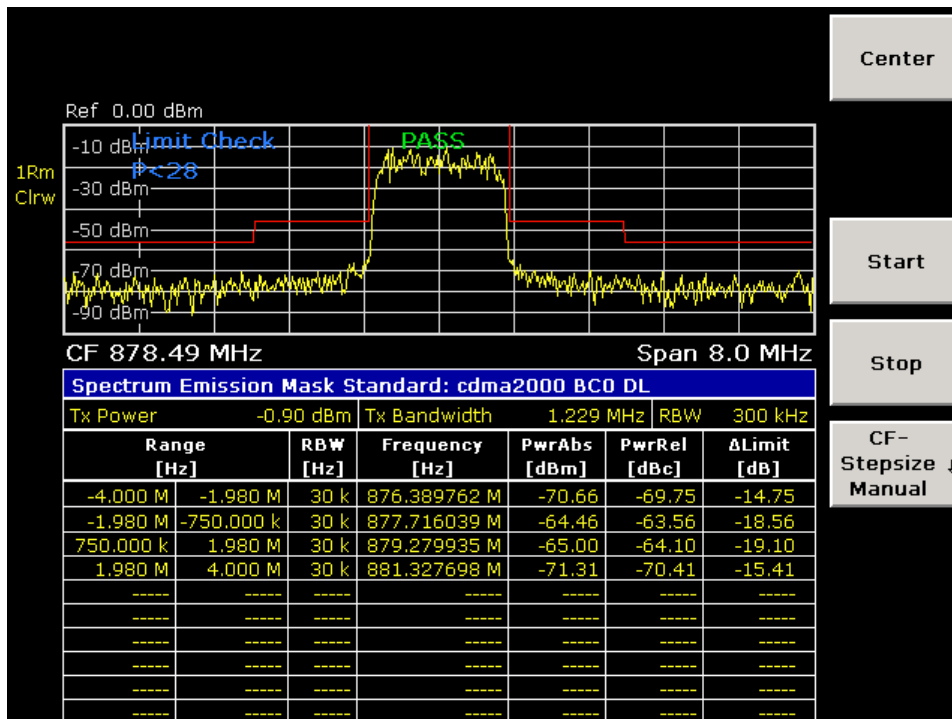

In the following examples, adjusting the settings of the code domain measurements is described using the dialog boxes. Alternately the settings can also be modified by using the corresponding hardkeys as in the base unit (e.g. the center frequency can be either set via the Frontend Settings dialog box, but also via the **FREQ** key).

Test setup:

- Connect the RF output of the signal generator to the RF input of the R&S FSL.
- Connect the reference input (EXT REF) on the rear panel of the R&S FSL to the reference output (REF) of the signal generator (coaxial cable with BNC connectors).

Signal generator settings:

Frequency: 878.49 MHz

Level: 0 dBm

Standard: CDMA2000

Procedure:

1. Set the R&S FSL to its default state.
 - Press the **PRESET** key.
2. Activate the CDMA2000 BTS Analyzer Mode.
 - Press the **MODE** key and select **CDMA2000 BTS Analyzer**.
3. Enter the Code Domain Analyzer.
 - Press the **MEAS** key
 - Press the **Code Domain Analyzer** softkey.
4. Start the measurement
 - In the Code Domain Analyzer softkey menu, press the **Select Meas** softkey.
 - Press the **Code Domain Power** softkey.
5. Enter the Settings Overview dialog box.
 - Press the **Settings** softkey.
 - Press the **Settings Overview** softkey.
 - The Settings Overview dialog box is displayed.
6. Set the center frequency and the reference level.
 - In the Settings Overview dialog box select the **Frontend** button.
 - In the **Center Frequency** field enter *878.49 MHz*.
 - In the **Ref Level** field enter *10 dBm*.
 - Close the Frontend Settings dialog box.
 - Close the Settings Overview box.

In the two screens, the following results are displayed: screen A shows the power of the code domain of the signal. The x-axis represents the individual channels (or codes), while the y-axis shows the power of each channel. In screen B the result summary is displayed. It shows the numeric results of the code domain power measurement, including the frequency error.



Abbildung 2-84: Measurement of the code domain power without external reference

Synchronization of the reference frequencies

The frequency error can be reduced by synchronizing the transmitter and the receiver to the same reference frequency.

7. Press the **SETUP** key.
 - Press the **Reference Int/Ext** softkey to switch to an external reference.

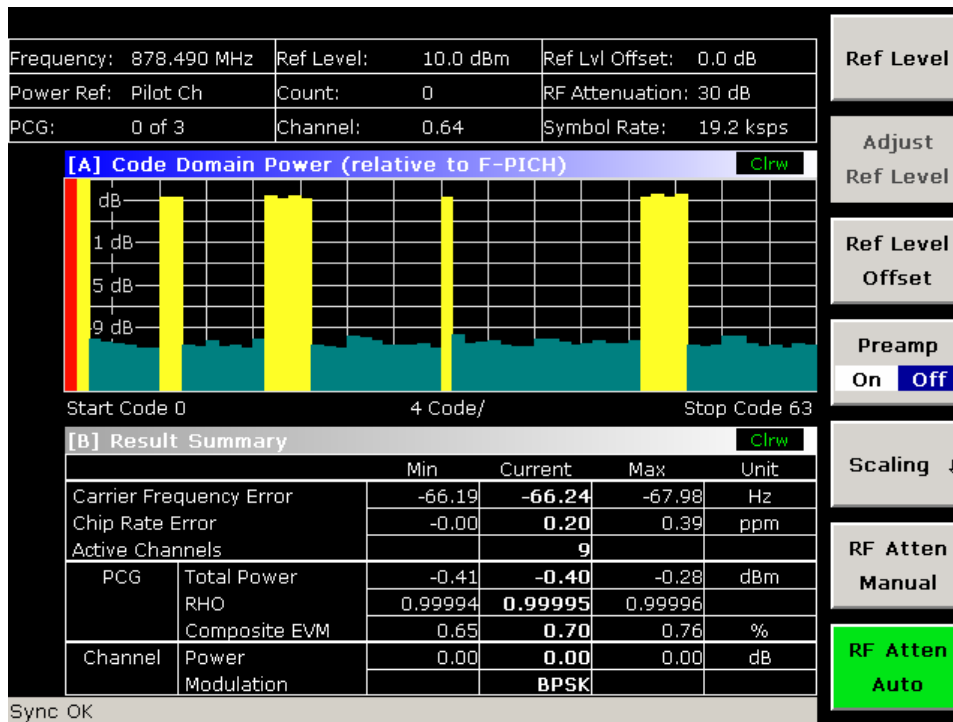
Screen A again shows the CDP measurement and screen B the result summary. After the synchronization of the reference frequencies of the devices, the frequency error should now be smaller than 10 Hz.

Behavior with deviating center frequency setting

A measurement can only be valid if the center frequency of the DUT and the analyzer are balanced.

8. On the signal generator, change the center frequency in steps of 0.1 kHz and observe the analyzer screen.

Up to a frequency error of approximately 1.0 kHz, a Code Domain Power measurement on the R&S FSL is still possible. A frequency error within this range causes no apparent difference in the accuracy of the Code Domain Power measurement.

In case of a frequency error of more than 1.0 kHz, the probability of incorrect synchronization increases. This is indicated by the SYNC FAILED error message.

If the frequency error exceeds approximately 1.5 kHz, a Code Domain Power measurement cannot be performed. This is indicated by the SYNC FAILED error message.

Reset the center frequency of the signal generator to *878.49 MHz*.



The center frequency of the DUT should not deviate by more than 1.0 kHz from that of the R&S FSL.

Measuring the triggered Relative Code Domain Power

If the code domain power measurement is performed without external triggering, a section of the test signal is recorded at an arbitrary point of time and the firmware attempts to detect the start of a power control group (PCG). To detect this start, all possibilities of the PN sequence location have to be tested in **Free Run** trigger mode. This requires computing time. This computing time can be reduced by using an external (frame) trigger and entering the correct PN offset. If the search range for the start of the power control group and the PN offset are known then fewer possibilities have to be tested. This increases the measurement speed.

Test setup:

- Connect the RF output of the signal generator to the input of the R&S FSL.
- Connect the reference input (EXT REF) on the rear panel of the R&S FSL to the reference input of the signal generator (coaxial cable with BNC connectors).
- Connect the external trigger input on the rear panel of the R&S FSL (EXT TRIGGER/GATE IN) to the external trigger output of the signal generator.

Signal generator settings (e.g. R&S SMU):

Frequency: 878.49 MHz
Level: 0 dBm
Standard: CDMA2000

Procedure:

1. Set the R&S FSL to its default state.
 - Press the **PRESET** key.
2. Activate the CDMA2000 BTS Analyzer Mode.
 - Press the **MODE** key and select **CDMA2000 BTS Analyzer**.
3. Enter the Code Domain Analyzer.
 - Press the **MEAS** key
 - Press the **Code Domain Analyzer** softkey.
4. Start the measurement.
 - In the Code Domain Analyzer softkey menu, press the **Select Meas** softkey.
 - Press the **Code Domain Power** softkey.
5. Enter the Settings Overview dialog box.
 - Press the **Settings** softkey.
 - Press the **Settings Overview** softkey.

The Settings Overview dialog box is displayed.

6. Set the center frequency and the reference level.
 - In the Settings Overview dialog box select the **Frontend** button.
 - In the **Center Frequency** field enter *878.49 MHz*.
 - In the **Ref Level** field enter *10 dBm*.
 - Close the Frontend Settings dialog box.
 - Close the Settings Overview box.

In the two screens, the following results are displayed: by default, screen A shows the code domain power of the signal. Compared to the measurement without an external trigger (see previous example), the repetition rate of the measurement increases. In screen B the result summary is displayed. In the row Trigger to Frame, the offset between the trigger event and the start of the PCG (Power Control Group) is shown.



Abbildung 2-85: Measurement of the code domain power with an external trigger source

Note that the Trigger to Frame parameter is only visible in the full screen mode of the Result Summary display.

7. Change into full screen mode..
 - Set the focus on screen B by pressing the **Screen Focus A/B** softkey.
 - Press the **Screen Size Split/Full** softkey.

The display is now in full screen mode

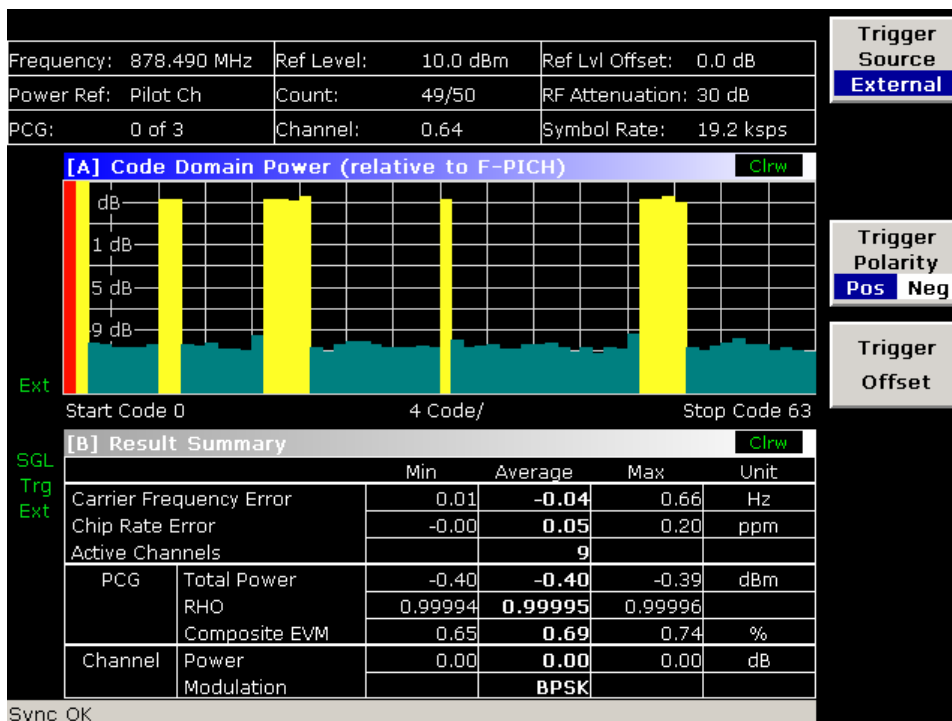
Adjusting the trigger offset

The delay between the trigger event and the start of the PCG can be compensated for by adjusting the trigger offset.

8. Set an external trigger source and the trigger offset.
 - In the Settings Overview dialog box select the **IQ Capture** button.

- Set the **Trigger Source** radio button to **External**.
- Set the **Trigger Offset** to $100\mu\text{s}$ to compensate analog delays of the trigger event.

In the two screens, the following results are displayed: Screen A shows the the same as above. In screen B the result summary is displayed. In the Trg to Frame result, the offset between the trigger event and the start of the PCG has been adjusted.

Behaviour with the wrong PN offset

The last adjustment to be made is setting the PN (Pseudo Noise) offset correctly. The measurement can only be valid, if the PN offset on the analyzer is the same as that of the transmit signal.

9. Set a PN Offset.

- In the Settings Overview dialog box select the **Demodulation Settings** button.
- In the **PN Offset** field enter **200**.

Again, screen A shows the CDP measurement, screen B the result summary. In the result summary, the Trigger to Frame result is not correct. Also, the error message SYNC FAILED indicates that the synchronization has failed.

- In the **PN Offset** field enter **0**

After adjusting it, the PN offset on the R&S FSL is the same as that of the signal. In the result summary the Trg To Frame value is now shown correctly.

Frequency:	878.490 MHz	Ref Level:	10.0 dBm	Ref Lvl Offset:	0.0 dB	Settings ↓																																																																																																											
Power Ref:	Pilot Ch	Count:	50/50	RF Attenuation:	30 dB																																																																																																												
PCG:	0 of 2	Channel:	0.64	Symbol Rate:	19.2 ksps																																																																																																												
[B] Result Summary Clr						Screen Focus																																																																																																											
						A B																																																																																																											
						Screen Size																																																																																																											
						Split Full																																																																																																											
						Select Meas ↓																																																																																																											
						Select Ch PCG																																																																																																											
						Adjust Ref Level																																																																																																											
						More ↓																																																																																																											
<table border="1"> <thead> <tr> <th></th> <th></th> <th>Min</th> <th>Average</th> <th>Max</th> <th>Unit</th> </tr> </thead> <tbody> <tr> <td>Carrier Frequency Error</td> <td></td> <td>-0.00</td> <td>-0.00</td> <td>-0.90</td> <td>Hz</td> </tr> <tr> <td>Carrier Frequency Error</td> <td></td> <td>-0.00</td> <td>-0.00</td> <td>-0.00</td> <td>ppm</td> </tr> <tr> <td>Chip Rate Error</td> <td></td> <td>0.00</td> <td>0.07</td> <td>0.40</td> <td>ppm</td> </tr> <tr> <td>Trigger to Frame</td> <td></td> <td>-99.7255</td> <td>-99.7261</td> <td>-99.8518</td> <td>μs</td> </tr> <tr> <td>Active Channels</td> <td></td> <td></td> <td>9</td> <td></td> <td></td> </tr> <tr> <td rowspan="3">Ext</td> <td>PCG</td> <td>Total Power</td> <td>-0.40</td> <td>-0.40</td> <td>-0.39</td> <td>dBm</td> </tr> <tr> <td></td> <td>Pilot Power</td> <td>-7.40</td> <td>-7.39</td> <td>-7.39</td> <td>dBm</td> </tr> <tr> <td></td> <td>RHO</td> <td>0.99994</td> <td>0.99995</td> <td>0.99996</td> <td></td> </tr> <tr> <td rowspan="3">Trg</td> <td></td> <td>Composite EVM</td> <td>0.65</td> <td>0.68</td> <td>0.76</td> <td>%</td> </tr> <tr> <td></td> <td>IQ Imbalance</td> <td>0.00</td> <td>0.06</td> <td>0.09</td> <td>%</td> </tr> <tr> <td></td> <td>IQ Offset</td> <td>0.03</td> <td>0.07</td> <td>0.11</td> <td>%</td> </tr> <tr> <td rowspan="5">Ext</td> <td rowspan="2">Channel</td> <td>Power Rel</td> <td>0.00</td> <td>0.00</td> <td>0.00</td> <td>dB</td> </tr> <tr> <td>Symbol EVM</td> <td>0.15</td> <td>0.21</td> <td>0.33</td> <td>%rms</td> </tr> <tr> <td>Modulation</td> <td></td> <td>BPSK</td> <td></td> <td></td> </tr> <tr> <td>Timing Offset</td> <td>---</td> <td>---</td> <td>---</td> <td>ns</td> </tr> <tr> <td>Phase Offset</td> <td>---</td> <td>---</td> <td>---</td> <td>mrad</td> </tr> <tr> <td></td> <td>Power Abs</td> <td>-7.40</td> <td>-7.39</td> <td>-7.39</td> <td>dBm</td> </tr> </tbody> </table>								Min	Average	Max	Unit	Carrier Frequency Error		-0.00	-0.00	-0.90	Hz	Carrier Frequency Error		-0.00	-0.00	-0.00	ppm	Chip Rate Error		0.00	0.07	0.40	ppm	Trigger to Frame		-99.7255	-99.7261	-99.8518	μs	Active Channels			9			Ext	PCG	Total Power	-0.40	-0.40	-0.39	dBm		Pilot Power	-7.40	-7.39	-7.39	dBm		RHO	0.99994	0.99995	0.99996		Trg		Composite EVM	0.65	0.68	0.76	%		IQ Imbalance	0.00	0.06	0.09	%		IQ Offset	0.03	0.07	0.11	%	Ext	Channel	Power Rel	0.00	0.00	0.00	dB	Symbol EVM	0.15	0.21	0.33	%rms	Modulation		BPSK			Timing Offset	---	---	---	ns	Phase Offset	---	---	---	mrad		Power Abs	-7.40	-7.39	-7.39	dBm	
		Min	Average	Max	Unit																																																																																																												
Carrier Frequency Error		-0.00	-0.00	-0.90	Hz																																																																																																												
Carrier Frequency Error		-0.00	-0.00	-0.00	ppm																																																																																																												
Chip Rate Error		0.00	0.07	0.40	ppm																																																																																																												
Trigger to Frame		-99.7255	-99.7261	-99.8518	μs																																																																																																												
Active Channels			9																																																																																																														
Ext	PCG	Total Power	-0.40	-0.40	-0.39	dBm																																																																																																											
		Pilot Power	-7.40	-7.39	-7.39	dBm																																																																																																											
		RHO	0.99994	0.99995	0.99996																																																																																																												
Trg		Composite EVM	0.65	0.68	0.76	%																																																																																																											
		IQ Imbalance	0.00	0.06	0.09	%																																																																																																											
		IQ Offset	0.03	0.07	0.11	%																																																																																																											
Ext	Channel	Power Rel	0.00	0.00	0.00	dB																																																																																																											
		Symbol EVM	0.15	0.21	0.33	%rms																																																																																																											
	Modulation		BPSK																																																																																																														
	Timing Offset	---	---	---	ns																																																																																																												
	Phase Offset	---	---	---	mrad																																																																																																												
	Power Abs	-7.40	-7.39	-7.39	dBm																																																																																																												
Sync OK																																																																																																																	

Abbildung 2-86: Result summary of the code domain measurement with the Trigger to Frame value

Measuring the Composite EVM

The Error Vector Magnitude (EVM) describes the quality of the measured signal compared to an ideal reference signal generated by the R&S FSL. In the I-Q plane, the error vector represents the ratio of the measured signal to the ideal signal on symbol level. The error vector is equal to the square root of the ratio of the measured signal to the reference signal. The result is given in %.

In the Composite EVM measurement the error is averaged over all channels (by means of the root mean square) for a given Power Control Group (PCG). The measurement covers the entire signal during the entire observation time. On screen the results are shown in a diagram, in which the x-axis represents the examined PCGs and the y-axis shows the EVM values.

Test Setup:

- Connect the RF output of the Signal Generator to the RF input of the R&S FSL (coaxial cables with N connectors).
- Connect the reference input (EXT REF IN/OUT) on the rear panel of the R&S FSL to the reference output (REF) on the signal generator (coaxial cable with BNC connectors).
- Connect external triggering of the analyzer (EXT TRIG GATE) to the signal generator's trigger (TRIGOUT1 at PAR DATA).

Signal generator settings:

Frequency: 878.49 MHz
Level: 0 dBm
Standard: CDMA2000

Procedure:

1. Set the R&S FSL to its default state.
 - Press the **PRESET** key.
2. Activate the CDMA2000 BTS Analyzer Mode.
 - Press the **MODE** key and select **CDMA2000 BTS Analyzer**.
3. Enter the Code Domain Analyzer.
 - Press the **MEAS** key
 - Press the **Code Domain Analyzer** softkey.
4. Start the measurement.
 - Press the **Select Meas** softkey
 - Press the **More ↓** softkey
 - Select the **Composite EVM** softkey and the measurement begins.
5. Enter the Settings Overview dialog box.
 - Press the **Settings** softkey.
 - Press the **Settings Overview** softkey.
 - The Settings Overview dialog box is displayed.
6. Set the center frequency and the reference level.
 - In the Settings Overview dialog box select the **Frontend** button.
 - In the **Center Frequency** field enter *878.49 MHz*.

- In the **Ref Level** field enter *10 dBm*.
 - Close the Frontend Settings dialog box.
7. Set an external trigger source.
- In the Settings Overview dialog box, select the **IQ Capture** button.
 - Set the **Trigger Source** radio button to **External**.
 - Close the Settings Overview box

In the two screens, the following results are displayed: by default, Screen A shows the diagram of the Composite EVM measurement result. In screen B the result summary is displayed. It shows the numeric results of the Code Domain Power measurement, including the values for the Composite EVM.

Measuring the Peak Code Domain Error and the RHO Factor

The Code Domain Error Power describes the quality of the measured signal compared to an ideal reference signal generated by the R&S FSL. In the I-Q plane, the error vector represents the difference of the measured signal and the ideal signal. The Code Domain Error is the difference in power on symbol level of the measured and the reference signal projected to the class of the base spreading factor. The unit of the result is dB.

In the Peak Code Domain Error (PCDE) measurement, the maximum error value over all channels is determined and displayed for a given PCG. The measurement covers the entire signal during the entire observation time. On screen the results are shown in a diagram, in which the x-axis represents the PCGs and the y-axis shows the PCDE values.

A measurement of the RHO factor is shown in the second part of the example. RHO is the normalized, correlated power between the measured and the ideal reference signal. The maximum value of RHO is 1. In that case the measured signal and the reference signal are identical. When measuring RHO, it is required that only the pilot channel is active.

Test setup:

- Connect the RF output of the signal generator to the RF input of the R&S FSL (coaxial cable with N connectors).
- Connect the reference input (EXT REF IN/OUT) on the rear panel of the R&S FSL to the reference output (REF) on the signal generator (coaxial cable with BNC connectors).
- Connect external triggering of the R&S FSL (EXT TRIG GATE) to the signal generator trigger (TRIGOUT1 at PAR DATA).

Signal generator settings:

Frequency: 878.49 MHz
Level: 0 dBm
Standard: CDMA2000

Procedure:

1. Set the R&S FSL to its default state.
 - Press the **PRESET** key.

2. Activate the CDMA2000 BTS Analyzer mode.
 - Press the **MODE** key and activate the **CDMA2000 BTS Analyzer** option.
3. Enter the Code Domain Analyzer.
 - Press the **MEAS** key.
 - Press the **Code Domain Analyzer** softkey.
4. Start the Peak Code Domain Error measurement.
 - Press the **Select Meas** softkey
 - Press the **More ↓** softkey
 - Select the **Peak Code Domain Error** softkey and start the measurement.
5. Enter the Settings Overview dialog box.
 - Press the **Settings** softkey.
 - Press the **Settings Overview** softkey.

The Settings Overview dialog box is displayed.
6. Set the center frequency and the reference level.
 - In the Settings Overview dialog box select the **Frontend** button.
 - In the **Center Frequency** field enter *878.49 MHz*.
 - In the **Ref Level** field enter *0 dBm*.
 - Close the Frontend Settings dialog box.
7. Set an external trigger source.
 - In the Settings Overview dialog box, select the **IQ Capture** button.
 - Set the **Trigger Source** radio button to **External**.
 - Close the Settings Overview box

In the two screens, the following results are displayed: by default, screen A shows the diagram of the Peak Code Domain Error. In screen B the result summary is displayed. It shows the numeric results of the code domain power measurement, but nothing specific about the Peak Code Domain Error.

Displaying RHO



Make sure that all channels except the pilot channel (code 0.64) are OFF, so that only the pilot channel is available in the measurement.

No specific measurement is required to get the value for RHO. The R&S FSL always calculates this value automatically regardless of the code domain measurement performed. Besides the results of the code domain measurements, the numeric result of the RHO measurement is shown in the result summary, by default shown in screen B.

Test Setup for Base Station Tests

This section describes the default settings of the R&S FSL, if it is used as a CDMA2000 base station tester. Before starting the measurements, the R&S FSL has to be configured correctly and supplied with power as described in the Quick Start Guide, "Preparing For Use". Furthermore, the application firmware of the R&S FSL-K82 must be enabled. Installation and enabling of the application firmware are described in chapter 4 "Instrument Functions". :

NOTICE

Risk of damage to the instrument

Before taking the instrument into operation, make sure that

- the housing covers are in place and their screws have been tightened,
- the ventilation slits are free,
- no signal voltage levels above the permissible limits are applied to the inputs,
- the outputs of the unit are not overloaded or wrongly connected.

Failure to comply may result in damage to the instrument.

Standard test setup:

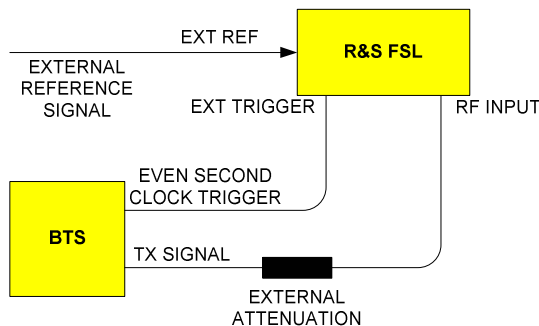

- Connect the antenna output (or TX output) of the base station to the RF input of the R&S FSL. Use power attenuator exhibiting suitable attenuation.

The following values for external attenuation are recommended to ensure that the RF input of the analyzer is protected and the sensitivity of the unit is not reduced too much:

Maximum Power	Recommended external attenuation
≥ 55 to 60 dBm	35 to 40 dB
≥ 50 to 55 dBm	30 to 35 dB
≥ 45 to 50 dBm	25 to 30 dB
≥ 40 to 45 dBm	20 to 25 dB
≥ 35 to 40 dBm	15 to 20 dB
≥ 30 to 35 dBm	10 to 15 dB
≥ 25 to 30 dBm	5 to 10 dB
≥ 20 to 25 dBm	0 to 5 dB
20 dBm	0 dB

- For signal measurements at the output of two-port networks, connect the reference frequency of the signal source to the rear reference input of the analyzer.
- The R&S FSL must be operated with an external frequency reference to ensure that the error limits of the CDMA2000 specification for frequency measurements on base stations are met. A rubidium frequency standard can be used as a reference source for example.
- If the base station has a trigger output, connect the trigger output of the base station to the rear trigger input of the analyzer (EXT TRIG GATE).

Presettings

Enter the external attenuation

Enter the reference level

Enter the center frequency

Set the trigger

If used, enable the external reference

Select the standard and the desired measurement

Set the PN offset

WLAN TX Measurements (Option K91 / K91n)

This section describes measurement examples for the WLAN TX Measurements option (K91 / K91n) and gives details to signal processing. For further information on measurement examples refer also to the Quick Start Guide, chapter 5 "Basic Measurement Examples".

This option is available from firmware version 1.20. The option R&S FSL-K91n is available from firmware version 1.90.

Signal Processing of the IEEE 802.11a application

Abbreviations

$a_{l,k}$	symbol at symbol l of sub carrier k
EVM_k	error vector magnitude of sub carrier k
EVM	error vector magnitude of current packet
g	signal gain
Δf	frequency deviation between Tx and Rx
l	symbol index $l = [1, \text{nof_Symbols}]$
nof_symbols	number of symbols of payload
H_k	channel transfer function of sub carrier k
k	channel index $k = [-31, 32]$
K_{mod}	modulation dependant normalization factor
ξ	relative clock error of reference oscillator
$r_{l,k}$	sub carrier k of symbol l

This description gives a rough view of the IEEE 802.11a application signal processing. Details are disregarded in order to get a concept overview.

A diagram of the interesting blocks is shown in [Fig. 2-87](#) First the RF signal is down converted to the IF frequency $f_{IF} = 20.4$ MHz. The resulting IF signal $r_{IF}(t)$ is shown on the left-hand side of the figure. After bandpass filtering, the signal is sampled by an Analog to Digital Converter (ADC) at a sampling rate of $f_{s1} = 81.6$ MHz. This digital sequence is resampled to the new sampling frequency of $f_{s2} = 80$ MHz which is a multiple of the Nyquist rate (20 MHz). The subsequent digital down converter shifts the IF signal to the complex base band. In the next step the base band signal is filtered by a FIR filter. To get an idea, the rough transfer function is plotted in the figure. This filter fulfills two tasks: first it suppresses the IF image frequency, secondly it attenuates the aliasing frequency bands caused by the subsequent down sampling. After filtering, the sequence is sampled down by the factor of 4. Thus the sampling rate of the down sampled sequence $r(i)$ is the Nyquist rate of $f_{s3} = 20$ MHz. Up to this point the digital part is implemented in an ASIC.

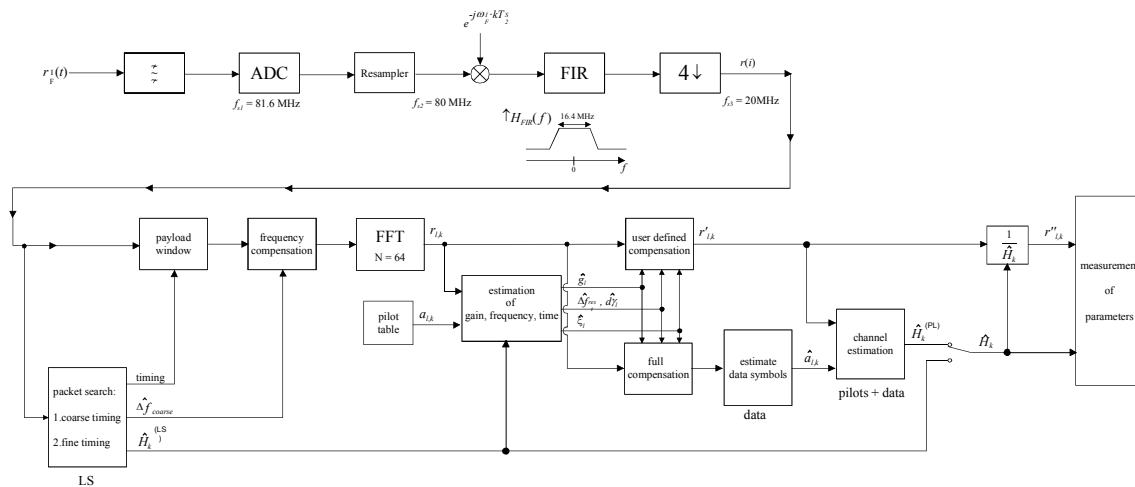

Fig. 2-87 Signal processing of the IEEE 802.11a application

In the lower part of the figure the subsequent digital signal processing is shown. In the first block the packet search is performed. This block detects the Long Symbol (LS) and recovers the timing. The coarse timing is detected first. This search is implemented in the time domain. The algorithm is based on cyclic repetition within the LS after $N = 64$ samples. Numerous treatises exist on this subject, e.g. [1] to [3]. Furthermore a coarse estimate $\hat{\Delta f}_{coarse}^1$ of the Rx-Tx frequency offset Δf is derived from the metric in [6]. This can easily be understood because the phase of $r(i) \cdot r^*(i + N)$ is determined by the frequency offset. As the frequency deviation Δf can exceed half a bin (distance between neighbor sub-carriers) the preceding Short Symbol (SS) is also analyzed in order to detect the ambiguity.

After the coarse timing calculation the time estimate is improved by the fine timing calculation. This is achieved by first estimating the coarse frequency response $\hat{H}_k^{(LS)}$, with $k = [-26, 26]$ denoting the channel index of the occupied sub-carriers. First the FFT of the LS is calculated. After the FFT calculation the known symbol information of the LS sub-carriers is removed by dividing by the symbols. The result is a coarse estimate \hat{H}_k of the channel transfer function. In the next step the complex channel impulse response is computed by an IFFT. Next the energy of the windowed impulse response (the window size is equal to the guard period) is calculated for every trial time. Afterwards the trial time of the maximum energy is detected. This trial time is used to adjust the timing.

Now the position of the LS is known and the starting point of the useful part of the first payload symbol can be derived. In the next block this calculated time instant is used to position the payload window. Only the payload part is windowed. This is sufficient because the payload is the only subject of the subsequent measurements.

In the next block the windowed sequence is compensated by the coarse frequency estimate $\hat{\Delta f}_{coarse}$. This is necessary because otherwise inter channel interference (ICI) would occur in the frequency domain.

The transition to the frequency domain is achieved by an FFT of length 64. The FFT is performed symbol-wise for every of the *nof_symbols* symbols of the payload. The calculated FFTs are described by $r_{l,k}$ with

the symbol index $l = [1, nof_symbols]$ and

the channel index $k = [-31, 32]$.

In case of an additive white Gaussian noise (AWGN) channel the FFT is described by [4], [5]

¹ The hat generally describes an estimate. Example: \hat{x} is the estimate of x.

$$r_{l,k} = K_{\text{mod}} \times a_{l,k} \times g_l \times H_k \times e^{j(\text{phase}_l^{(\text{common})} + \text{phase}_{l,k}^{(\text{timing})})} + n_{l,k} \quad (10)$$

with

the modulation-dependant normalization factor K_{mod} ,

the symbol $a_{l,k}$ of sub-carrier k at symbol l ,

the gain g_l at the symbol l in relation to the reference gain $g = 1$ at the long symbol (LS),

the channel frequency response H_k at the long symbol (LS),

the common phase drift $\text{phase}_l^{(\text{common})}$ of all sub-carriers at symbol l (see below),

the phase $\text{phase}_{l,k}^{(\text{timing})}$ of sub-carrier k at symbol l caused by the timing drift (see below),

the independent Gaussian distributed noise samples $n_{l,k}$.

The common phase drift in equation (10) is given by

$$\text{phase}_l^{(\text{common})} = 2\pi \times N_s / N \times \Delta f_{\text{rest}} T \times l + d\gamma_l \quad (11)$$

with

$N_s = 80$ being the number of Nyquist samples of the symbol period,

$N = 64$ being the number of Nyquist samples $N = 64$ of the useful part of the symbol,

Δf_{rest} being the (not yet compensated) frequency deviation,

$d\gamma_l$ being the phase jitter at the symbol l .

In general, the coarse frequency estimate $\hat{\Delta f}_{\text{coarse}}$ (see figure 1) is not error-free. Therefore the remaining frequency error Δf_{rest} represents the not yet compensated frequency deviation in $r_{l,k}$. Consequently the overall frequency deviation of the device under test (DUT) is calculated by $\Delta f = \hat{\Delta f}_{\text{coarse}} + \Delta f_{\text{rest}}$. Remark: The only motivation for dividing the common phase drift in equation (11) into two parts is to be able to calculate the overall frequency deviation of the DUT.

The reason for the phase jitter $d\gamma_l$ in equation (11) may be different. The nonlinear part of the phase jitter may be caused by the phase noise of the DUT oscillator. Another reason for nonlinear phase jitter may be the increase of the DUT amplifier temperature at the beginning of the burst. Please note that besides the nonlinear part the phase jitter $d\gamma_l$ also contains a constant part. This constant part is caused by the not yet compensated frequency deviation Δf_{rest} . To understand this, please keep in mind that the measurement of the phase starts at the first symbol $l = 1$ of the payload. In contrast the channel frequency response H_k in equation (10) represents the channel at the long symbol of the preamble. Consequently the not yet compensated frequency deviation Δf_{rest} produces a phase drift between the long symbol and the first symbol of the payload. Therefore this phase drift appears as a constant value ("DC value") in $d\gamma_l$.

Referring to the IEEE 802.11a measurement standard *Chapter 17.3.9.7 "Transmit modulation accuracy test"* [6], the common phase drift $\text{phase}_l^{(\text{common})}$ must be estimated and compensated from the pilots. Therefore this "symbol wise phase tracking" (Tracking Phase) is activated as the default setting of the R&S FSL-K91 / K91n.

Furthermore the timing drift in equation (10) is given by

$$\text{phase}_{l,k}^{(\text{timing})} = 2\pi \times N_s / N \times \xi \times k \times l \quad (12)$$

with ξ being the relative clock deviation of the reference oscillator. Normally a symbol-wise timing jitter is negligible and thus not modeled in equation (12). There may be situations where the timing drift has to be taken into account. This is illustrated by an example: In accordance to [6] the allowed clock deviation of the DUT is up to $\xi_{\max} = 20$ ppm. Furthermore a long packet with $\text{nof_symbols} = 400$ symbols is assumed. From equations (10) and (12), it results that the phase drift of the highest sub-carrier $k = 26$ in the last symbol $l = \text{nof_symbols}$ is 93 degrees. Even in the noise-free case, this would lead to symbol errors. The example shows that it is actually necessary to estimate and compensate the clock deviation, which is accomplished in the next block.

Referring to the IEEE 802.11a measurement standard [6], the timing drift $\text{phase}_{l,k}^{(\text{timing})}$ is not part of the requirements. Therefore the "time tracking" (Tracking Time) is not activated as the default setting of the R&S FSL-K91 / K91n.

The time tracking option should rather be seen as a powerful analyzing option.

In addition the tracking of the gain g_l in equation (10) is supported for each symbol in relation to the reference gain $g = 1$ at the time instant of the long symbol (LS). At this time the coarse channel transfer function $\hat{H}_k^{(LS)}$ is calculated. This makes sense since the sequence $r'_{l,k}$ is compensated by the coarse channel transfer function $\hat{H}_k^{(LS)}$ before estimating the symbols. Consequently a potential change of the gain at the symbol l (caused, for example, by the increase of the DUT amplifier temperature) may lead to symbol errors especially for a large symbol alphabet M of the MQAM transmission. In this case the estimation and the subsequent compensation of the gain are useful.

Referring to the IEEE 802.11a measurement standard [6], the compensation of the gain g_l is not part of the requirements. Therefore the "gain tracking" (Tracking Gain) is not activated as the default setting of the R&S FSL-K91 / K91n.

How can the parameters above be calculated? In this application the optimum maximum likelihood algorithm is used. In the first estimation step the symbol-independent parameters Δf_{rest} and ξ are estimated. The symbol dependent parameters can be neglected in this step i.e. the parameters are set to $g_l = 1$ and $d\gamma_l = 0$. Referring to equation (10) the log likelihood function²

$$L_1(\tilde{\Delta f}_{rest}, \tilde{\xi}) = \sum_{l=1}^{\text{nof_symbols}} \sum_{k=-21,-7,7,21} \left| r_{l,k} - a_{l,k} \times \hat{H}_k^{(LS)} \times e^{j(\tilde{\text{phase}}_l^{(\text{common})} + \tilde{\text{phase}}_{l,k}^{(\text{tim g})})} \right|^2 \quad (13)$$

with

$$\tilde{\text{phase}}_l^{(\text{common})} = 2\pi \times N_s / N \times \tilde{\Delta f}_{rest} T \times l$$

$$\tilde{\text{phase}}_l^{(\text{tim g})} = 2\pi \times N_s / N \times \tilde{\xi} \times k \times l$$

must be calculated as a function of the trial parameters $\tilde{\Delta f}_{rest}$ and $\tilde{\xi}$. The trial parameters leading to the minimum of the log likelihood function are used as estimates $\hat{\Delta f}_{rest}$ and $\hat{\xi}$. In equation (13)(13) the known pilot symbols $a_{l,k}$ are read from a table.

In the second step for every symbol l the log likelihood function

$$L_2(\tilde{g}_l, d\tilde{\gamma}_l) = \sum_{k=-21,-7,7,21} \left| r_{l,k} - a_{l,k} \times \tilde{g}_l \times \hat{H}_k^{(LS)} \times e^{j(\tilde{\text{phase}}_l^{(\text{common})} + \tilde{\text{phase}}_{l,k}^{(\text{tim g})})} \right|^2$$

with

$$\tilde{\text{phase}}_l^{(\text{common})} = 2\pi \times N_s / N \times \hat{\Delta f}_{rest} T \times l + d\tilde{\gamma}_l$$

$$\tilde{\text{phase}}_l^{(\text{tim g})} = 2\pi \times N_s / N \times \hat{\xi} \times k \times l$$

² The tilde generally describes an estimate. Example: \tilde{x} is the trial parameter of x .

is calculated as a function of the trial parameters \tilde{g}_l and $d\tilde{\gamma}_l$. Finally, the trial parameters leading to the minimum of the log likelihood function are used as estimates \hat{g}_l and $d\hat{\gamma}_l$.

This robust algorithm works well even at low signal to noise ratios with the Cramer Rao Bound being reached.

After estimation of the parameters, the sequence $r_{l,k}$ is compensated in the compensation blocks.

In the upper analyzing branch the compensation is user-defined i.e. the user determines which of the parameters are compensated. This is useful in order to extract the influence of these parameters. The resulting output sequence is described by $r'_{l,k}$.

In the lower compensation branch the full compensation is always performed. This separate compensation is necessary in order to avoid symbol errors. After the full compensation the secure estimation of the data symbols $\hat{a}_{l,k}$ is performed. From equation (10) it is clear that first the channel transfer function H_k must be removed. This is achieved by dividing the known coarse channel estimate $\hat{H}_k^{(LS)}$ calculated from the LS. Usually an error free estimation of the data symbols can be assumed.

In the next block a better channel estimate $\hat{H}_k^{(PL)}$ of the data and pilot sub-carriers is calculated by using all *nof_symbols* symbols of the payload (PL). This can be accomplished at this point because the phase is compensated and the data symbols are known. The long observation interval of *nof_symbols* symbols (compared to the short interval of 2 symbols for the estimation of $\hat{H}_k^{(LS)}$) leads to a nearly error-free channel estimate.

In the following equalizer block $r'_{l,k}$ is compensated by the channel estimate. The resulting channel-compensated sequence is described by $r''_{l,k}$. The user may either choose the coarse channel estimate $\hat{H}_k^{(LS)}$ (from the long symbol) or the nearly error-free channel estimate $\hat{H}_k^{(PL)}$ (from the payload) for equalization. In case of using the improved estimate $\hat{H}_k^{(PL)}$ a 2 dB reduction of the subsequent EVM measurement can be expected.

According to the IEEE 802.11a measurement standard [6], the coarse channel estimation $\hat{H}_k^{(LS)}$ (from the long symbol) has to be used for equalization. Therefore the default setting of the R&S FSL-K91 / K91n is equalization from the coarse channel estimate derived from the long symbol.

In the last block the measurement variables are calculated. The most important variable is the error vector magnitude

$$EVM_k = \sqrt{\frac{1}{nof_symbols} \sum_{l=1}^{nof_symbols} |r''_{l,k} - K_{mod} \times a_{l,k}|^2} \quad (14)$$

of the sub-carrier k of the current packet. Furthermore the packet error vector magnitude

$$EVM = \sqrt{\frac{1}{52} \sum_{k=-26(k \neq 0)}^{26} EVM_k^2} \quad (15)$$

is derived by averaging the squared EVM_k versus k . Finally the average error vector magnitude

$$\overline{EVM} = \sqrt{\frac{1}{nof_packets} \sum_{counter=1}^{nof_packets} EVM^2(counter)} \quad (16)$$

is calculated by averaging the packet EVM of all *nof_packets* detected packets. This parameter is equivalent to the so-called "RMS average of all errors $Error_{RMS}$ " of the IEEE 802.11a measurement commandment (see [6], Chapter 17.3.9.7).

Literature

- [1] Speth, Classen, Meyr: "Frame synchronization of OFDM systems in frequency selective fading channels", VTC '97, pp. 1807-1811
- [2] Schmidl, Cox: "Robust Frequency and Timing Synchronization of OFDM", IEEE Trans. on Comm., Dec. 1997, pp. 1613-621
- [3] Minn, Zeng, Bhargava: "On Timing Offset Estimation for OFDM", IEEE Communication Letters, July 2000, pp. 242-244
- [4] Speth, Fechtel, Fock, Meyr: "Optimum Receiver Design for Wireless Broad-Band Systems Using OFDM - Part I", IEEE Trans. On Comm. VOL. 47, NO 11, Nov. 1999
- [5] Speth, Fechtel, Fock, Meyr: "Optimum Receiver Design for Wireless Broad-Band Systems Using OFDM - Part II", IEEE Trans. On Comm. VOL. 49, NO 4, April. 2001
- [6] IEEE 802.11a, Part 11: Wireless LAN Medium Access Control (MAC) and Physical Layer (PHY) specifications

Signal Processing of the IEEE 802.11b application

Abbreviations

ε	timing offset
Δf	frequency offset
$\Delta \phi$	phase offset
$ARG\{\dots\}$	calculation of the angle of a complex value
EVM	error vector magnitude
\hat{g}_I	estimate of the gain factor in the I-branch
\hat{g}_Q	estimate of the gain factor in the Q-branch
$\Delta \hat{g}_Q$	accurate estimate of the crosstalk factor of the Q-branch in the I-branch
$\hat{h}_s(v)$	estimated baseband filter of the transmitter
$\hat{h}_r(v)$	estimated baseband filter of the receiver
$\hat{\delta}_I$	estimate of the IQ-offset in the I-branch
$\hat{\delta}_Q$	estimate of the IQ-offset in the I-branch
$r(v)$	measurement signal
$\hat{s}(v)$	estimate of the reference signal
$\hat{s}_n(v)$	estimate of the power normalized and undisturbed reference signal
$REAL\{\dots\}$	calculation of the real part of a complex value
$IMAG\{\dots\}$	calculation of the imaginary part of a complex value

This description gives a rough overview of the signal processing concept of the IEEE 802.11b application.

A block diagram of the measurement application is shown in Fig. 2-88. The baseband signal of an IEEE 802.11b wireless LAN system transmitter is sampled with a sampling rate of 44 MHz.

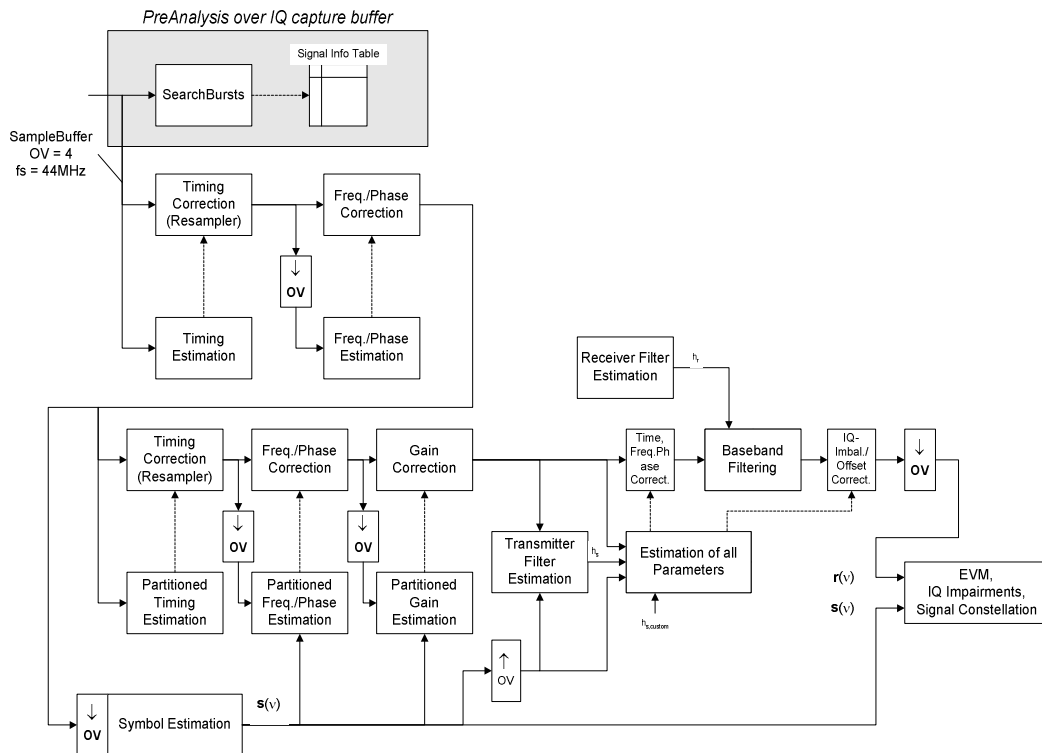

Fig. 2-88 Signal processing of the IEEE 802.11b application

The first task of the measurement application is to detect the position of the bursts within the measurement signal $r_1(v)$. The detection algorithm is able to find the positions of the beginning of short and long bursts and can distinguish between them. The algorithm also detects the initial state of the scrambler. This is required if IEEE 802.11 signals should be analyzed, because this standard does not specify the initial state of the scrambler.

With the knowledge of the start position of the burst, the header of the burst can be demodulated. The bits transmitted in the header provide information about the length of the burst and the modulation type used in the PSDU.

After the start position and the burst length is fully known, better estimates of timing offset, timing drift, frequency offset and phase offset can be calculated using the entire data of the burst.

At this point of the signal processing a demodulation can be performed without decision error. After demodulation the normalized and undisturbed reference signal $s(v)$ is available.

If the frequency offset is not constant and varies with time, the frequency- and phase offset in several partitions of the burst must be estimated and corrected. Additionally, timing offset, timing drift and gain factor can be estimated and corrected in several partitions of the burst. These corrections can be separately switched off in the demodulation settings menu.

Knowing the normalized power and undisturbed reference signal, the transmitter baseband filter is estimated by minimizing the cost function

$$L_1 = \sum_{v=0}^{N-1} \left| r(v) \times e^{-j2\pi\tilde{f}v} \times e^{-j\Delta\tilde{\phi}} - \sum_{i=-L}^{+L} \tilde{h}_s(i) \times \hat{s}_n(v-i) - \tilde{o}_I - j\tilde{o}_Q \right|^2 \quad (17)$$

of a maximum-likelihood-based estimator, where $r(v)$ is the over sampled measurement signal, $\hat{s}_n(v)$ the over sampled power normalized and undisturbed reference signal, N the observation length, L the filter length, $\tilde{\Delta f}$, $\Delta\tilde{\phi}$, \tilde{o}_I , \tilde{o}_Q and $\tilde{h}_s(v)$ the variation parameters of the frequency-, the phase, the IQ-offset and the coefficients of the transmitter filter. The frequency-, the phase- and the IQ-offset are estimated jointly with the coefficients of the transmitter filter to increase the estimation quality.

Once the transmitter filter is known, all other unknown signal parameters are estimated with a maximum-likelihood-based estimation, which minimizes the cost function

$$L_2 = \sum_{v=0}^{N-1} \left| r(v - \tilde{\epsilon}) \times e^{-j2\pi\tilde{f}v} \times e^{-j\Delta\tilde{\phi}} - \tilde{g}_I \times s_I(v) - j\tilde{g}_Q \times s_Q(v) + \Delta\tilde{g}_Q \times s_Q(v) - \tilde{o}_I - j\tilde{o}_Q \right|^2 \quad (18)$$

where \tilde{g}_I resp. \tilde{g}_Q are the variation parameters of the gain used in the I- resp. the Q-branch, $\Delta\tilde{g}_Q$ is the crosstalk factor of the Q-branch into the I-branch and $s_I(v)$ resp. $s_Q(v)$ are the filtered reference signal of the I- resp. the Q-branch. The unknown signal parameters are estimated in a joint estimation process to increase the accuracy of the estimates.

The accurate estimates of the frequency offset, the IQ-imbalance, the quadratur-mismatch and the normalized IQ-offset are displayed by the measurement software. The IQ-imbalance

$$IQ-Imbalance = \left| \frac{\tilde{g}_Q + \Delta\tilde{g}_Q}{\tilde{g}_I} \right| \quad (19)$$

is the quotient of the estimates of the gain factor of the Q-branch, the crosstalk factor and the gain factor of the I-branch, the quadrature-mismatch

$$Quadrature - Mismatch = ARG\{\tilde{g}_Q + j \times \Delta\tilde{g}_Q\} \quad (20)$$

is a measure for the crosstalk of the Q-branch into the I-branch. The normalized IQ-offset

$$IQ-Offset = \frac{\sqrt{\hat{o}_I^2 + \hat{o}_Q^2}}{\sqrt{\frac{1}{2} \cdot [\hat{g}_I^2 + \hat{g}_Q^2]}} \quad (21)$$

is defined as the magnitude of the IQ-offset normalized by the magnitude of the reference signal.

At this point of the signal processing all unknown signal parameters such as timing-, frequency-, phase-, IQ-offset and IQ-imbalance have been evaluated and the measurement signal can be corrected accordingly.

Using the corrected measurement signal $r(v)$ and the estimated reference signal $\hat{s}(v)$ the modulation quality parameters can be calculated. The mean error vector magnitude (EVM)

$$EVM = \frac{\sqrt{\sum_{v=0}^{N-1} |r(v) - \hat{s}(v)|^2}}{\sqrt{\sum_{v=0}^{N-1} |\hat{s}(v)|^2}} \quad (22)$$

is the quotient of the root-mean-square values of the error signal power and the reference signal power, whereas the instant error vector magnitude

$$EVM(v) = \frac{|r(v) - \hat{s}(v)|}{\sqrt{\sum_{v=0}^{N-1} |\hat{s}(v)|^2}} \quad (23)$$

is the momentary error signal magnitude normalized by the root mean square value of the reference signal power.

In [2] a different algorithm is proposed to calculate the error vector magnitude. In a first step the IQ-offset in the I-branch

$$\hat{o}_I = \frac{1}{N} \sum_{v=0}^{N-1} \text{REAL}\{r(v)\} \quad (24)$$

and the IQ-offset of the Q-branch

$$\hat{o}_Q = \frac{1}{N} \sum_{v=0}^{N-1} \text{IMAG}\{r(v)\} \quad (25)$$

are estimated separately, where $r(v)$ is the measurement signal which has been corrected with the estimates of the timing-, frequency- and phase offset, but not with the estimates of the IQ-imbalance and IQ-offset. With these values the IQ-imbalance of the I-branch

$$\hat{g}_I = \frac{1}{N} \sum_{v=0}^{N-1} |\text{REAL}\{r(v) - \hat{o}_I\}| \quad (26)$$

and the IQ-imbalance of the Q-branch

$$\hat{g}_Q = \frac{1}{N} \sum_{v=0}^{N-1} |\text{IMAG}\{r(v) - \hat{o}_Q\}| \quad (27)$$

are estimated in a non-linear estimation in a second step. Finally, the mean error vector magnitude

$$V_{\text{err}}(v) = \frac{\sqrt{\frac{1}{2} \sum_{v=0}^{N-1} [|\text{REAL}\{r(v)\} - \hat{o}_I| - \hat{g}_I]^2 + \frac{1}{2} \sum_{v=0}^{N-1} [|\text{IMAG}\{r(v)\} - \hat{o}_Q| - \hat{g}_Q]^2}}{\sqrt{\frac{1}{2} \cdot [\hat{g}_I^2 + \hat{g}_Q^2]}} \quad (28)$$

can be calculated with a non data aided calculation. The instant error vector magnitude

$$V_{\text{err}}(v) = \frac{\sqrt{\frac{1}{2} [|\text{REAL}\{r(v)\} - \hat{o}_I| - \hat{g}_I]^2 + \frac{1}{2} [|\text{IMAG}\{r(v)\} - \hat{o}_Q| - \hat{g}_Q]^2}}{\sqrt{\frac{1}{2} \cdot [\hat{g}_I^2 + \hat{g}_Q^2]}} \quad (29)$$

is the error signal magnitude normalized by the root mean square value of the estimate of the measurement signal power. The advantage of this method is that no estimate of the reference signal is needed, but the IQ-offset and IQ-imbalance values are not estimated in a joint estimation procedure. Therefore, each estimation parameter is disturbing the estimation of the other parameter and the accuracy of the estimates is lower than the accuracy of the estimations achieved by equation (17). If the EVM value is dominated by Gaussian noise this method yields similar results as equation (18).

Literature

- [1] Institute of Electrical and Electronic Engineers, *Part 11: Wireless LAN Medium Access Control (MAC) and Physical Layer (PHY) specifications*, IEEE Std 802.11-1999, Institute of Electrical and Electronic Engineers, Inc., 1999.
- [2] Institute of Electrical and Electronic Engineers, *Part 11: Wireless LAN Medium Access Control (MAC) and Physical Layer (PHY) specifications: Higher-Speed Physical Layer Extensions in the 2.4 GHz Band*, IEEE Std 802.11b-1999, Institute of Electrical and Electronic Engineers, Inc., 1999.

802.11b RF carrier suppression

Definition

The RF carrier suppression, measured at the channel center frequency, shall be at least 15 dB below the peak SIN(x)/x power spectrum. The RF carrier suppression shall be measured while transmitting a repetitive 01 data sequence with the scrambler disabled using DQPSK modulation. A 100 kHz resolution bandwidth shall be used to perform this measurement.

Measurement with the R&S FSL

The RF carrier suppression as defined in the standard is a determination of peak ratios. The unscrambled 01 data sequence provides a spectrum with distinct peaks enveloped by the transmit filter spectrum. An IQ offset leads to an additional peak at the center frequency.

The following measurement sequence can be used in normal spectrum mode:

1. Use power trigger or external trigger
1. Use gated sweep with gate delay at payload start and gate length = payload length (Delay-Comp ON and RBW = 50 MHz for gate settings)
2. Set RBW = 100 kHz
3. Set Sweep Time = 100 ms
4. Set Span = 20 MHz
5. Set Detector = RMS
6. Set Marker 1 to center frequency
7. Use Marker 2 as Delta Marker and set it to max. peak

Fig. 2-89 is a screenshot of this measurement. The delta marker shows directly the RF carrier suppression in dB (white circled value).

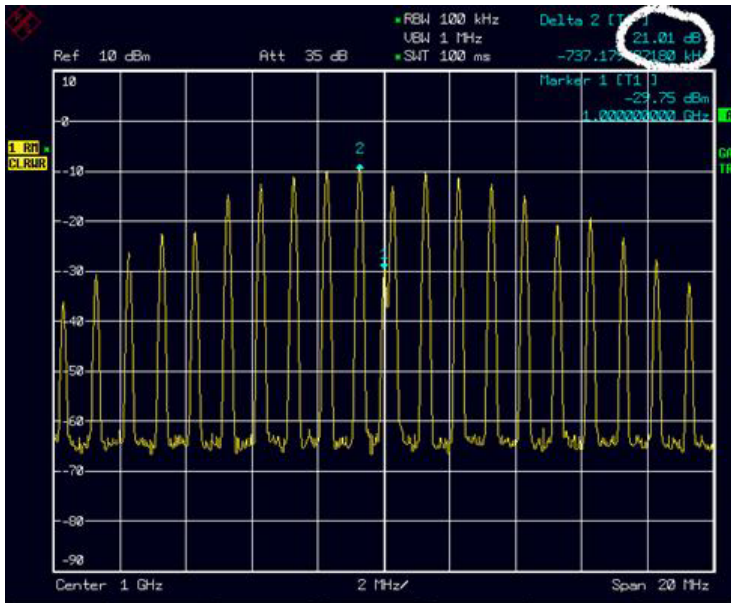

Fig. 2-89 RF carrier suppression measurement

Comparison to IQ offset measurement in K91 / K91n list mode

The IQ offset measurement in K91 / K91n returns the actual carrier feed through normalized to the mean power at the symbol timings. This measurement doesn't need a special test signal and is independent of the transmit filter shape.

The RF carrier suppression measured according to the standard is inversely proportional to the IQ offset measured in K91 / K91n list mode. The difference (in dB) between the two values depends on the transmit filter shape and should be determined with one reference measurement.

The following table lists exemplary the difference for three transmit filter shapes (± 0.5 dB):

Transmit filter	-IQ-Offset [dB] - RF-Carrier-Suppression [dB]
rectangular	11 dB
Root raised cosine, $\alpha = 0.22$	10 dB
Gaussian, $\alpha = 0.3$	9 dB

IQ Impairments

IQ Offset

An IQ-Offset indicates a carrier offset with fixed amplitude. This results in a constant shift of the IQ axes. The offset is normalized by the mean symbol power and displayed in dB.

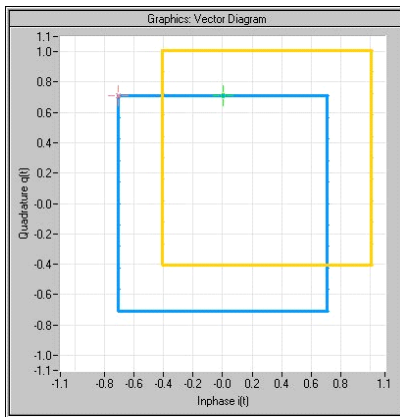

Gain Imbalance

An ideal I/Q modulator amplifies the I and Q signal path by exactly the same degree. The imbalance corresponds to the difference in amplification of the I and Q channel and therefore to the difference in amplitude of the signal components. In the vector diagram, the length of the I vector changes relative to the length of the Q vector.

The entry is displayed in dB and %, where 1 dB offset is roughly 12 % according to the following:

$$\text{Imbalance [dB]} = 20 \log (| \text{Gain}_Q | / | \text{Gain}_I |)$$

Positive values mean that the Q vector is amplified more than the I vector by the corresponding percentage:

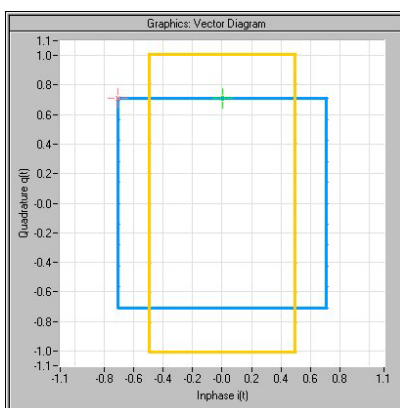

Negative values mean that the I vector is amplified more than the Q vector by the corresponding percentage:

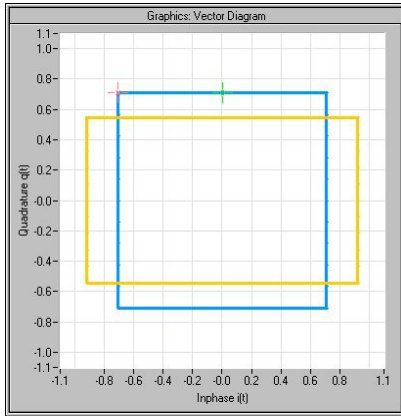

Quadrature Error

An ideal I/Q modulator sets the phase angle to exactly 90 degrees. With a quadrature error, the phase angle between the I and Q vector deviates from the ideal 90 degrees, the amplitudes of both components are of the same size. In the vector diagram, the quadrature error causes the coordinate system to shift.

A positive quadrature error means a phase angle greater than 90 degrees:

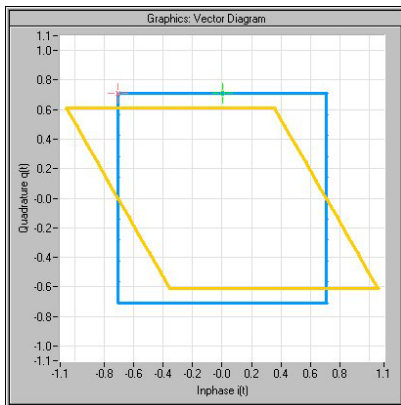

A negative quadrature error means a phase angle less than 90 degrees:

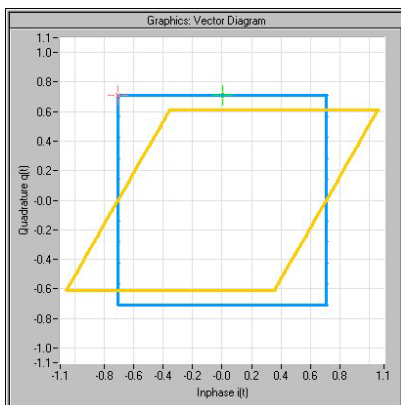

WiMAX, WiBro Measurements (Options K92/K93)

This section describes measurement examples for the WiMAX IEEE 802.16 OFDM, OFDMA Measurements option (R&S FSL-K93) and gives details to signal processing. For further information on measurement examples refer also to the Quick Start Guide, chapter 5 "Basic Measurement Examples".

The WiMAX IEEE 802.16 OFDM, OFDMA Measurements option (R&S FSL-K92/K93) includes the functionality of the WiMAX 802.16 OFDM Measurements option (R&S FSL-K92). Accordingly both options are described together in this section, differentiated by the corresponding standards:

- WiMAX 802.16 OFDM Measurements (R&S FSL-K92/K93)
 - IEEE 802.16-2004/Cor 1-2005 OFDM physical layer mode
The corresponding remote control mode is *OFDM*. In chapter 2, "Instrument Functions", the short form *IEEE 802.16-2004 OFDM* is used to reference this standard.
- WiMAX IEEE 802.16 OFDM, OFDMA Measurements option (R&S FSL-K93)
 - IEEE 802.16-2004/Cor 1-2005, IEEE 802.16e-2005 OFDMA physical layer mode
The corresponding remote control mode is *OFDMA*. In chapter 2, "Instrument Functions", the short form *IEEE 802.16e-2005 OFDMA* is used to reference this standard.
 - IEEE 802.16-2004/Cor 1-2005, IEEE 802.16e-2005 based WiBro
The corresponding remote control mode is *WiBro*. In chapter 2, "Instrument Functions", the short form *IEEE 802.16e-2005 WiBro* is used to reference this standard.

The options are available from firmware version 1.40 (R&S FSL-K92) and 1.50 (R&S FSL-K93).

Basic Measurement Example

This section provides step-by-step instructions for working through an ordinary measurement. The following steps are described:

1. Setting up the measurement
2. Performing the level detection
3. Performing the main measurement

Test setup

In this example, a DUT using IEEE 802.16-2004 is be used.

- Connect the DUT to the R&S FSL using the RF input of the R&S FSL. The DUT generates a signal modulated using 16QAM 2/3.

Setting up the measurement

1. Activate the **WIMAX** mode (for details refer to chapter "Instrument Functions", section "Measurement Mode Selection - MODE Key").
2. Press the **Settings General/Demod** softkey once to select and open the **General Settings** dialog box.

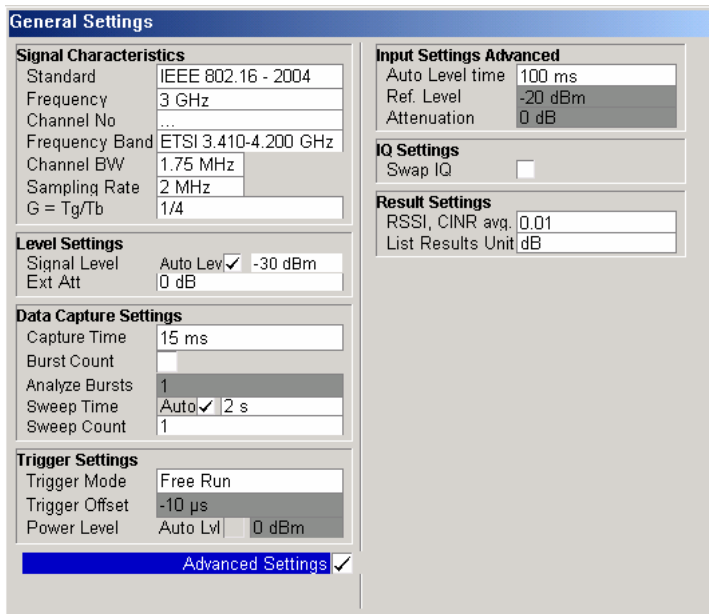

- In the **Frequency** field, enter the desired frequency to measure.
If a frequency is entered, which maps to a specific channel, the **Channel No** field updates.
- In the **Frequency Band** field, select the signal to be analyzed. The target band is either one of the bands given as example in the IEEE 802.16-2004 standard³ or an unspecified band.
- In the **Channel BW** or **Sampling Rate** field depending on the characteristics of the signal to be analyzed, select a value. The second parameter is derived from the first according to the standard⁴.
- In the **G = Tg/Tb** field, select a useful time ratio according to the characteristics of the signal to be analyzed.
- Under **Level Settings**, deactivate the **Auto Lev** option. In this example, the level detection measurement is executed manually (for details see [Performing the level detection](#)).

3. Press the **Settings General/Demod** softkey twice to select and open the **Demod Settings** dialog box.

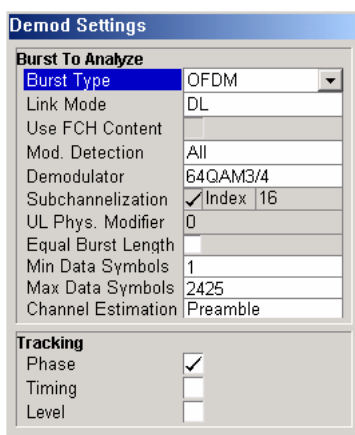

³ B.3.2 Wireless MAN-OFDM/OFDMA PHY symbol and performance parameters.

⁴ 8.3.2.2 Derived Parameter definitions

- In the **Link Mode** field, select the link mode of the bursts to be analyzed.
- In the **Demodulator** field, select the used modulation scheme.

Performing the level detection

1. Connect the DUT to the RF input of the R&S FSL.

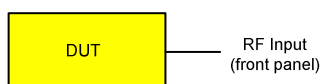

2. Start the level detection measurement by pressing the **SWEEP** hardkey and then the **Auto Level** softkey.

During the level detection measurement the status message **Running** is displayed in the status bar at the bottom of the screen.

After successful level detection, the status message **Measurement Complete** is displayed, the signal level field for the selected input displays the detected signal level and the Magnitude Capture Buffer (screen A) displays the zero span trace obtained during the measurement sequence.



An automatic level detection can be performed in two ways:

Once by pressing the **Auto Level** softkey in the sweep menu.

At the start of each measurement sweep by activating the **Auto Lev** option in the **General Settings** dialog box under **Level Settings**.

Performing the main measurement

1. Select single sweep measurements by pressing the **SWEEP** hardkey and then the **Run** softkey to select **Single**.
2. Start the measurement by pressing the **RUN** hardkey.

During the measurement, the status message **Running** is displayed.

Measurement results are updated once the measurement has completed. The results are displayed in graphical form. The display can be toggled to a tabular list of measurement points by pressing the **Display Graph/List** softkey (in the WiMAX/WiBro menu or trace menu).

Signal Processing of the IEEE 802.16-2004 OFDM Measurement Application

Abbreviation Description

$N_{FFT} = 256$	FFT length
$a_{l,k}$	symbol from the alphabet at symbol-index l of sub carrier k
EVM_k	error vector magnitude of sub carrier k
EVM	error vector magnitude of current packet
g	signal gain
Δf	frequency deviation between Tx and Rx

- l symbol index $l = [1, \text{nof_Symbols}]$
 - nof_symbols number of symbols of payload
 - H_k channel transfer function of sub carrier k
 - k channel index $k = [-128, 127]$
 - K_{mod} modulation dependent normalization factor
 - ξ relative clock error of reference oscillator
 - $r_{l,k}$ received symbol at symbol-index l of sub carrier k
- Pilots = {-88, -63, -38, -13, 13, 38, 63, 88}*

This description gives a rough view of the IEEE 802.16-2004 OFDM measurement application signal processing. Details are disregarded in order to get a concept overview.

A diagram of the interesting blocks is shown in Fig. 2-90. First the RF signal is down-converted to the IF frequency $f_{IF} = 20.4$ MHz. The resulting IF signal $r_{IF}(t)$ is shown on the left-hand side of the figure. After bandpass filtering, the signal is sampled by an Analog to Digital Converter (ADC) at a sampling rate of $f_{s1} = 81.6$ MHz. This digital sequence is resampled to the new sampling frequency of $f_{s2} = 80$ MHz which is a multiple of the Nyquist rate (20 MHz). The subsequent digital down-converter shifts the IF signal to the complex base band. In the next step the base band signal is filtered by a FIR filter. To get an idea, the rough transfer function is plotted in the figure. This filter fulfils two tasks: first it suppresses the IF image frequency, secondly it attenuates the aliasing frequency bands caused by the subsequent down-sampling. After filtering, the sequence is sampled down by the factor of 4. Thus the sampling rate of the down-sampled sequence $r(i)$ is the Nyquist rate of $f_{s3} = 20$ MHz. Up to this point the digital part is implemented in an ASIC.

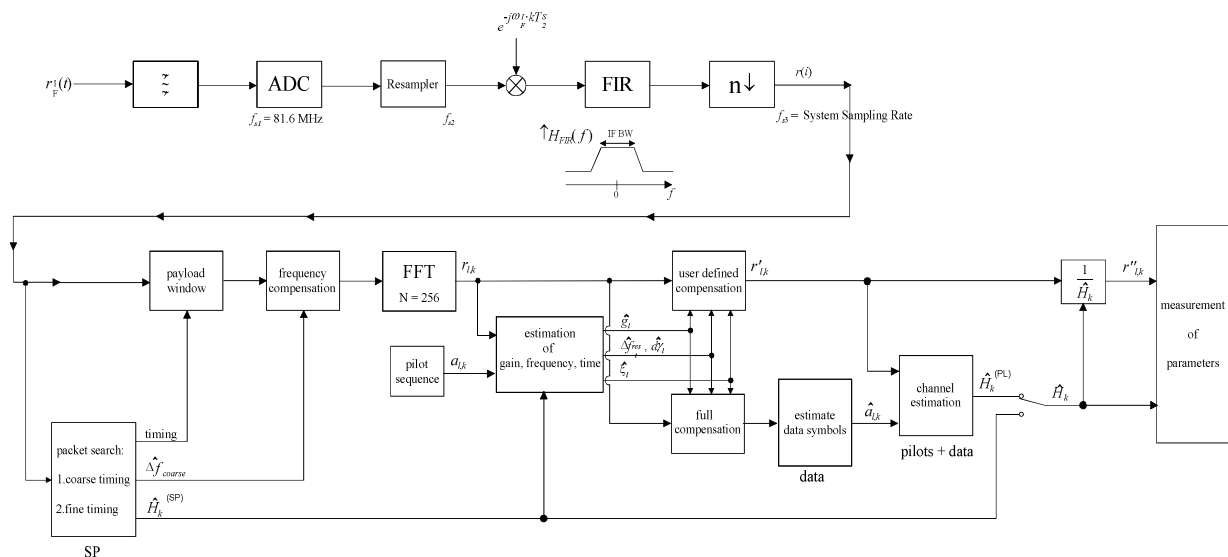

Fig. 2-90 Signal processing of the IEEE 802.16 OFDM measurement application

In the lower part of the figure the subsequent digital signal processing is shown. In the first block the packet search is performed. This block detects the Short Preamble (SP) and recovers the timing. The coarse timing is detected first. This search is implemented in the time domain. The algorithm is based on cyclic repetition within the SP after $N = N_{FFT} / 2 = 128$ samples. Note this cyclic repetition occurs also in the Long Preamble (LP). Numerous treatises exist on this subject, e.g. [1]-[3]. Furthermore a coarse

estimate $\hat{\Delta f}_{coarse}$ ⁵ of the Rx-Tx frequency offset Δf is derived from the metric in [6]. This can easily be understood because the phase of $r(i) \cdot r^*(i+N)$ is determined by the mod 2π frequency offset. As the frequency deviation Δf can exceed several bins (distance between neighbor sub-carriers) the SP is further used to solve this $n2\pi$ [offset over several bins] ambiguities.

After the coarse timing calculation the time estimate is improved by the fine timing calculation. This is achieved by first estimating the coarse frequency response $\hat{H}_k^{(SP)}$, with $k = [-100, 100]$ denoting the channel index of the occupied sub-carriers. First the FFT of the SP is calculated. After the FFT calculation the known symbol information of the SP sub-carriers is removed by dividing by the symbols. The result is a coarse estimate \hat{H}_k of the channel transfer function. In the next step the complex channel impulse response is computed by an IFFT. Next the energy of the windowed impulse response (the window size is equal to the guard period) is calculated for every trial time. Afterwards the trial time of the maximum energy is detected. This trial time is used to adjust the timing.

Now the position of the SP is known and the starting point of the useful part of the first payload symbol can be derived. In the next block this calculated time instant is used to position the payload window. Only the payload part is windowed. This is sufficient because the payload is the only subject of the subsequent measurements.

In the next block the windowed sequence is compensated by the coarse frequency estimate $\hat{\Delta f}_{coarse}$. This is necessary because otherwise inter channel interference (ICI) would occur in the frequency domain.

The transition to the frequency domain is achieved by an FFT of length 256. The FFT is performed symbol-wise for every of the *nof_symbols* symbols of the payload. The calculated FFTs are described by $r_{l,k}$ with

the symbol index $l = [1, nof_symbols]$ and

the channel index $k = [-128, 127]$.

In case of an additive white Gaussian noise (AWGN) channel the FFT is described by [4], [5]

$$r_{l,k} = K_{mod} \cdot a_{l,k} \cdot g_l \cdot H_k \cdot e^{j(\text{phase}_l^{(common)} + \text{phase}_{l,k}^{(timing)})} + n_{l,k} \quad (30)$$

with

the modulation-dependent normalization factor K_{mod}

the alphabet symbol $a_{l,k}$ at symbol-index l of sub-carrier k

the gain g_l at the symbol l in relation to the reference gain $g = 1$ at the Short Preamble (SP)

the channel frequency response H_k at the Short Preamble (SP)

the common phase drift $\text{phase}_l^{(common)}$ of all sub-carriers at symbol l (see below)

the phase $\text{phase}_{l,k}^{(timing)}$ of sub-carrier k at symbol l caused by the timing drift (see below)

the independent Gaussian distributed noise samples $n_{l,k}$

The common phase drift in equation (29) is given by

$$\text{phase}_l^{(common)} = 2\pi \cdot N_s / N \cdot \Delta f_{rest} \cdot T \cdot l + d\gamma_l \quad (31)$$

⁵ In this paper the hat generally describes an estimate. Example: \tilde{x} is the estimate of x .

with

$N_s = N_g + N_b$ being the number of Nyquist samples of the symbol period

$N = N_b = 256$ being the number of Nyquist samples of the useful part of the symbol

Δf_{rest} being the (not yet compensated) frequency deviation

$d\gamma_l$ being the phase jitter at the symbol l

In general, the coarse frequency estimate $\hat{\Delta f}_{coarse}$ (see Fig. 2-90) is not error-free. Therefore the remaining frequency error Δf_{rest} represents the not yet compensated frequency deviation in $r_{l,k}$. Consequently the overall frequency deviation of the device under test (DUT) is calculated by $\Delta f = \hat{\Delta f}_{coarse} + \Delta f_{rest}$. Remark: The only motivation for dividing the common phase drift in equation (11) into two parts is to be able to calculate the overall frequency deviation of the DUT.

The reason for the phase jitter $d\gamma_l$ in equation (11) may be different. The nonlinear part of the phase jitter may be caused by the phase noise of the DUT oscillator. Another reason for nonlinear phase jitter may be the increase of the DUT amplifier temperature at the beginning of the burst. Please note that besides the nonlinear part the phase jitter $d\gamma_l$ also contains a constant part. This constant part is caused by the not yet compensated frequency deviation Δf_{rest} . To understand this, please keep in mind that the measurement of the phase starts at the first symbol $l = 1$ of the payload. In contrast the channel frequency response H_k in equation (29) represents the channel at the Short Preamble of the preamble.

Consequently the not yet compensated frequency deviation Δf_{rest} produces a phase drift between the Short Preamble and the first symbol of the payload. Therefore this phase drift appears as a constant value ("DC value") in $d\gamma_l$.

Referring to the IEEE 802.16-2004 measurement standard Chapter 8.3.10.1.2 "Transmitter constellation error and test method" [6], the common phase drift $phase_l^{(common)}$ must be estimated and compensated from the pilots. Therefore the "symbol wise phase tracking" (Tracking Phase) is activated as the default setting of the R&S FSL-K92/K93.

Furthermore the timing drift in equation (29) is given by

$$phase_{l,k}^{(timing)} = 2\pi \cdot N_s / N \cdot \xi \cdot k \cdot l \quad (32)$$

with ξ being the relative clock deviation of the reference oscillator. Normally a symbol-wise timing jitter is negligible and thus not modeled in equation (32). There may be situations where the timing drift has to be taken into account. This is illustrated by an example: In accordance to [6] the allowed clock deviation of the DUT is up to $\xi_{max} = \pm 8$ ppm. Furthermore the maximal length of a frame $nof_symbols = 2420$ symbols⁶ is assumed. From equations (29) and (32), it results that the phase drift of the highest sub-carrier $k = 100$ in the last symbol $l = nof_symbols$ is to-do degrees. Even in the noise-free case, this would lead to symbol errors. The example shows that it is actually necessary to estimate and compensate the clock deviation, which is accomplished in the next block.

Referring to the IEEE 802.16-2004 measurement standard [6], the timing drift $phase_{l,k}^{(timing)}$ is not part of the requirements. Therefore the "time tracking" (Tracking Time) is not activated as the default setting of the R&S FSL-K92/K93.

The time tracking option should rather be seen as a powerful analyzing option.

In addition the tracking of the gain g_l in equation (29) is supported for each symbol in relation to the reference gain $g = 1$ at the time instant of the Short Preamble (SP). At this time the coarse channel

6 Assuming the maximal System Sampling Rate $F_s = 32$ MHz.

transfer function $\hat{H}_k^{(SP)}$ is calculated. This makes sense since the sequence $r'_{l,k}$ is compensated by the coarse channel transfer function $\hat{H}_k^{(SP)}$ before estimating the symbols. Consequently a potential change of the gain at the symbol l (caused, for example, by the increase of the DUT amplifier temperature) may lead to symbol errors especially for a large symbol alphabet M of the MQAM transmission. In this case the estimation and the subsequent compensation of the gain are useful.

Referring to the IEEE 802.16-2004 measurement standard [6], the compensation of the gain g_l is not part of the requirements. Therefore the "gain tracking" (Tracking Gain) is not activated as the default setting of the R&S FSL-K92/K93.

The unknown deviations of gain, frequency and time are calculated by an optimum maximum likelihood procedure, which works well even at low signal to noise ratios with the Cramer Rao Bound being reached. After estimation of these parameters, the received signal is fully compensated for the decision of the ideal reference signal $\hat{a}_{l,k}$ and compensated according to the user settings to get the measurement signal $r'_{l,k}$. Then the measurement signal is equalized by the inverse channel transfer function. According to the chosen setting, either the preamble estimation of the channel transfer function or a data aided estimation using the ideal reference signal is used. According to the IEEE 802.16-2004 measurement standard [6], the coarse channel estimation $\hat{H}_k^{(SP)}$ (from the short preamble) has to be used for equalization. Therefore the default setting of the R&S FSL-K92/K93 is equalization from the coarse channel estimate derived from the short preamble.

In the last block the measurement variables are calculated. The most important variable is the error vector magnitude

$$EVM_k = \sqrt{\frac{1}{\text{nof_Symbols}} \cdot \sum_{l=1}^{\text{nof_Symbols}} |r'_{l,k} - K_{\text{mod}} \cdot a_{l,k}|^2} \quad (33)$$

of the sub-carrier k of the current packet. Furthermore the packet error vector magnitude

$$EVM = \sqrt{\frac{1}{200} \cdot \sum_{\substack{k=-100 \\ (k \neq 0)}}^{100} EVM_k^2} \quad (34)$$

is derived by averaging the squared EVM_k versus k . Finally the average error vector magnitude

$$\overline{EVM} = \sqrt{\frac{1}{\text{nof_packets}} \sum_{\text{counter}=1}^{\text{nof_packets}} EVM^2(\text{counter})} \quad (35)$$

is calculated by averaging the packet EVM of all nof_packets detected packets. This parameter is equivalent to the so-called "RMS average of all errors $Error_{RMS}$ " of the IEEE 802.16-2004 measurement commandment (see [6], Chapter 8.3.10.1.2).

Analysis Steps

Preamble related result	Remark
Rough frequency estimation	In case of subchannelization, a rough frequency estimation is obtained by exploiting the cyclic prefix of the OFDM symbols.
Preamble power	
Preamble EVM	Uses payload channel estimation for equalization.
Frequency error vs. preamble	
Phase error vs. preamble	
Channel estimation	Used for equalizing

Payload related result	Remark
Fine frequency estimation	Estimation on pilots used for phase correction if 'Phase Tracking' is selected. Phase tracking needs at least one pilot. In case of subchannelization, the value shown in the result summary table is estimated on pilots and data.
Clock offset estimation	Estimation on pilots used for timing correction if 'Timing Tracking' is selected. Timing tracking needs at least two pilots. In case of subchannelization, the value shown in the result summary table is estimated on pilots and data.
IQ Offset	Power at spectral line 0 normalized to the total transmitted power.
Gain Imbalance	Estimation not available in case of subchannelization.
Quadrature Error	Estimation not available in case of subchannelization.
Payload channel estimation	Combined with the preamble channel estimation.

Burst related result	Remark
EVM All carriers EVM Data carriers EVM Pilot carriers	According to standard normalized to the average power of all 200 used carriers.
Burst Power	
Crest Factor	

Subchannelization

Subchannelization can be used in uplink bursts to allocate only a subset of the available OFDM sub carriers. The measurement software can distinguish between downlink bursts, uplink bursts without subchannelization and uplink bursts with a selectable subchannel index. Thus it is possible to analyze the complete WirelessMAN traffic with one capture buffer shot.

Synchronization

The synchronization of uplink bursts using subchannelization is performed after the synchronization on standard downlink and uplink preambles:

1. Synchronization of downlink and uplink bursts without subchannelization.
2. Pre-analysis of the bursts without subchannelization to determine their length.
3. Extraction of TX power areas without already detected bursts.
4. Synchronization of uplink bursts with the selected subchannel index.

In the following sections, the influence of subchannelization on results is discussed.

Channel Results

The standard requires an interpolation of order 0 for the channel estimation on unallocated sub carriers, i.e. the estimated channel coefficient of the nearest allocated sub carrier shall be used for those sub carriers not part of the allocated subchannels.

For the derived channel results like group delay or flatness difference, the unallocated carriers are not taken into account.

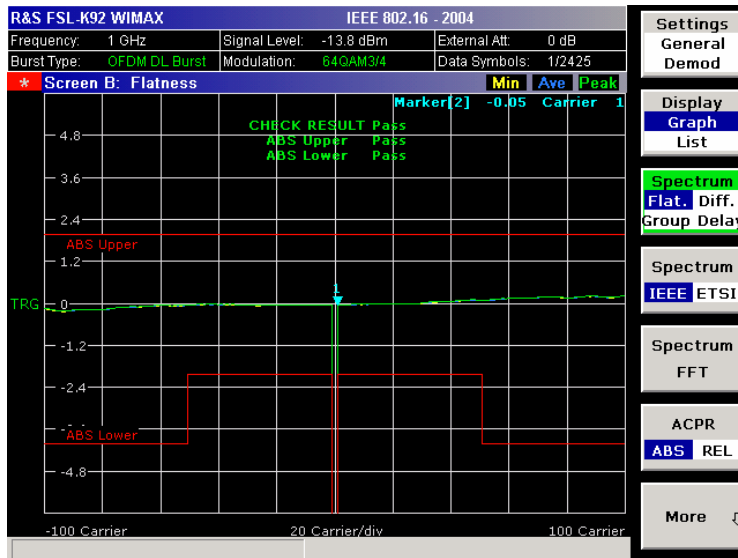

Fig. 2-91 Spectrum Flatness

Frequency and Clock Offset

The measurement software allows selectable compensation of phase, timing and gain errors based on pilot estimations. However, in case of subchannelization the number of pilots is decreased. Bursts with odd subchannel indices do not provide pilots at all. The following table lists the restrictions on the tracking ability for subchannelization:

Tracking	Subchannel Index		
	16 (8 Pilots) 8, 24 (4 Pilots) 4, 12, 20, 28 (2 Pilots)	2, 6, 10, 14, 18, 22, 26, 30 (1 Pilot)	1, 3, 5, 7, 9, 11, 13, 15, 17, 19, 21, 23, 25, 27, 29, 31 (No Pilot)
Phase	Available	Available	Available, but uses rough frequency offset estimation from the synchronization step only
Timing	Available	Not available	Not available
Gain	Available	Available	Not available

While the tracking functionality has to use pilot based estimates, the actual results for frequency and clock offset in the result summary can be data aided. In case of subchannelization the final estimation of frequency and clock offset is done using the already decided data sequence, which gives stable results even without pilots.

EVM

The error vector magnitude of a single constellation point is defined by

$$EVM(l,k) = \sqrt{\frac{|r(l,k) - a(l,k)|^2}{\frac{1}{N_{used}} \sum_{\substack{k=-N_{used}/2 \\ k \neq 0}}^{k=N_{used}/2} |a(l,k)|^2}}$$

where $r(l, k)$ is the received constellation point and $a(l, k)$ is the transmitted constellation point at the l^{th} symbol and carrier number k .

In case of subchannelization, it is required by the standard to include the unallocated carriers $k_{unalloc}$ by assuming $a(l, k_{unalloc}) = 0$ in the denominator of the EVM calculation.

Thus the EVM All Carriers result for one burst in the result summary equals

$$EVM_All_Carr = \sqrt{\frac{\frac{1}{L} \sum_{l=1}^L \frac{1}{N_{used}} \sum_{\substack{k=-N_{used}/2 \\ k \neq 0}}^{N_{used}/2} |r(l, k) - a(l, k)|^2}{\frac{1}{L} \sum_{l=1}^L \frac{1}{N_{used}} \sum_{\substack{k=-N_{used}/2 \\ k \neq 0}}^{N_{used}/2} |a(l, k)|^2}}$$

where L is the number of symbols in the burst.

This definition is according to the relative constellation error defined in the IEEE 802.16-2004 standard.

Using the equations above, the error power is normalized by the average transmitted power in all 200 carriers. Please notify, that by this definition the same absolute error power leads to different EVM results depending on the number of allocated carriers in case of subchannelization.

IQ Impairments

IQ imbalance in an OFDM transmitter or receiver leads to an interference of the symbols $a_{l,-k}$ with the symbols $a_{l,k}$. In case of subchannelization, the used sub carriers are always situated in such a way, that $a_{l,-k} = 0$, if $a_{l,k} \neq 0$. There is no impact of IQ imbalance on the actually allocated carriers of a subchannelization transmission. The effect can only be seen on the unallocated carriers and yields a pattern around the origin of the constellation diagram.

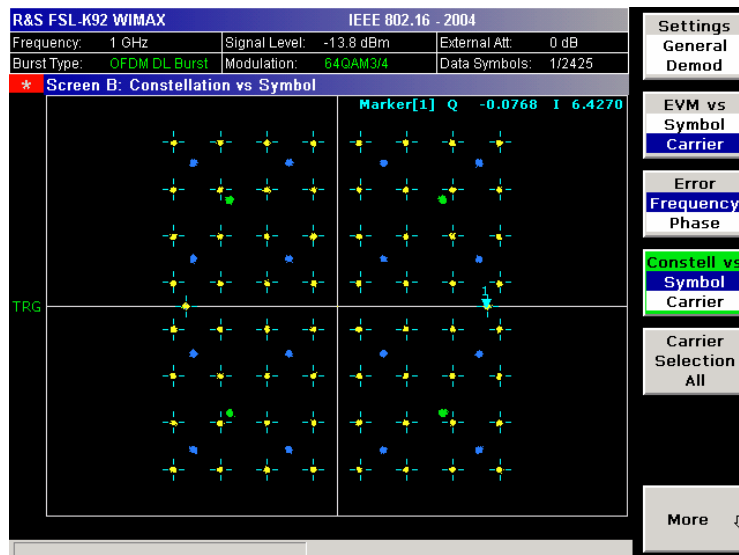

Fig. 2-92 Constellation vs Symbol

The unsymmetrical allocation of the sub carriers prevents a measurement of gain imbalance and quadrature error in case of subchannelization. The influence of the occupied carriers $a_{l,k}$ on the unoccupied carriers $a_{l,-k}$ could be measured, but there is no possibility to distinguish them from an unknown channel coefficient.

RSSI

See [6] section "8.3.9.2 RSSI mean and standard deviation". The Received Signal Strength Indication [RSSI] is basically the preamble power. The result summary provides the RSSI statistics according to the standard. A possible method to compute RSSI[k] at the antenna connector is given in [6] equation (87). RSSI[k] is the RSSI measurement based on the k-th signal/preamble.

The RSSI statistics of the *result summary* is calculated as follows:

1. RSSI row:
Statistic {min, mean, max} of the $R[k]=\text{RSSI}[k]$.
The mean value is $\hat{\mu}_{\text{RSSI dBm}}[k]$ according to [6] formula (89).
2. RSSI Standard Deviation row:
 $\hat{\sigma}_{\text{RSSI dB}}[k]$ according to [6] formula (91).

CINR

See [6] section "8.3.9.3 CINR mean and standard deviation". The result summary provides the Carrier Interference Noise Ratio [CINR] statistics according to the standard. One possible method to estimate the CINR of a single message is to compute the ratio of the sum of signal power and the sum of residual error for each data sample, using equation [6] (92).

$$\text{CINR}[k] = \frac{\sum_{n=0}^{N-1} |s[k, n]|^2}{\sum_{n=0}^{N-1} |r[k, n] - s[k, n]|^2}$$

with

- | | |
|-----------|---|
| $r[k, n]$ | received/measured sample n within message k |
| $s[k, n]$ | corresponding detected/reference sample (with channel state weighting) corresponding to received symbol n |

The CINR statistics of the *result summary* is calculated as follows:

1. CINR row:
Statistic {min, mean, max} of the CINR[k].
The mean value is $\hat{\mu}_{\text{CINR dB}}[k]$ according to [6] formula (94).
2. CINR Standard Deviation row
 $\hat{\sigma}_{\text{CINR dB}}[k]$ according to [6] formula (96).

Literature

- [1] Speth, Classen, Meyr: "Frame synchronisation of OFDM systems in frequency selective fading channels", VTC '97, pp. 1807-1811
- [2] Schmid, Cox: "Robust Frequency and Timing Synchronization of OFDM", IEEE Trans. on Comm., Dez. 1997, pp. 1613-621
- [3] Minn, Zeng, Bhargava: "On Timing Offset Estimation for OFDM", IEEE Communication Letters, July 2000, pp. 242-244
- [4] Speth, Fechtel, Fock, Meyr: "Optimum Receiver Design for Wireless Broad-Band Systems Using OFDM - Part I", IEEE Trans. On Comm. VOL. 47, NO 11, Nov. 1999
- [5] Speth, Fechtel, Fock, Meyr: "Optimum Receiver Design for Wireless Broad-Band Systems Using OFDM - Part II", IEEE Trans. On Comm. VOL. 49, NO 4, April. 2001
- [6] IEEE 802.16-2004, Part 16: Air Interface for Fixed Broadband Wireless Access Systems; 1 October 2004; Medium Access Control (MAC) and Physical Layer (PHY) specifications

Signal Processing of the IEEE802.16-2005 OFDMA/WiBro Measurement Application

Symbol	Description
$a_{l,k}, \hat{a}_{l,k}$	data symbol (actual, decided)
Δf_{res}	residual carrier frequency offset
$\Delta f, \Delta \hat{f}_{\text{coarse}}$	carrier frequency offset between transmitter and receiver (actual, coarse estimate)
ζ	relative sampling frequency offset
g_l	gain
$H_{l,k}, \hat{H}_{l,k}$	channel transfer function (actual, estimate)
i	time index
$\hat{i}_{\text{coarse}}, \hat{i}_{\text{fine}}$	timing estimate (coarse, fine)
$k, k_p, k_d, k_{\text{ch } n}$	subcarrier index (general, pilot, data, subchannel n)
l	OFDM symbol index
N_{FFT}	length of FFT
N_g	number of samples in cyclic prefix (guard interval)
N_s	number of Nyquist samples
N_{sc}	number of subcarriers
n	subchannel index, subframe index
$n_{l,k}$	noise sample
Φ_l	common phase error
$\Delta Q, \Delta \hat{Q}$	I/Q imbalance (actual, estimate)
$r(i)$	received sample in the time domain
$r_{l,k}, r'_{l,k}, r''_{l,k}, r'''_{l,k}$	received sample (uncompensated, fully compensated, partially compensated, equalized) in the frequency domain
T	useful symbol time
T_g	guard time
T_s	symbol time

Abbreviation	Description
AWGN	additive white Gaussian noise
BER	bit error rate
CFO	carrier frequency offset
CINR	carrier to interference and noise ratio
CIR	channel impulse response
CP	cyclic prefix (guard interval)
CPE	common phase error
CTF	channel transfer function

DL	downlink
EVM	error vector magnitude
FFT	fast Fourier transformation
IF	intermediate frequency
ISI	intersymbol interference
OFDM	orthogonal frequency division multiplexing
OFDMA	orthogonal frequency division multiple access
PAPR	peak to average power ratio
RSSI	received signal strength indicator
SFO	sampling frequency offset
UL	uplink

Introduction

The following description provides a brief overview of the digital signal processing used in the IEEE 802.16 OFDMA measurement application.

From the received IF signal as the point of origin to the actual analysis results like EVM or CINR, the digital signal processing can be divided into four major groups:

- Data capturing
 - Synchronization
 - Channel estimation / equalization
 - Analysis
- } OFDMA measurement application

The description of the IEEE802.16-2005 OFDMA/WiBro measurement signal processing is structured accordingly.

Signal Processing Block Diagram

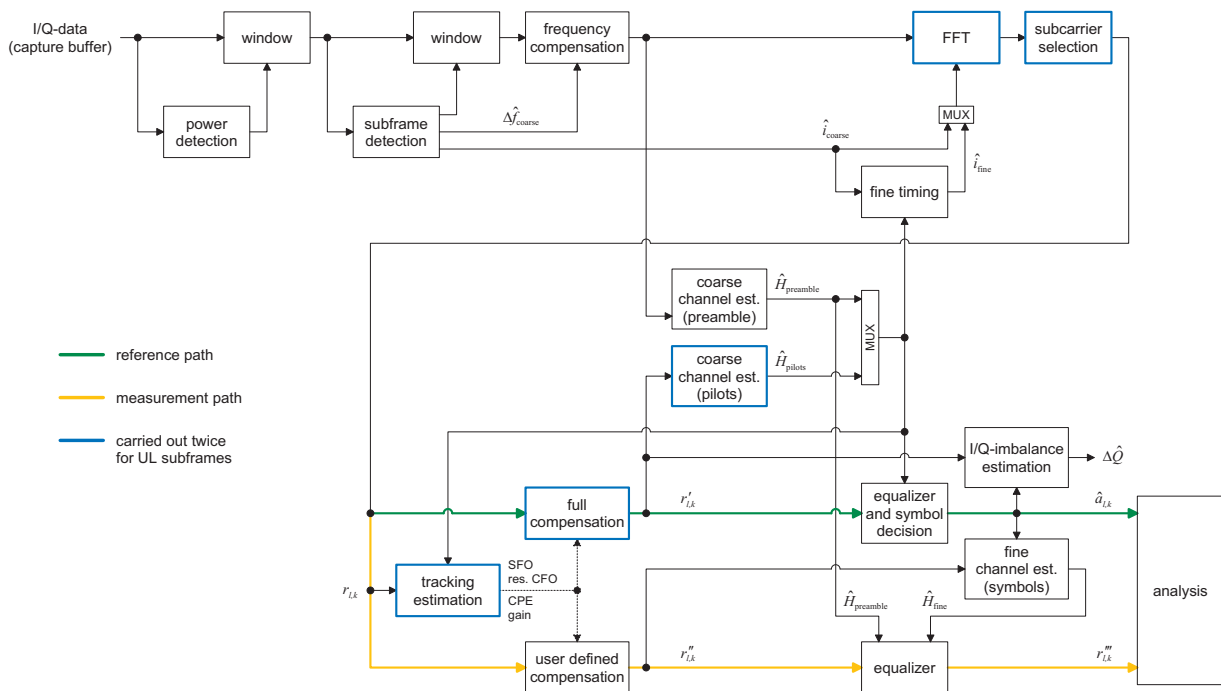

Fig. 2-93 Signal processing of the IEEE 802.16 OFDMA measurement application

The block diagram in Fig. 2-93 shows the OFDMA measurement application from the capture buffer containing the I/Q data to the actual analysis block. Outcome of the fully compensated reference path (green) are the estimates $\hat{a}_{l,k}$ of the transmitted data symbols $a_{l,k}$. Depending on the user defined compensation, the received samples $r_{l,k}^m$ of the measurement path (orange) still contain the transmitted signal impairments of interest. The analysis block reveals these impairments by comparing the reference and the measurement path. Prior to the analysis, diverse synchronization and channel estimation tasks have to be accomplished.

Synchronization

The first of the synchronization tasks is to detect areas of sufficient power within the captured I/Q data stream. The subframe detection block determines the beginning and end of each subframe and coarsely estimates both timing and carrier frequency offset. The fine timing block prior to the FFT allows a timing improvement using a level-based search for the beginning and end of the coarsely estimated channel impulse response. In the DL the coarse estimate of the CIR can be directly obtained from the preamble. Other than that the UL consists only of payload information with scattered pilots in the subcarrier-symbol plane, thus several OFDM symbols have to be observed to get a reliable estimate of the CIR. Since the OFDM symbols need to be phase synchronized prior to the channel estimation, the blue blocks in Fig. 2-93 have to be carried out twice. In the first iteration the timing estimate \hat{i}_{coarse} is used to position the window of the FFT. Having found the pilot-based estimate of the CIR, the fine timing estimate \hat{i}_{fine} is used in the second iteration.

After the time to frequency transformation by an FFT of length N_{FFT} , the tracking estimation block is used to estimate the following:

- relative sampling frequency offset ζ
- residual carrier frequency offset Δf_{res}
- common phase error Φ_l
- gain g_l

Corresponding to [3] and [4], the uncompensated samples $r_{l,k}$ can be expressed as

$$r_{l,k} = g_l \cdot a_{l,k} \cdot H_{l,k} \cdot \underbrace{e^{j\Phi_l}}_{\text{CPE}} \cdot \underbrace{e^{j2\pi \cdot N_s / N_{\text{FFT}} \cdot \zeta \cdot k \cdot l}}_{\text{SFO}} \cdot \underbrace{e^{j2\pi \cdot N_s / N_{\text{FFT}} \cdot \Delta f_{\text{res}} \cdot T \cdot l}}_{\text{res. CFO}} + n_{l,k} \quad (36)$$

with

- data symbol $a_{l,k}$ on subcarrier k at OFDM symbol l
- channel transfer function $H_{l,k}$
- number of Nyquist samples N_s within the symbol time T_s
- useful symbol time $T = T_s - T_g$
- independent and Gaussian distributed noise sample $n_{l,k}$

Within one OFDM symbol both the CPE and the residual CFO respectively cause the same phase rotation for each subcarrier, while the rotation due to the SFO linearly depends on the subcarrier index. A linear phase increase in symbol direction can be observed for the residual CFO as well as the SFO.

The results of the tracking estimation block are used to compensate the samples $r_{l,k}$. While a full compensation is performed in the reference path, the signal impairments that are of interest to the user are left uncompensated in the measurement path.

Channel Estimation / Equalization

According to Fig. 2-93, there are two coarse and one fine channel estimation blocks. Which of the two coarse estimation blocks is used depends on the link direction. For DL subframes the coarse channel estimation is based on the preamble and directly follows the coarse frequency compensation block. The pilot-based estimation for UL subframes is tapped behind the full compensation block of the reference path. Both of the coarse estimation blocks use available training symbols to determine initial estimates $\hat{H}_{l,k}$ of the channel transfer function at fixed positions in the subcarrier-symbol plane. Based on these nodes, the missing CTF values are obtained by interpolation in both time and frequency direction. The coarse estimation results are used for the above mentioned fine timing and to equalize the samples $r'_{l,k}$ of the reference path prior to symbol decision. Based on the decided data symbols, a fine channel estimation is performed and then used to equalize the partially compensated samples of the measurement path.

Analysis

The analysis block of the OFDMA measurement application allows to calculate a variety of measurement variables.

EVM

The most important variable is the error vector magnitude (EVM).

$$EVM_{l,k} = \left| \frac{r_{l,k}^m - \hat{a}_{l,k}}{\hat{a}_{l,k}} \right| \quad (37)$$

on subcarrier k at OFDM symbol l . The subsequent average values can be derived from (37).

1. EVM of subchannel n at OFDM symbol l :

$$EVM_{l,\text{subchannel } n} = \sqrt{\frac{1}{N_{\text{sc}}} \sum_{k_{\text{ch},n}} EVM_{l,k_{\text{ch},n}}^2} \quad (38)$$

2. EVM of all pilot subcarriers:

$$EVM_{\text{pilots}} = \sqrt{\frac{1}{N_{\text{sc}}} \sum_l \sum_{k_p} EVM_{l,k_p}^2} \quad (39)$$

3. EVM of all data subcarriers:

$$EVM_{\text{data}} = \sqrt{\frac{1}{N_{\text{sc}}} \sum_l \sum_{k_d} EVM_{l,k_d}^2} \quad (40)$$

4. EVM of all used subcarriers:

$$EVM_{\text{all}} = \sqrt{\frac{1}{N_{\text{sc}}} \sum_l \left[\sum_{k_p} EVM_{l,k_p}^2 + \sum_{k_d} EVM_{l,k_d}^2 \right]} \quad (41)$$

The number of subcarriers respectively taken into account is denoted by N_{sc} .

CINR

The carrier to interference and noise ratio is determined for each subframe n . The computation is based on the partially compensated samples $r''_{l,k}$, the decided symbols $\hat{a}_{l,k}$, and the channel estimates \hat{H}_k (DL: preamble and fine; UL: fine).

$$CINR(n) = \frac{\sum_l \sum_k |\hat{a}_{l,k} \cdot \hat{H}_k|^2}{\sum_l \sum_k |r''_{l,k} - \hat{a}_{l,k} \cdot \hat{H}_k|^2} \quad (42)$$

Further CINR statistics are defined in the standards [5], [6].

$$\begin{aligned} \hat{\mu}_{\text{CINR}}(n) &= \begin{cases} CINR(0) & n = 0 \\ (1 - \alpha_{\text{avg}}) \cdot \hat{\mu}_{\text{CINR}}(n-1) + \alpha_{\text{avg}} \cdot CINR(n) & n > 0 \end{cases} \\ \hat{\mu}_{\text{CINR}}^{(\text{dB})}(n) &= 10 \cdot \log \hat{\mu}_{\text{CINR}}(n) \text{ dB} \\ \hat{x}_{\text{CINR}}^2(n) &= \begin{cases} CINR^2(0) & n = 0 \\ (1 - \alpha_{\text{avg}}) \cdot \hat{x}_{\text{CINR}}^2(n-1) + \alpha_{\text{avg}} \cdot CINR^2(n) & n > 0 \end{cases} \\ \hat{\sigma}_{\text{CINR}}^{(\text{dB})}(n) &= 5 \cdot \log(\hat{x}_{\text{CINR}}^2(n) - \hat{\mu}_{\text{CINR}}^2(n)) \text{ dB} \end{aligned} \quad (43)$$

RSSI

The received signal strength indicator is determined for each subframe n . The computation is based on the time domain samples $r(i)$ extracted by the subframe detection block.

$$RSSI(n) \sim \overline{|r(i)|^2} \quad (44)$$

Further RSSI statistics are defined in the standard [5], [6].

$$\begin{aligned} \hat{\mu}_{\text{RSSI}}(n) &= \begin{cases} RSSI(0) & n = 0 \\ (1 - \alpha_{\text{avg}}) \cdot \hat{\mu}_{\text{RSSI}}(n-1) + \alpha_{\text{avg}} \cdot RSSI(n) & n > 0 \end{cases} \\ \hat{\mu}_{\text{RSSI}}^{(\text{dB})}(n) &= 10 \cdot \log \hat{\mu}_{\text{RSSI}}(n) \text{ dB} \\ \hat{x}_{\text{RSSI}}^2(n) &= \begin{cases} RSSI^2(0) & n = 0 \\ (1 - \alpha_{\text{avg}}) \cdot \hat{x}_{\text{RSSI}}^2(n-1) + \alpha_{\text{avg}} \cdot RSSI^2(n) & n > 0 \end{cases} \\ \hat{\sigma}_{\text{RSSI}}^{(\text{dB})}(n) &= 5 \cdot \log(\hat{x}_{\text{RSSI}}^2(n) - \hat{\mu}_{\text{RSSI}}^2(n)) \text{ dB} \end{aligned} \quad (45)$$

I/Q Imbalance

The I/Q imbalance estimation block allows to evaluate the

$$\text{modulator gain balance} = |1 + \Delta Q| \quad (46)$$

and the

$$\text{quadrature mismatch} = \arg\{1 + \Delta Q\} \quad (47)$$

respectively based on the block's estimate $\Delta \hat{Q}$.

Other Measurement Variables

Without going into detail, the OFDMA measurement application additionally provides the following results:

- Burst power
- Constellation diagram
- Group delay
- I/Q offset
- PAPR
- Pilot BER
- Spectral flatness

Literature

- [1] Speth, M., Classen, F., and Meyr, H.: Frame Synchronization of OFDM Systems in Frequency Selective Fading Channels. IEEE VTC'97, May 1997, pp. 1807-1811.
- [2] Schmid, T. M. and Cox, D. C.: Robust Frequency and Timing Synchronization of OFDM. IEEE Trans. on Commun. Vol. 45 (1997) No. 12, pp. 1613-1621.
- [3] Speth, M., Fechtel, S., Fock, G., and Meyr, H.: Optimum Receiver Design for Wireless Broad-Band Systems Using OFDM - Part I. IEEE Trans. on Commun. Vol. 47 (1999) No. 11, pp. 1668-1677.
- [4] Speth, M., Fechtel, S., Fock, G., and Meyr, H.: Optimum Receiver Design for OFDM-Based Broadband Transmission - Part II: A Case Study. IEEE Trans. on Commun. Vol. 49 (2001) No. 4, pp. 571-578.
- [5] IEEE 802.16-2004™: Air Interface for Fixed Broadband Wireless Access Systems (2004).
- [6] IEEE Std 802.16e™-2005 and IEEE Std 802.16™-2004/Cor1-2005: Air Interface for Fixed and Mobile Broadband Wireless Access Systems (2006)

3 Manual Operation

For details refer to the Quick Start Guide chapter 4, "Basic Operations".

Contents of Chapter 4

4	Instrument Functions - Analyzer	4.1
	Measurement Parameters.....	4.2
	Initializing the Configuration - PRESET Key.....	4.2
	Selecting the Frequency and Span - FREQ Key.....	4.5
	Setting the Frequency Span - SPAN Key.....	4.11
	Setting the Level Display and Configuring the RF Input - AMPT Key	4.13
	Setting the Bandwidths and Sweep Time - BW Key	4.17
	Configuring the Sweep Mode - SWEEP Key.....	4.22
	Triggering the Sweep - TRIG Key	4.25
	Setting Traces - TRACE Key.....	4.35
	Measurement Functions	4.47
	Using Markers and Delta Markers - MKR Key.....	4.48
	Changing Settings via Markers - MKR-> Key.....	4.60
	Power Measurements - MEAS Key	4.69
	Using Limit Lines and Display Lines - LINES Key.....	4.111
	Measurement Modes.....	4.120
	Measurement Mode Selection - MODE Key.....	4.120
	Measurement Mode Menus - MENU Key.....	4.122
	Models and Options	4.124
	Tracking Generator (Models 13, 16 and 28).....	4.125
	Analog Demodulation (Option K7).....	4.131
	Bluetooth Measurements (Option K8)	4.149
	Power Meter (Option K9).....	4.176
	Spectrogram Measurement (Option K14).....	4.181
	Cable TV Measurements (Option K20)	4.192
	Noise Figure Measurements Option (K30).....	4.235
	3GPP Base Station Measurements (Option K72)	4.258
	CDMA2000 BTS Analyzer (Option K82).....	4.282
	1xEV-DO BTS Analyzer (Option K84)	4.340
	WLAN TX Measurements (Option K91 / K91n).....	4.391
	WiMAX, WiBro Measurements (Options K92/K93)	4.423
	Instrument Functions - Basic Settings.....	4.472
	General Settings, Printout and Instrument Settings.....	4.473
	Instrument Setup and Interface Configuration - SETUP Key	4.474
	Saving and Recalling Settings Files - FILE Key	4.492
	Manual Operation - Local Menu	4.500
	Measurement Documentation - PRINT Key	4.501

4 Instrument Functions - Analyzer

In this section, all analyzer functions of the R&S FSL and their application are explained in detail. The basic settings functions are described in section "Instrument Functions - Basic Settings".

For every key a table is provided in which all submenus and corresponding commands are listed. The description of the submenus and commands follows the order of the table. The commands for the optional remote control (if any) are indicated for each softkey. The description is divided into the following topics:

- ["Measurement Parameters"](#) on page 4.2
This section describes how to reset the instrument, to set up specific measurements and to set the measurement parameters. Examples of basic operations are provided in the Quick Start Guide, chapter 5 "Basic Measurement Examples". Advanced examples are described in chapter "Advanced Measurement Examples".
- ["Measurement Functions"](#) on page 4.47
This section informs about how to select and configure the measurement functions. Examples of basic operations are provided in the Quick Start Guide, chapter 5 "Basic Measurement Examples". Advanced examples are described in chapter "Advanced Measurement Examples".
- ["Measurement Modes"](#) on page 4.120
This section describes the provided measurement modes, the change of measurement modes and the access to the menus of all active measurement modes.
- ["Models and Options"](#) on page 4.124
This section informs about optional functions and their application that are included in the basic unit configuration.

More basic information on operation is given in the Quick Start Guide. The front and the rear view of the instrument together with a table of all available keys and a short description are provided in chapter "Front and Rear Panel". Chapter "Preparing for Use" informs how to start working with the instrument for the first time. A brief introduction on handling the instrument is given in chapter "Basic Operations". This includes also the description of the keys for basic operations like switching the instrument on and off or starting a measurement.

Measurement Parameters

In this section all menus necessary for setting measurement parameters are described. This includes the following topics and keys. For details on changing the mode refer to "[Measurement Mode Selection - MODE Key](#)" on page 4.120.

- "[Initializing the Configuration - PRESET Key](#)" on page 4.2
- "[Selecting the Frequency and Span - FREQ Key](#)" on page 4.5
- "[Setting the Frequency Span - SPAN Key](#)" on page 4.11
- "[Setting the Level Display and Configuring the RF Input - AMPT Key](#)" on page 4.13
- "[Setting the Bandwidths and Sweep Time - BW Key](#)" on page 4.17
- "[Configuring the Sweep Mode - SWEEP Key](#)" on page 4.22
- "[Triggering the Sweep - TRIG Key](#)" on page 4.25
- "[Setting Traces - TRACE Key](#)" on page 4.35

Table 4-1: Sweep range variables

Abbreviation	Definition	R&S FSL3 value	R&S FSL6 value	R&S FSL18 value
f_{\max}	max. frequency	3 GHz	6 GHz	18 GHz*
f_{\min}	min. frequency available	0 Hz	0 Hz	0 Hz
span_{\min}	smallest selectable span > 0 Hz	10 Hz	10 Hz	10 Hz

* In remote control, the query of the maximum frequency returns 20 GHz. For further details refer to chapter 6.

Initializing the Configuration - PRESET Key

The **PRESET** key resets the instrument to the default setting and therefore provides a defined initial state as a known starting point for measurements



If the **LOCAL LOCKOUT** function is active in the remote control mode, the **PRESET** key is disabled.

Further information

- "[Initial configuration](#)" on page 4.4

Task

- [To preset the instrument](#)

To preset the instrument

1. Define the data set for the preset:
 - To retrieve the originally provided settings file (see [Initial configuration](#)), in the file menu, deactivate the **Startup Recall** softkey.
 - To retrieve a customized settings file, in the file menu, activate the **Startup Recall** softkey, press the **Startup Recall Setup** softkey, and select the corresponding file.
For details refer to section "Saving and Recalling Settings Files - FILE Key".
 2. Press the **PRESET** key to trigger a preset.
- Remote: *RST or SYSTem:PRESet (for details refer to chapter "Remote Control - Commands", section "Common Commands" or section "SYSTem Subsystem").



In order to save the current settings after reboot of the instrument, create a shutdown file by switching the analyzer in the standby mode (press the On/Off key on the FRONT panel and wait until the yellow LED is ON). With the battery pack option, use a USB keyboard and terminate the analyzer firmware with ALT+F4 to create the shutdown file.

Initial configuration

The initial configuration is selected in a way that the RF input is always protected against overload, provided that the applied signal levels are in the allowed range for the instrument.

The parameter set of the initial configuration can be customized by using the **Startup Recall** softkey in the file menu. For further information refer to section "Instrument Functions - Basic Settings", "Saving and Recalling Settings Files - FILE Key".

Table 4-2: Initial configuration

Parameter	Setting
mode	Spectrum Analyzer
center frequency	$f_{\max} / 2$
center frequency step size	0.1 * center frequency
span	R&S FSL3: 3 GHz R&S FSL6: 6 GHz R&S FSL18: 18 GHz
RF attenuation	auto (R&S FSL3/6: 0 dB; R&S FSL18: 10 dB)
reference level	R&S FSL3/6: -20 dBm; R&S FSL18: -10 dBm
level range	100 dB log
level unit	dBm
sweep time	auto
resolution bandwidth	auto (3 MHz)
video bandwidth	auto (10 MHz)
FFT filters	off
span / RBW	50
RBW / VBW	0.33
sweep	cont
trigger	free run
trace 1	clr write
trace 2/3/4/5/6	blank
detector	auto peak
frequency offset	0 Hz
reference level offset	0 dB
reference level position	100 %
grid	abs
cal correction	on
noise source	off
input	RF
tracking generator (models 13, 16, 28)	off

Selecting the Frequency and Span - **FREQ** Key

The **FREQ** key is used to specify the frequency axis, and to set the frequency offset and the signal track function. The frequency axis can be specified either by the start and stop frequency or by the center frequency and the span.

To open the frequency menu

- Press the **FREQ** key.

The frequency menu is displayed. The **Frequency Center** edit dialog box is displayed.

Menu and softkey description

- ["Softkeys of the frequency menu"](#) on page 4.6

To display help to a softkey, press the **HELP** key and then the softkey for which you want to display help. To close the help window, press the **ESC** key. For further information refer to section "How to use the Help System".

Tasks

- [To specify the frequency axis by the start and stop frequency](#)
- [To specify the frequency axis by the center frequency and the span](#)
- [To specify the step size for the arrow keys and the rotary knob](#)
- [To modify the frequency axis by an offset](#)
- [To track signals \(only possible if span >0\)](#)

To specify the frequency axis by the start and stop frequency

1. Press the **Start** softkey and enter a start frequency.
2. Press the **Stop** softkey and enter a stop frequency.

To specify the frequency axis by the center frequency and the span

3. Press the **FREQ** key and enter a center frequency in the **Frequency Center** edit dialog box.
4. Press the **SPAN** key and enter the bandwidth you want to analyze.



Entering a value of 0 Hz will cause a change to the zero span analysis mode.

To specify the step size for the arrow keys and the rotary knob

1. Press the **CF Stepsize** softkey.
The softkeys are displayed according to the selected frequency span (zero span or span > 0).
2. To define the step size of the center frequency:

- Only if span > 0: Press **0.1*Span**, **0.5*Span** or **x*Span** to define the step size for the center frequency as percentage of the span.
- Only if span = 0: Press **0.1*RBW**, **0.5*RBW** or **x*RBW** to define the step size for the center frequency as percentage of the resolution bandwidth.
- Press the **=Center** softkey to set the step size to the value of the center frequency and to remove the dependency of the step size to span or resolution bandwidth.
- Press the **=Marker** softkey to set the step size to the value of the marker and to remove the dependency of the step size to span or resolution bandwidth.
- Press the **Manual** softkey and enter a fixed step size for the center frequency.



The step size assigned to arrow keys corresponds to the selected value; the step size of the rotary knob is $\frac{1}{10}$ of it.

To modify the frequency axis by an offset

- Press the **Frequency Offset** softkey and enter the offset to shift the displayed frequency span.

To track signals (only possible if span >0)

1. Press the **Signal Track** softkey.
The softkeys of this submenu are displayed to start and stop signal tracking with specified parameters.
2. Press the **Track On/Off** softkey to switch signal tracking on or off.
3. Press the **Track BW** softkey and enter a bandwidth for signal tracking.
4. Press the **Track Threshold** softkey and enter the threshold for signal tracking.
5. Press the **Select Trace** softkey and select the trace for signal tracking.

Softkeys of the frequency menu

The following table shows all softkeys available in the frequency menu. It is possible that your instrument configuration does not provide all softkeys. If a softkey is only available with a special option, model or (measurement) mode, this information is delivered in the corresponding softkey description.

Menu / Command	Command
Center	
Start	
Stop	
CF Stepsize ↓	0.1*Span/0.1*RBW
	0.5*Span/0.5*RBW
	x*Span/x*RBW
	=Center
	=Marker

Menu / Command	Command
	Manual
Frequency Offset	
Signal Track ↓	Track On/Off
	Track BW
	Track Threshold
	Select Trace

Center

Opens an edit dialog box to enter the center frequency. The allowed range of values for the center frequency depends on the frequency span.

$$\text{span} > 0: \text{span}_{\min} / 2 \leq f_{\text{center}} \leq f_{\text{max}} - \text{span}_{\min} / 2$$

$$\text{span} = 0: 0 \text{ Hz} \leq f_{\text{center}} \leq f_{\text{max}}$$

f_{max} and span_{\min} are specified in the data sheet. To help analyze signals located at the end of the frequency range, for R&S FSL models with an upper frequency limit of 6 GHz or less, the f_{max} value is extended by 0.05 GHz for direct entry via the key pad. The preset and full span values remain unchanged.

→ Remote: FREQ:CENT 100MHz

Start

Opens an edit dialog box to define the start frequency. The following range of values is allowed:

$$f_{\min} \leq f_{\text{start}} \leq f_{\text{max}} - \text{span}_{\min}$$

f_{\min} , f_{max} and span_{\min} are specified in the data sheet. To help analyze signals located at the end of the frequency range, for R&S FSL models with an upper frequency limit of 6 GHz or less, the f_{max} value is extended by 0.05 GHz for direct entry via the key pad. The preset and full span values remain unchanged.

→ Remote: FREQ:STAR 20MHz

Stop

Opens an edit dialog box to define the stop frequency. The following range of values for the stop frequency is allowed:

$$f_{\min} + \text{span}_{\min} \leq f_{\text{stop}} \leq f_{\text{max}}$$

f_{\min} , f_{max} and span_{\min} are specified in the data sheet. To help analyze signals located at the end of the frequency range, for R&S FSL models with an upper frequency limit of 6 GHz or less, the f_{max} value is extended by 0.05 GHz for direct entry via the key pad. For the R&S FSL18 model, the f_{max} value is extended to 20 GHz. The preset and full span values remain unchanged.

→ Remote: FREQ:STOP 2000MHz

CF Step size

Opens a submenu to set the step size of the center frequency. In addition to the **=Center**, **=Marker** and **Manual** softkeys, the other softkeys are displayed depending on the selected frequency span.

The step size can be coupled to the span (span > 0) or the resolution bandwidth (span = 0) or it can be manually set to a fixed value.

0.1*Span (span > 0)

Sets the step size for the center frequency to 10% of the span.

- Remote: `FREQ:CENT:STEP:LINK SPAN`
- Remote: `FREQ:CENT:STEP:LINK:FACT 10PCT`

0.1*RBW (zero span)

Sets the step size for the center frequency to 10% of the resolution bandwidth. This is the default setting.

- Remote: `FREQ:CENT:STEP:LINK RBW`
- Remote: `FREQ:CENT:STEP:LINK:FACT 10PCT`

0.5*Span (span > 0)

Sets the step size for the center frequency to 50% of the span.

- Remote: `FREQ:CENT:STEP:LINK SPAN`
- Remote: `FREQ:CENT:STEP:LINK:FACT 50PCT`

0.5*RBW (zero span)

Sets the step size for the center frequency to 50% of the resolution bandwidth.

- Remote: `FREQ:CENT:STEP:LINK RBW`
- Remote: `FREQ:CENT:STEP:LINK:FACT 50PCT`

x*Span (span > 0)

Opens an edit dialog box to set the step size for the center frequency as % of the span.

- Remote: `FREQ:CENT:STEP:LINK SPAN`
- Remote: `FREQ:CENT:STEP:LINK:FACT 20PCT`

x*RBW (zero span)

Opens an edit dialog box to set the step size for the center frequency as % of the resolution bandwidth. Values between 1 and 100% in steps of 1% are allowed. The default setting is 10%.

- Remote: `FREQ:CENT:STEP:LINK RBW`
- Remote: `FREQ:CENT:STEP:LINK:FACT 20PCT`

=Center

Sets the step size to the value of the center frequency and removes the coupling of the step size to span or resolution bandwidth. This function is especially useful during measurements of the signal harmonic content because by entering the center frequency each stroke of the arrow key selects the center frequency of another harmonic.

=Marker

Sets the step size to the value of the current marker and removes the coupling of the step size to span or resolution bandwidth. This function is especially useful during measurements of the signal harmonic content at the marker position because by entering the center frequency each stroke of the arrow key selects the center frequency of another harmonic.

Manual

Opens an edit dialog box to enter a fixed step size for the center frequency.

→ Remote: `FREQ:CENT:STEP 120MHZ`

Frequency Offset

Opens an edit dialog box to enter a frequency offset that shifts the displayed frequency range by the specified offset. The allowed values range from -100 GHz to 100 GHz. The default setting is 0 Hz.

→ Remote: `FREQ:OFFS 10 MHz`

Signal Track (span > 0)

Opens a submenu to modify the parameters for signal tracking: search bandwidth, threshold value and trace.

The search bandwidth and the threshold value are shown in the diagram by two vertical lines and one horizontal line, which are labeled as **TRK**. After each sweep the center frequency is set to the maximum signal found within the searched bandwidth. If no maximum signal above the set threshold value is found in the searched bandwidth, the track mechanism stops.

→ Remote: `CALC:MARK:FUNC:STR OFF`

Track On/Off (span > 0)

Switches the signal tracking on or off.

→ Remote: `CALC:MARK:FUNC:STR OFF`

Track BW (span > 0)

Opens an edit dialog box to set the search bandwidth for signal tracking. The frequency range is calculated as a function of the center frequency.

→ Remote: `CALC:MARK:FUNC:STR:BAND 1MHZ`

Track Threshold (span > 0)

Opens an edit dialog box to set the threshold value for signal tracking.

→ Remote: CALC:MARK:FUNC:STR:THR -70DBM

Select Trace (span > 0)

Opens an edit dialog box to select the trace on which the signal is tracked.

→ Remote: CALC:MARK:FUNC:STR:TRAC 1

Setting the Frequency Span - SPAN Key

The **SPAN** key is used to set the frequency span to be analyzed.

To open the span menu

- Press the **SPAN** key.

The span menu is displayed. For span > 0 an edit dialog box to enter the frequency is displayed. For zero span, an edit dialog box to enter the sweep time is displayed.

Menu and softkey description

- ["Softkeys of the span menu"](#) on page 4.11

To display help to a softkey, press the **HELP** key and then the softkey for which you want to display help. To close the help window, press the **ESC** key. For further information refer to section "How to use the Help System".

Task

- [To specify the span \(alternatives\)](#)

To specify the span (alternatives)

1. To set the span, use the **Span Manual**, **Full Span**, **Zero Span** and **Last Span** softkeys.
2. To define a frequency range, use the **Start** and **Stop** softkeys.
3. For zero span, press the **Sweeptime Manual** softkey and enter a sweep time.

Softkeys of the span menu

The following table shows all softkeys available in the span menu. It is possible that your instrument configuration does not provide all softkeys. If a softkey is only available with a special option, model or (measurement) mode, this information is delivered in the corresponding softkey description.

Command
Span Manual
Sweeptime Manual
Start
Stop
Full Span
Zero Span
Last Span

Span Manual

Opens an edit dialog box to enter the frequency span. The center frequency is kept constant. The following range is allowed:

$span = 0$: 0 Hz

$span > 0$: $span_{min} \leq f_{span} \leq f_{max}$

f_{max} and $span_{min}$ are specified in the data sheet. To help analyze signals located at the end of the frequency range, for R&S FSL models with an upper frequency limit of 6 GHz or less, the f_{max} value is extended by 0.05 GHz for direct entry via the key pad. The preset and full span values remain unchanged.

→ Remote: `FREQ:SPAN 2GHz`

Start

Opens an edit dialog box to enter the start frequency. For details see **Start** softkey in the frequency menu.

→ Remote: `FREQ:STAR 20MHz`

Stop

Opens an edit dialog box to enter the stop frequency. For details see **Stop** softkey in the frequency menu.

→ Remote: `FREQ:STOP 2000MHz`

Full Span

Sets the span to the full frequency range of the R&S FSL specified in the data sheet. This setting is useful for overview measurements.

→ Remote: `FREQ:SPAN:FULL`

Zero Span

Sets the span to 0 Hz (zero span). The x-axis becomes the time axis with the grid lines corresponding to 1/10 of the current sweep time (**SWT**).

→ Remote: `FREQ:SPAN 0Hz`

Last Span

Sets the span to the previous value. With this function e.g. a fast change between overview measurement and detailed measurement is possible.

Setting the Level Display and Configuring the RF Input - AMPT Key

The **AMPT** key is used to set the reference level, the level range and unit, the scaling and the RF attenuation.

To open the amplitude menu

- Press the **AMPT** key.

The amplitude menu is displayed. The **Reference Level** dialog box is displayed.

Menu and softkey description

- ["Softkeys of the amplitude menu"](#) on page 4.13

To display help to a softkey, press the **HELP** key and then the softkey for which you want to display help. To close the help window, press the **ESC** key. For further information refer to section "How to use the Help System".

Task

- [To specify the amplitude](#)

To specify the amplitude

1. Set the reference level, offset and position, using the **Ref Level**, **Ref Level Offset** and **Ref Level Position** softkeys.
2. Select the level range and the unit for the level axis, using the **Range Log** and **Unit** softkeys.
3. Set the scaling, using the **Range Linear** and/or **Grid Abs / Rel** softkeys.
4. Set the attenuation, using the **RF Atten Manual** or **RF Atten Auto** softkeys.

Softkeys of the amplitude menu

The following table shows all softkeys available in the amplitude menu. It is possible that your instrument configuration does not provide all softkeys. If a softkey is only available with a special option, model or (measurement) mode, this information is delivered in the corresponding softkey description.

Menu / Command	Command
Ref Level	
Range Log	
Range Linear ↓	Range Linear %
	Range Lin. Unit
Preamp On/Off	
RF Atten Manual	
RF Atten Auto	
More ↓	
Ref Level Offset	
Ref Level Position	

Menu / Command	Command
Grid Abs / Rel	
Unit	
Input 50 Ω / 75 Ω	

Ref Level

Opens an edit dialog box to enter the reference level in the currently active unit (dBm, dBμV, etc).

The reference level value is the maximum value the AD converter can handle without distortion of the measured value. Signal levels above this value will not be measured correctly, which is indicated by the **IFOVL** status display.

→ Remote: `DISP:TRAC:Y:RLEV -60dBm`

Range Log

Selects logarithmic scaling for the level display range and opens the **Range Log** dialog box to select a value for the level range.

→ Remote: `DISP:TRAC:Y:SPAC LOG`

→ Remote: `DISP:TRAC:Y 120DB`

Range Linear

Selects linear scaling for the level display range and opens a submenu to select the type of linear scaling.

Range Linear %

Selects linear scaling in % for the level display range, i.e. the horizontal grid lines are labelled in %. The grid is divided in decadic steps.

Markers are displayed in the selected unit (**Unit** softkey). Delta markers are displayed in % referenced to the voltage value at the position of marker 1. This is the default setting for linear scaling.

This softkey is available from firmware version 1.80.

→ Remote: `DISP:TRAC:Y:SPAC LIN`

Range Lin. Unit

Selects linear scaling in dB for the level display range, i.e. the horizontal lines are labelled in dB.

Markers are displayed in the selected unit (**Unit** softkey). Delta markers are displayed in dB referenced to the power value at the position of marker 1.

This softkey is available from firmware version 1.80.

→ Remote: `DISP:TRAC:Y:SPAC LDB`

R&S FSL *Setting the Level Display and Configuring the RF Input - AMPT Key*

Preamp On/Off (option RF Preamplifier, B22)

Switches the preamplifier on or off.

The preamplifier has only an effect below 6 GHz.

→ Remote: INP:GAIN:STAT ON

RF Atten Manual

Opens an edit dialog box to enter the attenuation, irrespective of the reference level.

The attenuation can be set in 5 dB steps. The range is specified in the data sheet. If the defined reference level cannot be set for the set RF attenuation, the reference level will be adjusted accordingly.

The RF attenuation defines the level at the input mixer according to the formula:

$$level_{mixer} = level_{input} - RF \text{ attenuation}$$

The maximum mixer level allowed is -10 dBm. Mixer levels above this value may lead to incorrect measurement results, which are indicated by the **OVL**D status display.

→ Remote: INP:ATT 30 DB

RF Atten Auto

Sets the RF attenuation automatically as a function of the selected reference level. This ensures that the optimum RF attenuation is always used. It is the default setting.

→ Remote: INP:ATT:AUTO ON

Ref Level Offset

Opens an edit dialog box to enter the arithmetic level offset. This offset is added to the measured level irrespective of the selected unit. The scaling of the y-axis is changed accordingly. The setting range is ±200 dB in 0.1 dB steps.

→ Remote: DISP:WIND:TRAC:Y:RLEV:OFFS -10dB

Ref Level Position

Opens an edit dialog box to enter the reference level position, i.e. the position of the maximum AD converter value on the level axis. The setting range is from -200 to +200%, 0% corresponding to the lower and 100% to the upper limit of the diagram.

→ Remote: DISP:WIND:TRAC:Y:RPOS 100PCT

Grid Abs / Rel (not available with Range Linear)

Switches between absolute and relative scaling of the level axis.

Absolute scaling	The labeling of the level lines refers to the absolute value of the reference level. Absolute scaling is the default setting.
Relative scaling	The upper line of the grid is always at 0 dB. The scaling is in dB whereas the reference level is always in the set unit (for details on unit settings see Unit softkey).

→ Remote: `DISP:WIND:TRAC:Y:MODE ABS`

Unit

Opens the **Unit** dialog box to select the unit for the level axis. The default setting is dBm. If a transducer is switched on, the softkey is not available.

In general, the spectrum analyzer measures the signal voltage at the RF input. The level display is calibrated in RMS values of an unmodulated sinewave signal. In the default state, the level is displayed at a power of 1 mW (= dBm). Via the known input impedance (50 Ω or 75 Ω), conversion to other units is possible. The units dBm, dBmV, dB μ V, V and W are directly convertible.

→ Remote: `CALC:UNIT:POW DBM`

Input 50 Ω / 75 Ω

Uses 50 Ω or 75 Ω as reference impedance for the measured levels. Default setting is 50 Ω .

Changes the reference impedance for the measured levels

The setting 75 Ω should be selected, if the 50 Ω input impedance is transformed to a higher impedance using a 75 Ω adapter of the RAZ type (= 25 Ω in series to the input impedance of the instrument). The correction value in this case is 1.76 dB = 10 log (75 Ω / 50 Ω).

All levels specified in this Operating Manual refer to the default setting of the instrument (50 Ω).

→ Remote: `INP:IMP 50OHM`

Setting the Bandwidths and Sweep Time - BW Key

The **BW** key is used to set the resolution bandwidth, video bandwidth (VBW) and sweep time (SWT). The values available for resolution bandwidth and video bandwidth depend on the selected filter type. For details on channel filters see also "[List of available RRC and channel filters](#)" on page 4.18.

To open the bandwidth menu

- Press the **BW** key.

The bandwidth menu is displayed.

Menu and softkey description

- "[Softkeys of the bandwidth menu](#)" on page 4.20

To display help to a softkey, press the **HELP** key and then the softkey for which you want to display help. To close the help window, press the **ESC** key. For further information refer to section "How to use the Help System".

Further information

- "[List of available RRC and channel filters](#)" on page 4.18

Tasks

- [To specify the bandwidth](#)
- [To choose the appropriate filter type](#)

To specify the bandwidth

1. Set the resolution bandwidth using the **Res BW Manual** or **Res BW Auto** softkey.
2. Set the video bandwidth using the **Video BW Manual** or **Video BW Auto** softkey.
3. Set the sweep time using the **Sweeptime Manual** or **Sweeptime Auto** softkey.
4. Press the **Filter Type** softkey and select the appropriate filters.

To choose the appropriate filter type

All resolution bandwidths are realized with digital filters. With option Narrow IF Filters, R&S FSL-B7, the range is enlarged (for details refer to the data sheet).

The video filters serve for smoothing the displayed trace. Using video bandwidths that are small compared to the resolution bandwidth, only the signal average is displayed and noise peaks and pulsed signals are repressed. If pulsed signals are to be measured, it is recommended to use a video bandwidth that is large compared to the resolution bandwidth ($VBW * 10 \times RBW$) for the amplitudes of pulses to be measured correctly.

The following filter types are available:

- Gaussian filters

The Gaussian filters are set by default. The available bandwidths are specified in the data sheet.

- EMI (6dB) filters

The EMI (6dB) filters are available from firmware version 1.30. The available bandwidths are specified in the data sheet.

- FFT filters

The available bandwidths are specified in the data sheet.

The FFT algorithm offers considerably higher measurement speeds with all the other settings remaining the same. The reason is that for analog filters the sweep time required for a particular span is proportional to $(\text{span}/\text{RBW}^2)$. When using the FFT algorithm, however, the sweep time is proportional to (span/RBW) .

FFT filters are particularly suitable for stationary signals (sinusoidal signals or signals that are continuously modulated in time). For burst signals (TDMA) or pulsed signals, normal filters are preferable. When the tracking generator is used as signal source for the DUT, filtering with the FFT algorithm is not useful. The **FFT** option is thus not available if the tracking generator is switched on.

If the FFT filters are activated, the sweep time display (**SWT**) is replaced by the acquisition time (**AQT**) display. The sweep time is defined by the selected bandwidth and span, and cannot be changed. The video bandwidth is not defined and therefore cannot be set.

The sample detector and the peak detector are available. If the **Detector Auto Select** softkey in the trace menu is activated, the peak detector is selected.

- channel filters

details see "[List of available RRC and channel filters](#)"

- RRC filters

details see "[List of available RRC and channel filters](#)"

List of available RRC and channel filters

For power measurement a number of especially steep-edged channel filters are available (see the following table).

For filters of type RRC (Root Raised Cosine), the filter bandwidth indicated describes the sampling rate of the filter. For all other filters (CFILter) the filter bandwidth is the 3 dB bandwidth.

Table 4-3: Filter types

Filter Bandwidth		Filter Type	Application
100	Hz	CFILter	A0
200	Hz	CFILter	
300	Hz	CFILter	
500	Hz	CFILter	
1	kHz	CFILter	SSB
1.5	kHz	CFILter	
2	kHz	CFILter	
2.4	kHz	CFILter	
2.7	kHz	CFILter	
3	kHz	CFILter	
3.4	kHz	CFILter	
4	kHz	CFILter	DAB, Satellite
4.5	kHz	CFILter	
5	kHz	CFILter	
6	kHz	CFILter	ETTS300 113 (12.5 kHz channels)
8.5	kHz	CFILter	
9	kHz	CFILter	AM radio

Filter Bandwidth		Filter Type	Application
10	kHz	CFILter	CDMAone ETTS300 113 (20 kHz channels) ETTS300 113 (25 kHz channels) TETRA PDC IS 136 (NADC) CDPD, CDMAone
12.5	kHz	CFILter	
14	kHz	CFILter	
15	kHz	CFILter	
16	kHz	CFILter	
18	kHz, $\alpha = 0.35$	RRC	
20	kHz	CFILter	
21	kHz	CFILter	
24.3	kHz, $\alpha = 0.35$	RRC	
25	kHz	CFILter	
30	kHz	CFILter	
50	kHz	CFILter	
100	kHz	CFILter	
150	kHz	CFILter	
192	kHz	CFILter	
200	kHz	CFILter	
300	kHz	CFILter	
500	kHz	CFILter	
1.0	MHz	CFILter	CDMAone CDMAone DAB W-CDMA 3GPP W-CDMA NTT DOCOMO
1.2288	MHz	CFILter	
1.28	MHz	RRC	
1.5	MHz	CFILter	
2.0	MHz	CFILter	
3.0	MHz	CFILter	
3.75	MHz	CFILter	
3.84	MHz, $\alpha = 0.22^*$	RRC	
4.096	MHz, $\alpha = 0.22^*$	RRC	
5.0	MHz	CFILter	
20 MHz	MHz	CFILter	



The 20 MHz channel filter is unavailable in sweep mode.

The 3.84 and 4.096 MHz filters (marked with an asterisk in the table) require an IF filter model index ≥ 3 .

Softkeys of the bandwidth menu

The following table shows all softkeys available in the bandwidth menu. It is possible that your instrument configuration does not provide all softkeys. If a softkey is only available with a special option, model or (measurement) mode, this information is delivered in the corresponding softkey description.

Command
Res BW Manual
Res BW Auto
Video BW Manual
Video BW Auto
Sweptime Manual
Sweptime Auto
Filter Type

Res BW Manual

Opens an edit dialog box to enter a value for the resolution bandwidth. The available resolution bandwidths are specified in the data sheet. For details on the correlation between resolution bandwidth and filter type refer to "[To choose the appropriate filter type](#)" on page 4.17.

Numeric input is always rounded to the nearest possible bandwidth. For rotary knob or **UP/DNARROW** key inputs, the bandwidth is adjusted in steps either upwards or downwards.

The manual input mode of the resolution bandwidth is indicated by a green asterisk (*) at the **RBW** display.

→ Remote: BAND:AUTO OFF

→ Remote: BAND 1MHz

Res BW Auto (span > 0)

Couples the resolution bandwidth to the selected span. If the span is changed, the resolution bandwidth is automatically adjusted.

This setting is recommended, if a favorable setting of the resolution bandwidth in relation to the selected span is desired.

→ Remote: BAND:AUTO ON

Video BW Manual (not available for FFT filter)

Opens an edit dialog box to enter the video bandwidth. The available video bandwidths are specified in the data sheet.

Numeric input is always rounded to the nearest possible bandwidth. For rotary knob or **UP/DNARROW** key inputs, the bandwidth is adjusted in steps either upwards or downwards.

The manual input mode of the video bandwidth is indicated by a green asterisk (*) at the **VBW** display.

→ Remote: BAND:VID:AUTO OFF

→ Remote: BAND:VID 10 kHz

Video BW Auto (not available for FFT filter)

Couples the video bandwidth to the resolution bandwidth. If the resolution bandwidth is changed, the video bandwidth is automatically adjusted.

This setting is recommended, if a minimum sweep time is required for a selected resolution bandwidth. Narrow video bandwidths require longer sweep times due to the longer settling time. Wide bandwidths reduce the signal/noise ratio.

→ Remote: BAND:VID:AUTO ON

Sweptime Manual (not available for FFT filter)

Opens an edit dialog box to enter the sweep time.

Sweep time	Option TV Trigger, B6 (available from version 1.10)
absolute max. sweep time value: 16000 s	100 µs (zero span)
absolute min. sweep time value: 1 µs (zero span)	25 µs (zero span)
2.5 ms (span > 0)	-

Allowed values depend on the ratio of span to RBW and RBW to VBW. For details refer to the data sheet.

Numeric input is always rounded to the nearest possible sweep time. For rotary knob or **UPARROW/DNARROW** key inputs, the sweep time is adjusted in steps either downwards or upwards.

The manual input mode of the sweep time is indicated by a green asterisk (*) at the **SWT** display. If the selected sweep time is too short for the selected bandwidth and span, level measurement errors will occur due to a too short settling time for the resolution or video filters. In this case, the R&S FSL displays the error message **UNCAL** and marks the indicated sweep time with a red asterisk (*).

→ Remote: SWE:TIME:AUTO OFF

→ Remote: SWE:TIME 10s

Sweptime Auto (not available for FFT filter and zero span)

Couples the sweep time to the span, video bandwidth (VBW) and resolution bandwidth (RBW). If the span, resolution bandwidth or video bandwidth are changed, the sweep time is automatically adjusted.

The R&S FSL always selects the shortest sweep time that is possible without falsifying the signal. The maximum level error is < 0.1 dB, compared to using a longer sweep time.

→ Remote: SWE:TIME:AUTO ON

Filter Type

Opens the **Filter Type** dialog box to select the filter type.

For detailed information on filters see "[To choose the appropriate filter type](#)" on page 4.17 and "[List of available RRC and channel filters](#)" on page 4.18.

→ Remote: BAND:TYPE NORM

Configuring the Sweep Mode - SWEEP Key

The **SWEEP** key is used to configure the sweep mode. Continuous sweep or single sweep are possible. The sweep time and the number of measured values are set.

To open the sweep menu

- Press the **SWEEP** key.
The sweep menu is displayed.

Menu and softkey description

- ["Softkeys of the sweep menu"](#) on page 4.22

To display help to a softkey, press the **HELP** key and then the softkey for which you want to display help. To close the help window, press the **ESC** key. For further information refer to section "How to use the Help System".

Task

- [To specify the sweep settings](#)

To specify the sweep settings

1. Press the **Sweep Count** softkey and enter the sweep count.
2. Set the sweep time by using the **Sweeptime Manual** or **Sweeptime Auto** softkey.
3. Press the **Sweep Points** softkey and enter the number of sweep points.
4. Select the sweep mode using the **Continuous Sweep** or **Single Sweep** softkey.
5. To repeat the single sweep, press the **Continue Single Sweep** softkey.

Softkeys of the sweep menu

The following table shows all softkeys available in the sweep menu. It is possible that your instrument configuration does not provide all softkeys. If a softkey is only available with a special option, model or (measurement) mode, this information is delivered in the corresponding softkey description.

If the Spectrogram Measurement option (K14) is activated, this menu provides additional functionality. For details refer to "[Softkeys of the sweep menu \(Spectrogram view\)](#)" on page 4.185.

Command
Continuous Sweep
Single Sweep
Continue Single Sweep
Sweeptime Manual
Sweeptime Auto
Sweep Count
Sweep Points

Continuous Sweep

Sets the continuous sweep mode: the sweep takes place continuously according to the trigger settings. This is the default setting. The trace averaging is determined by the sweep count value (see **Sweep Count** softkey).

If the Spectrogram Measurement option (K14) is activated, this softkey provides additional functionality. For details refer to **Continuous Sweep Start/Stop** softkey in the sweep menu of this option.

→ Remote: INIT:CONT ON

Single Sweep

Sets the single sweep mode: starts the number of sweeps that are defined by using the **Sweep Count** softkey. The measurement stops after the defined number of sweeps has been performed.

→ Remote: INIT:CONT OFF

Continue Single Sweep

Repeats the number of sweeps set by using the **Sweep Count** softkey, without deleting the trace of the last measurement.

This is particularly of interest when using the trace configurations **Average** or **Max Hold** to take previously recorded measurements into account for averaging / maximum search. For details on trace configuration refer to "[Setting Traces - TRACE Key](#)" on page 4.35.

→ Remote: INIT:CONM

Sweeptime Manual

Opens an edit dialog box to enter the sweep time. For details see **Sweeptime Manual** softkey in the bandwidth menu.

→ Remote: SWE:TIME 10s

Sweeptime Auto

Sets the automatic sweep time mode. For details see **Sweeptime Auto** softkey in the bandwidth menu.

→ Remote: SWE:TIME:AUTO ON

Sweep Count

Opens an edit dialog box to enter the number of sweeps to be performed in the single sweep mode. Values from 0 to 32767 are allowed. If the values 0 or 1 are set, one sweep is performed. The sweep count is applied to all the traces in a diagram.

The sweep count set in the sweep menu is the same as that in the trace menu (for further details see **Sweep Count** softkey). If the trace configurations **Average**, **Max Hold** or **Min Hold** are set, the sweep count value also determines the number of averaging or maximum search procedures (for details on trace configuration see "[Setting Traces - TRACE Key](#)" on page 4.35).

Example:

TRACE key - **Trace Mode** softkey - **Mode Max Hold** softkey

SWEEP key - **Sweep Count** softkey - **Average Sweep Count** dialog box: enter 10

Single Sweep softkey: R&S FSL performs the **Max Hold** function over 10 sweeps.

→ Remote: SWE:COUN 64

Sweep Points

Opens an edit dialog box to enter the number of measured values to be collected during one sweep.

– Entry via rotary knob:

In the range from 101 to 1001, the sweep points are increased or decreased in steps of 100 points.

In the range from 1001 to 32001, the sweep points are increased or decreased in steps of 1000 points.

– Entry via keypad:

All values in the defined range can be set.

The default value is 501 sweep points. If a value \neq 501 is set, the auto peak detector is turned off automatically.

→ Remote: SWE:POIN 501

Triggering the Sweep - TRIG Key

The **TRIG** key is used to set trigger mode, trigger threshold, trigger delay, trigger polarity and for gated sweep the gate configuration.

To open the trigger menu

- Press the **TRIG** key.
The trigger menu is displayed.

Menu and softkey description

- ["Softkeys of the trigger menu"](#) on page 4.29

To display help to a softkey, press the **HELP** key and then the softkey for which you want to display help. To close the help window, press the **ESC** key. For further information refer to section "How to use the Help System".

Further information

- ["Trigger mode overview"](#) on page 4.27

Tasks

- [To specify the trigger settings](#)
- [To use gated sweep operation \(option Gated Sweep, B8\)](#)
- [To trigger on TV signals \(zero span and option TV Trigger, B6\)](#)

To specify the trigger settings

1. Press the **Trg / Gate Source** softkey to select the trigger mode (for details see ["Trigger mode overview"](#) on page 4.27).
2. Press the **Trg / Gate Level** softkey to set the trigger level.
3. Press the **Trigger Offset** softkey to set the trigger offset.
4. For details on gated sweep operation, see ["To use gated sweep operation \(option Gated Sweep, B8\)"](#) on page 4.25.
5. For details on TV signal triggering, see ["To trigger on TV signals \(zero span and option TV Trigger, B6\)"](#).

To use gated sweep operation (option Gated Sweep, B8)

By using a gate in sweep mode and stopping the measurement while the gate signal is inactive, the spectrum for pulsed RF carriers can be displayed without the superposition of frequency components generated during switching. Similarly, the spectrum can also be examined for an inactive carrier. The sweep can be controlled by an external gate or by the internal power trigger.

Gated sweep operation is also possible for span = 0. This enables - e.g. in burst signals - level variations of individual slots to be displayed versus time.

1. Press the **Gate Settings** submenu softkey to define the settings of the gate mode.

At the center frequency a transition to zero span is made and the time parameters gate delay and gate length are displayed as vertical lines to adjust them easily.

When quitting the **Gate Settings** submenu, the original span is retrieved so the desired measurement can be performed with the accurately set gate.

2. To set the parameters gate delay and gate length highly accurate, press the **Sweep Time** softkey to alter the x-axis in a way that the signal range concerned (e.g. one full burst) is displayed.
3. Press the **Gate Delay** softkey to set the sampling time in a way that the desired portion of the signal is shown.
4. Press the **Gate Mode Lvl/Edge** softkey to set the gate mode.
5. If the **Edge** gate mode has been selected, press the **Gate Length** softkey to set the sampling duration in a way that the desired portion of the signal is shown.
6. Press the **Trg / Gate Polarity Pos/Neg** softkey to set the polarity of the trigger source.
7. Press the **Gated Trigger** softkey to activate the gated sweep mode.

To indicate that a gate is used for the sweep, the enhancement label **GAT** is displayed on the screen. This label appears to the right of the window for which the gate is configured.

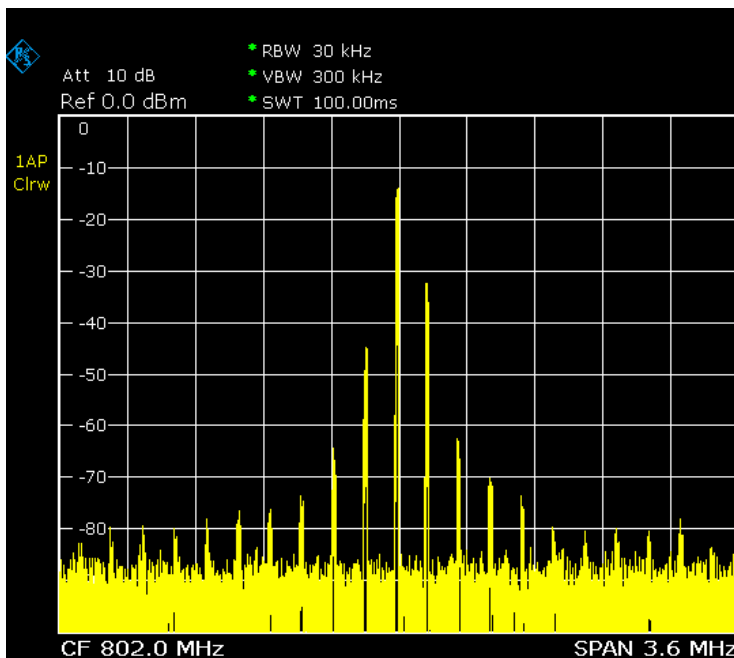

Fig. 4-1: TDMA signal with GATE OFF

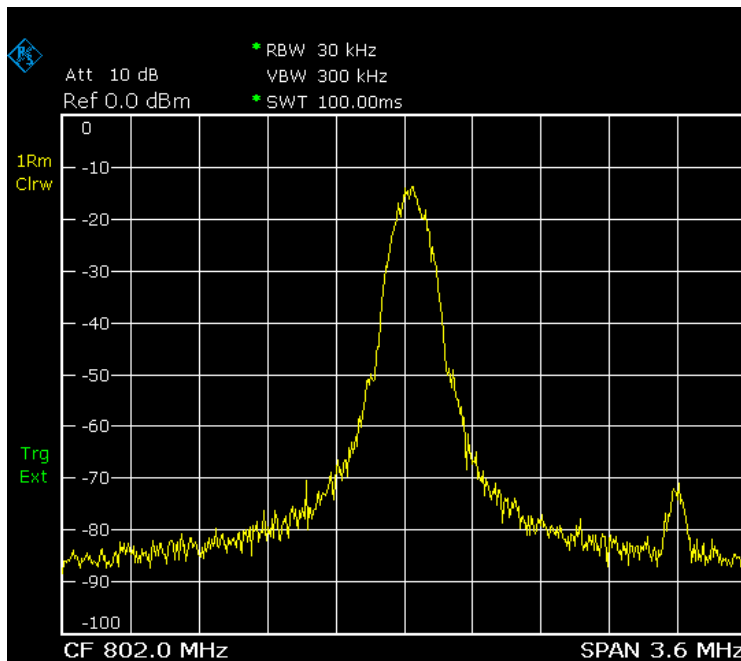

Fig. 4-2: Pulsed signal with GATE ON

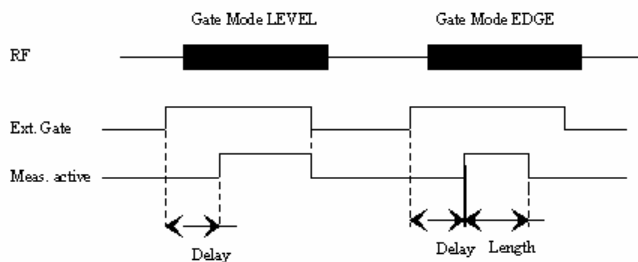

Fig. 4-3: Timing diagram for GATE, GATE DELAY and GATE LENGTH

To trigger on TV signals (zero span and option TV Trigger, B6)

1. Press the **TV Trig Settings** submenu softkey to switch the TV trigger on and define the settings for triggering on TV signal.
2. To configure the TV trigger, press the **Vert Sync**, **Vert Sync Odd Field**, **Vert Sync Even Field** or **Hor Sync** softkey.
3. Press the **Video Pol Pos/Neg** softkey to set the polarity of the video signal.
4. Press the **Lines 625/525** softkey to set the line system to be used.

Option TV Trigger, B6, is available from firmware version 1.10.

Trigger mode overview

The R&S FSL offers the following trigger modes:

- **Free Run**

The start of a sweep is not triggered. Once a measurement is completed, another is started immediately.

- **External**

Triggering via a TTL signal at the input connector **EXT TRIG / GATE IN** on the rear panel.

- **Video**

Triggering by the displayed voltage.

A horizontal trigger line is shown in the diagram. It is used to set the trigger threshold from 0% to 100% of the diagram height.

- **IF Power**

Triggering of the measurement via signals which are outside the measurement channel.

For this purpose, the R&S FSL uses a level detector at the second intermediate frequency. Its threshold can be set in a range between -50 dBm and -10 dBm at the input mixer. The resulting trigger level at the RF input is calculated via the following formula:

$$Mixerlevel_{min} + RFAtt - PreampGain \leq Input\ Signal \leq Mixerlevel_{max} + RFAtt - PreampGain$$

The bandwidth at the intermediate frequency is 20 MHz. The R&S FSL is triggered as soon as the trigger threshold is exceeded within a 10 MHz range around the selected frequency (= start frequency in the frequency sweep).

Thus, the measurement of spurious emissions, e.g. for pulsed carriers, is possible even if the carrier lies outside the selected frequency span.

- **TV (option TV Trigger, B6, available from firmware version 1.10)**

Triggering of the measurement on TV signals. In this trigger mode, only the **Auto Peak** and the **Sample** detectors are available (for details refer to "[Detector overview](#)" on page 4.38).

In order to display different sections of a TV video signal, the R&S FSL derives several trigger signals from the video signals. This allows triggering as well on the frame repetition as on each line of the TV video signal.

The filter bandwidth is constant: 4.0 MHz for standards with 525 lines or 5.0 MHz for standards with 625 lines. The position of the filter is determined by the firmware in order to place the 3 dB filter bandwidth on the center frequency, as shown in the diagram below. For the center frequency, the value of the vision carrier frequency should be set.

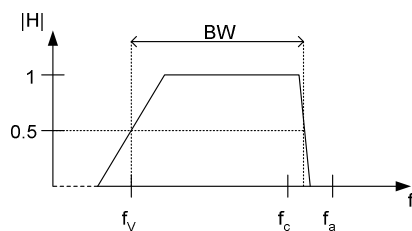

fv = vision carrier frequency

fa = aural carrier frequency

fc = chrominance sub-carrier frequency

BW = -3dB filter bandwidth

Fig. 4-4: 3 dB Filter bandwidth (option TV Trigger, B6, available from firmware version 1.10)

- **Time Trigger (available from firmware version 1.60)**

Triggering of the measurement by a time interval, set via the **Repetition Intervall** softkey.

Softkeys of the trigger menu

The following table shows all softkeys available in the trigger menu. It is possible that your instrument configuration does not provide all softkeys. If a softkey is only available with a special option, model or (measurement) mode, this information is delivered in the corresponding softkey description.

Menu / Command	Command
Trg / Gate Source	
Trg / Gate Level	
Trg / Gate Polarity Pos/Neg	
Trigger Offset / Repetition Intervall	
Gated Trigger	
Gate Settings ↓	Gate Mode Lvl/Edge
	Gate Delay
	Gate Length
	Trg / Gate Source
	Trg / Gate Level
	Trg / Gate Polarity Pos/Neg
	Sweep Time
More ↓	
IF Power Retrigger Holdoff	
IF Power Retrigger Hysteresis	
TV Trig Settings	Vert Sync
	Vert Sync Odd Field
	Vert Sync Even Field
	Hor Sync
	Video Pol Pos/Neg
	Lines 625/525
	TV Free Run On/Off

Trg / Gate Source

Opens the **Trigger / Gate Source** dialog box to select the trigger / gate mode. For detailed information on trigger modes see "[Trigger mode overview](#)" on page 4.27.

The gate-related settings are only available with option Gated Sweep, R&S FSL-B8. As gate modes, all modes apart from the TV Trigger mode (option TV Trigger, B6, available from firmware version 1.10) are available. For details see also "[To use gated sweep operation \(option Gated Sweep, B8\)](#)" on page 4.25.

The default setting is **Free Run**. If a trigger mode other than **Free Run** has been set, the enhancement label **TRG** is displayed.

- Remote: TRIG:SOUR IMM | VID | IFP | EXT | TV | TIME (Free Run, Video, IF Power, Extern, TV Trigger, Time Trigger)
- Remote: SWE:EGAT:SOUR EXT (Extern)

Trg / Gate Level

Opens an edit dialog box to enter the trigger / gate level. The gate-related settings are only available with option Gated Sweep, R&S FSL-B8. For details see also "[Trigger mode overview](#)" on page 4.27 and "[To use gated sweep operation \(option Gated Sweep, B8\)](#)" on page 4.25.

In the **Time Trigger** mode, this softkey is not available.

- Remote: TRIG:LEV:VID 50PCT
- Remote: TRIG:LEV:IFP -30DBM

Trg / Gate Polarity Pos/Neg

Sets the polarity of the trigger / gate source. The gate-related settings are only available with option Gated Sweep, R&S FSL-B8.

The sweep starts after a positive or negative edge of the trigger signal. The default setting is **Pos**. The setting applies to all modes with the exception of the **Free Run** mode.

level triggering In the setting **Pos** the sweep is stopped by the logic '0' signal and restarted by the logical '1' signal after the gate delay time has elapsed.

edge triggering The sweep is continued on a '0' to '1' transition for the gate length duration after the gate delay time has elapsed.

In the **Time Trigger** mode, this softkey is not available.

For details also see "[To use gated sweep operation \(option Gated Sweep, B8\)](#)" on page 4.25.

- Remote: TRIG:SLOP POS
- Remote: SWE:EGAT:POL POS

Trigger Offset

Opens an edit dialog box to enter the time offset between the trigger signal and the start of the sweep. The time may be entered in multiples of 125 ns in the range -100 s to 100 s (default 0 s).

offset > 0: start of the sweep is delayed

offset < 0: sweep starts earlier (pre-trigger)

only possible for span = 0 and gated trigger switched off
not possible if RMS or average detector activated

maximum allowed range and the maximum resolution limited by the sweep time:

$$range_{max} = -499/500 \times sweep\ time$$

$$resolution_{max} = sweep\ time/500$$



For the option TV Trigger, B6 (available from firmware version 1.10), the allowed offset ranges from -50 μs to +50 μs. If the trigger source is changed to TV trigger and the set trigger offset is out of range, the trigger offset is adopted to the closest value allowed.

In the **External** or **IF Power** trigger mode, a common input signal is used for both trigger and gate. Therefore changes to the gate delay will affect the trigger delay (trigger offset) as well.

In the **Time Trigger** mode, this softkey is not available.

→ Remote: TRIG:HOLD 10US

Repetition Intervals (Time Trigger mode)

Opens an edit dialog box to enter the time interval after which the sweep is started. The possible values range from 100 ms to 5000 s.

This softkey is available from firmware version 1.60.

→ Remote: TRIG:TIME:RINT 50

Gated Trigger (option Gated Sweep, B8)

Switches the sweep mode with gate on or off .

This softkey requires the following trigger mode:

span > 0 **External** or **IF Power**

span = 0 **External** or **IF Power** or **Video**

If a different mode is active, the **IF Power** trigger mode is automatically selected.

If the gate is switched on, a gate signal applied to the rear panel connector EXT TRIGGER/GATE or the internal IF power detector controls the sweep of the analyzer.

In the **Time Trigger** mode, this softkey is not available.

For details also see "[To use gated sweep operation \(option Gated Sweep, B8\)](#)" on page 4.25.

→ Remote: SWE:EGAT ON

→ Remote: SWE:EGAT:SOUR IFP | EXT

Gate Settings (option Gated Sweep, B8)

Opens a submenu to make all the settings required for gated sweep operation.

In the **Time Trigger** mode, this softkey is not available.

For details also see "[To use gated sweep operation \(option Gated Sweep, B8\)](#)" on page 4.25.

Gate Mode Lvl/Edge (option Gated Sweep, B8)

Sets the gate mode. As settings level-triggered or edge-triggered gate mode can be selected.

For details also see "[To use gated sweep operation \(option Gated Sweep, B8\)](#)" on page 4.25.

→ Remote: SWE:EGAT:TYPE EDGE

Gate Delay (option Gated Sweep, B8)

Opens an edit dialog box to enter the gate delay time between the gate signal and the continuation of the sweep. Values between 125 ns and 100 s are allowed. The delay position on the time axis in relation to the sweep is indicated by a line labeled **GD**.

This is useful for e.g. taking into account a delay between the gate signal and the stabilization of an RF carrier.

As a common input signal is used for both trigger and gate when selecting the **External** or **IF Power** trigger mode, changes to the gate delay will affect the trigger delay (trigger offset) as well.

For details also see "[To use gated sweep operation \(option Gated Sweep, B8\)](#)" on page 4.25.

→ Remote: SWE:EGAT:HOLD 1US

Gate Length (Gate Mode Edge)

Opens an edit dialog box to enter the gate length. Values between 125 ns and 100 s are allowed. The gate length in relation to the sweep is indicated by a line labeled **GL**.

The length of the gate signal defines if the sweep is to be interrupted. Only in the edge-triggered mode the gate length can be set, while in the level-triggered the gate length depends on the length of the gate signal.

For details also see "[To use gated sweep operation \(option Gated Sweep, B8\)](#)" on page 4.25.

→ Remote: SWE:EGAT:LENG 100US

Sweep Time (option Gated Sweep, B8)

Opens an edit dialog box to change the sweep time in order to obtain a higher resolution for positioning gate delay and gate length. When quitting the **Gate Settings** submenu, the original sweep time is retrieved.

For details also see "[To use gated sweep operation \(option Gated Sweep, B8\)](#)" on page 4.25.

IF Power Retrigger Holdoff

Opens an edit dialog box to define the value for the IF power trigger holdoff. This softkey is only available if the IF power trigger is selected as the trigger source. The holdoff value in s is the time which must pass since another IF power trigger event may happen. The range of the value is between 150 ns and 10 s in the step width of 10 ns.

This softkey is available from firmware version 1.30.

→ Remote: TRIG:IFP:HOLD 200 ns

IF Power Retrigger Hysteresis

Opens an edit dialog box to define the value for the IF power trigger hysteresis. This softkey is only available if the IF power trigger is selected as the trigger source. The hysteresis in dB is the value the input signal must decay below the IF power trigger level in order to allow an IF power trigger starting the measurement. The range of the value is between 3 dB and 50 dB in the step width of 1 dB.

This softkey is available from firmware version 1.30.

→ Remote: TRIG:IFP:HYST 10DB

TV Trig Settings (zero span and option TV Trigger, B6)

Switches the TV trigger on and opens a submenu to configure the TV signal parameters.

Option TV Trigger, B6, is available from firmware version 1.10.

→ Remote: TRIG:SOUR TV

Vert Sync (zero span and option TV Trigger, B6)

Sets the trigger on the vertical sync signal. The R&S FSL triggers on the frame repetition signal without distinction between the two fields.

Option TV Trigger, B6, is available from firmware version 1.10.

→ Remote: TRIG:VID:FIEL:SEL ALL

Vert Sync Odd Field (zero span and option TV Trigger, B6)

Sets the trigger on the vertical sync signal of the first field.

Option TV Trigger, B6, is available from firmware version 1.10.

→ Remote: TRIG:VID:FIEL:SEL ODD

Vert Sync Even Field (zero span and option TV Trigger, B6)

Sets the trigger on the vertical sync signal of the second field.

Option TV Trigger, B6, is available from firmware version 1.10.

→ Remote: TRIG:VID:FIEL:SEL EVEN

Hor Sync (zero span and option TV Trigger, B6)

Sets the trigger on the horizontal sync signal and opens an edit dialog box to enter the corresponding line. Depending on the selected line system (for details see **Lines 625/525** softkey), values from 1 to 525 or 1 to 625 are allowed. If the range is exceeded, the maximum possible line number will be set.

The default setting is 17, which is used to trigger according to CCIR 473-4 on test line 17.

Option TV Trigger, B6, is available from firmware version 1.10.

→ Remote: TRIG:VID:LINE:NUM 17

Video Pol Pos/Neg (zero span and option TV Trigger, B6)

Sets the polarity of the video signal. Default setting is **Neg**.

Positive video polarity is to be selected e.g. for standard L signals, negative video polarity for signals according to the standards B/G/I/M (color standard PAL or NTSC).

Option TV Trigger, B6, is available from firmware version 1.10.

→ Remote: TRIG:VID:SSIG:POL NEG

Lines 625/525 (zero span and option TV Trigger, B6)

Sets the line system to be used. Default setting is 625 lines.

Option TV Trigger, B6, is available from firmware version 1.10.

→ Remote: TRIG:VID:FORM:LPFR 625

TV Free Run On/Off (zero span and option TV Trigger, B6)

Activates or deactivates the free run trigger mode for option TV Trigger, B6. For details on trigger modes refer to "[Trigger mode overview](#)" on page 4.27. In this mode, only the trace modes **Clear Write** and **View** are available (see also "[Trace mode overview](#)" on page 4.36).

This softkey is available from firmware version 1.30.

→ Remote: TRIG:VID:CONT ON

Setting Traces - TRACE Key

The **TRACE** key is used to configure the data acquisition for measurement and the analysis of the measurement data.

The R&S FSL is capable of displaying up to six different traces at a time in a diagram. A trace consists of a maximum of 501 measurement points on the horizontal axis (frequency or time). If more measured values than measurement points are available, several measured values are combined in one measurement point.

The trace functions are subdivided as follows:

- Display mode of trace (**Clear Write**, **View** and **Blank**). For details on trace modes see "[Trace mode overview](#)" on page 4.36.
- Evaluation of the trace as a whole (**Average**, **Max Hold** and **Min Hold**). For details on trace modes see "[Trace mode overview](#)" on page 4.36. For details on averaging see "[Description of the averaging method](#)" on page 4.37.
- Evaluation of individual measurement points of a trace. For details on detectors see "[Detector overview](#)" on page 4.38.

To open the trace menu

- Press the **TRACE** key.

The trace menu is displayed. The **Trace Configuration** dialog box is displayed.

Menu and softkey description

- "[Softkeys of the trace menu](#)" on page 4.39

To display help to a softkey, press the **HELP** key and then the softkey for which you want to display help. To close the help window, press the **ESC** key. For further information refer to section "How to use the Help System".

Further information

- "[Trace mode overview](#)" on page 4.36
- "[Detector overview](#)" on page 4.38
- "[Description of the averaging method](#)" on page 4.37
- "[ASCII file export format](#)" on page 4.46

Task

- [To specify the trace settings](#)

To specify the trace settings

1. Press the **Trace 1 2 3 4 5 6** softkey to select the trace.
2. Press the **Trace Mode** softkey to select the trace mode for the selected trace (for details see "[Trace mode overview](#)" on page 4.36).
3. Press the **Detector Auto Select** softkey for automatic detector selection or press the **Detector Manual Select** softkey to select a detector (for details see "[Detector overview](#)" on page 4.38).
4. To change the sweep count setting, which also determines trace averaging, press the **Sweep Count** softkey.

5. To deactivate the reset of the traces in **Min Hold** and **Max Hold** mode after some specific parameter changes, press the **Hold/Cont** softkey.
6. To copy a trace into another trace memory, press the **Copy Trace** softkey.
Upon copying, the contents of the selected memory are overwritten and the new contents are displayed in the **View** mode.
7. To export the active trace in ASCII format:
 - Press the **More** softkey.
 - If necessary, press the **Decim Sep** softkey to change the decimal separator with floating-point numerals.
 - Press the **ASCII File Export** softkey to enter the ASCII file export name.The active trace is saved in ASCII format on the flash disk or a USB device.

Trace mode overview

The traces can individually be activated for a measurement or frozen after completion of a measurement. Traces that are not activated are hidden. Each time the trace mode is changed, the selected trace memory is cleared.

The R&S FSL offers 6 different trace modes:

- **Clear Write**

Overwrite mode: the trace is overwritten by each sweep. All available detectors can be selected. This is the default setting.

- **Max Hold**

The maximum value is determined over several sweeps and displayed. The R&S FSL saves the sweep result in the trace memory only if the new value is greater than the previous one. The detector is automatically set to **Positive Peak**.

This mode is especially useful with modulated or pulsed signals. The signal spectrum is filled up upon each sweep until all signal components are detected in a kind of envelope.

This mode is not available for statistics measurements or if the TV trigger is active and the **TV Free Run On/Off** softkey is set to **ON** (option TV Trigger, B6).

- **Min Hold**

The minimum value is determined from several measurements and displayed. The R&S FSL saves for each sweep the smallest of the previously stored/currently measured values in the trace memory. The detector is automatically set to **Negative Peak**.

This mode is useful e.g. for making an unmodulated carrier in a composite signal visible. Noise, interference signals or modulated signals are suppressed whereas a CW signal is recognized by its constant level.

This mode is not available for statistics measurements or if the TV trigger is active and the **TV Free Run On/Off** softkey is set to **ON** (option TV Trigger, B6).

- **Average**

The average is formed over several sweeps. All available detectors can be selected. If the detector is automatically selected, the sample detector is used. For details see also "[Description of the averaging method](#)" on page 4.37.

This mode is not available for statistics measurements or if the TV trigger is active and the **TV Free Run On/Off** softkey is set to **ON** (option TV Trigger, B6).

- **View**

The current contents of the trace memory is frozen and displayed.

If a trace is frozen, the instrument settings, apart from level range and reference level (see below), can be changed without impact on the displayed trace. The fact that the trace and the current instrument setting do not correspond any more is indicated by the enhancement label "*" at the left edge of the grid.

If level range or reference level are changed, the R&S FSL automatically adapts the measured data to the changed display range. This allows an amplitude zoom to be made after the measurement in order to show details of the trace.

- **Blank**

Hides the selected trace.

Description of the averaging method

Averaging is carried out over the measurement points derived from the measurement samples. Several measured values may be combined in a measurement point. This means that with linear level display the average is formed over linear amplitude values. The sweep mode (continuous or single sweep, for details see "[Configuring the Sweep Mode - SWEEP Key](#)" on page 4.22) and running averaging apply to the average display analogously. In principle, two methods for calculating the average are used: continuous averaging and averaging over the selected number of sweeps.

- sweep count > 1

Depending on the relation of the following two parameters, two different situations exist:

n = number of sweeps performed since measurement start

c = sweep count (number of sweeps forming one statistics cycle)

- $n \leq c$

In single sweep or continuous sweep mode during the first statistics cycle, averaging over the selected number of sweeps is performed. The average trace n is calculated at each measurement point according to:

$$Avg(n) = \frac{n-1}{n} Avg(n-1) + \frac{1}{n} Curr(n) \quad \text{Equ. 4-1}$$

with Avg = average trace; $Curr$ = current trace

Until the first statistics cycle is completed ($n < c$), a preliminary average is displayed which represents the arithmetic mean value over all measured sweeps. With n increasing, the displayed trace is increasingly smoothed since there are more single sweeps for averaging.

When the first statistics cycle is completed ($n = c$), the average trace is saved in the trace memory.

- $n > c$

In continuous sweep mode after the first statistics cycle, continuous averaging is performed. The average trace n is calculated at each measurement point according to:

$$Avg(n) = \frac{c-1}{c} Avg(n-1) + \frac{1}{c} Curr(n) \quad \text{Equ. 4-2}$$

with Avg = average trace; $Curr$ = current trace

In single sweep mode, the same formula holds true if the **Continue Single Sweep** softkey is pressed.

- sweep count = 0

In continuous sweep mode, a continuous average is calculated according to Equ. 4-3.

with $c = 10$:

$$Avg(n) = \frac{9}{10} Avg(n-1) + \frac{1}{10} Curr(n) \quad \text{Equ. 4-3}$$

with Avg = average trace; Curr = current trace

Due to the weighting between the current trace and the average trace, past values have practically no influence on the displayed trace after about ten sweeps. With this setting, signal noise is effectively reduced without need for restarting the averaging process after a change of the signal.

- sweep count = 1

The current trace is displayed. No averaging is performed. This is a special case of Equ. 4-1 with n = 0.

Detector overview

The measurement detector for the individual display modes can be selected directly by you or set automatically by R&S FSL. The detector activated for the specific trace is identified in the respective trace display field in form of an abbreviation (for details see detector list).

The detectors of the R&S FSL are implemented as pure digital devices. They collect signal power data within each measured point during a sweep. The default number of sweep points is 501. The following detectors are available:

Detector	Indicator	Function
auto peak detector (Auto Peak)	Ap	determines the maximum and the minimum value within a measurement point
peak detector (Positive Peak)	Pk	determines the maximum value within a measurement point
min peak detector (Negative Peak)	Mi	determines the minimum value within a measurement point
sample detector (Sample)	Sa	selects a random value within a measurement point
RMS detector (RMS)	Rm	determines the root mean square power within a measurement point
average detector (Average)	Av	determines the linear average power within a measurement point
quasi peak detector (Quasi Peak)	QP	determines the quasipeak power within a measurement point for EMI measurements (available from firmware version 1.10)

If the TV trigger is active, only the auto peak and the sample detector are available.

The result obtained from the selected detector within a measurement point is displayed as the power value at this measurement point.

All detectors work in parallel in the background, which means that the measurement speed is independent of the detector combination used for different traces.



During a frequency sweep, R&S FSL increments the 1st local oscillator in steps that are smaller than approximately 1/10 of the bandwidth. This makes sure that the oscillator step speed is conforming to the hardware settling times and does not affect the precision of the measured power.

The number of measured values taken during a sweep is independent of the number of oscillator steps. It is always selected as a multiple or a fraction of 501 (= default number of trace points displayed on the screen). Choosing less than 501 measured values (e.g. 125 or 251) will lead to an interpolated measurement curve, choosing more than 501 points (e.g. 1001, 2001 ...) will result in several measured values being overlaid at the same frequency position.

Softkeys of the trace menu

The following table shows all softkeys available in the trace menu. It is possible that your instrument configuration does not provide all softkeys. If a softkey is only available with a special option, model or (measurement) mode, this information is delivered in the corresponding softkey description.

Menu / Command	Command
Trace 1 2 3 4 5 6	
Trace Mode ↓	Clear Write
	Max Hold
	Min Hold
	Average
	View
	Blank
Detector Auto Select	
Detector Manual Select ↓	Detector Auto Peak
	Detector Positive Peak
	Detector Negative Peak
	Detector Sample
	Detector RMS
	More ↓
	Detector Average
	Detector Quasi Peak
Sweep Count	
Hold/Cont	
More ↓	
Trace 1 2 3 4 5 6	
Copy Trace	

Menu / Command	Command
ASCII File Export	
Decim Sep	
Trace Math	
Trace Math Position	
Average Mode	LOG
	LIN
	POWER

Trace 1 2 3 4 5 6

Selects the active trace (1, 2, 3, 4, 5, 6). The default setting is trace 1 in the overwrite mode (see **Clear Write** mode), the other traces are switched off (see **Blank** mode).

→ Remote: (selected via numeric suffix of :TRACe<1 . . . 6>)

Trace Mode

Opens a submenu to select the trace mode. For details see "[Trace mode overview](#)" on page 4.36.

Clear Write

Selects the **Clear Write** mode. For details see "[Trace mode overview](#)" on page 4.36.

This softkey is available from firmware version 1.80.

→ Remote: DISP:TRAC:MODE WRIT

Max Hold

Selects the **Max Hold** mode. For details see "[Trace mode overview](#)" on page 4.36.

This softkey is available from firmware version 1.80.

→ Remote: DISP:TRAC:MODE MAXH

Min Hold

Selects the **Min Hold** mode. For details see "[Trace mode overview](#)" on page 4.36.

This softkey is available from firmware version 1.80.

→ Remote: DISP:TRAC:MODE MINH

Average

Selects the **Average** mode. For details see "[Trace mode overview](#)" on page 4.36.

This softkey is available from firmware version 1.80.

→ Remote: DISP:TRAC:MODE AVER

View

Selects the **View** mode. For details see "[Trace mode overview](#)" on page 4.36.

This softkey is available from firmware version 1.80.

→ Remote: DISP:TRAC:MODE VIEW

Blank

Selects the **Blank** mode. For details see "[Trace mode overview](#)" on page 4.36.

This softkey is available from firmware version 1.80.

→ Remote: DISP:TRAC OFF

Detector Auto Select

Selects the optimum detector for the selected trace and filter mode. This is the default setting. For details see also "[Detector overview](#)" on page 4.38.

Trace mode	Detector (band-pass filter)	Detector (FFT filter)
Clear/Write	Auto Peak	Max Peak
Average	Sample	Sample
Max Hold	Max Peak	Max Peak
Min Hold	Min Peak	Max Peak

→ Remote: DET:AUTO ON

Detector Manual Select

Opens a submenu to select the detector. For details see "[Detector overview](#)" on page 4.38.

Detector Auto Peak

Selects the **Auto Peak** detector. For details see "[Detector overview](#)" on page 4.38.

This softkey is available from firmware version 1.80.

→ Remote: DET APE

Detector Positive Peak

Selects the **Positive Peak** detector. For details see "[Detector overview](#)" on page 4.38.

This softkey is available from firmware version 1.80.

→ Remote: DET POS

Detector Negative Peak

Selects the **Negative Peak** detector. For details see "[Detector overview](#)" on page 4.38.

This softkey is available from firmware version 1.80.

→ Remote: DET NEG

Detector Sample

Selects the **Sample** detector. For details see "[Detector overview](#)" on page 4.38.

This softkey is available from firmware version 1.80.

→ Remote: DET SAMP

Detector RMS

Selects the **RMS** detector. For details see "[Detector overview](#)" on page 4.38.

This softkey is available from firmware version 1.80.

→ Remote: DET RMS

Detector Average

Selects the **Average** detector. For details see "[Detector overview](#)" on page 4.38.

This softkey is available from firmware version 1.80.

→ Remote: DET AVER

Detector Quasi Peak

Selects the **Quasi Peak** detector. For details see "[Detector overview](#)" on page 4.38.

This softkey is available from firmware version 1.80.

→ Remote: DET QPE

Sweep Count

Opens an edit dialog box to enter the number of sweeps used for averaging. Values from 0 to 32767 are allowed. The default setting is 0. The sweep count is applied to all the traces in a diagram. The sweep count set in the trace menu is the same as that in the sweep menu (for further details see **Sweep Count** softkey).

In the continuous sweep mode, the sweep count value determines the trace averaging:

- sweep count = 0: continuous averaging
- sweep count = 1: no averaging
- sweep count > 1: averaging over the selected number of sweeps; in the continuous sweep mode averaging is performed until the set number of sweeps is attained and is then continued as continuous averaging (see also "[Description of the averaging method](#)" on page 4.37).

→ Remote: SWE:COUN 64

Hold/Cont

Switches on or off the reset of the traces in Min Hold, Max Hold and Average mode after some specific parameter changes have been made. The default setting is off.

Normally, the measurement is started anew after parameter changes, before the measurement results are evaluated (e.g. using a marker). In all cases that require a new measurement after parameter changes, the trace is reset automatically to avoid false results (e.g. with span changes). For applications that require no reset after parameter changes, the automatic reset can be switched off.

→ Remote: `DISP:TRAC:MODE:HCON ON`

Copy Trace

Opens an edit dialog box to enter the number of the trace memory, in which the currently selected trace shall be copied.

→ Remote: `TRAC:COPY TRACE1,TRACE2`

ASCII File Export

Opens the **ASCII File Export Name** dialog box and saves the active trace in ASCII format to the specified file and directory.

The file consists of the header containing important scaling parameters and a data section containing the trace data. For details on an ASCII file see "[ASCII file export format](#)" on page 4.46.

This format can be processed by spreadsheet calculation programs, e.g. MS Excel. It is necessary to define ';' as a separator for the data import. Different language versions of evaluation programs may require a different handling of the decimal point. It is therefore possible to select between separators '.' (decimal point) and ',' (comma) using the **Decim Sep** softkey.

→ Remote: `FORM ASC`

→ Remote: `MMEM:STOR:TRAC 1, 'TRACE.DAT'`

Decim Sep

Selects the decimal separator with floating-point numerals for the ASCII file export to support evaluation programs (e.g. MS Excel) in different languages. The values '.' (decimal point) and ',' (comma) can be set. For details see also **ASCII File Export** softkey.

→ Remote: `FORM:DEXP:DSEP POIN`

Trace Math

Opens the **Trace Mathematics** dialog box to define which trace is subtracted from trace 1. The result is displayed in trace 1 and refers to the zero point defined with the **Trace Math Position** softkey. The following subtractions can be performed:

T1->T1-T2	Subtracts trace 2 from trace 1.
T1->T1-T3	Subtracts trace 3 from trace 1
T1->T1-T4	Subtracts trace 4 from trace 1
T1->T1-T5	Subtracts trace 5 from trace 1
T1->T1-T6	Subtracts trace 6 from trace 1

If the **Trace Math Off** option is activated, the function is switched off (default setting).

This softkey is available from firmware version 1.30.

- Remote: CALC1:MATH (TRACE1 - TRACE2)
- Remote: CALC:MATH:STAT ON

Trace Math Position

Opens an edit dialog box to define the zero point in % of the diagram height. The range of values extends from -100% to +200%.

This softkey is available from firmware version 1.30.

- Remote: CALC:MATH:POS 50PCT

Average Mode

Opens a submenu to select the averaging method for the average trace mode. The submenu contains the following softkeys.

This softkey is available from firmware version 1.90.

Command
LOG
LIN
POWER

Logarithmic averaging is preferred to display signals with a low signal to noise ratio. While positive peak values are decreased in logarithmic averaging due to the characteristics involved, it is also true that negative peaks are increased relative to the average value. If the distorted amplitude distribution is averaged, a value is obtained that is smaller than the actual average value. The difference is -2.5 dB.

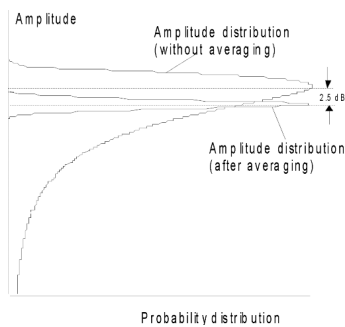

This low average value is usually corrected in noise power measurements by a 2.5 dB factor. Therefore the R&S FSL offers the selection of linear averaging. The trace data is converted to linear values prior to averaging, then averaged and reconverted to logarithmic values. After these conversions the data is displayed on the screen. The average value is always correctly displayed irrespective of the signal characteristic.

In case of stationary sinusoidal signals all averaging methods have the same results.

LOG

Activates logarithmic averaging.

This averaging method only takes effect if the grid is set to a logarithmic scale (see **Range Log** softkey). In this case the values are averaged in dBm. Otherwise (i.e. with linear scaling) the behaviour is the same as with linear averaging (see **LIN** softkey). For further information on logarithmic scaling refer to the **Average Mode** softkey.

This softkey is available from firmware version 1.90.

→ Remote: CALC:MATH:MODE LOG

LIN

Activates linear voltage or power averaging, depending on the selected unit.

Linear averaging means that the power level values are converted into linear units prior to averaging. After the averaging, the data is converted back into its original unit.

The averaging is done in two ways (depending on the set unit - see **Unit** softkey):

- The unit is set to either W or dBm: the data is converted into W prior to averaging, i.e. averaging is done in W.
- The unit is set to either V, A, dBmV, dB μ V, dB μ A or dBpW: the data is converted into V prior to averaging, i.e. averaging is done in V.

This softkey is available from firmware version 1.90.

→ Remote: CALC:MATH:MODE LIN

POWER

Activates linear power averaging.

The power level values are converted into unit Watt prior to averaging. After the averaging, the data is converted back into its original unit.

Unlike the **LIN** softkey, the averaging is always done in W.

This softkey is available from firmware version 1.90.

→ Remote: CALC:MATH:MODE POW

ASCII file export format

The data of the file header consist of three columns, each separated by a semicolon: parameter name; numeric value; basic unit. The data section starts with the keyword "Trace <n>" (<n> = number of stored trace), followed by the measured data in one or several columns (depending on measurement) which are also separated by a semicolon.

File contents: header	Description
Type;FSL;	Instrument model
Version;5.00;	Firmware version
Date;01.Oct 2006;	Date of data set storage
Mode;ANALYZER;	Instrument mode
Center Freq;55000;Hz	Center frequency
Freq Offset;0;Hz	Frequency offset
Span;90000;Hz	Frequency range (0 Hz in zero span and statistics measurements)
x-Axis;LIN;	Scaling of x-axis linear (LIN) or logarithmic (LOG)
Start;10000;Hz Stop;100000;Hz	Start/stop of the display range. Unit: Hz for span > 0, s for span = 0, dBm/dB for statistics measurements
Ref Level;-30;dBm	Reference level
Level Offset;0;dB	Level offset
Ref Position;75;%	Position of reference level referred to diagram limits (0% = lower edge)
y-Axis;LOG;	Scaling of y-axis linear (LIN) or logarithmic (LOG)
Level Range;100;dB	Display range in y direction. Unit: dB with x-axis LOG, % with x-axis LIN
Rf Att;20;dB	Input attenuation
RBW;100000;Hz	Resolution bandwidth
VBW;30000;Hz	Video bandwidth
SWT;0.005;s	Sweep time
Trace Mode;AVERAGE;	Display mode of trace: CLR/WRITE,AVERAGE,MAXHOLD,MINHOLD
Detector;AUTOPEAK;	Detector set: AUTOPEAK,MAXPEAK,MINPEAK,AVERAGE,RMS,SAMPLE,QUASIPeAK
Sweep Count;20;	Number of sweeps set
File contents: data section of the file	Description
Trace 1;;;	Selected trace
x-Unit;Hz;	Unit of x values: Hz with span > 0; s with span = 0; dBm/dB with statistics measurements
y-Unit;dBm;	Unit of y values: dB*V/A/W depending on the selected unit with y-axis LOG or % with y-axis LIN
Values; 501;	Number of measurement points
10000;-10.3;-15.7 10180;-11.5;-16.9 10360;-12.0;-17.4 ...;...	Measured values: <x value>, <y1>, <y2>; <y2> being available only with detector AUTOPEAK and containing in this case the smallest of the two measured values for a measurement point.

Measurement Functions

In this section all menus necessary for setting measurement functions are described. This includes the following topics and keys:

- ["Using Markers and Delta Markers - MKR Key"](#) on page 4.48
- ["Changing Settings via Markers - MKR-> Key"](#) on page 4.60
- ["Power Measurements - MEAS Key"](#) on page 4.69
- ["Using Limit Lines and Display Lines - LINES Key"](#) on page 4.111

Using Markers and Delta Markers - MKR Key

The markers are used for marking points on traces, reading out measurement results and for quickly selecting a display section. The R&S FSL provides four markers per trace.

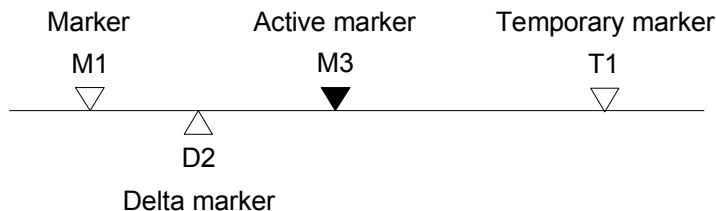

Fig. 4-5: Marker types

All markers can be used either as markers or delta markers. The marker that can be moved by the user is defined in the following as the active marker. Temporary markers are used in addition to the markers and delta markers to evaluate the measurement results. They disappear when the associated function is deactivated.

The measurement results of the active marker (also called marker values) are displayed in the marker field. The marker field is located at the upper right corner of the display and shows the following:

- marker type (M1 in the example)
- trace in square brackets ([1] in the example)
- level (-33.09 dBm in the example)
- marker location (3 GHz in the example)

```
M1[1]          -33.09 dBm
                3.000000000 GHz
```

Fig. 4-6: Marker values

The **MKR** key is used to select and position the absolute and relative measurement markers (markers and delta markers). In addition, the functions for frequency counter, fixed reference point for relative measurement markers and enlargement of the measurement area are assigned to this key.

Also the following measurements can be carried out:

- Noise density (**Noise Meas On/Off** softkey; see also "[Measurement of noise density](#)" on page 4.51)
- Frequency measurement (**Sig Count On/Off** softkey; see also "[Frequency measurement with the frequency counter](#)" on page 4.50)
- Filter or signal bandwidth (**n dB down** softkey)
- AF demodulation (**Marker Demod** softkey; see also "[AF demodulation](#)" on page 4.50)

For further information on markers see also "[Changing Settings via Markers - MKR-> Key](#)" on page 4.60.

To open the marker menu

- Press the **MKR** key.

The marker menu is displayed. If no marker is active, marker 1 is activated and a peak search on the trace is carried out. Otherwise, the edit dialog box for the last activated marker is opened and the current frequency / time value is displayed.

Menu and softkey description

- "Softkeys of the marker menu" on page 4.52

To display help to a softkey, press the **HELP** key and then the softkey for which you want to display help. To close the help window, press the **ESC** key. For further information refer to section "How to use the Help System".

Further information

- "AF demodulation" on page 4.50
- "Frequency measurement with the frequency counter" on page 4.50
- "Measurement of noise density" on page 4.51

Tasks

- To define the basic marker settings
- To set a fixed reference point (phase noise measurement)
- To set the demodulation mode and duration

To define the basic marker settings

1. Press the **MKR** key to open the marker menu.

Marker 1 is activated and positioned on the maximum value of the trace as normal marker. If several traces are being displayed, the marker is set to the maximum value (peak) of the trace which has the lowest number (1 to 3) and is not frozen (View mode). In case a marker is already located there, it will be set to the frequency of the next lowest level (next peak).

2. To change to another trace, press the **Marker to Trace** softkey and enter the number of the trace on which the marker is to be placed.

The marker changes to selected trace, but remains on the previous frequency or time. If a trace is turned off, the corresponding markers and marker functions are also deactivated.

3. To switch on a delta marker, press the **Marker 2** softkey.

Marker 2 is switched on as a delta marker. The frequency and level of marker 2 are displayed in relation to marker 1 in the marker field.

4. To change the marker type of marker 2, press the **/Marker Norm/Delta** softkey.

Marker 2 becomes a normal marker. The frequency and level of marker 2 are displayed as absolute values in the marker field.

5. To switch off marker 2, press the **Marker 2** softkey again.

Marker 2 is deactivated. Marker 1 becomes the active marker for entry. The frequency and level of marker 1 are displayed in the marker field.

To set a fixed reference point (phase noise measurement)

1. Press the **Phase Noise/Ref Fixed** softkey.

The submenu with the **Phase Noise On/Off** softkey switched on is displayed. The level and frequency or time values of marker 1 immediately become the reference point.

2. To set the maximum of the selected trace as reference point, press the **Peak Search** softkey.

3. To define the values for the reference point, proceed as follows:

- Press the **Ref Point Level** softkey and enter a reference level value.

- If span > 0, press the **Ref Point Frequency** softkey and enter a frequency reference value.
- If span = 0, press the **Ref Point Time** softkey and enter a reference time value.

To set the demodulation mode and duration

1. Press the **Marker Demod** softkey.
The submenu with the **Mkr Demod On/Off** softkey switched on is displayed.
2. To change the demodulation mode, press the **AM** or **FM** softkey.
For details see "[AF demodulation](#)" on page 4.50.
3. To modify the demodulation time for span > 0, press the **Mkr Stop Time** softkey.
4. To change to continuous demodulation for span > 0, press the **Cont Demod** softkey.
5. To tune the volume for acoustic monitoring, press the **Volume** softkey.

AF demodulation

The R&S FSL provides demodulators for AM and FM signals. With these demodulators, a displayed signal can be identified acoustically by using headphones.

CAUTION**Risk of hearing damage**

Using headphones can result in hearing damage.

Check the volume setting carefully before putting on the headphones in order to protect your hearing.

For span > 0, the demodulation is not continuous. The frequency at which the demodulation takes place is set by the active marker. If the level of the selected frequency is above the threshold line, the sweep stops for the selected time (stop time) and the RF signal is demodulated. For span = 0, the demodulation is continuously active irrespective of the stop time set.

Frequency measurement with the frequency counter

In order to accurately determine the frequency of a signal, the R&S FSL is equipped with a frequency counter which measures the frequency of the RF signal at the intermediate frequency. Using the measured IF, the R&S FSL calculates the frequency of the RF input signal by applying the known frequency conversion factors.

The frequency measurement uncertainty depends only upon the accuracy of the frequency reference used (external or internal reference). Although the R&S FSL always operates synchronously irrespective of the set span, the frequency counter delivers a more exact result than a measurement performed with a marker. This is due to the following:

- The marker measures only the position of the point on the trace and infers from this value the signal frequency. The trace, however, contains only a limited number of points. Depending upon the selected span, each point may contain many measurement values, which therefore limits the frequency resolution.
- The resolution, with which the frequency can be measured with a marker, is dependant on the selected resolution bandwidth which in return affects the necessary measurement time. For this reason, the bandwidth is normally made as wide as possible and the sweep time as short as

possible. This results in a loss of frequency resolution. For the measurement with the frequency counter, the sweep is stopped at the reference marker, the frequency is counted with the desired resolution and then the sweep is allowed to continue.

Measurement of noise density

During noise measurement, the noise power density is measured at the position of the marker. For span = 0, all points of the trace are used to determine the noise power density. For span > 0, two points to the right and left of the marker are used for the measurement to obtain a stable result.

The noise power density is indicated in the marker field. With logarithmic amplitude units (dBm, dBmV, dBm μ V, dBm μ A), the noise power density is output in dBm/Hz, i.e. as level in 1 Hz bandwidth with reference to 1 mW. With linear amplitude units (V, A, W), the noise voltage density is evaluated in μ V/Hz, the noise current density in μ A/Hz or the noise power density in μ W/Hz.

In the default setting, the R&S FSL uses the sample detector for the noise function.

With the sample detector, the trace can additionally be set to Average to stabilize the measured values. With RMS detector used, trace averaging must not be used since in this case it produces too low noise levels which cannot be corrected. Instead, the sweep time can be increased to obtain stable measurement results.

The following settings have to be made to ensure that the power density measurement yields correct values:

- Detector: Sample or RMS
- Video bandwidth:
 - ≤ 0.1 resolution bandwidth with sample detector
 - ≥ 3 x resolution bandwidth with RMS detector
- Trace averaging:

With the sample detector, the trace can additionally be set to average to stabilize the measured values. With RMS detector used, trace averaging must not be used since in this case it produces too low noise levels which cannot be corrected. Instead, the sweep time can be increased to obtain stable measurement results.

The R&S FSL uses the following correction factors to evaluate the noise density from the marker level:

- Since the noise power is indicated with reference to 1 Hz bandwidth, the bandwidth correction value is deducted from the marker level. It is $10 \times \lg(1 \text{ Hz}/\text{BW}_{\text{Noise}})$, where BW_{Noise} is the noise or power bandwidth of the set resolution filter (RBW).
- RMS detector: With the exception of bandwidth correction, no further corrections are required since this detector already indicates the power with every point of the trace.
- Sample detector: As a result of video filter averaging and trace averaging, 1.05 dB is added to the marker level. This is the difference between the average value and the RMS value of white noise. With a logarithmic level axis, 1.45 dB is added additionally. Logarithmic averaging is thus fully taken into account which yields a value that is 1.45 dB lower than that of linear averaging.
- To allow a more stable noise display the adjacent (symmetric to the measurement frequency) points of the trace are averaged.
- For span > 0, the measured values are averaged versus time (after a sweep).



The R&S FSL noise figure can be calculated from the measured power density level. It is calculated by deducting the set RF attenuation (RF Att) from the displayed noise level and adding 174 to the result.

Softkeys of the marker menu

The following table shows all softkeys available in the marker menu. It is possible that your instrument configuration does not provide all softkeys. If a softkey is only available with a special option, model or (measurement) mode, this information is delivered in the corresponding softkey description.

If the Spectrogram Measurement option (K14) is activated, the edit dialog box for markers and delta markers is extended. For details refer to "[Markers and marker values](#)" on page 4.182.

Menu / Command	Submenu / Command	Command
Marker 1		
Marker 2		
Marker Norm/Delta		
Noise Meas On/Off		
Phase Noise/Ref Fixed ↓	Phase Noise On/Off	
	Ref Point Level	
	Ref Point Frequency/ Ref Point Time	
	Peak Search	
	Phase Noise 1 2 3 4 ▲	
	Reference Fixed ↓	Reference Fixed On/Off
		Ref Point Level
		Ref Point Frequency/ Ref Point Time
		Peak Search
Sig Count On/Off		
More ↓		
Marker 3		
Marker 4		
Marker to Trace		
Marker Demod ↓	Mkr Demod On/Off	
	AM	
	FM	
	Mkr Stop Time	
	Cont Demod	
	Volume	
n dB down		
All Marker Off		

Menu / Command	Submenu / Command	Command
More ↓		
Marker Zoom		
Marker Peak List ↓	New Search	
	Sort Mode Freq/Lvl	
	Peak Excursion	
	Left Limit	
	Right Limit	
	Threshold	
	More ↓	
	Peak List Off	
	Threshold	
	ASCII File Export	
	Decim Sep	
Marker Stepsize ↓	Stepsize Standard	
	Stepsize Sweep Points	

Marker 1/Marker 2/Marker 3/Marker 4/Marker Norm/Delta

The **Marker <no>** softkey activates the corresponding marker and opens an edit dialog box to enter a value for the marker to be set to. Pressing the softkey again deactivates the selected marker.

If a marker value is changed using the rotary knob, the step size is defined via the **Stepsize Standard** or **Stepsize Sweep Points** softkeys.

Marker 1 is always the reference marker for relative measurements. If activated, markers 2 to 4 are delta markers that refer to marker 1. These markers can be converted into markers with absolute value display by means of the **Marker Norm/Delta** softkey. If marker 1 is the active marker, pressing the **Marker Norm/Delta** softkey switches on an additional delta marker.

- Remote: CALC:MARK ON
- Remote: CALC:MARK:X <value>
- Remote: CALC:MARK:Y?
- Remote: CALC:DELT ON
- Remote: CALC:DELT:X <value>
- Remote: CALC:DELT:X:REL?
- Remote: CALC:DELT:Y?

Noise Meas On/Off

Switches the noise measurement for the active marker on or off. The corresponding marker becomes the normal marker. For more details on noise measurement see "[Measurement of noise density](#)" on page 4.51.

- Remote: CALC:MARK:FUNC:NOIS ON
- Remote: CALC:MARK:FUNC:NOIS:RES?

Phase Noise/Ref Fixed

The function of this softkey depends on the setting of the **Noise Meas** softkey:

- **Noise Meas On**: activates phase noise measurements.
 - **Noise Meas Off**: freezes the current position of marker 1 as a reference for relative measurements. Additionally it opens a submenu to set all values of a reference point. Instead of using the current values of the reference marker (marker 1) as reference point for the delta markers, level and frequency or time are set to fixed values and used as reference point.
-

Phase Noise On/Off

Switches the relative measurement to a fixed reference value on or off. The level and frequency or time values of marker 1 immediately become the reference point, but can be altered using the corresponding softkeys (**Ref Point Level**, **Ref Point Frequency**, **Ref Point Time** and **Peak Search**).

→ Remote: CALC:DELT2:FUNC:FIX ON

Ref Point Level

Opens an edit dialog box to enter a reference level value. All relative level values of the delta markers refer to this reference level.

→ Remote: CALC:DELT2:FUNC:FIX:RPO:Y -10dBm

Ref Point Frequency (span > 0) / Ref Point Time (zero span)

Opens an edit dialog box to enter a frequency reference or time value. All relative frequency or time values of the delta markers refer to this frequency reference. For phase noise measurement, input of reference time is not possible..

→ Remote: CALC:DELT2:FUNC:FIX:RPO:X 10.7MHz

→ Remote: CALC:DELT2:FUNC:FIX:RPO:X 5MS

Peak Search

Sets the maximum value of the selected trace as the reference point.

→ Remote: CALC:DELT:FUNC:FIX:RPO:MAX

Phase Noise 1 2 3 4 Δ

Selects the normal marker or the delta markers, activates the marker and opens an edit dialog box to enter a value for the marker to be set to. Δ stands for delta marker 1.

Reference Fixed

Opens a submenu for relative measurement to a fixed reference value.

Reference Fixed On/Off

Switches the relative measurement to a fixed reference value on or off. The level and frequency or time values of marker 1 immediately become the reference point, but can be altered using the corresponding softkeys (**Ref Point Level**, **Ref Point Frequency**, **Ref Point Time** and **Peak Search**).

→ Remote: CALC:DELT2:FUNC:FIX ON

Sig Count On/Off

Switches the frequency counter on/off. The frequency is counted at the position of the reference marker (marker 1). If no marker is activated, marker 1 is switched on and set at the largest signal.

The sweep stops at the reference marker until the frequency counter has delivered a result. The result is displayed in the marker field (see "[Fig. 4-6: Marker values](#)" on page 4.48), labeled with [Tx CNT]. For more details see "[Frequency measurement with the frequency counter](#)" on page 4.50.

→ Remote: CALC:MARK1:COUN ON

→ Remote: CALC:MARK:COUN:FREQ?

Marker to Trace

Opens an edit dialog box to enter the number of the trace, on which the marker is to be placed.

→ Remote: CALC:MARK1:TRAC 1

→ Remote: CALC:DELT:TRAC 1

Marker Demod

Opens a submenu to set the demodulation mode and duration. For more details see also "[AF demodulation](#)" on page 4.50.

Mkr Demod On/Off

Switches the demodulation on/off. For more details see also "[AF demodulation](#)" on page 4.50.

→ Remote: CALC:MARK1:FUNC:DEM ON

AM

Sets AM as demodulation mode. This is the default setting. For more details see also "[AF demodulation](#)" on page 4.50.

→ Remote: CALC:MARK1:FUNC:DEM:SEL AM

FM

Sets FM as demodulation mode. Default setting is AM. For more details see also "[AF demodulation](#)" on page 4.50.

→ Remote: CALC:MARK1:FUNC:DEM:SEL FM

Mkr Stop Time

Opens an edit dialog box to enter the demodulation stop time for span > 0. For more details see also "AF demodulation" on page 4.50.

→ Remote: CALC:MARK1:FUNC:DEM:HOLD 3s

Cont Demod (span > 0)

Switches the continuous demodulation on or off. If the sweep time is long enough, the set frequency range can be monitored acoustically. For more details see also "AF demodulation" on page 4.50.

→ Remote: CALC:MARK1:FUNC:DEM:CONT ON

Volume

Opens an edit dialog box to regulate the volume for acoustic monitoring. For more details see also "AF demodulation" on page 4.50.

→ Remote: SYST:SPE:VOL 0.5

n dB down

Opens an edit dialog box to enter a value to define the level spacing of the two temporary markers to the right and left of marker 1 (default setting: 3 dB). Activates the temporary markers T1 and T2. The values of the temporary markers (T1, T2) and the entered value (ndB) are displayed in the marker field.

If a positive value is entered, the markers T1 and T2 are placed below the active reference marker. If a negative value (e.g. for notch filter measurements) is entered, the markers T1 and T2 are placed above the active reference marker. Marker T1 is placed to the left and marker T2 to the right of the reference marker.

In the marker field, the following results are displayed:

Span setting	Parameter name	Description
span > 0	Bw	frequency spacing of the two temporary markers
	Q factor	quality of the displayed bandwidth value (Bw)
span = 0	PWid	pulse width between the two temporary markers

If it is not possible to form the frequency spacing for the n dB value (e.g. because of noise display), dashes instead of a measured value are displayed.

- Remote: CALC:MARK1:FUNC:NDBD:STAT ON
- Remote: CALC:MARK1:FUNC:NDBD 3dB
- Remote: CALC:MARK1:FUNC:NDBD:RES?
- Remote: CALC:MARK:FUNC:NDBD:QFAC?
- Remote: CALC:MARK1:FUNC:NDBD:FREQ? (span > 0)
- Remote: CALC:MARK1:FUNC:NDBD:TIME? (span = 0)

All Marker Off

Switches all markers off.

→ Remote: CALC:MARK:AOFF

Marker Zoom (span > 0)

Opens an edit dialog box to enter a display range for the zoom. The area around marker 1 is expanded accordingly and more details of the spectrum can be seen. If no marker is activated, marker 1 is switched on and set on the largest signal..

The following sweep is stopped at the position of the reference marker. The frequency of the signal is counted and the measured frequency becomes the new center frequency. The zoomed display range is then configured and the new settings are used by the R&S FSL for further measurements.

As long as switching to the new frequency display range has not yet taken place, pressing the softkey will abort the procedure. If an instrument setting is changed while using this function, the procedure is aborted.

→ Remote: CALC:MARK1:FUNC:ZOOM 1kHz

Marker Peak List

Opens the **Peak List** dialog box and a submenu to define criterias for the sort order and the contents of the peak list. The number of listed peaks is indicated in the title bar. For all listed peaks the frequency and level values are given. Maximal 50 entries are listed.

This softkey is available from firmware version 1.30.

→ Remote: CALC:MARK:FUNC:FPE:COUN?

→ Remote: CALC:MARK:FUNC:FPE:X?

→ Remote: CALC:MARK:FUNC:FPE:Y?

New Search

Starts a new peak search and enters the results in the peak list.

This softkey is available from firmware version 1.30.

→ Remote: CALC:MARK:FUNC:FPE 3

Sort Mode Freq/Lvl

Defines the criteria for sorting:

Freq sorting in ascending order of frequency values (span > 0) or time values (span = 0)

Lvl sorting in ascending order of the level

This softkey is available from firmware version 1.30.

→ Remote: CALC:MARK:FUNC:FPE:SORT Y

Peak List Off

Switches the peak list function off.

This softkey is available from firmware version 1.30.

ASCII File Export

Opens the **ASCII File Export Name** dialog box and saves the content of the marker peak list in ASCII format to the specified file and directory. The file consists of a data section containing the peak list.

Example:

```
Peak;1
1089743590;Hz
-105.24;dBm
...
```

This format can be processed by spreadsheet calculation programs, e.g. MS Excel. It is necessary to define ';' as a separator for the data import. Different language versions of evaluation programs may require a different handling of the decimal point. It is therefore possible to select between separators '.' (decimal point) and ',' (comma) using the **Decim Sep** softkey.

This softkey is available from firmware version 1.80.

- Remote: FORM ASC
 - Remote: MMEM:STOR:PEAK 'test'
-

Decim Sep

For details refer to the **Decim Sep** softkey in the trace menu of the base unit.

This softkey is available from firmware version 1.80.

Marker Stepsize

Opens a submenu to set the step size of all markers and delta markers.

This softkey is available from firmware version 1.60.

Stepsize Standard

Moves the marker or delta marker from one measurement point to the next, if the marker or delta marker value is changed via the rotary knob (**Marker 1/Marker 2/Marker 3/Marker 4** softkeys). If more measured values than measurement points exist, it is not possible to read out all measured values. In this case, use the **Stepsize Sweep Points** softkey.

This softkey is available from firmware version 1.60.

- Remote: CALC:MARK:X:SSIZ STAN
-

Stepsize Sweep Points

Moves the marker or delta marker from one measured value to the next, if the marker or delta marker value is changed via the rotary knob (**Marker 1/Marker 2/Marker 3/Marker 4** softkeys). If more measured values than measurement points exist, every single measured value is accessible and its value is displayed in the marker field.

The number of measured values is defined in the sweep menu via the **Sweep Points** softkey.

This functionality is available for all base unit measurements with the exception of statistics (**APD** and **CCDF** softkeys in the measurement menu).

This softkey is available from firmware version 1.60.

→ Remote: `CALC:MARK:X:SSIZ POIN`

Changing Settings via Markers - MKR-> Key

The **MKR->** key is used for search functions of measurement markers, assignment of the marker frequency as center frequency, restriction of the search area and characterization of maxima and minima. For details on markers in general, see "[Using Markers and Delta Markers - MKR Key](#)" on page 4.48.

To open the marker-> menu

- Press the **MKR->** key.

The marker-> menu is displayed. If no marker is active, marker 1 will be activated and a peak search on the trace carried out. Otherwise, the edit dialog box for the last activated marker is opened and the current frequency / time value is displayed.

Menu and softkey description

- "[Softkeys of the marker-> menu](#)" on page 4.64

To display help to a softkey, press the **HELP** key and then the softkey for which you want to display help. To close the help window, press the **ESC** key. For further information refer to section "How to use the Help System".

Further information

- "[Effect of different peak excursion settings \(example\)](#)" on page 4.62

Tasks

- [To search for a maximum](#)
- [To search for a minimum](#)
- [To specify the search limits](#)
- [To specify the search range](#)
- [To examine a signal at the center in detail](#)
- [To specify the suitable peak excursion](#)

To search for a maximum

1. To search the highest maximum, press the **Peak** softkey.
2. To define the search mode for the next maximum, use the **Next Peak Mode < abs >** softkey.
3. To start the search, press **Next Peak** the softkey.

To search for a minimum

1. To search the minimum, press the **Min** softkey.
2. To define the search mode for the next maximum, use the **Next Min Mode < abs >** softkey.
3. To start the search, press the **Next Min** softkey.

To specify the search limits

1. To define the lower limit, press the **Left Limit** softkey.
2. To define the upper limit, press the **Right Limit** softkey.
3. To define the threshold, press the **Threshold** softkey.
4. To switch the search limits off, press the **Search Lim Off** softkey.

To specify the search range

- Press the **Exclude LO** softkey to include the frequency 0 Hz in the marker search functions.

To examine a signal at the center in detail

1. Press the **PRESET** key to set the R&S FSL to the default setting.
2. Press the **MKR->** key to open the marker-> menu.
3. Marker 1 is activated and set to the largest signal of the trace.
4. Press the **Center =Mkr Freq** softkey to set to the marker frequency.
5. The span is adapted in such a way that the minimum frequency (= 0 Hz) or the maximum frequency is not exceeded.
6. Press the **Ref Lvl =Mkr Lvl** softkey to set the reference level to the measured marker level.
7. Press the **SPAN** key.
8. The edit dialog box to enter a frequency span is displayed.
9. Reduce the span, e.g. using the rotary knob.

To specify the suitable peak excursion

1. If the next peak mode **abs** of softkey **Next Peak Mode < abs > / Next Min Mode < abs >** is used, the default value is sufficient, since, in this mode, the next lower maximum or next higher minimum will always be detected.
2. If the next peak mode **< or >** of softkey **Next Peak Mode < abs > / Next Min Mode < abs >** is used, the 6 dB level change set as a default value may be attained already by the inherent noise of the instrument. To avoid identifying noise peaks as maxima or minima, enter a peak excursion value that is higher than the difference between the highest and the lowest value measured for the displayed inherent noise.

Effect of different peak excursion settings (example)

The following figure shows a trace to be examined.

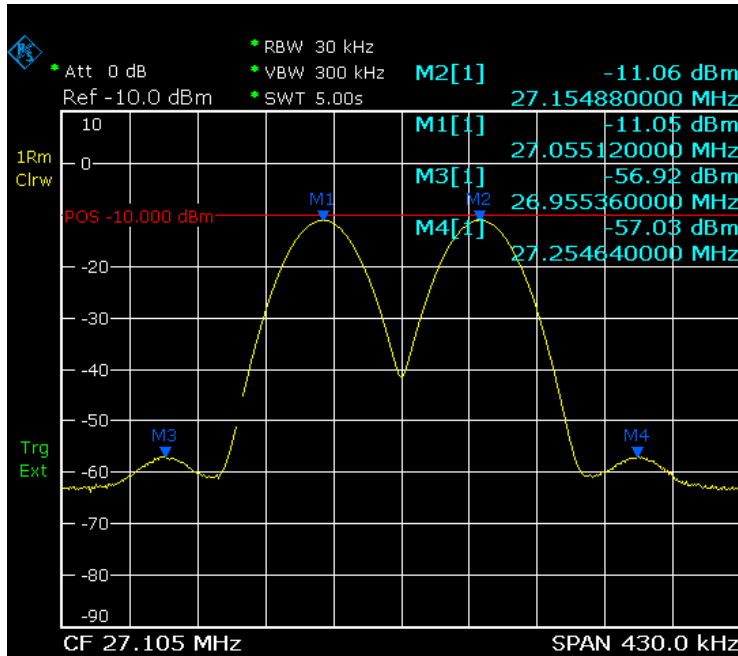

Fig. 4-7: Trace example

The following table lists the signals as indicated by the marker numbers in the diagram above, as well as the minimum of the amplitude decrease to both sides of the signal:

signal #	min. amplitude decrease to both sides of the signal
1	30 dB
2	29.85 dB
3	7 dB
4	7 dB

The detected signals and their order are different depending on the peak excursion setting and the peak search method (whether the next lower maximum or the next relative maximum are searched). The following results are obtained. All tests start with the marker set to signal 1 by pressing the softkey **Peak**.

- 40 dB peak excursion

Result: With both methods apart from signal 1 no signal is detected, as the signal level does not decrease by more than 30 dB to either side of any signal.

next lower maximum	next relative maximum
next peak mode abs : signal 1 (no further signal detected)	next peak mode <: signal 1 (no further signal detected)
	next peak mode >: signal 1 (no further signal detected)

- 20 dB peak excursion

Result: With both methods apart from signal 1 signal 2 is detected, as the signal level decreases at least by 29.85 dB to either side of this signal, which is now greater than the peak excursion.

next lower maximum	next relative maximum
next peak mode abs : signal 2	next peak mode <: signal 1 (no further signal detected)
next peak mode abs : signal 2 (no further signal detected)	next peak mode >: signal 2
	next peak mode >: signal 2 (no further signal detected)

- 6 dB peak excursion

Result: With both methods all signals are detected.

next lower maximum	next relative maximum
next peak mode abs : signal 2	next peak mode <: signal 3
next peak mode abs : signal 3	next peak mode >: signal 1
next peak mode abs : signal 4	next peak mode >: signal 2
	next peak mode >: signal 4

Softkeys of the marker-> menu

The following table shows all softkeys available in the marker-> menu. It is possible that your instrument configuration does not provide all softkeys. If a softkey is only available with a special option, model or (measurement) mode, this information is delivered in the corresponding softkey description.

If the Spectrogram Measurement option (K14) is activated, this menu provides additional functionality. For details refer to "[Softkeys of the marker-> menu \(Spectrogram view\)](#)" on page 4.187.

Menu / Command	Command
Select 1 2 3 4 Δ	
Peak	
Next Peak	
Next Peak Mode < abs >	
Center =Mkr Freq	
Ref Lvl =Mkr Lvl	
More ↓	
Select 1 2 3 4 Δ	
Min	
Next Min	
Next Min Mode < abs >	
Search Limits ↓	Left Limit
	Right Limit
	Threshold
	Search Lim Off
Peak Excursion	
More ↓	
Exclude LO	
Auto Max Peak/Auto Min Peak	

Select 1 2 3 4 Δ

Selects the normal marker or the delta markers, activates the marker and opens an edit dialog box to enter a value for the marker to be set to. Δ stands for delta marker 1.

If the Spectrogram Measurement option (K14) is activated, the edit dialog box for markers and delta markers is extended. For details refer to "[Markers and marker values](#)" on page 4.182.

- Remote: CALC:MARK1 ON
- Remote: CALC:MARK1:X <value>
- Remote: CALC:MARK1:Y?

Peak

Sets the active marker/delta marker to the highest maximum of the trace.

If the Spectrogram Measurement option (K14) is activated, this softkey provides altered functionality. For details refer to **Peak** softkey in the marker-> menu of this option.

→ Remote: CALC:MARK:MAX

→ Remote: CALC:DELT:MAX

Next Peak

Sets the active marker/delta marker to the next maximum of the selected trace according to the mode selected using the **Next Peak Mode < abs >** softkey.

If the Spectrogram Measurement option (K14) is activated, this softkey provides altered functionality. For details refer to **Next Peak** softkey in the marker-> menu of this option.

Next Peak Mode < abs >

Selects the mode of the **Next Peak** softkey. Three settings are available:

- < Sets the active marker/delta marker to the next maximum left to the marker of the selected trace.
- abs Sets the active marker/delta marker to the next lower maximum of the selected trace.
- > Sets the active marker/delta marker to the next maximum right to the marker of the selected trace.

If the Spectrogram Measurement option (K14) is activated, this softkey provides altered functionality. For details refer to **Next Peak X Search < abs >** and **Next Peak Y Search up/abs/dn** softkeys in the marker-> menu of this option.

→ Remote: CALC:MARK:MAX:LEFT (>)

→ Remote: CALC:DELT:MAX:LEFT (<)

→ Remote: CALC:MARK:MAX:RIGH (>)

→ Remote: CALC:DELT:MAX:RIGH (>)

→ Remote: CALC:MARK:MAX:NEXT (abs)

→ Remote: CALC:DELT:MAX:NEXT (abs)

Center =Mkr Freq (span > 0)

Sets the center frequency to the current marker or delta marker frequency. A signal can thus be set to as center frequency, for example to examine it in detail with a smaller span.

Remote: CALC:MARK:FUNC:CENT

Ref Lvl =Mkr Lvl

Sets the reference level to the current marker level.

→ Remote: CALC:MARK:FUNC:REF

Min

Sets the active marker/delta marker to the minimum of the selected trace.

If the Spectrogram Measurement option (K14) is activated, this softkey provides altered functionality. For details refer to **Min** softkey in the marker-> menu of this option.

→ Remote: CALC:MARK:MIN

→ Remote: CALC:DELT:MIN

Next Min

Sets the active marker/delta marker to the next minimum of the selected trace according to the mode selected using the **Next Min Mode < abs >** softkey.

If the Spectrogram Measurement option (K14) is activated, this softkey provides altered functionality. For details refer to **Next Min** softkey in the marker-> menu of this option.

→ Remote: CALC:MARK:MIN:NEXT

→ Remote: CALC:DELT:MIN:NEXT

Next Min Mode < abs >

Selects the mode of the **Next Min** softkey. Three settings are available:

< Sets the active marker/delta marker to the next minimum left to the marker of the selected trace.

abs Sets the active marker/delta marker to the next higher minimum of the selected trace.

> Sets the active marker/delta marker to the next minimum right to the marker of the selected trace.

If the Spectrogram Measurement option (K14) is activated, this softkey provides altered functionality. For details refer to **Next Min X Search < abs >** and **Next Min Y Search up/abs/dn** softkeys in the marker-> menu of this option.

→ Remote: CALC:MARK:MAX:LEFT

→ Remote: CALC:DELT:MAX:LEFT

Search Limits

Opens a submenu to set the limits for maximum or minimum search in the x and y direction.

→ Remote: CALC:MARK:X:SLIM ON

Left Limit

Opens an edit dialog box to enter a value for the lower limit (left vertical line: S1 for span > 0; T1 for zero span). The search is performed between the lines of the left and right limit (see also **Right Limit** softkey).

→ Remote: CALC:MARK:X:SLIM:LEFT 1MHZ

Right Limit

Opens an edit dialog box to enter a value for the upper limit (left vertical line: S2 for span > 0; T2 for zero span). The search is performed between the lines of the left and right limit (see also **Left Limit** softkey). If no value is set, the upper limit corresponds to the stop frequency.

→ Remote: CALC:MARK:X:SLIM:RIGH 10MHZ

Threshold

Opens an edit dialog box to define the threshold line. The threshold line represents the lower level limit for a **Peak** search and the upper level limit for a **Min** search.

Opens an edit dialog box to define the threshold line. The threshold line represents the lower limit of the peak search level range.

→ Remote: CALC:THR -20dBm

→ Remote: CALC:THR ON

Search Lim Off

Deactivates all limits of the search range.

→ Remote: CALC:MARK:X:SLIM OFF

→ Remote: CALC:THR:STAT OFF

Peak Excursion

Opens - for level measurements - an edit dialog box to enter the minimum level value by which a signal must rise or fall so that it will be identified as a maximum or a minimum by the search functions. Entries from 0 dB to 80 dB are allowed; the resolution is 0.1 dB. The default setting for the peak excursion is 6 dB.

For details see also "[To specify the suitable peak excursion](#)" on page 4.61 and "[Effect of different peak excursion settings \(example\)](#)" on page 4.62.

→ Remote: CALC:MARK:PEXC 10dB

Exclude LO

Switches the frequency range limit for the marker search functions on or off.

activated minimum frequency $\geq 6 \times$ resolution bandwidth (RBW)

Because of the interference by the first local oscillator to the first intermediate frequency at the input mixer, the LO is represented as a signal at 0 Hz. To avoid the marker jumping to the LO at 0 Hz with the peak function when setting the display range, this frequency is excluded.

deactivated no restriction to the search range. The frequency 0 Hz is included in the marker search functions.

→ Remote: CALC:MARK:LOEX ON

Auto Max Peak / Auto Min Peak

Adds an automatic peak search action for marker 1 at the end of each particular sweep. This function may be used during adjustments of a device under test to keep track of the actual peak marker position and level.

The actual marker search limit settings (**Left Limit, Right Limit, Threshold, Exclude LO** softkeys) are taken into account.

This softkey is available from firmware version 1.50.

- Remote: CALC:MARK:MIN:AUTO ON
 - Remote: CALC:MARK:MAX:AUTO ON
-

Power Measurements - MEAS Key

With its power measurement functions, the R&S FSL is able to measure all the necessary parameters with high accuracy in a wide dynamic range.

A modulated carrier is almost always used (except e.g. SSB-AM) for high-frequency transmission of information. Due to the information modulated upon the carrier, the latter covers a spectrum which is defined by the modulation, the transmission data rate and the signal filtering. Within a transmission band each carrier is assigned a channel taking into account these parameters. In order to ensure error-free transmission, each transmitter must be conforming to the specified parameters. These include among others:

- the output power
- the occupied bandwidth, i.e. the bandwidth which must contain a defined percentage of the power
- the power dissipation allowed in the adjacent channels

The **MEAS** key is used for complex measurement functions as power measurements, occupied bandwidth, signal statistic, carrier to noise spacing, AM modulation depth, third-order intercept point, harmonics and spurious emissions. For measurement examples refer to chapter "Advanced Measurement Examples" and to the Quick Start Guide, chapter 5, "Basic Measurement Examples".

The following measurements can be performed:

- Power in zero span (**Time Domain Power** softkey; for details see "[Power measurement in zero span](#)" on page 4.71)
- Channel power and adjacent-channel power with span > 0 and with a single or several carriers (**CP, ACP, MC-ACP** softkey)
- Occupied bandwidth (**OBW** softkey, for details see "[Measurement of occupied bandwidth](#)" on page 4.72)
- Carrier-to-noise ratio (**C/N, C/No** softkey)
- Amplitude probability distribution (**APD** and **CCDF** softkeys, for details refer to chapter "Advanced Measurement Examples", "Amplitude Distribution Measurement")
- Modulation depth (**AM Mod Depth** softkey)
- 3rd order intercept (**TOI** softkey, for details refer to chapter "Advanced Measurement Examples", "Intermodulation Measurements")

To open the power measurement menu

- Press the **MEAS** key.

The power measurement menu is displayed.

Menu and softkey description

- "[Softkeys of the power measurement menu](#)" on page 4.82

To display help to a softkey, press the **HELP** key and then the softkey for which you want to display help. To close the help window, press the **ESC** key. For further information refer to section "How to use the Help System".

Further information

- ["Power measurement in zero span"](#) on page 4.71
- ["Measurement of occupied bandwidth"](#) on page 4.72
- ["Predefined CP / ACP standards"](#) on page 4.72
- ["Settings of CP / ACP test parameters"](#) on page 4.73
- ["Ranges and range settings"](#) on page 4.75
- ["Provided XML files for the Spectrum Emission Mask measurement"](#) on page 4.75
- ["Format description of Spectrum Emission Mask XML files"](#) on page 4.76
- ["ASCII file export format \(Spectrum Emission Mask\)"](#) on page 4.82

Tasks

- [To measure the power in zero span](#)
- [To set the channel configuration](#)
- [To measure the occupied bandwidth](#)
- [To measure signal statistics](#)
- [To measure the carrier-to-noise ratio](#)

To measure the power in zero span

1. Press the **Time Domain Power** softkey to activate the power measurement.
The corresponding submenu is displayed.
2. To limit the power evaluation range, switch on the limits (**Limits On/Off** softkey) and enter the limits by using the **Left Limit** and **Right Limit** softkeys.
3. Select the type of power measurement by using the **Mean** or **RMS** softkey. (RMS or mean power), the settings for max hold and averaging as well as the definition of limits.
4. To calculate and display the peak value, press the **Peak** softkey.
5. To calculate and display the standard deviation from the mean value, press the **Std Dev** softkey.

To set the channel configuration

1. Press the **CP, ACP, MC-ACP** softkey to active channel or adjacent-channel power measurement.
The corresponding submenu is displayed.
2. To use a predefined standard for measurement, press the **CP / ACP Standard** softkey (for details on available standards see ["Predefined CP / ACP standards"](#) on page 4.72).
3. To configure the parameters independently of the predefined standards, press the **CP / ACP Config** softkey (for details see ["Settings of CP / ACP test parameters"](#) on page 4.73).
4. To enter the sweep time, press the **Sweep Time** softkey.
5. To display the whole diagram, press the **Full Size Diagram** softkey.
6. To adjust the reference level to the measured channel power, press the **Adjust Ref Level** softkey.

To measure the occupied bandwidth

1. Press the **OBW** softkey to activate the measurement of the occupied bandwidth (for details see also "[Measurement of occupied bandwidth](#)" on page 4.72).

The corresponding submenu is displayed.

2. Press the **% Power Bandwidth** softkey to enter the percentage of power.
3. To change the channel bandwidth for the transmission channel, press the **Channel Bandwidth** softkey.
4. To optimize the settings for the selected channel configuration, press the **Adjust Settings** softkey (for details see also "[Settings of CP / ACP test parameters](#)" on page 4.73).
5. To adjust the reference level to the measured total power after the first sweep, press the **Adjust Ref Level** softkey.

To measure signal statistics

- To activate and configure the measurement of the amplitude probability distribution (APD), press the **APD** softkey (for details refer to chapter "Advanced Measurement Examples", "Amplitude Distribution Measurement"). The corresponding submenu is displayed.
- To activate and configure the measurement of the complementary cumulative distribution (CCDF), press the **CCDF** softkey (for details refer to chapter "Advanced Measurement Examples", "Amplitude Distribution Measurement").

The corresponding submenu is displayed.

To measure the carrier-to-noise ratio

1. Press the **C/N, C/No** softkey to configure the carrier-to-noise ratio measurement.
The corresponding submenu is displayed.
2. To activate the measurements without reference to the bandwidth, press the **C/N** softkey.
3. To activate the measurements with reference to the bandwidth, press the **C/No** softkey.
4. To change the channel bandwidth for the transmission channel, press the **Channel Bandwidth** softkey.
5. To optimize the settings for the selected channel configuration, press the **Adjust Settings** softkey (for details see also "[Settings of CP / ACP test parameters](#)" on page 4.73).

Power measurement in zero span

With the aid of the power measurement function, the R&S FSL determines the power of the signal in zero span by summing up the power at the individual measurement points and dividing the result by the number of measurement points. In this way it is possible to measure for example the power of TDMA signals during transmission or during the muting phase. Both the mean power and the RMS power can be measured by means of the individual power values.

The result is displayed in the marker field. The measured values are updated after each sweep or averaged over a user-defined number of sweeps in order to determine e.g. the mean power over several bursts. For determination of the peak value the maximum value from several sweeps is displayed.

If both the on and off phase of a burst signal are displayed, the measurement range can be limited to the transmission or to the muting phase with the aid of vertical lines. The ratio between signal and noise power of a TDMA signal for instance can be measured by using a measurement as a reference value and after that varying the measurement range.

Upon switching on power measurement the sample detector is activated.

Measurement of occupied bandwidth

An important characteristic of a modulated signal is its occupied bandwidth. In a radio communications system for instance the occupied bandwidth must be limited to enable distortion-free transmission in adjacent channels. The occupied bandwidth is defined as the bandwidth containing a defined percentage of the total transmitted power. A percentage between 10% and 99.9% can be set.

The measurement principle is the following: The bandwidth containing 99% of the signal power is to be determined, for example. The routine first calculates the total power of all displayed points of the trace. In the next step, the points from the right edge of the trace are summed up until 0.5% of the total power is reached. Auxiliary marker 1 is positioned at the corresponding frequency. Then the points from the left edge of the trace are summed up until 0.5% of the power is reached. Auxiliary marker 2 is positioned at this point. 99% of the power is now between the two markers. The distance between the two frequency markers is the occupied bandwidth which is displayed in the marker field.

To ensure correct power measurement, especially for noise signals, and to obtain the correct occupied bandwidth, the following prerequisites and settings are necessary:

- Only the signal to be measured is displayed on the screen. An additional signal would falsify the measurement.
- $RBW \ll$ occupied bandwidth
(approx. 1/20 of occupied bandwidth, for voice communication type 300 Hz or 1 kHz)
- $VBW \geq 3 \times RBW$
- RMS detector
- $Span \geq 2$ to $3 \times$ occupied bandwidth

Some of the measurement specifications (e.g. PDC, RCR STD-27B) require measurement of the occupied bandwidth using a peak detector. The detector setting of the R&S FSL has to be changed accordingly then.

Predefined CP / ACP standards

The test parameters for the channel and adjacent-channel measurements are set according to the mobile radio standard. The available standards are listed below.

Parameter	Standard
CDMA2000	CDMA 2000
CDMA IS95A FWD	CDMA IS95A forward
CDMA IS95A REV	CDMA IS95A reverse
CDMA IS95C Class 0 FWD	CDMA IS95C Class 0 forward
CDMA IS95C Class 0 REV	CDMA IS95C Class 0 reverse
CDMA IS95C Class 1 FWD	CDMA IS95C Class 1 forward
CDMA IS95C Class 1 REV	CDMA IS95C Class 1 reverse
CDMA J-STD008 FWD	CDMA J-STD008 forward
CDMA J-STD008 REV	CDMA J-STD008 reverse
CDPD	CDPD
NADC IS136	NADC IS136
PDC	PDC
PHS	PHS
RFID 14443	RFID 14443

Parameter	Standard
TD-SCDMA FWD	TD-SCDMA forward
TD-SCDMA REV	TD-SCDMA reverse
TETRA	TETRA
W-CDMA 3GPP FWD	W-CDMA 3.84 MHz forward
W-CDMA 3GPP REV	W-CDMA 3.84 MHz reverse
WIBRO	WIBRO
WiMAX	WiMAX
WLAN 802.11A	WLAN 802.11A
WLAN 802.11B	WLAN 802.11B



For the R&S FSL, the channel spacing is defined as the distance between the center frequency of the adjacent channel and the center frequency of the transmission channel. The definition of the adjacent-channel spacing in standards IS95 B / C, IS97 B / C, IS98 B / C and CDMA2000 DS / MC1 / MC3 is different. These standards define the adjacent-channel spacing from the center of the transmission channel to the closest border of the adjacent channel. This definition is also used for the R&S FSL if the standard settings marked with a dagger are selected.

Settings of CP / ACP test parameters

- **Frequency span**

The frequency span must at least cover the channels to be measured plus a measurement margin of approx. 10%.



If the frequency span is large in comparison to the channel bandwidth (or the adjacent-channel bandwidths) being examined, only a few points on the trace are available per channel. This reduces the accuracy of the waveform calculation for the channel filter used, which has a negative effect on the measurement accuracy. It is therefore strongly recommended that the formulas mentioned be taken into consideration when selecting the frequency span.

For channel power measurements the **Adjust Settings** softkey sets the frequency span as follows:

$$(No. of transmission channels - 1) \times transmission channel spacing + 2 \times transmission channel bandwidth + measurement margin$$

For adjacent-channel power measurements, the **Adjust Settings** softkey sets the frequency span as a function of the number of transmission channels, the transmission channel spacing, the adjacent-channel spacing, and the bandwidth of one of adjacent-channels ADJ, ALT1 or ALT2, whichever is furthest away from the transmission channels:

(No. of transmission channels - 1) x transmission channel spacing + 2 x (adjacent-channel spacing + adjacent-channel bandwidth) + measurement margin

The measurement margin is approx. 10% of the value obtained by adding the channel spacing and the channel bandwidth.

- **Resolution bandwidth (RBW)**

To ensure both, acceptable measurement speed and required selection (to suppress spectral components outside the channel to be measured, especially of the adjacent channels), the resolution bandwidth must not be selected too small or too large. As a general approach, the resolution bandwidth is to be set to values between 1% and 4% of the channel bandwidth.

A larger resolution bandwidth can be selected if the spectrum within the channel to be measured and around it has a flat characteristic. In the standard setting, e.g. for standard IS95A REV at an adjacent channel bandwidth of 30 kHz, a resolution bandwidth of 30 kHz is used. This yields correct results since the spectrum in the neighborhood of the adjacent channels normally has a constant level. For standard NADC/IS136 this is not possible for example, since the spectrum of the transmit signal penetrates into the adjacent channels and a too large resolution bandwidth causes a too low selection of the channel filter. The adjacent-channel power would thus be measured too high.

With the exception of the IS95 CDMA standards, the **Adjust Settings** softkey sets the resolution bandwidth (RBW) as a function of the channel bandwidth:

$$RBW \leq 1/40 \text{ of channel bandwidth}$$

The maximum possible resolution bandwidth (with respect to the requirement $RBW \leq 1/40$) resulting from the available RBW steps (1, 3) is selected.

- **Video bandwidth (VBW)**

For a correct power measurement, the video signal must not be limited in bandwidth. A restricted bandwidth of the logarithmic video signal would cause signal averaging and thus result in a too low indication of the power (-2.51 dB at very low video bandwidths). The video bandwidth should therefore be selected at least three times the resolution bandwidth:

$$VBW \geq 3 \times RBW$$

The **Adjust Settings** softkey sets the video bandwidth (VBW) as a function of the channel bandwidth (see formula above) and the smallest possible VBW with regard to the available step size will be selected.

- **Detector**

The **Adjust Settings** softkey selects the RMS detector. This detector is selected since it correctly indicates the power irrespective of the characteristics of the signal to be measured. The whole IF envelope is used to calculate the power for each measurement point. The IF envelope is digitized using a sampling frequency which is at least five times the resolution bandwidth which has been selected. Based on the sample values, the power is calculated for each measurement point using the following formula:

$$P_{RMS} = \sqrt{\frac{1}{N} \cdot \sum_{i=1}^N s_i^2}$$

s_i = linear digitized video voltage at the output of the A/D converter

N = number of A/D converter values per measurement point

P_{RMS} = power represented by a measurement point

When the power has been calculated, the power units are converted into decibels and the value is displayed as a measurement point.

In principle, the sample detector would be possible as well. Due to the limited number of measurement points used to calculate the power in the channel, the sample detector would yield less stable results.

- **Trace averaging**

The **Adjust Settings** softkey switches off this function. Averaging, which is often performed to stabilize the measurement results, leads to a too low level indication and should therefore be avoided. The reduction in the displayed power depends on the number of averages and the signal characteristics in the channel to be measured.

- **Reference level**

The **Adjust Settings** softkey does not influence the reference level. It can be separately adjusted using the **Adjust Settings** softkey.

Ranges and range settings

In the Spectrum Emission Mask and Spurious Emissions measurements, a range defines a segment, for which you can define the following parameters separately: start and stop frequency, RBW, VBW, sweep time, sweep points, reference level, attenuator settings, and limit values. Via the sweep list, you define the ranges and their settings (for details on settings refer to the **Sweep List** softkey).

The following rules apply to ranges:

- The minimum span of a range is 20 Hz.
- The individual ranges must not overlap (but need not directly follow one another).
- The maximum number of ranges is 20.
- Spectrum Emission Mask measurement only: A minimum of three ranges is mandatory.
- Spectrum Emission Mask measurement only: The reference range cannot be deleted (it is marked in blue color).

Provided XML files for the Spectrum Emission Mask measurement

You can change the settings manually or via XML files. The XML files offer a quick way to change the configuration. A set of ready-made XML files for different standards is already provided. For details see Table 4-4. You can also create and use your own XML files (for details see "[Format description of Spectrum Emission Mask XML files](#)" on page 4.76). All XML files are stored under `C:\r_s\instr\sem_std`. Use the **Edit Power Classes** softkey for quick access to the available XML files.

Table 4-4: Provided XML files

Path	XML file name	Displayed standard characteristics*
C:\r_s\instr\sem_std\cdma2000\DL	default0.xml	CDMA2000 BC0 default DL
	default1.xml	CDMA2000 BC1 default DL
C:\r_s\instr\sem_std\cdma2000\UL	default0.xml	CDMA2000 BC0 default UL
	default1.xml	CDMA2000 BC1 default UL
C:\r_s\instr\sem_std\WCDMA\3GPP\DL	PowerClass_31_39.xml	W-CDMA 3GPP (31,39)dBm DL
	PowerClass_39_43.xml	W-CDMA 3GPP (39,43)dBm DL
	PowerClass_43_INF.xml	W-CDMA 3GPP (43,INF)dBm DL
	PowerClass_negINF_31.xml	W-CDMA 3GPP (-INF,31)dBm DL
C:\r_s\instr\sem_std\WIBRO\DL	PowerClass_29_40.xml	WiBro TTA (29,40)dBm DL
	PowerClass_40_INF.xml	WiBro TTA (40,INF)dBm DL
	PowerClass_negINF_29.xml	WiBro TTA (-INF,29)dBm DL
C:\r_s\instr\sem_std\WIBRO\UL	PowerClass_23_INF.xml	WiBro TTA (23,INF)dBm UL

Path	XML file name	Displayed standard characteristics*
	PowerClass_negINF_23.xml	WiBro TTA (23,INF)dBm UL
C:\R_S\instr\sem_std\WIMAX\DL\ETSI\...MHz (1.75 MHz, 2.00 MHz, 3.5 MHz, 7.00 MHz, 14.00 MHz, 28 MHz)	System_Type_E.xml	WIMAX DL ETSI-System Type E
	System_Type_F.xml	WIMAX ETSI-System Type F DL
	System_Type_G.xml	WIMAX ETSI-System Type G DL
C:\R_S\instr\sem_std\WIMAX\DL\IEEE	10MHz.xml	WIMAX 10MHz DL
	20MHz.xml	WIMAX 20MHz DL
C:\R_S\instr\sem_std\WIMAX\UL\ETSI...MHz (1.75 MHz, 2.00 MHz, 3.5 MHz, 7.00 MHz, 14.00 MHz, 28 MHz)	System_Type_E.xml	WIMAX System Type E UL
	System_Type_F.xml	WIMAX System Type F UL
	System_Type_G.xml	WIMAX System Type G UL
C:\R_S\instr\sem_std\WIMAX\UL\IEEE	10MHz.xml	WIMAX 10MHz UL
	20MHz.xml	WIMAX 20MHz UL
C:\R_S\instr\sem_std\WLAN\802_11_TURBO	ETSI.xml	IEEE 802.11
	IEEE.xml	IEEE 802.11
C:\R_S\instr\sem_std\WLAN\802_11a	ETSI.xml	IEEE 802.11a)
	IEEE.xml	IEEE 802.11a
C:\R_S\instr\sem_std\WLAN\802_11b	IEEE.xml	IEEE 802.11b
C:\R_S\instr\sem_std\WLAN\802_11j_10MHz	ETSI.xml	IEEE. 802.11j
	IEEE.xml	IEEE 802.11j
C:\R_S\instr\sem_std\WLAN\802_11j_20MHz	ETSI.xml	IEEE 802.11j
	IEEE.xml	IEEE 802.11j

*Used abbreviations:

BC: band class

UL: uplink

DL: downlink

TTA: Telecommunications Technology Association



For the WiBro standards, the 1 MHz channel filter is used for every occurrence of a 1 MHz filter. Within the R&S FSL-K92/93, the 1 MHz filter are Gaussian filters.

Format description of Spectrum Emission Mask XML files

The files for importing range settings are in XML format and therefore obey the rules of the XML standard. Below, the child nodes, attributes, and structure defined for the data import is described. Build your own XML files according to these conventions because the R&S FSL can only interpret XML files of a known structure. For example files look in the *C:\r_s\instr\sem_std directory*.



XML File Structure

It is mandatory to follow the structure exactly as shown below or else the R&S FSL is not able to interpret the XML file and error messages are shown on the screen. For this reason it is recommended to make a copy of an existing file (see **Save As Standard** softkey) and edit the copy of the file. The default files can be found in the C:\r_s\instr\sem_std directory.

Alternatively, edit the settings using the **Edit Power Classes** dialog box and the **Sweep List** dialog box and save the XML file with the **Save As Standard** softkey afterwards. This way, no modifications have to be done in the XML file itself.

Basically, the file consists of three elements that can be defined.

- The first element of the structure is the BaseFormat element. It carries information about basic settings. In this element only the ReferencePower child node has any effects on the measurement itself. The other attributes and child nodes are used to display information about the Spectrum Emission Mask Standard on the measurement screen. The child nodes and attributes of this element are shown in [Table 4-5](#).

Spectrum Emission Mask Standard: W-CDMA 3GPP DL (39,43)dBm							
Tx Power		-70.75 dBm	Tx Bandwidth		3.840 MHz	RBW	1 MHz
Range [Hz]	RBW [Hz]	Frequency [Hz]	PwrAbs [dBm]	PwrRel [dBc]	ΔLimit [dB]		
-12.750 M	-8.000 M	1 M	2.991974 G	-77.89	-7.14	47.36 *	
-8.000 M	-4.000 M	1 M	2.995923 G	-93.74	-22.99	-82.24	
-4.000 M	-3.515 M	30 k	2.996404 G	-100.18	-29.43	-75.68	
-3.515 M	-2.715 M	30 k	2.996512 G	-105.54	-34.78	-81.04	
-2.715 M	-2.515 M	30 k	2.997318 G	-105.54	-34.78	-93.04	
2.515 M	2.715 M	30 k	3.002548 G	-105.54	-34.78	-93.04	
2.715 M	3.515 M	30 k	3.003382 G	-102.45	-31.70	-79.95	
3.515 M	4.000 M	30 k	3.003919 G	-100.18	-29.43	-75.68	
4.000 M	8.000 M	1 M	3.004026 G	-105.54	-34.78	-81.04	
8.000 M	12.750 M	1 M	3.012724 G	-77.89	-7.14	47.36 *	

In the example above (*PowerClass_39_43.xml* under C:\r_s\instr\sem_std\WCDMA\3GPP), these attributes are defined as follows:

- Standard="W-CDMA 3GPP"
- LinkDirection="DL"
- PowerClass="(39,43)dBm"
- The second element is the PowerClass element, which is embedded in the BaseFormat element. It carries settings information about the power classes. Up to four different power classes can be defined. For details refer to the **Sweep List** softkey and the corresponding parameter description. The child nodes and attributes of this element are shown in [Table 4-6](#).
- The third element is the Range element, which in turn is embedded in the PowerClass element. It carries the settings information of the range. There have to be at least three defined ranges: one reference range and at least one range to either side of the reference range. The maximum number of ranges is twenty. Note that the R&S FSL uses the same ranges in each power class. Therefore, the contents of the ranges of each defined power class have to be identical to the first power class. An exception are the Start and Stop values of the two Limit nodes that are used to determine the power class. Note also, that there are two Limit nodes to be defined: one that gives the limit in absolute values and one in relative values. Make sure units for the Start and Stop nodes are identical for each Limit node. For details refer to the **Sweep List** softkey and the corresponding parameter description. The child nodes and attributes of this element are shown in [Table 4-7](#).

The following tables show the child nodes and attributes of each element and show if a child node or attribute is mandatory for the R&S FSL to interpret the file or not. Since the hierarchy of the XML can not be seen in the tables, either view one of the default files already stored on the R&S FSL in the `C:\r_sl\instr\sem_std` directory or check the structure as shown below.

Below, a basic example of the structure of the file is shown, containing all mandatory attributes and child nodes. Note that the `PowerClass` element and the `range` element are themselves elements of the `Base Format` element and are to be inserted where noted. The separation is done here simply for reasons of a better overview. Also, no example values are given here to allow a quick reference to the tables above. Italic font shows the placeholders for the values.

- The `Base Format` element is structured as follows:

```
<RS_SEM_ACP_FileFormat Version="1.0.0.0">
  <Name>Standard</Name>
  <Instrument>
    <Type>Instrument Type</Type>
    <Application>Application</Application>
  </Instrument>
  <LinkDirection Name="Name">
    <ReferencePower>
      <Method>Method</Method>
    </ReferencePower>
    <PowerClass Index="n">
      <!-- For contents of the PowerClass node see
      Table 4-6 -->
      <!-- Define up to four PowerClass nodes -->
    </PowerClass>
  </LinkDirection>
</RS_SEM_ACP_File>
```

- The `PowerClass` element is structured as follows:

```
<PowerClass Index="n">
  <StartPower Unit="dBm" InclusiveFlag="true" Value="StartPowerValue"/>
  <StopPower Unit="dBm" InclusiveFlag="false" Value="StopPowerValue"/>
  <DefaultLimitFailMode>Limit Fail Mode</DefaultLimitFailMode>
  <Range Index="n">
    <!-- For contents of the Range node see Table 4-7 -->
    <!-- Define up to twenty Range nodes -->
  </Range>
  ...
</PowerClass>
```

- The Range element is structured as follows:

```

<Range Index="n">
  <Name="Name">
    <ChannelType>Channel Type</Channel Type>
    <WeightingFilter>
      <Type>FilterType</Type>
      <RollOffFactor>Factor</RollOffFactor>
      <Bandwidth>Bandwidth</Bandwidth>
    </WeightingFilter>
    <FrequencyRange>
      <Start>RangeStart</Start>
      <Stop>RangeStop</Stop>
    </FrequencyRange>
    <Limit>
      <Start Unit="Unit" Value="Value"/>
      <Stop Unit="Unit" Value="Value"/>
    </Limit>
    <Limit>
      <Start Unit="Unit" Value="Value"/>
      <Stop Unit="Unit" Value="Value"/>
    </Limit>
    <RBW Bandwidth="Bandwidth" Type="FilterType"/>
    <VBW Bandwidth="Bandwidth"/>
    <Detector>Detector</Detector>
    <Sweep Mode="SweepMode" Time="SweepTime"/>
    <Amplitude>
      <ReferenceLevel Unit="dBm" Value="Value"/>
      <RFAttenuation Mode="Auto" Unit="dB" Value="Value"/>
      <Preamplifier State="State"/>
    </Amplitude>
  </Range>

```

Table 4-5: Attributes and child nodes of the BaseFormat element

Child Node	Attribute	Value	Parameter Description	Mandatory
	FileFormatVersion	1.0.0.0		Yes
	Date	"YYYY-MM-DD HH:MM:SS"	Date in ISO 8601 format	No
Name		<string>	Name of the standard	Yes
Instrument	Type	FSL	Name of the instrument	No

Child Node	Attribute	Value	Parameter Description	Mandatory
	Application	SA K72 K82	Name of the application	No
LinkDirection	Name	Downlink Uplink None		Yes
	ShortName	DL UL		No
ReferencePower				Yes
Method	TX Channel Power TX Channel Peak Power			Yes
ReferenceChannel	<string>			No

Table 4-6: Attributes and child nodes of the PowerClass element

Child Node	Attribute	Value	Parameter Description	Mandatory
	Index	0...3	Indexes are continuous and have to start with 0	Yes
StartPower	Value	<power in dBm>	The start power must equal the stop power of the previous power class. The StartPower value of the first range is -200	Yes
	Unit	dBm		Yes
	InclusiveFlag	"true"		Yes
StopPower	Value	<power in dBm>	The stop power must equal the start power of the next power class. The StopPower value of the last range is 200	Yes
	Unit	dBm		Yes
	InclusiveFlag	"false"		Yes
DefaultLimitFailMode		Absolute Relative Absolute and Relative Absolute or Relative		Yes

Table 4-7: Attributes and child nodes of the Range element (normal ranges)

Child Node	Attribute	Value	Parameter Description	Mandatory
	Index	0...19	Indexes are continuous and have to start with 0	Yes
	Name	<string>	Name of the range	Only if ReferenceChannel contains a name and the range is the reference range
	ShortName	<string>	Short name of the range	No
ChannelType		TX Adjacent		Yes
WeightingFilter				Only if ReferencePower method is "TX Channel Power" and the range is the reference range
Type		RRC CFILter	Type of the weighting filter	Yes
RollOffFactor		0...1	Excess bandwidth of the filter	Only if the filter type is RRC

Child Node	Attribute	Value	Parameter Description	Mandatory
Bandwidth		<Bandwidth in Hz>	Filter bandwidth	Only if the filter type is RRC
FrequencyRange				Yes
Start		<frequency in Hz>	Start value of the range	Yes
Stop		<frequency in Hz>	Stop value of the range	Yes
Limit			A Range must contain exactly two limit nodes; one of the limit nodes has to have a relative unit (e.g. dBc), the other one must have an absolute unit (e.g. dBm)	Yes
Start	Value	<numeric_value>	Power limit at start frequency	Yes
	Unit	dBm/Hz dBm dBc dBr dB	Sets the unit of the start value	Yes
Stop	Value	<numeric_value>	Power limit at stop frequency	Yes
	Unit	dBm/Hz dBm dBc dBr dB	Sets the unit of the stop value	Yes
LimitFailMode		Absolute Relative Absolute and Relative Absolute or Relative		No (if quoted, it has to be equal to DefaultLimitFailMode)
RBW	Bandwidth	<bandwidth in Hz>	RBW	Yes
	Type	NORM PULS CFIL RRC		No
VBW	Bandwidth	<bandwidth in Hz>	VBW	Yes
Detector		NEG POS SAMP RMS AVER QUAS	Detector	No (if quoted, it has to be equal in all ranges)
Sweep	Mode	Manual Auto	Sweep Time Mode	Yes
	Time	<time in sec>	Sweep Time	No
Amplitude				No
ReferenceLevel	Value	<power in dBm>	Ref. Level	Yes, if the ReferenceLevel child node is used
	Unit	dBm		Yes, if the ReferenceLevel node is used
RF Attenuation	Mode	Manual Auto	RF Attenuator	Yes, if the ReferenceLevel child node is used
Preamplifier		ON OFF	Preamp	Yes

ASCII file export format (Spectrum Emission Mask)

The first part of the file lists information about the spectrum analyzer and the general setup. For a detailed description refer to "ASCII file export format" on page 4.46.

File contents	Description
RefType; CPOWER; TxBandwidth;9540000;Hz Filter State; ON; Alpha;0.22;	reference range setup, for details see Edit Reference Range softkey
PeaksPerRange;1; Values;4;	evaluation list information
0;-22500000;-9270000;1000000;2986455000;-74.762840270996094; -10.576210021972656;-45.762840270996094;PASS; 1;-9270000;-4770000;100000;2991405000;-100.17695617675781; -35.990325927734375;-1.490325927734375;PASS 3;4770000;9270000;100000;3005445000;-100.17695617675781; -35.990325927734375;-1.490325927734375;PASS; 4;9270000;22500000;1000000;3018225000;-74.762840270996094; -10.576210021972656;-45.762840270996094;PASS;	information about each peak: <range number>; <start frequency>; <stop frequency>; <resolution bandwidth of range>; <frequency of peak>; <absolute power in dBm of peak>; <relative power in dBc of peak (related to the channel power)>; <distance to the limit line in dB (positive value means above the limit)>; <limit fail (pass = 0, fail =1)>;

Softkeys of the power measurement menu

The following table shows all softkeys available in the power measurement menu. It is possible that your instrument configuration does not provide all softkeys. If a softkey is only available with a special option, model or (measurement) mode, this information is delivered in the corresponding softkey description.

Menu / Command	Submenu / Command	Submenu / Command	Command
All Functions Off			
TOI ↓	Marker 1		
	Marker 2		
	Marker 3		
	Marker 4		
	Search Signals		
AM Mod Depth ↓	same contents as TOI menu		
Time Domain Power ↓	Peak		
	RMS		
	Mean		
	Std Dev		
	Limits On/Off		
	Left Limit		
	Right Limit		
C/N, C/No ↓	C/N		

Menu / Command	Submenu / Command	Submenu / Command	Command
	C/No		
	Channel Bandwidth		
	Adjust Settings		
CP, ACP, MC-ACP ↓	CP / ACP Standard		
	CP / ACP Config ↓	# of TX Chan	
		# of Adj Chan	
		Channel Settings ↓	Channel Bandwidth
			Channel Spacing
			Chan Pwr/Hz
			ACP Ref Settings
			Adjust Ref Level
			Adjust Settings
		Limit Checking ↓	Limit Chk On/Off
			Edit ACP Limit
		Power Mode ↓	Clear/Write
			Max Hold
		Select Trace	
		Adjust Settings	
	Sweep Time		
	Fast ACP On/Off		
	ACP Abs/Rel		
	Adjust Ref Level		
More ↓			
All Functions Off			
OBW ↓	% Power Bandwidth		
	Channel Bandwidth		
	Adjust Ref Level		
	Adjust Settings		
APD ↓	Percent Marker		
	Res BW		
	# of Samples		
	Scaling ↓	x-Axis Ref Level	
		x-Axis Range	
		y-Axis Max Value	
		y-Axis Min Value	
		y-Unit %/Abs	
		Default Settings	

Menu / Command	Submenu / Command	Submenu / Command	Command
		Adjust Settings	
	Adjust Settings		
CCDF ↓	same contents as APD menu		
Spectrum Emission Mask ↓	Sweep List ↓	Edit Sweep List/Close Sweep List	
		Insert before Range	
		Insert after Range	
		Delete Range	
		Edit Reference Range	
	List Evaluation ↓	List Evaluation On/Off	
		List Full Screen	
		Margin	
		Show Peaks	
		List Up	
		List Down	
		Save Evaluation List ↓	ASCII File Export
			Decim Sep
	Edit Reference Range		
	Edit Power Classes		
	Load Standard		
	Save As Standard		
	Restore Standard Files		
	Meas Start/Stop		
Spurious Emissions ↓	Sweep List ↓	Edit Sweep List/Close Sweep List	
		Insert before Range	
		Insert after Range	
		Delete Range	
		Adjust X-Axis	
	List Evaluation ↓	List Evaluation On/Off	
		List Full Screen	
		Details On/Off	
		Peaks per Range	
		Margin	
		Show Peaks	
		More ↓	
		List Up	
		List Down	

Menu / Command	Submenu / Command	Submenu / Command	Command
		Save Evaluation List ↓	ASCII File Export
			Decim Sep
	Meas Start/Stop		
More ↓			
All Functions Off			
Harmonic Distortion ↓	Harmonic On/Off		
	No. of Harmonics		
	Harmonic Sweep Time		
	Harmonic RBW Auto		
	Adjust Settings		
Full Size Diagram			

All Functions Off

Switches off all power measurement functions.

→ Remote: CALC:MARK:FUNC:<function> OFF

TOI

Opens a submenu and activates the measurement of the 3rd order intercept point.

A two-tone signal with equal carrier levels is expected at the R&S FSL input. Marker 1 and marker 2 (both normal markers) are set to the maximum of the two signals. Marker 3 and marker 4 (also both normal markers) are placed on the intermodulation products. When the function is enabled, the frequency entry is activated for the delta markers. They can be set manually.

The R&S FSL calculates the third order intercept point from the level spacing between normal markers and delta markers and displays it in the marker field.

→ Remote: CALC:MARK:FUNC:TOI ON

→ Remote: CALC:MARK:FUNC:TOI:RES?

Search Signals

Activates all markers.

→ Remote: CALC:MARK:FUNC:TOI:RES?

AM Mod Depth

Opens a submenu and activates the measurement of the AM modulation depth. An AM-modulated carrier is required on the screen for ensuring correct operation.

The level value of marker 1 is taken as the carrier level. When this function is activated, marker 2 and marker 3 are automatically set symmetrically to the carrier on the adjacent peak values of the trace as delta markers and marker 2 is activated for the entry.

When the position of marker 2 (delta) is changed, marker 3 (delta) is moved symmetrically with respect to the reference marker (marker 1).

If the edit dialog box is opened for marker 3, the latter can be moved for fine adjustment irrespective of marker 2.

The R&S FSL calculates the power at the marker positions from the measured levels. The AM modulation depth is calculated from the ratio between the power values at the reference marker and at the delta markers. If the powers of the two AM side bands are unequal, the mean value of the two power values is used for AM modulation depth calculation.

- Remote: CALC:MARK:FUNC:MDEP ON
- Remote: CALC:MARK:FUNC:MDEP:RES?

Time Domain Power (zero span)

Activates the power measurement in zero span and opens a submenu to configure the power measurement. For more details see also "[Power measurement in zero span](#)" on page 4.71.

- Remote: CALC:MARK:FUNC:SUMM:STAT ON

Peak (zero span)

Activates the calculation of the peak value from the points of the displayed trace or a segment thereof. For more details see also "[Power measurement in zero span](#)" on page 4.71.

- Remote: CALC:MARK:FUNC:SUMM:PPE ON
- Remote: CALC:MARK:FUNC:SUMM:PPE:RES?

RMS (zero span)

Activates the calculation of the RMS value from the points of the displayed trace or a segment thereof. For more details see also "[Power measurement in zero span](#)" on page 4.71.

- Remote: CALC:MARK:FUNC:SUMM:RMS ON
- Remote: CALC:MARK:FUNC:SUMM:RMS:RES?

Mean (zero span)

Activates the calculation of the mean value from the points of the displayed trace or a segment thereof. The linear mean value of the equivalent voltages is calculated.

This can be used for instance to measure the mean power during a GSM burst.

For more details see also "[Power measurement in zero span](#)" on page 4.71.

- Remote: CALC:MARK:FUNC:SUMM:MEAN ON
- Remote: CALC:MARK:FUNC:SUMM:MEAN:RES?

Std Dev (zero span)

Activates the calculation of the standard deviation of measurement points from the mean value and displays them as measured value. The measurement of the mean power is automatically switched on at the same time. For more details see also "[Power measurement in zero span](#)" on page 4.71.

- Remote: CALC:MARK:FUNC:SUMM:SDEV ON
- Remote: CALC:MARK:FUNC:SUMM:SDEV:RES?

Limits On/Off (zero span)

Switches the limitation of the evaluation range on or off. Default setting is off.

If switched off, the evaluation range is not limited. If switched on, the evaluation range is defined by the left and right limit. If only one limit is set, it corresponds to the left limit and the right limit is defined by the stop frequency. If the second limit is also set, it defines the right limit.

For more details see also "[Power measurement in zero span](#)" on page 4.71.

- Remote: CALC:MARK:X:SLIM OFF

Left Limit (zero span)

Opens an edit dialog box to enter a value for line 1. For more details see also "[Power measurement in zero span](#)" on page 4.71.

- Remote: CALC:MARK:X:SLIM:LEFT <value>

Right Limit (zero span)

Opens an edit dialog box to enter a value for line 2. For more details see also "[Power measurement in zero span](#)" on page 4.71.

- Remote: CALC:MARK:X:SLIM:RIGH <value>

C/N, C/No (span > 0)

Opens a submenu to configure the carrier/noise ratio measurement. Measurements without (C/N) and measurements with reference to the bandwidth (C/No) are possible.

C/N (span > 0)

Switches the measurement of the carrier/noise ratio on or off. If no marker is active, marker 1 is activated.

The measurement is performed on the trace where marker 1 is located. To shift marker 1 and measure another trace, use the **Marker to Trace** softkey in the marker menu. To determine the maximum value of the current trace, use the **Phase Noise/Ref Fixed** softkey in the marker menu.

- Remote: CALC:MARK:FUNC:POW:SEL CN
- Remote: CALC:MARK:FUNC:POW:RES? CN
- Remote: CALC:MARK:FUNC:POW OFF

C/No (span > 0)

Switches the measurement of the carrier/noise ratio with reference to a 1 Hz bandwidth on or off. If no marker is active, marker 1 is activated.

The measurement is performed on the trace where marker 1 is located. To shift marker 1 and measure another trace, use the **Marker to Trace** softkey in the marker menu. To determine the maximum value of the current trace, use the **Phase Noise/Ref Fixed** softkey in the marker menu.

- Remote: CALC:MARK:FUNC:POW:SEL CN0
- Remote: CALC:MARK:FUNC:POW:RES? CN0
- Remote: CALC:MARK:FUNC:POW OFF

Channel Bandwidth (span > 0)

Opens an edit dialog box to enter the measurement channel bandwidth. The default setting is 14 kHz.

- Remote: POW:ACH:BWID 30kHz

Adjust Settings (span > 0)

Enables the RMS detector (see also "[Detector overview](#)" on page 4.38) and adjusts the span to the selected channel bandwidth according to:

4 x channel bandwidth + measurement margin

The adjustment is performed once; if necessary, the setting can be changed later on.

- Remote: POW:ACH:PRES CN | CN0

CP, ACP, MC-ACP

Activates the active channel or adjacent-channel power measurement either for a single carrier signal or for several carrier signals, depending on the current measurement configuration, and opens a submenu to configure the channel power measurement. With default settings the measurement is performed by integrating the powers at the display points within the specified channels (IBW method).

If multi-carrier ACP measurement is activated, the number of measured values is increased to ensure that adjacent-channel powers are measured with adequate accuracy.

- Remote: CALC:MARK:FUNC:POW:SEL CPOW|ACP|MCAC
- Remote: CALC:MARK:FUNC:POW:RES? CPOW|ACP|MCAC
- Remote: CALC:MARK:FUNC:POW OFF

CP / ACP Standard

Opens an edit dialog box to select the settings according to predefined standards. For details on the available standards see "[Predefined CP / ACP standards](#)" on page 4.72. By default no standard is set.

The selection of the standard influences the following parameters:

- channel spacing and adjacent-channel spacing

- channel bandwidth, adjacent-channel bandwidth, and type of filtering
- resolution bandwidth
- video bandwidth
- detector
- # of adjacent channels
- trace averaging (switched off)

→ Remote: CALC:MARK:FUNC:POW:PRES <standard>

CP / ACP Config

Opens a submenu to configure the channel power and adjacent channel power measurement independently of the predefined standards (for details see also "[To set the channel configuration](#)" on page 4.70 and "[Settings of CP / ACP test parameters](#)" on page 4.73).

of TX Chan (MC-ACP)

Opens an edit dialog box to enter the number of carrier signals to be taken into account in channel and adjacent-channel power measurements. Values from 1 to 12 are allowed.

→ Remote: POW:ACH:TXCH:COUN 4

of Adj Chan

Opens an edit dialog box to enter the number of adjacent channels to be considered in the adjacent-channel power measurement. Values from 0 to 12 are allowed.

The following measurements are performed depending on the number of the channels:

- | | |
|-----|---|
| 0 | Only the channel powers are measured. |
| 1 | The channel powers and the power of the upper and lower adjacent channel are measured. |
| 2 | The channel powers, the power of the upper and lower adjacent channel, and of the next higher and lower channel (alternate channel 1) are measured. |
| 3 | The channel power, the power of the upper and lower adjacent channel, the power of the next higher and lower channel (alternate channel 1), and of the next but one higher and lower adjacent channel (alternate channel 2) are measured. |
| ... | ... |
| 12 | The channel power, the power of the upper and lower adjacent channel, and the power of the all higher and lower channels (alternate channel 1 to 11) are measured. |

→ Remote: POW:ACH:ACP 1

Channel Settings

Opens a submenu to define the channel settings.

Channel Bandwidth

Opens the **TX/ACP Channel Bandwidth** dialog box to enter the channel bandwidths for the transmission channels and the adjacent channels. The entry **TX** is only available for the multi-carrier ACP measurement.

The transmission-channel bandwidth is normally defined by the transmission standard. The correct bandwidth is set automatically for the selected standard (see **CP / ACP Standard** softkey).

Measurements in zero span (see **Fast ACP On/Off** softkey) are performed in the zero span mode. The channel limits are indicated by vertical lines. For measurements requiring channel bandwidths deviating from those defined in the selected standard the IBW method is to be used.

With the IBW method (see **Fast ACP On/Off** softkey), the channel bandwidth limits are marked by two vertical lines right and left of the channel center frequency. It can in this way be visually checked whether the entire power of the signal under test is within the selected channel bandwidth.

If measuring according to the IBW method (**Fast ACP Off**), the bandwidths of the different adjacent channels are to be entered numerically. Since all adjacent channels often have the same bandwidth, the other channels Alt1 and Alt2 are set to the bandwidth of the adjacent channel on entering the adjacent-channel bandwidth (ADJ). Thus only one value needs to be entered in case of equal adjacent channel bandwidths. The same holds true for the Alt2 channels (alternate channels 2) if the bandwidth of the Alt1 channel (alternate channel 1) is entered.

For details on available channel filters see "[List of available RRC and channel filters](#)" on page 4.18.

- Remote: POW:ACH:BWID 30kHz
- Remote: POW:ACH:BWID:ACH 30kHz
- Remote: POW:ACH:BWID:ALT2 30kHz

Channel Spacing

Opens the **TX/ACP Channel Spacing** dialog box to enter the channel spacings for the TX channels and for the adjacent channels.

The entry **TX** is only available for the multi-carrier ACP measurement.

– TX channels (left column)

- TX1-2 spacing between the first and the second carrier
- TX2-3 spacing between the second and the third carrier
-

The spacings between all adjacent TX channels can be defined separately. In order to allow a convenient setup for the system with equal TX channel spacing, the value of TX spacing 1-2 is copied in all the spacing below after entry, the TX spacing 2-3 is copied in all the spacing below after entry and so forth. For different spacings, a setup from top to bottom is necessary.

If the spacings are not equal, the channel distribution according to the center frequency is as follows:

- Odd number of TX channels The middle TX channel is centered to center frequency.
- Even number of TX channels The two TX channels in the middle are used to calculate the frequency between those two channels. This frequency is aligned to the center frequency.

- Adjacent channels (right column)

Since all the adjacent channels often have the same distance to each other, the modification of the adjacent-channel spacing (ADJ) causes a change in all higher adjacent-channel spacings (Alt1, Alt2, ...): they are all multiplied by the same factor (new spacing value / old spacing value). Thus only one value needs to be entered in case of equal channel spacing. A modification of a higher adjacent-channel spacing (Alt1, Alt2, ...) causes a change by the same factor in all higher adjacent-channel spacings, while the lower adjacent-channel spacings remain unchanged.

Example:

In the default setting, the adjacent channels have the following spacing: 20 kHz (**ADJ**), 40 kHz (**Alt1**), 60 kHz (**Alt2**), 80 kHz (**Alt3**), 100 kHz (**Alt4**), ...

If the spacing of the first adjacent channel (**ADJ**) is set to 40 kHz, the spacing of all other adjacent channels is multiplied by factor 2 to result in 80 kHz (**Alt1**), 120 kHz (**Alt2**), 160 kHz (**Alt3**), ...

If, starting from the default setting, the spacing of the 5th adjacent channel (**Alt4**) is set to 150 kHz, the spacing of all higher adjacent channels is multiplied by factor 1.5 to result in 180 kHz (**Alt5**), 210 kHz (**Alt6**), 240 kHz (**Alt7**), ...

If a ACP or MC-ACP measurement is started, all settings according to the standard including the channel bandwidths and channel spacings are set and can be adjusted afterwards.

- Remote: POW:ACH:SPAC:CHAN 25kHz
- Remote: POW:ACH:SPAC 33kHz
- Remote: POW:ACH:SPAC:ALT1 100kHz

Chan Pwr/Hz

If deactivated, the channel power is displayed in dBm. If activated, the channel power density is displayed instead. Thus, the absolute unit of the channel power is switched from dBm to dBm/Hz. The channel power density in dBm/Hz corresponds to the power inside a bandwidth of 1 Hz and is calculated as follows:

$$\text{channel power density} = \text{channel power} - \log_{10}(\text{channel bandwidth})$$

By means of this function it is possible e.g. to measure the signal/noise power density or use the additional functions **ACP Abs/Rel** and **ACP Ref Settings** to obtain the signal to noise ratio.

This softkey is available from firmware version 1.50.

- Remote: CALC:MARK:FUNC:POW:RES:PHZ ON

ACP Ref Settings (MC-ACP)

Opens an edit dialog box to select the transmission channel to which the adjacent-channel relative power values should be referenced.

TX Channel 1 - 12	Selection of one of channels 1 to 12.
Min Power TX Channel	The transmission channel with the lowest power is used as a reference channel.
Max Power TX Channel	The transmission channel with the highest power is used as a reference channel.
Lowest & Highest Channel	The outer left-hand transmission channel is the reference channel for the lower adjacent channels, the outer right-hand transmission channel that for the upper adjacent channels.

- Remote: POW:ACH:REF:TXCH:MAN 3
 - Remote: POW:ACH:REF:TXCH:AUTO MAX
-

Limit Checking

Opens a submenu to activate and define the limits for the ACP measurement.
This softkey is available from firmware version 1.30.

Limit Chk On/Off

Activates or deactivates the limit check for the ACP measurement.

- Remote: CALC:LIM:ACP ON
 - Remote: CALC:LIM:ACP:ACH:RES?
 - Remote: CALC:LIM:ACP:ALT:RES?
-

Edit ACP Limit

Opens the **ACP Limits** dialog box to define the limits for the ACP measurement.

The following rules apply for the limits:

- A separate limit can be defined for each adjacent channel. The limit applies to both the upper and the lower adjacent channel.
- A relative and/or absolute limit can be defined. The check of both limit values can be activated independently.
- The R&S FSL checks adherence to the limits irrespective of whether the limits are absolute or relative or whether the measurement is carried out with absolute or relative levels. If both limits are active and if the higher of both limit values is exceeded, the measured value is marked by a preceding asterisk.

- Remote: CALC:LIM:ACP ON
- Remote: CALC:LIM:ACP:<adjacent-channel> 0dB,0dB
- Remote: CALC:LIM:ACP:<adjacent-channel>:STAT ON
- Remote: CALC:LIM:ACP:<adjacent-channel>:ABS -10dBm,-10dBm
- Remote: CALC:LIM:ACP:<adjacent-channel>:ABS:STAT ON

For details refer to chapter "Remote Control - Commands", section "CALCulate:LIMit:ACPower Subsystem".

Power Mode

Opens a submenu to select the power mode.
This softkey is available from firmware version 1.30.

Clear/Write

If this mode is activated, the channel power and the adjacent channel powers are calculated directly from the current trace (default mode).

This softkey is available from firmware version 1.30.

→ Remote: CALC:MARK:FUNC:POW:MODE WRIT

Max Hold

If this mode is activated, the power values are calculated from the current trace and compared with the previous power value using a maximum algorithm. The higher value is retained. If activated, the enhancement label **Pwr Max** is displayed.

This softkey is available from firmware version 1.30.

→ Remote: CALC:MARK:FUNC:POW:MODE MAXH

Select Trace

Opens an edit dialog box to enter the trace number on which the CP/ACP measurement is to be performed. Only activated traces can be selected (for details on trace modes see "[Trace mode overview](#)" on page 4.36).

→ Remote: POW:TRAC 2

Adjust Settings

Automatically optimizes all instrument settings for the selected channel configuration (channel bandwidth, channel spacing) within a specific frequency range (channel bandwidth). The adjustment is carried out only once. If necessary, the instrument settings can be changed later.

For details on the settings of span, resolution bandwidth, video bandwidth, detector and trace averaging see "[Settings of CP / ACP test parameters](#)" on page 4.73.

→ Remote: POW:ACH:PRES ACP

Sweep Time

Opens an edit dialog box to enter the sweep time. With the RMS detector, a longer sweep time increases the stability of the measurement results.

The function of this softkey is identical to the **Sweeptime Manual** softkey in the bandwidth menu.

→ Remote: SWE:TIM <value>

Fast ACP On/Off

Switches between the IBW method (**Fast ACP Off**) and the zero span method (**Fast ACP On**).

When switched on, the R&S FSL sets the center frequency consecutively to the different channel center frequencies and measures the power with the selected measurement time (= sweep time/number of channels). The RBW filters suitable for the selected standard and frequency offset are automatically used (e.g. root raised cos with IS 136). For details on available channel filters see "[List of available RRC and channel filters](#)" on page 4.18.

The RMS detector is used for obtaining correct power measurement results. Therefore this requires no software correction factors.

Measured values are output as a list. The powers of the transmission channels are output in dBm, the powers of the adjacent channels in dBm.

The sweep time is selected depending on the desired reproducibility of results. Reproducibility increases with sweep time since power measurement is then performed over a longer time period. As a general approach, it can be assumed that approx. 500 non-correlated measured values are required for a reproducibility of 0.5 dB (99% of the measurements are within 0.5 dB of the true measured value). This holds true for white noise. The measured values are considered as non-correlated if their time interval corresponds to the reciprocal of the measured bandwidth.

With IS 136 the measurement bandwidth is approx. 25 kHz, i.e. measured values at an interval of 40 μ s are considered as non-correlated. A measurement time of 40 ms is thus required per channel for 1000 measured values. This is the default sweep time which the R&S FSL sets in coupled mode. Approx. 5000 measured values are required for a reproducibility of 0.1 dB (99%), i.e. the measurement time is to be increased to 200 ms.

→ Remote: POW:HSP ON

ACP Abs/Rel

Switches between absolute and relative power measurement in the adjacent channels.

Abs	The absolute power in the adjacent channels is displayed in the unit of the y-axis, e.g. in dBm, dB μ V.
Rel	The level of the adjacent channels is displayed relative to the level of the transmission channel in dBc.

→ Remote: POW:ACH:MODE REL

Adjust Ref Level

Adjusts the reference level to the measured channel power. This ensures that the settings of the RF attenuation and the reference level are optimally adjusted to the signal level without overloading the R&S FSL or limiting the dynamic range by a too small S/N ratio. For details on manual settings see "[Settings of CP / ACP test parameters](#)" on page 4.73.

The reference level is not influenced by the selection of a standard. To achieve an optimum dynamic range, the reference level has to be set in a way that places the signal maximum close to the reference level without forcing an overload message. Since the measurement bandwidth for channel power measurements is significantly lower than the signal bandwidth, the signal path may be overloaded although the trace is still significantly below the reference level.

→ Remote: POW:ACH:PRES:RLEV

OBW (span > 0)

Activates measurement of the occupied bandwidth according to the current configuration and opens a submenu to configure the measurement. The occupied bandwidth is displayed in the marker display field and marked on the trace by temporary markers. For details see also "[Measurement of occupied bandwidth](#)" on page 4.72.

The measurement is performed on the trace with marker 1. In order to evaluate another trace, marker 1 must be placed on another trace (see **Marker to Trace** softkey in the marker menu).

- Remote: CALC:MARK:FUNC:POW:SEL:OBW
- Remote: CALC:MARK:FUNC:POW:RES?:OBW
- Remote: CALC:MARK:FUNC:POW:OFF

% Power Bandwidth (span > 0)

Opens an edit dialog box to enter the percentage of total power in the displayed frequency range which defines the occupied bandwidth. Values from 10% to 99.9% are allowed.

- Remote: POW:BWID:95PCT

Channel Bandwidth (span > 0)

Opens an edit dialog box to enter the channel bandwidth for the transmission channel. The specified channel bandwidth is used for optimization of the test parameters (for details see "[Settings of CP / ACP test parameters](#)" on page 4.73). The default setting is 14 kHz.

For measurements in line with a specific transmission standard, the bandwidth specified by the standard for the transmission channel must be entered.

- Remote: POW:ACH:BWID:30kHz

Adjust Ref Level (span > 0)

Adjusts the reference level to the measured total power of the signal. The softkey is activated after the first sweep with active measurement of the occupied bandwidth has been completed and the total power of the signal is thus known.

Adjusting the reference level ensures that the signal path will not be overloaded and the dynamic range not limited by too low a reference level. Since the measurement bandwidth for channel power measurements is significantly lower than the signal bandwidth, the signal path may be overloaded although the trace is distinctly below the reference level. If the measured channel power is equal to the reference level, the signal path cannot be overloaded.

- Remote: POW:ACH:PRES:RLEV

APD

Activates the function to measure the amplitude probability density (APD) and opens a submenu.

- Remote: CALC:STAT:APD:ON

Percent Marker

Opens an edit dialog box to enter a probability value and to position marker 1. Thus, the power which is exceeded with a given probability can be determined very easily. If marker 1 is deactivated, it will be switched on automatically.

→ Remote: `CALC:MARK:Y:PERC 0...100%`

Res BW

Opens an edit dialog box to set the resolution bandwidth directly. The function of this softkey is identical to the **Res BW Manual** softkey in the bandwidth menu.

For correct measurement of the signal statistics the resolution bandwidth has to be wider than the signal bandwidth in order to measure the actual peaks of the signal amplitude correctly. In order not to influence the peak amplitudes the video bandwidth is automatically set to 10 MHz. The sample detector is used for detecting the video voltage.

→ Remote: `BAND 3 MHz`

of Samples

Opens an edit dialog box to set the number of power measurements that are taken into account for the statistics.

Apart from the number of measurements the overall measurement time depends also on the set resolution bandwidth as the resolution bandwidth directly influences the sampling rate.

→ Remote: `CALC:STAT:NSAM <value>`

Scaling

Opens a submenu to change the scaling parameters of x- and y-axis.

x-Axis Ref Level

Opens an edit dialog box to enter the reference level in the currently active unit (dBm, dBµV, etc). The function of this softkey is identical to the **Ref Level** softkey in the amplitude menu.

For the APD function this value is mapped to the right diagram border. For the CCDF function there is no direct representation of this value on the diagram as the x-axis is scaled relatively to the measured mean power.

→ Remote: `CALC:STAT:SCAL:X:RLEV <value>`

x-Axis Range

Opens the **Range Log** dialog box to select a value for the level range to be covered by the statistics measurement selected. The function is identical to the **Range Log** softkey in amplitude menu.

→ Remote: `CALC:STAT:SCAL:X:RANG <value>`

y-Axis Max Value

Opens an edit dialog box to define the upper limit of the displayed probability range. Values on the y-axis are normalized which means that the maximum value is 1.0. The y-axis scaling is defined via the **y-Unit %/Abs** softkey. If the y-axis has logarithmic scale, the distance between max and min value must be at least one decade.

→ Remote: `CALC:STAT:SCAL:Y:UPP <value>`

y-Axis Min Value

Opens an edit dialog box to define the lower limit of the displayed probability range. Values in the range $0 < \text{value} < 1$ are allowed. The y-axis scaling is defined via the **y-Unit %/Abs** softkey. If the y-axis has logarithmic scale, the distance between max and min value must be at least one decade.

→ Remote: `CALC:STAT:SCAL:Y:LOW <value>`

y-Unit %/Abs

Defines the scaling type of the y-axis. The default value is absolute scaling.

This softkey is available from firmware version 1.80.

→ Remote: `CALC:STAT:SCAL:Y:UNIT PCT`

Default Settings

Resets the x- and y-axis scalings to their preset values.

x-axis ref level: -20 dBm

x-axis range APD: 100 dB

x-axis range CCDF: 20 dB

y-axis upper limit: 1.0

y-axis lower limit: 1E-6

→ Remote: `CALC:STAT:PRES`

Adjust Settings

Adjusts the level settings according to the measured difference between peak and minimum power for APD measurement or peak and mean power for CCDF measurement in order to obtain maximum power resolution. Adapts the probability scale to the selected number of samples. Adjusts the reference level to the current input signal. For details see also **Adjust Ref Level** softkey.

→ Remote: `CALC:STAT:SCAL:AUTO ONCE`

CCDF

Activates the function to measure the complementary cumulative distribution function (CCDF) and opens a submenu.

→ Remote: `CALC:STAT:CCDF ON`

Spectrum Emission Mask

Opens a submenu to configure the Spectrum Emission Mask measurement.

The Spectrum Emission Mask (SEM) measurement defines a measurement that monitors compliance with a spectral mask. The SEM measurement of the base unit allows a flexible definition of all parameters in the SEM measurement.

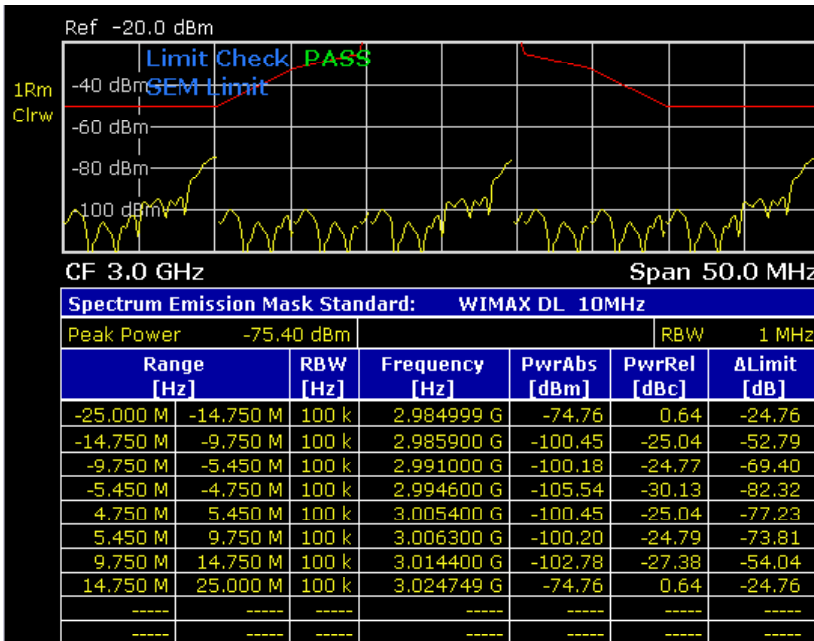

This softkey is available from firmware version 1.80.

→ Remote: SWE:MODE ESP

Sweep List

Opens a submenu to edit the sweep list and displays the **Sweep List** dialog box. After a preset, the sweep list contains a set of default ranges and parameters. For each range, you can change the parameters listed below. To insert or delete ranges, use the **Insert before Range**, **Insert after Range**, **Delete Range** softkeys. The measurement results are not updated during editing but on closing the dialog box (**Close Sweep List** softkey).



If you edit the sweep list, always follow the rules described in "Ranges and range settings" on page 4.75.

Parameter	Restriction
Range Start	
Range Stop	
Filter Type	
RBW	
VBW	
Sweep Time Mode	

Parameter	Restriction
Sweep Time	
Detector	Spurious Emissions measurement only
Ref. Level	
RF Att. Mode	
RF Attenuator	
Preamp	
Sweep Points	Spurious Emissions measurement only
Stop after Sweep	Spurious Emissions measurement only
Transd. Factor	
Limit Check 1 to 4	
Abs Limit Start	
Abs Limit Stop	
Rel Limit Start	Spectrum Emission Mask measurement only
Rel Limit Stop	Spectrum Emission Mask measurement only

- Spectrum Emission Mask measurement:

The changes of the sweep list are only kept until you load another parameter set (via a preset or by loading an XML file). If you want to have a parameter set permanently available, create an XML file for this configuration (for details refer to "[Format description of Spectrum Emission Mask XML files](#)" on page 4.76).

If you load one of the provided XML files (**Load Standard** softkey), the sweep list contains ranges and parameters according to the selected standard. For further details refer also to "[Provided XML files for the Spectrum Emission Mask measurement](#)" on page 4.75.

This softkey is available from firmware version 1.80.

Range Start/Range Stop (Sweep List dialog box)

Sets the start frequency/stop frequency of the selected range. Follow the rules described in "[Ranges and range settings](#)" on page 4.75.

In order to change the start/stop frequency of the first/last range, select the appropriate span with the **SPAN** key. If you set a span that is smaller than the overall span of the ranges, the measurement includes only the ranges that lie within the defined span and have a minimum span of 20 Hz. The first and last range are adapted to the given span as long as the minimum span of 20 Hz is not violated.

- Spectrum Emission Mask measurement:

Frequency values for each range have to be defined relative to the center frequency. The reference range has to be centered on the center frequency. The minimum span of the reference range is given by the current TX Bandwidth. For details refer to the **Edit Reference Range** softkey description.

- Remote: ESP:RANG1:STAR 100000000 (Spectrum Emission Mask)
- Remote: ESP:RANG3:STOP 10000000 (Spectrum Emission Mask)
- Remote: LIST:RANG1:STAR 100000000 (Spurious Emissions)
- Remote: LIST:RANG3:STOP 10000000 (Spurious Emissions)

Filter Type (Sweep List dialog box)

Sets the filter type for this range. For details on filters see also "[To choose the appropriate filter type](#)" on page 4.17.

- Remote: `ESP:RANG1:FILT:TYPE RRC` (Spectrum Emission Mask)
 - Remote: `LIST:RANG1:FILT:TYPE RRC` (Spurious Emissions)
-

RBW (Sweep List dialog box)

Sets the RBW value for this range.

- Remote: `ESP:RANG2:BAND:RES 5000` (Spectrum Emission Mask)
 - Remote: `LIST:RANG2:BAND:RES 5000` (Spurious Emissions)
-

VBW (Sweep List dialog box)

Sets the VBW value for this range.

- Remote: `ESP:RANG1:BAND:VID 5000000` (Spectrum Emission Mask)
 - Remote: `LIST:RANG1:BAND:VID 5000000` (Spurious Emissions)
-

Sweep Time Mode (Sweep List dialog box)

Activates or deactivates the auto mode for the sweep time.

- Remote: `ESP:RANG3:SWE:TIME:AUTO OFF` (Spectrum Emission Mask)
 - Remote: `LIST:RANG3:SWE:TIME:AUTO OFF` (Spurious Emissions)
-

Sweep Time (Sweep List dialog box)

Sets the sweep time value for the range.

- Remote: `ESP:RANG1:SWE:TIME 1` (Spectrum Emission Mask)
 - Remote: `LIST:RANG1:SWE:TIME 1` (Spurious Emissions)
-

Detector (Sweep List dialog box, Spurious Emissions)

Sets the detector for the range. For details refer to "[Detector overview](#)" on page 4.38.

- Remote: `LIST:RANGe3:DET SAMP`
-

Ref. Level (Sweep List dialog box)

Sets the reference level for the range.

- Remote: `ESP:RANG2:RLEV 0` (Spectrum Emission Mask)
 - Remote: `LIST:RANG2:RLEV 0` (Spurious Emissions)
-

RF Att. Mode (Sweep List dialog box)

Activates or deactivates the auto mode for RF attenuation.

- Remote: `ESP:RANG2:INP:ATT:AUTO OFF` (Spectrum Emission Mask)
 - Remote: `LIST:RANG2:INP:ATT:AUTO OFF` (Spurious Emissions)
-

RF Attenuator (Sweep List dialog box)

Sets the attenuation value for that range.

- Remote: `ESP:RANG3:INP:ATT 10` (Spectrum Emission Mask)
 - Remote: `LIST:RANG3:INP:ATT 10` (Spurious Emissions)
-

Preamp (Sweep List dialog box)

Switches the preamplifier on or off.

- Remote: `ESP:RANG3:INP:GAIN:STATE ON` (Spectrum Emission Mask)
 - Remote: `LIST:RANG3:INP:GAIN:STATE ON` (Spurious Emissions)
-

Sweep Points (Sweep List dialog box, Spurious Emissions)

Sets the number of sweep points per range. For details on possible values refer to the **Sweep Points** softkey of the sweep menu.

- Remote: `LIST:RANG3:POIN 601`
-

Stop after Sweep (Sweep List dialog box, Spurious Emissions)

Configures the sweep behavior.

On The R&S FSL stops after one range is swept and continues only if you confirm (a message box is displayed).

Off The R&S FSL sweeps all ranges in one go.

- Remote: `LIST:RANG1:BRE ON`
-

Transd. Factor (Sweep List dialog box)

Sets a transducer for the specified range. You can only choose a transducer that fulfills the following conditions:

- The transducer overlaps or equals the span of the range.
- The x-axis is linear.
- The unit is dB.

- Remote: `ESP:RANG1:TRAN 'test'` (Spectrum Emission Mask)
 - Remote: `LIST:RANG1:TRAN 'test'` (Spurious Emissions)
-

Limit Check 1 to 4 (Sweep List dialog box)

Sets the type of limit check for all ranges. Possible states are:

Absolute	Checks only the absolute limits defined.
Relative	Checks only the relative limits. Relative limits are defined as relative to the measured power in the reference range.
Abs and Rel	Combines the absolute and relative limit. The limit check fails when both limits are violated.
Abs or Rel	Combines the absolute and relative limit. The limit check fails when one of the limits is violated.

The limit state affects the availability of all limit settings (**Abs Limit Start, Abs Limit Stop, Rel Limit Start, Rel Limit Stop**).

Dependent on the number of active power classes (see **Edit Power Classes** dialog box), the number of limits that can be set varies. Up to four limits are possible. The sweep list is extended accordingly.

- Remote: `ESP:RANG3:LIM:STAT AND` (Spectrum Emission Mask)
 - Remote: `LIST:RANG3:LIM:STAT ON` (Spurious Emissions)
 - Remote: `CALC:LIM3:FAIL?`
-

Abs Limit Start (Sweep List dialog box)

Sets an absolute limit value at the start frequency of the range [dBm].

This parameter is only available if the limit check is set accordingly (see **Limit Check 1 to 4** parameter).

Dependent on the number of active power classes (see **Edit Power Classes** dialog box), the number of limits that can be set varies. Up to four limits are possible. The sweep list is extended accordingly.

- Remote: `ESP:RANG1:LIM:ABS:STAR 10` (Spectrum Emission Mask)
 - Remote: `LIST:RANG1:LIM:STAR 10` (Spurious Emissions)
-

Abs Limit Stop (Sweep List dialog box)

Sets an absolute limit value at the stop frequency of the range [dBm].

This parameter is only available if the limit check is set accordingly (see **Limit Check 1 to 4** parameter).

Dependent on the number of active power classes (see **Edit Power Classes** dialog box), the number of limits that can be set varies. Up to four limits are possible. The sweep list is extended accordingly.

- Remote: `ESP:RANG1:LIM:ABS:STOP 20` (Spectrum Emission Mask)
 - Remote: `LIST:RANG1:LIM:STOP 20` (Spurious Emissions)
-

Rel Limit Start (Sweep List dialog box, Spectrum Emission Mask)

Sets a relative limit value at the start frequency of the range [dBc].

This parameter is only available if the limit check is set accordingly (see **Limit Check 1 to 4** parameter).

Dependent on the number of active power classes (see **Edit Power Classes** dialog box), the number of limits that can be set varies. Up to four limits are possible. The sweep list is extended accordingly.

→ Remote: `ESP:RANG3:LIM:REL:STAR -20`

Rel Limit Stop (Sweep List dialog box, Spectrum Emission Mask)

Sets a relative limit value at the stop frequency of the range [dBc].

This parameter is only available if the limit check is set accordingly (see **Limit Check 1 to 4** parameter).

Dependent on the number of active power classes (see **Edit Power Classes** dialog box), the number of limits that can be set varies. Up to four limits are possible. The sweep list is extended accordingly.

→ Remote: `ESP:RANG3:LIM:REL:STOP 20`

Edit Sweep List/Close Sweep List

Opens/ closes the **Sweep List** dialog box. Closing the dialog box updates the measurement results.

For further details refer to "[Ranges and range settings](#)" on page 4.75.

This softkey is available from firmware version 1.80.

Insert before Range

Inserts a new range to the left of the currently focussed range. The range numbers of the currently focused range and all higher ranges are increased accordingly. The maximum number of ranges is 20.

For further details refer to "[Ranges and range settings](#)" on page 4.75.

This softkey is available from firmware version 1.80.

→ Remote: `ESP:RANG3:INS BEF (Spectrum Emission Mask)`

Insert after Range

Inserts a new range to the right of the currently focused range. The range numbers of all higher ranges are increased accordingly. The maximum number of ranges is 20.

For further details refer to "[Ranges and range settings](#)" on page 4.75.

This softkey is available from firmware version 1.80.

→ Remote: `ESP:RANG1:INS AFT (Spectrum Emission Mask)`

Delete Range

Deletes the currently focused range, if possible. The range numbers are updated accordingly. For further details refer to "[Ranges and range settings](#)" on page 4.75.

This softkey is available from firmware version 1.80.

- Remote: ESP:RANG4:DEL (Spectrum Emission Mask)
 - Remote: LIST:RANG4:DEL (Spurious Emissions)
-

Edit Reference Range

Opens the **Reference Range** dialog box to edit the additional settings used for SEM measurements.

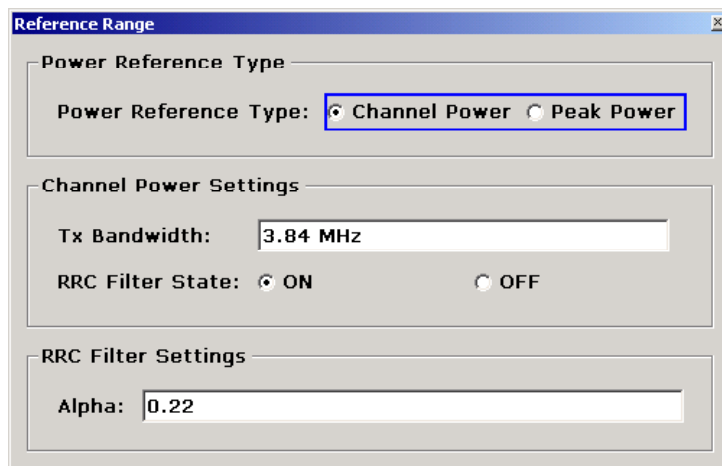

- **Peak Power**

Measures the highest peak within the reference range.

- **Channel Power**

Measures the channel power within the reference range (integral bandwidth method).

If the **Channel Power** reference power type is activated, the dialog box is extended to define additional settings:

- **Tx Bandwidth**

Defines the bandwidth used for measuring the channel power:
 minimum span \leq value \leq span of reference range

- **RRC Filter State**

Activates or deactivates the use of an RRC filter.

- **RRC Filter Settings**

Sets the alpha value of the RRC filter. This pane is only available if the RRC filter is activated.

For further details refer to "[Ranges and range settings](#)" on page 4.75.

This softkey is available from firmware version 1.80.

- Remote: ESP:RTYP PEAK
 - Remote: ESP:BWID 1MHZ
 - Remote: ESP:FILT OFF
 - Remote: ESP:FILT:ALPH 0.5
-

List Evaluation

Opens a submenu to edit the list evaluation settings.

This softkey is available from firmware version 1.80.

List Evaluation On/Off

Activates or deactivates the list evaluation.

This softkey is available from firmware version 1.80.

- Remote: `CALC:ESP:PSE:AUTO OFF` (Spectrum Emission Mask)
 - Remote: `CALC:PSE:AUTO OFF` (Spurious Emissions)
 - Remote: `TRAC? LIST`
-

List Full Screen

Switches between split screen and full screen.

deactivated split screen (diagram and list)

activated list in full screen

This softkey is available from firmware version 1.80.

- Remote: `DISP:WIND2:SIZE LARG`
-

Margin

Opens an edit dialog box to enter the margin used for the limit check/peak search.

This softkey is available from firmware version 1.80.

- Remote: `CALC:ESP:PSE:MARG 100` (Spectrum Emission Mask)
 - Remote: `CALC:PEAK:MARG 100` (Spurious Emissions)
-

Show Peaks

In the diagram, marks all peaks with blue squares that have been listed during an active list evaluation.

This softkey is available from firmware version 1.80.

- Remote: `CALC:ESP:PSE:PSH ON` (Spectrum Emission Mask)
 - Remote: `CALC:PSE:PSH ON` (Spurious Emissions)
-

List Up/List Down

Scrolls through the evaluation list if the number of found peaks exceeds the number of rows shown in the evaluation list table.

These softkeys are available from firmware version 1.80.

Save Evaluation List

Opens the **ASCII File Export Name** dialog box to save the result in ASCII format to a specified file and directory. For further details refer also to the **ASCII File Export** softkey.

This softkey is available from firmware version 1.80.

→ Remote: MEM:STOR:LIST 'test'

ASCII File Export

An example of an output file is given in "[ASCII file export format \(Spectrum Emission Mask\)](#)" on page 4.82. For further details refer also to the **ASCII File Export** softkey in the trace menu of the base unit.

This softkey is available from firmware version 1.80.

→ Remote: MEM:STOR:LIST 'test'

Decim Sep

For details refer to the **Decim Sep** softkey in the trace menu of the base unit.

This softkey is available from firmware version 1.80.

Edit Power Classes

Opens a dialog box to modify the power class settings.

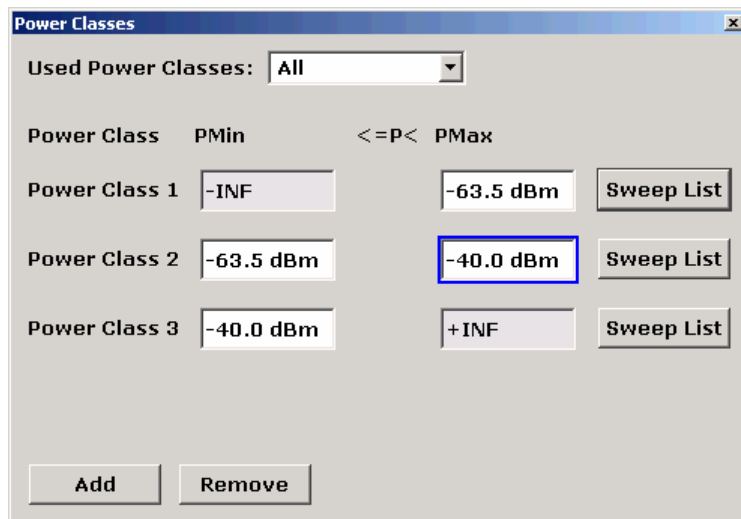

The dialog box contains the following elements:

– **Used Power Classes**

Choose the power classes to be used from this dropdown menu. It is only possible to select either one of the defined power classes or all of the defined power classes together.

Only power classes for which limits are defined are available for selection.

– **PMin / PMax**

Defines the level limits for each power class. The range always starts at -200 dBm (-INF) and always stops at 200 dBm (+INF). These fields cannot be modified. If more than one Power Class is defined, the value of PMin must equal the value of PMax of the last Power Class and vice versa.

– **Sweep List**

Opens the sweep list dialog box. For details see the **Sweep List** dialog box.

– **Add / Remove**

Activates or deactivates power classes to be defined. Up to four power classes can be defined. The number of active power classes affect the availability of the items of the Used Power Classes dropdown menu.

This softkey is available from firmware version 1.90.

- Remote: CALC:LIM:ESP:PCL ON
 - Remote: CALC:LIM:ESP:PCL MIN <numeric_value>
 - Remote: CALC:LIM:ESP:PCL:MAX <numeric_value>
 - Remote: CALC:LIM:ESP:PCL:COUN <numeric_value>
 - Remote: CALC:LIM:ESP:PCL:LIM ABS
-

Load Standard

Opens a dialog box to select an XML file which includes the desired standard specification. For details on the provided XML files refer to "[Provided XML files for the Spectrum Emission Mask measurement](#)" on page 4.75.

This softkey is available from firmware version 1.80.

- Remote: ESP:PRES 'WCDMA\3GPP\DL\PowerClass_31_39.xml'
-

Save As Standard

Opens the **Save As Standard** dialog box, in which the currently used SEM settings and parameters can be saved and exported into an *.xml file. Enter the name of the file in the file name field. For details on the structure and contents of the XML file refer to "[Format description of Spectrum Emission Mask XML files](#)" on page 4.76.

This softkey is available from firmware version 1.90.

- Remote: SENS:ESP:STOR "<file name>"
-

Restore Standard Files

Copies the XML files from the C:\R_S\instr\sem_backup folder to the C:\R_S\instr\sem_std folder. Files of the same name are overwritten.

This softkey is available from firmware version 1.80.

- Remote: ESP:PRES:REST
-

Meas Start/Stop

Aborts/restarts the current measurement and displays the status:

Start The measurement is currently running.

Stop The measurement has been stopped, or, in single sweep mode, the end of the sweep has been reached.

This softkey is available from firmware version 1.80.

- Remote: ABOR
- Remote: INIT:ESP (Spectrum Emission Mask)
- Remote: INIT:SPUR (Spurious Emissions)
- Remote: INIT:CONM (Spurious Emissions)

Spurious Emissions

Opens a submenu to configure the Spurious Emissions measurement.

The Spurious Emissions measurement defines a measurement that monitors unwanted RF products outside the assigned frequency band generated by an amplifier. The spurious emissions are usually measured across a wide frequency range. The Spurious Emissions measurement allows a flexible definition of all parameters.

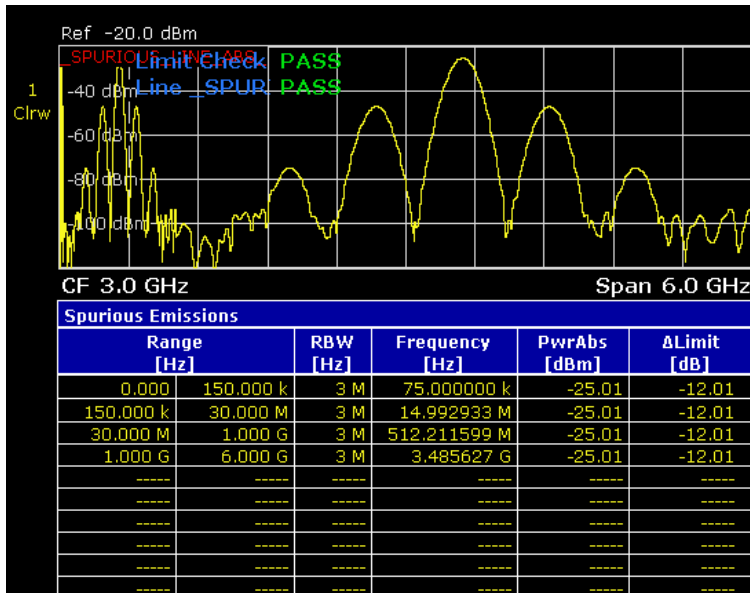

This softkey is available from firmware version 1.80.

- Remote: SWE:MODE LIST

Adjust X-Axis

Adjusts the frequency axis of measurement diagram automatically so that the start frequency matches the start frequency of the first sweep range, and the stop frequency of the last sweep range.

This softkey is available from firmware version 1.80.

Details On/Off

Configures the list contents.

- On Displays the whole list contents.
- Off Displays only the highest peaks (one peak per range).

This softkey is available from firmware version 1.80.

Peaks per Range

Opens an edit dialog box to enter the number of peaks per range that are stored in the list. Once the selected number of peaks has been reached, the peak search is stopped in the current range and continued in the next range. The maximum value is 50.

This softkey is available from firmware version 1.80.

→ Remote: CALC:PSE:SUBR 10

Harmonic Distortion

Opens a submenu to determine the settings for harmonics measurement and activates the harmonic distortion measurement. With this measurement it is possible to measure easily the harmonics e.g. from a VCO. In addition the THD (total harmonic distortion) is calculated in % and dB.

With span > 0 Hz, an automatic search for the first harmonic is carried out within the set frequency range. Also the level is adjusted. In zero span, the center frequency is unchanged.

In the upper pane, the zero span sweeps on all harmonics are shown, separated by display lines. This provides a very good overview about the measurement. In the lower pane, the mean RMS results are displayed in numerical values. The THD values are displayed in the marker field.

This softkey is available from firmware version 1.10.

→ Remote: CALC:MARK:FUNC:HARM:STAT ON
→ Remote: CALC:MARK:FUNC:HARM:DIST? TOT
→ Remote: CALC:MARK:FUNC:HARM:LIST?

Harmonic On/Off

Activates/deactivates the harmonic distortion measurement.

This softkey is available from firmware version 1.10.

→ Remote: CALC:MARK:FUNC:HARM:STAT ON

No. of Harmonics

Sets the number of harmonics that shall be measured. The range is from 1 to 26.

This softkey is available from firmware version 1.10.

→ Remote: CALC:MARK:FUNC:HARM:NHAR 2

Harmonic Sweep Time

For details refer to the **Sweeptime Manual** softkey in the bandwidth menu.

This softkey is available from firmware version 1.10.

Harmonic RBW Auto

Enables/disables the automatic adjustment of the resolution bandwidth. The automatic adjustment is carried out according to:

$$RBW_n = RBW_1 * n$$

If RBW_n is not available, the next higher value is used.

This softkey is available from firmware version 1.10.

→ Remote: `CALC:MARK:FUNC:HARM:BAND:AUTO OFF`

Adjust Settings

Activates the frequency search in the frequency range that was set before starting the harmonic measurement (if harmonic measurement was with span > 0) and adjusts the level.

This softkey is available from firmware version 1.10.

→ Remote: `CALC:MARK:FUNC:HARM:PRES`

Full Size Diagram (span > 0)

Displays the diagram in full screen size.

→ Remote: `DISP:SIZE LARG|SMAL`

Using Limit Lines and Display Lines - LINES Key

The **LINES** key is used to configure limit and display lines.

To open the lines menu

- Press the **LINES** key.

The lines menu and the **Select Limit Line** dialog box are displayed. For details on the **Select Limit Line** dialog box refer to "[To select a limit line](#)" on page 4.112.

Menu and softkey description

- "[Softkeys of the lines menu](#)" on page 4.116

To display help to a softkey, press the **HELP** key and then the softkey for which you want to display help. To close the help window, press the **ESC** key. For further information refer to section "How to use the Help System".

Further information

- "[Display Lines](#)" on page 4.115
- "[Limit Lines](#)" on page 4.115

Task

- [To work with display lines](#)
- [To select a limit line](#)
- [To create a new limit line](#)
- [To edit an existing limit line](#)
- [To create a new limit line based upon an existing limit line](#)
- [To activate/deactivate a limit line](#)

To work with display lines

Initial situation: The line is switched on (softkey with highlighted background) or off (softkey without highlighted background), for example the Display Line 1.

1. Press the **Display Lines** softkey.
2. Press the **Display Line 1** softkey for the first time.
An edit dialog box is opened to enter the position of the display line (by rotary knob, step keys or numerical entry). If the line was switched off, it is switched on. If it was switched on, it remains switched on.
3. If another softkey is pressed, the edit dialog box for the **Display Line 1** softkey is closed, but the line remains switched on (softkey with highlighted background).
4. Press the **Display Line 1** softkey for the second time.
The edit dialog box for the display line will be opened again.
5. Press the **Display Line 1** softkey again.
The line is switched off (softkey without highlighted background).

To select a limit line

1. To display the **Select Limit Line** dialog box, press the **LINES** key or go to the main limit line menu.

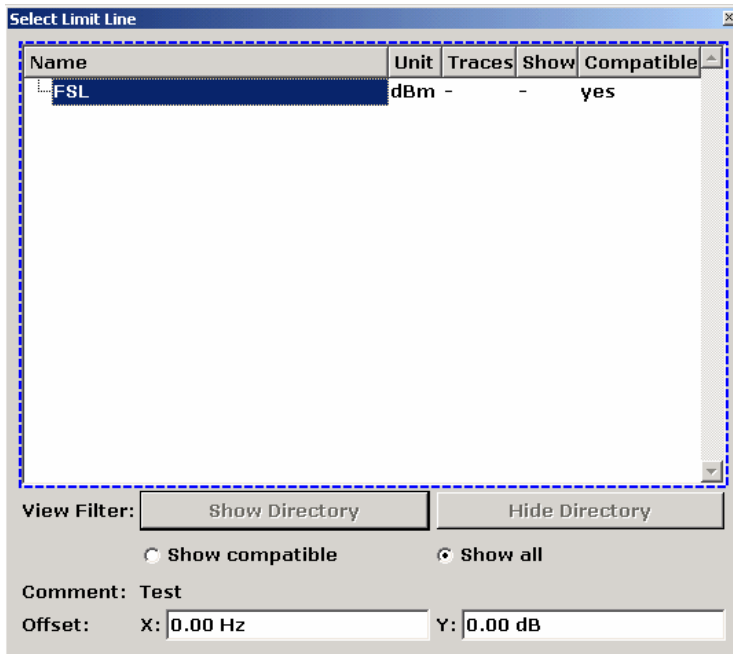

All limit lines, saved in the default directory, and all subdirectories are displayed. For each limit line, the following information is given:

- Unit** unit of the y-axis
- Traces** selected traces to check
- Show** limit line displayed in the measurement diagram or hidden
- Compatible** compatibility of the limit line to the current measurement settings

2. To display only the limit lines that are compatible, activate the **Show compatible** option. For details on compatibility refer to "Limit Lines" on page 4.115.
3. To navigate into a subdirectory, use the **Show Directory** and **Hide Directory** buttons.

To create a new limit line

1. Press the **New** softkey to define a new limit line.

The **Edit Limit Line** dialog box is displayed. For more details on limit lines refer also to "Limit Lines" on page 4.115.

2. Press the **Edit Name** softkey and enter a name, if you want to save the limit line in the main directory. To save the limit line in an existing subdirectory, enter the relative path. A new subdirectory can only be created using the **FILE** key (for details refer to section "Instrument Functions - Basic Settings", "Saving and Recalling Settings Files - FILE Key").
3. To change the span setting, set the focus in the **X-Axis** field and change the unit via the rotary knob: **Hz** for span > 0 Hz or **s** for zero span.
4. To change between absolute and relative scale mode for the x-axis, set the focus on the **abs** or **rel** option next to the **X-Axis** field and press the **CHECKMARK** key. Relative scaling is always suitable, if masks for bursts are to be defined in zero span, or if masks for modulated signals are required for span > 0 Hz.

absolute: The frequencies or times are interpreted as absolute physical units.

relative: In the data point table, the frequencies are referred to the currently set center frequency. In the zero span mode, the left boundary of the diagram constitutes the reference.

5. To change the scaling of the y-axis, set the focus in the **Y-Axis** field and change the unit using the rotary knob.
6. To change between absolute and relative units for the y-axis, set the focus on the **abs** or **rel** option next to the **Y-Axis** field and press the **CHECKMARK** key.

absolute: The limit values refer to absolute levels or voltages.

relative: The limit values refer to the reference level (Ref Level). Limit values with the unit dB are always relative values.

7. To define the limit line as upper or lower limit line, set the focus on the **Upper** or **Lower** option and press the **CHECKMARK** key.
8. To change between linear or logarithmic scale of the x-axis, set the focus on the **lin** or **log** option and press the **CHECKMARK** key.
9. If the scaling of the y-axis is relative, you can define an absolute threshold value that works as a lower limit for the relative limit values (see figure below). Set the focus in the **Threshold** field and enter a value.

The function is especially useful for mobile radio applications provided the limit values are defined in relation to the carrier power as long as they are above an absolute limit value.

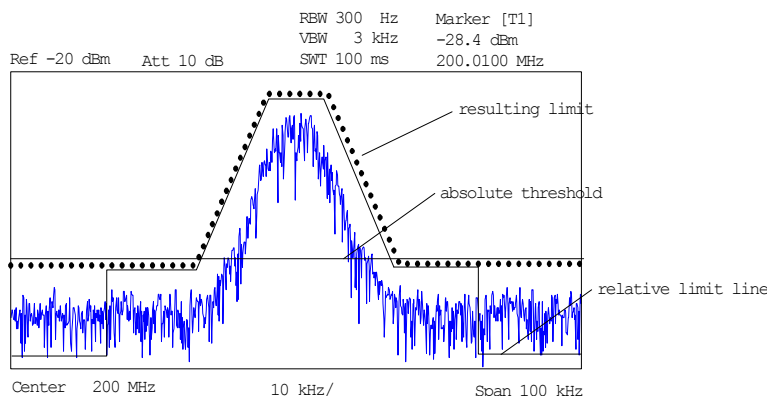

10. To define a signal-level distance to the limit line, press the **Edit Margin** softkey and enter a value. If the limit line is defined as an upper limit, the margin means that the level is below the limit line. If the limit line is defined as a lower limit, the margin means that the level is above the limit line.
11. To enter a comment, press the **Edit Comment** and enter a comment, e.g. a description of the application.
12. To enter a new data point:
 - Press the **Insert Value Above** softkey.
 - Enter the new x and y value in the successive displayed edit dialog boxes.
13. To change a data point:
 - Set the focus on the x and y value to be changed and press the **Value** softkey.
 - Enter the new x or y value in the displayed edit dialog box.
14. To delete a data point, select the corresponding entry and press the **Delete Value** softkey.

15. To shift the complete limit line parallel in the horizontal direction, select the **Shift x** button and enter a x shift value.
16. To shift the complete limit line parallel in the vertical direction, select the **Shift y** button and enter an y shift value.
17. Press the **Save Limit Line** softkey.

If an existing name is used, a message box is displayed. You have to confirm before the limit line is overwritten.

To edit an existing limit line

1. In the **Select Limit Line** dialog box, select the limit line you want to alter. For details see also "[To select a limit line](#)" on page 4.112.
2. Press the **Edit** softkey.
3. Edit the data as described in "[To select a limit line](#)" on page 4.112.
4. Save the limit line (**Save Limit Line** softkey).

To create a new limit line based upon an existing limit line

1. In the **Select Limit Line** dialog box, select the limit line you want to use as a basis for a new limit line. For details see also "[To select a limit line](#)" on page 4.112.
2. Press the **Copy to** softkey to transfer the data of the limit line into the **Edit Limit Line** dialog box.
3. Press the **Edit Name** softkey and enter a new name.
4. To shift the complete limit line parallel in the horizontal direction, select the **Shift x** button and enter an x shift value. In this manner, a new limit line can be easily generated based upon an existing limit line which has been shifted horizontally.
5. To shift the complete limit line parallel in the vertical direction, select the **Shift y** button and enter a y shift value. In this manner, a new limit line can be easily generated based upon an existing limit line which has been shifted in Y direction
6. If required, edit the data as described in "[To select a limit line](#)" on page 4.112.
7. Save the limit line (**Save Limit Line** softkey).

To activate/deactivate a limit line

Prerequisites:

- The x- and y-units of limit line and current measurement setting have to be compatible. For details refer to "[Limit Lines](#)" on page 4.115.
 - The limit line has to consist of 2 or more data points.
1. In the **Select Limit Line** dialog box, select the limit line you want to activate/deactivate. For details see also "[To select a limit line](#)" on page 4.112.
 2. To activate or deactivate a limit line for a trace, press the **Select Traces to check** softkey and select or deselect the trace(s) to which this limit line applies.
 3. To deactivate the limit line for all traces, press the **Deselect All** softkey.

Display Lines

Display lines help to evaluate a trace - as do markers. The function of a display line is comparable to that of a ruler that can be shifted on the trace in order to mark absolute values. They are exclusively used to optically mark relevant frequencies or points in time (span = 0) as well as constant level values. It is not possible to check automatically whether the points are below or above the marked level values.

The softkeys for setting and switching the display lines on/off work like triple switches. For details see "[To work with display lines](#)" on page 4.111.

Two different types of display lines are provided:

- Two horizontal level lines for marking levels - Display Line 1 and 2
The level lines are continuous horizontal lines across the entire width of a diagram and can be shifted in y direction.
- Two vertical frequency or time lines for marking frequencies or points in time - Frequency/Time Line 1 and 2
The frequency or time lines are continuous vertical lines across the entire height of the diagram and can be shifted in x direction.

Each line is identified by one of the following abbreviations:

- D1: Display Line 1
- D2: Display Line 2
- F1: Frequency Line 1
- F2: Frequency Line 2
- T1: Time Line 1
- T2: Time Line 2

Limit Lines

Limit lines are used to define amplitude curves or spectral distribution boundaries on the display screen which are not to be exceeded. They indicate, for example, the upper limits for interference radiation or spurious waves which are allowed from a device under test (DUT). For transmission of information in TDMA systems (e.g. GSM), the amplitude of the bursts in a timeslot must adhere to a curve that falls within a specified tolerance band. The lower and upper limits may each be specified by a limit line. Then, the amplitude curve can be controlled either visually or automatically for any violations of the upper or lower limits (GO/NOGO test).

The instrument supports limit lines with a maximum of 50 data points. 8 of the limit lines stored in the instrument can be activated simultaneously. The number of limit lines stored in the instrument is only limited by the capacity of the flash disk used. For details see also "[To select a limit line](#)" on page 4.112.

Limit lines are compatible with the current measurement settings, if the following applies:

- The x unit of the limit line has to be identical to the current setting.
- The y unit of the limit line has to be identical to the current setting with the exception of dB based units; all dB based units are compatible with each other.

At the time of entry, the R&S FSL immediately checks that all limit lines are in accordance with the following guidelines:

- The frequencies/times for each data point must be entered in ascending order, however, for any single frequency/time, two data points may be entered (vertical segment of a limit line).

- The data points are allocated in order of ascending frequency/time. Gaps are not allowed. If gaps are desired, two separate limit lines must be defined and then both enabled.
- The entered frequencies/times need not necessarily be selectable in R&S FSL. A limit line may also exceed the specified frequency or time range. The minimum frequency for a data point is -200 GHz, the maximum frequency is 200 GHz. For the time range representation, negative times may also be entered. The allowed range is -1000 s to +1000 s.

Softkeys of the lines menu

The following table shows all softkeys available in the lines menu. It is possible that your instrument configuration does not provide all softkeys. If a softkey is only available with a special option, model or (measurement) mode, this information is delivered in the corresponding softkey description.

Menu / Command	Command
Select Traces to check	
Deselect All	
New ↓	Edit Name
	Edit Comment
	Edit Margin
	Value
	Insert Value Above
	Delete Value
	Save Limit Line
Edit ↓	same contents as New Limit Line menu
Copy to ↓	same contents as New Limit Line menu
Delete	
Display Lines ↓	Display Line 1
	Display Line 2
	Frequency Line 1
	Frequency Line 2
	Time Line 1
	Time Line 2

Select Traces to check

Opens the **Select Traces to Check** dialog box to activate the selected limit line for a trace. One limit line can be activated for several traces simultaneously. For details see also "[To activate/deactivate a limit line](#)" on page 4.114 .

This softkey is available from firmware version 1.10.

- Remote: CALC:LIM2:TRAC 3
- Remote: CALC:LIM:STAT ON

Deselect All

Deactivates the selected limit line for all assigned traces. For details see also "[To activate/deactivate a limit line](#)" on page 4.114 .

This softkey is available from firmware version 1.10.

→ Remote: `CALC:LIM:STAT OFF`

New

Opens the **Edit Limit Line** dialog box and a submenu to define a new limit line. For details see also "[Limit Lines](#)" on page 4.115 and "[To select a limit line](#)" on page 4.112.

This softkey is available from firmware version 1.10.

Edit Name

Sets the focus on the **Name** field to enter or change the limit line name. A maximum of 8 characters is permitted for each name. All names must be compatible with the Windows XP conventions for file names. The limit line data are stored under this name. The instrument stores all limit lines with LIM as extension.

This softkey is available from firmware version 1.10.

→ Remote: `CALC:LIM3:NAME "GSM1"`

Edit Comment

Sets the focus on the **Comment** field to enter or change a comment for the limit line. The text must not exceed 40 characters.

This softkey is available from firmware version 1.10.

→ Remote: `CALC:LIM5:COMM 'Upper limit for spectrum'`

Edit Margin

Sets the focus on the **Margin** field to enter or change a margin for the limit line. The default setting is 0 dB (i.e. no margin).

This softkey is available from firmware version 1.10.

Value

Opens an edit dialog box to change an existing x or y value, depending on the selected column. The softkey is only available if an existing value is selected.

The desired data points are entered in ascending order (two repeated frequencies/time values are permitted).

This softkey is available from firmware version 1.10.

→ Remote: `CALC:LIM3:CONT:DATA 1MHz, 3MHz, 30MHz`

→ Remote: `CALC:LIM3:UPP:DATA -10, 0, 0`

→ Remote: `CALC:LIM3:LOW:DATA -30, -40, -40`

Insert Value Above

Creates an empty line above the selected data point to enter a new data point. This softkey corresponds to the **Insert** button in the dialog box.

It is also possible to add a data point at the end of the list, if the focus is set below the last entry line of the list.

The data points are entered in ascending order (two repeated frequencies/time values are permitted). If the entered values are not in accordance with the ascending order rule, an error message is displayed and the values are discarded.

This softkey is available from firmware version 1.10.

Delete Value

Deletes the selected data point (x and y value). All succeeding data points are shifted up accordingly. This softkey corresponds to the **Delete** button in the dialog box.

The softkey is only available if an existing value is selected.

This softkey is available from firmware version 1.10.

Save Limit Line

Saves the currently edited limit line under the name defined in the **Name** field.

This softkey is available from firmware version 1.10.

Edit

Opens a submenu to edit limit lines. For details see also "[Limit Lines](#)" on page 4.115 and "[To edit an existing limit line](#)" on page 4.114.

This softkey is available from firmware version 1.10.

→ Remote: For details refer to chapter "Remote Control - Commands", section "Definition of the limit line".

Copy to

Copies the data of the selected limit line and displays it in the **Edit Limit Line** dialog box. If the limit line is edited and saved under a new name, a new limit line can be easily generated by parallel translation or editing of an existing limit line.

For details see also "[Limit Lines](#)" on page 4.115 and "[To create a new limit line based upon an existing limit line](#)" on page 4.114.

This softkey is available from firmware version 1.10.

→ Remote: CALC:LIM3:COPY 2

Delete

Deletes the selected limit line.

This softkey is available from firmware version 1.10.

→ Remote: CALC:LIM3:DEL

Display Lines

Opens a submenu to enable, disable and set display lines. Which softkeys are available depends on the display mode (frequency or time range). For details see also "[Display Lines](#)" on page 4.115 and "[To work with display lines](#)" on page 4.111.

Display Line 1 and Display Line 2

Enable or disable the level lines 1/2 and open an edit dialog box to enter the position of the lines. For details see also "[Display Lines](#)" on page 4.115 and "[To work with display lines](#)" on page 4.111.

- Remote: CALC:DLIN:STAT ON
 - Remote: CALC:DLIN -20dBm
-

Frequency Line 1 and Frequency Line 2 (span > 0)

Enable or disable the frequency lines 1/2 and open an edit dialog box to enter the position of the lines. For details see also "[Display Lines](#)" on page 4.115 and "[To work with display lines](#)" on page 4.111.

- Remote: CALC:FLIN:STAT ON
 - Remote: CALC:FLIN 120MHz
-

Time Line 1 and Time Line 2 (zero span)

Enable or disable the time lines 1/2 and open an edit dialog box to enter the position of the lines. For details see also "[Display Lines](#)" on page 4.115 and "[To work with display lines](#)" on page 4.111.

- Remote: CALC:TLIN:STAT ON
 - Remote: CALC:TLIN 10ms
-

Measurement Modes

This section describes the provided measurement modes, the change of measurement modes and the access to the menus of all active measurement modes. For details refer to the following sections:

- ["Measurement Mode Selection - MODE Key"](#) on page 4.120
- ["Measurement Mode Menus - MENU Key"](#) on page 4.122

Measurement Mode Selection - MODE Key

The **MODE** key provides a quick access to the menu of the current measurement mode and a fast change of the measurement mode. You can choose from the following measurement modes:

- [Spectrum Analyzer mode](#)
- [Analog Demodulation mode \(Analog Demodulation option, K7\)](#)
- [Bluetooth mode \(Bluetooth Measurements option, K8\)](#)
- [Cable TV Analyzer mode \(Cable TV Measurements option, K20\)](#)
- [Noise mode \(Noise Figure Measurements option, K30\)](#)
- [3G FDD BTS mode \(3GPP Base Station Measurements option, K72\)](#)
- [CDMA2000 BTS Analyzer mode \(CDMA2000 Base Station Measurements option, K82\)](#)
- [1xEV-DO BTS Analyzer mode \(1xEV-DO Base Station Measurements option, K84\)](#)
- [WLAN mode \(WLAN TX Measurements option, K91/K91n\)](#)
- [WiMAX mode \(WiMAX IEEE 802.16 OFDM, OFDMA Measurements option, K92/K93\)](#)

To change the measurement mode

1. Press the **MODE** key.
The menu of the current measurement mode is displayed and the **Measurement Modes** dialog box is opened.
2. To activate another mode, select the corresponding option and press the **CHECKMARK** key. More than one measurement mode can be activated simultaneously.
3. To deactivate an activated mode, select the corresponding option and press the **CHECKMARK** key.

Spectrum Analyzer mode

In the **Spectrum Analyzer** mode the functions provided correspond to those of a conventional spectrum analyzer. The analyzer measures the frequency spectrum of the test signal over the selected frequency range with the selected resolution and sweep time, or, for a fixed frequency, displays the waveform of the video signal. This mode is set in the initial configuration.

Analog Demodulation mode (Analog Demodulation option, K7)

The **Analog Demodulation** mode requires an instrument equipped with the corresponding optional software. This mode provides measurement functions for demodulating AM, FM, or PM signals. For details refer to ["Analog Demodulation \(Option K7\)"](#) on page 4.131.

Bluetooth mode (Bluetooth Measurements option, K8)

The **Bluetooth** mode requires an instrument equipped with the corresponding optional software. This mode provides measurements to test the conformity of signal sources to the Bluetooth RF Test Specifications. For details refer to "[Bluetooth Measurements \(Option K8\)](#)" on page 4.149.

Cable TV Analyzer mode (Cable TV Measurements option, K20)

The **Cable TV Analyzer** mode requires an instrument equipped with the corresponding optional software. This mode provides ready-made measurements for analog and digital TV signals where most of the parameters are set automatically. For details refer to "[Cable TV Measurements \(Option K20\)](#)" on page 4.192.

Noise mode (Noise Figure Measurements option, K30)

The **Noise** mode requires an instrument equipped with the corresponding optional software. This mode provides accurate and flexible noise measurement functions. For details refer to "[Noise Figure Measurements Option \(K30\)](#)" on page 4.235.

3G FDD BTS mode (3GPP Base Station Measurements option, K72)

The **3G FDD BTS** mode requires an instrument equipped with the corresponding optional software. This mode provides test measurements for WCDMA downlink signals (base station signals) according to the test specification. For details refer to "[3GPP Base Station Measurements \(Option K72\)](#)" on page 4.258.

CDMA2000 BTS Analyzer mode (CDMA2000 Base Station Measurements option, K82)

The **CDMA2000 BTS Analyzer** mode requires an instrument equipped with the corresponding optional software. This mode provides test measurements on forward link signals (base station) according to the 3GPP2 Standard (Third Generation Partnership Project 2). For details refer to "[CDMA2000 BTS Analyzer \(Option K82\)](#)" on page 4.282.

1xEV-DO BTS Analyzer mode (1xEV-DO Base Station Measurements option, K84)

The **1xEV-DO BTS Analyzer** mode requires an instrument equipped with the corresponding optional software. This mode provides test measurements on forward link signals (base station) according to the 3GPP2 Standard (Third Generation Partnership Project 2). For details refer to "[1xEV-DO BTS Analyzer \(Option K84\)](#)" on page 4.340.

WLAN mode (WLAN TX Measurements option, K91/K91n)

The **WLAN** mode requires an instrument equipped with the corresponding optional software. This mode provides Wireless LAN TX measurement functions according to IEEE 802.11 a, b, g, j and n standards. For details refer to "[WLAN TX Measurements \(Option K91 / K91n\)](#)" on page 4.391.

WiMAX mode (WiMAX IEEE 802.16 OFDM, OFDMA Measurements option, K92/K93)

The **WiMAX** mode requires an instrument equipped with the WiMAX IEEE 802.16 OFDM, OFDMA Measurements option (R&S FSL-K93). This mode provides WiMAX and WiBro measurement functions according to IEEE standards 802.16-2004 OFDM and 802.16e-2005 OFDMA/WiBro. It includes the WiMAX 802.16 OFDM Measurements option (R&S FSL-K92). For details refer to "[WiMAX, WiBro Measurements \(Options K92/K93\)](#)" on page 4.423.

Measurement Mode Menus - MENU Key

The **MENU** key provides a quick access to the menu of the current measurement mode. For details on measurement modes refer to "[Measurement Mode Selection - MODE Key](#)" on page 4.120.

To access the main menu of an active measurement mode

- Press the **MENU** key.

The menu of the current measurement mode is displayed.

If the tracking generator, the power meter, and the spectrogram are available in the current measurement mode, softkeys for these functions are also provided. In the **Spectrum Analyzer** mode with active acoustic monitoring, the softkey **Marker Demod Volume** to control the volume control for acoustic monitoring is displayed.

Menu and softkey description

- "[Optional softkeys of the menu menu](#)" on page 4.122

To display help to a softkey, press the **HELP** key and then the softkey for which you want to display help. To close the help window, press the **ESC** key. For further information refer to section "How to use the Help System".

Optional softkeys of the menu menu

Apart from the softkeys of the current measurement mode, the following optional softkeys are available in the menu menu. It is possible that the basic unit does not provide all these softkeys. If a softkey is only available with a special option, model or (measurement) mode, this information is delivered in the corresponding softkey description.

Menu / Command
Tracking Generator
Power Meter
Spectrogram
Marker Demod Volume

Tracking Generator (models 13, 16 and 28)

Displays the menu of the **Tracking Generator** measurement mode. For details refer to "[Tracking Generator \(Models 13, 16 and 28\)](#)" on page 4.125.

Power Meter (Power Sensor Support option, K9)

Displays the menu of the **Power Meter** measurement mode. For details refer to "[Power Meter \(Option K9\)](#)" on page 4.176.

Spectrogram (Spectrogram Measurement option, K14)

Displays the menu of the Spectrogram Measurement option. For details refer to "[Spectrogram Measurement \(Option K14\)](#)" on page 4.181.

Marker Demod Volume (Spectrum Analyzer mode)

Opens a dialog box to regulate the volume for acoustic monitoring.

Models and Options

This section describes models and firmware options that are not included in the basic unit configuration. If hardware options are controlled via the firmware, the provided softkeys are described in the corresponding menu section. The information, with which special option or model these softkeys are supplied, is delivered in the corresponding softkey description.

A list of all available hardware and firmware options is provided on CD-ROM. To check the options your instrument provides, refer to the Quick Start Guide, chapter 2 "Preparing for Use". For details on models and firmware options refer to the following sections:

- ["Tracking Generator \(Models 13, 16 and 28\)"](#) on page 4.125
- ["Analog Demodulation \(Option K7\)"](#) on page 4.131
- ["Bluetooth Measurements \(Option K8\)"](#) on page 4.149
- ["Power Meter \(Option K9\)"](#) on page 4.176
- ["Spectrogram Measurement \(Option K14\)"](#) on page 4.181
- ["Cable TV Measurements \(Option K20\)"](#) on page 4.192
- ["Noise Figure Measurements Option \(K30\)"](#) on page 4.235
- ["3GPP Base Station Measurements \(Option K72\)"](#) on page 4.258
- ["CDMA2000 BTS Analyzer \(Option K82\)"](#) on page 4.282
- ["1xEV-DO BTS Analyzer \(Option K84\)"](#) on page 4.340
- ["WLAN TX Measurements \(Option K91 / K91n\)"](#) on page 4.391
- ["WiMAX, WiBro Measurements \(Options K92/K93\)"](#) on page 4.423

Tracking Generator (Models 13, 16 and 28)

During operation the tracking generator emits a signal exactly at the input frequency of the R&S FSL.

The tracking generator can be used in all measurement modes. Acquisition of test setup calibration values (see **Source Cal** softkey) and normalization using these correction values (see **Normalize** softkey) is only possible in the tracking generator measurement mode. For details on measurement modes refer to "[Measurement Mode Selection - MODE Key](#)" on page 4.120.

FFT filters (for details see "[To choose the appropriate filter type](#)" on page 4.17) are not available if the tracking generator is active.

For measurements with running tracking generator it is recommended to set the start frequency to 3 x resolution bandwidth in order to meet the data sheet accuracy.



The RF characteristics of some DUTs are especially sensitive concerning the input VSWR. In such cases insertion of 10-20 dB attenuation between the DUT and the tracking generator output is recommended.

To open the tracking generator menu

1. Press the **MENU** key.
2. Press the **Tracking Generator** softkey.
The tracking generator menu is displayed.

Menu and softkey description

- "[Softkeys of the tracking generator menu](#)" on page 4.127

To display help to a softkey, press the **HELP** key and then the softkey for which you want to display help. To close the help window, press the **ESC** key. For further information refer to section "How to use the Help System".

Further information

- "[Transmission measurement](#)" on page 4.126
- "[Reflection measurement](#)" on page 4.126
- "[Calibration mechanism](#)" on page 4.126

Tasks

- [To calibrate for transmission and reflection measurement](#)

To calibrate for transmission and reflection measurement

Prerequisite: The instrument is in tracking generator measurement mode (for details refer to "[Measurement Mode Selection - MODE Key](#)" on page 4.120).

1. Press the **Source Power** softkey to enter the generator output level.
If the tracking generator is off, it is switched on.

2. To enter a constant level offset for the tracking generator, press the **Power Offset** softkey.
3. Press the **Source Cal** softkey to open the submenu for calibration.
4. To record a reference trace for transmission measurement, press the **Cal Trans** softkey.
The recording of the reference trace and the completion of the calibration sweep are indicated by message boxes.
5. To record a reference trace for reflection measurement, press the **Cal Refl Short** or **Cal Refl Open** softkey.
The recording of the reference trace and the completion of the calibration sweep are indicated by message boxes.
6. Press the **Normalize** softkey to switch on the normalization.
7. Press the **Ref Value Position** softkey to display the reference line.
8. Press the **Ref Value** softkey to enter a value to shift the reference line.
9. Press the **Recall** softkey to restore the settings used for source calibration.

Transmission measurement

This measurement will yield the transmission characteristics of a two-port network. The built-in tracking generator serves as a signal source. It is connected to the input connector of the DUT. The input of the R&S FSL is fed from the output of the DUT. A calibration can be carried out to compensate for the effects of the test setup (e.g. frequency response of connecting cables).

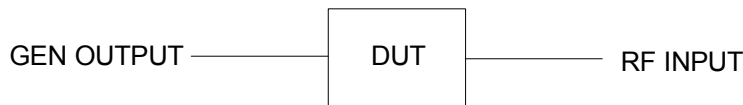

Fig. 4-8: Test setup for transmission measurement

Reflection measurement

Scalar reflection measurements can be carried out by means of a reflection-coefficient measurement bridge.

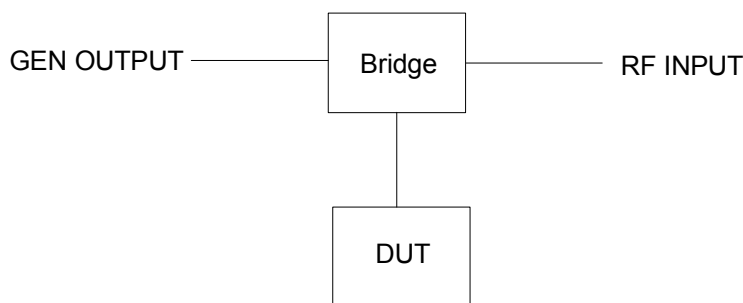

Fig. 4-9: Test setup for reflection measurement

Calibration mechanism

Calibration means a calculation of the difference between the currently measured power and a reference curve, independent of the selected type of measurement (transmission/reflection). The hardware settings used for measuring the reference curve are included in the reference dataset.

Even with normalization switched on, the device settings can be changed in a wide area without stopping the normalization. This reduces the necessity to carry out a new normalization to a minimum.

For this purpose the reference dataset (trace with 501 measured values) is stored internally as a table of 501 points (frequency/level).

Differences in level settings between the reference curve and the current device settings are taken into account automatically. If the span is reduced, a linear interpolation of the intermediate values is applied. If the span increases, the values at the left or right border of the reference dataset are extrapolated to the current start or stop frequency, i.e. the reference dataset is extended by constant values.

An enhancement label is used to mark the different levels of measurement accuracy. This enhancement label is displayed at the right diagram border if normalization is switched on and a deviation from the reference setting occurs. Three accuracy levels are defined:

Table 4-8: Measurement accuracy levels

Accuracy	Enhancement label	Reason/Limitation
high	NOR	no difference between reference setting and measurement
medium	APX (approximation)	change of the following settings: coupling (RBW, VBW, SWT) reference level, RF attenuation start or stop frequency output level of tracking generator detector (max. peak, min. peak, sample, etc.) change of frequency: max. 501 points within the set sweep limits (corresponds to a doubling of the span)
-	Aborted normalization	more than 500 extrapolated points within the current sweep limits (in case of span doubling)



At a reference level of -10 dBm and at a tracking generator output level of the same value the R&S FSL operates without overrange reserve, i.e. the R&S FSL is in danger of being overloaded if a signal is applied whose amplitude is higher than the reference line. In this case, either the message **OVLD** for overload or **IFOVL** for exceeded display range (clipping of the trace at the upper diagram border = overrange) is displayed in the status line.

Overloading can be avoided as follows:

- Reducing the output level of the tracking generator (**Source Power** softkey in the tracking generator menu)
- Increasing the reference level (**Ref Level** softkey in the amplitude menu)

Softkeys of the tracking generator menu

The following table shows all softkeys available in the tracking generator menu. It is possible that your instrument configuration does not provide all softkeys. If a softkey is only available with a special option, model or (measurement) mode, this information is delivered in the corresponding softkey description.

For the description of the other main softkeys refer to "[Optional softkeys of the menu menu](#)" on page 4.122.

Menu / Command	Command
Source On/Off	
Source Power	
Power Offset	
Source Cal ↓	Cal Trans
	Cal Refl Short
	Cal Refl Open
	Normalize
	Ref Value Position
	Ref Value
	Recall

Source On/Off

Switches the tracking generator on or off. Default setting is off.

If the tracking generator is switched off, the corresponding hardware settings and the normalization are discarded. To switch off the tracking generator but keep the hardware settings and the normalization, enter -400 dBm into the edit dialog box displayed by pressing the **Source Power** softkey.

→ Remote: `OUTP:STAT ON`

Source Power

Opens an edit dialog box to enter a tracking generator output power. The default output power is -20 dBm for the R&S FSL3/6 and -30 dBm for the R&S FSL18. For the R&S FSL3/6, the minimum output level depends on which frontend is built in the instrument. You can check the type of frontend in your R&S FSL via the **Hardware Info** dialog in the Setup menu.

Frontend Variant	Min. Tracking Generator Output Level
1300.3009.03	-20 dBm
1300.3609.04	-20 dBm
1300.3609.06	-50 dBm

For the R&S FSL18, the minimum output level is always -30 dBm.

The range is also specified in the data sheet.

Additionally, the value -400 dBm is available to switch off the tracking generator but keep the hardware settings.

If the tracking generator is off, it is automatically switched on if an output power value is entered. For details on switching on or off refer to the **Source On/Off** softkey.

→ Remote: `SOUR:POW -20dBm`

Power Offset

Opens an edit dialog box to enter a constant level offset for the tracking generator. Values from -200 dB to +200 dB in 1 dB steps are allowed. The default setting is 0 dB. Offsets are indicated by the enhancement label **LVL**.

With this offset for example attenuators or amplifiers at the output connector of the tracking generator can be taken into account for the displayed output power values on screen or during data entry. Positive offsets apply to an amplifier and negative offsets to an attenuator subsequent to the tracking generator.

→ Remote: SOUR:POW:OFFS -10dB

Source Cal

Opens a submenu to configure calibration for transmission and reflection measurement. For details on the test setups see "[Transmission measurement](#)" on page 4.126 and "[Reflection measurement](#)" on page 4.126.

Cal Trans

Starts a sweep that records a reference trace. This trace is used to calculate the difference for the normalized values.

→ Remote: CORR:METH TRAN

Cal Refl Short

Starts a sweep as reference trace for short-circuit calibration.

If both calibrations (open circuit, short circuit) are carried out, the calibration curve is calculated by averaging the two measurements and stored in the memory. The order of the two calibration measurements is free.

→ Remote: CORR:METH REFL

Cal Refl Open

Starts a sweep as reference trace the open-circuit calibration.

If both calibrations (open circuit, short circuit) are carried out, the calibration curve is calculated by averaging the two measurements and stored in the memory. The order of the two calibration measurements is free.

→ Remote: CORR:COLL OPEN

Normalize

Switches the normalization on or off. The softkey is only available if the memory contains a reference trace. For details on normalization see "[Calibration mechanism](#)" on page 4.126.

→ Remote: CORR ON

Ref Value Position

Switches the reference line on or off. The reference line marks the reference position at which the normalization result (calculated difference with a reference trace) is displayed. For details on the reference line see "[Calibration mechanism](#)" on page 4.126.

→ Remote: `DISP:WIND:TRAC:Y:RPOS 10PCT`

Ref Value

Opens an edit dialog box to enter a position value that shifts the reference line vertically. By default the reference line corresponds to a difference of 0 dB between the currently measured trace and the reference trace.

If, e.g. after a source calibration, a 10 dB attenuation is inserted into the signal path between DUT and R&S FSL input, the measurement trace will be moved by 10 dB down. Entering a reference value of -10 dB will shift the reference line also by 10 dB down and place the measurement trace on the reference line. The deviation from the nominal power level can be displayed with higher resolution (e.g. 1 dB/div). The power is still displayed in absolute values.

→ Remote: `DISP:WIND:TRAC:Y:RVAL -10dB`

Recall

Restores the settings that were used during source calibration. This can be useful if device settings were changed after calibration (e.g. center frequency, frequency deviation, reference level, etc).

→ Remote: `CORR:REC`

Analog Demodulation (Option K7)

The digital signal processing in the R&S FSL, used in the analyzer mode for digital IF filters, is also ideally suited for demodulating AM, FM, or PM signals. The firmware option R&S FSL-K7 provides the necessary measurement functions.

The R&S FSL is equipped with a demodulator that is capable of performing AM, FM, and PM demodulation at a time. Additionally maximum, minimum and average or current values can be obtained parallelly over a selected number of measurements.

By sampling (digitization) already at the IF and digital down-conversion to the baseband (I/Q), the demodulator achieves maximum accuracy and temperature stability. There is no evidence of typical errors of an analog down-conversion and demodulation like AM to FM conversion and vice versa, deviation error, frequency response or frequency drift at DC coupling.

This option is available from firmware version 1.10.

To open the analog demodulation menu

- If the **Analog Demodulation** mode is not the active measurement mode, press the **MODE** key and activate the **Analog Demodulation** option.
- If the **Analog Demodulation** mode is already active, press the **MENU** key.

The analog demodulation menu is displayed. If the tracking generator (models 13, 16 and 28) or the power meter (option Power Sensor Support, K9) is available, softkeys for these functions are also provided.

Menu and softkey description

- ["Softkeys of the analog demodulation menu"](#) on page 4.134
- ["Softkeys of the frequency menu \(Analog Demodulation mode\)"](#) on page 4.141
- ["Softkeys of the span menu \(Analog Demodulation mode\)"](#) on page 4.142
- ["Softkeys of the amplitude menu \(Analog Demodulation mode\)"](#) on page 4.143
- ["Softkeys of the bandwidth menu \(Analog Demodulation mode\)"](#) on page 4.145
- ["Softkeys of the sweep menu \(Analog Demodulation mode\)"](#) on page 4.146
- ["Softkeys of the trigger menu \(Analog Demodulation mode\)"](#) on page 4.147

Apart from the power measurement menu that is not available in the **Analog Demodulation** mode, all other menus are provided as described for the base unit. For details refer to the corresponding menu descriptions.

To display help to a softkey, press the **HELP** key and then the softkey for which you want to display help. To close the help window, press the **ESC** key. For further information refer to section "How to use the Help System".

Further information

- ["Circuit description - block diagrams"](#) on page 4.132
- ["Demodulation bandwidth"](#) on page 4.133
- ["AF trigger"](#) on page 4.133
- ["Stability of measurement results"](#) on page 4.133
- ["Sample rate, measurement time and trigger offset"](#) on page 4.133

Circuit description - block diagrams

The software demodulator runs on the main processor of the analyzer. The demodulation process is shown in Fig. 4-10: Block diagram of software demodulator. All calculations are performed simultaneously with the same I/Q data set. Magnitude (= amplitude) and phase of the complex I/Q pairs are determined. The frequency result is obtained from the differential phase.

For details on the analyzer signal processing refer to chapter "Remote Control - Commands", section "TRACE:IQ Subsystem".

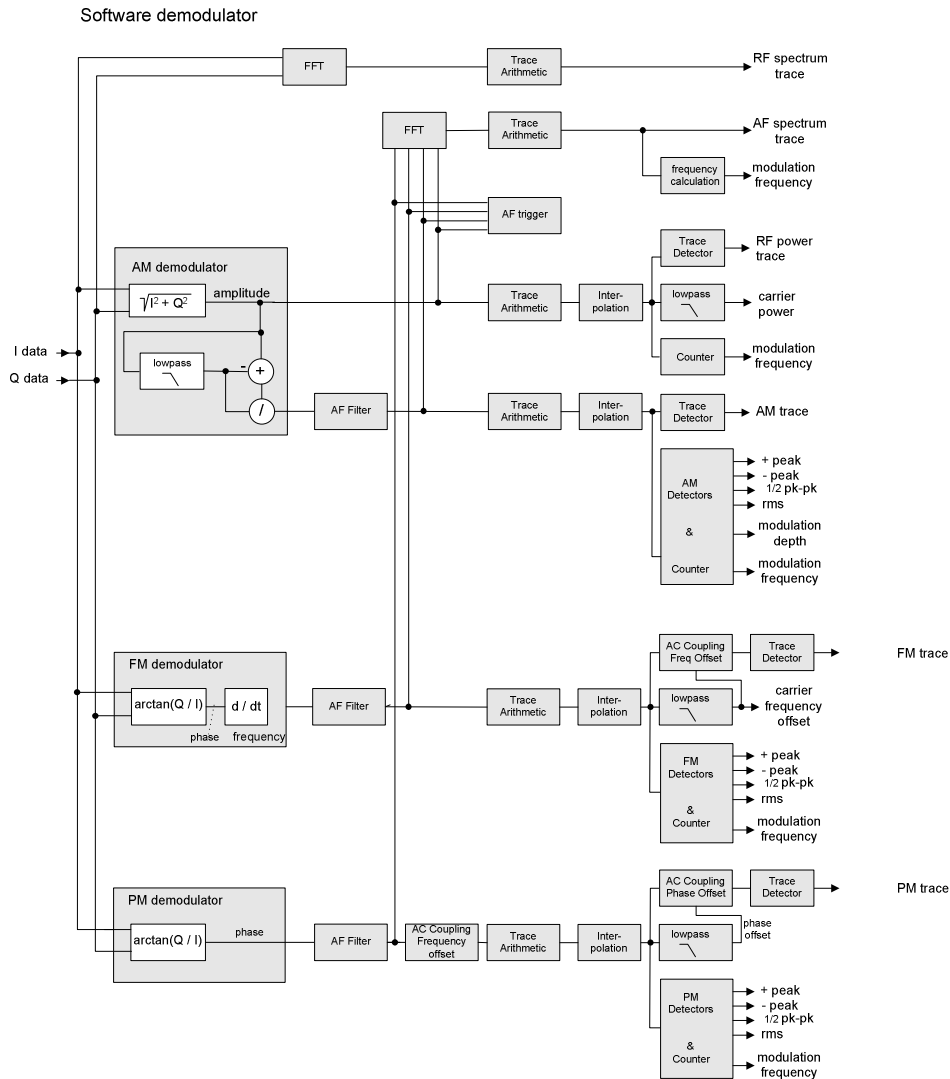

Fig. 4-10: Block diagram of software demodulator

The AM DC, FM DC and PM DC raw data of the demodulators is fed into the *Trace Arithmetic* block that combines consecutive data sets. Possible trace modes are: Clear Write, Max Hold, Min Hold and Average (for details refer to section "Trace mode overview" on page 4.36). The output data of the *Trace Arithmetic* block can be read via remote control.

The collected measured values are evaluated by the selected detector (for details refer to chapter "Instrument Functions", section "Detector overview". The result is displayed on the screen and can be read out via remote control.

In addition, important parameters are calculated:

- A counter determines the modulation frequency for AM, FM, and PM.

- average power = carrier power (RF power)
- average frequency = carrier frequency offset (FM)
- The modulation depth or the frequency or phase deviation is displayed.
- AC coupling is possible with FM and PM display. The deviations are determined from the trace data. +Peak, -Peak, ½ Peak-Peak and RMS are displayed.

Demodulation bandwidth

The demodulation bandwidth is not the 3 dB bandwidth but the useful bandwidth which is distortion-free with regard to phase and amplitude.

Therefore the following formulas apply:

- AM: demodulation bandwidth $\geq 2 \times$ modulation frequency
- FM: demodulation bandwidth $\geq 2 \times$ (frequency deviation + modulation frequency)
- PM: demodulation bandwidth $\geq 2 \times$ modulation frequency $\times (1 + \text{phase deviation})$



If the center frequency of the analyzer is not set exactly to the signal frequency, the demodulation bandwidth must be selected larger by the carrier offset, in addition to the requirement described above. This also applies if FM or PM AC coupling has been selected.

In general, the demodulation bandwidth should be as narrow as possible to improve the S/N ratio. The residual FM caused by noise floor and phase noise increases dramatically with the bandwidth, especially with FM.

AF trigger

The analog demodulation option allows triggering to the demodulated signal. The display is stable if a minimum of five modulation periods are within the recording time.

Triggering is always DC-coupled. Therefore triggering is possible directly to the point where a specific carrier level, phase or frequency is exceeded or not attained.

Stability of measurement results

Despite amplitude and frequency modulation, the display of carrier power and carrier frequency offset is stable.

This is achieved by a digital filter which sufficiently suppresses the modulation, provided, however, that the measurement time is $\geq 3 \times 1 / \text{modulation frequency}$, i.e. that at least three periods of the AF signal are recorded.

The mean carrier power for calculating the AM is also calculated with a digital filter that returns stable results after a measurement time of $\geq 3 \times 1 / \text{modulation frequency}$, i.e. at least three cycles of the AF signal must be recorded before a stable AM can be shown.

Sample rate, measurement time and trigger offset

Depending on the sample rate, the maximum demodulation bandwidths listed in the table can be obtained during the measurement. The permissible value range of the measurement time and trigger

offset depends on the selected demodulation bandwidth. If the AF filter or the AF trigger are not active, the measurement time enlarges by 20%.

Demod. bandwidth	Sample rate	Measurement time			Trigger offset	
		Min.	Max. with AF filter or AF trigger active	Max. with AF filter and AF trigger deactive	Min.	Max.
18 MHz	32 MHz	31.25 ns	12.5 ms	15 ms	-12.5 ms	507.9 ms
10 MHz	32 MHz	31.25 ns	12.5 ms	15 ms	-12.5 ms	507.9 ms
8 MHz	16 MHz	62.5 ns	25 ms	30 ms	-25 ms	1.015 s
5 MHz	8 MHz	125 ns	50 ms	60 ms	-50 ms	2.031 s
3 MHz	4 MHz	250 ns	100 ms	120 ms	-100 ms	4.063 s
1.6 MHz	2 MHz	500 ns	200 ms	240 ms	-200 ms	8.126 s
800 kHz	1 MHz	1 µs	400 ms	480 ms	-400 ms	16.25 s
400 kHz	500 kHz	2 µs	800 ms	960 ms	-800 ms	32.50 s
200 kHz	250 kHz	4 µs	1.6 s	1.92 s	-1.6 s	65.00 s
100 kHz	125 kHz	8 µs	3.2 s	3.84 s	-3.2 s	130.0 s
50 kHz	62.5 kHz	16 µs	6.4 s	7.68 s	-6.4 s	260.0 s
25 kHz	31.25 kHz	32 µs	12.8 s	15.36 s	-12.8 s	520.0 s
12.5 kHz	15.625 kHz	64 µs	25.6 s	30.72 s	-25.6 s	1040 s
6.4 kHz	7,8125 kHz	128 µs	51.2 s	61.44 s	-51.2 s	2080 s
3.2 kHz	3,90625 kHz	256 µs	102.4 s	122.88 s	-102.4 s	4160 s
1.6 kHz	1,953125 kHz	512 µs	204.8 s	245.76 s	-204.8 s	8321 s
800 Hz	976,5625 Hz	1.024 ms	409.6 s	491.52 s	-409.6 s	16643 s
400 Hz	488,28125 Hz	2.048 ms	819.2 s	983.04 s	-819.2 s	33287 s
200 Hz	244,140625 Hz	4.096 ms	1638.4 s	1966.08 s	-1638.4 s	66574 s
100 Hz	122,0703125 Hz	8.192 ms	3276.8 s	3932.16 s	-3276.8 s	133148 s

Softkeys of the analog demodulation menu

The following table shows all softkeys available in the analog demodulation menu. It is possible that your instrument configuration does not provide all softkeys. If a softkey is only available with a special option, model or (measurement) mode, this information is delivered in the corresponding softkey description.

Menu / Command	Submenu / Command	Command
Modulation AM/FM/PM		
Result Display	AF Time Domain	
	AF Spectrum	
	RF Time Domain	
	RF Spectrum	
	Select Trace	

Menu / Command	Submenu / Command	Command
	Diagram Full Size	
Demod BW		
Meas Time		
AF Range ↓	Dev per Division/dB per Division	
	Reference Position	
	Reference Value	
	Deviation Lin/Log	
Demod Settings ↓	AF Coupling AC/DC	
	AF Filter ↓	Low Pass AF Filter
		High Pass AF Filter
		Deemphasis
	Zero Phase Reference Point	
	Phase Wrap On/Off	
	Phase Unit Rad/Deg	
More ↓		
Zoom		

Modulation AM/FM/PM

Selects the display of demodulated AM, FM, or PM signal. In single sweep mode, the data is determined from the current I/Q data set, i.e. a change to AM/FM/PM does not trigger a new measurement.

If FM is selected, the average value of the demodulated signal is mapped depending on the **AF Coupling AC/DC** softkey setting.

→ Remote: `CALC:FEED 'XTIM:FM'`

Result Display

Opens a submenu to select the measurement result to be displayed. The RF or AF signal in the zero span or the RF or AF frequency spectrum determined via FFT can be selected for display.

In order to display the measurement results, the screen is divided in two halves. In the upper half, the measurement results are displayed as a trace. In the lower half the results of additional evaluation functions are shown.

All displays are determined from the I/Q data set recorded for the measurement. In single sweep mode, the single data set recorded can be evaluated in all displays simply by switching the result display.

AF Time Domain

Selects the AF display in zero span, calculated from the AM, FM, or PM signal.

→ Remote: `CALC:FEED 'XTIM:FM'`

AF Spectrum

Selects the display of the AF spectrum. The AF spectrum can be calculated from the AM, FM, or PM signal in zero span.

→ Remote: `CALC:FEED 'XTIM:FM:AFSP'`

RF Time Domain

Selects the display of the RF signal in zero span. In contrast to normal analyzer operation, the level values are determined from the recorded I/Q data set as root-mean-square values.

The softkey is not available if the RF spectrum display is selected.

→ Remote: `CALC:FEED 'XTIM:RFP'`

RF Spectrum

Selects the display of the RF signal in span > 0. In contrast to normal spectrum analyzer operation, the measured values are determined using FFT from the recorded I/Q data set.

→ Remote: `CALC:FEED 'XTIM:SPECTRUM'`

Select Trace

Opens an edit dialog box to enter the number of the trace for which the data is to be displayed in the lower half of the screen. Only activated traces can be selected.

Diagram Full Size

Switches the diagram to full screen size.

→ Remote: `DISP:SIZE LARG`

Demod BW

Opens an edit dialog box to enter the demodulation bandwidth of the analog demodulation. The demodulation bandwidth determines the sampling rate for recording the signal to be analyzed. For details on the relation between demodulation bandwidth and sampling rate refer to "[Sample rate, measurement time and trigger offset](#)" on page 4.133.

→ Remote: `BAND:DEM 1MHz`

Meas Time

Opens an editor for entering the measurement time of the analog demodulation. For details on the measurement time values refer to "[Sample rate, measurement time and trigger offset](#)" on page 4.133.

→ Remote: `ADEM:MTIM 62.5US`

→ Remote: `SWE:TIME 10s`

AF Range

Opens a submenu for determining the diagram scaling for AF displays.

The range for RF displays is set via the amplitude menu. For details refer to "[Setting the Level Display and Configuring the RF Input - AMPT Key](#)" on page 4.13.

Dev per Division

Opens an edit dialog box to set the modulation depth or the phase or frequency deviation per division:

AM display: 0.0001% to 1000%

FM display: 1 Hz/div to 1 MHz/div

PM display: 0.0001 rad/div to 1000 rad/div

The softkey is not available if logarithmic display is set (**Deviation Lin/Log** softkey).

→ Remote: `DISP:WIND:TRAC:Y:PDIV 50kHz`

dB per Division

Opens an edit dialog box to set the modulation depth or the FM or PM deviation to be displayed in the range 0.1 dB/div to 20 dB/div.

The softkey is not available if linear display is set (**Deviation Lin/Log** softkey).

→ Remote: `DISP:TRAC:Y:PDIV 5DB`

Reference Position

Determines the position of the reference line for the modulation depth or the phase or frequency deviation on the y-axis of the diagram. By default, this line is set to 0.

The position is entered as a percentage of the diagram height with 100 % corresponding to the upper diagram border. The default setting is 50 % (diagram center) for the display of the AM, FM, or PM signal, and 100% (upper diagram border) for the AF spectrum display of the AM, FM, or PM signal.

→ Remote: `DISP:TRAC:Y:RPOS 50PCT`

Reference Value

Determines the modulation depth or the frequency or phase deviation at the reference line of the y-axis. The reference value is set separately for each display of the AM, FM, and PM signal and the AF spectrum of the AM, FM, and PM signal.

- AM/FM/PM signal display

The trace display takes individual frequency/phase offsets into account (in contrast, the **AF Coupling AC/DC** softkey permits automatic correction by the average frequency/phase offset of the signal, and can therefore not be activated simultaneously).

Possible values: 0 and $\pm 10000\%$ (AM), 0 and ± 10 MHz (FM), 0 and ± 10000 rad (PM).

- AF spectrum display of the AM/FM/PM signal

In the default setting, the reference value defines the modulation depth or the FM/PM deviation at the upper diagram border.

Possible values: 0 and 10000% (AM), 0 and 10 MHz (FM), 0 and 10000 rad (PM).

→ Remote: `DISP:TRAC:Y:RVAL 0HZ`

Deviation Lin/Log

Switches between logarithmic and linear display of the modulation depth or the frequency or phase deviation.

→ Remote: `DISP:TRAC:Y:SPAC LOG`

Demod Settings

Opens a submenu for the demodulation settings.

AF Coupling AC/DC

Controls the automatic correction of the frequency offset and phase offset of the input signal:

– FM signal display

If DC is selected, the absolute frequency is displayed, i.e. an input signal with an offset relative to the center frequency is not displayed symmetrically with respect to the zero line.

If AC is selected, the frequency offset is automatically corrected, i.e. the trace is always symmetric with respect to the zero line.

– PM signal display

If DC is selected, the phase runs according to the existing frequency offset. In addition, the DC signal contains a phase offset of $\pm\pi$.

If AC is selected, the frequency offset and phase offset are automatically corrected, i.e. the trace is always symmetric with respect to the zero line.

The softkey is not available with the AF spectrum display of the FM or PM signal.

→ Remote: `ADEM:AF:COUP DC`

AF Filter

Opens a submenu to select the appropriate filters. The bandwidth of the demodulated signal can be reduced by high pass or low pass filters and also a de-emphasis can be switched on. The selected filters are used for AM, FM and PM demodulation in common. Individual settings are not possible.

Low Pass AF Filter

Opens the **Low Pass AF Filter** dialog box to select the filter type. Relative and absolute low pass filter are available.

– Relative low pass filters:

The filters (3 dB) can be selected in % of the demodulation bandwidth. The filters are designed as 5th-order Butterworth filter (30 dB/octave) and active for all demodulation bandwidths.

– Absolute low pass filters:

The filter are indicated by the 3 dB cutoff frequency. The 3 kHz and 15 kHz filters are designed as 5th-order Butterworth filter (30 dB/octave). The 150 kHz filter is designed as 8th-order Butterworth filter (48 dB/octave).

The absolute low pass filters are active in the following demodulation bandwidth range:

- 3 kHz: $6.4 \text{ kHz} \leq \text{demodulation bandwidth} \leq 4 \text{ MHz}$
- 15 kHz: $50 \text{ kHz} \leq \text{demodulation bandwidth} \leq 16 \text{ MHz}$
- 150 kHz: $400 \text{ kHz} \leq \text{demodulation bandwidth} \leq 16 \text{ MHz}$

- Remote: `FILT:LPAS ON`
- Remote: `FILT:LPAS:FREQ 150kHz`
- Remote: `FILT:LPAS:FREQ 25PCT`

High Pass AF Filter

Opens the **High Pass AF Filter** dialog box to switch on a high pass filter with the given limit to separate the DC component. The filters are indicated by the 3 dB cutoff frequency. The filters are designed as 2nd-order Butterworth filter (12 dB/octave).

The high pass filters are active in the following demodulation bandwidth range:

- 50 Hz: $200 \text{ Hz} \leq \text{demodulation bandwidth} \leq 4 \text{ MHz}$
- 300 Hz: $800 \text{ Hz} \leq \text{demodulation bandwidth} \leq 16 \text{ MHz}$

- Remote: `FILT:HPAS ON`
- Remote: `FILT:HPAS:FREQ 300Hz`

Deemphasis

Opens the **Deemphasis** dialog box to switch on a deemphasis with the given time constant.

The deemphasis is active in the following demodulation bandwidth range:

- 25 μs : $25 \text{ kHz} \leq \text{demodulation bandwidth} \leq 18 \text{ MHz}$
- 50 μs : $6.4 \text{ kHz} \leq \text{demodulation bandwidth} \leq 18 \text{ MHz}$
- 75 μs : $6.4 \text{ kHz} \leq \text{demodulation bandwidth} \leq 18 \text{ MHz}$
- 750 μs : $800 \text{ Hz} \leq \text{demodulation bandwidth} \leq 4 \text{ MHz}$

The following table shows the required demodulation bandwidth for an error less than 0.5 dB up to a maximum AF frequency.

deemphasis	25 μs	50 μs	75 μs	750 μs
max. AF frequency	25 kHz	12 kHz	8 kHz	800 Hz
required demodulation bandwidth	$\geq 200 \text{ kHz}$	$\geq 100 \text{ kHz}$	$\geq 50 \text{ kHz}$	$\geq 6.4 \text{ kHz}$

For higher AF frequencies the demodulation bandwidth must be increased.

- Remote: `FILT:DEMP ON`
- Remote: `FILT:DEMP:TCON 750us`

Zero Phase Reference Point

Defines the position at which the phase of the PM-demodulated signal is set to 0 rad. The entry is made with respect to time. In the default setting, the first measured value is set to 0 rad.

This softkey is only available in the PM display with DC coupling.

→ Remote: ADEM:PM:RPO 500us

Phase Wrap On/Off

Activates/deactivates the phase wrap.

On The phase will be displayed in the range $\pm 180^\circ$ ($\pm \Pi$). For example, if the phase exceeds $+180^\circ$, 360° is subtracted from the phase value, with the display thus showing $>-180^\circ$.

Off The phase will not be wrapped.

This softkey is available in the PM signal displays.

→ Remote: CALC:FORM PHAS

Phase Unit Rad/Deg

Sets the phase unit to rad or deg for displaying PM signals.

→ Remote: UNIT:ANGL RAD

Zoom

Activates or deactivates the zoom function. The zoom function is not available if the number of measurement points falls below 501.

activated: A 1-to-1 allocation is selected, i.e. each measurement point corresponds to a measured value. The start of the zoom window can be determined in the associated field by entering the time.

deactivated: If more measured values than measurement points are available, several measured values are combined in one measurement point according to the method of the selected trace detector. For details on detectors refer to "[Detector overview](#)" on page 4.38.

→ Remote: ADEM:ZOOM ON

→ Remote: ADEM:ZOOM:START 30US

Softkeys of the frequency menu (Analog Demodulation mode)

The following table shows all softkeys available in the frequency menu in **Analog Demodulation** mode (**FREQ** key). It is possible that your instrument configuration does not provide all softkeys. If a softkey is only available with a special option, model or (measurement) mode, this information is delivered in the corresponding softkey description.

Menu / Command	Command
Center	
CF Stepsize ↓	0.1*Span/0.1*Demod BW
	0.5*Span/0.5*Demod BW
	x*Span/x*Demod BW
	=Center
	Manual
AF Center	
AF Start	
AF Stop	

Center

For details refer to the **Center** softkey in the frequency menu of the base unit.

CF Stepsize

For details refer to the **CF Stepsize** softkey in the frequency menu of the base unit.

0.1*Span (RF Spectrum)

For details refer to the **0.1*Span** softkey in the frequency menu of the base unit.

0.1*Demod BW (AF/RF Time Domain, AF Spectrum)

For details see **0.1*RBW** softkey in the frequency menu of the base unit.

0.5*Span (RF Spectrum)

For details refer to the **0.5*Span** softkey in the frequency menu of the base unit.

0.5*Demod BW (AF/RF Time Domain, AF Spectrum)

For details see **0.5*RBW** softkey in the frequency menu of the base unit.

x*Span (RF Spectrum)

For details refer to the **x*Span** softkey in the frequency menu of the base unit.

x*Demod BW (AF/RF Time Domain, AF Spectrum)

For details see **x*RBW** softkey in the frequency menu of the base unit.

=Center

For details refer to the **=Center** softkey in the frequency menu of the base unit.

Manual

For details refer to the **Manual** softkey in the frequency menu of the base unit.

AF Center (AF Spectrum)

Opens an edit box to enter the center frequency within the AF spectrum.

→ Remote: ADEM:AF:CENT 1MHZ

AF Start

Opens an edit box to define the start frequency within the AF spectrum.

→ Remote: ADEM:AF:STAR 0HZ

AF Stop

Opens an edit box to define the stop frequency within the AF spectrum.

The maximum AF stop frequency corresponds to half the demodulation bandwidth.

→ Remote: ADEM:AF:STOP 2MHZ

Softkeys of the span menu (Analog Demodulation mode)

The following table shows all softkeys available in the span menu in **Analog Demodulation** mode (**SPAN** key). It is possible that your instrument configuration does not provide all softkeys. If a softkey is only available with a special option, model or (measurement) mode, this information is delivered in the corresponding softkey description.

Command
Span Manual/AF Span Manual
Demod Bandwidth
Full Span/AF Full Span

Span Manual (RF Spectrum)

If the RF spectrum display is active, values between the sampling rate/200 and the demodulation bandwidth/2 are allowed.

For further details refer to the **Span Manual** softkey in the span menu of the base unit.

→ Remote: ADEM:SPEC:SPAN:ZOOM 5 MHz

AF Span Manual (AF Spectrum)

Opens an edit dialog box to enter the frequency range for the AF spectrum display. Values between the sampling rate/1000 and the demodulation bandwidth/2 are allowed.

→ Remote: ADEM:AF:SPAN 2.5 MHz

Demod Bandwidth

For details see **Demod BW** softkey in the analog demodulation menu.

Full Span (RF Spectrum)

If the RF spectrum display is active, the full frequency range corresponds to the demodulation bandwidth.

For further details refer to the **Full Span** softkey in the span menu of the base unit.

→ Remote: ADEM:SPEC:SPAN:ZOOM MAX

AF Full Span (AF Spectrum)

Sets the span to the maximum frequency range for the AF spectrum display. The maximum frequency range corresponds to the demodulation bandwidth.

→ Remote: ADEM:AF:SPAN:FULL

Softkeys of the amplitude menu (Analog Demodulation mode)

The following table shows all softkeys available in the amplitude menu in **Analog Demodulation** mode (**AMPT** key). It is possible that your instrument configuration does not provide all softkeys. If a softkey is only available with a special option, model or (measurement) mode, this information is delivered in the corresponding softkey description.

Menu / Command	Command
Ref Level	
Range Log/Range Linear	
AF Range ↓	Dev per Division/dB per Division
	Reference Position
	Reference Value
	Deviation Lin/Log
Preamp On/Off	
RF Atten Manual	
RF Atten Auto	
More ↓	
Ref Level Offset	
Ref Level Position	
Grid Abs / Rel	

Menu / Command	Command
Unit	
Input 50 Ω / 75 Ω	

Ref Level

For details refer to the **Ref Level** softkey in the amplitude menu of the base unit.

Range Log (RF result display)

This softkey is only available for the RF result display. For the RF result display, the **AF Range** softkey is used.

For details refer to the **Range Log** softkey in the amplitude menu of the base unit.

Range Linear (RF result display)

This softkey is only available for the RF result display. For the RF result display, the **AF Range** softkey is used.

For details refer to the **Range Linear** softkey in the amplitude menu of the base unit.

AF Range (AF result display)

For details refer to the **AF Range** softkey in the analog demodulation menu.

Dev per Division

For details refer to the **Dev per Division** softkey in the analog demodulation menu.

dB per Division

For details refer to the **dB per Division** softkey in the analog demodulation menu.

Reference Position

For details refer to the **Reference Position** softkey in the analog demodulation menu.

Reference Value

For details refer to the **Reference Value** softkey in the analog demodulation menu.

Deviation Lin/Log

For details refer to the **Deviation Lin/Log** softkey in the analog demodulation menu.

Preamp On/Off (option RF Preamplifier, B22)

For details refer to the **Preamp On/Off** softkey in the amplitude menu of the base unit.

RF Atten Manual

For details refer to the **RF Atten Manual** softkey in the amplitude menu of the base unit.

RF Atten Auto

For details refer to the **RF Atten Auto** softkey in the amplitude menu of the base unit.

Ref Level Offset

For details refer to the **Ref Level Offset** softkey in the amplitude menu of the base unit.

Ref Level Position

For details refer to the **Ref Level Position** softkey in the amplitude menu of the base unit.

Grid Abs / Rel (not available with Range Linear)

For details refer to the **Grid Abs / Rel** softkey in the amplitude menu of the base unit.

Unit (PM AF result display)

For details refer to the **Unit** softkey in the amplitude menu of the base unit.

Input 50 Ω / 75 Ω

For details refer to the **Input 50 Ω / 75 Ω** softkey in the amplitude menu of the base unit.

Softkeys of the bandwidth menu (Analog Demodulation mode)

The following table shows all softkeys available in the bandwidth menu in **Analog Demodulation** mode (**BW** key). It is possible that your instrument configuration does not provide all softkeys. If a softkey is only available with a special option, model or (measurement) mode, this information is delivered in the corresponding softkey description.

Command
Res BW
Demod BW
Meas Time

Res BW (span > 0)

Opens an edit dialog box to enter a value for the resolution bandwidth. The range is specified in the data sheet.

→ Remote: ADEM:SPEC:BAND 10 kHz

Demod BW

For details refer to the **Demod BW** softkey in the in the analog demodulation menu.

Meas Time

For details refer to the **Meas Time** softkey in the in the analog demodulation menu.

Softkeys of the sweep menu (Analog Demodulation mode)

The following table shows all softkeys available in the sweep menu in **Analog Demodulation** mode (**SWEEP** key). It is possible that your instrument configuration does not provide all softkeys. If a softkey is only available with a special option, model or (measurement) mode, this information is delivered in the corresponding softkey description.

Command
Continuous Sweep
Single Sweep
Continue Sgl Sweep
Meas Time
Sweep Count

Continuous Sweep

For details refer to the **Continuous Sweep** softkey in the in the sweep menu of the base unit.

Single Sweep

For details refer to the **Single Sweep** softkey in the in the sweep menu of the base unit.

Continue Sgl Sweep

For details refer to the **Continue Single Sweep** softkey in the in the sweep menu of the base unit.

Meas Time

For details refer to the **Meas Time** softkey in the in the analog demodulation menu.

Sweep Count

For details refer to the **Sweep Count** softkey in the in the sweep menu of the base unit.

Softkeys of the trigger menu (Analog Demodulation mode)

The following table shows all softkeys available in the trigger menu in **Analog Demodulation** mode (**TRIG** key). It is possible that your instrument configuration does not provide all softkeys. If a softkey is only available with a special option, model or (measurement) mode, this information is delivered in the corresponding softkey description.

Command
Trigger Source
Trigger Level
Trigger Polarity Pos/Neg
Trigger Offset

Trigger Source

Opens the **Trigger** dialog box to select the trigger mode. Additional to the trigger modes described in section "[Trigger mode overview](#)" on page 4.27, the following trigger modes are available:

Selected option	Specified threshold
AM (Offline)	modulation depth of the AM signal
FM (Offline)	frequency of the FM signal
PM (Offline)	phase of the PM signal
RF (Offline)	level of the RF signal

In **Analog Demodulation** mode, the next measurement is triggered if the selected input signal exceeds the threshold specified using the **Trg / Gate Level** softkey. A periodic signal modulated onto the carrier frequency can be displayed in this way. It is recommended that the measurement time covers at least five periods of the audio signal.

For further details refer to the **Trg / Gate Source** softkey in the trigger menu.

→ Remote: TRIG:SOUR IMM | IFP | EXT | FM | PM | AM | RF (Free Run, IF Power, Extern, FM (Offline), PM (Offline), AM (Offline), RF (Offline))

Trigger Level

For details refer to the **Trg / Gate Level** softkey in the in the trigger menu of the base unit.

Trigger Polarity Pos/Neg

For details refer to the **Trg / Gate Polarity Pos/Neg** softkey in the in the trigger menu of the base unit.

Trigger Offset

For details on the relation between demodulation bandwidth (option Analog Demodulation, R&S FSL-K7) and trigger offset refer to "[Sample rate, measurement time and trigger offset](#)" on page 4.133.

For details refer to the **Trigger Offset** softkey in the in the trigger menu of the base unit.

Bluetooth Measurements (Option K8)

This option provides measurements to test the conformity of signal sources to the Bluetooth RF Test Specification (Bluetooth SIG). For background information on Bluetooth measurements refer to chapter "Advanced Measurement Examples".

This option is available from firmware version 1.30.

To open the Bluetooth menu

- If the **Bluetooth** mode is not the active measurement mode, press the **MODE** key and activate the **Bluetooth** option.
- If the **Bluetooth** mode is already active, press the **MENU** key.
The Bluetooth menu is displayed. .

Menu and softkey description

- ["Softkeys of the Bluetooth menu"](#) on page 4.157
- ["Softkeys of the frequency menu \(Bluetooth mode\)"](#) on page 4.162
- ["Softkeys of the amplitude menu \(Bluetooth mode\)"](#) on page 4.163
- ["Softkeys of the bandwidth menu \(Bluetooth mode\)"](#) on page 4.165
- ["Softkeys of the sweep menu \(Bluetooth mode\)"](#) on page 4.167
- ["Softkeys of the trigger menu \(Bluetooth mode\)"](#) on page 4.171
- ["Softkeys of the measurement menu \(Bluetooth mode\)"](#) on page 4.171

The span menu is not available in the **Bluetooth** mode. All other menus are provided as described for the base unit. For details refer to the corresponding menu descriptions.

To display help to a softkey, press the **HELP** key and then the softkey for which you want to display help. To close the help window, press the **ESC** key. For further information refer to section "How to use the Help System".

Further information

- ["Position of a Bluetooth burst"](#) on page 4.151
- ["Labels used in the measurement displays"](#) on page 4.151

Tasks

- [To adapt the settings to the characteristics of the DUT](#)

Measurements overview

The Bluetooth Measurements option provides the following measurement types:

- ["Output Power"](#) on page 4.152
- ["Adjacent Channel Power"](#) on page 4.152
- ["Modulation Characteristics"](#) on page 4.153
- ["Initial Carrier Frequency Tolerance"](#) on page 4.154
- ["Carrier Frequency Drift"](#) on page 4.154
- ["Relative Transmit Power \(EDR\)"](#) on page 4.155

- "In-band Spurious Emissions (EDR)" on page 4.156
- "Carrier Frequency Stability and Modulation Accuracy (EDR)" on page 4.156
- "Differential Phase Encoding (EDR)" on page 4.157

The basic parameter settings are described in section "[To adapt the settings to the characteristics of the DUT](#)" on page 4.150. The settings that can be configured individually for each measurement are the following:

- RBW (the IF bandwidth set up for modulation measurements is valid for all measurements)
- VBW
- RBW auto mode
- VBW auto mode
- trace mode
- detector
- sweep count
- sweep time auto mode
- sweep time

They are available in the corresponding menus as soon as the corresponding measurement is selected. Changes to these settings are always related to the selected measurement. The settings defined in the RF Test Specification can thus be modified individually for development or production. By using the start recall function, the individual configuration of the various tests can be preserved over a preset.

To adapt the settings to the characteristics of the DUT

1. Set the spectrum analyzer to its default state.
 - Press **PRESET**.
 - The R&S FSL is set to its default state.
2. Select the Bluetooth operating mode.
 - Press **MODE** key.
 - In the **Measurement Modes** dialog box, select **Bluetooth**.
 - The **Bluetooth** mode is activated and the main menu of the option is displayed.
3. Select the transmit channel.
 - Press **Channel** softkey and enter the desired channel number.
4. Select the packet length.
 - Press **Packet Type** softkey.
 - The list of available packet type is displayed.
 - Select the desired packet length and confirm the selection with **ENTER**.
5. Select the power class of the DUT.
 - Press **Power Class** softkey and enter the power class.
6. Configure the sync settings (LAP).
 - Press **Find Sync** softkey.
 - The submenu menu for configuration of the sync information is displayed.

- Press **LAP** softkey and enter the lower address part of the Bluetooth device address of the DUT. The sync word used for the sync search will be calculated.
7. Select a measurement.
- Press the **MEAS** key and select the desired measurement in the softkey menu.
 - Configure measurement time, measurement control and the number of measurement cycles by pressing the corresponding softkeys. For further information refer to section "[Softkeys of the measurement menu \(Bluetooth mode\)](#)" on page 4.171.

Further information

This section provides background information on measurements and displayed information.

Position of a Bluetooth burst

The RF Test Specification allows different methods to determine the position of a Bluetooth burst:

- The burst is defined by the p0 bit and the automatically determined packet length (**Find Sync On**).
- The burst is defined by the two 3dB points (**Find Sync Off** and **Find Burst On**). The search of the 3dB points is defined in the RF Test Specification as the alternative method compared with the p0 bit method.

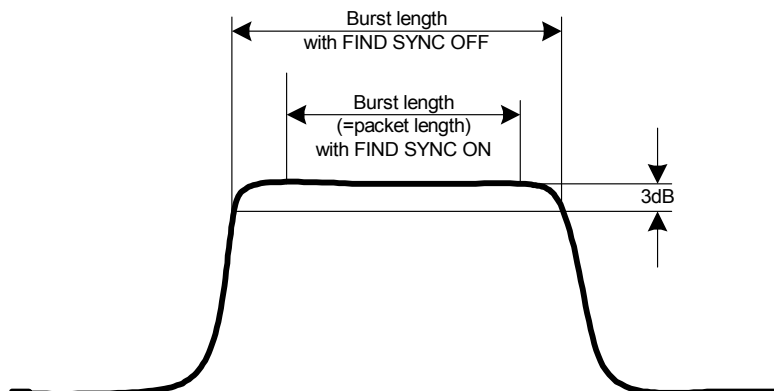

Fig. 4-11 Definition of a Bluetooth burst

Labels used in the measurement displays

- Enhancement label **TDF**

Offset values, set with the **Antenna Gain** softkey that are larger or smaller than 0 dB will activate the enhancement label **TDF** at the right diagram border.

Measurements

In this section, every measurement type is introduced by a short description.

Output Power measurement

The Output Power measurement (**Output Power** softkey) determines the maximum and average output power during a burst of the equipment under test (EUT). For this purpose a complete packet is recorded in the zero span.

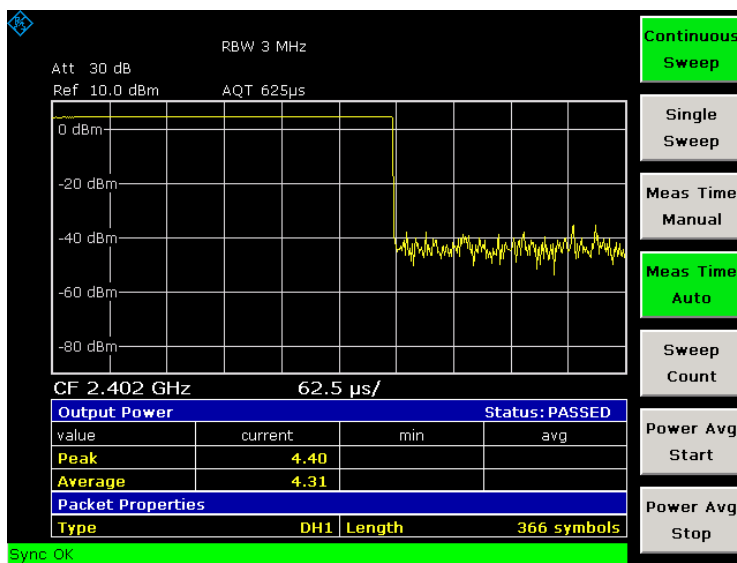

Fig. 4-12 Output power measurement

The peak value is determined from the complete contents of the measurement curve, whereas the average power is calculated from an area of at least 20% to 80% of the burst.

During the Output Power measurement the Bluetooth demodulator is active in order to determine the sync word within the signal, which is later-on used as the trigger basis. The Bluetooth demodulator is placed in a signal path without video filter. This is why the video filter cannot be activated with the Output Power measurement.

The EUT (equipment under test) must keep the following limits according to the RF Test Specification:

- $P_{AV} < 100 \text{ mW}$ (20 dBm) EIRP
- $P_{PK} < 200 \text{ mW}$ (23 dBm) EIRP
- If the EUT is conforming to power class 1: $P_{AV} > 1 \text{ mW}$ (0 dBm)
- If the EUT is conforming to power class 2: 0.25 mW (-6 dBm) $< P_{AV} < 2.5 \text{ mW}$ (4 dBm)
- If the EUT is conforming to power class 3: $P_{AV} < 1 \text{ mW}$ (0 dBm)

A violation of these limits is marked on the screen in red color.

Adjacent Channel Power measurement

The measurement of the TX Output Spectrum - Adjacent Channel Power measurement (**TX Spec ACP** softkey) measures the power of all adjacent channels.

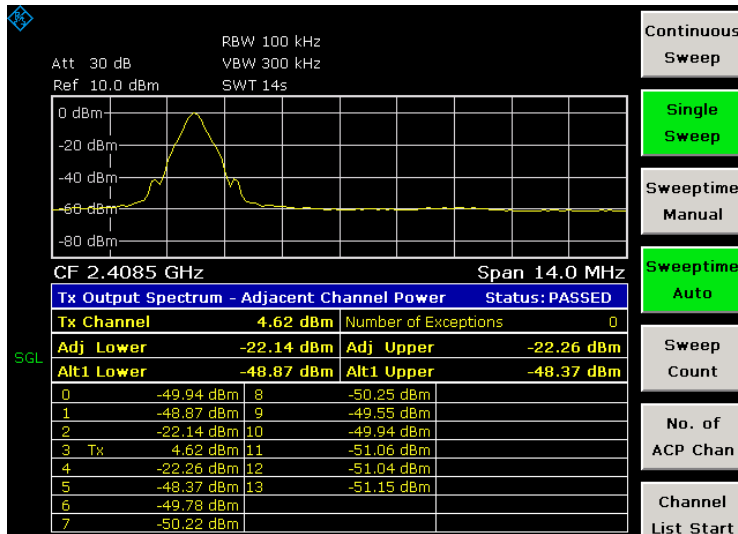

Fig. 4-13 TX Spectrum ACP measurement

The following limits are given by the RF Test Specification:

- $P_{TX}(f) \leq -20 \text{ dBm}$ for $|M-N| = 2$
- $P_{TX}(f) \leq -40 \text{ dBm}$ for $|M-N| \geq 3$

with M = Transmit channel of the equipment under test, N = adjacent channel to be measured

A violation of these limits will be marked by red color and an asterisk (*).

Modulation Characteristics measurement

The measurement of the modulation characteristics (**Modulation Char** softkey) determines the maximum frequency deviation of all 8 bit sequences of the payload.

Additionally the average value of the maximum frequency deviation of a packet will be calculated. For this purpose the equipment under test is configured in a way that packets with bit pattern "11110000" and "10101010" are transmitted alternately. According to the RF Test Specification this sequence has to be repeated 10 times.

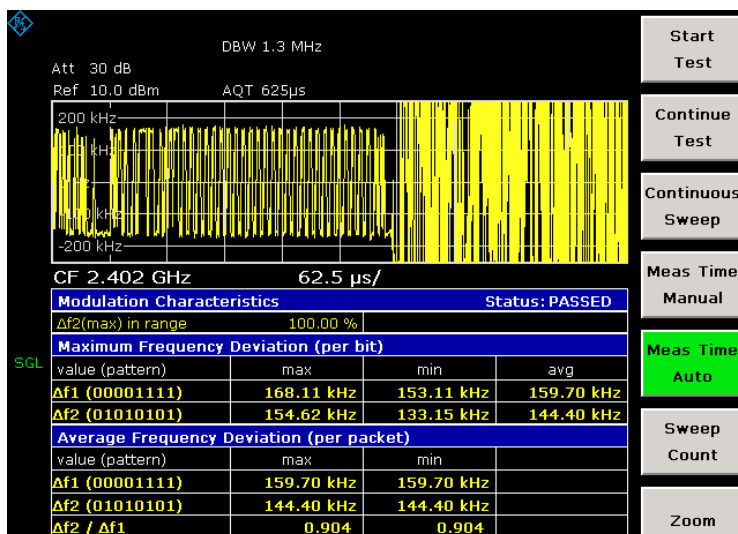

Fig. 4-14 Modulation Characteristics measurement

Initial Carrier Frequency Tolerance measurement

The measurement of the Initial Carrier Frequency Tolerance (**Init Carr Freq Tol** softkey) determines the carrier offset of the four preamble bits. According to the RF Test Specification the calculation of the carrier offset is performed from the middle of the first preamble bit to the middle of the bit following the preamble.

With **Clear/Write** trace mode and single sweep operation the selected number of sweeps will be processed and according to the RF Test Specification the results of all sweeps will be compared with the defined tolerance. If a different trace mode is selected, the analyzer can alternatively combine several traces and determine the measurement results from the resulting trace.

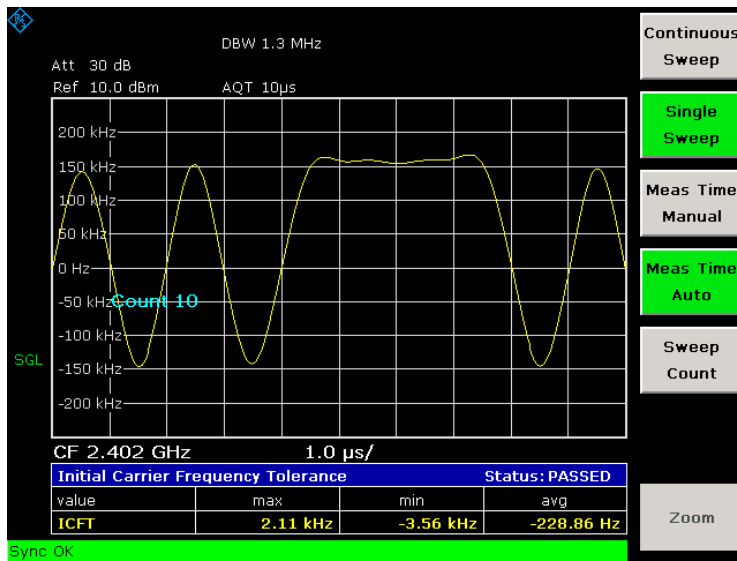

Fig. 4-15 Initial Carrier Frequency Tolerance measurement

Carrier Frequency Drift measurement

The measurement of the Carrier Frequency Drift (**Carr Freq Drift** softkey) determines the maximum frequency drift between the average value of the preamble bits and any 10 bit group of the payload. Additionally the maximum drift rate between all 10 bit groups in the payload is determined every 50µs.

With **Clear/Write** trace mode and single sweep operation the selected number of sweeps will be processed and according to the RF Test Specification the results of all sweeps will be compared with the defined tolerance. If a different trace mode is selected, the analyzer can alternatively combine several traces and determine the measurement results from the resulting trace.

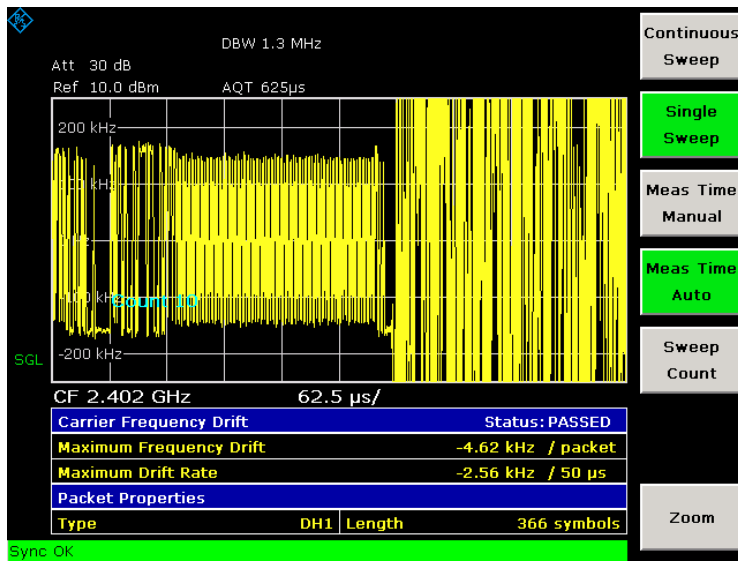

Fig. 4-16 Carrier Frequency Drift measurement

Relative Transmit Power (EDR) measurement

The measurement of the Relative Transmit Power (**Rel TX Power** softkey) is an enhanced data rate measurement (EDR). It determines the average transmission power of the GFSK and DPSK modulated parts of the signal and calculates the ratio of those values.

The measurement results must conform to the requirement:

- $(P_{GFSK} - 4\text{dB}) < P_{DPSK} < (P_{GFSK} + 1\text{dB})$

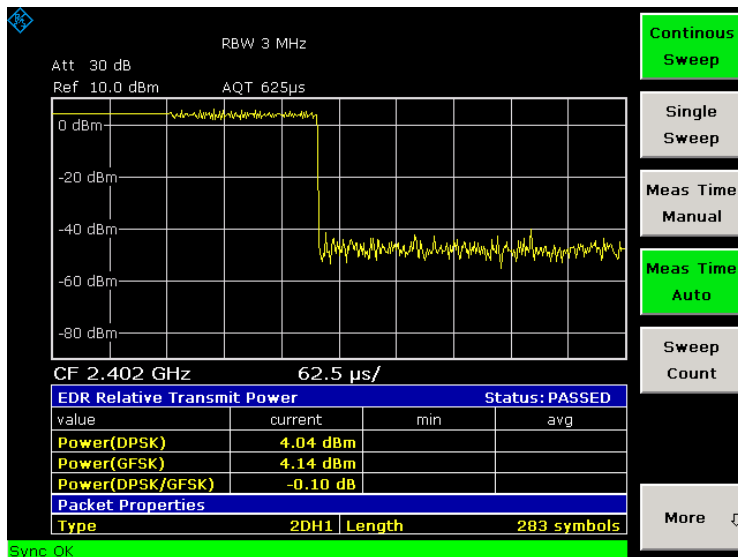

Fig. 4-17 Relative Transmit Power (EDR) measurement

In-band Spurious Emissions (EDR) measurement

The measurement of the In-band Spurious Emissions (**Spurious Emissions** softkey) is an enhanced data rate measurement (EDR). It verifies whether the level of unwanted signals within the used frequency band lies below the required level. The analyzer records the signal only in those parts of the signal in which the device transmits DPSK-modulated data.

The signal must meet the following conditions:

- $P_{TX}(f) \leq -20 \text{ dBm}$ for $|M-N| = 2$
- $P_{TX}(f) \leq -40 \text{ dBm}$ for $|M-N| \geq 3$
with M = transmit channel of the equipment under test, N = adjacent channel to be measured
- The adjacent channel power between 1 MHz and 1.5 MHz from the carrier (Adj500kHz Low/Upp) shall be at least 26 dB below the maximum power of the carrier (TX Channel (Ref)).

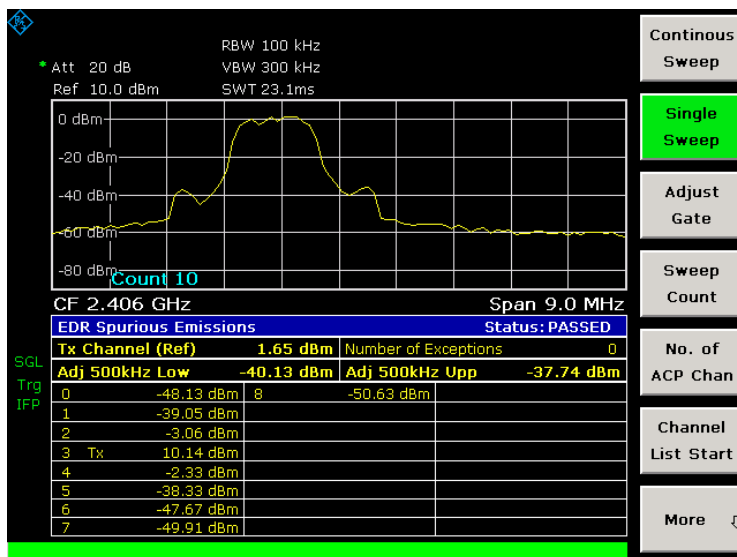

Fig. 4-18 In-band Spurious Emissions (EDR) measurement

Carrier Frequency Stability and Modulation Accuracy (EDR) measurement

The measurement of the Carrier Frequency Stability and Modulation Accuracy (**Carr Freq Stability** softkey) is an enhanced data rate measurement (EDR). It verifies that the modulation accuracy and the frequency stability are working within the required limits. According to the RF Test Specification, the software records 200 blocks, each with a length of 50 μs for the evaluation. The number of blocks to be recorded can be changed by the softkey **Block Count**.

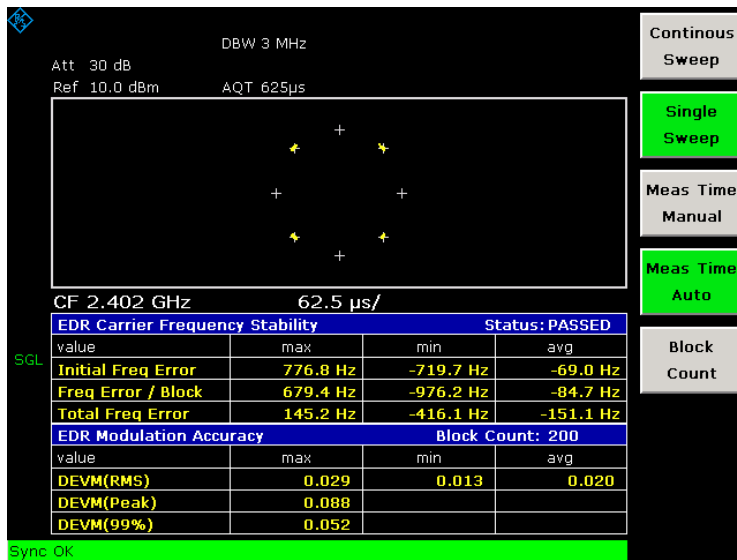

Fig. 4-19 Carrier Frequency Stability and Modulation Accuracy (EDR) measurement

Differential Phase Encoding (EDR) measurement

The measurement of the Differential Phase Encoding (**Diff Phase** softkey) is an enhanced data rate measurement (EDR). It checks in the time range of the DPSK modulation whether the device modulates the data correctly.

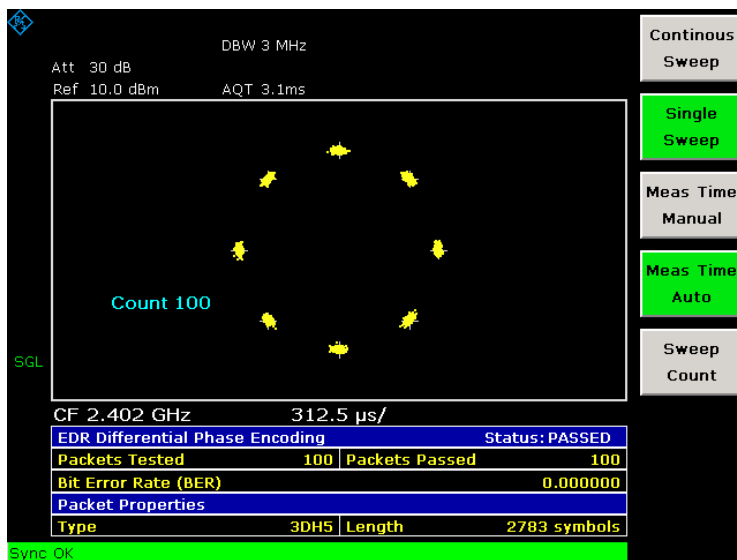

Fig. 4-20 Differential Phase Encoding (EDR) measurement

Softkeys of the Bluetooth menu

This menu provides the softkeys for the basic settings, which are common to all tests. The following table shows all softkeys available in the Bluetooth menu. It is possible that your instrument configuration does not provide all softkeys. If a softkey is only available with a special option, model or (measurement) mode, this information is delivered in the corresponding softkey description.

Menu / Command	Command
Channel	
Packet Type	
Packet Bytes SCO	
Power Class	
Antenna Gain	
Find Sync ↓	Find Sync On/Off
	LAP
	Sync Offset
	Find Burst On/Off
	Burst Offset
	Search Len Auto
	Search Len Manual
More ↓	
Select Trace	
Points / Symbol	

Channel

Opens an edit dialog box to enter the transmission channel number. From the number of the channel the center frequency is calculated in accordance to the RF Test Specification. The default setting is channel number 0.

Setting the channel number is in principle equal to changing the center frequency. The major difference is that the center frequency is not limited to available frequency band values, i.e. values outside the frequency band and between the discrete channels can be selected (see also **Center** softkey in the frequency menu).

→ Remote: CONF:BTO:CHAN 20

Packet Type

Opens a dialog box to select the number of occupied slots in the sent packet. The **AUTO** value is identical to **5 Slot Packet**. The default value is packet type **1 Slot Packet**.

The number of occupied slots is used for the automatic calculation of the sweep time (**Sweeptime Auto** softkey) and the search length of the sync word (**Search Len Auto** softkey).

The actually transmitted packet type is determined automatically by the Bluetooth demodulator (which means that the selected packet type need not necessarily correspond to the really transmitted packet type; it will only affect the settings for sweep time and search length as described above).

→ Remote: CONF:BTO:PTYP DH5

Packet Bytes SCO

Opens an edit dialog box to set the number of payload bytes that are transmitted in a packet. For SCO packets, the payload length must be adjusted because those packets have no payload header.

→ Remote: CONF:BTO:PBSC 50

Power Class (Output Power)

Opens an edit dialog box to set one of the Bluetooth power classes (1 to 3). The selection of the power class determines the limits. The default setting is power class 1 (100 mW).

→ Remote: CONF:BTO:PCL 3

Antenna Gain

Opens an edit dialog box to enter a level offset in order to take the gain of an antenna into account for displaying power values. The default setting is 0 dB (see also [Labels used in the measurement displays](#)).

→ Remote: CORR:EGA:INP 10DB

Find Sync

Opens a submenu to set the signal processing functions of the analyzer in order to determine the position of the first preamble bit p0 by correlation with the sync word. For this purpose a sufficient record length of the FM demodulated signal is necessary.

For further information refer to "[Position of a Bluetooth burst](#)" on page 4.151.

Find Sync On/Off

Activates or deactivates the search of the sync word. The default setting is activated.

The results of the modulation measurements [Modulation Characteristics](#), [Initial Carrier Frequency Tolerance](#), [Carrier Frequency Drift](#) can only be calculated if the softkey is activated. The measurement of the [Output Power](#) can be performed with either this softkey or the **Find Burst On/Off** softkey activated. If both softkeys are activated, the search area for the sync word will be limited to the area of the detected burst. If the **Find Burst On/Off** softkey is not activated or no burst is identified, the total record length (search length) is investigated.

For further information refer to "[Position of a Bluetooth burst](#)" on page 4.151.

→ Remote: DDEM:SEAR:SYNC ON

LAP

Opens an edit dialog box to enter the lower 24 bit (Lower Address Part, LAP) of the Bluetooth Device Address (BD_ADDR) of the equipment under test (EUT).

The LAP is used to calculate the 64-bit sync word. The sync word in return is used to determine the start of a packet by correlation and to determine the position of the first preamble bit p0 using the method described in the RF Test Specification.

The values for the lower address part range from 000000h to FFFFFFFh. The default setting is 0000000h.

→ Remote: DDEM:SEAR:SYNC:LAP #HA3F45B

Sync Offset

Opens an edit dialog box to define the number of bits to be displayed in front of the of the first preamble bit p0. If the sync word is identified, but the selected measurement time cannot be displayed due to the selected sync offset, the message **SYNC OFFSET INVALID** is displayed.

The value range depends on the search length and the upper limit of symbols (400001 points / symbol). The default setting for the sync offset is 0.

This softkey is only available if the **Find Sync On/Off** softkey is activated.

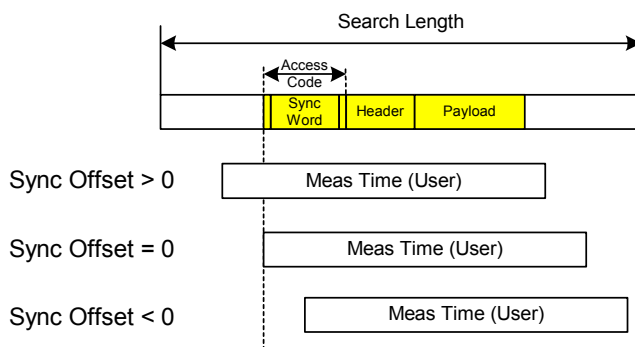

→ Remote: DDEM:SEAR:SYNC:OFFS 10

Find Burst On/Off (Output Power)

Activates the burst search if the **Find Sync On/Off** softkey is deactivated. Beside the synchronization on the sync word, the Output Power measurement can perform a burst search to evaluate the signal according to the standard.

If the **Find Sync On/Off** softkey is not activated and no burst is identified, the message **BURST NOT FOUND** is displayed, and the corresponding bit in the STATus:QUEStionable:SYNC register is set during remote operation.

For further information refer to "[Position of a Bluetooth burst](#)" on page 4.151.

→ Remote: DDEM:SEAR:PULS OFF

Burst Offset

Opens an edit dialog box to define the time to be displayed before the identified burst. The values range from -10 ms to + 10 ms, with negative values moving the burst to the left, positive values to the right. The default setting for the burst offset is 0.

If the burst is identified, but the selected measurement time cannot be displayed due to the selected burst offset, the message **BURST OFFSET INVALID** is displayed.

This softkey is only available if the **Find Sync On/Off** softkey is deactivated and the **Find Burst On/Off** softkey is activated.

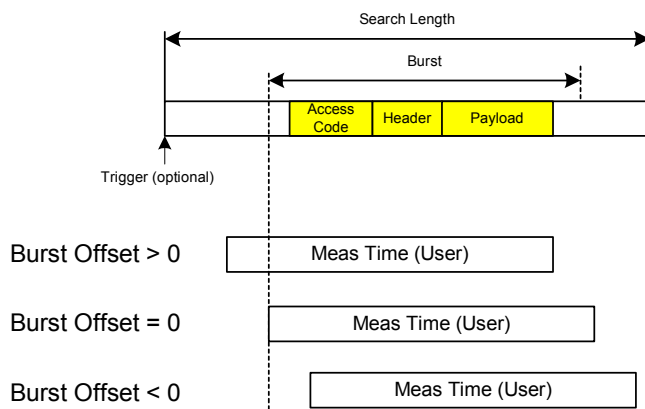

→ Remote: DDEM:SEAR:PULS:OFFS 1MS

Search Len Auto

Activates or deactivates the automatic selection of the search length for the search of the sync word or the burst, depending on the selected packet type. The automatic search length is determined as follows:

Trigger free run:

$$\text{search length} = 3 * \text{packet length} + | \text{sync offset or burst offset} |$$

All other trigger modes:

$$\text{search length} = 1 * \text{packet length} + 1 \text{ Slot} + | \text{sync offset or burst offset} |$$

If the selected measurement time is higher than the packet length, the following difference is added to the search length:

$$\text{measurement time} - \text{packet length}$$

In the default setting, the automatic calculation of the search length is activated.

→ Remote: DDEM:SEAR:TIME:AUTO OFF

Search Len Manual

Opens an edit dialog box to enter the search length used for determining the sync word or the burst. The unit of the search length is seconds; the values range from 100 μ s to (400001 / points per symbol) μ s. The default setting is 1825 μ s.

The selected number of points / symbol and the maximum search length is listed in the table below.

Points per symbol	Max. search length (number of slots)
2	104.4
4	52.2
8	26.1
16	13.1
32	6.5

For information on the correlation of trigger and record length refer to the **Search Len Auto** softkey.

→ Remote: DDEM:SEAR:TIME 100US

Select Trace

Opens an edit dialog box to select the measurement curve whose numeric results will be displayed in the lower half of the screen. The default curve selected is trace 1.

→ Remote: CONF:BTO:TRAC2:SEL

Points / Symbol (Output Power, TX Spec ACP, Modulation Char, Init Carr Freq Tol, Carr Freq Drift)

Opens an edit dialog box to change the number of measurement samples per symbol. For Basic Rate measurements, the possible values are 2, 4, 8, 16, 32. The default value is 4. For EDR measurements, the default value is set and cannot be changed.

The RF Test Specification requests an oversampling factor of at least 4. With this oversampling factor a **5 Slot Packet** corresponds to 12500 measurement samples (= 2500 samples / slot).

→ Remote: CONF:BTO:PRAT 16

Softkeys of the frequency menu (Bluetooth mode)

The following table shows all softkeys available in the frequency menu in **Bluetooth** mode (**FREQ** key). It is possible that your instrument configuration does not provide all softkeys. If a softkey is only available with a special option, model or (measurement) mode, this information is delivered in the corresponding softkey description.

Menu / Command	Command
Center	
CF-Stepsize ↓	0.1*Chan Spacing
	= Chan Spacing

Center

Opens an edit dialog box to change the center frequency.

If the frequency channel has been set via the **Channel** softkey, a change of the center frequency is possible, but the relation to the frequency channel will be lost, which means that the value range for the center frequency is not limited to frequencies within valid frequency channels.

The return to the fixed relation between center frequency and Bluetooth frequency channels is performed when **Channel** softkey is pressed or when another measurement is selected. The center frequency will be rounded to the nearest frequency channel.

→ Remote: `FREQ:CENT 100MHz`

CF-Stepsize

Opens a submenu to set the step size of the center frequency.

0.1*Chan Spacing

Sets the step size of the center frequency to 1/10 of the channel spacing.

= Chan Spacing

Sets the step size of the center frequency to the size of the channel spacing.

Softkeys of the amplitude menu (Bluetooth mode)

The following table shows all softkeys available in the amplitude menu in **Bluetooth** mode (**AMPT** key). It is possible that your instrument configuration does not provide all softkeys. If a softkey is only available with a special option, model or (measurement) mode, this information is delivered in the corresponding softkey description.

Menu / Command	Command
Ref Level	
Range ↓	Range
	Reference Position
	Reference Value
	Zoom
Range Log	
Range Linear	
RF Atten Manual	
RF Atten Auto	
More ↓	
Ref Level Offset	
Ref Level Position	
Input 50 Ω / 75 Ω	

Ref Level

The maximum input power of the A/D converter (defined by this value) must be equal or higher than the maximum power of the signal under test.

For details refer to the **Ref Level** softkey in the amplitude menu of the base unit.

Range (Modulation Char, Init Carr Freq Tol, Carr Freq Drift)

Opens a submenu for scaling the x- and y-axis.

Range (Modulation Char, Init Carr Freq Tol, Carr Freq Drift)

Opens an edit dialog box to enter the range for the frequency deviation.

→ Remote: `DISP:TRAC:Y 110dB`

Reference Position (Modulation Char, Init Carr Freq Tol, Carr Freq Drift)

Opens an edit dialog box to enter the position of the reference line for the frequency deviation on the y-axis of the diagram. The unit is % of the diagram height, with 100% corresponding to the upper diagram border.

→ Remote: `DISP:WIND:TRAC:Y:RPOS 50PCT`

Reference Value (Modulation Char, Init Carr Freq Tol, Carr Freq Drift)

Opens an edit dialog box to enter the FM deviation at the reference line on the y-axis. This allows individual frequency offsets to be taken into account for the display of the measurement curves. The valid value range is 0 to ± 1 MHz; the default setting is 0 Hz.

→ Remote: `DISP:TRAC:Y:RVAL 0`

Range Log**(Output Power, TX Spec ACP, Rel TX Power, Spurious Emissions, Carr Freq Stability, Diff Phase)**

For details refer to the **Range Log** softkey in the amplitude menu of the base unit.

Range Linear**(Output Power, TX Spec ACP, Rel TX Power, Spurious Emissions, Carr Freq Stability, Diff Phase)**

For details refer to the **Range Linear** softkey in the amplitude menu of the base unit.

RF Atten Manual

For details refer to the **RF Atten Manual** softkey in the amplitude menu of the base unit.

RF Atten Auto

For details refer to the **RF Atten Auto** softkey in the amplitude menu of the base unit.

Ref Level Offset

For details refer to the **Ref Level Offset** softkey in the amplitude menu of the base unit.

Ref Level Position

For details refer to the **Ref Level Position** softkey in the amplitude menu of the base unit.

Input 50 Ω / 75 Ω

For details refer to the **Input 50 Ω / 75 Ω** softkey in the amplitude menu of the base unit.

Softkeys of the bandwidth menu (Bluetooth mode)

The following table shows all softkeys available in the bandwidth menu in **Bluetooth** mode (**BW** key). It is possible that your instrument configuration does not provide all softkeys. If a softkey is only available with a special option, model or (measurement) mode, this information is delivered in the corresponding softkey description.

Command
Meas Time Manual
Meas Time Auto
SweepTime Manual
SweepTime Auto
Res BW Manual
Res BW Auto
Video BW Manual
Video BW Auto
Filter Type
Meas Filter

Meas Time Manual

(Output Power, Modulation Char, Init Carr Freq Tol, Carr Freq Drift, Rel TX Power, Carr Freq Stability, Diff Phase)

Opens an edit dialog box to enter the measurement time. The valid value range is 1 μ s to (400001 / points per symbol) μ s.

→ Remote: CONF:BTO:SWE:TIME 10MS

Meas Time Auto

(Output Power, Modulation Char, Init Carr Freq Tol, Carr Freq Drift, Rel TX Power, Carr Freq Stability, Diff Phase)

Activates the automatic calculation of the measurement time. The automatic sweep time corresponds to the settings defined in the RF Test Specification. By default, the automatic sweep time calculation is activated.

→ Remote: CONF:BTO:SWE:TIME:AUTO ON

Sweeptime Manual (TX Spec ACP)

Opens an edit dialog box to enter the sweep time. The valid value range is 10 μ s (minimum measurement time for one channel) to 16000 s. The default setting is 79 s.

→ Remote: `CONF:BTO:SWE:TIME 10MS`

Sweeptime Auto (TX Spec ACP)

Activates the automatic calculation of the sweep time. The automatic sweep time corresponds to the settings defined in the RF Test Specification. By default, it is activated.

→ Remote: `CONF:BTO:SWE:TIME:AUTO ON`

Res BW Manual (Output Power, Rel TX Power)

Opens an edit dialog box to enter the resolution bandwidth. The values range from 1 MHz to 3 MHz. The default value is 3 MHz.

→ Remote: `CONF:BTO:BAND 1KHZ`

Res BW Auto (Output Power, TX Spec ACP, Rel TX Power, Spurious Emissions)

Sets the bandwidth according to the values defined in the RF Test Specification.

→ Remote: `CONF:BTO:BAND:AUTO ON`

Video BW Manual (TX Spec ACP)

The default value is 300 kHz, according to the values defined in the RF Test Specification.

For further details refer to the **Video BW Manual** softkey in the bandwidth menu of the base unit.

→ Remote: `CONF:BTO:BAND:VID 100HZ`

Video BW Auto (TX Spec ACP, Spurious Emissions)

Sets the video bandwidth according to the values defined in the RF Test Specification. In the In-band Spurious Emissions measurement, the video bandwidth is always adjusted automatically. Therefore the softkey is activated by default and its state cannot be changed.

→ Remote: `CONF:BTO:BAND:VID:AUTO ON`

Filter Type (Output Power, TX Spec ACP, Spurious Emissions, Rel TX Power)

Opens the **Filter Type** dialog box to select the filter type. For the measurements Output Power and Rel TX Power, a Gaussian or a channel filter can be selected. For the measurements TX Spec ACP and Spurious Emissions, the filter type is a Gaussian filter.

→ Remote: `BAND:TYPE NORM`

Meas Filter (Modulation Char, Init Carr Freq Tol, Carr Freq Drift)

Activates or deactivates a filter that limits the bandwidth for the modulation measurements. Since the RF Test Specification Rev 2.0.E.3 it is required to use this filter and therefore it is activated by default.

The filter is flat within 1.04 MHz (ripple: only 0.02 dB) and has steep slopes outside this area. The filter has the following characteristics:

- passband ripple up to ± 550 kHz < 0.5 dB (peak to peak)
- minimum attenuation in the transition band
 - ± 650 kHz: ≥ 3 dB
 - ± 1 MHz: ≥ 14 dB
 - ± 2 MHz: ≥ 44 dB

→ Remote: DDEM:FILT:MEAS BTO

Softkeys of the sweep menu (Bluetooth mode)

The following table shows all softkeys available in the sweep menu in **Bluetooth** mode (**SWEEP** key). In the **Bluetooth** mode, the sweep menu is used for direct entry into the measurement menu of the currently selected measurement. It is possible that your instrument configuration does not provide all softkeys. If a softkey is only available with a special option, model or (measurement) mode, this information is delivered in the corresponding softkey description.

Command
Start Test
Continue Test
Continuous Sweep
Single Sweep
Meas Time Manual
Meas Time Auto
Sweeptime Manual
Sweeptime Auto
Block Count
Adjust Gate
Sweep Count
Power Avg Start
Power Avg Stop
Zoom
No. of ACP Chan
Channel List Start
More ↓
Gate Delay
Gate Length
GFSK Start

Command
GFSK Stop
DPSK Start
DPSK Stop

Start Test (Modulation Char)

Initiates a new measurement. All frequency deviation values obtained earlier are discarded.

The bit pattern in the payload is detected automatically. The frequency deviation of a packet is determined according to the procedure defined in the RF Test Specification.

→ Remote: INIT;*WAI

Continue Test (Modulation Char)

Measures the frequency deviation of further packets after the bit pattern has been changed at the EUT, just like the **Start Test** softkey did for the first bit pattern type. The results of the preceding measurement are preserved and are taken into account for the new measurements.

→ Remote: INIT:CONM;*WAI

Continuous Sweep

Selects the continuous measurement operation. This is the default setting of the instrument.

→ Remote: INIT:CONT ON;*WAI

Single Sweep (Output Power, TX Spec ACP, Init Carr Freq Tol, Carr Freq Drift, Rel TX Power, Spurious Emissions, Carr Freq Stability, Diff Phase)

Selects the single measurement operation and starts a measurement cycle.

→ Remote: INIT:CONT OFF;*WAI

Block Count (Carr Freq Stability)

Opens an edit dialog box to enter the number of blocks to be measured. Every block has the length of 50 μ s. The default value is 200 blocks.

This softkey is only available in single sweep operation.

→ Remote: CONF:BTO:CFST:BCO 1000

Adjust Gate (Spurious Emissions)

Adjusts the gate settings according to the pre-measurement results.

→ Remote: CONF:BTO:IBS:GATE:AUTO ONCE

Sweep Count

(Output Power, TX Spec ACP, Modulation Char, Init Carr Freq Tol, Carr Freq Drift, Rel TX Power, Spurious Emissions, Diff Phase)

Opens an edit dialog box to enter the number of sweeps to be initiated by **Single Sweep** softkey. The valid value range is 0 to 32767.

→ Remote: CONF:BTO:SWE:COUN 20

Power Avg Start (Output Power)

Opens an edit dialog box to enter the start position of the evaluation area for the average burst power. The values range from 0 to 100%, the default setting is 20%.

For further information refer to "[Position of a Bluetooth burst](#)" on page 4.151.

→ Remote: CONF:BTO:POW:AVER:STAR 10PCT

Power Avg Stop (Output Power)

Opens an edit dialog box to enter the stop position of the evaluation area for the average burst power. The values range from 0 to 100%, the default setting is 80%.

For further information refer to "[Position of a Bluetooth burst](#)" on page 4.151.

→ Remote: CONF:BTO:POW:AVER:STAR 90PCT

Zoom (Modulation Char, Init Carr Freq Tol, Carr Freq Drift)

Activates or deactivates the zoom function. Opens an edit dialog box to enter the zoom start position. The valid value range for the zoom start position is 0 to (measurement time - 500 / sampling rate). The default setting for the zoom function is 0s (off).

With active zoom function, an area of only 501 samples is displayed.

→ Remote: ADEM:ZOOM ON

→ Remote: ADEM:ZOOM:STAR 500us

No. of ACP Chan (TX Spec ACP, Spurious Emissions)

Opens an edit dialog box to enter the number of adjacent channels, for which the power is to be measured. The values range from 0 to 78. A minimum value of 3 is recommended. The default setting is 78 (all channels).

As with the ACP measurement of the basic instrument firmware this value refers to the number of adjacent channels on one side of the TX channel. This means that with a selected value of 10 the analyzer will measure in total 21 channels (10 lower channels + TX channel + 10 upper channels).

The frequency range required for the measurement is set up automatically. The center frequency will also be adapted automatically dependent on the selected TX channel.

The measurement of the adjacent channels is limited to the available Bluetooth frequency band, which means that at maximum 79 channels (23 channels in France) will be measured.

→ Remote: CONF:BTO:ACLR:ACP 10 (TX Spec ACP)

→ Remote: CONF:BTO:IBS:ACP 20 (Spurious Emissions)

Channel List Start (TX Spec ACP, Spurious Emissions)

Opens an edit dialog box to enter the channel with which the result display table starts. Because of the multiplicity of the measurements results not all channels can be displayed simultaneously.

Gate Delay (Spurious Emissions)

Opens an edit dialog box to enter the time between trigger event and start of the DPSK packet. That is the measurement start time.

→ Remote: `SWE:EGAT:HOLD 100us`

Gate Length (Spurious Emissions)

Opens an edit dialog box to enter the sweep time in seconds. Usually, this is the length of the DPSK section.

→ Remote: `SWE:EGAT:LENG 10ms`

GFSK Start (Rel TX Power)

Opens an edit dialog box to enter the start time for the power measurement of the GFSK sections of the packet. The default value is 10%.

The abbreviation GFSK stands for Gaussian Frequency Shift Keying.

→ Remote: `CONF:BTO:RTP:GAV:STAR 20`

GFSK Stop (Rel TX Power)

Opens an edit dialog box to enter the stop time for the power measurement of the GFSK sections of the packet. The default value is 90%.

The abbreviation GFSK stands for Gaussian Frequency Shift Keying.

→ Remote: `CONF:BTO:RTP:GAV:STOP 80`

DPSK Start (Rel TX Power)

Opens an edit dialog box to enter the start time for the power measurement of the DPSK sections of the packet. The default value is 10%.

The abbreviation DPSK stands for Differential Phase Shift Keying.

→ Remote: `CONF:BTO:RTP:DAV:STAR 20`

DPSK Stop (Rel TX Power)

Opens an edit dialog box to enter the stop time for the power measurement of the DPSK sections of the packet. The default value is 90%.

The abbreviation DPSK stands for Differential Phase Shift Keying.

→ Remote: `CONF:BTO:RTP:DAV:STOP 80`

Softkeys of the trigger menu (Bluetooth mode)

The following table shows all softkeys available in the trigger menu in **Bluetooth** mode (**FREQ** key). It is possible that your instrument configuration does not provide all softkeys. If a softkey is only available with a special option, model or (measurement) mode, this information is delivered in the corresponding softkey description.

Command
Trigger Source
Trg/Gate Level
Trigger Polarity
Trigger Offset

Trigger Source

Opens the **Trigger** dialog box to select one of the following trigger sources: **Free Run**, **External**, **IF Power**.

For further details refer to the **Trg / Gate Source** softkey in the trigger menu of the base unit.

Trg/Gate Level

Opens an edit dialog box to enter the trigger / gate level. This softkey is not available, if the trigger source **Free Run** is selected.

For further details refer to the **Trg / Gate Level** softkey in the trigger menu of the base unit.

Trigger Polarity

For details refer to the **Trg / Gate Polarity Pos/Neg** softkey in the trigger menu of the base unit.

Trigger Offset

For details refer to the **Trigger Offset** softkey in the trigger menu of the base unit.

Softkeys of the measurement menu (Bluetooth mode)

The following table shows all softkeys available in the measurement menu in **Bluetooth** mode (**MEAS** key). It is possible that your instrument configuration does not provide all softkeys. If a softkey is only available with a special option, model or (measurement) mode, this information is delivered in the corresponding softkey description.

In the **Bluetooth** mode, the sweep menu is used for direct entry into the measurement menu of the currently selected measurement. Therefore only the softkeys to select a measurement are described in this section. All other softkeys are linked to the description in section [Softkeys of the sweep menu \(Bluetooth mode\)](#) or [Softkeys of the bandwidth menu \(Bluetooth mode\)](#).

Menu / Command	Submenu / Command	Command
Output Power	Continuous Sweep	
	Single Sweep	
	Meas Time Manual	

Menu / Command	Submenu / Command	Command
	Meas Time Auto	
	Sweep Count	
	Power Avg Start	
	Power Avg Stop	
TX Spec ACP ↓	Continuous Sweep	
	Single Sweep	
	Sweeptime Manual	
	Sweeptime Auto	
	Sweep Count	
	No. of ACP Chan	
	Channel List Start	
Modulation Char ↓	Start Test	
	Continue Test	
	Continuous Sweep	
	Meas Time Manual	
	Meas Time Auto	
	Sweep Count	
	Zoom	
Init Carr Freq Tol ↓	Continuous Sweep	
	Single Sweep	
	Meas Time Manual	
	Meas Time Auto	
	Sweep Count	
	Zoom	
Carr Freq Drift ↓	see contents of the Init Carr Freq Tol submenu	
EDR ↓	Rel TX Power ↓	Continuous Sweep
		Single Sweep
		Meas Time Manual
		Meas Time Auto
		Sweep Count
		More ↓
		GFSK Start
		GFSK Stop
		DPSK Start
		DPSK Stop
	Spurious Emissions ↓	Continuous Sweep
		Single Sweep

Menu / Command	Submenu / Command	Command
		Adjust Gate
		Sweep Count
		No. of ACP Chan
		Channel List Start
		More ↓
		Gate Delay
		Gate Length
	Carr Freq Stability ↓	Continuous Sweep
		Single Sweep
		Meas Time Manual
		Meas Time Auto
		Block Count
	Diff Phase ↓	Continuous Sweep
		Single Sweep
		Meas Time Manual
		Meas Time Auto
		Sweep Count

Output Power

Opens a submenu to configure the Output Power measurement. For further details refer to "[Output Power measurement](#)" on page 4.152.

- Remote: CONF:BTO:MEAS OPOW
 - Remote: CALC:BTO:OPOW?
 - Remote: CALC:BTO:OPOW:AVER? MAX
-

TX Spec ACP

Opens a submenu to configure the TX Spec ACP measurement. For further details refer to "[Adjacent Channel Power measurement](#)" on page 4.152.

- Remote: CONF:BTO:MEAS ACLR
 - Remote: CALC:BTO:ACLR?
 - Remote: CALC:BTO:ACLR:EXC?
-

Modulation Char

Opens a submenu to configure the Modulation Char measurement. For further details refer to "[Modulation Characteristics measurement](#)" on page 4.153.

- Remote: CONF:BTO:MEAS MCH
 - Remote: CALC:BTO:MCH:DF1:AVER? MIN
 - Remote: CALC:BTO:MCH:DF1:MAX? MIN
 - Remote: CALC:BTO:MCH:DF2:PERC?
 - Remote: CALC:BTO:MCH:RAT? MIN
-

Init Carr Freq Tol

Opens a submenu to configure the Init Carr Freq Tol measurement. For further details refer to "[Initial Carrier Frequency Tolerance measurement](#)" on page 4.154.

- Remote: CONF:BTO:MEAS IFCT
 - Remote: CALC:BTO:ICFT? AVER
-

Carr Freq Drift

Opens a submenu to configure the Carr Freq Drift measurement. For further details refer to "[Carrier Frequency Drift measurement](#)" on page 4.154.

- Remote: CONF:BTO:MEAS CFDR
 - Remote: CALC:BTO:CFDR?
 - Remote: CALC:BTO:CFDR:RATE?
-

EDR

Opens a submenu with all available enhanced data rate measurements.

Rel TX Power

Opens a submenu to configure the Rel TX Power measurement. For further details refer to "[Relative Transmit Power \(EDR\) measurement](#)" on page 4.155.

- Remote: CONF:BTO:MEAS RTP
 - Remote: CALC:BTO:RTP? MIN
 - Remote: CALC:BTO:RTP:GFSK? MIN
 - Remote: CALC:BTO:RTP:RAT? MIN
-

Spurious Emissions

Opens a submenu to configure the Spurious Emissions measurement. For further details refer to "[In-band Spurious Emissions \(EDR\) measurement](#)" on page 4.156.

- Remote: CONF:BTO:MEAS IBS
 - Remote: CALC:BTO:IBS?
 - Remote: CALC:BTO:IBS:EXC?
 - Remote: CALC:BTO:IBS:HADJ? LOW
-

Carr Freq Stability

Opens a submenu to configure the Carr Freq Stability measurement. For further details refer to "[Carrier Frequency Stability and Modulation Accuracy \(EDR\) measurement](#)" on page 4.156.

- Remote: CONF:BTO:MEAS CFST
 - Remote: CALC:BTO:CFST:FERR? MIN
 - Remote: CALC:BTO:CFST:FERR:BLOC? AVER
 - Remote: CALC:BTO:CFST:FERR:INIT? MAX
 - Remote: CALC:BTO:CFST:DEVM? AVER
 - Remote: CALC:BTO:CFST:DEVM:PEAK?
 - Remote: CALC:BTO:CFST:DEVM:D99Pct?
 - Remote: CALC:BTO:CFST:COUNT?
-

Diff Phase

Opens a submenu to configure the Diff Phase measurement. For further details refer to "[Differential Phase Encoding \(EDR\) measurement](#)" on page 4.157.

- Remote: CONF:BTO:MEAS DPEN
 - Remote: CALC:BTO:DPEN:NERR?
 - Remote: CALC:BTO:DPEN?
 - Remote: CALC:BTO:DPEN:BER?
-

Power Meter (Option K9)

For precise power measurement a power sensor is connected to the instrument via the front panel (USB connector) or the rear panel (power sensor, option R&S FSL-B5). The Power Sensor Support firmware option provides the power measurement functions for this test setup (see Fig. 4-21: Power sensor support - standard test setup). Both manual operation and remote control are supported. The functions of this firmware option are described in this section. For details on the connectors and compatible power sensors refer to the Quick Start Guide, chapter 1, "Front and Rear Panel".

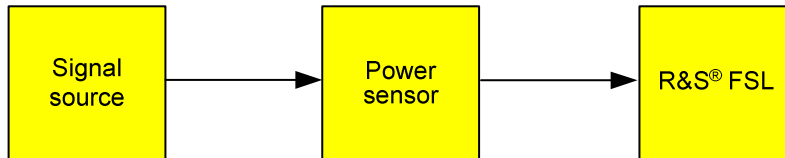

Fig. 4-21: Power sensor support - standard test setup

To open the power meter menu

1. Press the **MENU** key.
2. Press the **Power Meter** softkey.
The power meter menu is displayed.

Menu and softkey description

- ["Softkeys of the power meter menu"](#) on page 4.177

To display help to a softkey, press the **HELP** key and then the softkey for which you want to display help. To close the help window, press the **ESC** key. For further information refer to section "How to use the Help System".

Tasks

- [To zero the power meter](#)
- [To use the power meter](#)

To zero the power meter

1. Press the **Zero** softkey.
A dialog box is displayed that prompts you to disconnect all signals from the input of the power sensor.
2. Disconnect all signals from the input of the power sensor and press **ENTER** to continue.
3. Wait until zeroing is complete.
A corresponding message is displayed.

To use the power meter

1. Press the **Frequency Coupling** softkey to select the coupling option.
2. If you have selected the **Manual** coupling option, press the **Frequency Manual** softkey to enter the frequency of the signal which power you want to measure.
3. Press the **Unit/Scale** softkey to set the unit for the power result display.

4. If you have selected dB or % as units (relative display), define a reference value:
 - To set the currently measured power as a reference value, press the **Meas->Ref** softkey.
 - To enter a reference value, press the **Reference Value** softkey.
5. Press the **Meas Time/Average** softkey to select the measurement time. For recommendations refer to the **Meas Time/Average** softkey description.

Softkeys of the power meter menu

The following table shows all softkeys available in the power meter menu. It is possible that your instrument configuration does not provide all softkeys. If a softkey is only available with a special option, model or (measurement) mode, this information is delivered in the corresponding softkey description.

For the description of the other main softkeys refer to "[Optional softkeys of the menu menu](#)" on page 4.122.

Command
Power Meter On/Off
Frequency Manual
Frequency Coupling
Unit/Scale
Zero
Meas Time/Average
More ↓
Meas->Ref
Reference Value
Use Ref Lev Offset
Number of Readings
Ext Power Trigger
Trigger Level

Power Meter On/Off

Switches the power measurement on or off.

→ Remote: PMET ON

Frequency Manual

Opens an edit dialog box to enter the frequency of the signal to be measured. The power sensor has a memory with frequency-dependent correction factors. This allows extreme accuracy for signals of a known frequency.

→ Remote: PMET:FREQ 1GHZ

Frequency Coupling

Opens the **Frequency Coupling** dialog box to select the coupling option. The frequency can be coupled automatically to the center frequency of the instrument or to the frequency of marker 1, or manually to a set frequency (see **Frequency Manual** softkey).

→ Remote: PMET:FREQ:LINK CENT

Unit/Scale

Opens the **Unit/Scale** dialog box to select the unit with which the measured power is to be displayed.

If dB or % is selected, the display is relative to a reference value that is defined with either the Meas->Ref softkey or the **Reference Value** softkey.

→ Remote: UNIT:PMET:POW DBM

→ Remote: UNIT:PMET:POW:RAT DB

Zero

Starts zeroing of the power sensor. For details on the zeroing process refer to "[To zero the power meter](#)" on page 4.176.

→ Remote: CAL:PMET:ZERO:AUTO ONCE;*WAI

Meas Time/Average

Opens the **Meas Time** dialog box to select the measurement time or to switch to manual averaging mode. In general, results are more precise with longer measurement times. The following settings are recommended for different signal types to obtain stable and precise results:

Short Stationary signals with high power (> -40dBm), because they require only a short measurement time and short measurement time provides the highest repetition rates.

Normal Signals with lower power or of modulated signals

Long Signals at the lower end of the measurement range (<-50 dBm) or signals with lower power to minimize the influence of noise.

Manual Switches to manual averaging mode. The average count is set with the **Number of Readings** softkey.

This parameter is available from firmware version 1.70.

→ Remote: PMET:MTIM SHOR

→ Remote: PMET:MTIM:AVER ON

Meas->Ref

Sets the currently measured power as a reference value for the relative display. The reference value can also be set manually via the **Reference Value** softkey.

→ Remote: CALC:PMET:REL:AUTO ONCE

Reference Value

Opens an edit dialog box to enter a reference value for relative measurements in the unit dBm.

→ Remote: CALC:PMET:REL -30DBM

Use Ref Lev Offset

If activated, takes the reference level offset set for the analyzer (**Ref Level Offset** softkey) into account for the measured power. If deactivated, takes no offset into account.

This softkey is available from firmware version 1.50.

→ Remote: PMET:ROFF OFF

Number of Readings

Opens an edit dialog box to enter the number of readings (averagings) to be performed after a single sweep has been started. This softkey is only available if manual averaging is selected (**Meas Time/Average** softkey).

The values for the average count range from 0 to 256 in binary steps (1, 2, 4, 8,...). For average count = 0 or 1, one reading is performed. The averaging and sweep count of the trace menu are independent from this setting.

Results become more stable with extended average, particularly if signals with low power are measured. This setting can be used to minimize the influence of noise in the power meter measurement.

This softkey is available from firmware version 1.70.

→ Remote: PMET:MTIM:AVER:COUN 8

Ext Power Trigger

Activates the creation of a trigger signal in the power sensor. When pressing the softkey, the following softkeys of the power meter menu become unavailable: Unit/Scale, Reference Value, Use Ref Lev Offset and Number of Readings.

Pressing the softkey causes the transmission of the following remote commands to the power sensor:

```
*RST
SENS:AVER:STAT OFF
TRIG:MAST:STAT ON
TRIG:SOUR INT
TRIG:SLOP POS
TRIG:DTIM 100e-6
INIT:CONT ON
```

This softkey is only available in conjunction with a NRP-Z81 power sensor.

This softkey is available from firmware version 1.90.

→ Remote: SENS:PMET:TRIG ON

Trigger Level

Opens an edit dialog box to enter the trigger level.

This softkey is only available in conjunction with a NRP-Z81 power sensor.

This softkey is available from firmware version 1.90.

→ Remote: SENS:PMET:TRIG:LEV -10 dBm

Spectrogram Measurement (Option K14)

The Spectrogram Measurement option provides a graphical view of frequency and amplitude changes over a time interval. For display details refer to "[Spectrogram view](#)" on page 4.181.

Not all measurement types can be displayed in the Spectrogram view. If the Spectrogram Measurement option is active and a measurement cannot be displayed in form of a spectrogram, the softkey of the corresponding measurement is disabled.

If the Spectrogram view is active, all parameter settings set in the **Spectrum Analyzer** mode are kept, and vice versa.

This option is available from firmware version 1.60.

To open the spectrogram menu

1. Press the **MENU** key.
2. Press the **Spectrogram** softkey.

The spectrogram menu is displayed.

Menu and softkey description

- "[Softkeys of the spectrogram menu](#)" on page 4.183
- "[Softkeys of the sweep menu \(Spectrogram view\)](#)" on page 4.185
- "[Softkeys of the marker menu \(Spectrogram view\)](#)" on page 4.186
- "[Softkeys of the marker-> menu \(Spectrogram view\)](#)" on page 4.187

All other menus are provided as described for the base unit. For details refer to the corresponding menu descriptions.

To display help to a softkey, press the **HELP** key and then the softkey for which you want to display help. To close the help window, press the **ESC** key. For further information refer to section "How to use the Help System".

Further information

- "[Spectrogram view](#)" on page 4.181
- "[Markers and marker values](#)" on page 4.182
- "[Maximum number of frames](#)" on page 4.183

Spectrogram view

The Spectrogram view is divided into two panes: the spectrum analyzer result display (upper pane) and the spectrogram result display (lower pane).

- spectrum analyzer result display

As in **Spectrum Analyzer** mode, all traces are displayed and available. For trace 1, the **View** and **Blank** trace modes are not available.

During the measurement, always the current trace is displayed.

If no measurement is running, the trace to be displayed is selected via:

- the **Select Frame** softkey
- the edit dialog box for markers and delta markers (**MKR** key, **Marker 1/2/3/4** softkeys or **MKR->** key, **Select 1 2 3 4** Δ softkey)

The selected trace is displayed with its corresponding, activated markers (D2 in the example). The position of the markers activated for other traces is only displayed in the marker field (M1 in the example).

- spectrogram result display

In a Cartesian diagram, the chronological power distribution (y-axis) over a frequency or time range (x-axis) is displayed. The different levels are displayed in different colors.

Only the data of trace 1 is displayed in the spectrogram. The result display is build up by horizontal lines so-called frames, each representing a trace. The frames are sorted in chronological order: Starting from the current trace (frame 0) at the y-axis value zero, the last trace (frame -1), the trace before the last trace (frame -2), and so on, are displayed with increasing y-axis value. The maximum number of frames to be recorded is defined by the **History Depth** softkey.

A frame consists of a maximum of 501 measurement points. If more measured values than measurement points are available (set via the **Sweep Points** softkey), several measured values are combined in one measurement point using the selected detector (**Auto Peak** detector not available, for details on detectors refer to "[Detector overview](#)" on page 4.38).

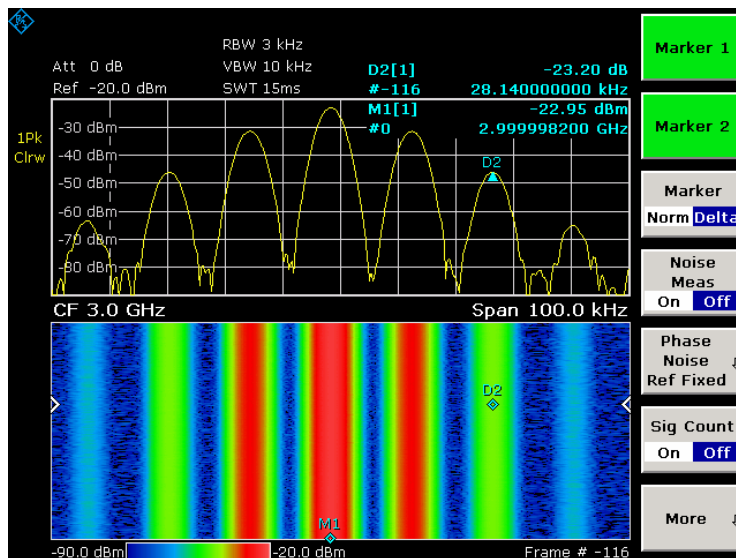

Fig. 4-22 Spectrogram (example)

A color map below the spectrogram shows the level and color assignment: the minimum level on the left (-101.0 dBm in the example), the maximum level on the right (-1.0 dBm in the example). The used colors are defined via the **Color** softkey. The level and color assignment is derived automatically from the levels.

Below the right corner of the spectrogram, the frame number is displayed (# 0 in the example). If the time stamp is activated, the time stamp instead of the frame number is displayed (for details refer to the **Time Stamp On/Off** softkey).

The position of a marker (rhomb symbol) is displayed in the spectrogram result display only if the marker is located in the visible area. If the marker is located outside the visible area, only its values are displayed in the marker field.

Markers and marker values

In the spectrum analyzer result display, the marker information of all activated markers is displayed in the marker field. Additional to the marker values of the base unit (for details see "[Using Markers and Delta Markers - MKR Key](#)" on page 4.48), the frame number is given (# 0 in the example).

```

M1[1]          -26.12 dBm
#0             2.083200000 GHz
D2[1]          -70.65 dB
#0             904.800000000 MHz

```

In the spectrogram result display, in maximum 4 markers and delta markers can be activated for different frames at the same time. To assign a marker to a frame, the edit marker dialog box is extended. Additionally to the marker value, the frame number must be defined.

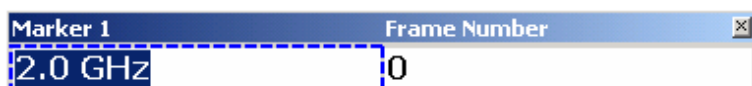

When the marker edit dialog box is opened, the **Marker 1** field is in edit mode. To change to the frame number field, use the **FIELD RIGHT** key.

If a marker is activated when the measurement is halted (**Continuous Sweep Start/Stop** softkey), the marker is set and visible in both result displays (provided that it is located in the visible area of the spectrogram result display). If the marker value or the frame number is altered, the new position is reflected in both result displays.

Maximum number of frames

The following table shows the correlation between the number of measurement points and the maximum number of frames stored in the history buffer:

Measurement points	Max. number of frames
≤ 501	20,000
1,001	12,488
2,001	6,247
4,001	3,124
8,001	1,562
16,001	781
32,001	391

Softkeys of the spectrogram menu

The following table shows all softkeys available in the spectrogram menu (**MENU** key). It is possible that your instrument configuration does not provide all softkeys. If a softkey is only available with a special option, model or (measurement) mode, this information is delivered in the corresponding softkey description.

For the description of the other main softkeys refer to "[Optional softkeys of the menu menu](#)" on page 4.122.

Command
Spectrogram On/Off
History Depth
Color
Maximize Size
Time Stamp On/Off

Spectrogram On/Off

Activates or deactivates the Spectrogram Measurement option.

→ Remote: CALC:SPEC ON

History Depth

Opens an edit dialog box to enter the number of frames to be stored in the history buffer. The maximum number of frames depends on the number of sweep points (**Sweep Points** softkey) and is determined according to "[Maximum number of frames](#)" on page 4.183.

If the history buffer is full, the oldest frame results are overwritten by the new ones.

→ Remote: CALC:SPEC:HDEP 1000

Color

Opens the **Frame Color** dialog box to select the frame color setting.

Color	RGB colors
Radar	black - green - white
Grayscale	black and white

→ Remote: CALC:SPEC:COL RAD

Maximize Size

Changes the screen layout.

Activated Enlarges the spectrogram result display and scales down the spectrum analyzer result display.

Deactivated Divides the screen in two equally sized panes.

→ Remote: CALC:SPEC:SIZE LARG

Time Stamp On/Off

Defines the displayed item in the right lower corner.

On The time stamp (system time of the sweep start) is displayed instead of the frame number.

Off The frame number is displayed.

→ Remote: CALC:SPEC:TST ON

Softkeys of the sweep menu (Spectrogram view)

The following table shows all softkeys available in the sweep menu of the Spectrogram Measurement option (**SWEEP** key). It is possible that your instrument configuration does not provide all softkeys. If a softkey is only available with a special option, model or (measurement) mode, this information is delivered in the corresponding softkey description.

Command
Continuous Sweep Start/Stop
Single Sweep
Select Frame
Sweeptime Manual
Sweeptime Auto
Sweep Count
More ↓
Sweep Points
Continue Frame On/Off
Frame Count
Spectrogram Clear

Continuous Sweep Start/Stop

→ Stops or continues the measurement in continuous sweep mode. The trace averaging is determined by the sweep count value (for details refer to the **Sweep Count** softkey in the trace menu of the base unit).

Continuous Sweep Start The measurement is stopped. Press the softkey to continue the measurement.

Continuous Sweep Stop The measurement is running. Press the softkey to stop the measurement.

→ Remote: INIT:CONT ON

Single Sweep

For details refer to the **Single Sweep** softkey in the sweep menu of the base unit.

Select Frame

Opens an edit dialog box to select the frame if no measurement is running. If the active marker value is altered, the value of the selected frame is updated accordingly.

During a measurement, the value is fixed to 0 and this softkey is not available.

→ Remote: CALC:SPEC:FRAM:SEL -10

Sweeptime Manual

For details refer to the **Sweeptime Manual** softkey in the sweep menu of the base unit.

Sweptime Auto

For details refer to the **Sweptime Auto** softkey in the sweep menu of the base unit.

Sweep Count

For details refer to the **Sweep Count** softkey in the sweep menu of the base unit.

Sweep Points

For details refer to the **Sweep Points** softkey in the sweep menu of the base unit.

Continue Frame On/Off

Determines whether the results of the last measurement are deleted before starting a new measurement.

On Repeats the single sweep measurement without deleting the spectrogram results of the last measurement. One of the following trace modes is to be used: **Max Hold, Min Hold, Average**.

Off Deletes the last measurement results before performing a single sweep measurement.

This softkey takes effect in single sweep mode only.

→ Remote: CALC:SPEC:CONT ON

Frame Count

Opens an edit dialog box to enter the number of frames to be recorded in a single sweep measurement, whereas the **Sweep Count** entry determines how many sweeps are combined according to the selected trace mode (**Max Hold** or **Min Hold**) in one trace (frame). The maximum number of frames is determined according to "[Maximum number of frames](#)" on page 4.183.

This softkey takes effect in single sweep mode only.

→ Remote: CALC:SPEC:FRAM:COUN 200

Spectrogram Clear

Deletes the spectrogram result display and the history buffer.

→ Remote: CALC:SPEC:CLE

Softkeys of the marker menu (Spectrogram view)

Additional to the functionality of the base unit (for details refer to "[Softkeys of the marker menu](#)" on page 4.52), the edit dialog box for markers and delta markers is extended. For details refer to "[Markers and marker values](#)" on page 4.182.

Softkeys of the marker-> menu (Spectrogram view)

The following table shows all softkeys available in the marker-> menu of the Spectrogram Measurement option (**MKR->** key). It is possible that your instrument configuration does not provide all softkeys. If a softkey is only available with a special option, model or (measurement) mode, this information is delivered in the corresponding softkey description.

Menu / Command	Command
Select 1 2 3 4 Δ	
Peak	
Next Peak	
Search Mode ↓	Next Peak X Search < abs >
	Next Peak Y Search up/abs/dn
	Next Min X Search < abs >
	Next Min Y Search up/abs/dn
	Marker Search Type
	Select Search Area
Center =Mkr Freq	
Ref Lvl =Mkr Lvl	
More ↓	
Select 1 2 3 4 Δ	
Min	
Next Min	
Search Mode ↓	identical to Search Mode menu above
Search Limits ↓	Left Limit
	Right Limit
	Threshold
	Search Lim Off
Peak Excursion	
Exclude LO	

Select 1 2 3 4 Δ

The edit dialog box for markers and delta markers is extended as described in "[Markers and marker values](#)" on page 4.182.

For further details refer to the **Select 1 2 3 4 Δ** softkey in the marker-> menu of the base unit.

- Remote: CALC:MARK2:SPEC:FRAM -20
- Remote: CALC:DELT3:SPEC:FRAM -50

Peak

Sets the active marker/delta marker to the highest maximum according to the selected search type (**Marker Search Type** softkey).

- Remote: CALC:MARK:MAX (in x direction)
 - Remote: CALC:DELT:MAX (in x direction)
 - Remote: CALC:MARK:SPEC:Y:MAX (y direction)
 - Remote: CALC:DELT4:SPEC:Y:MAX (y direction)
 - Remote: CALC:MARK2:SPEC:XY:MAX (xy direction)
 - Remote: CALC:DELT2:SPEC:XY:MAX (xy direction)
-

Next Peak

Sets the active marker/delta marker to the next maximum according to the mode selected using the **Search Mode** softkey. For the **XY Search (Marker Search Type)** softkey, this softkey is not available.

- Remote: for search in x direction see **Next Peak X Search < abs >** softkey
 - Remote: for search in y direction see **Next Peak Y Search up/abs/dn** softkey
-

Search Mode

Displays a submenu to define the search mode for the **Next Peak** and **Next Min** softkeys.

Next Peak X Search < abs >

Selects the mode of the **Next Peak** softkey, if the X Search is selected (**Marker Search Type** softkey). Three settings are available:

- < Sets the active marker/delta marker to the next maximum left to the marker of the selected frame.
- abs Sets the active marker/delta marker to the next lower maximum of the selected frame.
- > Sets the active marker/delta marker to the next maximum right to the marker of the selected frame.

- Remote: CALC:MARK2:MAX:LEFT (<)
 - Remote: CALC:DELT:MAX:LEFT (<)
 - Remote: CALC:MARK:MAX:RIGH (>)
 - Remote: CALC:DELT:MAX:RIGH (>)
 - Remote: CALC:MARK2:MAX:NEXT (abs)
 - Remote: CALC:DELT2:MAX:NEXT (abs)
-

Next Peak Y Search up/abs/dn

Selects the mode of the **Next Peak** softkey, if the Y Search is selected (**Marker Search Type** softkey). Three settings are available:

- up Sets the active marker/delta marker to the next maximum above the current marker position (constant x-axis value).

- abs Sets the active marker/delta marker to the next lower maximum in y-axis direction (constant x-axis value).
- dn Sets the active marker/delta marker to the next maximum below the current marker position (constant x-axis value).

- Remote: CALC:MARK2:SPEC:Y:MAX:ABOV (up)
- Remote: CALC:DELT2:SPEC:Y:MAX:ABOV (up)
- Remote: CALC:MARK:SPEC:Y:MAX:NEXT (abs)
- Remote: CALC:DELT4:SPEC:Y:MAX:NEXT (abs)
- Remote: CALC:MARK3:SPEC:Y:MAX:BEL (dn)
- Remote: CALC:DELT3:SPEC:Y:MAX:BEL (dn)

Next Min X Search < abs >

Selects the mode of the **Next Min** softkey, if the X Search is selected (**Marker Search Type** softkey). Three settings are available:

- < Sets the active marker/delta marker to the next minimum left to the marker of the selected frame.
- abs Sets the active marker/delta marker to the next higher minimum of the selected frame.
- > Sets the active marker/delta marker to the next minimum right to the marker of the selected frame.

- Remote: CALC:MARK2:MIN:LEFT (<)
- Remote: CALC:DELT:MIN:LEFT (<)
- Remote: CALC:MARK:MIN:RIGH (>)
- Remote: CALC:DELT:MIN:RIGH (>)
- Remote: CALC:MARK2:MIN:NEXT (abs)
- Remote: CALC:DELT2:MIN:NEXT (abs)

Next Min Y Search up/abs/dn

Selects the mode of the **Next Min** softkey, if the Y Search is selected (**Marker Search Type** softkey). Three settings are available:

- up Sets the active marker/delta marker to the next minimum above the current marker position (constant x-axis value).
- abs Sets the active marker/delta marker to the next higher minimum in y-axis direction (constant x-axis value).
- dn Sets the active marker/delta marker to the next minimum below the current marker position (constant x-axis value).

- Remote: CALC:MARK2:SPEC:Y:MIN:ABOV (up)
- Remote: CALC:DELT2:SPEC:Y:MIN:ABOV (up)
- Remote: CALC:MARK:SPEC:Y:MIN:NEXT (abs)
- Remote: CALC:DELT4:SPEC:Y:MIN:NEXT (abs)
- Remote: CALC:MARK3:SPEC:Y:MIN:BEL (dn)
- Remote: CALC:DELT3:SPEC:Y:MIN:BEL (dn)

Marker Search Type

Displays the **Marker Search Type** dialog box to select the search direction:

- X Search** The selected frame is searched for peaks (**Next Peak X Search < abs >** softkey) or minima (**Next Min X Search < abs >** softkey).
 - Y Search** The frames are searched with constant x-axis value for peaks (**Next Peak Y Search up/abs/dn** softkey) or minima (**Next Min Y Search up/abs/dn** softkey).
 - XY Search** All frames are searched in x and y-axis direction for peaks or minima. Only the absolute search mode is available.
-

Select Search Area

Displays the **Marker Search Area** dialog box to select the search area:

- Visible** The search takes only place in the area displayed in the Spectrogram view.
- Memory** The search takes place in the whole data range stored in the history buffer.

- Remote: CALC:MARK2:SPEC:SAR MEM
 - Remote: CALC:DELT2:SPEC:SAR MEM
-

Center =Mkr Freq (span > 0)

For details refer to the **Center =Mkr Freq** softkey in the marker-> menu of the base unit.

Ref Lvl =Mkr Lvl

For details refer to the **Ref Lvl =Mkr Lvl** softkey in the marker-> menu of the base unit.

Min

Sets the active marker/delta marker to the highest minimum according to the selected search type (**Marker Search Type** softkey).

For further details refer to the **Min** softkey in the marker-> menu of the base unit.

- Remote: CALC:MARK:MIN (in x direction)
 - Remote: CALC:DELT:MIN (in x direction)
 - Remote: CALC:MARK:SPEC:Y:MIN (y direction)
 - Remote: CALC:DELT4:SPEC:Y:MIN (y direction)
 - Remote: CALC:MARK3:SPEC:XY:MIN (xy direction)
 - Remote: CALC:DELT3:SPEC:XY:MIN (xy direction)
-

Next Min

Sets the active marker/delta marker to the next minimum according to the mode selected using the **Search Mode** softkey. For the **XY Search (Marker Search Type)** softkey, this softkey is not available.

- Remote: for search in x direction see **Next Min X Search < abs >** softkey
 - Remote: for search in y direction see **Next Min Y Search up/abs/dn** softkey
-

Search Limits

For details refer to the **Search Limits** softkey in the marker-> menu of the base unit.

Left Limit

For details refer to the **Left Limit** softkey in the marker-> menu of the base unit.

Right Limit

For details refer to the **Right Limit** softkey in the marker-> menu of the base unit.

Threshold

For details refer to the **Threshold** softkey in the marker-> menu of the base unit.

Search Lim Off

For details refer to the **Search Lim Off** softkey in the marker-> menu of the base unit.

Peak Excursion

For details refer to the **Peak Excursion** softkey in the marker-> menu of the base unit.

Exclude LO

For details refer to the **Exclude LO** softkey in the marker-> menu of the base unit.

Cable TV Measurements (Option K20)

The Cable TV Measurements option provides ready-made measurements for analog and digital TV signals where most of the parameters are set automatically. Thus the measurements can be carried out fast and with a minimum of effort.

Averaging can be applied to the measurement results. If the results are presented in a table, only the values in the table are averaged, not the trace itself. For details refer to "[Setting Traces - TRACE Key](#)" on page 4.35. Measurement specific settings as signal levels, limits etc. are saved using the save / recall function described in section "Instrument Functions - Basic Settings", "Instrument Setup and Interface Configuration - SETUP Key".

This option is available from firmware version 1.30.

To open the Cable TV Analyzer menu

- If the **Cable TV Analyzer** mode is not the active measurement mode, press the **MODE** key and activate the **Cable TV Analyzer** option.
- If the **Cable TV Analyzer** mode is already active, press the **MENU** key.
The Cable TV Analyzer menu is displayed. .

Menu and softkey description

- "[Softkeys of the Cable TV Analyzer menu](#)" on page 4.211
- "[Softkeys of the frequency menu \(Cable TV Analyzer mode\)](#)" on page 4.214
- "[Softkeys of the amplitude menu \(Cable TV Analyzer mode\)](#)" on page 4.216
- "[Softkeys of the trace menu \(Cable TV Analyzer mode\)](#)" on page 4.217
- "[Softkeys of the measurement menu \(Cable TV Analyzer mode\)](#)" on page 4.218

The bandwidth, span, trigger and lines menus are not available in the **Cable TV Analyzer** mode. All other menus are provided as described for the base unit. For details refer to the corresponding menu descriptions.

To display help to a softkey, press the **HELP** key and then the softkey for which you want to display help. To close the help window, press the **ESC** key. For further information refer to section "How to use the Help System".

Further information

- "[Information in the status bar](#)" on page 4.198
- "[Channel tables](#)" on page 4.198
- "[Modulation standards](#)" on page 4.199
- "[Signal level](#)" on page 4.199
- "[Attenuation adjustment](#)" on page 4.199
- "[Labels used in the measurement displays](#)" on page 4.200
- "[Short list of cable TV terms and abbreviations](#)" on page 4.200

Tasks

- ["To edit a channel table"](#) on page 4.194
- ["To create a channel table"](#) on page 4.195
- ["To copy a channel table"](#) on page 4.195
- ["To create a new modulation standard"](#) on page 4.195
- ["To edit a modulation standard"](#) on page 4.196
- ["To copy a modulation standard"](#) on page 4.197
- ["To perform a measurement using a channel table"](#) on page 4.197
- ["To perform a measurement without a channel table"](#) on page 4.197

Measurements overview

All measurements can be performed with or without using a channel table (see also ["To perform a measurement using a channel table"](#) on page 4.197 and ["To perform a measurement without a channel table"](#) on page 4.197). In this section, the measurements are performed using a channel table. For every measurement type, a short introduction is given. For a more detailed description on every measurement type refer to chapter "Advanced Measurement Examples".

The measurements are divided into three groups:

analog TV	Using an analog modulation standard, the measurement of one single channel is performed.
digital TV	Using a digital modulation standard, the measurement of one single channel is performed.
TV analyzer	Measurements on the entire TV network, i.e. several or all channels, are performed.

For detailed information on the softkeys provided for each measurement type, refer to ["Softkeys of the measurement menu \(Cable TV Analyzer mode\)"](#) on page 4.218.

The following measurement types are provided:

- analog TV measurements:
 - ["Spectrum"](#) on page 4.201
 - ["Carriers"](#) on page 4.201
 - ["C/N"](#) on page 4.202
 - ["CSO"](#) on page 4.203
 - ["CTB"](#) on page 4.204
 - ["Video Scope"](#) on page 4.205
 - ["Vision Modulation"](#) on page 4.205
 - ["Hum"](#) on page 4.206
- digital TV measurements:
 - ["Spectrum"](#) on page 4.206
 - ["Overview"](#) on page 4.207
 - ["Constellation Diagram \(Modulation Analysis\)"](#) on page 4.207
 - ["Modulation Errors \(Modulation Analysis\)"](#) on page 4.208

- "Echo Pattern (Channel Analysis)" on page 4.208
- "Channel Power" on page 4.209
- "APD" on page 4.209
- "CCDF" on page 4.210
- TV analyzer measurement:
 - "Tilt" on page 4.210

To edit a channel table

1. Press the **Channel Setup** softkey.

The **Channel Tables** dialog box is displayed.

If a measurement is running, the channel table used in the measurement (so-called active channel table) is the channel table in focus. For further details refer also to "Channel tables" on page 4.198.

2. In the **Channel Tables** dialog box, focus the channel table you want to edit.
3. Press the **Edit** softkey.

The **Channel Table** dialog box and the edit submenu is displayed. Each line in the channel table represents one channel.

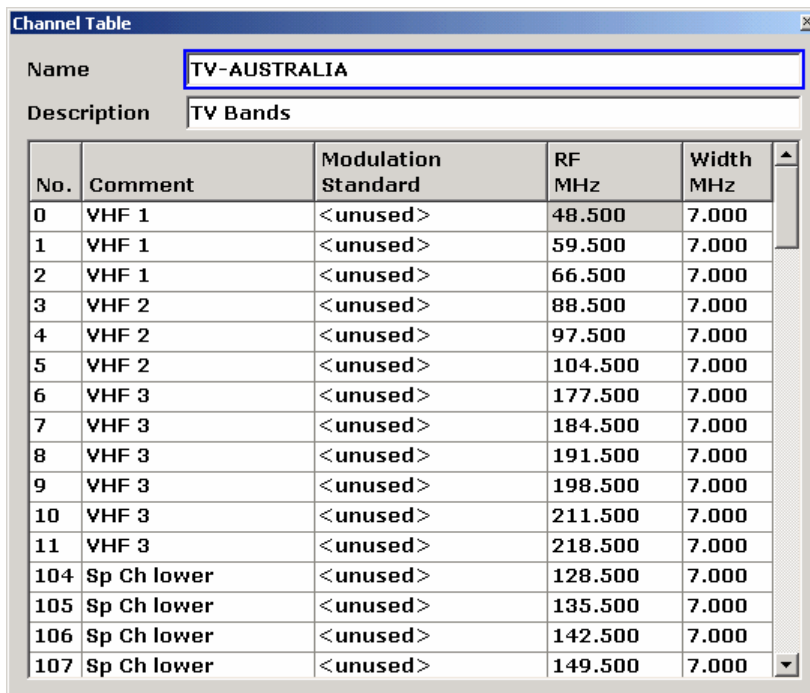

The screenshot shows a dialog box titled "Channel Table" with a close button (X) in the top right corner. It contains two input fields: "Name" with the value "TV-AUSTRALIA" and "Description" with the value "TV Bands". Below these fields is a table with the following data:

No.	Comment	Modulation Standard	RF MHz	Width MHz
0	VHF 1	<unused>	48.500	7.000
1	VHF 1	<unused>	59.500	7.000
2	VHF 1	<unused>	66.500	7.000
3	VHF 2	<unused>	88.500	7.000
4	VHF 2	<unused>	97.500	7.000
5	VHF 2	<unused>	104.500	7.000
6	VHF 3	<unused>	177.500	7.000
7	VHF 3	<unused>	184.500	7.000
8	VHF 3	<unused>	191.500	7.000
9	VHF 3	<unused>	198.500	7.000
10	VHF 3	<unused>	211.500	7.000
11	VHF 3	<unused>	218.500	7.000
104	Sp Ch lower	<unused>	128.500	7.000
105	Sp Ch lower	<unused>	135.500	7.000
106	Sp Ch lower	<unused>	142.500	7.000
107	Sp Ch lower	<unused>	149.500	7.000

The channels are displayed as they are entered and are not sorted automatically. If you prefer the entries ordered with respect to their channel number, enter the channels accordingly.

4. In the **Name** and **Description** field, edit the name and the description for the channel table via the keypad.

If the name of a channel table is changed, the channel table with the old name is not overwritten but retained, and a new channel table is created additionally.

In the title bar, ***(unsaved changes)** is displayed.

5. To edit an existing channel:

- In the **No.** and **Comment** column, edit the channel number and a comment for the channel via the keypad.

- In the **Modulation Standard** column, open the list of all available modulation standards via the **ENTER** key and select a modulation standard from the list. If you want to create, edit or view a modulation standard, press the **Modulation Options** softkey. For further information refer to "[To create a new modulation standard](#)" on page 4.195.
 - In the **RF MHz** column, set an RF value. The RF represents the characteristic frequency of a channel. Its interpretation depends on the modulation standard, e.g. for analog TV. For detailed information refer to the **RF** softkey on page 4.214.

If the modulation standard is changed from an analog to a digital one, the RF frequency is changed automatically. Therefore it is recommended to proceed in the described order, i.e. to set the modulation standard first.
 - In the **Width MHz** column, set a width value.
6. To create a new channel:
- Set the focus on a channel and press the **Copy Channel** softkey.
 - Change the entries of the channel as desired.
7. To delete a channel, press the **Delete Channel** softkey.
8. To leave the whole channel table without saving the changes, press the **Discard Changes** softkey.
9. To save your changes, press the **Save Changes** softkey.
- If the channel table contains invalid entries, an error message is displayed and saving is denied.

To create a channel table

1. In the **Channel Setup** submenu, press the **New** softkey to create a new channel table. For further details refer also to "[Channel tables](#)" on page 4.198.
2. Continue as described in "[To edit a channel table](#)" on page 4.194, step 4.

To copy a channel table

1. Press the **Channel Setup** softkey. For further details refer also to "[Channel tables](#)" on page 4.198.
2. In the **Channel Tables** dialog box, focus the channel table you want to copy.
3. Press the **Copy** softkey.
4. Continue as described in "[To edit a channel table](#)" on page 4.194, step 4.

To create a new modulation standard

1. In the **Channel Setup** submenu, press the **Edit**, **New**, or **Copy** softkey.
2. In the **Modulation Options** submenu, press the **New** softkey.

The **Modulation Standard Options** dialog box is displayed. As soon as you change entries, in the title bar, ***(unsaved changes)** is displayed.
3. Enter a name for the modulation standard. It is recommended to include the TV standard in the name, e.g. XY_DVB-C 16QAM.

If a modulation standard with the entered name already exists, the name is not accepted and a message box is displayed. The input field remains editable.
4. Select the **Signal Type**. Depending on this setting, the fields and entries of the **New Modulation Standard** dialog box are configured. Therefore it is recommended to proceed in the described order.
5. For the **Analog TV** signal type, define the following parameters:

TV standard, sound system, group delay, color system, bar line, quiet line, sideband position. The entries that can be selected may depend on the setting of the previous parameter.

For every parameter a default value is set. Change this setting if necessary.

The screenshot shows the 'Modulation Standard Options' dialog box with the following settings:

- Name: Analog Test
- Signal Type: Analog TV
- TV Standard: B/G
- Sound System: FM 5.5 / FM 5.742
- Group Delay: General
- Color System: PAL
- Bar Line: Field: 1, Line: 18, Type: CCIR17
- Quiet Line: Field: 1, Line: 22
- Sideband Position: Normal

6. For the **Digital TV** signal type, define the following parameters:

TV standard, constellation, symbol rate, roll-off, sideband position. The entries that can be selected may depend on the setting of the previous parameter.

The screenshot shows the 'Modulation Standard Options' dialog box with the following settings:

- Name: Digital Test
- Signal Type: Digital TV
- TV Standard: QAM J83/A (DVB-C Europe)
- Constellation: 64QAM
- Symbol Rate: 6.9 MSymb/s
- Roll-Off: 0.150
- Sideband Position: Auto

- Press the previous key twice to go back to the **Channel Table** dialog box.
- Press the **Save Changes** softkey to save the changes.
The new modulation standard can be used for any channel.
- To discard the changes, press the **Discard Changes** softkey.

To edit a modulation standard

- In the **Channel Setup - Edit / New / Copy** submenu, press the **Modulation Options** softkey.
In the **Modulation Standards** dialog box, all modulation standards defined for this channel table are displayed.
- In the **Modulation Standards** dialog box, set the focus on the modulation standard you want to edit.
- Press the **Edit** softkey.
The **Modulation Standard Options** dialog box is displayed.
- For further instructions see "[To create a new modulation standard](#)" on page 4.195.

To copy a modulation standard

1. Press the **Channel Setup** softkey.
2. In the **Channel Tables** dialog box, focus the channel table that contains the modulation standard you want to copy.
3. Press the **Copy** softkey (for further details see "[To create a channel table](#)" on page 4.195).
4. Enter a name for the copied channel table.
5. If you want to alter the channel table, continue as described in "[To edit a channel table](#)" on page 4.194, step 4.
6. If you want to alter the modulation standard, press the **Modulation Options** softkey and then the **Edit** softkey (for further details see "[To create a new modulation standard](#)" on page 4.195).

To perform a measurement using a channel table

1. Press the **Channel Setup** softkey.
The **Channel Tables** dialog box is displayed.
2. Select the channel table you want to use for the measurement and press the **ENTER** key or the **Activate** softkey.
If no adequate channel table is available, you can edit or create a channel table, or perform the measurement without a channel table (For details refer to "[To edit a channel table](#)" on page 4.194, "[To create a channel table](#)" on page 4.195 or "[To perform a measurement without a channel table](#)" on page 4.197).
3. Press the **MEAS** key.
4. In the measurement menu, press the softkey for the measurement you want to perform.
5. Set up the measurement as described for every measurement type in section "[Measurements](#)" on page 4.193.
6. Press the **RUN** key to start the measurement.

To perform a measurement without a channel table

1. Press the **Channel Setup** softkey.
The **Channel Tables** dialog box is displayed.
2. Select no channel table < none > and press the **ENTER** key or the **Activate** softkey.
3. Press the **MEAS** key.
4. In the measurement menu, press the **Analog TV** or **Digital TV** softkey.
5. Press the softkey for the measurement you want to perform.
6. Press the **Analog TV Settings** or **Digital TV Settings** softkey to setup the modulation parameters.
The **Analog TV Settings** or **Digital TV Settings** dialog box is displayed.
7. Enter the parameters for the measurement.
 - analog TV: for details refer to the **Analog TV Settings** softkey in the analog TV measurement menu.
 - digital TV: for details refer to the **Digital TV Settings** softkey in the digital TV measurement menu.
8. Press the **Adjust Attenuation** softkey to set the signal level appropriately.
9. Press the **RUN** key to start the measurement.

Information in the status bar

The status bar provides valuable information for working with the application. The information is supplied context-sensitively and always refers to the graphical user interface element in focus. The following types of information are displayed:

- possible range for a parameter
- description what to do
- hints
- warnings
- information on synchronization

Channel tables

Channel tables are lists of channels, as they occur in a cable TV network. They provide a quick access to the channels to be analyzed. Depending on its designation, a channel table can contain all channels of a cable TV network or it can be restricted to a subset of all available channels, e.g. to all digital DVB-C channels of the cable TV network.



In the **Channel Tables** dialog box, all available channel tables are sorted in alphabetic order. The name of a channel table displayed in the list corresponds to the file name of the channel table, excluding the file extension (*.cht).

The first list entry is **< none >**. If this entry is selected, no channel table is used. This can be useful for measurements where no appropriate channel table is available, or if the Cable TV Measurements option (K20) is used in a R&D laboratory. The Tilt measurement is not possible if no channel table is used. For a step-by-step instruction refer to ["To perform a measurement without a channel table"](#) on page 4.197.

Some channel tables are provided with the option. In these channel tables, all modulation standards are set to **< unused >** (for further details refer to ["Modulation standards"](#) on page 4.199). Based on this set, you can customize your own channel tables. Use the **Restore Default Tables** softkey to restore the provided channel tables.

Modulation standards

A modulation standard is a set of parameters defining the modulation properties of a TV signal (as used in a TV channel). The signal type is the characteristic parameter of this set. Modulation standards are defined for every channel table individually. As a maximum, 40 modulation standards can be created per channel table. If, in a channel table, the modulation standard of a channel is set to **< unused >**, no modulation standard is defined for this channel and therefore no measurements can be performed for this channel.

If no channel table **< none >** is activated, a default modulation standard can be edited and changed via the **Analog TV Settings** or **Digital TV Settings** softkey, but these changes are not saved permanently. Pressing the **PRESET** key restores the default settings.

Signal level

The signal level represents the expected RMS (digital TV) or peak (analog TV) channel power. This power is only valid for one single channel, which is the current measurement channel. The signal level is not identical to the level of the signal fed into the R&S FSL's RF input. This signal may consist of many TV channels and hence have a much higher total power than the current channel to be investigated.

In most measurements the signal level determines the upper horizontal display line. The signal level value is related to the reference level by a constant offset. The reference level value is the maximum value the AD converter can handle without distortion of the measured value. The signal level can either be entered via the **Signal Lvl** key or by using the auto scale function (e.g. **Auto Range** softkey in the Tilt measurement).

Attenuation adjustment

To get valid measurement results it is very important to set the R&S FSL's hardware, i.e. the attenuator and the preamplifier, in a reasonable way. This can either be done manually or by relying on the **Adjust Attenuation** softkey. Apart from the hardware setting, the displayed grid depends on the signal level of the signal present in the current measurement channel.

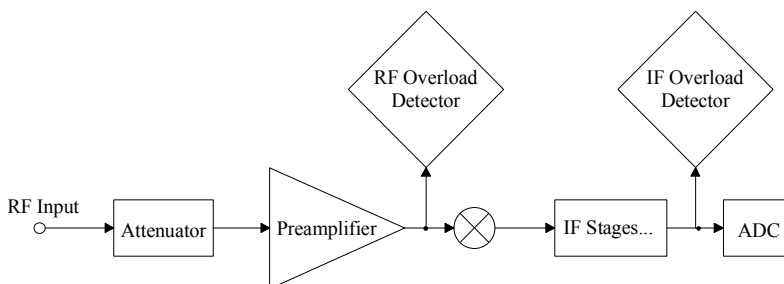

Fig. 4-23 R&S FSL hardware overview (only relevant parts for attenuation adjustment)

Fig. 4-23 shows the R&S FSL's hardware. It only comprises blocks that effect the level settings described in this section. The signal from the device under test, e.g. a single cable TV transmitter or a test point of a cable TV network with many channels, is plugged into the R&S FSL's RF input. The level of the signal is reduced by the electronic attenuator or increased by the preamplifier (option B22 required). Then the signal is fed into the first mixer.

The level of this signal is typically referred to as mixer level. The mixer level is a very crucial parameter. If the mixer level is too high the mixer will be overloaded. As a result, non-linear effects are produced, e.g. intermodulation products, and the intermodulation products (e.g. CTB or CSO) of the device under test can not be distinguished from those of the R&S FSL's mixer. To reveal this, the R&S FSL's hardware has two overload detectors. The RF overload detector reports a mixer overload and the IF overload detector indicates an overload of the analog to digital converter (ADC). The combination of the results of both detectors control the overload message **OVL** displayed on the R&S FSL's screen. Increasing the attenuation reduces the signal to noise ratio but also reduces the mixer's non-linear

effects. For cable TV measurements such as [CTB](#), [CSO](#), [CCDF](#), and [APD](#) that measure non-linearities, it is recommended to choose a higher attenuation than for other measurements.

Attenuator setting	Preamplifier setting
30 dB	off
25 dB	off
20 dB	off
15 dB	off
10 dB	off
5 dB	off
0 dB	off
15 dB	on
10 dB	on
5 dB	on
0 dB	on

To adjust the attenuation manually, refer to the table above that lists reasonable combinations of attenuator and preamplifier settings. The maximum total attenuation is achieved with the setting of the first line. If you want to set the R&S FSL hardware manually you should start with the maximum attenuation and then reduce the total attenuation until an overload will be reported (**OVL** displayed on the screen). Depending on the intended measurement, you should then choose an attenuation of about one or two steps higher than the setting that caused an overload. Be aware, that the manual attenuator and the preamplifier setting is kept for all measurements. For further details refer to the **RF Atten Manual** and **Preamp On/Off** softkeys.

Alternatively, you can **automatically** adjust the attenuator and the preamplifier using the **Adjust Attenuation** softkey. The Cable TV Measurements option sets the optimum values for the measurement. If you change to another measurement, these values may be altered automatically in order to find the optimum setting (e.g. low noise or low distortion) for the chosen measurement.

Labels used in the measurement displays

Positions of special values are marked as vertical lines in the measurement display.

Label	Description
VC	Vision Carrier
SC1	Sound Carrier 1
SC2	Sound Carrier 2

Short list of cable TV terms and abbreviations

Term or abbreviation	Description
AM Amplitude Modulation	Analog modulation technique where the carrier amplitude contains the information.
bar line	see VITS
DVB-C Digital Video Broadcasting for Cable Systems	DVB-C uses single carrier QAM as modulation technique.
DVB-T Digital Video Broadcasting Terrestrial	DVB-T uses OFDM as modulation technique.

Term or abbreviation	Description
NTSC National Television System Committee	Technique for transmitting color information in analog TV systems. NTSC is for example adopted by the USA, Canada and Japan.
OFDM Orthogonal Frequency Division Multiplexing	Digital multicarrier modulation technique. OFDM is used in terrestrial TV networks, e.g. DVB-T systems.
PAL Phase Alternation Line	Technique for transmitting color information in analog TV systems used in many European countries.
QAM Quadrature Amplitude Modulation	Digital modulation technique, where both phase and amplitude carry information.
SECAM Système en Couleur avec Mémoire	Technique for transmitting color information in analog TV systems. SECAM is adopted by France, countries of the Eastern block and most Arabic countries.
VITS Vertical Interval Test Signal	Line of a TV picture where a special test signal is transmitted. VITS lines are used for in-service measurements (cf. Quiet Line, Bar Line). These lines are invisible, i.e. they are located before the first or after the last visible line of the TV picture.

Measurements

In this section, every measurement type is introduced by a short description and by a basic step-by-step instruction. Also a list with all parameters that can be altered is presented.

Spectrum - analog TV

This measurement gives an overview of the active measurement channel. The spectrum is displayed as a full screen trace. The following parameters can be set:

Parameter
channel number

The basic procedure is the following:

1. Press the **MEAS** key.
2. Press the **Analog TV** softkey.
3. Press the **Spectrum** softkey.
4. To adjust the input attenuator, press the **Adjust Attenuation** softkey.
5. Press the **RUN** key.

For a more detailed description of this measurement type refer to chapter "Advanced Measurement Examples".

Carriers - analog TV

This measurement determines the carrier powers (vision carrier, one or two sound carriers) and their frequencies in analog TV channels and compares them against limits. The sound carrier power frequencies are displayed relative to the measured vision carrier power frequency. The following parameters can be set:

Parameter
channel number
limits

The basic procedure is the following:

1. Press the **MEAS** key.
2. Press the **Analog TV** softkey.
3. Press the **Carriers** softkey.
4. To change the limits, press the **Edit Table** softkey.
5. To adjust the input attenuator, press the **Adjust Attenuation** softkey.
6. Press the **RUN** key.

For a more detailed description of this measurement type refer to chapter "Advanced Measurement Examples".

C/N - analog TV

This measurement determines the carrier-to-noise ratio. The measurement consists of two sub-measurements: reference power measurement and noise measurement. The following parameters can be set:

Parameter
reference power
measurement method (In-Service, Off-Service, Quiet Line)
measurement frequencies (CF, Span)
noise reference bandwidth
noise floor correction
limits

The basic procedure is the following:

1. Press the **MEAS** key.
2. Press the **Analog TV** softkey.
3. Press the **C/N** softkey.
4. To change the setting of the reference power:
 - Press the **Reference Power** softkey.
 - Press the **Reference Channel, Same as Meas Channel, or Manual Reference Power** softkey and, if necessary, enter a value.
5. To configure the measurement, press the **C/N Setup** softkey.

The **C/N Setup** dialog box is displayed.

- Under **Measurement Method**, activate one of the options. For details refer to the **C/N Setup** softkey in the measurement menu.
 - Only for **In-Service** and **Off-Service** measurement method: Under **Measurement Frequencies**, enter the center frequencies and span values. Set the span values relative to the vision carrier of the current measurement.
 - In the **Noise Reference Bandwidth** field, enter a number in order to change the default value.
 - If the DUT's noise is close to the noise of the spectrum analyzer, activate the **Noise Floor Correction** option.
6. To change the limits, press the **Edit Table** softkey.

7. To activate the carrier measurement with the next sweep, press the **Meas Carrier** softkey. Prerequisite is, that in the **C/N Setup** dialog box under **Measurement Methods** the **Off-Service** option is selected.
8. To adjust the input attenuator, press the **Adjust Attenuation** softkey.
9. Press the **RUN** key.
10. Only for **In-Service** and **Off-Service** measurement method: To measure in the next frequency span defined via the C/N setup, press the **Next Meas Frequency** softkey.

For a more detailed description of this measurement type refer to chapter "Advanced Measurement Examples".

CSO - analog TV

This measurement determines the carrier-to-second order beat ratio (CSO). The measurement consists of two sub-measurements: reference power measurement and beat measurement of second order intermodulation products. The following parameters can be set:

Parameter
reference power
measurement method (Off-Service, Quiet Line)
measurement frequencies (CF, Span)
noise floor correction
limits

The basic procedure is the following:

1. Press the **MEAS** key.
2. Press the **Analog TV** softkey.
3. Press the **CSO** softkey.
4. To change the setting of the reference power:
 - Press the **Reference Power** softkey.
 - Press the **Reference Channel, Same as Meas Channel**, or **Manual Reference Power** softkey and, if necessary, enter a value.
5. To configure the measurement, press the **CSO Setup** softkey.

The **CSO Setup** dialog box is displayed.

 - Under **Measurement Method**, activate one of the options. For details refer to the **CSO Setup** softkey in the measurement menu.
 - Only for **Off-Service** measurement method: Under **Measurement Frequencies**, enter the center frequencies and span values.
 - If the DUT's noise is close to the noise of the spectrum analyzer, activate the **Noise Floor Correction** option.
6. To change the limits, press the **Edit Table** softkey.
7. To activate the carrier measurement with the next sweep, press the **Meas Carrier** softkey. Prerequisite is, that in the **CSO Setup** dialog box under **Measurement Methods** the **Off-Service** option is selected.
8. To adjust the input attenuator, press the **Adjust Attenuation** softkey.

9. Press the **RUN** key.
10. Only for **Off-Service** measurement method: To measure in the next frequency span defined via the C/N setup, press the **Next Meas Frequency** softkey.

For a more detailed description of this measurement type refer chapter "Advanced Measurement Examples".

CTB - analog TV

This measurement determines the carrier-to-composite triple beat ratio (CTB). The measurement consists of two sub-measurements: reference power measurement and beat measurement of third order intermodulation products. The following parameters can be set:

Parameter
reference power
measurement frequencies (CF, Span)
noise floor correction
limits

The basic procedure is the following:

1. Press the **MEAS** key.
2. Press the **Analog TV** softkey.
3. Press the **CTB** softkey.
4. To change the setting of the reference power:
 - Press the **Reference Power** softkey.
 - Press the **Reference Channel, Same as Meas Channel**, or **Manual Reference Power** softkey and, if necessary, enter a value.
5. To configure the measurement, press the **CTB Setup** softkey.

The **CTB Setup** dialog box is displayed.

 - Under **Measurement Frequencies**, enter the center frequencies and span values.
 - If the DUT's noise is close to the noise of the spectrum analyzer, activate the **Noise Floor Correction** option.
6. To change the limits, press the **Edit Table** softkey.
7. To adjust the input attenuator, press the **Adjust Attenuation** softkey.
8. Press the **RUN** key.
9. To measure in the next frequency span defined via the C/N setup, press the **Next Meas Frequency** softkey.

For a more detailed description of this measurement type refer to chapter "Advanced Measurement Examples".

Video Scope - analog TV

This measurement determines the luminance signal as a function of the time. The following parameters can be set:

Parameter
channel number
field
line

The basic procedure is the following:

1. Press the **MEAS** key.
2. Press the **Analog TV** softkey.
3. Press the **Video Scope** softkey.
4. For the TV standard **M** in combination with another color system than **PAL**, press the **Field 1/2** softkey to select field 1 or 2.
5. Press the **Line** softkey to enter the line number.
6. To change the sweep time, press the **Sweeptime Manual** softkey and enter a value.
7. To define a trigger offset, press the **Trigger Offset** softkey and enter a value.
8. To adjust the input attenuator, press the **Adjust Attenuation** softkey.
9. Press the **RUN** key.



The y-axis of the diagram is scaled in Volt for all TV standards except M. If the selected TV standard is M, the y-axis of the diagram is scaled in IRE.

For a more detailed description of this measurement type refer to chapter "Advanced Measurement Examples".

Vision Modulation - analog TV

This measurement determines the residual picture carrier and the modulation depth. The following parameters can be set:

Parameter
channel number
limits

The basic procedure is the following:

1. Press the **MEAS** key.
2. Press the **Analog TV** softkey.
3. Press the **Vision Modulation** softkey.
4. To change the limits, press the **Edit Table** softkey.

5. To adjust the input attenuator, press the **Adjust Attenuation** softkey.
6. Press the **RUN** key.

For a more detailed description of this measurement type refer to chapter "Advanced Measurement Examples".

Hum - analog TV

This measurement determines the hum values. The hum is a not-wanted amplitude modulation with a modulating frequency below 1 KHz and typically equal to the power line frequency or its harmonics. The following parameters can be set:

Parameter
channel number
limits

The basic procedure is the following:

1. Press the **MEAS** key.
2. Press the **Analog TV** softkey.
3. Press the **Hum** softkey.
4. To adjust the range of the y-axis, press the **Auto Range** softkey.
5. To change the limits, press the **Edit Table** softkey.
6. To adjust the input attenuator, press the **Adjust Attenuation** softkey.
7. Press the **RUN** key.

For a more detailed description of this measurement type refer to chapter "Advanced Measurement Examples".

Spectrum - digital TV

This measurement gives an overview of the active measurement channel. The spectrum is displayed as a full screen trace. The following parameters can be set:

Parameter
channel number

The basic procedure is the following:

1. Press the **MEAS** key.
2. Press the **Digital TV** softkey.
3. Press the **Spectrum** softkey.
4. To adjust the input attenuator, press the **Adjust Attenuation** softkey.
5. Press the **RUN** key.

For a more detailed description of this measurement type refer to chapter "Advanced Measurement Examples".

Overview - digital TV

This measurement determines the modulation accuracy of digitally modulated single carrier cable TV signals. The measurement results are displayed in a table: **MER (rms)** for the root mean square of the modulation error rate, **MER (peak)** for the peak of the modulation error rate, **EVM (rms)** for the root mean square of the error vector magnitude, **EVM (peak)** for the peak of the error vector magnitude, **Carrier Frequency Offset**, and **Symbol Rate Offset**. Less important result parameters are displayed in the result table of the [Modulation Errors \(Modulation Analysis\) - digital TV](#) measurement. The following parameters can be set:

Parameter
channel number
limits

The basic procedure is the following:

1. Press the **MEAS** key.
2. Press the **Digital TV** softkey.
3. Press the **Overview** softkey.
4. To magnify one parameter, press the **Zoom** softkey and activate the parameter. To go back to the default setting, activate **None**.
5. To change the limits, press the **Edit Table** softkey.
6. To adjust the input attenuator, press the **Adjust Attenuation** softkey.
7. Press the **RUN** key.

For a more detailed description of this measurement type refer to chapter "Advanced Measurement Examples".

Constellation Diagram (Modulation Analysis) - digital TV

This measurement displays the constellation diagram. The following parameters can be set:

Parameter
channel number

The basic procedure is the following:

1. Press the **MEAS** key.
2. Press the **Digital TV** softkey.
3. Press the **Modulation Analysis** softkey.
4. Press the **Const Diagram** softkey.
5. To zoom into one quadrant, press the **Zoom** softkey and activate the parameter. To go back to the general view, activate **None**.
6. To display the constellation diagram unchanged, while the I/Q samples are collected in the background, press the **Freeze** softkey. To switch back to the continual update the display, press the **Freeze** softkey again.
7. To adjust the input attenuator, press the **Adjust Attenuation** softkey.
8. Press the **RUN** key.

For a more detailed description of this measurement type refer to chapter "Advanced Measurement Examples".

Modulation Errors (Modulation Analysis) - digital TV

This measurement determines the modulation accuracy. The measurement results are displayed in a table: **Amplitude Imbalance** (amplification difference of I and Q signal caused by a non-ideal IQ modulator in the transmitter), **Quadrature Error** (phase offset relative to the ideal phase difference between the I and Q signal), **Carrier Suppression**, and **Phase Jitter** (root mean square of phase error). The more important result parameters are displayed in the result table of the [Overview - digital TV](#) measurement. The following parameters can be set:

Parameter
channel number
limits

The basic procedure is the following:

1. Press the **MEAS** key.
2. Press the **Digital TV** softkey.
3. Press the **Modulation Analysis** softkey.
4. Press the **Modulation Errors** softkey.
5. To magnify one parameter, press the **Zoom** softkey and activate the parameter. To go back to the default setting, activate **None**.
6. To change the limits, press the **Edit Table** softkey.
7. To adjust the input attenuator, press the **Adjust Attenuation** softkey.
8. Press the **RUN** key.

For a more detailed description of this measurement type refer to chapter "Advanced Measurement Examples".

Echo Pattern (Channel Analysis) - digital TV

This measurement determines the magnitude of the channel impulse response with respect to the corresponding time delay. The following parameters can be set:

Parameter
channel number
unit
velocity factor

The basic procedure is the following:

1. Press the **MEAS** key.
2. Press the **Digital TV** softkey.
3. Press the **Channel Analysis** softkey.
4. Press the **Echo Pattern** softkey.
5. To change the unit from μs to km or miles:
 - Press the **Velocity Factor** softkey to define the velocity of propagation for the unit conversion.
 - Press the **Unit** softkey to select the unit.
6. To zoom onto the echo pattern, press the **Zoom** softkey.
7. To adjust the input attenuator, press the **Adjust Attenuation** softkey.

8. Press the **RUN** key.

For a more detailed description of this measurement type refer to chapter "Advanced Measurement Examples".

Channel Power - digital TV

This measurement determines the channel power of a digital TV channel. The following parameters can be set:

Parameter
channel number
limits

The basic procedure is the following:

1. Press the **MEAS** key.
2. Press the **Digital TV** softkey.
3. Press the **Channel Power** softkey.
4. To change the limits, press the **Edit Table** softkey.
5. To adjust the input attenuator, press the **Adjust Attenuation** softkey.
6. Press the **RUN** key.

For a more detailed description of this measurement type refer to chapter "Advanced Measurement Examples".

APD - digital TV

This measurement determines the amplitude probability density function (APD). The following parameters can be set:

Parameter
channel number
x- and y-axis scaling

The basic procedure is the following:

1. Press the **MEAS** key.
2. Press the **Digital TV** softkey.
3. Press the **APD** softkey.
4. To change the scaling parameters of the x- and y-axis:
 - Press the **Scaling** softkey.
 - Press the corresponding softkey to change the parameters: **x-Axis Signal Lvl**, **x-Axis Range**, **y-Axis Max Value**, **y-Axis Min Value**, **Default Settings**.
5. To adjust the input attenuator, press the **Adjust Attenuation** softkey.
6. Press the **RUN** key.

For a more detailed description of this measurement type refer to chapter "Advanced Measurement Examples".

CCDF - digital TV

This measurement determines the complementary cumulative distribution function (CCDF) of the complex base band signal. The following parameters can be set:

Parameter
channel number
power exceeding probability
x- and y-axis scaling

The basic procedure is the following:

1. Press the **MEAS** key.
2. Press the **Digital TV** softkey.
3. Press the **CCDF** softkey.
4. To determine the power exceeded with a given probability, press the **Percent Marker** softkey.
5. To change the scaling parameters of the x- and y-axis:
 - Press the **Scaling** softkey.
 - Press the corresponding softkey to change the parameters: **x-Axis Signal L, x-Axis Range, y-Axis Max Value, y-Axis Min Value, Default Settings**.
6. To adjust the input attenuator, press the **Adjust Attenuation** softkey.
7. Press the **RUN** key.

For a more detailed description of this measurement type refer to chapter "Advanced Measurement Examples".

Tilt - TV analyzer

This measurement determines the frequency response of the cable TV network by measuring the channel power of every channel. The whole measurement sequence can take some time, depending on the number of channels. The following parameters can be set:

Parameter
span
modulation standard

The basic procedure is the following:

1. Select the appropriate channel table and activate it (for details refer to ["To perform a measurement using a channel table"](#) on page 4.197).
2. Press the **MEAS** key.
3. Press the **TV Analyzer** softkey.
4. Press the **Tilt** softkey.
5. To restrict the channels to be measured, press the **Tilt Setup** softkey:
The **Tilt Setup** dialog box is displayed.
 - To limit the frequency range, under **Span**, enter a start and stop frequency.
 - To select only channels of certain modulation standards for the measurement, under **Modulation Standards**, activate the modulation standards to be included in the measurement.
6. To adjust the range of the y-axis, press the **Auto Range** softkey.

7. Press the **RUN** key.

For a more detailed description of this measurement type refer to chapter "Advanced Measurement Examples".

Softkeys of the Cable TV Analyzer menu

The following table shows all softkeys available in the Cable TV Analyzer menu. It is possible that your instrument configuration does not provide all softkeys. If a softkey is only available with a special option, model or (measurement) mode, this information is delivered in the corresponding softkey description.

Menu / Command	Submenu / Command	Submenu / Command	Command
Channel Setup ↓	Activate		
	New ↓	Copy Channel	
		Delete Channel	
		Modulation Options ↓	New
			Delete
			Edit
		Save Changes	
		Discard Changes	
	Copy ↓	same contents as New menu	
	Delete		
	Edit ↓	same contents as New menu	
	Restore Default Tables		
Adjust Attenuation			

Channel Setup

Opens the **Channel Tables** dialog box with all available channel tables listed, and displays a submenu to activate, create, edit, copy, and delete channel tables and modulation standards.

For further information on channel tables refer to "[Channel tables](#)" on page 4.198 and "[Modulation standards](#)" on page 4.199.

Activate

Activates the channel table in focus. Alternatively to this softkey, the rotary knob or the **ENTER** key can be pressed.

Activating a channel table is synonymous to loading the selected channel table and discarding the previously active channel table. As a prerequisite, the channel table must have at least one channel with a digital or analog modulation standard. Otherwise the channel table cannot be loaded and an error message is displayed. If no appropriate channel table exists, select **< none >** for no channel table.

→ Remote: CONF:TV:CTAB:SEL 'TV-ITALY'

New

Creates a new channel table and opens the **Channel Table** dialog box with the according submenu to edit the channel table.

It is recommended to use long names in order to distinguish the channel tables from each other easily.

For further details refer to "[To create a channel table](#)" on page 4.195.

Copy Channel

Copies the channel in focus.

Delete Channel

Deletes the channel in focus. If the channel table consists only of one channel, this channel can not be deleted.

Modulation Options

Opens the **Modulation Standards** dialog box with all available modulation standards of the channel table listed, and displays a submenu to create, edit, and delete a modulation standard.

For further information on modulation standards refer to "[Modulation standards](#)" on page 4.199, "[To create a new modulation standard](#)" on page 4.195, and "[To copy a modulation standard](#)" on page 4.197.

New

Opens the **Modulation Standard Options** dialog box to define a new modulation standard for the channel table.

For further information on modulation standards refer to "[Modulation standards](#)" on page 4.199 and "[To create a new modulation standard](#)" on page 4.195.

- Remote: DDEM:SBAN NORM
 - Remote: DDEM:SRAT 1000000
 - Remote: DDEM:FILT:ALPH R018
 - Remote: TV:MST:NAME 'TEST'
 - Remote: TV:MST:STYP DTV
 - Remote: TV:MST:FILT:GDEL FLAT
 - Remote: SET:TV:STAN DK
 - Remote: SET:TV:STAN:AUD FM65MONO
 - Remote: SET:TV:STAN:COL SEC
-

Delete

Deletes the modulation standard focused in the **Modulation Standards** dialog box.

Edit

Opens the **Modulation Standard Options** dialog box for the modulation standard in focus. Alternatively to this softkey, the rotary knob or the **ENTER** key can be pressed.

For details refer to "[Modulation standards](#)" on page 4.199 and "[To create a new modulation standard](#)" on page 4.195.

- Remote: DDEM:SBAN NORM
 - Remote: DDEM:SRAT 1000000
 - Remote: DDEM:FILT:ALPH R018
 - Remote: TV:MST:NAME 'TEST'
 - Remote: TV:MST:STYP DTV
 - Remote: TV:MST:FILT:GDEL FLAT
 - Remote: SET:TV:STAN DK
 - Remote: SET:TV:STAN:AUD FM65MONO
 - Remote: SET:TV:STAN:COL SEC
-

Save Changes

Saves all changes in channels and modulation standards, if the channel table passes the compliance check. For further details refer to "[To edit a channel table](#)" on page 4.194.

Discard Changes

After confirmation, discards all changes in channels and modulation standards made for the current channel table. Reloads and displays the original channel table.

Copy

Copies the channel table in focus and opens the **Channel Table** dialog box with the according submenu to edit the channel table. If you enter a name that is already in use you are prompted to enter another one.

For further details refer to "[To create a channel table](#)" on page 4.195.

Delete

Deletes the channel table in focus. If the channel table in focus is also the active channel table, no channel table < **none** > will be activated.

Edit

Opens the **Channel Table** dialog box for the channel table in focus and displays a submenu for editing this channel table. For details refer to "[To edit a channel table](#)" on page 4.194.

Restore Default Tables

Restores the default set of channel tables and the channel table examples.

Adjust Attenuation

Adjusts the input attenuator. For details on the adjustment procedure refer to "[Attenuation adjustment](#)" on page 4.199.

→ Remote: POW:ACH:PRES:RLEV

Softkeys of the frequency menu (Cable TV Analyzer mode)

The following table shows all softkeys available in the frequency menu in **Cable TV Analyzer** mode (**FREQ** key). It is possible that your instrument configuration does not provide all softkeys. If a softkey is only available with a special option, model or (measurement) mode, this information is delivered in the corresponding softkey description.

Menu / Command	Command
RF	
Channel	
RF Stepsize ↓	Manual
	Channel Width
Frequency Abs/Rel	

RF

Opens an edit dialog box to enter the RF frequency. The interpretation of the RF frequency depends on the signal type (analog TV or digital TV) to measure:

Signal type	RF
< unused >	center frequency
analog TV	vision carrier frequency
digital TV	center frequency

If the modulation standard or the active measurement channel is changed, the RF is automatically adapted.

If no channel table < none > is activated, the interpretation of the RF frequency depends on the active measurement.

→ Remote: FREQ:RF 10MHZ

Channel

Displays the active channel table to select a particular measurement channel. The active channel is highlighted.

All channels can be selected, except those with modulation standard **< unused >**. Incompatible channels are marked accordingly; for example an analog TV channel inside a digital TV measurement. If an incompatible channel is selected, the current measurement is aborted, and the spectrum measurement will become the active measurement. If no channel table **< none >** is activated, this softkey is not available.

If you perform a measurement over all possible channels, use the **Channel No** softkey of the measurement menu to change from one channel to the next channel of the channel table quickly.

→ Remote: `FREQ:CHAN 3`

RF Stepsize

Opens a submenu to set the RF step size. If no channel table **< none >** is activated, this softkey is not available.

→ Remote: `FREQ:CENT:STEP 120MHz`

Manual

For details refer to the **Manual** softkey in the frequency menu of the base unit.

Channel Width

Takes the channel width of the current measurement channel as RF step size once.

If no channel table **< none >** is activated, this softkey is not available.

Frequency Abs/Rel

Sets the labeling of the frequency axis.

If absolute labeling is selected, the absolute frequencies are displayed, and all markers are absolute.

If relative labeling is selected, the reference is set to 0 Hz. The reference depends on the signal type:

Signal type	Reference
< unused >	center frequency
analog TV	vision carrier frequency
digital TV	center frequency

This softkey is not available in the Tilt measurement.

→ Remote: `SWE:SPAC ABS`

Softkeys of the amplitude menu (Cable TV Analyzer mode)

The following table shows all softkeys available in the amplitude menu in **Cable TV Analyzer** mode (**AMPT** key). It is possible that your instrument configuration does not provide all softkeys. If a softkey is only available with a special option, model or (measurement) mode, this information is delivered in the corresponding softkey description.

Command
Signal Lvl
Range Log
Range Linear
Preamp On/Off
Signal Lvl Position
RF Atten Manual
More ↓
Signal Lvl Offset
Signal Lvl Position
Grid Abs/Rel
Unit
Input 50 Ω / 75 Ω

Signal Lvl

Opens an edit dialog box to enter the expected RMS (digital TV) or peak (analog TV) input power of the signal. This parameter is channel-specific and is set, in a cable network with multiple channels, only for the signal of interest. However, mostly channels with the same signal type have the same signal level.

→ Remote: `DISP:TRAC:Y:RLEV -60dBm`

Range Log

For details refer to the **Range Log** softkey in the amplitude menu of the base unit.

Range Linear

For details refer to the **Range Linear** softkey in the amplitude menu of the base unit.

Preamp On/Off

For details refer to the **Preamp On/Off** softkey in the amplitude menu of the base unit.

Signal Lvl Position

For details refer to the **Ref Level Position** softkey in the amplitude menu of the base unit.

RF Atten Manual

Opens an edit dialog box to enter the attenuation. For details see also "[Attenuation adjustment](#)" on page 4.199.

Signal Lvl Offset

For details refer to the **Ref Level Offset** softkey in the amplitude menu of the base unit.

Grid Abs/Rel

For details refer to the **Grid Abs / Rel** softkey in the amplitude menu of the base unit.

Unit

Opens a list containing all allowed units to select the appropriate unit. These units are used for scaling diagrams or input/output of parameters and limits.

The variety of the absolute units depends on the selected measurement, as relative unit dB is used.

The units are selected according to the state of the **Range Log** and **Range Linear** softkeys. For voltage units, the input impedance (**Input 50 Ω / 75 Ω** softkey) is used for the conversion.

→ Remote: CALC:UNIT:POW DBM

Input 50 Ω / 75 Ω

For details refer to the **Input 50 Ω / 75 Ω** softkey in the amplitude menu of the base unit.

Typically, cable TV networks have an impedance of 75 Ω (set the softkey to 75 Ω). For precise (level) measurements an adapter of the RAZ type (= 25 Ω in series to the input impedance of the instrument) should always be used.

Softkeys of the trace menu (Cable TV Analyzer mode)

In the **Cable TV Analyzer** mode, 4 traces are available. In the measurements listed below, averaging is not carried out over the measurement points (trace) but over the values listed in the result table. Therefore instead of a trace mode a result mode is selected via the **Result Mode** softkey.

- Carriers
- C/N, CSO, CTB
- Vision Modulation
- Hum
- Overview
- Modulation Errors
- Channel Power
- Tilt

Apart from these differences, the trace menu works as described in "[Setting Traces - TRACE Key](#)" on page 4.35.

Softkeys of the measurement menu (Cable TV Analyzer mode)

The following table shows all softkeys available in the measurement menu in **Cable TV Analyzer** mode (**MEAS** key). It is possible that your instrument configuration does not provide all softkeys. If a softkey is only available with a special option, model or (measurement) mode, this information is delivered in the corresponding softkey description.

Menu / Command	Submenu / Command	Submenu / Command	Command
Analog TV ↓	Spectrum ↓	Channel No	
		Adjust Attenuation	
	Carriers ↓	Channel No	
		Edit Table	
		Adjust Attenuation	
	C/N ↓	Channel No	
		Reference Power ↓	Reference Channel
			Same as Meas Channel
			Manual Reference Power
		C/N Setup ↓	Insert Line
			Delete Line
		Next Meas Frequency	
		Edit Table	
		Meas Carrier	
		Adjust Attenuation	
	CSO ↓	Channel No	
		Reference Power ↓	same contents as in C/N submenu
		CSO Setup ↓	same contents as in C/N Setup submenu
		Next Meas Frequency	
		Edit Table	
		Meas Carrier	
		Adjust Attenuation	
	CTB ↓	Channel No	
		Reference Power ↓	same contents as in C/N submenu
		CTB Setup ↓	same contents as in C/N Setup submenu
		Next Meas Frequency	
		Edit Table	
		Meas Carrier	
		Adjust Attenuation	
	Analog TV Settings		

Menu / Command	Submenu / Command	Submenu / Command	Command
	More ↓		
	Video Scope ↓	Channel No	
		Line	
		Field 1/2	
		Sweeptime Manual	
		Trigger Offset	
		Adjust Attenuation	
	Vision Modulation ↓	Channel No	
		Edit Table	
		Adjust Attenuation	
	Hum ↓	Channel No	
		Auto Range	
		Edit Table	
		Adjust Attenuation	
	Analog TV Settings		
Digital TV ↓	Spectrum ↓	Channel No	
		Shoulder Atten On/Off	
		Adjust Attenuation	
	Overview ↓	Channel No	
		Zoom	
		Edit Table	
		Adjust Attenuation	
	Modulation Analysis ↓	Const Diagram ↓	Channel No
			Zoom
			Freeze
			Adjust Attenuation
		Modulation Errors ↓	Channel No
			Zoom
			Edit Table
			Adjust Attenuation
	Channel Analysis ↓	Echo Pattern ↓	Channel No
			Unit
			Zoom
			Velocity Factor
			Adjust Attenuation
		Adjust Attenuation	
	Digital TV Settings		

Menu / Command	Submenu / Command	Submenu / Command	Command
	More ↓		
	Channel Power ↓	Channel No	
		Edit Table	
		Adjust Attenuation	
	APD ↓	Channel No	
		Scaling ↓	x-Axis Signal Lvl
			x-Axis Range
			y-Axis Max Value
			y-Axis Min Value
			Default Settings
		Adjust Attenuation	
	CCDF ↓	Channel No	
		Percent Marker	
		Scaling ↓	same contents as in APD submenu
		Adjust Attenuation	
	Digital TV Settings		
TV Analyzer ↓	Tilt ↓	Tilt Setup	
		Auto Range	
		Adjust Attenuation	

Analog TV

Opens a submenu with all available analog TV measurements. Every measurement type provides its own submenu to set the parameters. Additionally the **Analog TV Settings** softkey gives access to the modulation standard information.

This softkey is only available if the active channel table has at least one channel with an analog TV modulation standard, or if no channel table < none > is activated.

If a digital TV channel is in use when pressing this softkey, automatically the first analog channel of the active channel table is selected.

For further details refer also to section "[Measurements](#)" on page 4.193.

Spectrum

Opens a submenu to measure an analog TV spectrum.

For further information refer to "[Spectrum - analog TV](#)" on page 4.201.

→ Remote: CONF:ATV:MEAS ASP

→ Remote: TRAC? TRACE1

Channel No

Opens an edit dialog box to select the measurement channel. Select the previous or next channel via the rotary knob or the arrow keys, or enter the channel number.

Only compatible channels can be selected, entries of incompatible channel are skipped. Incompatible channels are channels of a different signal type or channels with the modulation standard **< unused >**.

If you want to select a particular channel, use the **Channel** softkey in the frequency menu. If channel table **< none >** is selected, use the **RF** softkey in the frequency menu for frequency input.

→ Remote: `FREQ:CHAN 3`

Shoulder Atten On/Off

Activates or deactivates the shoulder measurement in accordance to ETSI TR 101290 standard. If activated, the results (upper and lower shoulder attenuation) are displayed as a list below the spectrum.

This softkey is available from firmware version 1.50.

- Remote: `CALC:DTV:RES? SAL`
 - Remote: `CALC:DTV:RES? SAUP`
 - Remote: `CONF:DTV:MEAS:SATT OFF`
-

Carriers

Opens a submenu to measure the carriers powers.

For further information refer to "[Carriers - analog TV](#)" on page 4.201.

- Remote: `CONF:ATV:MEAS CARR`
 - Remote: `CONF:ATV:RES:CARR? ALL`
-

Edit Table

Activates the edit mode to change the limits within the result table. To edit a field, press the **ENTER** key. For all available parameters, the limit fields contain default values. If a field is empty, the corresponding limit can not be set for the measurement.

For the following measurements, the unit for the upper and lower limits differs. The unit is set in the last table column. Only the limits carrying the set unit are displayed in the table. To display the other limits, change the unit first.

Measurement	Parameter	Unit lower limits	Unit upper limit
Hum		dB	%
Overview, Modulation Errors	MER (rms)	dB	%
	MER (peak)	dB	%
	EVM (rms)	dB	%
	EVM (peak)	dB	%

- Remote: CALCulate:ATV:LIMit Subsystem, CALCulate:ATV:LIMit:RESult Subsystem, CALCulate:ATV:RESult Subsystem for analog TV
- Remote: CALCulate:DTV:LIMit Subsystem, CALCulate:DTV:LIMit:RESult Subsystem, CALCulate:DTV:RESult Subsystem for digital TV

Meas Carrier

Switches the carrier or noise measurement on or off.

activate d	Starts a new carrier measurement with the next sweep.
deactiv ated	Starts a new noise measurement with the next sweep.

This softkey is only available in the **Off-Service** measurement method (setup dialog box).

- Remote: CONF:ATV:CN:MEAS NOIS
- Remote: CONF:ATV:CSO:MEAS NOIS
- Remote: CONF:ATV:CTB:MEAS NOIS

C/N

Opens a submenu to measure the carrier-to-noise ratio.

For further information refer to "[C/N - analog TV](#)" on page 4.202.

- Remote: CONF:ATV:MEAS CN
- Remote: CALC:ATV:RES:CN? ALL

Reference Power

Opens a submenu to select the reference power method. The state of this submenu is not part of the measurement parameter set. If you switch from one measurement to another, the settings of this submenu are unchanged.

The set reference power method is indicated on the softkey:

(Meas Ch)	Reference Channel softkey
(same)	Same as Meas Channel softkey
<value>	Manual Reference Power softkey

- Remote: ATV:CN:POW:REF:MODE RCH
- Remote: ATV:CSO:POW:REF:MODE RCH
- Remote: ATV:CTB:POW:REF:MODE RCH

Reference Channel

Displays the active channel table to select a particular measurement channel. For further details refer to the **Channel** softkey in the frequency menu.

- Remote: ATV:CN:POW:REF:CHAN:MAN 5
- Remote: ATV:CSO:POW:REF:CHAN:MAN 6
- Remote: ATV:CTB:POW:REF:CHAN:MAN 5

Same as Meas Channel

Sets the active measurement channel as reference channel. If the active measurement channel is changed, e.g. via the **Channel No** softkey, the reference channel is also changed automatically. This is the default setting.

- Remote: ATV:CN:POW:REF:MODE MCH
 - Remote: ATV:CSO:POW:REF:MODE MCH
 - Remote: ATV:CTB:POW:REF:MODE MCH
-

Manual Reference Power

Opens an edit dialog box to enter the reference power. The unit is set via the **Unit** softkey in the amplitude menu.

- Remote: ATV:CN:POW:REF:MAN 10
 - Remote: ATV:CSO:POW:REF:MAN 20
 - Remote: ATV:CTB:POW:REF:MAN 10
-

C/N Setup

Opens the **C/N Setup** dialog box to configure the following:

- **Measurement Method**

In-Service: While an analog TV signal is present, a gap between two consecutive channels, where only noise exists, is used to determine the noise power. A noise marker is placed there, and the noise power is determined.

Off-Service: The current measurement channel has to be switched off. An according message prompts you to do so. In this channel, a noise marker is placed, and the noise power is determined.

Quiet Line: While an analog TV signal is present, the carrier-to-noise ratio is measured using the so-called "Quiet Line". The measurement is fully automated.

- **Measurement Frequencies**

The table contains center frequencies (CF) and span values. The center frequency values are relative to the vision carrier frequency. One parameter set defines a frequency span and is used in one measurement. Only selected parameter sets are used in the measurements. If no parameter set is selected at all, the measurement is performed over all listed parameter sets.

For the **Quiet Line** measurement method, the table remains empty. For the other measurement methods, the table must contain at least one parameter set.

- **Noise Reference Bandwidth**

The entered value is multiplied with the measured noise power density to determine the noise power value.

- **Noise Floor Correction**

This option activates or deactivates the noise correction factor measurement. By default, the option is deactivated. In the noise correction factor measurement, the noise of the R&S FSL is determined. Therefore you are prompted to remove the cable from the R&S FSL's RF input when activating the option.

C/N Setup (Off-Service)

Measurement Method

In-Service

Off-Service

Quiet Line

Measurement Frequencies

CF (relative)	Span
<input checked="" type="checkbox"/> 2.75 MHz	10.0 MHz
<input type="checkbox"/>	
<input type="checkbox"/>	
<input type="checkbox"/>	
<input type="checkbox"/>	
<input type="checkbox"/>	
<input type="checkbox"/>	
<input type="checkbox"/>	
<input type="checkbox"/>	
<input type="checkbox"/>	
<input type="checkbox"/>	

Noise Reference Bandwidth

Noise Floor Correction

- Remote: ATV:CN:MEAS:MODE OSER (Measurement Method)
- Remote: ATV:CN:TABL1:MFR 1,1000,1000 (Measurement Frequencies)
- Remote: ATV:CN:BWID 7MHZ (Noise Reference Bandwidth)
- Remote: ATV:CN:POW:NCOR ON (Noise Floor Correction)

Insert Line

Inserts a line in the **Measurement Frequencies** table to add a parameter set. This softkey is only active, if the focus is on the **Measurement Frequencies** table.

Delete Line

Deletes the focused line in the **Measurement Frequencies** table. This softkey is only active, if the focus is on the **Measurement Frequencies** table.

Next Meas Frequency

Switches from one frequency span to the next according to the parameter sets (center frequency, span) defined under **Measurement Frequencies** in the setup dialog box. Only activated entries are considered.

- Remote: ATV:CN:CFR:NEXT
 - Remote: ATV:CSO:CFR:NEXT
 - Remote: ATV:CTB:CFR:NEXT
-

CSO

Opens a submenu to measure the carrier-to-second order beat ratio (CSO).

For further information refer to "[CSO - analog TV](#)" on page 4.203.

- Remote: CONF:ATV:MEAS CSO
- Remote: CALC:ATV:RES:CSO? ALL

CSO Setup

Opens the **CSO Setup** dialog box to configure the following:

– **Measurement Method**

Off-Service: The current measurement channel has to be switched off. An according message prompts you to do so. In this channel, a noise marker is placed, and the noise power is determined.

Quiet Line: While an analog TV signal is present, the carrier-to-second order beat ratio is measured using the so-called "Quiet Line". The measurement is fully automated.

– **Measurement Frequencies**

The table contains center frequencies (CF) and span values. The center frequency values are relative to the vision carrier frequency. One parameter set defines a frequency span and is used in one measurement. Only selected parameter sets are used in the measurements. If no parameter set is selected at all, the measurement is performed over all listed parameter sets. For the **Quiet Line** measurement method, the table remains empty.

– **Noise Floor Correction**

This option activates or deactivates the noise correction factor measurement. By default, the option is deactivated. In the noise correction factor measurement, the noise of the R&S FSL is determined. Therefore you are prompted to remove the cable from the R&S FSL's RF input when activating the option.

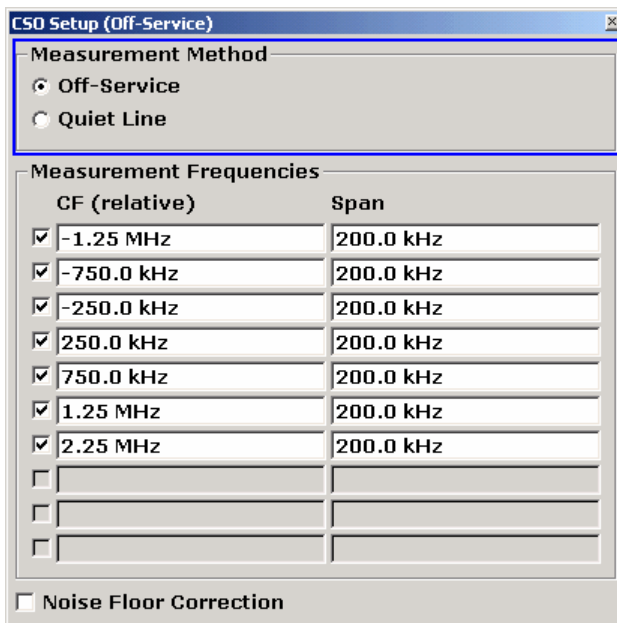

- Remote: ATV:CSO:MEAS:MODE QLIN (Measurement Method)
- Remote: ATV:CSO:TABL2:MFR 1, -2000, 2000 (Measurement Frequencies)
- Remote: ATV:CSO:POW:NCOR ON (Noise Floor Correction)

CTB

Opens a submenu to measure the carrier-to-composite triple beat ratio (CTB). The measurement always takes place off-service with current measurement channel has to be switched off. An according message prompts you to do so. In this channel, a noise marker is placed, and the noise power is determined.

For further information refer to "CTB - analog TV" on page 4.204.

- Remote: CONF:ATV:MEAS CTB
- Remote: CALC:ATV:RES:CTB? ALL

CTB Setup

Opens the **CTB Setup** dialog box to configure the following:

- **Measurement Frequencies**

The table contains center frequencies (CF) and span values. The center frequency values are relative to the vision carrier frequency. One parameter set defines a frequency span and is used in one measurement. Only selected parameter sets are used in the measurements. If no parameter set is selected at all, the measurement is performed over all listed parameter sets.

- **Noise Floor Correction**

This option activates or deactivates the noise correction factor measurement. By default, the option is deactivated. In the noise correction factor measurement, the noise of the R&S FSL is determined. Therefore you are prompted to remove the cable from the R&S FSL's RF input when activating the option.

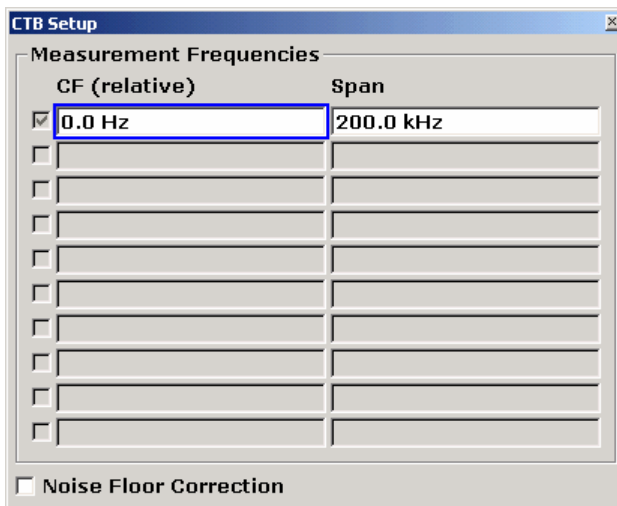

- Remote: ATV:CTB:TABL1:MFR 1,100,10000 (Measurement Frequencies)
- Remote: ATV:CTB:POW:NCOR ON (Noise Floor Correction)

Analog TV Settings

Opens the **Analog TV Settings** dialog box to modify the modulation standard parameters. The displayed parameters are derived from the modulation standard referenced in the active channel table. If no channel table < none > is activated, the default modulation standard is used (for details see also "[Modulation standards](#)" on page 4.199).

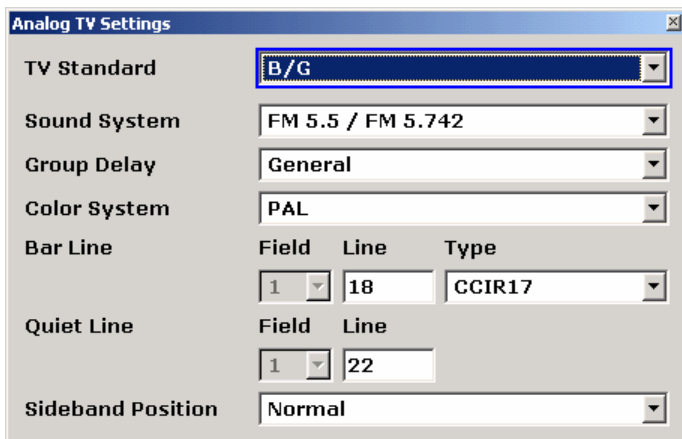

For the modulation standard, the changes made via this softkey are only kept as long as a measurement channel with the same modulation standard is selected. If a measurement channel with a different modulation standard is selected, or the **PRESET** key is pressed, the changes are lost.

If no channel table < none > is activated, the changes of the default modulation standard are kept as long as the **PRESET** key is not pressed.

- Remote: SET:TV:STAN DK (TV Standard)
- Remote: SET:TV:STAN:AUD FM65MONO (Sound System)
- Remote: TV:MST:FILT:GDEL FLAT (Group Delay)
- Remote: SET:TV:STAN:COL SEC (Color System)
- Remote: TRIG:VID:BLIN 16, TRIG:VID:BFI 2, TRIG:VID:BLIN:TYPE CCIR17 (Bar Line)
- Remote: TRIG:VID:QLIN 20, TRIG:VID:QFI 2 (Quiet Line)
- Remote: DDEM:SBAN NORM (Sideband Position)

Video Scope

Opens a submenu to measure the luminance signal. For this measurement, the **TRACE** key is not available.

For further information refer to "[Video Scope - analog TV](#)" on page 4.205.

- Remote: CONF:ATV:MEAS VSC
- Remote: TRAC? TRACE1

Line

Opens an edit dialog box to set the line number of the TV picture. The numbering conventions depend on the following conditions:

TV standard	Color system	Field number	Line numbering
≠ M	-	-	1, 2, ..., 625
≡ M	PAL	-	1, 2, ..., 525

≡ M	NTSC	1	1, 2, ..., 263
≡ M	NTSC	2	1, 2, ..., 262

→ Remote: TRIG:VID:LINE 17

Field 1/2

Selects the active field. Field 1 is the default state. This softkey is only available for the TV standard **M** in combination with another color system than **PAL**.

For details on numbering conventions of TV picture lines refer to the **Line** softkey.

→ Remote: TRIG:VID:FIEL 2

Sweeptime Manual

Opens an edit dialog box to enter the total sweep time. Possible values are 25, 50 and 100 μ s. The set value is indicated on the softkey.

→ Remote: SWE:TIME 10s

Trigger Offset

Opens an edit dialog box to enter a value for the trigger offset. The set value is indicated on the softkey.

→ Remote: TRIG:HOLD 500us

Vision Modulation

Opens a submenu to measure the residual picture carrier and the modulation depth.

For further information refer to "[Vision Modulation - analog TV](#)" on page 4.205.

→ Remote: CONF:ATV:MEAS VMOD

→ Remote: CALC:ATV:RES:VMOD? ALL

Hum

Opens a submenu to measure the hum.

For further information refer to "[Hum - analog TV](#)" on page 4.206.

→ Remote: CONF:ATV:MEAS HUM

→ Remote: CALC:ATV:RES:HUM?

Auto Range

Automatically adjusts the x- and y-axis once. Alternatively the range of the y-axis can be changed via the **Range Log** softkey or the **Range Linear** softkey in the amplitude menu.

→ Remote: DISP:TRAC:Y:AUTO ON

Digital TV

Opens a submenu with all available digital TV measurements. Every measurement type provides its own submenu to set the parameters. Additionally the **Digital TV Settings** softkey gives access to the modulation standard information.

This softkey is only available if the active channel table has at least one channel with a digital TV modulation standard, or if no channel table < **none** > is activated.

If an analog TV channel is in use when pressing this softkey, automatically the first digital channel of the active channel table is selected.

For further details refer also to section "[Measurements](#)" on page 4.193.

Spectrum

Opens a submenu to measure a digital TV spectrum.

For further information refer to "[Spectrum - digital TV](#)" on page 4.206.

→ Remote: CONF:DTV:MEAS DSP

→ Remote: TRAC? TRACE1

Overview

Opens a submenu to measure the modulation accuracy.

For further information refer to "[Overview - digital TV](#)" on page 4.207.

→ Remote: CONF:DTV:MEAS OVER

→ Remote: CALC:DTV:RES? ALL

Zoom

Opens the **Select Result Parameter** dialog box to set the zoom:

None The whole result table is displayed (default setting).

[parameter] The selected parameter is displayed separately in the upper pane.

→ Remote: DISP:ZOOM:OVER MERP

→ Remote: DISP:ZOOM:MERR MERP

Modulation Analysis

Opens a submenu to select one of the following modulation measurements:

– [Const Diagram](#)

– [Modulation Errors](#)

Const Diagram

Opens a submenu to display the constellation diagram. For further information refer to "[Constellation Diagram \(Modulation Analysis\) - digital TV](#)" on page 4.207.

- Remote: CONF:DTV:MEAS CONS
 - Remote: TRAC? TRACE1
-

Zoom

Opens the **Select Constellation Zoom Mode** dialog box to set the zoom:

- < none >** The whole constellation diagram is displayed (default setting).
- Quadrant 1/2/3/4** The selected quadrant is displayed. A pictogram shows the quadrant position.

- Remote: DISP:ZOOM:QUAD 1
-

Freeze

Sets the display mode. If activated, the constellation diagram is displayed unchanged, while the I/Q samples are collected in the background. If deactivated, the constellation diagram is displayed on basis of the current I/Q samples and, in continuous sweep mode, is updated with every measurement.

If a new zoom mode (see **Zoom** softkey) is selected, this softkey is automatically set to off.

- Remote: DISP:TRAC1:MODE:FRE ON
-

Modulation Errors

Opens a submenu to measure the modulation accuracy.

For further information refer to "[Modulation Errors \(Modulation Analysis\) - digital TV](#)" on page 4.208.

- Remote: CONF:DTV:MEAS MERR
 - Remote: CALC:DTV:RES? ALL
-

Channel Analysis

Opens a submenu to select a measurement for checking the transmission performance of a channel:

- [Echo Pattern](#)
-

Echo Pattern

Opens a submenu to measure the magnitude of channel impulse response with respect to the corresponding time delay.

For further information refer to "[Echo Pattern \(Channel Analysis\) - digital TV](#)" on page 4.208.

- Remote: CONF:DTV:MEAS EPAT
 - Remote: TRAC? TRACE1
-

Unit

Opens the **Unit** dialog box to select the unit: s, m.

→ Remote: CALC:DTV:UNIT:POW:EPAT M

Zoom

Opens an edit dialog box to zoom onto the echo pattern measurement, around 0 μ s. The zoom factor can vary from 1 to 20.

→ Remote: DISP:ZOOM:EPAT 2

→ Remote: DISP:ZOOM:EPAT:STAT ON

Velocity Factor

Opens an edit dialog box to enter the velocity of propagation of the signal in the transmission channel (e.g. cable), relative to speed of light.

The velocity factor is used to convert the impulse response results from seconds into meter, when changing the unit via the **Unit** softkey.

→ Remote: CORR:RVEL 2

Digital TV Settings

Opens the **Digital TV Settings** dialog box to modify the modulation standard and equalizer parameters. For details on the modulation standard parameters, refer also to "[Modulation standards](#)" on page 4.199 and "[To create a new modulation standard](#)" on page 4.195.

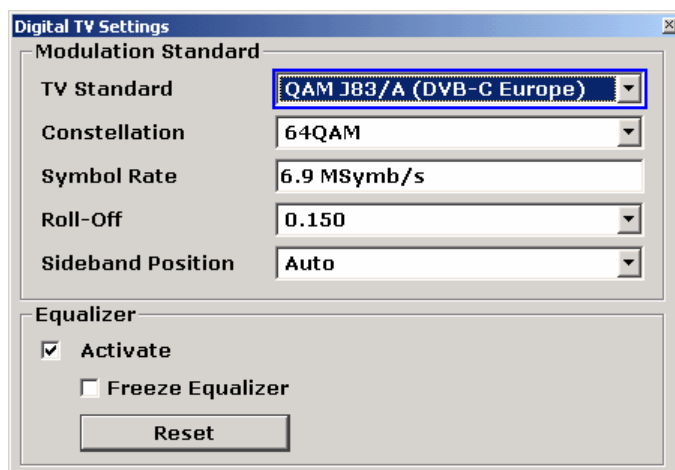

Under **Equalizer**, the following equalizer parameters can be modified:

- Activating or deactivating the equalizer: If the **Activate** option is activated, the equalizer is switched on and filters the signal.
- Activating or deactivating the **Freeze Equalizer** option: If activated the equalizer coefficients remain unchanged. If deactivated the equalizer taps are changed with every measurement.
- Pressing the **Reset** button sets all equalizer parameters to their default values.

- Remote: SET:TV:STAN DK (TV Standard)
 - Remote: SOURce:DM:FORM QAM128 (Constellation)
 - Remote: DDEM:SRAT 1000000 (Symbol Rate)
 - Remote: DDEM:FILT:ALPH R018 (Roll-Off)
 - Remote: DDEM:SBAN NORM (Sideband Position)
 - Remote: DDEM:EQU OFF (Activate Equalizer)
 - Remote: DDEM:EQU:FRE ON (Freeze Equalizer)
 - Remote: DDEM:EQU:RES (Reset Equalizer)
-

Channel Power

Opens a submenu to measure the channel power of a digital TV signal.

For further information refer to "[Channel Power - digital TV](#)" on page 4.209.

APD

Opens a submenu to measure the amplitude probability density function (APD) of a digital TV signal sampled in the complex base band.

For further information refer to "[APD - digital TV](#)" on page 4.209.

- Remote: CONF:DTV:MEAS APD
 - Remote: TRAC? TRACE1
-

Scaling

For details refer to the **Scaling** softkey in the power measurement menu of the base unit.

x-Axis Signal Lvl

For details refer to the **x-Axis Ref Level** softkey in the power measurement menu of the base unit.

x-Axis Range

For details refer to the **x-Axis Range** softkey in the power measurement menu of the base unit.

y-Axis Max Value

For details refer to the **y-Axis Max Value** softkey in the power measurement menu of the base unit.

y-Axis Min Value

For details refer to the **y-Axis Min Value** softkey in the power measurement menu of the base unit.

Default Settings

For details refer to the **Default Settings** softkey in the power measurement menu of the base unit.

CCDF

Opens a submenu to measure the complementary cumulative distribution function (CCDF) of the amplitude of a digital TV signal sampled in the complex base band.

For further information refer to "[CCDF - digital TV](#)" on page 4.210.

- Remote: CONF:DTV:MEAS CCDF
 - Remote: TRAC? TRACE1
-

Percent Marker

For details refer to the **Percent Marker** softkey in the power measurement menu of the base unit.

TV Analyzer

Opens a submenu with all available measurements that can be applied to a set of channels or all channels of the entire TV network (channel table). In these measurements, both analog and digital TV channels can be measured together. This softkey is only available if a channel table is selected.

Every measurement type provides its own submenu to set the parameters. For each measurement, a channel table must be selected. The choice of no channel table **< none >** is not permitted.

For further details refer also to section "[Measurements](#)" on page 4.193.

Tilt

Opens a submenu to measure the frequency response of the cable TV system. Each channel is measured using the information stored in the modulation standard. Channels with the modulation standard **< unused >** are not measured.

For further information refer to "[Tilt - TV analyzer](#)" on page 4.210.

- Remote: CONF:TV:MEAS TILT
 - Remote: TRAC? TRACE1
-

Tilt Setup

Opens the **Tilt Setup** dialog box to define a filter for the Tilt measurement. The following parameters can be defined for the measurement:

- | | |
|-----------------------------|---|
| Span | full span or a limited frequency range |
| Modulation Standards | channels with certain modulation standards (select one or several) or no restriction (select all) |

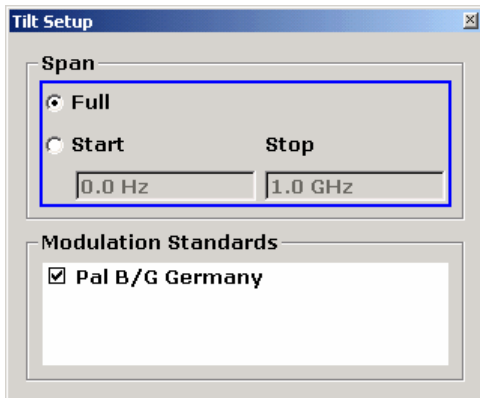

- Remote: `FREQ:SPAN:FULL, FREQ:STAR 20MHz, FREQ:STOP 2000MHz` (Span)
- Remote: `TV:TILT:MST:CDIS 'Analog TV', TV:TILT:MST:CEN 'Analog TV'` (Modulation Standards)

Auto Range

Automatically adjusts the x- and y-axis once. Alternatively the range of the y-axis can be changed via the **Range Log** softkey or the **Range Linear** softkey in the amplitude menu of the base unit.

- Remote: `DISP:TRAC:Y:AUTO ON`
-

Noise Figure Measurements Option (K30)

The Noise Figure Measurements option provides noise figure measurements. Using this option, the noise figure of a Device Under Test, e.g. low-noise FET amplifier circuits, with noise figures of less than 1 dB can be measured. This option is available from firmware version 1.50.

To open the noise figure measurements menu

- If the **Noise** mode is not the active measurement mode, press the **MODE** key and activate the **Noise** option.
- If the **Noise** mode is already active, press the **MENU** key or the **MEAS** key.
The noise figure measurements menu is displayed. .

Menu and softkey description

- ["Softkeys of the noise figure measurements menu \(Noise mode\)"](#) on page 4.239
- ["Softkeys of the sweep menu \(Noise mode\)"](#) on page 4.252
- ["Softkeys of the trace menu \(Noise mode\)"](#) on page 4.253
- ["Softkeys of the marker menu \(Noise mode\)"](#) on page 4.254
- ["Softkeys of the marker-> menu \(Noise mode\)"](#) on page 4.255
- ["Softkeys of the lines menu \(Noise mode\)"](#) on page 4.255

The span and trigger menus are not available in the **Noise** mode. All other menus are provided as described for the base unit. For details refer to the corresponding menu descriptions.

To display help to a softkey, press the **HELP** key and then the softkey for which you want to display help. To close the help window, press the **ESC** key. For further information refer to section "How to use the Help System".

Further information

- ["Measurement modes of the noise figure measurement"](#) on page 4.236
- ["Calibration"](#) on page 4.236
- ["Measurement forms"](#) on page 4.237
- ["Measurement settings"](#) on page 4.237
- ["Result displays"](#) on page 4.237
- ["Status bar information"](#) on page 4.239

Tasks

- [To edit tables](#)
- [To work with limit lines](#)

To edit tables

1. Select the table header using the rotary knob or arrow keys and press rotary knob or the **ENTER** key to enter into the edit mode.
2. Focus the field you want to edit using the arrow keys or the rotary knob.
3. Enter the values (for details refer to the Quick Start Guide, chapter 4, "Basic Operations").

4. To insert a new row above the currently selected row, press the **Insert** softkey.
5. To delete the currently selected row, press the **Delete** softkey.
6. Only available for the **Frequency Table**:
To update the table according to the **Frequency Settings**, press the **Build Tbl** softkey.
7. Press the **Exit** softkey to leave the edit mode.

To work with limit lines

1. Press the **LINES** key.
The **Limit Lines** dialog box is displayed. It contains information on name, limit, status, and a comment.
2. To activate limit lines, select the limit line you want to activate and press the **Enable/Disable** softkey.
3. To define a new limit line, press the **New** softkey and enter the limit line characteristics.
4. To modify a limit line, select the limit line you want to edit and press the **Edit** softkey.
5. To save a limit line, press the **Exit** softkey.
If data are missing or if some data are invalid, an error message is displayed.
6. To delete a limit line, select the limit line you want to edit and press the **Delete** softkey.

Further information

This section provides background information on measurements and displayed information.

Measurement modes of the noise figure measurement

Noise measurements are performed on many different types of device under test (DUT). The type of DUT to be measured determines the test setup and also how the frequency list is to be generated. To support these different types of DUT, two different noise figure measurement types are available:

- [Direct measurement](#)
- [Frequency-converting measurement](#)
 - Fixed LO, $IF = RF + LO$
 - Fixed LO, $IF = \text{abs}(RF - LO)$

The setup for the different measurement types is described with the **Schematic** softkey. The measurement mode is set in the **Frequency Settings** dialog box, **Mode** field.

Calibration

The calibration measures the noise introduced to a signal by the spectrum analyzer itself to compensate it in measurements on a device under test. This compensation is called 2nd stage correction, because the spectrum analyzer is the second stage of the test setup, the DUT being the first stage.

If the second stage correction is activated (**Measurement Settings** dialog box, **2nd Stage Correction** option), a separate calibration measurement is performed before the main measurement (for details on the measurement setup refer to chapter "Advanced Measurement Examples"). The data measured in the calibration measurement are used for compensation in the main measurement.

It is strongly recommended to perform calibration before running measurements (**Cal** softkey). It is possible to run measurements in an uncalibrated status, but the measurement results will not be corrected for any noise introduced by the spectrum analyzer itself.

If the list of receive frequencies (RF) is changed, at which the measurements are performed, calibration is necessary again to ensure that calibration data are available for every measurement step. For details on frequency settings refer to the **Freq Settings** softkey.

Measurement forms

Two forms of measurements are possible:

- frequency list measurement

A measurement is performed at each of the frequencies listed in the frequency list (**Freq Settings** softkey). The noise figure of the DUT across a user-specified range of frequencies is measured. In single sweep mode, each frequency point is measured once and complete. In continuous sweep mode, one frequency point after the other is measured in turn until the measurement is aborted.

- fixed frequency measurement

A continuous measurement is performed at the single frequency currently selected in the **Frequency List Results**. This individual frequency from the frequency list measurement is investigated in more detail, for example to see the effect of dynamic changes to the noise figure of the DUT at a particular frequency (see also **Fix Freq** softkey).

Measurement settings

The overall measurement settings used to obtain the current measurement results are displayed below the title bar (see Fig. 4-24). The following settings are listed:

Setting	Defined in
RBW	Measurement Settings dialog box, RBW field
Average	Measurement Settings dialog box, Average field
RF Attenuation	Measurement Settings dialog box, RF Attenuation field
Auto Ref Level	Measurement Settings dialog box, Automatic Ref Level field
2nd Stage Corr	Measurement Settings dialog box, 2nd Stage Correction field
Image Rej	Frequency Settings dialog box, Image Rej field

R&S FSL-K30 Noise & Gain		
RBW:	1 MHz	RF Attenuation: 0 dB
Average:	1	2nd Stage Corr: On
	Auto Ref Level: On	Image Rej: 999.99 dB

Fig. 4-24 Measurement settings for the noise figure measurement (example)

Result displays

The result displays consist of two panes:

- **Current Value** pane

In the title bar of this pane, the current measurement mode of the noise figure measurement (on the left) and the calibration status of the noise figure measurement (on the right, if the second stage correction is switched on) are displayed.

Below, the settings and measurement results for the currently selected measurement point in the frequency list are displayed:

Parameter	Description
RF	Receive frequency at the DUT at which the current values were measured (Hz).
LO	Local oscillator frequency (Hz), only displayed for frequency-converting measurements
IF	Intermediate frequency (Hz), only displayed for frequency-converting measurements
ENR	ENR value (dB), refers to the receive frequency (RF)
Loss In	Loss at the input of the DUT (dB), refers to the receive frequency (RF)
Loss Out	Loss at the output of the DUT (dB) frequency-converting measurements: refers to the intermediate frequency (IF) direct measurements: refers to the receive frequency (RF)
NF	Noise figure measured (dB)
Noise Temp	Noise temperature (K), derived from measured noise figure
Gain	Gain measured (dB)

Fixed LO,IF=RF+LO		Current Value		CALIBRATED	
RF:	554 MHz	ENR:	15 dB	NF:	17.13 dB
LO:	0 Hz	Loss In:	0 dB	Noise Temp:	14674.41 K
IF:	554 MHz	Loss Out:	0 dB	Gain:	0.36 dB

Fig. 4-25 Current Value pane (example)

- **Frequency List Result** or graph (frequency list results only)

The measurement results are represented according to the measurement form (see "Measurement forms").

- frequency list results

The measurement results for all frequencies defined in the **Frequency Table** are displayed in form of a graph (see Fig. Graphical result display (example)) or a table (**Frequency List Results**, see Fig. Tabular result display (example)), depending on the currently selected result display (see **Display List/Graph** softkey). The measurement results are updated as the measurement is in progress. Under **Current Value**, the details of the currently selected frequency in the **Frequency List Results** are displayed.

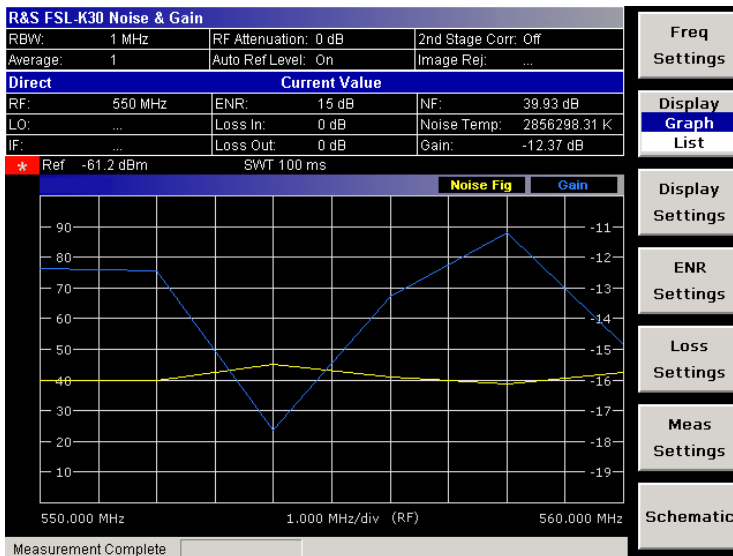

Fig. 4-26 Graphical result display (example)

R&S FSL_K30 Noise & Gain			
RBW:	1 MHz	RF Attenuation:	0 dB
Average:	1	Auto Ref Level:	On
Direct		2nd Stage Corr:	
Current Value		Off	
RF:	550 MHz	ENR:	15 dB
LO:	...	Loss In:	0 dB
IF:	...	Noise Temp:	2856298.31 K
Frequency List Results		Gain:	
-12.37 dB		...	
RF	NF	Noise Temp	Gain
550.000 MHz	39.934 dB	2856298.310 K	-12.366 dB
552.000 MHz	40.005 dB	2903060.727 K	-12.428 dB
554.000 MHz	45.220 dB	9647128.605 K	-17.638 dB
556.000 MHz	40.911 dB	3676944.780 K	-13.269 dB
558.000 MHz	38.831 dB	2215110.289 K	-11.201 dB
560.000 MHz	42.393 dB	5031055.648 K	-14.832 dB
Measurement Complete			

- Freq Settings
- Display Graph
- List
- Display Settings
- ENR Settings
- Loss Settings
- Meas Settings
- Schematic

Fig. 4-27 Tabular result display (example)

- fixed frequency results
 - Under **Current Value**, the measurement results for the fixed frequency are displayed and continuously updated. The **Frequency List Results** do not change - these are the results of the last frequency list measurement.

Status bar information

The status bar displays the following information:

- parameter values
 - If a parameter in a settings dialog box is selected, the minimum and maximum values for the selected parameter are displayed.
 - If a Boolean or an enumerated parameter in a dialog box is selected, the minimum and maximum values are displayed as N/A for not applicable.
- measurement status
 - During the measurement, the current measurement status along with detailed information about the progress is displayed.
- error messages (with red background)
- warning messages (with yellow background)

Softkeys of the noise figure measurements menu (Noise mode)

The following table shows all softkeys available in the noise figure measurements menu. It is possible that your instrument configuration does not provide all softkeys. If a softkey is only available with a special option, model or (measurement) mode, this information is delivered in the corresponding softkey description.

Command
Freq Settings
Display List/Graph
Display Settings

Command
ENR Settings
Loss Settings
Meas Settings
Schematic
Table edit mode
Build Tbl
Exit
Insert
Delete

Freq Settings

Opens the **Frequency Settings** dialog box. Alternatively, this dialog box is opened by pressing the **FREQ** key (with focus on the **Start Freq** field).

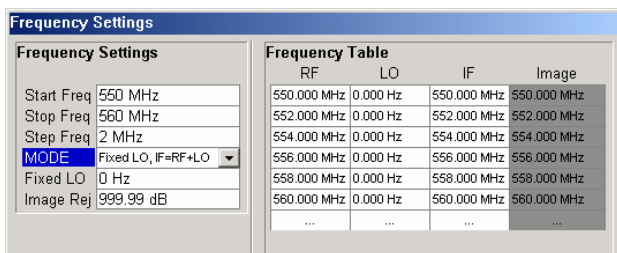

The **Frequency Settings** dialog box contains the following elements:

Frequency Settings	Start Freq
	Stop Freq
	Step Freq
	Mode
	Fixed LO
	Image Rej
Frequency Table	

Under **Frequency Settings**, the frequency settings and the measurement mode are set.

Under **Frequency Table**, the individual measurement steps are listed that will be performed exactly in the order of the table. They are generated from the start frequency, the stop frequency, and the step size on basis of the selected mode. If the start frequency is smaller than the stop frequency, the RF values are generated into a list of ascending frequencies. If the start frequency is larger, the list is descending. Not more than 100 measurement steps are possible. If the gap between start and stop frequency is too large, increase the step frequency.

Depending on the measurement type, the **Frequency Table** contains the following columns:

Measurement type	Column	Description
Direct measurement Frequency-converting measurement	RF	receive frequency, generated from the Start Freq , the Stop Freq , and the Step Freq field entries
Frequency-converting measurement	LO	constant LO frequency, defined via the Fixed LO field
	IF	IF frequency, calculated according to the Mode field

Measurement type	Column	Description
	Image	image frequency, shows whether image frequency filters are required and for which frequency range the image rejection of the DUT is needed (Image Rej field)

It is possible to customize the **Frequency Table** by editing, deleting, and inserting measurement steps. This might be useful in order to insert extra measurement steps near to a specific frequency of interest in order to get more detailed results. If the start, stop, or step frequency is changed, the **Frequency Table** is generated afresh and all manual modifications are overwritten. To customize this table, proceed according to "[To edit tables](#)" on page 4.235.

→ Remote: `FREQ:LIST:DATA 550MHZ,300MHZ,900MHZ` (Frequency Table)

Start Freq

Specifies the start frequency. This is the first receive frequency (RF) entry in the **Frequency Table** and the **Frequency List Results** (result display).

If the start frequency is changed, the **Frequency Table** is updated accordingly.

→ Remote: `FREQ:STAR 500MHZ`

Stop Freq

Specifies the stop frequency. This is the last receive frequency (RF) entry in the **Frequency Table** and the **Frequency List Results** (result display).

If the stop frequency is changed, the **Frequency Table** is updated accordingly.

→ Remote: `FREQ:STOP 700MHZ`

Step Freq

Specifies the step size between the single measurement steps. If the step frequency is larger than the difference between the start frequency and the stop frequency, the **Frequency Table** and the **Frequency List Results** (result display) just contain the start and stop frequency.

If the step frequency is changed, the **Frequency Table** is updated accordingly.

→ Remote: `FREQ:STEP 10MHZ`

Mode

Specifies the measurement mode. For details on modes refer to "[Measurement modes of the noise figure measurement](#)" on page 4.236.

If the mode is changed, the **Frequency Table** is updated accordingly.

→ Remote: `SENS:CONF:MODE:DUT DOWN`

Fixed LO

Specifies the fixed local oscillator frequency. This field is only available if a frequency-converting measurement mode is selected (**Mode** field). For details on modes refer to [Measurement modes of the noise figure measurement](#).

If the fixed LO is changed, the **Frequency Table** is updated accordingly.

→ Remote: SENS:CONF:MODE:SYST:LOSC:FREQ 1MHZ

Image Rej

Specifies the suppression applied to the second sideband. This field is only available if a frequency-converting measurement mode is selected. For details on modes refer to "[Measurement modes of the noise figure measurement](#)" on page 4.236.

The value entered is applied across the complete frequency range. A value of 999.99 dB corresponds to the generally used single-sideband measurement (SSB), where the second sideband does not noticeably affect the measurement result. This is the default value. A value of 0 dB corresponds to the double-sideband measurement (DSB), where both sidebands are converted to the same extent.

→ Remote: CORR:IREJ 100

Display List/Graph

Configures the result display. The measurement results are displayed either in form of a list of measurement points or as a graphical trace. For further details refer to "[Result displays](#)" on page 4.237.

→ Remote: DISP:TABL ON

Display Settings

Opens the **Graphic** dialog box to modify the graphical results display.

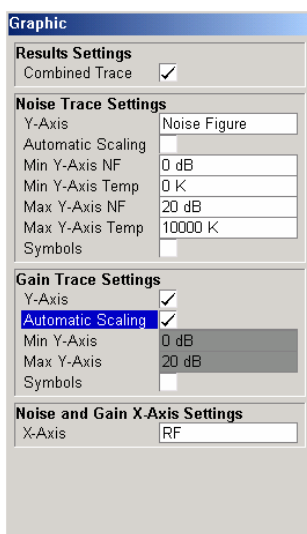

Under **Results Settings**, the settings that affect the overall results display are defined. Under **Noise Trace Settings**, the settings related to the graphical display of noise results are defined. Under **Gain Trace Settings**, the settings related to the graphical display of gain results are defined.

The **Graphic** dialog box contains the following elements:

Results Settings	Combined Trace Display
Noise Trace Settings	Y-Axis
	Automatic Scaling
	Min Y-Axis NF
	Min Y-Axis Temp
	Max Y-Axis NF
	Max Y-Axis Temp
	Symbols
Gain Trace Settings	Y-Axis
	Automatic Scaling
	Min Y-Axis
	Max Y-Axis
	Symbols
Noise and Gain X-Axis Settings	X-Axis

Combined Trace Display

Activates or deactivates the combined trace display of noise and gain results.

On The noise and gain traces are displayed in the same trace display in different colors.

Off The noise and gain traces are displayed in different trace displays.

→ Remote: `DISP:FORM SING`

Y-Axis

Specifies the type of noise result that is to be displayed graphically:

- **Noise Figure**
- **Noise Temperature**
- **Off** (no noise results are displayed graphically)

→ Remote: `DISP:DATA:TRAC1 NFIG|TEFF`

→ Remote: `DISP:TRAC OFF`

Automatic Scaling

Activates or deactivates the automatic scaling of the Y-axis.

On The y-axis is scaled automatically. The automatic scaling algorithm provides the optimal display of the complete range of results.

Off The automatic scaling of the y-axis is switched off, and the scale has to be specified manually:

for noise results via the **Min Y-Axis NF/Min Y-Axis Temp/Max Y-Axis NF/Max Y-Axis Temp** fields,

for gain results via the **Min Y-Axis/Max Y-Axis** fields.

→ Remote: `DISP:TRAC:Y:AUTO ON`

Min Y-Axis NF/Max Y-Axis NF

Specifies the minimum/maximum noise figure result that can be displayed graphically. It is only possible to enter a value, if the automatic scaling is deactivated (see **Automatic Scaling** option), and the y-axis is set to **Noise Figure** (see **Y-Axis** field).

→ Remote: `DISP:TRAC:Y:BOTT -30`

→ Remote: `DISP:TRAC:Y:TOP 30`

Min Y-Axis Temp/Max Y-Axis Temp

Specifies the minimum/maximum noise temperature result that can be displayed graphically. It is only possible to enter a value, if the automatic scaling is deactivated (see **Automatic Scaling** option), and the y-axis is set to **Noise Figure** (see **Y-Axis** field).

→ Remote: `DISP:TRAC:Y:BOTT -30`

→ Remote: `DISP:TRAC:Y:TOP 30`

Symbols

Activates or deactivates the symbol representation. If activated, each measured value is marked by a symbol. This helps to distinguish result types in a monochrome printout.

→ Remote: `DISP:TRAC:SYMB ON`

Y-Axis

Activates or deactivates the graphical display of gain results.

→ Remote: `DISP:TRAC2 OFF`

Min Y-Axis/Max Y-Axis

Specifies the minimum/maximum gain result that can be displayed graphically. It is only possible to enter a value, if the automatic scaling is deactivated (see **Automatic Scaling** option), and the y-axis is activated (see **Y-Axis** field).

→ Remote: `DISP:TRAC2:Y:BOTT 1`

→ Remote: `DISP:TRAC2:Y:TOP 10`

X-Axis

Specifies the scaling of the x-axis. This parameter is only editable in a frequency-converting measurement mode.

→ Remote: `DISP:TRAC:X IF`

ENR Settings

Opens the **ENR** dialog box.

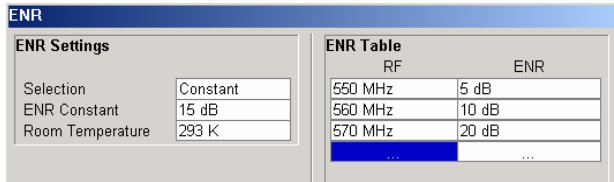

The abbreviation ENR stands for excess noise ratio. Correct ENR values for the noise source are essential to perform accurate measurements. They are used to calculate the effective noise temperature of the noise source that in turn is used for calculation of measurement results.

Under **ENR Settings**, the default ENR value is 15 dB as a constant value that is valid for all frequencies.

Under **ENR Table**, the frequency-dependent ENR values are listed. The list can contain up to 100 RF/ENR pairs. The order of the RF values in the list is not important. To modify this table, proceed as described in "To edit tables" on page 4.235. ENR tables can be saved and recalled at any time via the **FILE** key (for details refer to the section "Saving and Recalling Settings Files - FILE Key"). Additionally to the data saved by the basic unit, all data entered in the **ENR Settings** dialog box are saved.

The **ENR Settings** dialog box contains the following elements:

ENR Settings	Selection
	ENR Constant
	Room Temperature
ENR Table	

→ Remote: CORR:ENR:MEAS:TABLE:DATA 1MHZ,10,2MHZ,12 (ENR Table)

Selection

Defines the used ENR values.

Constant The value specified in the **ENR Constant** field is used for all frequencies. The entries of the **ENR Table** are ignored.

Table The entries of the **ENR Table** provide the basis for the ENR values. Between these values the R&S FSL uses interpolated values.

→ Remote: CORR:ENR:MODE SPOT

ENR Constant

Specifies the constant ENR value of the noise source that is used throughout the entire frequency range. This parameter is only editable if, in the **Selection** list, **Constant** is selected.

→ Remote: CORR:ENR:SPOT 30

Room Temperature

Specifies the current room temperature as an absolute value in Kelvin. This value is used in the calculation of the noise results.

→ Remote: CORR:TEMP 291.50

Loss Settings

Opens the **LOSS** dialog box to take additional losses due to cables or attenuators into account that are not considered in the calibration.

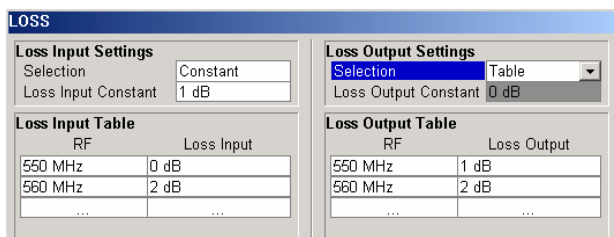

Under **Loss Input Settings**, the additional loss between the noise source and the DUT is defined. Under **Loss Output Settings**, the additional loss between the DUT and the analyzer is defined.

Under **Loss Input Table** or **Loss Output Table**, the list can contain up to 100 RF/ENR pairs. The order of the RF values in the list is not important. To modify this table, proceed as described in "To edit tables" on page 4.235. Loss tables can be saved and recalled at any time via the **FILE** key (for details refer to the section "Saving and Recalling Settings Files - FILE Key"). Additionally to the data saved by the basic unit, all loss input & output data entered in the **Loss Settings** dialog box are saved.

The **Loss Settings** dialog box contains the following elements:

Loss Input Settings	Selection
	Loss Input Constant
Loss Input Table	
Loss Output Settings	Selection
	Loss Output Constant
Loss Output Table	

→ Remote: CORR:LOSS:INP:TABL 1MHz, 10, 2MHz, 12 (Loss Input Table)

→ Remote: CORR:LOSS:OUTP:TABL 1MHz, 10, 2MHz, 12 (Loss Output Table)

Selection

Defines the used Loss values.

Constant The values specified in the **Loss Input Constant/Loss Output Constant** fields are used for all frequencies. The entries of the **Loss Input/Output Table** are ignored.

Table The entries of the **Loss Input/Output Table** provide the basis for the Loss values. Between these values the R&S FSL uses interpolated values.

→ Remote: CORR:LOSS:INP:MODE SPOT

→ Remote: CORR:LOSS:OUTP:MODE SPOT

Loss Input Constant/Loss Output Constant

Specifies the constant loss value that is used across the entire frequency range. This parameter is only editable if, in the **Selection** list, **Constant** is selected.

- Remote: CORR:LOSS:INP:SPOT 10
- Remote: CORR:LOSS:OUTP:SPOT 10

Meas Settings

Opens the **Measurement Settings** dialog box to modify all settings related to the overall measurement.

Alternatively, the **Measurement Settings** dialog box is opened as follows:

- **AMPT** key, with focus on the **RF Attenuation** field
- **BW** key, with focus on the **RBW** field

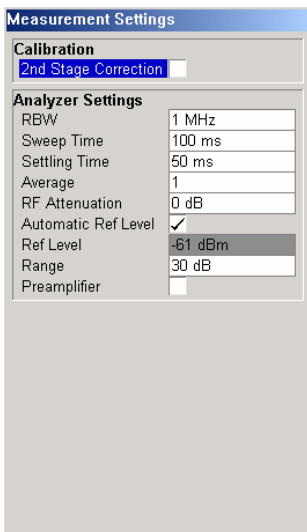

Under **Calibration**, the second stage correction can be activated or deactivated. For details refer also to "[Calibration](#)" on page 4.236.

Under **Analyzer Settings**, the general settings for the spectrum analyzer concerning the level, attenuation and bandwidth of the signal to be measured are defined.

The **Measurement Settings** dialog box contains the following elements:

Calibration	2nd Stage Correction
Analyzer Settings	RBW
	Sweep Time
	Settling Time
	Average
	RF Attenuation
	Automatic Ref Level
	Ref Level
	Range
	Preamplifier

2nd Stage Correction

Activates or deactivates the second stage correction.

On The calibration data recorded via the **Cal** softkey are used to correct the measurement results. The calibration data are stored independent of the state of the option.

Off No correction is applied to the measurement results.

For details refer also to "[Calibration](#)" on page 4.236.

→ Remote: CORR ON

RBW

Specifies the resolution bandwidth for the measurement.

A large value improves the averaging of the display considerably, reduces the influence of external sources of interference, and permits the fastest measurement time possible.

A low value should only be used across a very small frequency range. For measurements at low frequencies, the RBW must be reduced to prevent the LO frequency of the analyzer from invalidating the measurement. At receive frequencies of 100 kHz, the RBW must not exceed 10 kHz.

→ Remote: BAND 1MHz

Sweep Time

Specifies the time one complete measurement sweep takes. Two sweeps are performed for each measurement step (once with noise source on, once with noise source off).

For narrow bandwidths, the sweep time should be increased in order to give accurate measurement results.

→ Remote: SWE:TIME 10s

Settling Time

Specifies the time the DUT takes to settle after a noise source has been turned on or off.

Most noise sources generate an interfering DC component in addition to the noise spectrum. If the noise source is switched on or off, low-frequency DUTs may require this settling time for coupling capacitors to be charged or discharged.

→ Remote: SYST:CONF:DUT:STIM 1000MS

Average

Specifies the number of measurement sweeps over which the average is taken to produce the displayed measurement results.

The higher the number of sweeps, the more accurate the measurement results, but the measurement time is significantly longer.

An average value of 1 means that each displayed result is produced from one measurement sweep. This is sufficient for most cases.

→ Remote: SWE:COUN 10

RF Attenuation

Specifies the attenuation that is applied to the received RF signal.

To obtain a low noise figure for the analyzer and hence more accurate noise measurements, 0 dB should be set. For high DUT power levels or critical matching, a higher setting is also possible. A setting of 10 dB will give a much better VSWR (voltage standing wave ratio) of the analyzer, but will result in a worse noise figure of the analyzer.

→ Remote: INP:ATT 30 DB

Automatic Ref Level

Activates or deactivates the automatic reference level setting.

Off Specify a reference level manually (see **Ref Level** softkey).

On The reference level is measured automatically. The total measurement time increases.

The automatic reference level measurement is performed as follows:

– 2nd stage correction activated:

At the beginning of the calibration measurement, several measurements are performed at the first frequency test point and the reference level is calculated from these results taking into account the maximum gain of the DUT (see **Range** softkey).

– 2nd stage correction deactivated:

At the beginning of the main measurement, several measurements are performed at the first frequency test point and the reference level is calculated from these results. The range setting is not significant.

→ Remote: DISP:TRAC:Y:RLEV:AUTO ON

Ref Level

Specifies the reference level. It is only possible to enter a reference level manually, if the automatic reference level is deactivated (see **Automatic Ref Level** softkey).

The reference level should be about 5 to 15 dB above the noise display that occurs with the DUT connected and the noise source activated.

Even for DUTs with a high-ripple frequency response it can be useful to enter the reference level manually, because an automatic reference level setting may not always result in optimal settings.

→ Remote: DISP:TRAC:Y:RLEV 0

Range

Specifies the maximum gain expected from the DUT.

If the **2nd Stage Correction** is activated, this value is used to calculate the automatic reference level to ensure that the expected power of the measured signal will be within the optimum operating range of the spectrum analyzer (see **Automatic Ref Level** softkey).

To ensure accurate measurement results, the range should not exceed the actual gain of the DUT by more than a margin of 10 dB.

→ Remote: SYST:CONF:DUT:GAIN 10

Preamplifier

Activates or deactivates the preamplifier of the R&S FSL.

→ Remote: INP:GAIN:STAT ON

Schematic

Displays the schematic diagram of the test setup for the selected measurement type and the specified frequency ranges. If the frequency ranges are changed, the schematic diagram is updated accordingly.

– Direct measurement

The direct measurement mode is designed for DUTs without frequency-conversion, e.g. amplifiers.

The schematic display for the direct measurement mode is shown in Fig. 4-28. The upper part of the figure shows the setup for calibration. The lower part of the figure shows the test setup for the measurement.

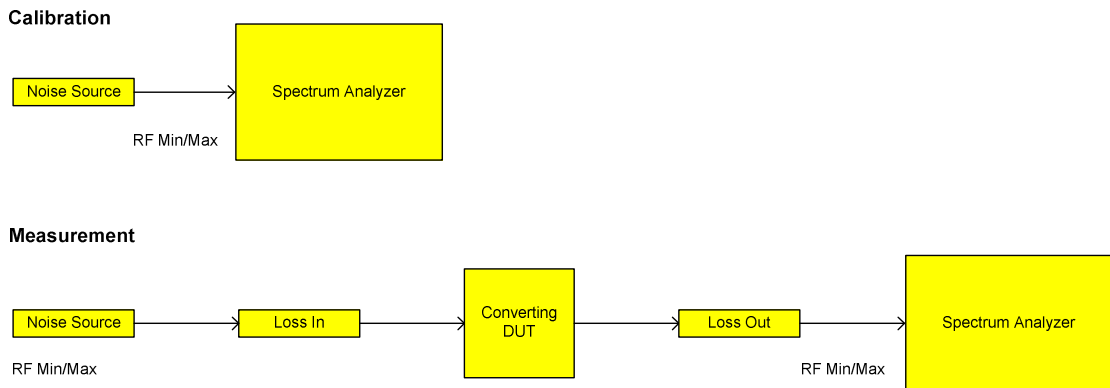

Fig. 4-28 Schematic diagram for direct measurements

– Frequency-converting measurement

The frequency-converting measurement mode is designed for frequency-converting DUTs that have a fixed Local Oscillator (LO) frequency, for example, satellite converters with a fixed LO frequency. .

The schematic display for the frequency-converting measurement mode is shown in Fig. 4-29. The upper part of the figure shows the setup for calibration. The lower part of the figure shows the test setup for the measurement.

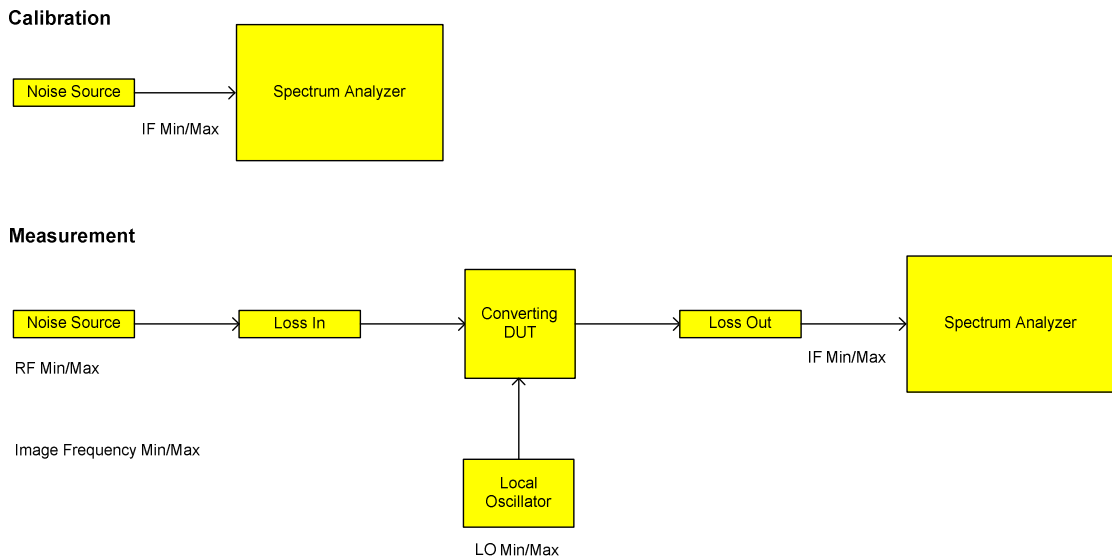

Fig. 4-29 Schematic diagram for frequency converting measurements

Build Tbl

Updates the table according to the **Frequency Settings (Freq Settings softkey)**.

Exit

Exits the edit mode of a table.

Insert

Inserts a row above the currently selected row and sets the focus on the first field of the new row.

This softkey is only available if the **Frequency Table** contains less than 100 measurement steps.

Delete

Deletes the currently selected row. This action requires no confirmation.

Softkeys of the sweep menu (Noise mode)

The following table shows all softkeys available in the sweep menu in **Noise** mode (**SWEEP** key). It is possible that your instrument configuration does not provide all softkeys. If a softkey is only available with a special option, model or (measurement) mode, this information is delivered in the corresponding softkey description.

Command
Sweep Single/Cont
Cal
Fix Freq

Sweep Single/Cont

Selects the sweep mode.

- Single** single sweep mode
Cont continuous sweep mode

If a measurement is started while another measurement is in progress, the first measurement will be aborted and the new measurement started immediately.

For further details refer to "[Measurement forms](#)" on page 4.237.

- Remote: CONF:LIST:CONT
- Remote: CONF:LIST:SING

Cal

Performs a calibration. The calibration status of the noise figure measurement is displayed in the title bar. For further details refer to "[Calibration](#)" on page 4.236.

This softkey is only available, if the **2nd Stage Correction** option in the Measurement Settings dialog box is activated.

- Remote: CONF:CORR

Fix Freq

Starts a fixed frequency measurement for the frequency that is currently selected in the **Frequency List Results**. For further details refer to "[Measurement forms](#)" on page 4.237 and "[Result displays](#)" on page 4.237.

This softkey is only available after a frequency list measurement has been completed and the measurement results are displayed in list form (**Display List/Graph** softkey).

- Remote: CONF:SING
- Remote: FREQ 10MHz

Softkeys of the trace menu (Noise mode)

Using the trace memory facility, you can save graphical display results (max. 3 trace sets) for comparison with subsequent measurements. This facility is recommended in order to compare and to document the effects of small changes on the DUT.

The following table shows all softkeys available in the trace menu in **Noise** mode (**TRACE** key). It is possible that your instrument configuration does not provide all softkeys. If a softkey is only available with a special option, model or (measurement) mode, this information is delivered in the corresponding softkey description.

Command
Display Graph/List
ASCII File Export
Decim Sep
More ↓
Data -> Mem1
Data -> Mem2
Data -> Mem3
Data On/Off
Mem1 On/Off
Mem2 On/Off
Mem3 On/Off

Display Graph/List

For details refer to the **Display List/Graph** softkey in the noise figure measurements menu.

ASCII File Export

For details refer to the **ASCII File Export** softkey in the trace menu of the base unit.

Decim Sep

For details refer to the **Decim Sep** softkey in the trace menu of the base unit.

Data -> Mem1/Data -> Mem2/Data -> Mem3

Saves the current trace results to trace memory <n>. If a trace memory <n> contains data, the corresponding softkey has a green background. The content of the trace memory <n> is displayed via the **Mem1 On/Off/Mem2 On/Off/Mem3 On/Off** softkeys.

If data is transferred to a trace memory that already contains trace data, the new trace data overwrite the current trace data in the memory.

- Remote: CONF:ARR:MEM2 ONCE
- Remote: FETC:ARR:MEM2:NOIS:FIG?
- Remote: FETC:ARR:MEM2:NOIS:GAIN?
- Remote: FETC:ARR:MEM2:NOIS:TEMP?

Data On/Off

Switches the display of the current measurement results on or off. The display of trace memory results is not affected if this softkey is pressed. If a new frequency list measurement is started, the display of the current result trace is switched on automatically.

→ Remote: DISP:CURR:DATA OFF

Mem1 On/Off / Mem2 On/Off / Mem3 On/Off

Switches the display of trace memory <n> on or off. This softkey is not available if no data is held in the selected trace memory.

→ Remote: DISP:ARR:MEM2 ON

Softkeys of the marker menu (Noise mode)

The following table shows all softkeys available in the marker menu in **Noise** mode (**MKR** key). It is possible that your instrument configuration does not provide all softkeys. If a softkey is only available with a special option, model or (measurement) mode, this information is delivered in the corresponding softkey description.

Command
Marker 1
Marker to Trace
All Marker Off

Marker 1

Activates marker 1 and opens an edit dialog box to enter a value for marker 1 to be set to. Pressing the softkey again deactivates the marker 1. This softkey is only available if measurement results are displayed.

This softkey is available from firmware version 1.60.

- Remote: CALC:MARK ON
- Remote: CALC:MARK:X 550 MHZ
- Remote: CALC:MARK:Y?

Marker to Trace

Opens a dialog box to select the trace (noise figure or gain), on which the marker is to be placed. This softkey is only available if measurement results are displayed.

This softkey is available from firmware version 1.60.

→ Remote: CALC:MARK:TRAC GAIN

All Marker Off

Switches off the active marker. This softkey is only available if measurement results are displayed.

This softkey is available from firmware version 1.60.

→ Remote: CALC:MARK:AOFF

Softkeys of the marker-> menu (Noise mode)

The following table shows all softkeys available in the marker-> menu in **Noise** mode (**MKR->** key). It is possible that your instrument configuration does not provide all softkeys. If a softkey is only available with a special option, model or (measurement) mode, this information is delivered in the corresponding softkey description.

Command
Peak
Min

Peak

Activates marker 1 and sets it to the highest maximum of the trace.

This softkey is available from firmware version 1.60.

→ Remote: CALC:MARK:MAX

Min

Activates marker 1 and sets it to the minimum of the selected trace.

This softkey is available from firmware version 1.60.

→ Remote: CALC:MARK:MIN

Softkeys of the lines menu (Noise mode)

The following table shows all softkeys available in the lines menu in **Noise** mode (**LINES** key). It is possible that your instrument configuration does not provide all softkeys. If a softkey is only available with a special option, model or (measurement) mode, this information is delivered in the corresponding softkey description.

Menu / Command	Command
New ↓	Exit
	Insert
	Delete
Edit ↓	same contents as New menu
Enable/Disable	
Delete	

New

Displays the **Limit Line** dialog box in edit mode with all fields necessary to define a new limit line. For further details see "[To work with limit lines](#)" on page 4.236.

In the edit mode, the **Limit Line** dialog box contains the following elements:

Name
Limit
Comment
Frequency
Limit

Name

Specifies the name of the limit line to uniquely identify every limit line. Any combination of alphanumeric characters is allowed. If the entered name already exists, an error message is displayed with the request to alter the name.

→ Remote: `CALC:LIM1:NAME FM1`

Limit

Specifies the result type (noise or gain) and the limit type (upper or lower) for the limit line.

→ Remote: `CALC:LIM2:TRAC NFIG`

Comment

Specifies a description for the limit line. Any combination of alphanumeric characters is allowed.

→ Remote: `CALC:LIM5:COMM 'Upper limit for spectrum'`

Frequency

Specifies the receive frequencies.

→ Remote: `CALC:LIM2:CONT 1MHz, 30MHz, 100MHz, 300MHz, 1GHz`

Limit

Specifies the limits for the receive frequencies.

→ Remote: `CALC:LIM2:LOW -30, -40, -10, -40, -30 (lower limit line)`

→ Remote: `CALC:LIM2:UPP -10, 0, 0, -10, -5 (upper limit line)`

Exit

Exits the edit mode of a table.

Insert

Inserts a row above the currently selected row and sets the focus on the first field of the new row.

Delete

Deletes the currently selected row. This action requires no confirmation.

Edit

Displays the **Limit Line** dialog box in edit mode with all data of the selected limit line. For further details refer to the **New** softkey.

Enable/Disable

Enables or disables the selected limit line. Limit checking is only performed for activated limit lines. Only one limit line of each type can be active at a given time.

- Remote: CALC:LIM:STAT ON
 - Remote: CALC:LIM4:LOW:STAT ON
 - Remote: CALC:LIM4:UPP:STAT ON
-

Delete

Deletes the selected limit line.

- Remote: CALC:LIM1:DEL
-

3GPP Base Station Measurements (Option K72)

The R&S FSL equipped with the 3GPP Base Station Measurements option performs code domain power measurements on downlink signals according to the 3GPP standard (Third Generation Partnership Project, FDD mode). Signals that meet the conditions for channel configuration of 3GPP standard test models 1 to 5 can be measured, including HSDPA and HSUPA signals (test model 5). In addition to the code domain power measurements specified by the 3GPP standard, the 3GPP Base Station Measurements option offers measurements with predefined settings in the frequency domain, e.g. power measurements.

This option is available from firmware version 1.60.

To open the settings menu

- If the **3G FDD BTS** mode is not the active measurement mode, press the **MODE** key and activate the **3G FDD BTS** option.
- If the **3G FDD BTS** mode is already active, press the **MENU** key.
The settings menu is displayed. .

Menu and softkey description

- ["Softkeys of the settings menu \(3G FDD BTS mode\)"](#) on page 4.262
- ["Softkeys of the frequency menu \(3G FDD BTS mode\)"](#) on page 4.266
- ["Softkeys of the amplitude menu \(3G FDD BTS mode\)"](#) on page 4.267
- ["Softkeys of the trigger menu \(3G FDD BTS mode\)"](#) on page 4.268
- ["Softkeys of the marker menu \(3G FDD BTS mode\)"](#) on page 4.268
- ["Softkeys of the marker-> menu \(3G FDD BTS mode\)"](#) on page 4.269
- ["Softkeys of the measurement menu \(3G FDD BTS mode\)"](#) on page 4.270

The span, bandwidth, and lines menus are not available in the **3G FDD BTS** mode. All other menus are provided as described for the base unit. For details refer to the corresponding menu descriptions.

To display help to a softkey, press the **HELP** key and then the softkey for which you want to display help. To close the help window, press the **ESC** key. For further information refer to section "How to use the Help System".

Further information

- ["Short list of abbreviations"](#) on page 4.260
- ["Channels of the Code Domain Channel Table and their usage"](#) on page 4.260
- ["Marker values"](#) on page 4.261

Measurements and result displays

The 3GPP Base Station Measurements option provides the following test measurement types and result displays:

- code domain power measurements
 - Code Domain Power Diagram (see **Code Dom Power Diagram** softkey)
 - Code Domain Channel Table (see **Code Dom Channel Table** softkey)
 - Code Domain Result Summary (see **Code Dom Result Summary** softkey)

The code domain power measurements are performed as specified by the 3GPP standards. A signal section of approx. 20 ms is recorded for analysis and then searched through to find the start of a 3GPP FDD frame. If a frame start is found in the signal, the code domain power analysis is performed for a complete frame starting from slot 0. The different result displays are calculated from the recorded IQ data set. Therefore it is not necessary to start a new measurement in order to change the result display. Common settings for these measurements are performed via the settings menu (**MENU** key). For details refer to "[Softkeys of the settings menu \(3G FDD BTS mode\)](#)" on page 4.262.

The measurement settings are listed below the title bar:

CF 3.0 GHz Result Summary

	Channel	0.256
Att 0 dB	CPICH Slot	0
Ref -20.0 dBm	Chan Slot	0

Parameter in example	Description
CF 3.0 GHz	center frequency
Result Summary	Code Domain Result Summary result display
Att 0 dB	attenuation
Ref -20.0 dBm	reference level
Channel 0.256	channel number and spreading code
CPICH Slot 0	common pilot channel slot number
Chan Slot 0	channel slot number

- RF measurements
 - Signal Channel Power (see **Power** softkey)
 - Adjacent-Channel Power (see **ACP** softkey)
 - Spectrum Emission Mask (see **Spectrum Emission Mask** softkey)

All these measurements are accessed via the **MEAS** key (measurement menu). Some parameters are set automatically according to the 3GPP standard. A list of these parameters is given with each measurement type. A set of parameters is passed on from the 3GPP Base Station Measurements option to the base unit and vice versa in order to provide a quick swap (see the following table).

Transferred parameters
center frequency
reference level
attenuation
reference level offset
center frequency step size
trigger source
trigger offset

For a detailed description refer also to chapter "Advanced Measurement Examples".

Short list of abbreviations

Term or abbreviation	Description
BTS	base transmission station
CPICH	common pilot channel
DPCH	dedicated physical channel, data channel
FDD	frequency division duplexing
PCCPCH	primary common control physical channel
PICH	paging indication channel.
SCH	synchronization channel, divided into P-SCH (primary synchronization channel) and S-SCH (secondary synchronization channel)

Channels of the Code Domain Channel Table and their usage

The channel assignment table contains the following (data) channels:

- CPICH
The common pilot channel is used to synchronize the signal in the case of CPICH synchronization. It is expected at code class 8 and code number 0.
- PSCH
The primary synchronization channel is used to synchronize the signal in the case of SCH synchronization. It is a non-orthogonal channel. Only the power of this channel is determined.
- SSCH
The secondary synchronization channel is a non-orthogonal channel. Only the power of this channel is determined.
- PCCPCH
The primary common control physical channel is used to synchronize the signal in the case of SCH synchronization. It is expected at code class 8 and code number 1.
- SCCPCH
The secondary common control physical channel is a QPSK-modulated channel without any pilot symbols. In the 3GPP test models, this channel can be found in code class 8 and code number 3. However, the code class and code number need not to be fixed and can vary. For this reason, the following rules are used to indicate SCCPCH.

HSDPA/HSUPA On/Off softkey set to Off

- Only one QPSK-modulated channel without pilot symbols is detected and displayed as the SCCPCH. Any further QPSK-modulated channels without pilot symbols are not detected as active channels.
- If the signal contains more than one channel without pilot symbols, the channel that is received in the highest code class and with the lowest code number is displayed as the SCCPCH. It is expected that only one channel of this type is included in the received signal. According to this assumption, this channel is probably the SCCPCH.

HSDPA/HSUPA On/Off softkey set to On

- All QPSK-modulated channels without pilot symbols are detected. If one of these channels is received at code class 8 and code number 3, it is displayed as the SCCPCH. QPSK-modulated channels without pilot symbols and a code class higher than or equal to 7 are marked with the

channel type CHAN. QPSK-modulated channels without pilot symbols and a code class lower than 7 are marked with channel type HSPDSCH.

- PICH
The paging indication channel is expected at code class 8 and code number 16.
- DPCH
The dedicated physical channel is a data channel that contains pilot symbols. The displayed channel type is DPCH. The status is **inactive** (channel is not active), **active** (channel is active and all pilot symbols are correct), or **pilotf** (channel is active but it contains incorrect pilot symbols).
- HS-PDSCH (HSDPA)
The high speed physical downlink shared channel does not contain any pilot symbols. It is a channel type that is expected in code classes equal to or higher than 7: HSPDSCH(QPSK)_ (QPSK-modulated slot of an HS-PDSCH channel), HSPDSCH(16QAM)_ (16QAM-modulated slot of an HS-PDSCH channel), HSPDSCH(NONE)_ (slot without power of an HS-PDSCH channel). The modulation type of these channels can be varied depending on the selected slot. The status is **inactive** (channel is not active) or **active** (channel is active and all pilot symbols are correct).
- HS-SSCH (HSDPA)
The high speed shared control channel does not contain any pilot symbols. It is a channel type that is expected in code classes equal to or higher than 7. The modulation type should always be QPSK. The channel does not contain any pilot symbols. The status is **inactive** (channel is not active) or **active** (channel is active and all pilot symbols are correct).
- CHAN
Any arbitrary channel that does not carry a valid pilot symbol sequence is displayed as an arbitrary channel. It is not possible to decide which channel type is transmitted. The only prerequisite is that the channel carries symbols of a sufficient signal to noise ratio.
 - Chan Type: CHAN (QPSK-modulated channel without any pilot symbols)
 - Status: inactive if the channel is not active; active if the channel is active
- E-HICH
Enhanced HARQ hybrid acknowledgement indicator channel
Carries hybrid ARQ ACK/NACK
- E-RGCH
Enhanced relative grant channel
Carries relative grant allocation for a UE
- E-AGCH
Enhanced absolute grant channel
Carries absolute grant allocation for a UE

Marker values

Additional to the marker values of the base unit, displayed in the marker field (for details see "[Using Markers and Delta Markers - MKR Key](#)" on page 4.48), the symbol rate of the channel (for unassigned codes 7.5 ksps, see example) is given.

M1[1]	-2.35 dB
222.512	SR 7.5 Ksps

Softkeys of the settings menu (3G FDD BTS mode)

The following table shows all softkeys available in the main menu of the 3GPP Base Station Measurements option (**MENU** key). It is possible that your instrument configuration does not provide all softkeys. If a softkey is only available with a special option, model or (measurement) mode, this information is delivered in the corresponding softkey description.

Menu / Command	Command
Select Channel	
Select CPICH Slot	
Code Power Abs/Rel	
Power Ref TOT/CPICH	
Scrambling Code ↓	Scrambling Code
	Scrambling Code Autosearch
	Show List
	Format Hex/Dec
Adjust Ref Level	
More ↓	
Invert Q On/Off	
Normalize On/Off	
Antenna Diversity On/Off	
Antenna Number 1/2	
Inactive Channel Threshold	
HSDPA/HSUPA On/Off	
Sync Type CPICH/SCH	

Select Channel

Opens an edit dialog box to enter the channel number and spreading factor, separated by a decimal point. The chosen channel is marked red in the Code Domain Power Diagram and this channel is used for channel-based evaluations in the Code Domain Result Summary.

Example:

entry 5.128

Channel 5 is marked at spreading factor 128 (30 ksps), if the channel is active; otherwise code 20 at spreading factor 512 is selected.

→ Remote: CDP:CODE 30

Select CPICH Slot

Opens an edit dialog box to enter the slot number. The chosen slot is evaluated in the Code Domain Power Diagram and is used for slot-based evaluations in the Code Domain Result Summary.

The slot number is defined on the basis of the CPICH (i.e. calculated in steps of 2560 chips starting from the beginning of the frame). The desired slot of the selected channel is converted according to its timing offset.

Example:

Slot 0 of the CPICH is set. The selected channel has a timing offset of 2816 chips, i.e. slot 0 of the channel is delayed by 2816 chips with respect to the frame start. Slot 0 of the CPICH therefore corresponds to slot 14 of the last frame of the channel.

→ Remote: CDP: SLOT 3

Code Power Abs/Rel (Code Domain Power Diagram)

Sets the scaling of the result display.

Abs absolute power in dB

Rel power relative to the reference chosen via the **Power Ref TOT/CPICH** softkey in dBm (default setting)

→ Remote: CALC: FEED 'XPOW: CDP'

Power Ref TOT/CPICH (Code Domain Power Diagram)

Sets the power reference for the relative power displays (see also **Code Power Abs/Rel** softkey):

TOT total power

CPICH power of the common pilot channel (default setting)

In contrast to the variable total power, the power of the CPICH is the same in all slots so that it can form the constant reference for the display.

→ Remote: CDP: PREF TOT

Scrambling Code

Opens the scrambling code menu.

Scrambling Code

Opens an edit dialog box to enter the scrambling code. The scrambling codes are used to distinguish between different base stations. Each base station has its own scrambling code. The scrambling code range in hexadecimal format is [0x0 ... 0x5FFF]

The scrambling codes are divided into 512 sets, each consisting of a primary scrambling code and 15 secondary scrambling codes.

The range of the primary scrambling codes is described by $n=16*i$ with $k=0$, $i \in [0 \dots 511] = [0 \dots 1FF]$.

The range of the secondary scrambling codes is described by $j=16*i+k$, with $k \in [1 \dots 15] = [1 \dots F]$.

Example:

To enter the primary scrambling code number '1', the digits '10' need to be entered. ($i = 1$, $k = 0$). The entered scrambling code has to coincide with that of the signal. Otherwise, a code domain power measurement of the signal is not possible.

→ Remote: CDP:LCOD #H2

Scrambling Code Autosearch

Searches automatically the scrambling code that leads to the highest signal power and stores it as new scrambling code for further measurements. All scrambling codes of the recorded signal are taken into account. As a prerequisite, the center frequency and level settings have to be correct.

The scrambling code search automatically determines the primary scrambling code number. The secondary scrambling code number is expected to be 0. Other scrambling codes can not be detected. Therefore, the range for detection is 0x0000 - 0x1FF0h, where the last digit is always 0.

→ Remote: CDP:LCOD:SEAR

Show List

Displays a result list of the automatic search sequence containing the highest power values calculated and the corresponding scrambling codes. The power shown is a coarse value for the CPICH power.

This softkey is only available after a scrambling code auto search has been performed (see **Scrambling Code Autosearch** softkey).

→ Remote: CDP:LCOD:SEAR:LIST?

Format Hex/Dec

Selects the display format of the scrambling codes:

Hex hexadecimal

Dec decimal

The default setting is hexadecimal.

→ Remote: CDP:LCOD #H2

→ Remote: CDP:LCOD:DVAL 3

Adjust Ref Level

Adjusts the reference level to the measured channel power. This ensures that the settings of the RF attenuation and the reference level are optimally adjusted to the signal level without overloading the R&S FSL or limiting the dynamic range by an S/N ratio that is too small.

→ Remote: CDP:LEV:ADJ

Invert Q On/Off

Switches the Q inversion on or off:

ON The sign of the Q-component of the signal is inverted.

OFF The sign of the Q-component of the signal remains unchanged (default setting).

→ Remote: CDP:QINV ON

Normalize On/Off

Activates and deactivates the elimination of the I/Q offset.

→ Remote: CDP:NORM ON

Antenna Diversity On/Off

Activates or deactivates the antenna diversity mode for the code domain power analysis. The default setting of this softkey is **OFF**. The diversity antennas are selected via the **Antenna Number 1/2** softkey.

→ Remote: CDP:ANT 1

Antenna Number 1/2

Switches between antenna set 1 or 2. The default setting of this softkey is **1**. This softkey is only available if the **Antenna Diversity On/Off** softkey is activated.

→ Remote: CDP:ANT 1

Inactive Channel Threshold

Opens an edit dialog box to set the minimum power threshold for a single channel (channel power compared to total signal power). Only channels with a signal power above this value are recognized as active channels. Channels with a signal power below this value are considered to be not active (irrespective of whether they contain pilot symbols or not).

The default value is -60 dB.

→ Remote: CDP:ICTR -10dB

HSDPA/HSUPA On/Off

Activates or deactivates the HSUPA/DPA channel detection and the display of the HSUPA/DPA channels in the channel table.

- ON** The high speed channels can be detected (default settings).
The modulation type (QPSK /16QAM) is detected.
- OFF** The high speed channel can not be detected.
Pilot symbols are detected.

→ Remote: CDP:HSDP OFF

Sync Type CPICH/SCH

Defines the synchronization. The default setting of this softkey is **CPICH**.

- CPICH** A synchronization to the CPICH control channel is performed. As a prerequisite, the CPICH control channel must be present in the signal.
- SCH** A synchronization without assuming the presence of a CPICH channel is performed.
While this setting can also be used with other channel configurations, but the probability of synchronization failure increases with the number of data channels.

→ Remote: CDP:STYP SCH

Softkeys of the frequency menu (3G FDD BTS mode)

The following table shows all softkeys available in the frequency menu in **3G FDD BTS** mode. It is possible that your instrument configuration does not provide all softkeys. If a softkey is only available with a special option, model or (measurement) mode, this information is delivered in the corresponding softkey description.

Command
Center
Stepsize Manual
Frequency Offset

Center

For details refer to the **Center** softkey in the frequency menu of the base unit.

Stepsize Manual

For details refer to the **Manual** softkey in the frequency menu of the base unit.

Frequency Offset

For details refer to the **Frequency Offset** softkey in the frequency menu of the base unit.

Softkeys of the amplitude menu (3G FDD BTS mode)

The following table shows all softkeys available in the amplitude menu in **3G FDD BTS** mode. It is possible that your instrument configuration does not provide all softkeys. If a softkey is only available with a special option, model or (measurement) mode, this information is delivered in the corresponding softkey description.

Command
Ref Level
Adjust Ref Level
Ref Level Offset
dB per Division
Reference Position
RF Atten Manual
RF Atten Auto

Ref Level

For details refer to the **Ref Level** softkey in the amplitude menu of the base unit.

Adjust Ref Level

For details refer to the **Adjust Ref Level** softkey in the settings menu.

Ref Level Offset

For details refer to the **Ref Level Offset** softkey in the amplitude menu of the base unit.

dB per Division

Opens an edit dialog box to set the scaling of the y-axis in dB.

→ Remote: `DISP:TRAC:Y:PDIV +10dB`

Reference Position

For details refer to the **Ref Level Position** softkey in the amplitude menu of the base unit.

RF Atten Manual

For details refer to the **RF Atten Manual** softkey in the amplitude menu of the base unit.

RF Atten Auto

For details refer to the **RF Atten Auto** softkey in the amplitude menu of the base unit.

Softkeys of the trigger menu (3G FDD BTS mode)

The following table shows all softkeys available in the trigger menu in **3G FDD BTS** mode. It is possible that your instrument configuration does not provide all softkeys. If a softkey is only available with a special option, model or (measurement) mode, this information is delivered in the corresponding softkey description.

Command
Trigger Source
Trigger Polarity Pos/Neg
Trigger Offset

Trigger Source

Opens the **Trigger Source** dialog box. In the 3GPP Base Station Measurements option, only the following trigger sources are available:

- **Free Run, External, IF Power**

For further details refer to the **Trg / Gate Source** softkey in the trigger menu of the base unit.

Trigger Polarity Pos/Neg

For details refer to the **Trg / Gate Polarity Pos/Neg** softkey in the trigger menu of the base unit.

Trigger Offset

For details refer to the **Trigger Offset** softkey in the trigger menu of the base unit.

Softkeys of the marker menu (3G FDD BTS mode)

The following table shows all softkeys available in the marker menu in **3G FDD BTS** mode. It is possible that your instrument configuration does not provide all softkeys. If a softkey is only available with a special option, model or (measurement) mode, this information is delivered in the corresponding softkey description.

Command
Marker 1
Marker 2
Marker 3
Marker 4
Marker Norm/Delta
Marker Zoom
All Marker Off

Marker 1/Marker 2/Marker 3/Marker 4/Marker Norm/Delta

For details refer to the **Marker 1, Marker 2, Marker 3, Marker 4, Marker Norm/Delta** softkeys in the trigger menu of the base unit.

Marker Zoom

Opens an edit dialog box to set the number of channels.

All Marker Off

For details refer to the **All Marker Off** softkey in the trigger menu of the base unit.

Softkeys of the marker-> menu (3G FDD BTS mode)

The following table shows all softkeys available in the marker-> menu in **3G FDD BTS** mode. It is possible that your instrument configuration does not provide all softkeys. If a softkey is only available with a special option, model or (measurement) mode, this information is delivered in the corresponding softkey description.

Command
Select 1 2 3 4 ↵
Peak
Next Peak
Next Peak Mode < abs >
CPICH
PCCPCH
More ↓
Select 1 2 3 4 ↵
Min
Next Min
Next Min Mode < abs >
CPICH
PCCPCH

Select 1 2 3 4 ↵

For further details refer to the **Select 1 2 3 4 ↵** softkey in the marker-> menu of the base unit.

Peak

For further details refer to the **Peak** softkey in the marker-> menu of the base unit.

Next Peak

For further details refer to the **Next Peak** softkey in the marker-> menu of the base unit.

Next Peak Mode < abs >

For further details refer to the **Next Peak Mode < abs >** softkey in the marker-> menu of the base unit.

CPICH

Sets the active marker/delta marker on the common pilot channel (code number 0 for spreading factor 256; corresponds to displayed code numbers 0 and 1 of the x-axis).

- Remote: CALC:MARK1:FUNC:CPIC
- Remote: CALC:MARK1:Y?
- Remote: CALC:DELT1:FUNC:CPIC
- Remote: CALC:DELT1:Y?

PCCPCH

Sets the active marker/delta marker on the primary common control physical channel (code number 1 for spreading factor 256; corresponds to displayed code numbers 2 and 3 of the x-axis).

- Remote: CALC:MARK1:FUNC:PCCP
- Remote: CALC:MARK1:Y?
- Remote: CALC:DELT1:FUNC:PCCP
- Remote: CALC:DELT1:Y?

Min

For further details refer to the **Min** softkey in the marker-> menu of the base unit.

Next Min

For further details refer to the **Next Min** softkey in the marker-> menu of the base unit.

Next Min Mode < abs >

For further details refer to the **Next Min Mode < abs >** softkey in the marker-> menu of the base unit.

Softkeys of the measurement menu (3G FDD BTS mode)

The following table shows all softkeys available in the measurement menu in **3G FDD BTS** mode. It is possible that your instrument configuration does not provide all softkeys. If a softkey is only available with a special option, model or (measurement) mode, this information is delivered in the corresponding softkey description.

Menu / Command	Submenu / Command	Submenu / Command	Command
Auto Level&Code			
Code Dom Channel Table			

Menu / Command	Submenu / Command	Submenu / Command	Command
Code Dom Power Diagram			
Code Dom Result Summary ↓	Select Channel		
	Result Summary Normal		
	Result Summary Extended		
Power ↓	CP / ACP Config ↓	# of TX Chan	
		# of Adj Chan	
		Channel Settings ↓	Channel Bandwidth
			Channel Spacing
			Chan Pwr/Hz
			ACP Ref Settings
			Adjust Ref Lvl
			Adjust Settings
		Limit Checking ↓	Limit Chk On/Off
			Edit ACP Limit
		Power Mode ↓	Clear/Write
			Max Hold
		Select Trace	
		Adjust Settings	
	Sweep Time		
	Fast ACP On/Off		
	ACP Abs/Rel		
	Adjust Ref Lvl		
ACP ↓	same contents as Power menu		
Spectrum Emission Mask ↓	Limit Line Auto		
	Limit Line Manual		
	Limit Line User ↓		
	Restore Std Lines		
	30kHz/1MHz Transition		
	Adjust Ref Level		

Auto Level&Code

Starts a sequence performing the following steps:

- Auto adjust the reference level.
- Search and select scrambling code with the highest power.
- Start measurement.
- Select Code Domain Result Summary result display.

→ Remote: CDP:ASEQ

Code Dom Channel Table

Selects the Code Domain Channel Table result display. This channel assignment table can contain up to 512 entries, corresponding to the 512 codes that can be assigned within the class of spreading factor 512. For detailed description of the channels refer to "Channels of the Code Domain Channel Table and their usage" on page 4.260.

The screenshot shows the 'Code Domain Channel Table' interface for a 2.1175 GHz signal. The main table lists channel parameters, and the sidebar on the right contains navigation buttons.

Chan Type	SymRate [ksps]	Chan	Status	PilotL [Bits]	PwrAbs [dBm]	PwrRel [dB]	T Offs [Chips]
CPICH	15	0	act.	0	18.62	0.00	0
PSCH	-----	-----	act.	0	15.65	-2.97	0
SSCH	-----	-----	act.	0	15.65	-2.97	0
PCCPCH	15	1	act.	0	18.62	0.00	0
SCCPCH	15	3	act.	0	15.62	-3.00	0
PICH	15	16	act.	0	10.63	-7.99	30720
DPCH	30	2	act.	8	15.62	-3.00	22016
DPCH	30	7	act.	8	8.60	-10.01	21248
DPCH	30	11	act.	8	15.63	-2.98	34304
DPCH	30	13	act.	8	10.59	-8.03	6400
DPCH	30	17	act.	8	14.59	-4.02	13312
DPCH	30	20	act.	8	14.63	-3.98	26368
DPCH	30	23	act.	8	13.63	-4.99	11520

Navigation sidebar options: Auto Level&Code, Code Dom Channel Table, Code Dom Power Diagram, Code Dom Result Summary, Power, ACP, Spectrum Emission Mask.

In the upper part of the Code Domain Channel Table, all channels that have to be present in the signal to be analyzed are listed. In the lower part of the table, all data channels contained in the signal are listed. A data channel is any channel that does not have a predefined channel number and symbol rate.

The channels are listed in descending order according to symbol rates and, within a symbol rate, in ascending order according to the channel numbers. Therefore, the unassigned codes are always to be found at the end of the table.

The following parameters of these channels are determined by the code domain power measurement:

- **Chan Type**
type of channel (active channels only)
If the modulation type of a channel can vary (HS-PDSCH), the value of the measured modulation type is appended to the channel type. Data channels without a type fully recognized are characterized as CHAN.
- **SymRate [ksps]**
symbol rate at which the channel is transmitted (7.5 ksps to 960 ksps).
- **Chan**
number of the channel spreading code (0 to [spreading factor-1]).
- **Status**
Unassigned codes are considered to be inactive. A data channel is considered to be active if the required pilot symbols (see 3GPP specification, exception: PICH) are to be found at the end of each slot. In addition, the channel should have minimum power (see **Inactive Channel Threshold** softkey).
- **PilotL [Bits]**
number of pilot bits of the channel

- **PwrAbs [dBm]/ PwrRel [dB]**

indication of the absolute and relative channel power (referenced to the CPICH or the total power of the signal)

- **T Offs [Chips]**

timing offset = offset between the start of the first slot of the channel and the start of the analyzed 3GPP FDD frame

→ Remote: CALC:FEED 'XTIM:CDP:ERR:CTAB'

→ Remote: TRAC? CTAB

Code Dom Power Diagram

Selects the Code Domain Power Diagram result display. Common settings for code domain power measurements are performed via the settings menu (**MENU** key). For details refer to "[Softkeys of the settings menu \(3G FDD BTS mode\)](#)" on page 4.262.

This result display shows the power of all occupied code channels in a bar graph. The x-axis is scaled for the highest code class or the highest spreading factor (512). Code channels with a lower spreading factor occupy correspondingly more channels of the highest code class. The power of a code channel is always measured according to its symbol rate. Unused code channels are assumed to belong to the highest code class and displayed accordingly. The displayed power of an unused code channel therefore corresponds to the power of a channel with the spreading factor 512 at the respective code position.

The measured power always refers to one slot. The time reference for the start of a slot is the CPICH slot. If the signal contains channels with timing offsets, the start of a slot of the channel may be different from the CPICH slot start. This leads to the power of the bar graphs normally being averaged over two adjacent slots in such cases. The power shown in the bar graphs thus does not necessarily correspond to the slot power of the channel the bar graph belongs to.

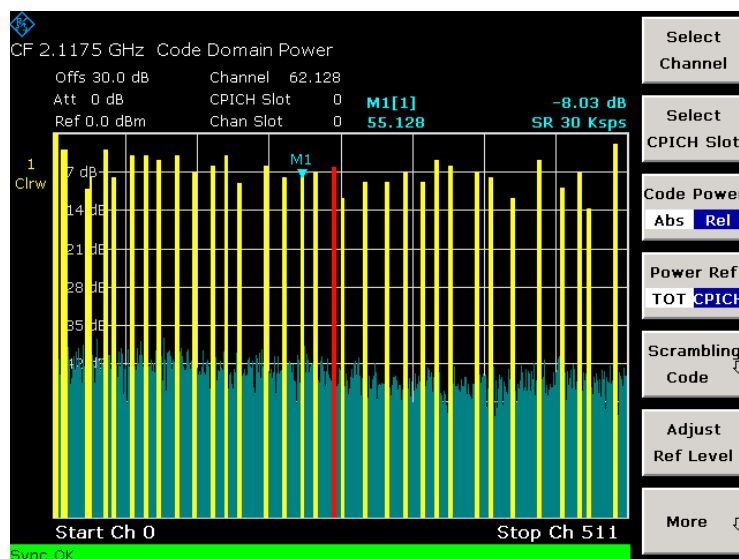

Detected channels are displayed in yellow color.

The codes where no channel could be detected (non-active channels) are displayed in blue color. These channels should be checked for their pilot symbols.

The channel that is adjusted via the **Select Channel** softkey is marked red. If it is an assigned channel, the entire channel is marked red. If it is an unassigned code, only the entered code is marked.

If the **HSDPA/HSUPA On/Off** softkey is activated, the detection of channels does not depend on pilot sequences. An active channel merely has to exceed the minimum power (see **Inactive**

Channel Threshold softkey). Therefore channels of the type HS-PDSCH are recognized as active (see also **Code Dom Channel Table** softkey).

- Remote: CALC:FEED 'XPOW:CDP'
- Remote: TRAC? TRACE1

Code Dom Result Summary

Opens a submenu to display the Result Summary.

Result Summary Normal

Selects the normal Code Domain Result Summary result display.

This result display shows the most important measurement results in one table with big letters. Via the **Result Summary Extended** softkey you can switch to the extended Code Dom Result Summary result display.

- **Total Power**

total signal power (average power of total evaluated 3GPP FDD frame).

- **Carrier Frequency Error**

frequency error relative to the center frequency of the R&S FSL

The absolute frequency error is the sum of the R&S FSL and DUT frequency error. The specified value is averaged via one slot; the frequency offset of the selected slot applies (via **Select CPICH Slot** softkey). The maximum frequency error that can be compensated is specified in the table below as a function of the sync mode. Transmitter and receiver should be synchronized as far as possible (see chapter 2).

Sync Type	Antenna diversity	Max. Freq. Offset
CPICH	X	5.0 kHz
SCH	OFF	1.6 kHz
SCH	ANT 1	330 Hz
SCH	ANT 2	330 Hz

- **Composite EVM**

difference between the test signal and the ideal reference signal

- **Peak Code Domain Error**

projection of the difference between the test signal and the ideal reference signal onto the selected spreading factor

- **No of Active Channels**

number of active channels detected in the signal (Both the detected data channels and the control channels are considered active channels.)

- Remote: CALC:FEED 'XTIM:CDP:ERR:SUMM'
- Remote: CALC:MARK:FUNC:WCDP:RES? CDP
- Remote: TRAC? TRACE1

Result Summary Extended

Extends the number of results shown in the normal Code Dom Result Summary result display (**Result Summary Normal** softkey) by the results listed below.

This result display consists of two panes. The **Global Results** (upper pane) contains the results for the total signal. The **Channel Results** (lower pane) lists the measurement results of the selected channel (marked red in the Code Domain Power Diagram).

– **Chip Rate Error**

chip rate error in ppm

As a result of a high chip rate error, symbol errors arise and the code domain power measurement is possibly not synchronized to the 3GPP FDD signal. The result is valid even if synchronization of the R&S FSL and signal failed.

– **Trigger to Frame**

time difference between the beginning of the recorded signal section to the start of the analyzed 3GPP FDD frame

In the case of triggered data collection, this difference is identical with the time difference of frame trigger (+ trigger offset) - frame start. If synchronization of the R&S FSL and W-CDMA signal fails, the **Trigger to Frame** value is not significant.

– **IQ Offset**

DC offset of signals in %

– **IQ Imbalance**

I/Q imbalance of signal in %

– **CPICH Slot No**

number of the CPICH slot at which the measurement is performed (selected via the **Select CPICH Slot** softkey).

– **CPICH Power**

power of the common pilot channel

– **Symbol Rate**

symbol rate at which the channel is transmitted

– **RHO**

quality parameter for every slot

– **Channel Code**

number of the spreading code of the selected channel

– **Timing Offset**

offset between the start of the first slot in the channel and the start of the analyzed 3GPP FDD frame

– **No of Pilot Bits**

number of pilot bits of the selected channel

– **Channel Slot No**

channel slot number, obtained by combining the value of the **Select CPICH Slot** softkey and the channel's timing offset

– **Channel Power Rel / Abs**

channel power, relative (see **Power Ref TOT/CPICH** softkey) and absolute.

- **Symbol EVM**
Peak (%Pk) or average (%rms) of the results of the error vector magnitude
- **Modulation Type**
modulation type of an HSDPA channel (QPSK or 16QAM modulation)

→ Remote: CDP:RSUM EXT

Power

Activates the measurement of the 3GPP FDD signal channel power and opens a submenu. This measurement is identical to the ACP measurement (see **ACP** softkey), the default settings are in accordance with the 3GPP specifications:

Parameter	Default setting
CP / ACP Standard	W-CDMA 3GPP FWD
# of Adj Chan	0 (all adjacent channels deactivated)

The R&S FSL measures the unweighted RF signal power in a bandwidth of

$$f_{BW} = 5\text{ MHz} \geq (1 + \alpha) \cdot 3.84\text{ MHz} \quad | \quad \alpha = 0.22$$

The power is measured in zero span using a digital channel filter of 5 MHz in bandwidth. According to the 3GPP standard, the measurement bandwidth (5 MHz) is slightly larger than the minimum required bandwidth of 4.7 MHz.

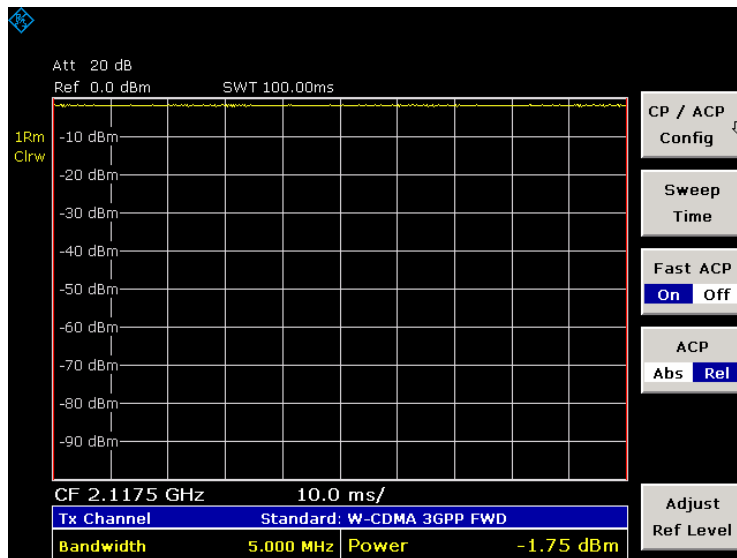

- Remote: CONF:WCDP:MEAS POW
- Remote: CALC:MARK:FUNC:POW:RES? CPOW
- Remote: TRAC? TRACE1

CP / ACP Config

For further details refer to the **CP / ACP Config** softkey in the power measurement menu of the base unit.

of TX Chan

For further details refer to the **# of TX Chan** softkey in the power measurement menu of the base unit.

of Adj Chan

For further details refer to the **# of Adj Chan** softkey in the power measurement menu of the base unit.

Channel Settings

For further details refer to the **Channel Settings** softkey in the power measurement menu of the base unit.

Channel Bandwidth

For further details refer to the **Channel Bandwidth** softkey in the power measurement menu of the base unit.

Channel Spacing

For further details refer to the **Channel Spacing** softkey in the power measurement menu of the base unit.

Chan Pwr/Hz

For further details refer to the **Chan Pwr/Hz** softkey in the power measurement menu of the base unit.

ACP Ref Settings

For further details refer to the **ACP Ref Settings** softkey in the power measurement menu of the base unit.

Limit Checking

For further details refer to the **Limit Checking** softkey in the power measurement menu of the base unit.

Limit Chk On/Off

For further details refer to the **Limit Chk On/Off** softkey in the power measurement menu of the base unit.

Edit ACP Limit

For further details refer to the **Edit ACP Limit** softkey in the power measurement menu of the base unit.

Power Mode

For further details refer to the **Power Mode** softkey in the power measurement menu of the base unit.

Clear/Write

For further details refer to the **Clear/Write** softkey in the power measurement menu of the base unit.

Max Hold

For further details refer to the **Max Hold** softkey in the power measurement menu of the base unit.

Select Trace

For further details refer to the **Select Trace** softkey in the power measurement menu of the base unit.

Adjust Settings

For further details refer to the **Adjust Settings** softkey in the power measurement menu of the base unit.

Sweep Time

For further details refer to the **Sweep Time** softkey in the power measurement menu of the base unit.

Fast ACP On/Off

For further details refer to the **Fast ACP On/Off** softkey in the power measurement menu of the base unit.

ACP Abs/Rel

For further details refer to the **ACP Abs/Rel** softkey in the power measurement menu of the base unit.

Adjust Ref Lvl

For further details refer to the **Adjust Ref Level** softkey in the power measurement menu of the base unit.

ACP

Activates the Adjacent-Channel Power measurement and opens a submenu for configuration. This measurement is identical to the ACP measurement of the base unit (see **CP, ACP, MC-ACP** softkey in the measurement menu of the base unit), but the default settings are in accordance with the 3GPP specifications:

Parameter	Default setting
CP / ACP Standard	W-CDMA 3GPP FWD
# of Adj Chan	2

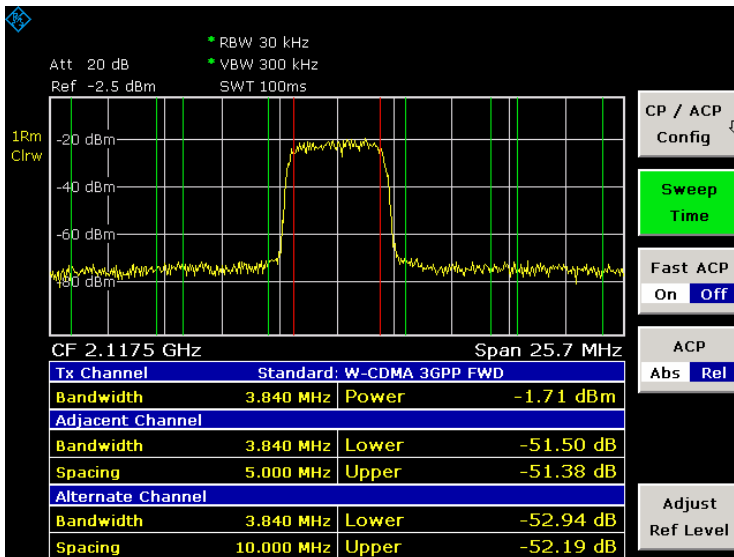

The R&S FSL measures the channel power and the relative power of the adjacent channels/alternate channels. The results are displayed below the screen.

- Remote: CONF:WCDP:MEAS ALCR
- Remote: CALC:MARK:FUNC:POWer:RES? ACP

Spectrum Emission Mask

Activates the Spectrum Emission Mask measurement and opens a submenu. This measurement compares the signal power in defined carrier offset ranges with the maximum values specified by 3GPP.

The following default settings are used in accordance with the 3GPP specifications:

Parameter	Default setting
CP / ACP Standard	W-CDMA 3GPP REV
# of Adj Chan	0
Span	25.5 MHz
BW	50 ms



Additional to the graphical result display, the peak list displays the peaks of the frequency ranges specified by the 3GPP specification. The table contains the following information:

Tx Power	power of the transmission channel
Tx Bandwidth	bandwidth used to measure the Tx power
Range	upper and lower frequency of the evaluated range relative to the center frequency
RBW	bandwidth used to measure the evaluated range
Frequency	exact frequency where the peak was detected
Level	absolute level of the peak
Pwr Rel	peak level relative to the Tx power
Delta	level relative to the limit. Positive Values show that the peak exceeds the limit from the specification. The values Level, Pwr Rel and Delta therefore change their color to red and an asterisk appears beside the Delta values.

→ Remote: CONF:WCDP:MEAS ESP

→ Remote: TRAC? TRACE1

Limit Line Auto

If activated, sets the limit line automatically according to the power determined in the useful channel. If the measurement is carried out in continuous sweep mode and the channel power changes from sweep to sweep, this can result in the limit line being continuously redrawn. This softkey is activated by default.

If deactivated, the limit line settings are defined via the **Limit Line Manual** softkey.

→ Remote: CALC:LIM:ESP:MODE AUTO

Limit Line Manual

Opens the **Manual Power** dialog box to select one of the following predefined limit lines according to the expected power range:

$P \geq 43 \text{ dBm}$

$39 \text{ dBm} \leq P < 43 \text{ dBm}$

$31 \text{ dBm} \leq P < 39 \text{ dBm}$
 $P < 31 \text{ dBm}$

The power at the different frequency offsets is compared with the selected limit line.

- Remote: `CALC:LIM:ESP:MODE MAN`
 - Remote: `CALC:LIM:ESP:VAL 39`
-

Limit Line User

Opens the lines menu of the base unit and switches to the standard limit line handling of the base unit. For details refer to section "[Softkeys of the lines menu](#)" on page 4.116 of the base unit.

- Remote: `CALC:LIM:ESP:MODE USER`
-

Restore Std Lines

Restores the limit lines defined according to the standard to their factory-set values.

- Remote: `CALC:LIM:ESP:REST`
-

30kHz/1MHz Transition

Defines the offset frequency at which the resolution bandwidth is changed in the range from 30 kHz to 1 MHz. The default value is 4.0 MHz.

- Remote: `CALC:LIM:ESP:TRAN 5MHZ`
-

Adjust Ref Level

Adjusts the reference level to the total signal power measured. This softkey becomes active after the occupied bandwidth has been measured in the first sweep and therefore the total signal power is known.

This ensures that the signal path is not overdriven and that the dynamic range is not limited by a reference level that is too low.

- Remote: `POW:ACH:PRES:RLEV`
-

CDMA2000 BTS Analyzer (Option K82)

The R&S FSL equipped with the CDMA2000 BTS Analyzer option performs Code Domain measurements on forward link signals according to the 3GPP2 Standard (Third Generation Partnership Project 2). The "Recommended Minimum Performance Standard for CDMA2000 Spread Spectrum Base Stations", C.S0010-C version 2.0 dated March 2006, is taken as a basis. This Standard has been approved by the following authority with the specified designation:

- TIA: TIA-97-F-1
- TTA: TTAT.3G-C-S0010-C v2.0

When the CDMA2000 specification is mentioned in the document, these standards are meant.

The CDMA2000 BTS Analyzer option supports the radio configurations 1 to 5, i.e. all radio configurations with a single carrier (1X) are supported. Accordingly, IS95A/B signals conforming to radio configurations 1&2 can be measured with the CDMA2000 BTS Analyzer option. In addition to the measurements called for by the CDMA2000 standard in the code domain, the CDMA2000 BTS Analyzer option features measurements in the spectral range such as channel power, adjacent channel power, occupied bandwidth and spectrum emission mask with predefined settings.

This option is available from firmware version 1.90.

To open the CDMA2000 BTS Analyzer

- If the **CDMA2000 BTS Analyzer** mode is not the active measurement mode, press the **MODE** key and activate the **CDMA2000 BTS Analyzer** option.
- If the **CDMA2000 BTS Analyzer** mode is already active, press the **MENU** key.
The Code Domain Analyzer menu is displayed. .

Menu and softkey description

- ["Softkeys of the Code Domain Analyzer menu \(CDMA2000 BTS Analyzer mode\)"](#) on page 4.292
- ["Softkeys of the frequency menu \(CDMA2000 BTS Analyzer mode\)"](#) on page 4.320
- ["Softkeys of the span menu \(CDMA2000 BTS Analyzer mode\)"](#) on page 4.321
- ["Softkeys of the amplitude menu \(CDMA2000 BTS Analyzer mode\)"](#) on page 4.322
- ["Softkeys of the bandwidth menu \(CDMA2000 BTS Analyzer mode\)"](#) on page 4.323
- ["Softkeys of the sweep menu \(CDMA2000 BTS Analyzer mode\)"](#) on page 4.324
- ["Softkeys of the trigger menu \(CDMA2000 BTS Analyzer mode\)"](#) on page 4.325
- ["Softkeys of the trace menu \(CDMA2000 BTS Analyzer mode\)"](#) on page 4.326
- ["Softkeys of the marker menu \(CDMA2000 BTS Analyzer mode\)"](#) on page 4.327
- ["Softkeys of the marker-> menu \(CDMA2000 BTS Analyzer mode\)"](#) on page 4.328
- ["Softkeys of the measurement menu \(CDMA2000 BTS Analyzer mode\)"](#) on page 4.330

The lines menu is not available in the **CDMA2000 BTS Analyzer** mode.

The span menu is not available for code domain measurements and signal power measurements. For details refer to the corresponding menu descriptions of the base unit ("[Setting the Frequency Span - SPAN Key](#)").

The bandwidth menu is not available for code domain measurements and CCDF measurements. For details refer to the corresponding menu descriptions of the base unit ("[Setting the Bandwidths and Sweep Time - BW Key](#)").

To display help to a softkey, press the **HELP** key and then the softkey for which you want to display help. To close the help window, press the **ESC** key. For further information refer to section "How to use the Help System" in the Quick Start Guide.

Further information

- "Predefined Channel Tables" on page 4.289
- "Relationship between channel type and modulation type" on page 4.291
- "Short list of terms and abbreviations" on page 4.291
- "Hadamard and BitReverse Code Tables" on page 4.337

Tasks

- "To edit a channel table" on page 4.283
- "To create a channel table" on page 4.284
- "To copy a channel table" on page 4.284

Measurements and result display

The **CDMA2000 BTS Analyzer** option provides the following test measurement types and result displays. All measurements and result displays are accessed via the **MEAS** key (measurement menu). "Code Domain Analysis" on page 4.284

- "Signal Channel Power" on page 4.286
- "Adjacent Channel Power" on page 4.286
- "Spectrum Emission Mask" on page 4.287
- "Occupied Bandwidth" on page 4.287
- "Complementary Cumulative Distribution Function" on page 4.288

To edit a channel table

1. Enter the **Channel Table Settings** menu and the corresponding dialog box is displayed.
2. Select the channel table to be edited by marking the check box.
3. Press the **Edit** softkey and the **Edit Channel Table** dialog box is displayed.

Each row in the table represents one channel. Channels are displayed as entered and not sorted automatically. To sort the channels use the **Sort** softkey (for details on how sorting is done see the **Sort** softkey).

4. Enter a name and a description of the channel table in the **Name** and **Description** field.
5. Add and delete channels by using the corresponding softkeys.
6. To edit an existing channel put the focus on the parameter to be changed.
 - Choose a channel type from the dropdown menu (opens with the **ENTER** key) in the **Channel Type** column. No channel types other than the ones found in the list can be chosen.
 - Assign a channel number in the **Walsh Ch.SF** column. Note that some channel types have predefined values and can not be edited.
 - Choose a radio configuration in the **Radio Configuration** column.
 - Activate or deactivate a channel in **State** column.
 - The columns **Symbol Rate/ kbps**, **Power/ dB** and **Domain Conflict** can not be edited. The values are calculated automatically.

For further details also refer to the **Edit** channel table dialog box.

To create a channel table

1. Enter the **Channel Table Settings** menu and the corresponding dialog box is displayed.
2. Press the **New** softkey and a new channel table by the name 'ChannelTable' will be added. The new channel table contains no channels by default.

For further details refer to the **New** softkey as well as "[To edit a channel table](#)" on page 4.283.

To copy a channel table

1. Enter the **Channel Table Settings** menu and the corresponding dialog box is displayed.
2. Select the channel table to be copied by marking the check box.
3. Press the **Copy** softkey and the channel table in focus is copied. The copy is named 'Copy of <SourceChannelTableName>'. Except the name, all elements of the channel table in focus are copied.

For further details refer to the **Copy** softkey as well as "[To edit a channel table](#)" on page 4.283. Measurements and result display

Measurements and result display

The **CDMA2000 BTS Analyzer** option provides the following test measurement types and result displays. All measurements and result displays are accessed via the **MEAS** key (measurement menu). "[Code Domain Analysis](#)" on page 4.284

- "[Signal Channel Power](#)" on page 4.286
- "[Adjacent Channel Power](#)" on page 4.286
- "[Spectrum Emission Mask](#)" on page 4.287
- "[Occupied Bandwidth](#)" on page 4.287
- "[Complementary Cumulative Distribution Function](#)" on page 4.288

Code Domain Analysis

The Code Domain Analyzer performs measurements in the code domain. The following measurement types and corresponding result displays are available:

Softkey	Definition
Code Domain Power	Code Domain Power result display in relative or absolute scaling
Channel Table	Channel occupancy table
Power vs PCG	Power of the selected channel versus all PCGs
Result Summary	Results in tabular form
Code Domain Error	Code Domain Error Power result display
Composite EVM	Averaged error between the test signal and the ideal reference signal
Peak Code Domain Error	Projection of the maximum error between the test signal and the reference signal
Channel Constell	Channel Constellation result display
EVM vs Symbol	Error Vector Magnitude result display
Composite Constell	Composite Constellation result display
Power vs Symbol	Power of the selected channel and of the selected PCG versus all symbols
Channel Bitstream	Display of decided bits

In the Code Domain Analyzer, the results are displayed in either one screen or in two screens (see **Screen Size Full/Split** softkey). Any result can be displayed in either screen. On top of the measurement screens the following settings and measurement results (so called result displays) are displayed (with the respective default settings):

Frequency: 2.4020 Ghz	Ref. Level: -20.00 dBm	Ref. Lvl Offset: 0.0 dB
Power Ref: PICH	Count: 0	Attenuation: 0 dB
PCG: 0	Channel: 0.64	Symbol Rate: 19.2 ksps

The result displays are defined in the following way:

Parameter	Defined in
Frequency	Frontend Settings dialog box, Center field
Power Ref	Result Settings dialog box, Power Reference field
PCG	Result Settings dialog box, Power Control Group field
Ref. Level	Frontend Settings dialog box, Ref. Level field
Count	SWEEP menu, Sweep Count softkey
Attenuation	Frontend Settings dialog box, RF Attenuation Auto field
Ref. Lvl Offset	Frontend Settings dialog box, Ref. Level Offset field
Channel	Result Settings dialog box, Channel (Code) Number field
Symbol Rate	Automatically calculated (see Add Channel softkey)

In the default setting after the preset, the analyzer is in **Spectrum Analyzer** mode (for details see "[Initializing the Configuration - PRESET Key](#)" on page 4.2). The settings of the Code Domain Analyzer are not active until the **CDMA2000 BTS Analyzer** mode is activated (see "[To open the CDMA2000 BTS Analyzer](#)" on page 4.282)

Table 4-9: Initial configuration of the Code Domain Analyzer

Parameter	Setting
digital standard	CDMA2000
sweep	continuous
channel table	auto search
trigger source	free run
trigger offset	0 s
PN offset	0 chips
inactive channel threshold	-60 dB
channel (code) number	0
power control group	0
capture length	3 PCGs (where PCG stands for Power Control Group)
code order	Hadamard
antenna diversity	OFF

In order to provide a quick swap from the base unit to the CDMA2000 BTS Analyzer option, some parameters are passed on.

Transferred parameter
Reference level
Ref Level Offset
Center Frequency
Attenuation

Signal Channel Power

The Power measurement analyses the RF signal power of a single channel with 1.2288 MHz bandwidth over a single trace. The displayed results are based on the root mean square.

The configuration is according to the CDMA2000 requirements.

Beneath the measurement screen the bandwidth and the associated channel power are displayed. The other screen elements match that of the screen of the Spectrum Analyzer mode.

The default settings are in accordance with the 3GPP2 specifications.

Setting	Default value
Frequency Span	2 MHz
ACP Standard	CDMA2000 MC1
Number of adjacent channels	0
Adjacent Channel Power	On

In order to provide a quick swap from the base unit to the CDMA2000 BTS Analyzer option, some parameters are passed on.

Transferred parameter
Reference Level
Ref Level Offset
RBW
VBW
of Samples

Refer also to the **Power** softkey in the measurement menu.

Adjacent Channel Power

The Adjacent Channel Power measurement analyses the power of the TX channel and the power of adjacent and alternate channels on the left and right side of the TX channel. The number of TX channels and adjacent channels can be modified as well as the band class.

Beneath the measurement screen the bandwidth and power of the TX channel and the bandwidth, spacing and power of the adjacent and alternate channels are displayed.

The default settings are in accordance with the 3GPP2 specifications.

Setting	Default value
Adjacent Channel Power	On
ACP Standard	CDMA2000 MC1
Number of adjacent channels	2

In order to provide a quick swap from the base unit to the CDMA2000 BTS Analyzer option, some parameters are passed on.

Transferred parameter
Reference Level
Ref Level Offset
RBW
VBW
of Adjacent Channels
Sweep Time
Span
Fast ACP Mode

For details on the softkeys of the Adjacent Channel Power measurement refer to the **Adjacent Channel Power** softkey in the measurement menu.

Spectrum Emission Mask (see Spectrum Emission Mask softkey)

measurement: Spectrum Emission Mask (K82) Spectrum Emission Mask (K82) The Spectrum Emission Mask measurement shows the quality of the measured signal by comparing the power values in the frequency range near the carrier against a spectral mask that is defined by the 3GPP2 specifications. The limits depend on the selected bandclass. In this way, the performance of the DUT can be tested and the emissions and their distance to the limit be identified.

Note that the 3GPP2 standard does not distinguish between spurious and spectral emissions.

Beneath the measurement screen a table showing the peak list. In the peak list the values for the worst spectral emissions are displayed including their frequency and power.

The default settings of the Spectrum Emission Mask measurement are listed in the table below.

Setting	Default value
Frequency Span	8 MHz
Sweep Time	100 ms
Detector	RMS

In order to provide a quick swap from the base unit to the CDMA2000 BTS Analyzer option, some parameters are passed on.

Transferred Parameter
Reference Level
Ref Level Offset
Center Frequency
Frequency Offset
Trigger settings

For details on the softkeys of the Spectrum Emission Mask measurement refer to the **Spectrum Emission Mask** softkey in the measurement menu.

Occupied Bandwidth

The Occupied Bandwidth measurement determines the bandwidth in which the signal power can be found. By default the bandwidth is displayed in which 99% of the signal is found. The percentage of the signal power included in the measurement can be modified.

In the top right corner of the screen, the bandwidth and frequency markers are displayed.

The default settings of the Occupied Bandwidth measurement are listed in the table below.

Setting	Default value
Occupied Bandwidth	ON
Frequency Span	4.2 MHz
Sweep Time	100 ms
RBW	30 kHz
VBW	300 kHz
Detector	RMS

In order to provide a quick swap from the base unit to the CDMA2000 BTS Analyzer option, some parameters are passed on.

Transferred parameter
Reference Level
Ref Level Offset
RBW
VBW
Sweep Time
Span

For details on the softkeys of the Occupied Bandwidth measurement see **Occupied Bandwidth** in the measurement menu.

Complementary Cumulative Distribution Function (CCDF)

The CCDF measurement displays the CCDF and the Crest factor. The CCDF shows distribution of the signal amplitudes. For the measurement, a signal section of settable length is recorded continuously in a zero span. The measurement is useful to determine errors of linear amplifiers.

The Crest factor is defined as the difference of the peak power and the mean power.

Beneath the measurement screen a table containing the number of included samples, mean and peak power and the Crest factor is displayed.

The default settings of the CCDF measurement are listed in the table below.

Setting	Default value
CCDF	ON
RBW	10 MHz
Detector	Sample

In order to provide a quick swap from the base unit to the CDMA2000 BTS Analyzer option, some parameters are passed on.

Transferred parameter
Reference Level
Ref Level Offset
RBW
of Samples

For details on the softkeys of the CCDF measurement see **CCDF** in the measurement menu.

In a transition from the base unit to the CDMA2000 BTS Analyzer option, external trigger sources are preserved, all other trigger sources are switched to the **Free Run** trigger mode. Additional trigger settings are preserved.

For a detailed description refer also to chapter "Advanced Measurement Examples".

Predefined Channel Tables

Predefined channel tables offer access to a quick configuration for the channel search. The **CDMA2000 BTS Analyzer** option provides the following set of channel tables compliant with the CDMA2000 specification:

- RECENT

This channel table always appears first in the list. It contains the channels that were automatically created during the last measurement with **Auto Search** channels activated (for details refer to **Channel Table Settings**).

- MPC_RC1 (Base Station Main Path 6 Channels Radio Configuration 1)

Channel table with F-PICH/F-SYNC/F-PCH and 6 data channels (see Table 4-10).

- MPC_RC4 (Base Station Main Path 6 Channels Radio Configuration 4)

Channel table with F-PICH/F-SYNC/F-PCH and 6 data channels (see Table 4-11).

- TDC_RC4 (Base Station Transmit Diversity Path 6 Channels Radio Configuration 4)

Channel table with F-PICH/F-SYNC/F-PCH and 6 data channels (see Table 4-12).

In addition to the compliant channel tables, the following channel tables are defined:

- BPC_RC4 (Base Station Both Paths 6 Channels Radio Configuration 4)

Channel table with F-PICH/F-TDPICH/F-SYNC/F-PCH and 6 data channels (see Table 4-13).

- The standard does not specify a channel number for the data channels. If you wish to use channels other than those in the predefined channel tables, you may copy the original tables and adapt the channels in the copy. For details refer to the step-by-step instructions "[To edit a channel table](#)", "[To create a channel table](#)" and "[To copy a channel table](#)".

Table 4-10: Base station channel table for main branch in radio configuration 1

Channel type	Number of channels	Radio configuration	Code channel (Walsh Code.SF)
F-PICH	1	-	0.64
F-SYNC	1	-	32.64
F-PCH	1	-	1.64
CHAN	6	1	9.64
		1	10.64
		1	11.64
		1	15.64
		1	17.64
		1	25.64

Table 4-11: Base station channel table for main branch in radio configuration 4

Channel type	Number of channels	Radio configuration	Code channel (Walsh Code.SF)
F-PICH	1	-	0.64
F-SYNC	1	-	32.64
F-PCH	1	-	1.64
CHAN	6	4	9.128
		4	10.128
		4	11.128
		4	15.128
		4	17.128
		4	25.128

Table 4-12: Base station channel table for antenna 2 in radio configuration 4

Channel type	Number of channels	Radio configuration	Code channel (Walsh Code.SF)
F-TDPICH	1	-	16.128
F-SYNC	1	-	32.64
F-PCH	1	-	1.64
CHAN	6	4	9.128
		4	10.128
		4	11.128
		4	15.128
		4	17.128
		4	25.128

Table 4-13: Base station test model for aggregate signal in radio configuration 4

Channel type	Number of channels	Radio configuration	Code channel (Walsh Code.SF)
F-PICH	1	-	0.64
F-TDPICH	1	-	16.128
F-SYNC	1	-	32.64
F-PCH	1	-	1.64
CHAN	6	4	9.128
		4	10.128
		4	11.128
		4	15.128
		4	17.128
		4	25.128

Relationship between channel type and modulation type

Channel type	Channel	Modulation
F-PICH	Pilot channel	BPSK
F-SYNC	Synchronisation channel	BPSK
F-PCH	Paging channel	BPSK
F-TDPICH	Transmit diversity pilot channel	BPSK
F-APICH	Auxiliary pilot channel	BPSK
F-ATDPICH	Auxiliary transmit diversity channel	BPSK
F-BCH	Broadcast channel	QPSK
F-CPCCH	Common power control channel	QPSK
F-CACH	Common assignment channel	QPSK
F-CCCH	Common control channel	QPSK
F-PDCCH	Packet data control channel	QPSK
F-PDCH	Packet data channel	QPSK, 8PSK or 16QAM
CHAN	Data channel radio configuration 1-2	BPSK
CHAN	Data channel radio configuration 3-5	QPSK

Short list of terms and abbreviations

For a more comprehensive glossary refer to the CDMA2000 standard.

Term or abbreviation	Description
APICH	auxiliary pilot channel
ATDPCH	auxiliary transmit diversity pilot channel
BCH	broadcast channel.
CACH	common assignment channel
CCCH	common control channel
CDEP	code domain error power
CDP	code domain power
Composite EVM	In accordance with the 3GPP2 specifications, determines the square root of the squared error between the real and the imaginary parts of the test signal and an ideally generated reference signal (EVM referred to the total signal) in a composite EVM measurement.
CPCCH	common power control channel
Crest factor	ratio of peak to average value of the signal
Inactive Channel Threshold	Minimum power that a single channel must have compared with the total signal to be recognized as an active channel.
MC1	multi-carrier1 (one carrier system 1X).
MC2	multi-carrier3 (three carrier system 3X).
OTD	orthogonal transmit diversity, two antennas used
PCG	power control group: name in CDMA2000 system for 1536 chips or 1.25 ms interval; transmitter power is constant during a power control group
PCH	paging channel

Term or abbreviation	Description
PDCH	packet data channel
PDCCH	packet data control channel
PICH	pilot channel 0.64
RC	radio configuration; definition of sampling rate, permissible data rates, modulation types and use of special channels, and transmit diversity
SF	spreading factor
SYNC	synchronisation channel 32.64
TD	transmit diversity, two antennas used
TDPICH	transmit diversity pilot channel 16.128
x.y	Walsh code x.y, with code number x and spreading factor y of the channel

Softkeys of the Code Domain Analyzer menu (CDMA2000 BTS Analyzer mode)

"The following table shows all softkeys available in the main menu of the **CDMA2000 BTS Analyzer** option (**MENU** key). It is possible that your instrument configuration does not provide all softkeys. If a softkey is only available with a special option, model or (measurement) mode, this information is delivered in the corresponding softkey description.



Most of the settings of the Code Domain Analyzer can be changed in two ways. One way is to use the softkeys like in the base unit and previous options, i.e. by pressing the softkeys and by entering the desired parameters directly in the corresponding fields. The softkey automatically sets the focus on the desired field.

The other way is to use the dialog boxes, in which most of the settings of the Code Domain Analyzer can be changed. To change a parameter via the dialog boxes, select the parameter to be modified with the rotary knob or the cursor keys and press the **ENTER** key to edit the field (the blue solid frame becomes a blue dotted frame). Make the desired changes in the field. To confirm the changes press the **ENTER** key a second time.

Menu / Command	Submenu / Command	Submenu / Command	Command
Settings	Settings Overview		
	Frontend Settings		
	IQ Capture Settings		
	Demod Settings		
	Channel Table Settings ↓	New	
		Copy	
		Delete	
		Edit ↓	Add Channel
			Delete Channel
			Meas
			Sort
			Save

Menu / Command	Submenu / Command	Submenu / Command	Command
			Cancel
			Reload
		Restore Default Tables	
	Result Settings		
Screen Focus A/B			
Screen Size Full/Split			
Select Meas ↓	Code Domain Power		
	Channel Table		
	Power vs PCG		
	Result Summary		
	Screen Focus A/B		
	Select Ch/PCG		
	More ↓		
	Code Domain Error		
	Composite EVM		
	Peak Code Domain Error		
	Channel Constell		
	Screen Focus A/B		
	Select Ch/PCG		
	More ↓		
	EVM vs Symbol		
	Composite Constell		
	Power vs Symbol		
	Channel Bitstream		
	Screen Focus A/B		
	Select Ch/PCG		
Select Ch/PCG			
Adjust Ref Level			

Settings

Opens a submenu to configure the Code Domain Analyzer result displays with the following softkeys:

- **Settings Overview**
- **Frontend Settings**
- **IQ Capture Settings**
- **Demod Settings**
- **Channel Table Settings**
- **Result Settings**

Settings Overview

This softkey opens the **Settings Overview** dialog box that visualizes the data flow of the Code Domain Analyzer and summarizes all of the current settings. In addition, you can change the current settings via this dialog box.

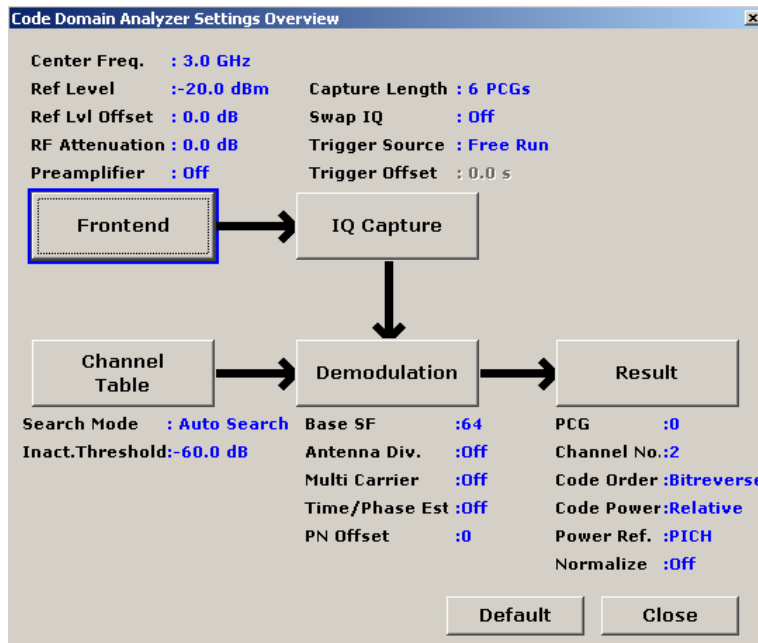

To change the settings, either use the rotary knob or the cursor keys to change the focus to any other block or press one of the following softkeys:

- **Frontend Settings**
- **IQ Capture Settings**
- **Demod Settings**
- **Channel Table Settings**
- **Result Settings**

When using the rotary knob or the cursor keys, press the **ENTER** key to open the corresponding dialog box. The Settings Overview dialog box always remains open while settings are modified.

Frontend Settings

Opens the **Frontend Settings** dialog box.

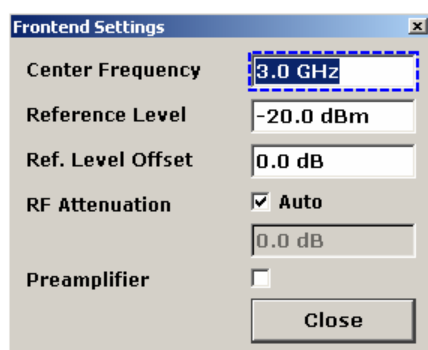

In the **Frontend Settings** dialog box, the following parameters can be modified:

Center
Ref. Level
Ref. Level Offset
RF Attenuation Manual
RF Attenuation Auto
Preamplifier

Center (Frontend Settings dialog box)

For details refer to the **Center** softkey in the frequency menu of the base unit.

Ref. Level (Frontend Settings dialog box)

For details refer to the **Ref Level** softkey in the amplitude menu of the base unit.

Ref. Level Offset (Frontend Settings dialog box)

For details refer to the **Ref Level Offset** softkey in the amplitude menu of the base unit.

RF Attenuation Manual (Frontend Settings dialog box)

For details refer to the **RF Atten Manual** softkey in the amplitude menu of the base unit.

RF Attenuation Auto (Frontend Settings dialog box)

For details refer to the **RF Atten Auto** softkey in the amplitude menu of the base unit.

Preamplifier (Frontend Settings dialog box)

For details refer to the **Preamp On/Off** softkey in the amplitude menu of the base unit.

IQ Capture Settings

Opens the **IQ Capture Settings** dialog box.

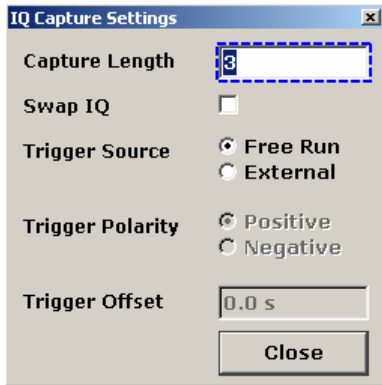

In the **IQ Capture Settings** dialog box, the following parameters can be modified:

Capture Length
Swap IQ
Trigger Source
Trigger Polarity
Trigger Offset

Capture Length (IQ Capture Settings dialog box)

Sets the number of PCGs you want to analyze. The input value is always in multiples of the PCGs. The maximum capture length value is 64. The default value is 3.

→ Remote: CDP:IQL 12

Swap IQ (IQ Capture Settings dialog box)

Activates the inversion of the sign of the Q-component of the signal. The default setting is OFF.

→ Remote: CDP:QINV ON

Trigger Source (IQ Capture Settings dialog box)

Selects one of the trigger modes: Free Run or External. Other trigger modes are not available. The default setting is Free Run. If External trigger mode has been set, the enhancement label **TRG** is displayed. For details on the trigger modes refer to [Trigger mode overview](#) on page 4.27.

→ Remote: TRIG:SOUR EXT

Trigger Polarity (IQ Capture Settings dialog box)

Sets the polarity of the trigger source.

Depending on the required polarity of the edge, the trigger polarity can be set to either positive or negative. The default setting is **Pos**. The setting only has an effect if the trigger source is external.

- Remote: TRIG:SLOP POS
- Remote: SWE:EGAT:POL POS

Trigger Offset (IQ Capture Settings dialog box)

For details refer to the **Trigger Offset** softkey in the trigger menu of the base unit.

Demod Settings

Opens the **Demodulation Settings** dialog box:

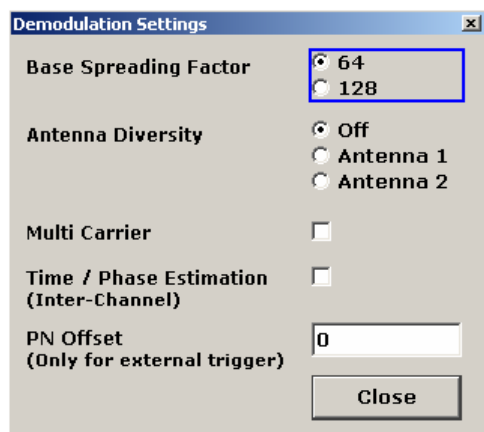

In the **Demodulation Settings** dialog box, the following parameters can be modified:

Base SF
Antenna Diversity
Multi Carrier
Time/Phase Estimation
PN Offset

Base SF (Demod Settings dialog box)

Sets the base spreading factor to either 64 or 128. If you set the base spreading factor to 64 for channels with a base spreading factor of 128 (code class 7), an alias power is displayed in the Code Domain Power and Code Domain Error Power diagrams.

- Remote: CDP:SFAC 64

Antenna Diversity (Demod Settings dialog box)

Activates or deactivates the orthogonal transmit diversity (two-antenna system) and defines the antenna for which the results will be displayed.

- Antenna 1** The signal of antenna 1 is fed in.
The pilot channel (F-PICH) with channel number 0 and spreading factor 64 (0.64) is required.
If a channel table is used in the measurement (see **Channel Table**), it must contain the pilot channel (F-PICH), but must not contain the transmit diversity pilot channel (F-TDPICH).
As reference for the code power (**Power Reference**), PICH is used.
- Antenna 2** The signal of antenna 2 is fed in.
The transmit diversity pilot channel (F-TDPICH) with channel number 16 and spreading factor 128 (16.128) is required.
If a channel table is used in the measurement (see **Channel Table**), it must contain the transmit diversity pilot channel (F-TDPICH), but must not contain the pilot channel (F-PICH).
As reference for the code power (**Power Reference**), F-TDPICH is used.
- Off** The aggregate signal from both antennas is fed in.
The pilot channels of both antennas are required.
If a channel table is used in the measurement (see **Channel Table**), it must contain both the transmit diversity pilot channel (F-TDPICH) and the pilot channel (F-PICH).
As reference for the code power (**Power Reference**), F-PICH is used.

→ Remote: CDP:ANT OFF

Multi Carrier (Demod Settings dialog box)

Activates or deactivates the Multi Carrier mode. The mode improves the processing of multi carrier signals. It allows the measurement on one carrier out of a multi carrier signal. This is done by activating a low pass filter and by using a special algorithm for signal detection on multi carrier signals.

Note that the low pass filter affects the measured signal quality (e.g. EVM and RHO) compared to a measurement without a filter. The algorithm used for signal detection slightly increases the calculation time.

The frequency response of the low pass filter is shown below.

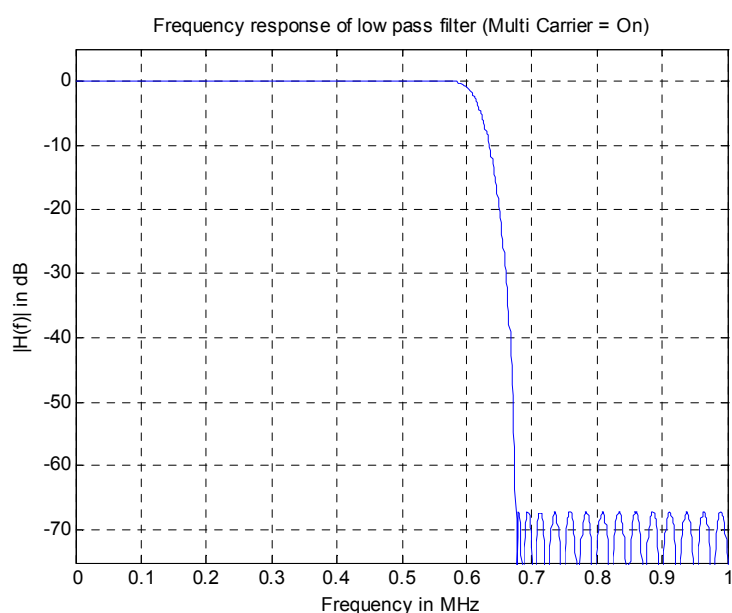

→ Remote: CONF:CDP:MCA ON

Time/Phase Estimation (Demod Settings dialog box)

Activates or deactivates the timing and phase offset calculation of the channels as to the pilot channel. If deactivated or more than 50 active channels are in the signal, the calculation does not take place and dashes instead of values are displayed as results.

→ Remote: CDP:TPM ON

PN Offset (Demod Settings dialog box)

Specifies the Pseudo Noise (PN) offset of the base station. In a CDMA2000 system, the PN offset is used to distinguish the base stations.

The PN offset determines the offset in the circulating PN sequence in multiples of 64 chips with reference to the event second clock trigger.

Although the parameter is always available, it only has a function in External trigger mode.

→ Remote: CDP:PNOF 0...511

Channel Table Settings

Opens the **Channel Table Settings** dialog box and the corresponding submenu.

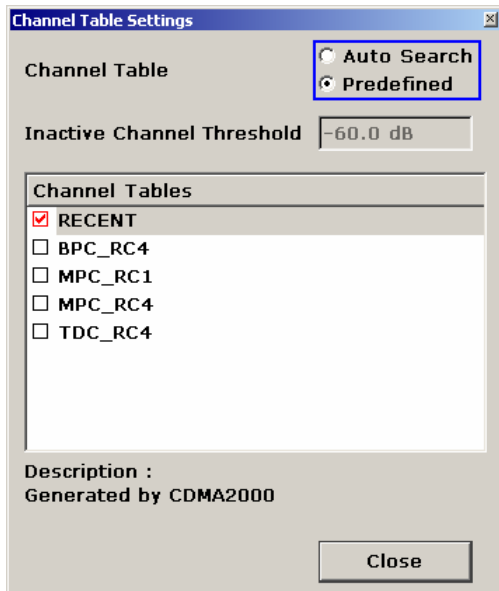

Predefined channel tables are a way to customize measurements. The RECENT channel table contains the last configuration used before switching from Auto Search to Predefined. The BPC_RC4, MPC_RC1, MPC_RC4 and TDC_RC4 channel tables are included in the option per default and are configured according to the standard. For details on the predefined channel tables refer to [Predefined Channel Tables](#) on page 4.289. In addition, new channel tables can be created and saved to be used in measurements. For details refer to the step by step instructions on how [To edit a channel table](#) on page 4.283, [To create a channel table](#) on page 4.284 and [To copy a channel table](#) on page 4.284.

In the **Channel Table Settings** dialog box, the following parameters can be modified:

Channel Table
Inactive Channel Threshold
Channel Table Name

Channel Table (Channel Table Settings dialog box)

Defines the channel table used in the measurement.

Auto Search The Auto Search mode scans the whole code domain, including all permissible symbol rates and channel numbers, for active channels.

The automatic search provides an overview of the channels contained in the signal. If channels are not detected as being active, change the threshold (see **Inactive Channel Threshold**) or select the **Predefined** channel search type.

Predefined Performs the Code Domain Analyzer measurement on the basis of the active predefined channel table (see **Channel Table Name**). All channels of a channel table are assumed to be active. For details see also [Predefined Channel Tables](#) on page 4.289.

- Remote: CONF:CDP:CTAB[:STAT] ON
- Remote: CONF:CDP:CTAB:SEL "MPC_RC4"

Inactive Channel Threshold (Channel Table Settings dialog box)

Defines the minimum power which a single channel must have compared to the total signal in order to be regarded as an active channel. Channels below the specified threshold are regarded as "inactive". The parameter is only available in the Auto Search mode of the Channel Table Settings dialog box.

The default value is -60 dB. With this value all channels with signals such as the CDMA2000 test models are located by the Code Domain Power analysis. Decrease the Inactive Channel Threshold value, if not all channels contained in the signal are detected.

→ Remote: CDP:ICTR -100 dB ... 0 dB

Channel Table Name (Channel Table Settings dialog box)

In this field a list of the available channel tables is shown. To activate a predefined channel table, select the corresponding check box by using the cursor keys and pressing the **ENTER** key. The selected channel table is then used as the basis for future measurements (until you choose another or activate Auto Search).

An active channel table must completely describe the supplied signal, also in regard to the transmit diversity (see **Antenna Diversity**).

Using the softkeys, customized channel tables can be defined or existing channel tables can be modified. For details refer to the step-by-step instructions [To edit a channel table](#) on page 4.283, [To copy a channel table](#) on page 4.284 and [To create a channel table](#) on page 4.284.

→ Remote: CONF:CDP:CTAB:CAT?

New

Creates a new channel table name that can be seen in the dialog box from then on. The name will be automatically set to 'ChannelTable'. By default, the resulting channel table is completely empty (i.e. it contains no channel at all). Also see the section on how [To create a channel table](#) on page 4.284.

→ Remote: CONF:CDP:CTAB:NAME "NEW_TAB"

Copy

Copies the selected table. All elements of the selected channel table are copied, except the name which is set to 'Copy of <SourceChannelTableName>'. Also see the section on how [To copy a channel table](#) on page 4.284.

→ Remote: CONF:CDP:CTAB:COPY "CTAB2"

Delete

Deletes the selected channel table. The currently active channel table cannot be deleted.

→ Remote: CONF:CDP:CTAB:DEL "CTAB2"

Edit

Opens the **Edit Channel Table** dialog box and the corresponding softkey menu.

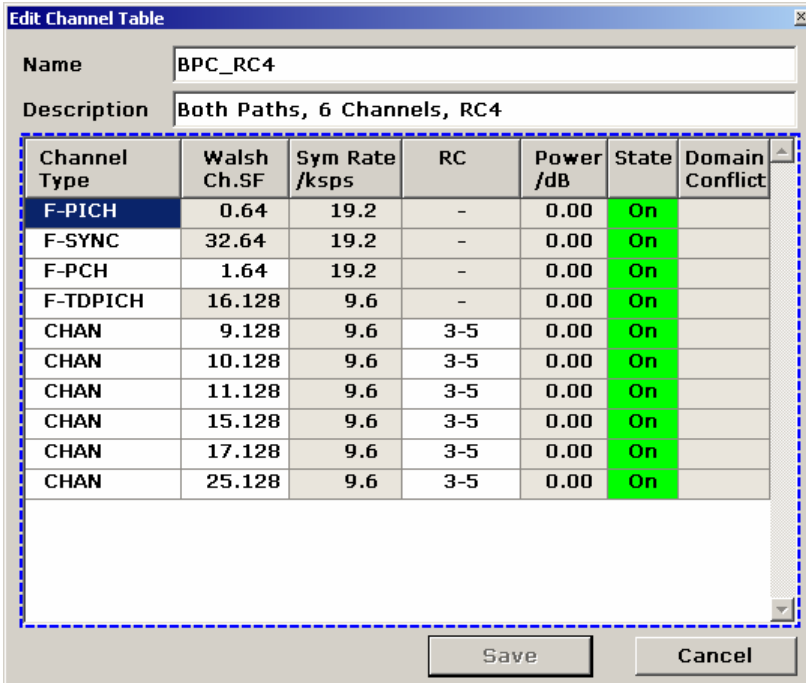

The dialog box contains the following items (grey fields can not be modified):

Item	Description
Name	Enter the name of the selected channel table, which will be saved under <name>.xml. Note that the old channel table file is not deleted. The name is case sensitive and may not contain spaces. It must be a valid MS Windows file name.
Description	Enter further information about the channel table.
Channel Type	Select one of the channel types from the dropdown menu
Walsh Ch.SF	Enter the Channel Number (Ch) and Spreading Factor (SF). For some channel types the possible values are limited or preset (e.g. F-PICH, F-TDPICH and F-PDCH).
Symbol Rate/ksps	Display of the symbol rate
RC	The Radio Configuration (RC) can be customized for only two channel types. For the F-PDCH the values can be 10(QPSK), 10(8PSK) and 10(16QAM). For CHAN channels the Radio Configuration can either be 1-2 or 3-5.
Power/dB	Contains the measured relative code domain power. The unit is dB. The fields are filled with values after pressing the Meas softkey.
State	Indicates whether a channel is active or inactive
DomainConflict	A red bullet is shown if there's a conflict of any sort between two or more channels (e.g. two conflicting channel codes)

Changes are never saved automatically. For that reason every time a change is made, the text '(unsaved changes)' appears in the title bar.

The corresponding softkey menu contains the following items:

Add Channel
Delete Channel
Meas
Sort
Save
Cancel
Reload

→ Remote: CONF:CDP:CTAB:NAME "NEW_TAB"

Add Channel

Inserts a new channel below the one selected. The default values for a new channel are:

ChannelType	CHAN
Walsh Ch.SF	1.64
SymbolRate	19.2 ksps (automatically calculated)
RadioConfiguration	3-5
Power	0 dB (automatically calculated)
State	Off
DomainConflict	No (automatically calculated)

To change the channel type use the dropdown menu that opens when selecting / highlighting the **Channel Type** field that should be changed and pressing the **ENTER** key. The radio configuration settings are changed in the same way.

To change the channel number type another channel number in the form 'ChannelNumber.SpreadingFactor' or simply the code number (see **Channel (Code) Number** for details) in the respective field and confirm the change with the **ENTER** key.

To activate or deactivate a channel, simply select the field and confirm with the **ENTER** key.

The R&S FSL automatically checks for conflicts between two active channels.

→ Remote: CONF:CDP:CTAB:DATA "0...13, 2...7, 0...127, 0...30, 0, 0, 0 | 1"

Delete Channel

Deletes the selected channel without further notice.

Meas

Initiates a measurement in Automatic Channel Search mode. The measurement results are applied to the active channel table. The active channel table is overwritten without further notice.

The softkey is only available if the **Auto Search** mode is selected in the **Channel Table Settings** dialog box.

Sort

Sorts the table according to the following rules.

First off, active channels are separated from inactive channels. Within these categories sorting is then done first by the channel type (special channels like F-PICH or F-SYNC first, then data channels) and next by the spreading factor in ascending order. Last, the sorting is done by the code number, also in ascending order.

Save

Saves the table under its specified name in the xml-format. If you edit a channel table and want to keep the original channel table, change the name of the edited channel table before saving it.

Cancel

Closes the Edit dialog box and returns to the Channel Table Settings dialog box. Changes applied to the channel table are lost.

Reload

Reloads the original content of the copied channel table.

Restore Default Tables

Restores the predefined channel tables (see [Predefined Channel Tables](#) on page 4.289) to their factory-set values. Existing channel tables with the same name as default channel tables are replaced by this action. In this way, you can undo unintentional overwriting.

→ Remote: CONF:CDP:CTAB:REST

Result Settings

Opens the **Result Settings** dialog box.

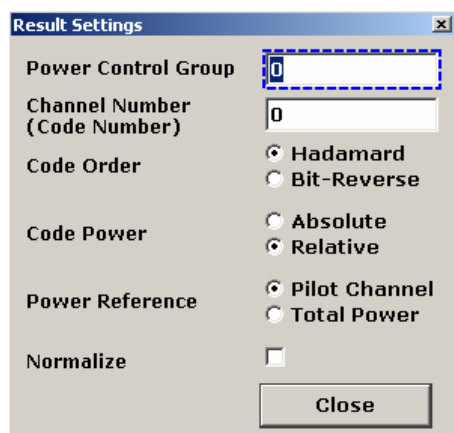

The **Result Settings** dialog box contains the following parameters:

Power Control Group
Channel (Code) Number
Code Order
Code Power
Power Reference
Normalize

Power Control Group (Result Settings dialog box)

In some measurements it is possible to highlight the data of a specific PCG. Select the PCG on which to put the focus on in this field. The range of the value depends on the Capture Length defined in the **IQ Capture Settings** dialog box. The range is (0 to Capture Length-1).

The defined value is valid for any measurement which takes PCGs into account (for further information see also the **Select Ch/PCG** softkey). The selected PCG is highlighted in red on the screen (as opposed to the others which are displayed in yellow).

→ Remote: CDP:SLOT 0 ... (IQ_CAPTURE_LENGTH-1)

Channel (Code) Number (Result Settings dialog box)

The entry in this field corresponds to a specific code to be examined. The valid range is from 0 to BSF-1. The base spreading factor (BSF) is either 64 or 128 depending on the setting of the **Base SF** field and can not be edited via this field. The selected channel is marked red in the Channel Table. In the Code Domain Power display and the Code Domain Error Power display, all codes belonging to this channel will be marked red.

The defined value is valid for any measurement that takes a selected channel into account (for further information see also the **Select Ch/PCG** softkey).

The rotary knob behavior depends on the result display and the graphic display. For Code Domain Power and Code Domain Error result displays, the rotary knob always selects the adjacent channel. The position of the adjacent channel in the diagram depends on the **Code Order**. In the channel table result display, the rotary knob scrolls through the list.

→ Remote: CDP:CODE 0 ... (BASE_SF-1)

Code Order (Result Settings dialog box)

Selects the channel sorting for the **Code Domain Power** and **Code Domain Error** result displays.

Hadamard order

By default, the codes are sorted in Hadamard order, i.e. in ascending order.

You can see the power of each code in this way; there is no distinction between channels apparent. If there is a channel covering several codes, the display shows the individual power of each code.

Example (for base spreading factor of 64):

0.64, 1.64, 2.64, ..., 63.64

Bit-Reverse order Bundles the channels with concentrated codes, i.e. all codes of a channel are next to one another. In this way you can see the total power of a concentrated channel.

Example (for base spreading factor of 64):

0.64, 32.64, 16.64, 48.64, 8.64, 40.64, ..., 15.64, 47.64, 31.64, 63.64

For details refer to [Hadamard and BitReverse Code Tables](#) on page 4.337.

→ Remote: CDP:ORD HAD

Code Power (Result Settings dialog box)

Selects the y-axis scaling for the **Code Domain Power** result display.

Absolute scaling dBm

Relative scaling dB

Set the reference via the **Power Reference**.

→ Remote: CALC:FEED "XPOW:CDP[:ABS]"

→ Remote: CALC:FEED "XPOW:CDP:RAT"

Power Reference (Result Settings dialog box)

Determines the reference power for the relative power measurements.

Pilot Channel By default, the reference power is the power of the pilot channel. Which pilot channel is used as reference depends on the **Antenna Diversity**.

Total Power The power is measured over one PCG. The reference power is the total power of the signal for the corresponding PCG.

By default, the power of the channels is referred to the power of the pilot channel (code number 0). The power of the pilot channel is identical over all PCGs and hence can be used as a constant reference for the result display. In contrast, the total power can vary from PCG to PCG due to the possibility of a power level change in the different code channels.

In the **Power vs PCG** result display, with enabled power control and reference to the total power of the signal, the power control of the selected channel is not necessarily reflected.

Example (theoretical):

There is just one data channel in the signal and its power is controlled.

The power is referred to the total power of the signal (which consists only of the contribution from this one data channel).

In the Power vs. PCG diagram, a straight line is displayed instead of the expected power staircase.

For relative result displays, the reference value **Total Power** is therefore only meaningful if the signal does not contain power control. For signals with enabled power control, use the **Pilot Channel** setting, since the pilot channel is not subject to power control under any circumstances.

→ Remote: CDP:PREF TOT

Normalize (Result Settings dialog box)

If activated, this parameter eliminates the DC offset from the signal. By default, the parameter is deactivated.

→ Remote: CDP:NORM ON

Screen Focus A/B

Sets the focus on the selected screen. Changes apply only to the focused screen. There are no restrictions to the display of measurement results, i.e. you can display every result display in either or both screens.

→ Remote: DISP:SEL

Screen Size Full/Split

Displays the result display in full screen size, or splits the screen to display two result displays.

To change settings in split screen display, set the focus on the designated result display via the **Screen Focus A/B** softkey.

→ Remote: DISP:FORM SING

Select Meas

Opens a submenu to select one of the measurements and result displays of the Code Domain Analyzer:

- [Code Domain Power](#) on page 4.307
- [Channel Table](#) on page 4.309
- [Power vs PCG](#) on page 4.310
- [Result Summary](#) on page 4.310
- [Code Domain Error](#) on page 4.313
- [Composite EVM](#) on page 4.314
- [Peak Code Domain Error](#) on page 4.315
- [Channel Constell](#) on page 4.315
- [EVM vs Symbol](#) on page 4.316
- [Composite Constell](#) on page 4.316
- [Power vs Symbol](#) on page 4.317
- [Channel Bitstream](#) on page 4.318

For details on screen layout and default settings refer to the measurement description of the [Code Domain Analysis](#) on page 4.284.

Code Domain Power

Starts the Code Domain Power (CDP) result display. By default, the scaling is relative.

This result display determines the power of all channels and plots it in a diagram. The x-axis represents the channel (code) number, which corresponds to the base spreading factor. Each

bar in the diagram represents one code. The order of the codes depends on the **Code Order**. The y-axis is a logarithmic level axis that shows the power of each channel.

The measurement evaluates the total signal over a single PCG. It supports both Hadamard and BitReverse code sorting order. Selects the Code Domain Power (CDP) result display with relative scaling.

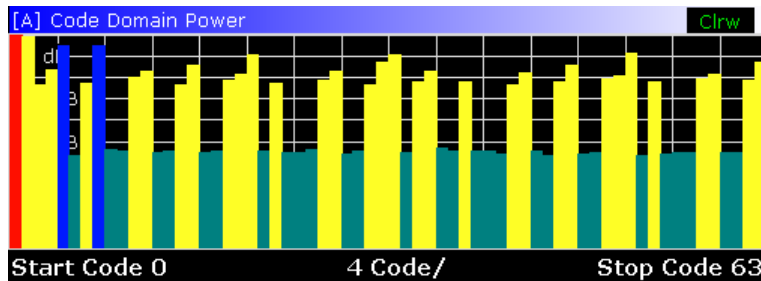

Fig. 4-30: CDP measurement (result displayed in Hadamard code order)

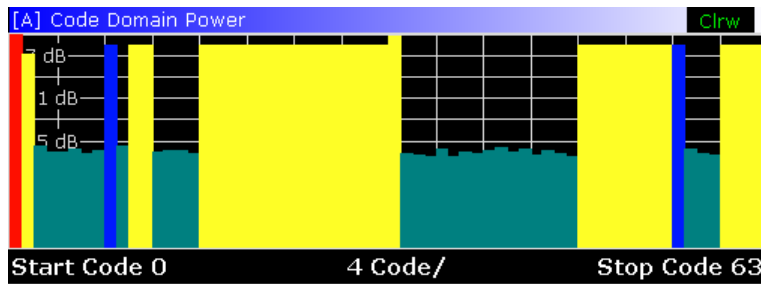

Fig. 4-31: CDP measurement (result displayed in Bit Reverse code order for the same signal)

Active and inactive data channels are defined via the **Inactive Channel Threshold**. The power values of the active and unassigned channels are shown in different colors. In addition, codes with alias power can occur. These codes obtain power components originating either from a spreading factor higher than the base spreading factor or from the own and/or another antenna as a result of transmit diversity.

The following colors are defined:

- Red: selected channel (**Channel (Code) Number**)
- Yellow: active channel
- Cyan: inactive channel
- Light blue: alias power of higher spreading factor
- Magenta: alias power as a result of transmit diversity



If codes with alias power are displayed, set the highest base spreading factor using the **Base SF**.

It is not recommended to select more detailed result displays (such as **Channel Constell**) for unassigned codes, since the results are not valid.

- Remote: CALC1:FEED "XPOW:CDP:RAT" (relative code power)
- Remote: CALC1:FEED "XPOW:CDP" (absolute code power)

Channel Table

Starts the Channel Table result display.

This result display shows all channels of the signal. The sorting of the channels is according to channel type, i.e. special channels like F-PICH, F-SYNC etc. first, then data channels (CHAN) and last inactive channels (always shown as '---'). Within a group, channels are sorted according to the spreading factor and then according to code number, also in ascending order. Within the code number, first active, then inactive channels are listed. The selected channel is marked in red. Active and inactive data channels are defined via the **Inactive Channel Threshold**.

The Channel Table result display may contain up to 128 entries, corresponding to the highest base spreading factor of 128.

The measurement evaluates the total signal over a single PCG.

[A] Channel Table								Clr
Channel Type	Walsh Ch.SF	Symb.Rate /ksps	RC	State	Power /dBm	Power /dB	T Offs /ns	P Offs /mrad
PICH	0.64	19.2	---	On	-17.01	0.00	---	---
SYNC	32.64	19.2	---	On	-23.34	-6.33	---	---
PCH	1.64	19.2	---	On	-17.31	-0.31	---	---
CHAN	2.4	307.2	3	On	-20.26	-3.26	---	---
CHAN	3.8	153.6	3	On	-20.27	-3.26	---	---
CHAN	15.16	76.8	3	On	-20.32	-3.31	---	---

Fig. 4-32: Channel Table result display

For the Code Domain Power measurement, the following parameters are determined for the channels:

- **Channel Type**
Shows type of channel ('---' for inactive channels)
- **Walsh Chan.SF**
Channel number including the spreading factor (in the form <Channel>.<SF>).
- **Symb Rate/ksps**
Symbol rate with which the channel is transmitted (9.6 ksps to 307.2 ksps).
- **RC**
Radio configuration.
- **State**
Status display. Unassigned codes are identified as inactive channels.
- **Pwr dBm/Pwr dB**
Specification of the absolute (dBm) and relative (dB) (referred to the F-PICH or the total power of signal) power of the channel
- **T Offs/ns and Ph Offs/mrad**
Timing/phase offset between this channel and the pilot channel (enabled via the **Demod Settings** softkey, **Time/Phase Estimation**).
If enabled, the maximum value of the timing/phase offset is displayed together with the associated channel in the last two lines. Since the timing/phase offset values of each active channel can be either negative or positive, the absolute values are compared and the maximum is displayed with the original sign.

→ Remote: CALC1:FEED "XTIM:CDP:ERR:CTAB"

Power vs PCG

Selects the Power versus Power Control Group (PCG) result display.

In this result display, the power of the selected channel is averaged for each measured PCG and referred to the pilot power of the PCG. Therefore the unit of the y-axis is dB (relative to the **Pilot Channel**). For measurements in which **Antenna Diversity** is inactive (OFF) or set to 'Antenna 1', the F-PICH channel is used as reference, while the F-TDPICH channel is used for measurements in which Antenna Diversity is set to 'Antenna 2'.



For signals with enabled power control, use the default reference power setting. For details refer to **Power Reference**.

The measurement evaluates one code channel over the entire period of observation. The selected PCG is displayed red.

You can set the number of PCGs by means of the Capture Length.



For a power-regulated signal, to correctly detect the start of a power control group, the external trigger must be used.

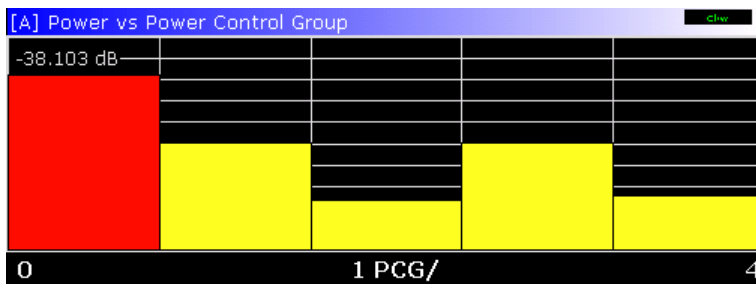

Fig. 4-33: Power vs PCG for an occupied channel with power control

→ Remote: CALC2:FEED "XTIM:CDP:PVSL"

Result Summary

The Result Summary shows the data of various measurements in numerical form.

Note the effects of the **Trace Mode** softkey differ from other measurements. The **Min Hold** and **Max Hold** values are already given in the Min and Max columns of the **Result Summary** table. When in **Average** trace mode, the Current column is renamed to Average and the corresponding values are displayed. The current values are displayed in the Current column, when the **View** trace mode is activated.

The result display is divided as follows:

- Global Results
- PCG
- Channel

[A] Result Summary		Min	Current	Max	Unit
Carrier Frequency Error		-256.70	-256.70	-256.70	Hz
Carrier Frequency Error		-0.09	-0.09	-0.09	ppm
Chip Rate Error		-0.49	-0.49	-0.49	ppm
Trigger to Frame		---	---	---	s
Active Channels			9		
PCG	Total Power	-10.03	-10.03	-10.03	dBm
	Pilot Power	6.98	6.98	6.98	dBm
	RHO	1.00	1.00	1.00	
	Composite EVM	4.27	4.27	4.27	%
	IQ Imbalance	0.14	0.14	0.14	%
	IQ offset	0.85	0.85	0.85	%
Channel	Power Rel	-38.26	-38.26	-38.26	dB
	Symbol EVM	73.39	73.39	73.39	%rms
	Modulation		QPSK		
	Timing Offset	---	---	---	ns
	Phase Offset	---	---	---	mrad
	Power Abs	-55.27	-55.27	-55.27	dBm

Fig. 4-34: Result summary

- Remote: CALC2:FEED "XTIM:CDP:ERR:SUMM"
- Remote: CALC:MARK:FUNC:CDP:RES?

Global Results

Under **Global Results**, the measurement results that concern the total signal (that is, all channels) for the entire period of observation (that is, all PCGs) are displayed:

- Carrier Frequency Error

Specifies the frequency error referred to the set center frequency of the R&S FSL. The absolute frequency error is the sum of the frequency error of the R&S FSL and that of the device under test. Frequency differences between the transmitter and receiver of more than 1.0 kHz impair synchronization of the Code Domain Power measurement. If at all possible, the transmitter and the receiver should be synchronized (refer to chapter "Advanced Measurement Examples"). The frequency error is available in the units both Hz and ppm referred to the carrier frequency.

The value of the Carrier Frequency Error in ppm is only displayed in full screen mode.

- Chip Rate Error

Specifies the chip rate error (1.2288 Mcps) in ppm. A large chip rate error results in symbol errors and, consequently, possibly in the Code Domain Power measurement not being able to perform synchronization. This measurement result is also valid if the R&S FSL could not synchronize to the CDMA2000 signal.

- Trigger to Frame

Reflects the time offset from the beginning of the recorded signal section to the start of the first PCG. In case of triggered data recording, this corresponds to the timing offset:

$$\text{frame trigger (+ trigger offset) - start of first PCG}$$

If it was not possible to synchronize the R&S FSL to the CDMA2000 signal, this measurement result is meaningless. If the **Free Run** trigger mode is selected, dashes are displayed.

The Trigger to Frame value is only displayed in full screen mode.

– **Active Channels**

Specifies the number of active channels found in the signal. Detected data channels as well as special channels are regarded as active. With transmit diversity, the result applies to the selected antenna (refer to **Antenna Diversity**). No value is displayed in both the Min and Max columns.

PCG

Under **PCG**, the measurement results that concern the total signal (that is, all channels) for the selected power control group (**Capture Length**) are displayed:

– **Total Power**

Shows the total power of the signal.

– **Pilot Power**

Shows the power of the pilot channel. If antenna 2 is selected, the power of the F-TDPICH is displayed, in all other cases that of the F-PICH (for details refer to **Antenna Diversity**).

The value for the Pilot Power is only displayed in full screen mode.

– **RHO**

Shows the quality parameter RHO. According to the CDMA2000 standard, RHO is the normalized, correlated power between the measured and the ideally generated reference signal. When RHO is measured, the CDMA2000 standard requires that only the pilot channel be supplied.

– **Composite EVM**

The composite EVM is the difference between the test signal and the ideal reference signal (refer to the **Composite EVM** softkey).

– **IQ Imbalance / Offset**

Shows the IQ imbalance and the DC offset of the signal in %.

The values for IQ Imbalance and IQ Offset are only displayed in full screen mode.

Channel

Under **Channel**, the measurement results of the selected channel and the selected PCG are displayed:

– **Power**

Shows the channel power of the selected channel and PCG. The result depends on the selected **Code Power** and the **Power Reference**) and absolute channel power.

– **EVM**

Shows the peak or mean value of the EVM measurement result (refer to the **EVM vs Symbol** softkey).

The value of the EVM is only displayed in full screen mode.

- **Modulation**

Displays the modulation type of the channel and PCG: BPSK, QPSK, 8PSK, or 16QAM. No values are displayed in the Min and Max columns.

- **Timing Offset**

Shows the timing offset between the selected channel and the pilot channel (enabled via the **Demod Settings** softkey, **Time/Phase Estimation**).

The Timing Offset is only displayed in full screen mode.

- **Phase Offset**

Shows the phase offset between the selected channel and the pilot channel (enabled via the **Demod Settings** softkey, **Time/Phase Estimation**).

The Phase Offset is only displayed in full screen mode.

Select Ch/PCG

This softkey allows to select a specific PCG (Power Control Group) and/ or channel for the measurement. The key has three different states. Pressing the softkey once, opens a standard dialog box in which the channel number can be entered. Pressing it for the second time, a specific PCG can be entered. On the third hit, the softkey becomes unselected.

For details on the effects of the **Select Ch/PCG** softkey, refer to **Channel (Code) Number** and **Power Control Group**

The following result displays take results for a PCG into account:

- [Code Domain Power](#) on page 4.307
- [Code Domain Error](#) on page 4.314
- [Channel Table](#) on page 4.309
- [Power vs Symbol](#) on page 4.318
- [Composite Constell](#) on page 4.317
- [Result Summary](#) on page 4.310
- [Channel Bitstream](#) on page 4.318
- [Channel Constell](#) on page 4.316
- [EVM vs Symbol](#) on page 4.316

The following result displays take results for a channel into account:

- [Power vs PCG](#) on page 4.310
- [Power vs Symbol](#) on page 4.318
- [Result Summary](#) on page 4.310
- [Channel Bitstream](#) on page 4.318
- [Channel Constell](#) on page 4.316
- [EVM vs Symbol](#) on page 4.316

→ Remote: CDP: SLOT 0 ... (IQ_CAPTURE_LENGTH-1) (PCG selection)

→ Remote: CDP: CODE 0 ... (BASE_SF-1) (Channel and Code selection)

Code Domain Error

Starts the Code Domain Error Power result display.

This result display shows the difference in power of the test signal and an ideally generated reference signal and plots in a diagram. The unit is dB. The x-axis represents the channel (code) number, which corresponds to the base spreading factor. The y-axis is a logarithmic level axis that shows the error power of each channel. Since it is an error power, active and inactive channels can be rated jointly at a glance.

The measurement evaluates the total signal over a single PCG. It supports both Hadamard and BitReverse code sorting order.

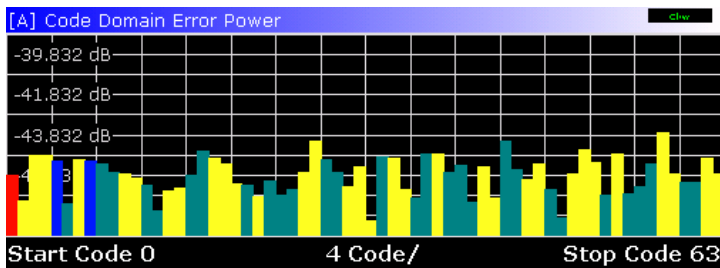

Fig. 4-35: Code Domain Error Power (results shown in Hadamard code order)

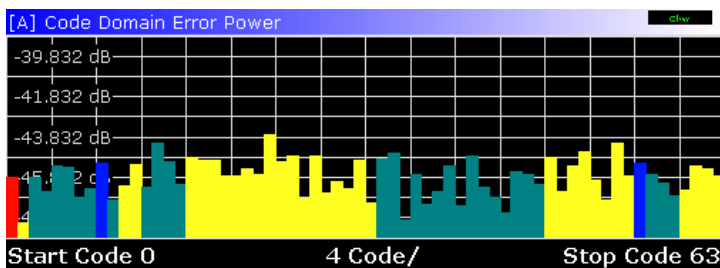

Fig. 4-36: Code Domain Error Power (results for the same signal shown in Bit Reverse code order)

Active and inactive data channels are defined via the **Inactive Channel Threshold**. The power values of the active and inactive channels take on different colors. In addition, codes with alias power can occur. These codes obtain power components originating either from a spreading factor higher than the base spreading factor or from the own and/or another antenna as a result of transmit diversity.

The following colors are defined:

- Red: selected channel (**Channel (Code) Number**)
- Yellow: active channel
- Cyan: inactive
- Light blue: alias power of higher spreading factor
- Magenta: alias power as a result of transmit diversity



If codes with alias power are displayed, set the highest base spreading factor using the **Base SF**.

It is not recommended to select more detailed result displays (such as **Channel Constellation**) for unassigned codes, since the results are not valid.

→ Remote: CALC1:FEED "XPOW:CDEP"

Composite EVM

Starts the Composite EVM result display.

This result display is for measuring the modulation accuracy. It determines the error vector magnitude (EVM) over the total signal. The EVM is the root of the ratio of the mean error power (root mean square) to the power of an ideally generated reference signal. Thus, the EVM is shown in %. The diagram consists of a composite EVM for each PCG.

The measurement evaluates the total signal over the entire period of observation. The selected PCG is displayed red. You can set the number of PCGs in the **Capture Length** field

Only the channels detected as being active are used to generate the ideal reference signal. If a channel is not detected as being active, e.g. on account of low power, the difference between the test signal and the reference signal and the composite EVM is therefore very large. Distortions also occur if unassigned codes are wrongly given the status of "active channel". To obtain reliable measurement results, select an adequate channel threshold via the **Inactive Channel Threshold** field.

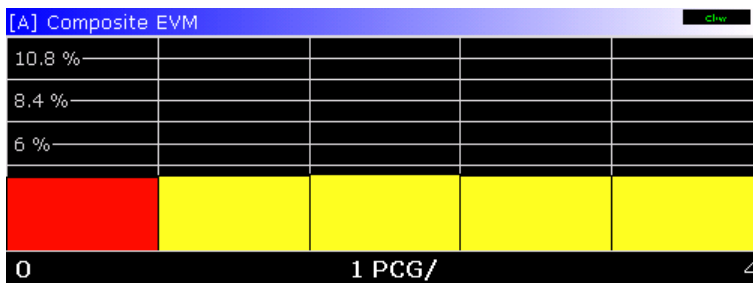

Fig. 4-37: Composite EVM display for the case of all the channels contained in the signal being detected as active.

→ Remote: CALC1:FEED "XTIM:CDP:MACC"

Peak Code Domain Error

Starts the Peak Code Domain Error result display.

The Peak Code Domain Error is defined as the maximum value for the Code Domain Error for all codes. That means that in this result display the Code Domain Error Power is projected onto the code domain at a specific base spreading factor. In the diagram, each bar of the x-axis represents one PCG. The y-axis represents the error power.

You can select the base spreading factor in the **Base SF** field and the number of evaluated PCGs in the **Capture Length** field.

The measurement evaluates the total signal over the entire period of observation. The currently selected PCG is displayed red.

Only the channels detected as being active are used to generate the ideal reference signal. If a channel is not detected as being active, e.g. on account of low power, the difference between the test signal and the reference signal is very large. The result display therefore shows a peak code domain error that is too high. Distortions also occur if unassigned codes are wrongly given the status of "active channel". To obtain reliable measurement results, select an adequate channel threshold via the **Inactive Channel Threshold** field.

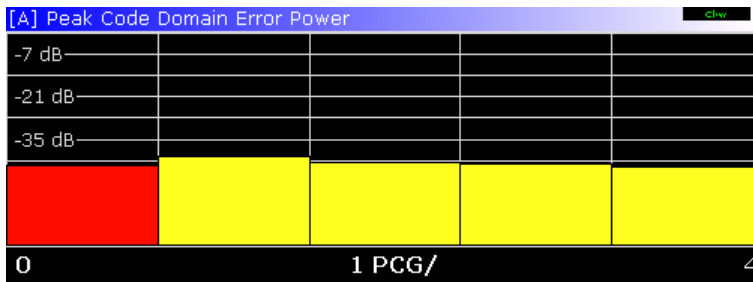

Fig. 4-38: Peak code domain error for the case of all the channels contained in the signal being detected as active

→ Remote: CALC:FEED "XTIM:CDP:ERR:PCD"

Channel Constell

Starts the Channel Constellation result display.

This result display shows the channel constellation of the modulated signal at symbol level.

The measurement evaluates a single channel over a single PCG. You can select a specific channel and PCG with the **Select Ch/PCG** softkey.

Supported modulation schemes are BPSK, QPSK, 8PSK and 16QAM. In CDMA2000 the modulation scheme depends on the channel type. Inactive channels can be measured, but the result is meaningless since these channels do not contain data.

The BPSK constellation points are displayed on the x-axis, while the constellation points of QPSK and 16QAM are located on neither axis.

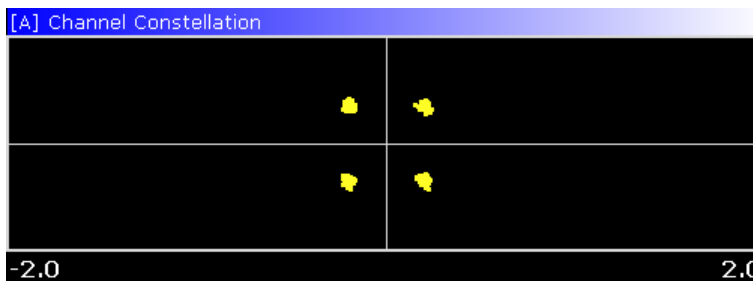

Fig. 4-39: Channel constellation diagram

→ Remote: CALC:FEED "XTIM:CDP:SYMB:CONS"

EVM vs Symbol

Starts the Symbol Error Vector Magnitude result display.

This result display shows the EVM on symbol level. The x-axis represents the symbols and the y-axis shows the EVM in %.

The measurement evaluates a single channel over a single PCG.

You can select a specific channel and PCG with the **Select Ch/PCG** softkey. The number of symbols is in the range from 6 to 384 and can be calculated like this:

$$\text{Number of symbols} = \text{Number of chips in one PCG} / \text{ChannelSF} / K$$

with

$$\text{Number of chips in one PCG} = 1536$$

Channel SF = 4, 8, 16, 32, 64 or 128

K = 1 for Antenna Diversity = OFF

K = 2 for Antenna Diversity \neq OFF

This calculation thus takes into account the results of a channel for a power control group. The result is given in %. Inactive channels can be measured, but the result is meaningless since these channels do not contain data. To set the channel and the PCG, use the **Select Ch/PCG** softkey.

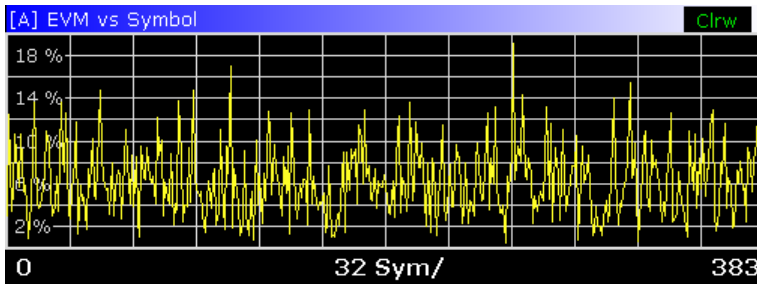

Fig. 4-40: Error vector magnitude on symbol level

→ Remote: CALC2:FEED "XTIM:CDP:SYMB:EVM"

Composite Constell

Starts the Composite Constellation result display.

This result display shows the constellation of the modulated signal at chip level. For each of the 1536 chips, a constellation point is displayed in the diagram.

The measurement evaluates the total signal over a single PCG.

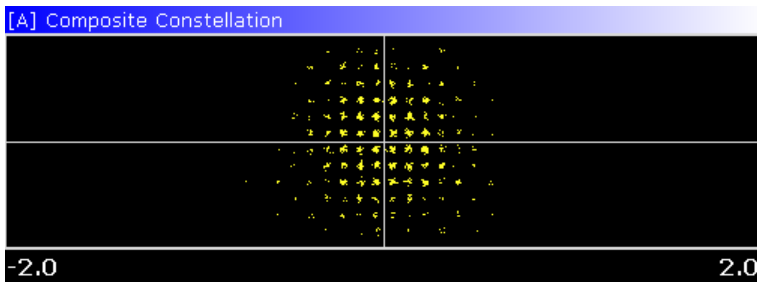

Fig. 4-41: Composite constellation diagram

→ Remote: CALC:FEED "XTIM:CDP:COMP:CONS"

Power vs Symbol

Starts the Power vs Symbol result display.

This result display calculates the absolute power in dBm for every symbol number.

The measurement evaluates a single channel over a single PCG. You can select a specific channel and PCG with the **Select Ch/PCG** softkey.

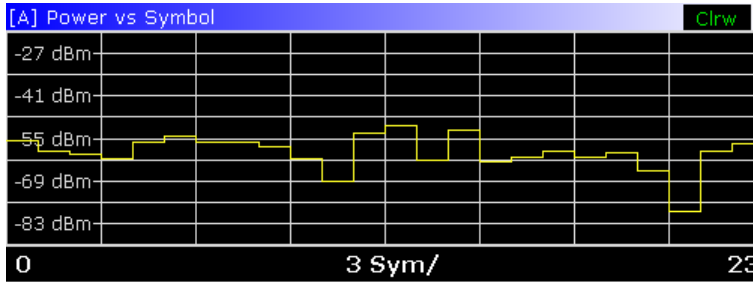

Fig. 4-42: Power of a channel on symbol level

→ Remote: CALC:FEED "XTIM:CDP:PVSYS"

Channel Bitstream

Starts the Channel Bitstream result display.

The result display provides information on the demodulated bits for the selected channel and the selected PCGs. This calculation thus takes into account the results of a channel for a specific PCG. All bits that are part of inactive channels are marked as being invalid by means of dashes. For 16QAM modulation '----' is displayed, for 8PSK modulation '---', for QPSK '--' and for BPSK '-'. To set the channel and the PCG, use the **Select Ch/PCG** softkey.

A certain symbol can be selected by using the **MKR** key. By entering a number, the marker will jump to the selected symbol. If there are more symbols than the screen is capable of displaying, the marker can also be used to scroll inside the list.

Depending on the spreading factor (symbol rate) of the channel, a minimum of 12 and a maximum of 384 symbols can be contained in a power control group. In case of an active transmit diversity (**Antenna Diversity**) the values reduce to the half. Depending on the modulation type, a symbol consists of the following bits:

- BPSK: 1 bit (only the I-component is assigned)
- QPSK: 2 bits (I-component followed by the Q-component)
- 8PSK: 3 bits
- 16QAM: 4 bits

In accordance with the radio configuration and the channel type, there are BPSK and QPSK modulated channels in the CDMA2000 system. For details refer to [Relationship between channel type and modulation type](#) on page 4.291.

The order is shown in the following figure:

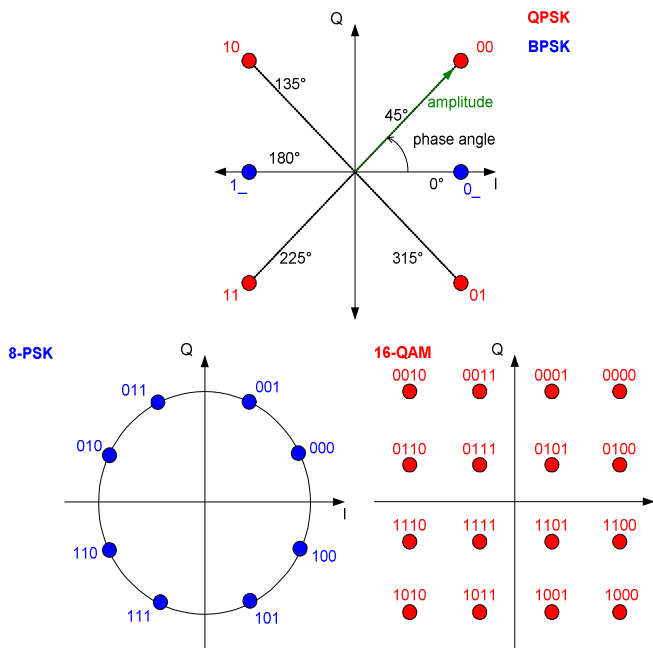

Fig. 4-43: Phasor diagram for QPSK, BPSK, 8PSK and 16QAM including bit values

[A] Channel BitStream	
0	01 01 11 00 00 01 10 11 10 00 01 00 10 11 00 10
32	10 01 10 00 11 01 11 11 11 00 01 00 10 01 00 11
64	10 00 00 00 10 01 00 01 10 01 00 01 00 01 01 01
96	01 11 01 00 01 00 11 01 00 01 10 11 00 00 00 00
128	11 01 00 11 10 10 00 01 10 00 10 01 11 01 11 11
160	01 00 00 00 11 11 00 10 10 11 10 01 11 00 01 11
192	10 00 10 10 11 00 01 10 00 00 01 10 01 10 01 01
224	01 00 11 01 10 01 11 11 01 10 00 01 11 10 10 10
256	11 11 01 11 10 01 00 10 00 00 11 00 00 11 00 10
288	11 01 10 10 11 10 11 11 01 01 10 00 00 11 10 00
320	10 00 11 01 01 11 10 00 00 10 10 00 00 00 00 01
352	01 01 11 11 00 00 00 10 11 00 00 10 00 10 01 01
384	01 10 11 00 10 00 01 11 00 10 11 11 10 11 11 11
416	01 11 00 01 01 10 01 10 11 01 00 00 10 11 10 00
448	11 00 11 11 01 00 10 00 10 11 01 00 10 10 10 10
480	01 01 00 10 11 10 10 11 01 11 10 11 00 11 00 01
512	01 00 01 11 11 00 10 00 11 11 01 10 10 01 10 10

Fig. 4-44: Demodulated bits of a channel for one PCG

→ Remote: CALC:FEED "XTIM:CDP:BSTR"

Adjust Ref Level

Adjusts the reference level to the measured channel power. This ensures that the settings of the RF attenuation and reference level are optimally adjusted to the signal level without overloading the R&S FSL or limiting the dynamic range by a too small S/N ratio.

Current measurements are aborted when pressing the softkey and resumed after the automatic level detection is finished.

For further details refer also to the **Adjust Ref Level** softkey in the measurement menu of the base unit.

→ Remote: CDP:LEV:ADJ

Softkeys of the frequency menu (CDMA2000 BTS Analyzer mode)

The following table shows all softkeys available in the frequency menu in **CDMA2000 BTS Analyzer** mode. It is possible that your instrument configuration does not provide all softkeys. If a softkey is only available with a special option, model or (measurement) mode, this information is delivered in the corresponding softkey description.

Command
Center
Start
Stop
CF-Stepsize ↓

Center

For details refer to the **Center** softkey in the frequency menu of the base unit.

Start

Opens an edit dialog box to define the start frequency. For further details refer to the **Start** softkey in the frequency menu of the base unit.

Note that the softkey is unavailable for Code Domain and CCDF measurements.

→ Remote: `FREQ:STAR 800 MHz`

Stop

Opens an edit dialog box to define the stop frequency. For further details refer to the **Stop** softkey in the frequency menu of the base unit.

Note that the softkey is unavailable for Code Domain and CCDF measurements.

→ Remote: `FREQ:STOP 1.500 MHz`

CF-Stepsize

For details including the submenu refer to the **CF Stepsize** softkey in the frequency menu of the base unit.

Softkeys of the span menu (CDMA2000 BTS Analyzer mode)

The following table shows all softkeys available in the span menu in **CDMA2000 BTS Analyzer** mode. It is possible that your instrument configuration does not provide all softkeys. If a softkey is only available with a special option, model or measurement mode, this information is delivered in the corresponding softkey description.

Note that the span menu is not available for code domain measurements and the signal power measurement.

Command
Span Manual
Sweeptime Manual
Start
Stop
Full Span
Last Span

Span Manual

For details refer to the **Span Manual** softkey in the span menu of the base unit.

Sweeptime Manual

For details refer to the **Sweeptime Manual** softkey in the bandwidth menu of the base unit.

Start

For details refer to the **Start** softkey in the span menu of the base unit.

Stop

For details refer to the **Stop** softkey in the span menu of the base unit.

Full Span

For details refer to the **Full Span** softkey in the span menu of the base unit.

Last Span

For details refer to the **Last Span** softkey in the span menu of the base unit.

Softkeys of the amplitude menu (CDMA2000 BTS Analyzer mode)

The following table shows all softkeys available in the amplitude menu in **CDMA2000 BTS Analyzer** mode. It is possible that your instrument configuration does not provide all softkeys. If a softkey is only available with a special option, model or measurement mode, this information is delivered in the corresponding softkey description.

Menu / Command	Command
Ref Level	
Adjust Ref Level	
Ref Level Offset	
Preamp On/Off	
Scaling ↓	Auto Scale Once
	y-Axis Maximum
	y-Axis Minimum
RF Atten Manual	
RF Atten Auto	

Ref Level

For details refer to the **Ref Level** softkey in the amplitude menu of the base unit.

Adjust Ref Level

For details refer to the **Adjust Ref Level** softkey in the Code Domain Analyzer menu.

Ref Level Offset

For details refer to the **Ref Level Offset** softkey in the amplitude menu of the base unit.

Preamp On/Off

For details refer to the **Preamp On/Off** softkey in the amplitude menu of the base unit.

Note that this softkey is only available if the hardware option RF Preamplifier B22 is installed.

Scaling

Opens a submenu with the following softkeys:

Auto Scale Once
y-Axis Maximum
y-Axis Minimum

This submenu is only available for code domain measurements.

Auto Scale Once

Automatically scales the y-axis of the grid of the selected screen with respect to the measured data.

The softkey is available for the following measurements: Code Domain Power, Code Domain Error, Composite EVM. Peak Code Domain Error, Peak Code Domain Error vs PCG, Power vs PCG, EVM vs Symbol and Power vs Symbol.

→ Remote: `DISP:TRAC:Y:AUTO ONCE`

y-Axis Maximum

Opens a dialog box to set the maximum value for the y-axis of the grid of the selected screen.

The softkey is available for the following measurements: Code Domain Power, Code Domain Error, Composite EVM. Peak Code Domain Error, Peak Code Domain Error vs PCG, Power vs PCG, EVM vs Symbol and Power vs Symbol.

→ Remote: `DISP:TRAC:Y:MAX -40`

y-Axis Minimum

Opens a dialog box to set the minimum value for the y-axis of the grid of the selected screen.

The softkey is available for the following measurements: Code Domain Power, Code Domain Error, Composite EVM. Peak Code Domain Error, Peak Code Domain Error vs PCG, Power vs PCG, EVM vs Symbol and Power vs Symbol.

→ Remote: `:DISP:TRAC:Y:MIN 50`

RF Atten Manual

For details refer to the **RF Atten Manual** softkey in the amplitude menu of the base unit.

RF Atten Auto

For details refer to the **RF Atten Auto** softkey in the amplitude menu of the base unit.

Softkeys of the bandwidth menu (CDMA2000 BTS Analyzer mode)

The following table shows all softkeys available in the bandwidth menu in **CDMA2000 BTS Analyzer** mode. It is possible that your instrument configuration does not provide all softkeys. If a softkey is only available with a special option, model or measurement mode, this information is delivered in the corresponding softkey description.

Note that the softkeys of the bandwidth menu are not available for code domain measurements and are inactive for the CCDF measurement.

Command
Res BW Manual
Res BW Auto
Video BW Manual
Video BW Auto

Sweeptime Manual
Sweeptime Auto
Filter Type

Res BW Manual

For details refer to the **Res BW Manual** softkey in the bandwidth menu of the base unit.

Res BW Auto

For details refer to the **Res BW Auto** softkey in the bandwidth menu of the base unit.

Video BW Manual

For details refer to the **Video BW Manual** softkey in the bandwidth menu of the base unit.

Video BW Auto

For details refer to the **Video BW Auto** softkey in the bandwidth menu of the base unit.

Sweeptime Manual

For details refer to the **Sweeptime Manual** softkey in the bandwidth menu of the base unit.

Sweeptime Auto

For details refer to the **Sweeptime Auto** softkey in the bandwidth menu of the base unit.

Filter Type

For details refer to the **Filter Type** softkey in the bandwidth menu of the base unit.

Softkeys of the sweep menu (CDMA2000 BTS Analyzer mode)

The following table shows all softkeys available in the sweep menu in **CDMA2000 BTS Analyzer** mode. It is possible that your instrument configuration does not provide all softkeys. If a softkey is only available with a special option, model or measurement mode, this information is delivered in the corresponding softkey description.

Command
Continuous Sweep
Single Sweep
Continue Single Sweep
Sweeptime Manual
Sweeptime Auto

Sweep Count
Sweep Points

Continuous Sweep

For details refer to the **Continuous Sweep** softkey in the sweep menu of the base unit.

Single Sweep

For details refer to the **Single Sweep** softkey in the sweep menu of the base unit.

Continue Single Sweep

For details refer to the **Continue Single Sweep** softkey in the sweep menu of the base unit.

Sweeptime Manual

For details refer to the **Sweeptime Manual** softkey in the sweep menu of the base unit.

The softkey is not available for code domain and the CCDF measurements.

Sweeptime Auto

For details refer to the **Sweeptime Auto** softkey in the sweep menu of the base unit.

The softkey is not available for code domain and the CCDF measurements.

Sweep Count

For details refer to the **Sweep Count** softkey in the sweep menu of the base unit.

Sweep Points

For details refer to the **Sweep Points** softkey in the sweep menu of the base unit.

Softkeys of the trigger menu (CDMA2000 BTS Analyzer mode)

The following table shows all softkeys available in the trigger menu in **CDMA2000 BTS Analyzer** mode. It is possible that your instrument configuration does not provide all softkeys. If a softkey is only available with a special option, model or measurement mode, this information is delivered in the corresponding softkey description.

Command
Trigger Source
Trigger Polarity Pos/Neg
Trigger Offset

Trigger Source

For details refer to the **Trigger Source** softkey of the IQ Capture Settings dialog box.

Trigger Polarity Pos/Neg

For details refer to the **Trigger Polarity** softkey of the IQ Capture Settings dialog box.

Trigger Offset

For details refer to the **Trigger Offset** softkey in the trigger menu of the base unit.

Softkeys of the trace menu (CDMA2000 BTS Analyzer mode)

The following table shows all softkeys available in the trace menu in **CDMA2000 BTS Analyzer** mode. It is possible that your instrument configuration does not provide all softkeys. If a softkey is only available with a special option, model or measurement mode, this information is delivered in the corresponding softkey description.

Command
Trace Mode
Screen Focus A/B
Screen Size Full/Split
Scaling
Sweep Count

Trace Mode

Opens a dialog box, in which the trace mode can be selected. For details on the various trace modes refer to the [Trace mode overview](#) on page 4.36.

Note that the **Blank** trace mode is not available for the code domain measurements. Also note that the **Trace Mode** softkey is not available for the **Result Summary** measurement. This is because in this measurement the minimum, mean and maximum values are already supported (see **Result Summary**).

→ Remote: `DISP:TRAC:MODE AVER`

Screen Focus A/B

For details refer to the **Screen Focus A/B** softkey in the Code Domain Analyzer root menu (main menu).

Screen Size Full/Split

For details refer to the **Screen Size Full/Split** softkey in the Code Domain Analyzer root menu (main menu).

Scaling

For details refer to the **Scaling** softkey in the amplitude menu.

Auto Scale Once (Scaling menu)

For details refer to the **Auto Scale Once** softkey in the amplitude menu.

y-Axis Maximum (Scaling menu)

For details refer to the **y-Axis Maximum** softkey in the amplitude menu.

y-Axis Minimum (Scaling menu)

For details refer to the **y-Axis Minimum** softkey in the amplitude menu.

Sweep Count

For details refer to the **Sweep Count** softkey in the sweep menu of the base unit.

Softkeys of the marker menu (CDMA2000 BTS Analyzer mode)

The following table shows all softkeys available in the marker menu in **CDMA2000 BTS Analyzer** mode. It is possible that your instrument configuration does not provide all softkeys. If a softkey is only available with a special option, model or measurement mode, this information is delivered in the corresponding softkey description.

The softkeys of the marker menu are not available for the Result Summary, Channel Table and CCDF measurements.

Command
Marker 1
Marker 2
Marker 3
Marker 4
Marker Norm/Delta
All Marker Off
Percent Marker

Marker 1/Marker 2/Marker 3/Marker 4/Marker Norm/Delta

The **Marker <no>** softkey activates the corresponding marker and opens an edit dialog box to enter a value for the marker to be set to. Pressing the softkey again deactivates the selected marker. If two screens are active in the Code Domain Analyzer, each of the screens has its own set of markers.

Marker 1 is always the reference marker for relative measurements. If activated, markers 2 to 4 are delta markers that refer to marker 1. These markers can be converted into markers with absolute value display by means of the **Marker Norm/Delta** softkey. If marker 1 is the active marker, pressing the **Marker Norm/Delta** softkey switches on an additional delta marker.

For the Channel Bitstream measurement only one marker (Marker 1) is available. It can be used for scrolling and to display the number and value of a bit.

- Remote: CALC:MARK ON
- Remote: CALC:MARK:X <value>
- Remote: CALC:MARK:Y?
- Remote: CALC:DELT ON
- Remote: CALC:DELT:X <value>
- Remote: CALC:DELT:X:REL?
- Remote: CALC:DELT:Y?

All Marker Off

For details refer to the **All Marker Off** softkey in the marker menu of the base unit.

Percent Marker

"Opens an edit dialog box to enter a probability value and to position marker 1. Thus, the power which is exceeded with a given probability can be determined very easily. If marker 1 is deactivated, it will be switched on automatically.

This softkey is only available for the CCDF measurement.

- Remote: CALC:MARK:Y:PERC 0...100%

Softkeys of the marker-> menu (CDMA2000 BTS Analyzer mode)

The following table shows all softkeys available in the marker-> menu in **CDMA2000 BTS Analyzer** mode. It is possible that your instrument configuration does not provide all softkeys. If a softkey is only available with a special option, model or measurement mode, this information is delivered in the corresponding softkey description.

The softkeys of the marker-> menu are not available for the Result Summary, Channel Table and CCDF measurements.

Command
Select 1 2 3 4 ↵
Peak
Next Peak
Next Peak Mode < abs>
F-PICH
F-TDPICH
More ↓
Select 1 2 3 4 ↵
Min
Next Min
Next Min Mode < abs>

Select 1 2 3 4 Δ

Selects the normal marker or the delta markers, activates the marker and opens an edit dialog box to enter a value for the marker to be set to. Δ stands for delta marker 1.

Since the Channel Bitstream measurements supports only one marker, this softkey is not available for that measurement.

- Remote: CALC:MARK1 ON
 - Remote: CALC:MARK1:X <value>
 - Remote: CALC:MARK1:Y?
-

Peak

For details refer to the **Peak** softkey in the MKR-> menu of the base unit.

Next Peak

For details refer to the **Next Peak** softkey in the MKR-> menu of the base unit.

Next Peak Mode < abs>

For details refer to the **Next Peak Mode < abs >** softkey in the MKR-> menu of the base unit.

F-PICH

Sets the marker to the F-PICH channel. The softkey is only available if the x-axis of the active screen is a code axis.

- Remote: CALC:MARK:FUNC:PICH
-

F-TDPICH

Sets the marker to the F-TDPICH channel. The softkey is only available if the x-axis of the active screen is a code axis.

- Remote: CALC:MARK:FUNC:TDP
-

Min

For details refer to the **Min** softkey in the MKR-> menu of the base unit.

Next Min

For details refer to the **Next Min** softkey in the MKR-> menu of the base unit.

Next Min Mode < abs>

For details refer to the **Next Min Mode < abs >** softkey in the MKR-> menu of the base unit.

Softkeys of the measurement menu (CDMA2000 BTS Analyzer mode)

The following table shows all softkeys available in the measurement menu in **CDMA2000 BTS Analyzer** mode. It is possible that your instrument configuration does not provide all softkeys. If a softkey is only available with a special option, model or (measurement) mode, this information is delivered in the corresponding softkey description.

Menu / Command	Submenu / Command
Code Domain Analyzer ↓	
Power	
Adjacent Channel Power ↓	ACP Config ↓
	Sweep Time
	Fast ACP On/Off
	ACP Abs/Rel
	Adjust Ref Level
Spectrum Emission Mask ↓	Edit Sweep List
	List Evaluation
	Edit Reference Range
	Edit Power Classes
	Bandclass
	Load Standard
	Save As Standard
	Meas Start/Stop
	Restore FSL K82 Files
Occupied Bandwidth ↓	% Power Bandwidth
	Adjust Ref Level
	Adjust Settings
CCDF ↓	Percent Marker
	Res BW
	# of Samples
	Scaling
	Adjust Settings

Code Domain Analyzer

Activates the Code Domain Analyzer and opens the Code Domain Analyzer menu. Select the desired result display via this menu. For details refer to [Softkeys of the Code Domain Analyzer menu \(CDMA2000 BTS Analyzer mode\)](#) on page 4.292.

For details on the measurements in the code domain, initial configuration and screen layout refer to the description of the [Code Domain Analysis](#) on page 4.284.

→ Remote: CONF:CDP:MEAS CDP

Power

Activates the Signal Channel Power measurement, in which the power of a single channel is determined.

For details on screen layout and default values see the description of the [Signal Channel Power](#) on page 4.286.

- Remote: CONF:CDP:MEAS POW
- Remote: CALC:MARK:FUNC:POW:RES? CPOW (result query)

Adjacent Channel Power

Activates the Adjacent Channel Power measurement.

In this measurement the power of the carrier and its adjacent and alternate channels is determined. For details on screen layout and default values see the description of the [Adjacent Channel Power](#) on page 4.286.

Also opens the Adjacent Channel Power submenu containing the following softkeys:

Bandclass
ACP Config
Sweep Time
Fast ACP On/Off
ACP Abs/Rel
Adjust Ref Level

- Remote: CONF:CDP:MEAS ACLR
- Remote: CALC:MARK:FUNC:POW:RES? ACP (result query)

Bandclass (Adjacent Channel Power submenu)

softkey:Band Class (K82)"Opens a dialog box to select the bandclass. The following bandclasses are available:

Band Class 0	800 MHz Cellular Band
Band Class 1	1.9 GHz PCS Band
Band Class 2	TACS Band
Band Class 3	JTACS Band
Band Class 4	Korean PCS Band
Band Class 5	450 MHz NMT Band
Band Class 6	2 GHz IMT-2000 Band
Band Class 7	700 MHz Band
Band Class 8	1800 MHz Band
Band Class 9	900 MHz Band
Band Class 10	Secondary 800 MHz
Band Class 11	400 MHz European PAMR Band
Band Class 12	800 MHz PAMR Band
Band Class 13	2.5 GHz IMT-2000 Extension Band

Band Class 14	US PCS 1.9 GHz Band
Band Class 15	AWS Band
Band Class 16	US 2.5 GHz Band
Band Class 17	US 2.5 GHz Forward Link Only Band

→ Remote: CONF:CDP:BCL <value>

ACP Config (Adjacent Channel Power submenu)

For details on the softkey and submenus refer to the **CP / ACP Config** softkey in the Adjacent Channel Power submenu of the base unit.

Sweep Time (Adjacent Channel Power submenu)

For details refer to the **Sweep Time** softkey in the Adjacent Channel Power submenu of the base unit.

Fast ACP On/Off (Adjacent Channel Power submenu)

For details refer to the **Fast ACP On/Off** softkey in the Adjacent Channel Power submenu of the base unit.

ACP Abs/Rel (Adjacent Channel Power submenu)

For details refer to the **ACP Abs/Rel** softkey in the Adjacent Channel Power submenu of the base unit.

Adjust Ref Level (Adjacent Channel Power submenu)

For details refer to the **Adjust Ref Level** softkey in the Code Domain Analyzer menu.

Spectrum Emission Mask

Performs a comparison of the signal power in different carrier offset ranges with the maximum values specified in the CDMA2000 specification. With the exception of a few softkeys this measurement is identical to the Spectrum Emission Mask measurement of the base unit (refer to [Spectrum Emission Mask](#) on page 4.98).

For details on screen layout and default values see the description of the [Spectrum Emission Mask](#) on page 4.287.

Also opens the Spectrum Emission Mask submenu containing the following softkeys:

Edit Sweep List
List Evaluation
Edit Reference Range
Edit Power Classes
Bandclass

Load Standard
Save As Standard
Meas Start/Stop
Restore FSL K82 Files

→ Remote: CONF:CDP:MEAS ESP

→ Remote: CALC:LIM:FAIL?

Edit Sweep List

For details on the Edit Sweep List softkey and its submenu refer to the **Edit Sweep List** softkey in the Spectrum Emission Mask submenu of the base unit.

List Evaluation

For details on the List Evaluation softkey and its submenu refer to the **List Evaluation** softkey in the Spectrum Emission Mask submenu of the base unit.

Edit Reference Range

Opens the Reference Range dialog box. For details refer to the **Edit Reference Range** softkey in the Spectrum Emission Mask submenu of the base unit.

Edit Power Classes

Opens the Power Classes dialog box. For details refer to the **Edit Power Classes** softkey in the Spectrum Emission Mask submenu of the base unit.

Bandclass

Opens a dialog box, to select a specific bandclass.

A list of the supported bandclasses can be found in the description of the **Bandclass** softkey in the ACP measurement menu.

The settings for each bandclass are provided in *.xml files that are located in the directory `C:\R_S\INSTR\sem_std\cdma2000\dl`. The files themselves are named C2K_DL_BC01.XML (bandclass 1) to C2K_DL_BC17.XML (bandclass 17). By selecting one of the bandclasses from the dialog box, the correct file will be loaded automatically. The file can also be loaded manually (see **Load Standard** softkey).

→ Remote: CONF:CDP:BCL <value>

Load Standard

Opens the **Load Standard** dialog box, in which the *.xml file to be imported can be selected. If a file is imported, the SEM settings specified in the file will be used. All previous SEM settings will be lost.

→ Remote: ESP:PRES "<file name>"

Save As Standard

Opens the **Save As Standard** dialog box, in which the currently used SEM settings and parameters can be saved and exported into an *.xml file. Enter the name of the file in the file name field.

It is also possible to save the settings under one of the default bandclass file names (see **Bandclass** softkey). When overwriting one of the default files, the customized settings will be linked to the corresponding bandclass while the default settings are lost.

To restore the default bandclass settings press the **Restore FSL K82 Files** softkey.

→ Remote: ESP:STOR "<file name>"

Meas Start/Stop

For details on the **Meas Start/Stop** softkey refer to the **Meas Start/Stop** softkey in the Spectrum Emission Mask submenu of the base unit.

Restore FSL K82 Files

"softkey:Restore FSL K82 Files (K82)"Restores all default files of the K82 option into the C:\R_S\INSTR\sem_std\cdma2000\dl directory. If changes have been applied to the files, these will be lost.

→ Remote: ESP:PRES:REST

Occupied Bandwidth

Activates measurement of the bandwidth assigned to the signal.

For details on screen layout and default values see the description of the [Occupied Bandwidth](#) on page 4.287.

Also opens the Occupied Bandwidth submenu containing the following softkeys:

% Power Bandwidth
Channel Bandwidth
Adjust Ref Level
Adjust Settings

→ Remote: CONF:CDP:MEAS OBAN

→ Remote: CALC:MARK:FUNC:POW:RES? OBAN (result query)

% Power Bandwidth

For details refer to the **% Power Bandwidth** softkey in the OBW submenu of the base unit.

Channel Bandwidth

For details refer to the **Channel Bandwidth** softkey in the ACP Config submenu of the base unit.

Adjust Ref Level

For details refer to the **Adjust Ref Level** softkey in the Code Domain Analyzer menu.

Adjust Settings

Automatically optimizes all instrument settings for the selected channel configuration (channel bandwidth, channel spacing) within a specific frequency range (channel bandwidth). The adjustment is carried out only once. If necessary, the instrument settings can be changed later.

→ Remote: POW:ACH:PRES OBW

CCDF

Starts the measurement of the Complementary Cumulative Distribution Function and the Crest factor.

For details on screen layout and default values see the description of the [Complementary Cumulative Distribution Function](#) on page 4.288.

Also opens the CCDF submenu containing the following softkeys:

Percent Marker
Res BW
of Samples
Scaling
More ↓
Adjust Settings

→ Remote: CONF:CDP:MEAS CCDF

Percent Marker

For details refer to the **Percent Marker** softkey in the CCDF submenu of the base unit.

Res BW

For details refer to the **Res BW** softkey in the CCDF submenu of the base unit.

of Samples

For details refer to the **# of Samples** softkey in the CCDF submenu of the base unit.

Scaling

For details refer to the **Scaling** softkey and the corresponding submenu in the CCDF submenu of the base unit.

Adjust Settings

Automatically optimizes all instrument settings for the selected channel configuration (channel bandwidth, channel spacing) within a specific frequency range (channel bandwidth). The adjustment is carried out only once. If necessary, the instrument settings can be changed later.

→ Remote: `CALC:STAT:SCAL:AUTO ONCE`

Hadamard and BitReverse Code Tables

The following tables show the code sequences with Hadamard and BitReverse orders for the Code Domain Power and Code Domain Error Power result displays.

As an example, the corresponding cells for channel 8.32 (channel number 8 for spreading factor 32) are marked to show where the different codes of this channel are located.

Table 4-14: Code table for base spreading factor 64

HADAMARD				BITREVERSE			
0	000000	0	0	0	0	0	0
1	000001	0	0	0	0	0	1
2	000010	0	0	0	0	1	0
3	000011	0	0	0	0	1	1
4	000100	0	0	0	1	0	0
5	000101	0	0	0	1	0	1
6	000110	0	0	0	1	1	0
7	000111	0	0	0	1	1	1
8	001000	0	0	1	0	0	0
9	001001	0	0	1	0	0	1
10	001010	0	0	1	0	1	0
11	001011	0	0	1	0	1	1
12	001100	0	0	1	1	0	0
13	001101	0	0	1	1	0	1
14	001110	0	0	1	1	1	0
15	001111	0	0	1	1	1	1
16	010000	0	1	0	0	0	0
17	010001	0	1	0	0	0	1
18	010010	0	1	0	0	1	0
19	010011	0	1	0	0	1	1
20	010100	0	1	0	1	0	0
21	010101	0	1	0	1	0	1
22	010110	0	1	0	1	1	0
23	010111	0	1	0	1	1	1
24	011000	0	1	1	0	0	0
25	011001	0	1	1	0	0	1
26	011010	0	1	1	0	1	0
27	011011	0	1	1	0	1	1
28	011100	0	1	1	1	0	0
29	011101	0	1	1	1	0	1
30	011110	0	1	1	1	1	0
31	011111	0	1	1	1	1	1
32	100000	1	0	0	0	0	0
33	100001	1	0	0	0	0	1
34	100010	1	0	0	0	1	0
35	100011	1	0	0	0	1	1
36	100100	1	0	0	1	0	0
37	100101	1	0	0	1	0	1
38	100110	1	0	0	1	1	0
39	100111	1	0	0	1	1	1
40	101000	1	0	1	0	0	0
41	101001	1	0	1	0	0	1
42	101010	1	0	1	0	1	0
43	101011	1	0	1	0	1	1
44	101100	1	0	1	1	0	0
45	101101	1	0	1	1	0	1
46	101110	1	0	1	1	1	0
47	101111	1	0	1	1	1	1
48	110000	1	1	0	0	0	0
49	110001	1	1	0	0	0	1
50	110010	1	1	0	0	1	0
51	110011	1	1	0	0	1	1
52	110100	1	1	0	1	0	0
53	110101	1	1	0	1	0	1
54	110110	1	1	0	1	1	0
55	110111	1	1	0	1	1	1
56	111000	1	1	1	0	0	0
57	111001	1	1	1	0	0	1
58	111010	1	1	1	0	1	0
59	111011	1	1	1	0	1	1
60	111100	1	1	1	1	0	0
61	111101	1	1	1	1	0	1
62	111110	1	1	1	1	1	0
63	111111	1	1	1	1	1	1

Table 4-15: Code table for base spreading factor 128 (part 1)

HADAMARD				BIT REVERSE			
0	000000	0 0 0 0 0 0 0 0	0 0 0 0 0 0 0 0	000000	0		
1	000001	0 0 0 0 0 0 0 1	1 0 0 0 0 0 0 0	100000	64		
2	000010	0 0 0 0 0 0 1 0	0 1 0 0 0 0 0 0	010000	32		
3	000011	0 0 0 0 0 0 1 1	1 1 0 0 0 0 0 0	110000	96		
4	000100	0 0 0 0 0 1 0 0	0 0 1 0 0 0 0 0	001000	16		
5	000101	0 0 0 0 0 1 0 1	1 0 1 0 0 0 0 0	101000	80		
6	000110	0 0 0 0 0 1 1 0	0 1 1 0 0 0 0 0	011000	48		
7	000111	0 0 0 0 0 1 1 1	1 1 1 0 0 0 0 0	111000	112		
8	0001000	0 0 0 1 0 0 0 0	0 0 0 1 0 0 0 0	0001000	8		
9	0001001	0 0 0 1 0 0 0 1	1 0 0 1 0 0 0 0	1001000	72		
10	0001010	0 0 0 1 0 0 1 0	0 1 0 1 0 0 0 0	0101000	40		
11	0001011	0 0 0 1 0 0 1 1	1 1 0 1 0 0 0 0	1101000	104		
12	0001100	0 0 0 1 1 0 0 0	0 0 1 1 0 0 0 0	0011000	24		
13	0001101	0 0 0 1 1 0 0 1	1 0 1 1 0 0 0 0	1011000	88		
14	0001110	0 0 0 1 1 0 1 0	0 1 1 1 0 0 0 0	0111000	56		
15	0001111	0 0 0 1 1 0 1 1	1 1 1 1 0 0 0 0	1111000	120		
16	0010000	0 0 1 0 0 0 0 0	0 0 0 0 1 0 0 0	0000100	4		
17	0010001	0 0 1 0 0 0 0 1	1 0 0 0 1 0 0 0	1000100	68		
18	0010010	0 0 1 0 0 0 1 0	0 1 0 0 1 0 0 0	0100100	36		
19	0010011	0 0 1 0 0 0 1 1	1 1 0 0 1 0 0 0	1100100	100		
20	0010100	0 0 1 0 1 0 0 0	0 0 1 0 1 0 0 0	0010100	20		
21	0010101	0 0 1 0 1 0 0 1	1 0 1 0 1 0 0 0	1010100	84		
22	0010110	0 0 1 0 1 0 1 0	0 1 1 0 1 0 0 0	0110100	52		
23	0010111	0 0 1 0 1 0 1 1	1 1 1 0 1 0 0 0	1110100	116		
24	0011000	0 0 1 1 0 0 0 0	0 0 0 1 1 0 0 0	0001100	12		
25	0011001	0 0 1 1 0 0 0 1	1 0 0 1 1 0 0 0	1001100	76		
26	0011010	0 0 1 1 0 0 1 0	0 1 0 1 1 0 0 0	0101100	44		
27	0011011	0 0 1 1 0 0 1 1	1 1 0 1 1 0 0 0	1101100	108		
28	0011100	0 0 1 1 1 0 0 0	0 0 1 1 1 0 0 0	0011100	28		
29	0011101	0 0 1 1 1 0 0 1	1 0 1 1 1 0 0 0	1011100	92		
30	0011110	0 0 1 1 1 0 1 0	0 1 1 1 1 0 0 0	0111100	60		
31	0011111	0 0 1 1 1 0 1 1	1 1 1 1 1 0 0 0	1111100	124		
32	0100000	0 1 0 0 0 0 0 0	0 0 0 0 0 1 0 0	0000010	2		
33	0100001	0 1 0 0 0 0 0 1	1 0 0 0 0 1 0 0	1000010	66		
34	0100010	0 1 0 0 0 0 1 0	0 1 0 0 0 1 0 0	0100010	34		
35	0100011	0 1 0 0 0 0 1 1	1 1 0 0 0 1 0 0	1100010	98		
36	0100100	0 1 0 0 0 1 0 0	0 0 1 0 0 1 0 0	0010010	18		
37	0100101	0 1 0 0 0 1 0 1	1 0 1 0 0 1 0 0	1010010	82		
38	0100110	0 1 0 0 0 1 1 0	0 1 1 0 0 1 0 0	0110010	50		
39	0100111	0 1 0 0 0 1 1 1	1 1 1 0 0 1 0 0	1110010	114		
40	0101000	0 1 0 1 0 0 0 0	0 0 0 1 0 1 0 0	0001010	10		
41	0101001	0 1 0 1 0 0 0 1	1 0 0 1 0 1 0 0	1001010	74		
42	0101010	0 1 0 1 0 0 1 0	0 1 0 1 0 1 0 0	0101010	42		
43	0101011	0 1 0 1 0 0 1 1	1 1 0 1 0 1 0 0	1101010	106		
44	0101100	0 1 0 1 1 0 0 0	0 0 1 1 0 1 0 0	0011010	26		
45	0101101	0 1 0 1 1 0 0 1	1 0 1 1 0 1 0 0	1011010	90		
46	0101110	0 1 0 1 1 0 1 0	0 1 1 1 0 1 0 0	0111010	58		
47	0101111	0 1 0 1 1 0 1 1	1 1 1 1 0 1 0 0	1111010	122		
48	0110000	0 1 1 0 0 0 0 0	0 0 0 0 1 1 0 0	0000110	6		
49	0110001	0 1 1 0 0 0 0 1	1 0 0 0 1 1 0 0	1000110	70		
50	0110010	0 1 1 0 0 0 1 0	0 1 0 0 1 1 0 0	0100110	38		
51	0110011	0 1 1 0 0 0 1 1	1 1 0 0 1 1 0 0	1100110	102		
52	0110100	0 1 1 0 0 1 0 0	0 0 1 0 1 1 0 0	0010110	22		
53	0110101	0 1 1 0 0 1 0 1	1 0 1 0 1 1 0 0	1010110	86		
54	0110110	0 1 1 0 0 1 1 0	0 1 1 0 1 1 0 0	0110110	54		
55	0110111	0 1 1 0 0 1 1 1	1 1 1 0 1 1 0 0	1110110	118		
56	0111000	0 1 1 1 0 0 0 0	0 0 0 1 1 1 0 0	0001110	14		
57	0111001	0 1 1 1 0 0 0 1	1 0 0 1 1 1 0 0	1001110	78		
58	0111010	0 1 1 1 0 0 1 0	0 1 0 1 1 1 0 0	0101110	46		
59	0111011	0 1 1 1 0 0 1 1	1 1 0 1 1 1 0 0	1101110	110		
60	0111100	0 1 1 1 1 0 0 0	0 0 1 1 1 1 0 0	0011110	30		
61	0111101	0 1 1 1 1 0 0 1	1 0 1 1 1 1 0 0	1011110	94		
62	0111110	0 1 1 1 1 0 1 0	0 1 1 1 1 1 0 0	0111110	62		
63	0111111	0 1 1 1 1 0 1 1	1 1 1 1 1 1 0 0	1111110	126		

Table 4-16: Code table for base spreading factor 128 (part 1)

	HADAMARD		RETVERSE		
64	100000	1 0 0 0 0 0 0 0	0 0 0 0 0 0 0 1	000001	1
65	100001	1 0 0 0 0 0 0 1	1 0 0 0 0 0 0 1	100001	65
66	1000010	1 0 0 0 0 0 1 0	0 1 0 0 0 0 0 1	010001	33
67	1000011	1 0 0 0 0 0 1 1	1 1 0 0 0 0 0 1	110001	97
68	1000100	1 0 0 0 0 1 0 0	0 0 1 0 0 0 0 1	001001	17
69	1000101	1 0 0 0 0 1 0 1	1 0 1 0 0 0 0 1	101001	81
70	1000110	1 0 0 0 0 1 1 0	0 1 1 0 0 0 0 1	011001	49
71	1000111	1 0 0 0 0 1 1 1	1 1 1 0 0 0 0 1	111001	113
72	1001000	1 0 0 1 0 0 0 0	0 0 0 1 0 0 0 1	0001001	9
73	1001001	1 0 0 1 0 0 0 1	1 0 0 1 0 0 0 1	1001001	73
74	1001010	1 0 0 1 0 0 1 0	0 1 0 1 0 0 0 1	0101001	41
75	1001011	1 0 0 1 0 0 1 1	1 1 0 1 0 0 0 1	1101001	105
76	1001100	1 0 0 1 1 0 0 0	0 0 1 1 0 0 0 1	0011001	25
77	1001101	1 0 0 1 1 0 0 1	1 0 1 1 0 0 0 1	1011001	89
78	1001110	1 0 0 1 1 0 1 0	0 1 1 1 0 0 0 1	0111001	57
79	1001111	1 0 0 1 1 0 1 1	1 1 1 1 0 0 0 1	1111001	121
80	1010000	1 0 1 0 0 0 0 0	0 0 0 0 1 0 0 1	0000101	5
81	1010001	1 0 1 0 0 0 0 1	1 0 0 0 1 0 0 1	1000101	69
82	1010010	1 0 1 0 0 0 1 0	0 1 0 0 1 0 0 1	0100101	37
83	1010011	1 0 1 0 0 0 1 1	1 1 0 0 1 0 0 1	1100101	101
84	1010100	1 0 1 0 1 0 0 0	0 0 1 0 1 0 0 1	0010101	21
85	1010101	1 0 1 0 1 0 0 1	1 0 1 0 1 0 0 1	1010101	85
86	1010110	1 0 1 0 1 0 1 0	0 1 1 0 1 0 0 1	0110101	53
87	1010111	1 0 1 0 1 0 1 1	1 1 1 0 1 0 0 1	1110101	117
88	1011000	1 0 1 1 0 0 0 0	0 0 0 1 1 0 0 1	0001101	13
89	1011001	1 0 1 1 0 0 0 1	1 0 0 1 1 0 0 1	1001101	77
90	1011010	1 0 1 1 0 0 1 0	0 1 0 1 1 0 0 1	0101101	45
91	1011011	1 0 1 1 0 0 1 1	1 1 0 1 1 0 0 1	1101101	109
92	1011100	1 0 1 1 1 0 0 0	0 0 1 1 1 0 0 1	0011101	29
93	1011101	1 0 1 1 1 0 0 1	1 0 1 1 1 0 0 1	1011101	93
94	1011110	1 0 1 1 1 0 1 0	0 1 1 1 1 0 0 1	0111101	61
95	1011111	1 0 1 1 1 0 1 1	1 1 1 1 1 0 0 1	1111101	125
96	1100000	1 1 0 0 0 0 0 0	0 0 0 0 0 0 1 1	0000111	3
97	1100001	1 1 0 0 0 0 0 1	1 0 0 0 0 0 1 1	1000111	67
98	1100010	1 1 0 0 0 0 1 0	0 1 0 0 0 0 1 1	0100111	35
99	1100011	1 1 0 0 0 0 1 1	1 1 0 0 0 0 1 1	1100111	99
100	1100100	1 1 0 0 0 1 0 0	0 0 1 0 0 0 1 1	0010111	19
101	1100101	1 1 0 0 0 1 0 1	1 0 1 0 0 0 1 1	1010111	83
102	1100110	1 1 0 0 0 1 1 0	0 1 1 0 0 0 1 1	0110111	51
103	1100111	1 1 0 0 0 1 1 1	1 1 1 0 0 0 1 1	1110111	115
104	1101000	1 1 0 1 0 0 0 0	0 0 0 1 0 0 1 1	0001011	11
105	1101001	1 1 0 1 0 0 0 1	1 0 0 1 0 0 1 1	1001011	75
106	1101010	1 1 0 1 0 0 1 0	0 1 0 1 0 0 1 1	0101011	43
107	1101011	1 1 0 1 0 0 1 1	1 1 0 1 0 0 1 1	1101011	107
108	1101100	1 1 0 1 1 0 0 0	0 0 1 1 0 0 1 1	0011011	27
109	1101101	1 1 0 1 1 0 0 1	1 0 1 1 0 0 1 1	1011011	91
110	1101110	1 1 0 1 1 0 1 0	0 1 1 1 0 0 1 1	0111011	59
111	1101111	1 1 0 1 1 0 1 1	1 1 1 1 0 0 1 1	1111011	123
112	1110000	1 1 1 0 0 0 0 0	0 0 0 0 1 1 1 1	0000111	7
113	1110001	1 1 1 0 0 0 0 1	1 0 0 0 1 1 1 1	1000111	71
114	1110010	1 1 1 0 0 0 1 0	0 1 0 0 1 1 1 1	0100111	39
115	1110011	1 1 1 0 0 0 1 1	1 1 0 0 1 1 1 1	1100111	103
116	1110100	1 1 1 0 0 1 0 0	0 0 1 0 1 1 1 1	0010111	23
117	1110101	1 1 1 0 0 1 0 1	1 0 1 0 1 1 1 1	1010111	87
118	1110110	1 1 1 0 0 1 1 0	0 1 1 0 1 1 1 1	0110111	55
119	1110111	1 1 1 0 0 1 1 1	1 1 1 0 1 1 1 1	1110111	119
120	1111000	1 1 1 1 0 0 0 0	0 0 0 1 1 1 1 1	0001111	15
121	1111001	1 1 1 1 0 0 0 1	1 0 0 1 1 1 1 1	1001111	79
122	1111010	1 1 1 1 0 0 1 0	0 1 0 1 1 1 1 1	0101111	47
123	1111011	1 1 1 1 0 0 1 1	1 1 0 1 1 1 1 1	1101111	111
124	1111100	1 1 1 1 1 0 0 0	0 0 1 1 1 1 1 1	0011111	31
125	1111101	1 1 1 1 1 0 0 1	1 0 1 1 1 1 1 1	1011111	95
126	1111110	1 1 1 1 1 0 1 0	0 1 1 1 1 1 1 1	0111111	63
127	1111111	1 1 1 1 1 0 1 1	1 1 1 1 1 1 1 1	1111111	127

1xEV-DO BTS Analyzer (Option K84)

The R&S FSL equipped with the 1xEV-DO BTS Analyzer option performs Code Domain measurements on forward link signals according to the 3GPP2 Standard (Third Generation Partnership Project 2) high rate packet data. The standard, which was defined for packet-oriented data communications, is generally referred to as 1xEV-DO (First Evolution Data Only).

This option is available from firmware version 1.91

To open the 1xEV-DO BTS Analyzer

- If the **1xEV-DO BTS Analyzer** mode is not the active measurement mode, press the **MODE** key and activate the **1xEV-DO BTS Analyzer** option.
- If the **1xEV-DO BTS Analyzer** mode is already active, press the **MENU** key.
The Code Domain Analyzer menu is displayed.

Further Information

- [Measurements and result display](#)
- [Channel Type Characteristics](#)
- [Predefined Channel Tables](#)

Menu and softkey description

- ["Softkeys of the Code Domain Analyzer Menu \(1xEV-DO BTS Analyzer mode\)"](#) on page 4.348
- ["Softkeys of the frequency menu \(1xEV-DO BTS Analyzer mode\)"](#) on page 4.373
- ["Softkeys of the span menu \(1xEV-DO BTS Analyzer mode\)"](#) on page 4.374
- ["Softkeys of the amplitude menu \(1xEV-DO BTS Analyzer mode\)"](#) on page 4.375
- ["Softkeys of the bandwidth menu \(1xEV-DO BTS Analyzer mode\)"](#) on page 4.376
- ["Softkeys of the sweep menu \(1xEV-DO BTS Analyzer mode\)"](#) on page 4.378
- ["Softkeys of the trigger menu \(1xEV-DO BTS Analyzer mode\)"](#) on page 4.379
- ["Softkeys of the trace menu \(1xEV-DO BTS Analyzer mode\)"](#) on page 4.379
- ["Softkeys of the marker menu \(1xEV-DO BTS Analyzer mode\)"](#) on page 4.380
- ["Softkeys of the marker-> menu \(1xEV-DO BTS Analyzer mode\)"](#) on page 4.381
- ["Softkeys of the measurement menu \(1xEV-DO BTS Analyzer mode\)"](#) on page 4.383

Measurements and result display

The 1xEV-DO BTS Analyzer option provides the following test measurement types and result displays. All measurements and result displays are accessed via the MEAS key (measurement menu).

- ["Code Domain Analysis"](#) on page 4.341
- ["Signal Channel Power"](#) on page 4.342
- ["Adjacent Channel Power"](#) on page 4.343
- ["Spectrum Emission Mask"](#) on page 4.343
- ["Occupied Bandwidth"](#) on page 4.344
- ["Complementary Cumulative Distribution Function \(CCDF\)"](#) on page 4.345
- ["Power vs Time"](#) on page 4.345

Code Domain Analysis

The Code Domain Analyzer performs measurements in the code domain. The following measurement types and corresponding result displays are available:

Softkey	Definition
Code Domain Power	Code Domain Power result display
General Results	General results in tabular form
Channel Results	Results for a specific channel in tabular form
Power vs Chip	Power of the selected channel versus all chips
Power vs Symbol	Power of the selected channel and of the selected slot versus all symbols
Composite EVM	Averaged error between the test signal and the ideal reference signal
Channel Table	Channel occupancy table
Bitstream	Display of decided bits
Peak Code Domain Error	Projection of the maximum error between the test signal and the reference signal
Code Domain Error	Code Domain Error Power result display
Symbol Constellation	Symbol constellation result display
EVM vs Symbol	Error Vector Magnitude result display
Composite Constellation	Composite constellation result display

In the Code Domain Analyzer, the results are displayed in either one screen or in two screens (see Screen Size Split/Full softkey). Any result can be displayed in either screen. On top of the measurement screens the following settings and measurement results (so called result displays) are displayed (with the respective default settings):

Frequency: 3.000 Ghz	Ref. Level: -20.00 dBm	Ref. Lvl Offset: 0.0 dB
Code Power: REL	Count: 0	RF Attenuation: 0 dB
Slot: 0 of 3	Code: 0.32	Channel Type: PILOT

In the default setting after the preset, the analyzer is in Spectrum Analyzer mode (for details see ["Initializing the Configuration - PRESET Key"](#) on page 4.2). The settings of the Code Domain Analyzer are not active until the 1xEV-DO BTS Analyzer mode is activate (see ["To open the 1xEV-DO BTS Analyzer"](#) on page 4.340)

Parameter	Setting
Digital standard	1xEV-DO, Revision 0
Sweep	Continuous
Channel table	Auto Search
Trigger source	Free Run
Trigger offset	0 s
PN offset	0 chips
Inactive channel threshold	-40 dB
Channel type	PILOT
Code number	0
Slot	0
Capture length	3 slots

In order to provide a quick swap from the base unit to the 1xEV-DO BTS Analyzer option, some parameters are passed on.

Transferred parameter
Reference level
Ref Level Offset
Attenuation
Center Frequency
Frequency offset

Signal Channel Power

The Power measurement analyses the RF signal power of a single channel with 1.2288 MHz bandwidth over a single trace. The displayed results are based on the root mean square.

The configuration is according to the 1xEV-DO requirements.

Beneath the measurement screen the bandwidth and the associated channel power are displayed. The other screen elements match that of the screen of the Spectrum Analyzer mode.

The default settings are in accordance with the 3GPP2 specifications.

Setting	Default value
Frequency Span	2 MHz
ACP Standard	1xEV-DO0 MC1
Number of adjacent channels	0
Adjacent Channel Power	On

In order to provide a quick swap from the base unit to the 1xEV-DO0 BTS Analyzer option, some parameters are passed on.

Transferred parameter
Reference Level
Ref Level Offset
RBW

Transferred parameter
VBW
of Samples

Refer also to the Power softkey in the measurement menu.

Adjacent Channel Power

The Adjacent Channel Power measurement analyses the power of the TX channel and the power of adjacent and alternate channels on the left and right side of the TX channel. The number of TX channels and adjacent channels can be modified as well as the band class.

Beneath the measurement screen the bandwidth and power of the TX channel and the bandwidth, spacing and power of the adjacent and alternate channels are displayed.

The default settings are in accordance with the 3GPP2 specifications.

Setting	Default value
Adjacent Channel Power	On
ACP Standard	1xEV-DO0 MC1
Number of adjacent channels	2

In order to provide a quick swap from the base unit to the 1xEV-DO BTS Analyzer option, some parameters are passed on.

Transferred parameter
Reference Level
Ref Level Offset
RBW
VBW
of Adjacent Channels
Sweep Time
Span
Fast ACP Mode

For details on the softkeys of the Adjacent Channel Power measurement refer to the Adjacent Channel Power softkey in the measurement menu.

Spectrum Emission Mask

The Spectrum Emission Mask measurement shows the quality of the measured signal by comparing the power values in the frequency range near the carrier against a spectral mask that is defined by the 3GPP2 specifications. The limits depend on the selected bandclass. In this way, the performance of the DUT can be tested and the emissions and their distance to the limit be identified.

Note that the 3GPP2 standard does not distinguish between spurious and spectral emissions.

Beneath the measurement screen a table showing the peak list. In the peak list the values for the worst spectral emissions are displayed including their frequency and power.

The default settings of the Spectrum Emission Mask measurement are listed in the table below.

Setting	Default value
Frequency Span	8 MHz
Sweep Time	100 ms
Detector	RMS

In order to provide a quick swap from the base unit to the 1xEV-DO BTS Analyzer option, some parameters are passed on.

Transferred Parameter
Reference Level
Ref Level Offset
Center Frequency
Frequency Offset
Trigger settings

For details on the softkeys of the Spectrum Emission Mask measurement refer to the Spectrum Emission Mask softkey in the measurement menu.

Occupied Bandwidth

The Occupied Bandwidth measurement determines the bandwidth in which the signal power can be found. By default the bandwidth is displayed in which 99% of the signal is found. The percentage of the signal power included in the measurement can be modified.

In the top right corner of the screen, the bandwidth and frequency markers are displayed.

The default settings of the Occupied Bandwidth measurement are listed in the table below.

Setting	Default value
Occupied Bandwidth	ON
Frequency Span	4.2 MHz
Sweep Time	100 ms
RBW	30 kHz
VBW	300 kHz
Detector	RMS

In order to provide a quick swap from the base unit to the 1xEV-DO BTS Analyzer option, some parameters are passed on.

Transferred parameter
Reference Level
Ref Level Offset
RBW
VBW
Sweep Time
Span

For details on the softkeys of the Occupied Bandwidth measurement see Occupied Bandwidth in the measurement menu.

Complementary Cumulative Distribution Function (CCDF)

The CCDF measurement displays the CCDF and the Crest factor. The CCDF shows distribution of the signal amplitudes. For the measurement, a signal section of settable length is recorded continuously in a zero span. The measurement is useful to determine errors of linear amplifiers.

The Crest factor is defined as the difference of the peak power and the mean power.

Beneath the measurement screen a table containing the number of included samples, mean and peak power and the Crest factor is displayed.

The default settings of the CCDF measurement are listed in the table below.

Setting	Default value
CCDF	ON
RBW	10 MHz
Detector	Sample

In order to provide a quick swap from the base unit to the 1xEV-DO BTS Analyzer option, some parameters are passed on.

Transferred parameter
Reference Level
Ref Level Offset
RBW
of Samples

For details on the softkeys of the CCDF measurement see CCDF in the measurement menu.

In a transition from the base unit to the 1xEV-DO BTS Analyzer option, external trigger sources are preserved, all other trigger sources are switched to the Free Run trigger mode. Additional trigger settings are preserved.

Power vs Time

The Power vs Time measurement examines a specified number of half slots. Up to 36 half slots can be captured and processed simultaneously. That means that for a standard measurement of 100 half slots only three data captures are necessary. After the capturing of the data the R&S FSL averages the measured values and compares the results to the emission envelope mask. You can define the emission envelope mask in the corresponding submenu.

Setting	Default value
Frequency Span	0 (Zero Span)
Sweep Time	833.38 μ s
RBW	3 MHz
VBW	10 MHz
Detector	RMS
Trace Mode	Average

In order to provide a quick swap from the base unit to the 1xEV-DO0 BTS Analyzer option, some parameters are passed on.

Transferred Parameter
Reference Level
Ref Level Offset

Transferred Parameter
Center Frequency
Frequency Offset
Trigger settings

For details on the softkeys of the Power vs Time measurement see Power vs Time in the measurement menu.

Channel Type Characteristics

The following table shows the relationship between symbol rate, spreading factor, number of symbols, number of bits, number of chips and the channel type.

Channel Type	Spreading Factor	Symbol Rate	Modulation Type	Chips per Slot	Symbols per Slot and Code	Bits per Slot and Code		
						Mapping I or Q	Mapping Complex	
PILOT	32	38.4 ksps	BPSK-I or BPSK-Q	96*2=192	6	6	12	
MAC	Rev. 0 64 Rev. A 128	19.2 ksps 9.6 ksps	BPSK-I or BPSK-Q	64*4=256	4 2	4 2	8 4	
PREAMBLE	Rev. 0 32	38.4 ksps	BPSK-I or BPSK-Q	Preamble length 64: 128: 256: 512: 1024:	2 4 8 16 32	2 4 8 16 32	4 8 16 32 64	
	Rev. A 64	19.2 ksps	BPSK-I or BPSK-Q	64: 128: 256: 512: 1024:	1 2 4 8 16	1 2 4 8 16	2 4 8 16 32	
DATA	16	76.8 ksps	QPSK, 8-PSK, 16QAM	400*4 -PreambleChips =DataNettoChips		Mapping always Complex Modulation Type		
						QPSK	8-PSK	16QAM
				1600-0 = 1600 1600-64 = 1536 1600-128 = 1472 1600-256 = 1344 1600-512 = 1088 1600-1024=576	100 96 92 84 68 36	200 192 184 168 136 72	300 288 276 252 204 104	400 384 368 336 272 144

Predefined Channel Tables

Predefined channel tables offer access to a quick configuration for the channel search. The 1xEV-DO BTS Analyzer option provides the following set of channel tables compliant with the 1xEV-DO specification:

- DPQPSK:
Channel table with channel types PILOT/MAC/PREAMBLE/DATA with modulation type QPSK in channel type DATA and the following listed active codes in channel types.
- DO8PSK:
Channel table with channel types PILOT/MAC/PREAMBLE/DATA with modulation type 8-PSK in channel type DATA and the following listed active codes in channel types.

- DO16QAM:
Channel table with channel types PILOT/MAC/PREAMBLE/DATA with modulation type 16-QAM in channel type DATA and the following listed active codes in channel types.
- DO_IDLE:
Channel table with channel types PILOT/MAC - known as IDLE slot, since it does not contain any active channels in the DATA channel type.

Tabelle 4-17: Base station channel table DOQPSK with QPSK modulation in DATA area

Channel Type	Number of Channels	Code Channel (Walsh Code.SF)	Modulation / Mapping
Pilot	1	0.32	BPSK-I
Mac	5	2.64 (RA) 3.64 4.64 34.64 35.64	BPSK-I BPSK-I BPSK-I BPSK-Q BPSK-Q
Preamble (64 chips long)	1	3.32	BPSK-I
Data	16	0.16 1.16 2.16 ... 13.16 14.16 15.16	QPSK QPSK QPSK QPSK QPSK QPSK

Tabelle 4-18: Base station channel table DO8PSK with 8-PSK modulation in DATA area

Channel Type	Number of Channels	Code Channel (Walsh Code.SF)	Modulation / Mapping
Pilot	1	0.32	BPSK-I
Mac	5	2.64 (RA) 3.64 4.64 34.64 35.64	BPSK-I BPSK-I BPSK-I BPSK-Q BPSK-Q
Preamble (64 chips long)	1	3.32	BPSK-I
Data	16	0.16 1.16 2.16 ... 13.16 14.16 15.16	8-PSK 8-PSK 8-PSK 8-PSK 8-PSK 8-PSK

Tabelle 4-19: Base station channel table DO16QAM with 16QAM modulation in DATA area

Channel Type	Number of Channels	Code Channel (Walsh Code.SF)	Modulation / Mapping
Pilot	1	0.32	BPSK-I
Mac	5	2.64 (RA) 3.64 4.64 34.64 35.64	BPSK-I BPSK-I BPSK-I BPSK-Q BPSK-Q
Preamble (64 chips long)	1	3.32	BPSK-I

Channel Type	Number of Channels	Code Channel (Walsh Code.SF)	Modulation / Mapping
Data	16	0.16 1.16 2.16 ... 13.16 14.16 15.16	16-QAM 16-QAM 16-QAM 16-QAM 16-QAM 16-QAM

Tabelle 4-20: Base station test model DO_IDLE for idle slot configuration

Channel Type	Number of Channels	Code Channel (Walsh Code.SF)	Modulation / Mapping
Pilot	1	0.32	BPSK-I
Mac	5	2.64 (RA)	BPSK-I

Softkeys of the Code Domain Analyzer Menu (1xEV-DO BTS Analyzer mode)

The following table shows all softkeys available in the main menu of the **1xEV-DO BTS Analyzer** option (**MENU** key). It is possible that your instrument configuration does not provide all softkeys. If a softkey is only available with a special option, model or (measurement) mode, this information is delivered in the corresponding softkey description.

Menu / Command	Menu / Command	Command	
Settings	Settings Overview		
	Frontend Settings		
	IQ Capture Settings		
	Demod Settings		
	Channel Table Settings	New	Add Channel
			Delete Channel
			Meas
			Sort
			Save
			Cancel
			Reload
		Copy	Same as New
		Delete	
		Edit	Same as New
		Restore Default Tables	
	Result Settings		
Screen Focus A/B			
Screen Size Split/Full			
Select Meas			
Chan Type			
Select Code/Slot			
Adjust Ref Level			

Settings

Opens a submenu to configure the Code Domain Analyzer result displays with the following softkeys:

- **Frontend Settings**
- **IQ Capture Settings**
- **Demod Settings**
- **Channel Table Settings**
- **Result Settings**

Settings Overview

This softkey opens the **Settings Overview** dialog box that visualizes the data flow of the Code Domain Analyzer and summarizes all of the current settings. In addition, the current settings can be changed via the Settings Overview dialog box.

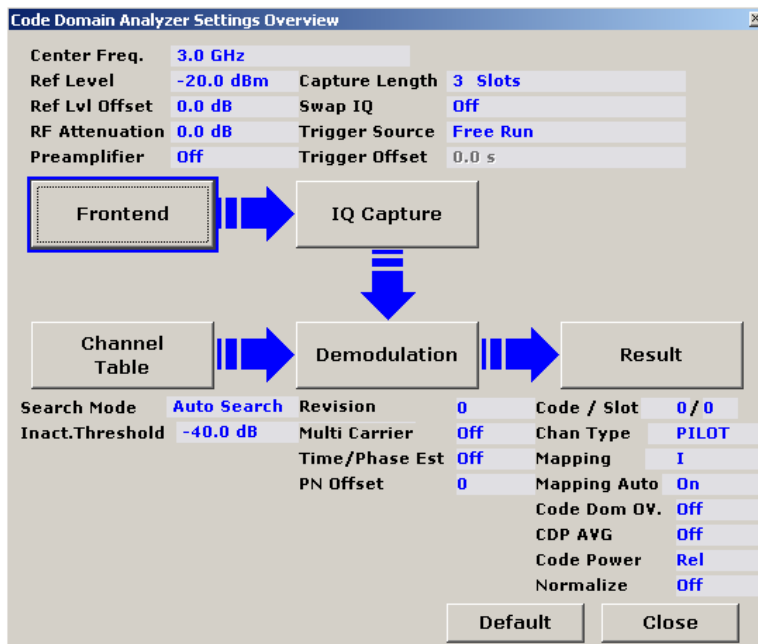

To change the settings, either use the rotary knob or the cursor keys to change the focus to any other block or press one of the following softkeys:

- **Frontend Settings**
- **IQ Capture Settings**
- **Demod Settings**
- **Channel Table Settings**
- **Result Settings**

When using the rotary knob or the cursor keys, press the **ENTER** key to open the corresponding dialog box. The Settings Overview dialog box always remains open while settings are modified.

Frontend Settings

Opens the **Frontend Settings** dialog box and corresponding softkey submenu.

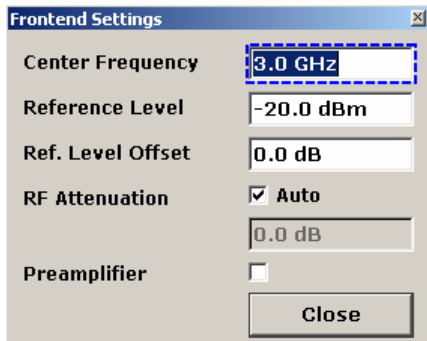

In the **Frontend Settings** dialog box, the following parameters can be modified:

Center
Ref Level
Ref Level Offset
RF Atten Manual
RF Atten Auto
Preamp On Off

Center

For details refer to the **Center** softkey in the frequency menu of the base unit.

Ref Level

For details refer to the **Ref Level** softkey in the amplitude menu of the base unit.

Ref Level Offset

For details refer to the **Ref Level Offset** softkey in the amplitude menu of the base unit.

RF Atten Manual

For details refer to the **RF Atten Manual** softkey in the amplitude menu of the base unit.

RF Atten Auto

For details refer to the **RF Atten Auto** softkey in the amplitude menu of the base unit.

Preamp On Off

For details refer to the **Preamp On/Off** softkey in the amplitude menu of the base unit.

IQ Capture Settings

Opens the **IQ Capture Settings** dialog box and corresponding softkey submenu.

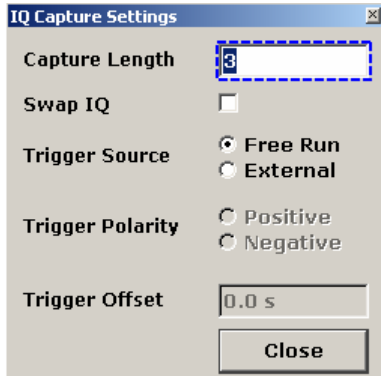

In the **IQ Capture Settings** dialog box, the following parameters can be modified:

Capture Length
Swap IQ On Off
Trigger Source
Trigger Polarity
Trigger Offset

Capture Length

Enter the number of slots to be analyzed in the range from 2 to 12. The capture length is always a multiple of the slot. The default setting is 3 slots.

→ Remote: CDP:IQL 12

Swap IQ On Off

To invert the sign of the Q-component of the signal activate the **Swap IQ** check box. The default setting is OFF.

→ Remote: CDP:QINV ON

Trigger Source

Available trigger modes are Free Run and External. For more details on trigger modes refer to "[Trigger mode overview](#)" on page 4.27. The default setting is Free Run.

→ Remote: TRIG:SOUR EXT

Trigger Polarity

Set the polarity of the trigger source. The sweep starts either after a positive or negative edge of the trigger signal. The default setting is Positive.

Trigger Polarity available only for an External trigger source.

→ Remote: TRIG:SLOP POS

Trigger Offset

For details refer to the **Trigger Offset** softkey in the trigger menu of the base unit.

Demod Settings

Opens the **Demod Settings** dialog box and corresponding softkey submenu.

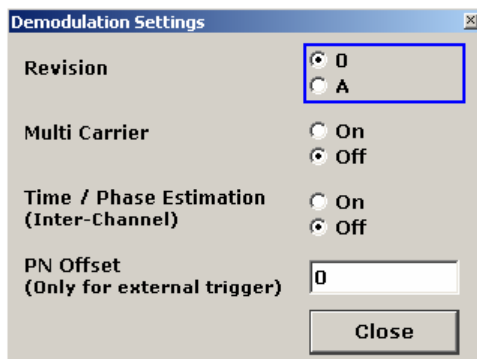

In the **Demod** dialog box, the following parameters can be modified:

Revision 0 A
Multi Carrier On Off
Time Phase Estimation On Off
PN Offset

Revision 0 A

Specifies the characteristics of the signal you want to analyze. Select whether to analyze a signal of Revision 0 or Revision A. For details on the characteristics of the revisions of the 1xEV-DO standard refer to [Channel Type Characteristics](#).

In revision A the number of active users increases. That means that the spreading factor (number of orthogonal codes) doubles for channel types MAC and PREAMBLE.

The amount of returned trace data in the MAC and PREAMBLE channels is different for Revision 0 and A, depending on the channel type and selected evaluation (see table above). The R&S FSL detects all the channels on a per slot basis. Therefore the R&S FSL recognizes changes in the channel configuration and modulation over the recorded slots.

In revision A the following modulation types are added within some of the MAC channels:

- ON/OFF keying ACK on the I branch (OOKA-I),
- ON/OFF keying ACK on the Q branch (OOKA-Q),
- ON/OFF keying NACK on the I branch (OOKN-I) and the
- ON/OFF keying NACK on the Q branch (OOKN-Q)

If the 2 bits within an ON/OFF keying modulation are identical, the modulation is not possible to be recognized as an ON/OFF keying modulation. If both bits are containing '1' information (ON) the modulation is identical to a BPSK and will be recognized as BPSK. If both bits are containing '0' information (OFF) there is no power within that code and slot and therefore no modulation is detected. Is the evaluation set to MAPPING COMPLEX the separate I and Q branch detection within the result summary is not any longer selected and the modulation type will be a 2BPSK with the coding number 5 via remote.

→ Remote: CONF:CDP:REV 0

Multi Carrier On Off

Activates or deactivates the Multi Carrier mode. The mode improves the processing of multi carrier signals. It allows the measurement on one carrier out of a multi carrier signal. This is done by activating a low pass filter and by using a special algorithm for signal detection on multi carrier signals.

Note that the low pass filter affects the measured signal quality (e.g. EVM and RHO) compared to a measurement without a filter. The algorithm used for signal detection slightly increases the calculation time.

The frequency response of the low pass filter is shown below.

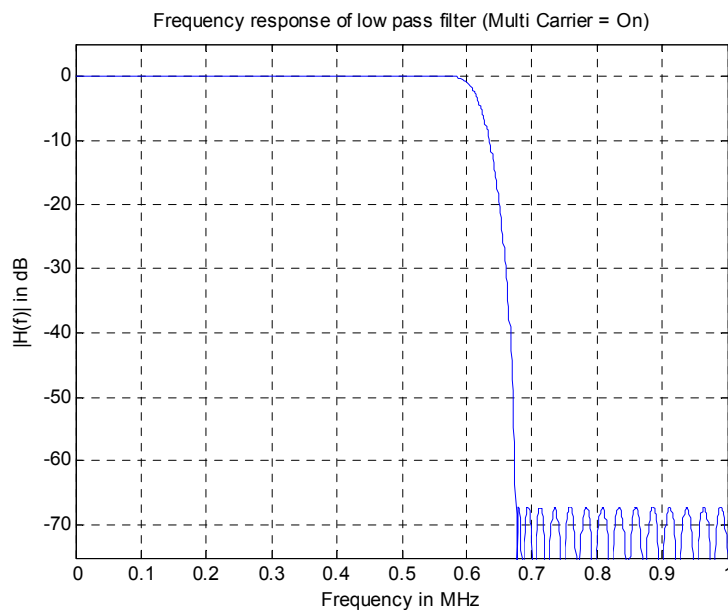

→ Remote: CONF:CDP:MCAAR ON

Time Phase Estimation On Off

Activates or deactivates the timing and phase offset calculation of the channels as to the pilot channel. If deactivated or more than 50 active channels are in the signal, the calculation does not take place and dashes instead of values are displayed as results.

→ Remote: CDP:TPM ON

PN Offset

Set the PN (Pseudo Noise) offset. The PN offset is used to distinguish the individual base stations in a 1xEV-DO network.

The PN offset determines the offset in the circulating PN sequence in multiples of 64 chips with reference to the event second clock trigger.

Although the parameter is always available, it only has a function in External trigger mode.

→ Remote: CDP: PNOF 512

Channel Table Settings

Opens the **Demod Settings** dialog box and corresponding softkey submenu. The dialog box also displays the available predefined channel tables.

Predefined channel tables are a way to customize measurements. The RECENT channel table contains the last configuration used before switching from Auto Search to Predefined. The DO16QAM, DO8PSK, DO_IDLE and DOQPSK channel tables are included in the option per default and are configured according to the standard. For details on the predefined channel tables refer to Predefined Channel Tables on page 4.289. In addition, you can create new channel tables to be used in measurements. For details refer to the **New** softkey.

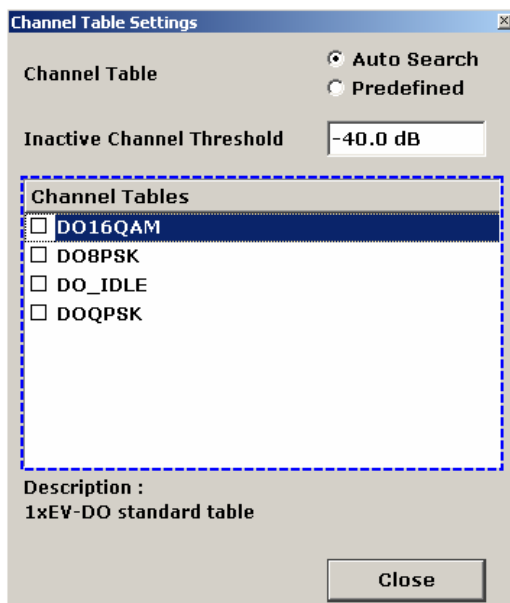

In the **Demod** dialog box, the following parameters can be modified:

Channel Table
Inactive Channel Threshold
Available Channel Tables

The softkey menu contains the following softkeys:

New
Copy
Delete
Edit
Restore Default Tables

Channel Table

Define whether to use a predefined channel table or an automatically generated channel table in the measurements.

Auto Search Searches the whole code domain (all permissible symbol rates and channel numbers) for active channels.

The automatic search provides an overview of the channels contained in the signal. If channels are not detected as being active, change the threshold (see **Inactive Channel Threshold**) or select the **Predefined** channel search type.

Predefined Performs the Code Domain Analyzer measurement on the basis of the active predefined channel table (see **Channel Table Name**). All channels of a channel table are assumed to be active. For details see [Predefined Channel Tables](#) on page 4.289.

- Remote: CONF:CDP:CTAB[:STAT] ON
 - Remote: CONF:CDP:CTAB:SEL "DOQPSK"
-

Inactive Channel Threshold

Defines the minimum power which a single channel must have compared to the total signal in order to be regarded as an active channel. Channels below the specified threshold are regarded as "inactive". The parameter is only available in the Auto Search mode of the Channel Table Settings dialog box. .

The default value is -40 dB. With this value all channels with signals such as the 1xEV-DO test models are located by the Code Domain Power analysis. Decrease the Inactive Channel Threshold value, if not all channels contained in the signal are detected.

- Remote: CDP:ICTR -40
-

Available Channel Tables

This field shows the available channel tables. To activate a predefined channel table, select the corresponding check box by using the cursor keys and pressing the **ENTER** key. The selected channel table provides a basis for future measurements (until another is chosen or Auto Search is activated).

Using the softkeys, customized channel tables can be defined or existing channel tables can be modified.

New

Creates a new channel table name that can be seen in the dialog box from then on. The name will be automatically set to 'ChannelTable'. By default, the resulting channel table is completely empty (i.e. it contains no channel at all).

The submenu contains the following items:

Add Channel
Delete Channel
Meas
Sort

Save
Cancel
Reload

→ Remote: CONF:CDP:CTAB:NAME "NEW_TAB"

Add Channel

Inserts a new channel below the one selected. The default values for a new channel are:

ChannelType	MAC
Walsh Ch.SF	2.64
SymbolRate	19.2 ksps (automatically calculated)
Modulation	BPSK-I
Power	0 dB (automatically calculated)
State	Off
DomainConflict	No (automatically calculated)

To change the channel type use the dropdown menu that opens when selecting / highlighting the **Channel Type** field that should be changed and pressing the **ENTER** key. The radio configuration settings are changed in the same way.

To change the channel number type another channel number in the form 'ChannelNumber.SpreadingFactor' or simply the code number (see **Select Code Slot** for details) in the respective field and confirm the change with the **ENTER** key.

To activate or deactivate a channel, simply select the field and confirm with the **ENTER** key.

The R&S FSL automatically checks for conflicts between two active channels.

→ Remote: CONF:CDP:CTAB:DATA "0...13, 2...7, 0...127, 0...30, 0, 0, 0 | 1"

Delete Channel

Deletes the selected channel without further notice.

Meas

Initiates a measurement in Automatic Channel Search mode. The measurement results are applied to the active channel table. The active channel table is overwritten without further notice.

The softkey is only available if the **Auto Search** mode is selected in the **Channel Table Settings** dialog box.

Sort

Sorts the table according to the following rules.

First off, active channels are separated from inactive channels. Within these categories sorting is then done first by the channel type and next by the spreading factor in ascending order. Last, the sorting is done by the code number, also in ascending order.

Save

Saves the table under its specified name in the xml-format. If you edit a channel table and want to keep the original channel table, change the name of the edited channel table before saving it.

Cancel

Closes the Edit dialog box and returns to the Channel Table Settings dialog box. Changes applied to the channel table are lost.

Reload

Reloads the original content of the copied channel table.

Copy

Copies the selected table. All elements of the selected channel table are copied, except the name which is set to 'Copy of <SourceChannelTableName>'.

The submenu is the same as that of the **New** softkey.

→ Remote: CONF:CDP:CTAB:COPY "CTAB2"

Delete

Deletes the selected channel table. The currently active channel table cannot be deleted.

→ Remote: CONF:CDP:CTAB:DEL "CTAB2"

Edit

Opens the **Edit Channel Table** dialog box and the corresponding softkey menu.

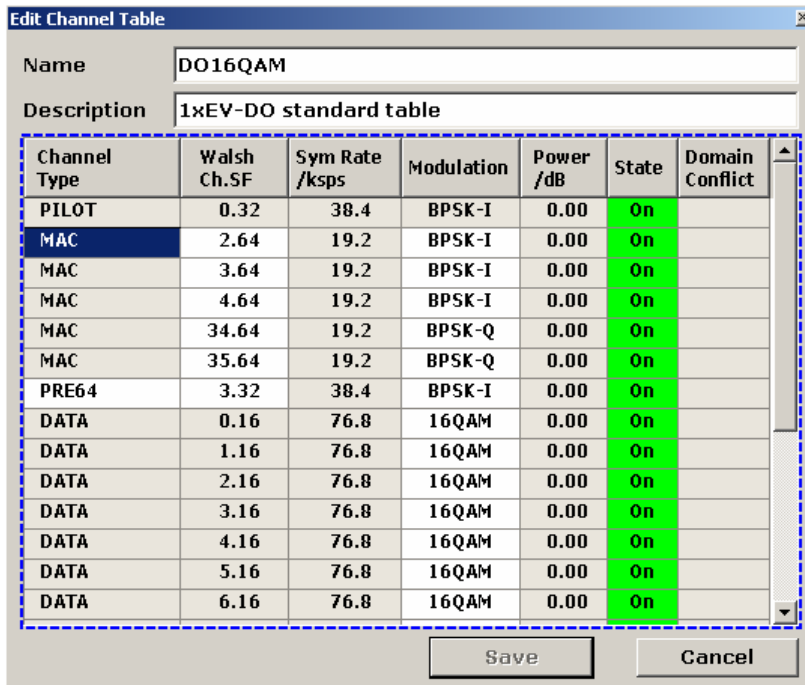

The dialog box contains the following items (grey fields can not be modified):

Item	Description
Name	Enter the name of the selected channel table, which will be saved under <name>.xml. Note that the old channel table file is not deleted. The name is case sensitive and may not contain spaces. It must be a valid MS Windows file name.
Description	Further information about the channel table can be entered
Channel Type	Select one of the channel types from the dropdown menu
Walsh Ch.SF	Enter the Channel Number (Ch) and Spreading Factor (SF). For some channel types the possible values are limited or preset (e.g. F-PDCH).
Symbol Rate/kspS	Display of the symbol rate
Modulation	Enter the modulation type for the channel.
Power/dB	Contains the measured relative code domain power. The unit is dB. The fields are filled with values after pressing the Meas softkey.
State	Indicates whether a channel is active or inactive
DomainConflict	A red bullet is shown if there's a conflict of any sort between two or more channels (e.g. two conflicting channel codes)

Changes are never saved automatically. For that reason every time a change is made, the text "(unsaved changes)" appears in the title bar.

The corresponding softkey menu contains the same items as the **New** softkey.

→ Remote: CONF:CDP:CTAB:NAME "NEW_TAB"

Restore Default Tables

Restores the predefined channel tables (see Predefined Channel Tables on page 4.289) to their factory-set values. Existing channel tables with the same name as default channel tables are replaced by this action. In this way, you can undo unintentional overwriting.

→ Remote: CONF:CDP:CTAB:REST

Result Settings

Opens the **Result Settings** dialog box.

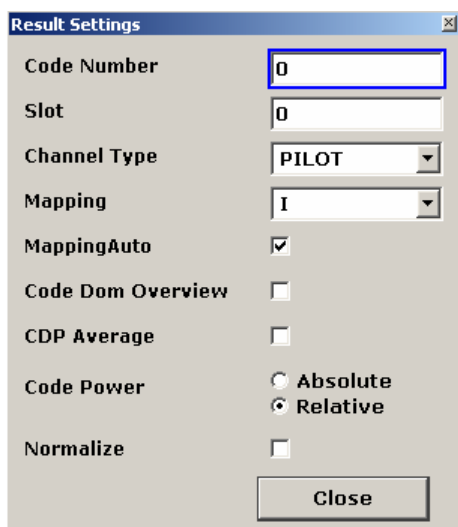

The **Result Settings** dialog box contains the following parameters:

Select Code Slot
Channel Type
Mapping
Mapping Auto
Code Dom Overview
CDP Average
Code Power
Normalize

Select Code Slot

This softkey toggles between code selection and slot selection.

If the focus is on Code Selection, select a code number. Enter the code as a decimal. The range depends on the specified channel type. For channel type PILOT and PREAMBLE values between 0 and 31 are valid. For channel type MAC the range is between 0 and 63 and for DATA only 63 is valid.

The following measurements take results for a Code into account: [Power vs Symbol](#), [Channel Results](#), [Bitstream](#), [Symbol Constellation](#), [EVM vs Symbol](#). In the following result displays, the selected code is highlighted in red: [Code Domain Power](#), [Channel Table](#), [Code Domain Error](#).

If the focus is on Slot selection, select a slot. Enter the number as a decimal. The range of the values is from 0 to (Capture Length -1). Refer to **Capture Length** for further details.

The following measurements take results for a Slot into account: [Code Domain Power](#), [Code Domain Error](#), [Channel Table](#), [Power vs Chip](#), [Power vs Symbol](#), [Composite Constellation](#), [General Results](#), [Channel Results](#), [Bitstream](#), [Symbol Constellation](#), [EVM vs Symbol](#). In the [Composite EVM](#) and [Peak Code Domain Error](#) the selected slot is highlighted in red.

- Remote: CDP:CODE 0... (CAPTURE LENGTH -1)
- Remote: CDP:CODE 0...31 | 63

Channel Type

Select one of the following channel types for the measurement:

Also opens a softkey submenu containing the following items:

Pilot
MAC
Preamble
Data

For further details on the characteristics of the channel types refer to [Channel Type Characteristics](#) on page 4.346.

- Remote: CDP:CTYP PIL

Pilot

Selects the Pilot channel type.

- Remote: CDP:CTYP PIL

MAC

Selects the MAC channel type.

- Remote: CDP:CTYP MAC

Preamble

Selects the Preamble channel type.

- Remote: CDP:CTYP PRE

Data

Selects the Data channel type.

- Remote: CDP:CTYP DATA

Mapping

The mapping mode determines whether the complex signal, the I or the Q branch is analyzed in the measurement.

Use manual mapping to obtain the option of examining any channel type as either a complex signal or in the I and Q branch. This setting is valid for any channel type. Also refer to **Mapping Auto**.

→ Remote: CDP:MMOD COMPL | I | Q

Mapping Auto

Automatically sets the type of mapping to be used in the measurement according to the following table:

Channel type	Mapping
Pilot	I or Q
MAC	I or Q
Preamble	I or Q
Data	Complex

→ Remote: CDP:MMOD AUTO

Code Dom Overview

Activate the Overview mode and screen A displays the I branch and screen B the Q branch of the signal.

This softkey is only available for Code Domain Power and Code Domain Error Power measurements. When active, the **Mapping** and **Mapping Auto** softkeys are not available.

→ Remote: CDP:OVER ON

CDP Average

Activate CDP average and the Code Domain Analysis is averaged over all slots. For channel type Data and Preamble this calculation assumes that preambles of different length do not occur in the slots. If active, ALL is displayed in the Slot field above the measurement screen.

This softkey is only available for Code Domain Analysis and is required by the 1xEV-DO standard.

→ Remote: CDP:AVER ON

Code Power

Selects for the Code Domain Power measurement whether the y-values are displayed as an absolute (dBm) or relative (dB). In Relative mode the reference is the total power of the channel type.

→ Remote: CALC:FEED "XPOW:CDP"

→ Remote: CALC:FEED "XPOW:CDP:RAT"

Normalize

Eliminates the DC offset from the signal.

The default setting of the parameter is OFF.

→ Remote: CDP:NORM OFF

Screen Focus A/B

Sets the focus on the selected screen. Changes apply only to the focused screen. There are no restrictions to the display of measurement results, i.e. you can display every result display in either or both screens.

→ Remote: DISP:WIND1:SSEL

Screen Size Split/Full

Displays the result display in full screen size, or splits the screen to display two result displays.

To change settings in split screen display, set the focus on the designated result display via the **Screen Focus A/B** softkey.

→ Remote: DISP:FORM SING

Select Meas

Opens a dialog box to select one of the measurements and result displays of the Code Domain Analyzer:

- Code Domain Power
- General Results
- Channel Results
- Power vs Chip
- Power vs Symbol
- Composite EVM
- Channel Table
- Bitstream
- Peak Code Domain Error
- Code Domain Error
- Symbol Constellation
- EVM vs Symbol
- Composite Constellation

For details on screen layout and default settings refer to the measurement description of the [Measurements and result display](#).

Code Domain Power

Starts the Code Domain Power (CDP) result display. By default the scaling is relative.

This result display determines the power of all codes of a specific channel and plots it in a diagram. The x-axis represents the code number. The number of codes depends on the **Channel Type**. Each bar in the diagram represents one code. The y-axis is a logarithmic level axis that shows the power of each code.

The measurement evaluates the total signal of a specific channel over a single slot.

Configure this result display via the **Result Settings** dialog box.

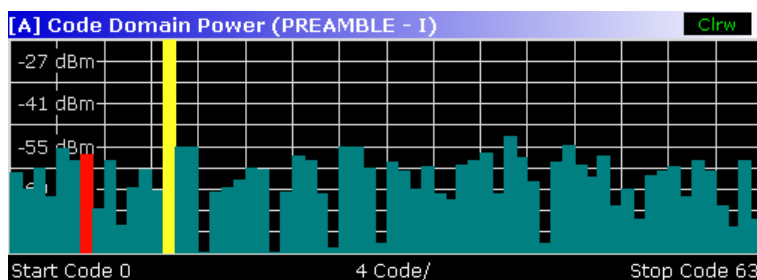

The standard requires a averaged code domain analysis. Activate **CDP Average** to perform a measurement over all slots. In case of Data and Preamble channel types the standard assumes that preambles of different lengths do not occur in the slots.

The power values of the assigned and unassigned codes are displayed in different colors:

- Yellow: assigned code
- Cyan: unassigned code

For details on the inactive channel threshold refer to **Inactive Channel Threshold**.

Set the mapping with **Mapping**. There is also an auto mapping function available (see **Mapping Auto**). It causes complex mapping to be analyzed separately for the Data channel type and mapping for the I or Q branch to be analyzed separately for the other channel types. In the latter case the I/Q selection can be set by means of the SELECT I/Q softkey. For a separate analysis of the I and Q branch, activate **Code Dom Overview** mode. Screen A displays the I branch and screen B the Q branch of the signal.

Another option for obtaining an overview of the CDP is to enable complex mapping (see **Mapping**). The code domain power is then constantly displayed as a complex analysis on screen A for the selected channel type.

In case of an analysis of the Data channel, the results of complex analysis are approximately 3 dB higher than the results of a separate I or Q analysis. This is because 50% of the power values are distributed to I and Q, respectively, for the complex modulation types of the DATA channel type.

- Remote: CALC:FEED "XPOW:CDP:RAT"
- Remote: CALC:FEED "XPOW:CDP"
- Remote: CDP:OVER ON

General Results

Under General Results, the measurement results that concern the total signal or the entire period of observation are displayed. The upper part of the result display shows the global results, i.e. results for all channels:

- **Carrier Frequency Error** (absolute and relative)

Shows the frequency error referred to the center frequency. The absolute frequency error is the sum of the frequency error of the analyzer and that of the device under test.

Differences of more than 4.0 kHz between transmitter and receiver frequency impair the synchronization of the CDP measurement. If at all possible, the transmitter and the receiver should be synchronized.

The unit of the frequency error is either Hz or ppm referred to the carrier frequency.

- **Chip Rate Error**

Shows the chip rate error (1.2288 Mcps) in ppm. A large chip rate error results in symbol errors and, consequently, in possible synchronization errors for CDP measurements.

This measurement result is also valid if the analyzer was not able to synchronize onto the 1xEV-DO signal.

- **Trigger to Frame**

This measurement result reproduces the timing offset from the beginning of the acquired signal section until the start of the first slot. In case of triggered data acquisition, this corresponds to the timing offset frame to trigger (+ trigger offset) until the start of the first slot. If the analyzer was not able to synchronize onto the 1xEV-DO signal, the value of Trg to Frame is not meaningful. For the Free Run trigger mode, dashes (---) are displayed.

- **RHO Pilot**

Shows the quality parameter RHO for the pilot channel. According to the standard, RHO is measured over all slots.

- **RHO ov -1/2**

Shows the quality parameter RHO for all chips and over all slots. According to the standard, the averaging limit is on the half slot limit.

- **RHO MAC**

Shows the quality parameter RHO for the MAC channel

- **RHO DATA**

Shows the quality parameter RHO for the Data channel

The bottom part of General Results shows results specific to the selected slot:

- **Power PILOT**

Shows the absolute power of the Pilot channel in dBm.

- **Power MAC**

Shows the absolute power of the MAC channel in dBm.

- **Power DATA**

Shows the absolute power of the Pilot channel in dBm.

- **Power PREAMBLE**

Shows the absolute power of the Preamble channel in dBm.

- **Composite EVM**

The composite EVM value is the difference between the test signal and ideal reference signal (also see Composite EVM).

- **Max. Pwr DATA**

Shows the maximum power of the Data channel. This is the highest value of the I- and Q-branch of the Data channel.

- **Min. Pwr. DATA**

Shows the minimum power of the Data channel. This is the smallest value of the I- and Q-branch of the Data channel.

- **Data Mode Type**

Shows the modulation type of the Data channel.

- **Act. MAC Chs**

Shows the number of active MAC channels.

- **Act. DATA Chs**

Shows the number of active Data channels.

- **Preamble Length**

Shows the length of the preamble in chips. If no preamble is present in the slot, this value is 0.

- **RHO**

Shows the quality parameter RHO calculated over a slot.

- **Max. inact. Pwr MAC**

Shows the maximum power of inactive MAC channels. This is the highest inactive channel from the I- and Q-branch of the MAC channels.

→ Remote: CALC:FEED "XTIM:CDP:ERR:SUMM"

→ Remote: CALC:MARK:FUNC:POW:RES?

Channel Results

Under Channel Results, the measurement results that concern a specific channel are displayed. The upper part of the result display shows common results for the selected channel:

- **Power**

Shows the total power of the selected channel type.

- **IQ Imbalance**

Shows the IQ imbalance of the signal in percent.

- **Pk CDE (SF xx/IQ)**

The Peak Code Domain Error measurement specifies a projection of the difference between test signal and ideal reference signal to the spreading factor that belongs to the channel type. This spreading factor is shown in brackets.

- **IQ Offset**

Shows the DC offset of the signal in percent.

The bottom part of the result display shows results specific to the selected channel type and the selected slot:

- **Symbol Rate**

Shows the symbol rate with which the channel is transmitted.

- **Channel.SF**

Shows the code number and its associated spreading factor.

- **Symbol EVM**

Shows the peak and the mean values of the Error Vector Magnitude measurement (also see EVM vs Symbol).

- **Timing Offset**

Shows the timing offset between the selected channel and the first active channel in the channel type (also see Time Phase Estimation On Off).

- **Phase Offset**

Shows the phase offset between the selected channel and the first active channel in the channel type (also see Time Phase Estimation On Off).

- **Channel Pwr Rel**

Shows the relative channel power (referred to the total power of the channel type).

- **Channel Pwr Abs**

Shows the absolute channel power (referred to the total power of the channel type).

- **Modulation Type**

Shows the modulation type of the channel.

→ Remote: CALC:FEED "XTIM:CDP:ERR:SUMM"

→ Remote: CALC:MARK:FUNC:POW:RES?

Power vs Chip

Starts the Power vs Chip result display.

This result display shows the power for all chips in a specific slot. Therefore, a trace consists of 2048 power values.

The measurement evaluates the total signal over a single slot.



Select the slot to be analyzed with **Select Code Slot**.

Due to the symmetric structure of the 1xEV-DO forward link signal, it is easy to identify which channel types in the slot have power.

→ Remote: CALC2:FEED "XTIM:CDP:PVCH"

Power vs Symbol

Starts the Power versus Symbol result display.

This result display shows the power of a code at each symbol time. The number of symbols on the x-axis is between 2 and 100, depending on the channel type.

The measurement evaluates a specific channel type over a single slot.

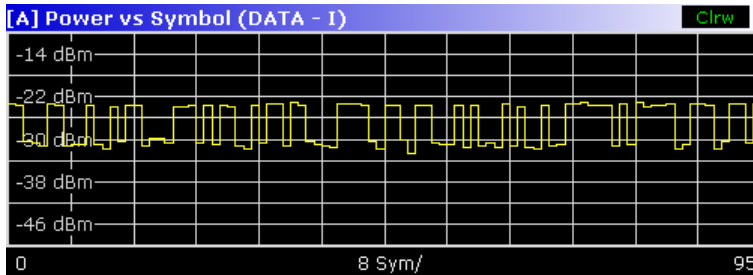

→ Remote: CALC2:FEED "XTIM:CDP:PVSY"

Composite EVM

Starts the Composite EVM (Error Vector Magnitude) result display.

This result display is for measuring the modulation accuracy. It determines the error vector magnitude (EVM) over the total signal. The EVM is the root of the ratio of the mean error power to the power of an ideally generated reference signal. To calculate the mean error power, the root mean square average (of the real and imaginary parts of the signal) is used.

The EVM is shown in %. The diagram consists of a composite EVM for each slot. Set the number of slots via the **Capture Length**.

The measurement evaluates the total signal over the entire period of observation. The selected slot is displayed red.

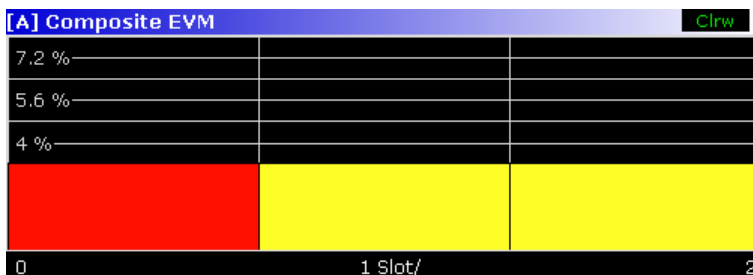

Only the channels detected as being active are used to generate the ideal reference signal. If a channel is not detected as being active, e.g. on account of low power, the difference between the test signal and the reference signal and the composite EVM is therefore very large.

Distortions also occur if unassigned codes are wrongly given the status of "active channel". To obtain reliable measurement results, select an adequate channel threshold via the **Inactive Channel Threshold** field.

→ Remote: CALC2:FEED "XTIM:CDP:MACC"

Channel Table

Starts the Channel Occupancy Table analysis.

In this result display all active channels are displayed. Therefore the channel table can contain up to 146 entries: one entry for Pilot and Preamble channel each, 16 entries for the Data channel and 128 entries for the MAC channel (64 on the I and Q branch respectively).

The channels are listed in the following order: first the Pilot channel, then the MAC and Preamble channels and the Data channel last. Within the channel types, the channels are sorted by ascending code number.

The measurement evaluates the total signal over a single slot.

The R&S FSL determines the following parameters for the channels:

– **Channel Type**

Shows the channel type of the active channel. Possible values are Pilot, MAC and Data. For the Preamble channel, the length in chips is similarly specified, thus resulting in the following options for the Preamble channel type: PRE64, PRE128, PRE256, PRE512 or PRE1024.

– **CHAN.SF**

Channel number including the spreading factor (in the form <Channel>.<SF>).

– **Symb Rate**

Symbol rate with which the channel is transmitted.

– **Modulation / Mapping**

Shows the modulation type of the channel. For Data channels possible values are QPSK, 8-PSK and 16 QAM. For all other channel types possible values are either BPSK-I or BPSK-Q.

– **Pwr Abs / Pwr Rel**

Specification of the absolute and relative power (referred to the total power in the channel type) of the channel.

– **T Offs**

Shows the timing offset between the current channel and the first active channel. It can be enabled by means of **Time Phase Estimation On Off**.

– **Ph Offs**

Phase offset between this channel and the first active channel. It can be enabled by means of **Time Phase Estimation On Off**.

→ Remote: CALC:FEED "XTIM:CDP:ERR:CTAB"

Bitstream

Starts the Bitstream result display.

This result display provides information on the demodulated bits for the selected channel type. All bits that are part of inactive channels are marked as being invalid by means of dashes. For 16QAM modulation '----' is displayed, for 8PSK modulation '---', for QPSK '--' and for BPSK '-'.

The measurement evaluates a single channel type over a single slot.

A specific symbol can be selected by using the MKR key. By entering a number, the marker will jump to the selected symbol. If there are more symbols than the screen is capable of displaying, the marker can also be used to scroll inside the list.

Depending on the modulation and the channel type, a minimum of 4 and a maximum of 400 bits can be contained in a slot. For more information on this topic refer to [Channel Type Characteristics](#).

Depending on the modulation type, a symbol consists of the following bits:

- BPSK: 1 bit (only the I or the Q component is assigned; in case of complex mapping a 2BPSK modulation is displayed with both the I and Q components)
- QPSK: 2 bits (I-component followed by the Q-component)
- 8PSK: 3 bits
- 16QAM: 4 bits

→ Remote: `CALC:FEED "XTIM:CDP:BSTR"`

Peak Code Domain Error

Starts the Peak Code Domain Error result display.

The Peak Code Domain Error is defined as the maximum value for the Code Domain Error for all codes. That means that in this result display the [Code Domain Error](#) is projected onto the code domain at a specific base spreading factor. The spreading factor is automatically set by the channel type. Define the number of slots via the **Capture Length** field. In the diagram, each bar of the x-axis represents one PCG. The y-axis represents the error power.

The measurement evaluates the total signal over the entire period of observation. The currently selected slot is marked in red.

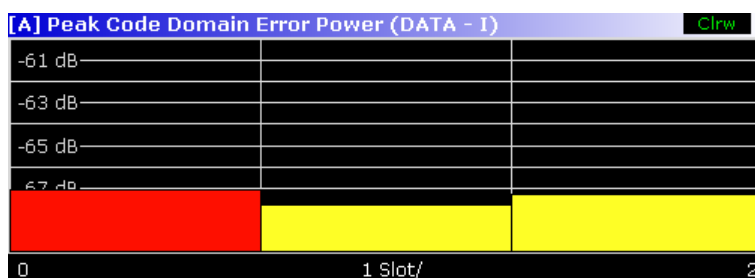

Only the channels detected as being active are used to generate the ideal reference signal. If a channel is not detected as being active, e.g. on account of low power, the difference between the test signal and the reference signal is very large. The result display therefore shows a peak code domain error that is too high for all slots. Distortions also occur if unassigned codes are wrongly given the status of "active channel". To obtain reliable measurement results, select an adequate channel threshold via the **Inactive Channel Threshold** field.

→ Remote: `CALC:FEED "XTIM:CDP:ERR:PCD"`

Code Domain Error

Starts the Code Domain Error Power (CDEP) result display.

This result display shows the difference in power between measured and ideally generated reference signals for each code in dB. Since it is an error power, active and inactive channels can be rated jointly at a glance. The total signal is taken into account over a single slot. The error power is determined and plotted in a diagram. In this diagram, the x-axis represents the code number, which depends on the channel type. The y-axis is a logarithmic level axis that shows the power of each code. To configure this result display, use the **Result Settings** dialog box (**Settings** softkey menu, **Result Settings** softkey).

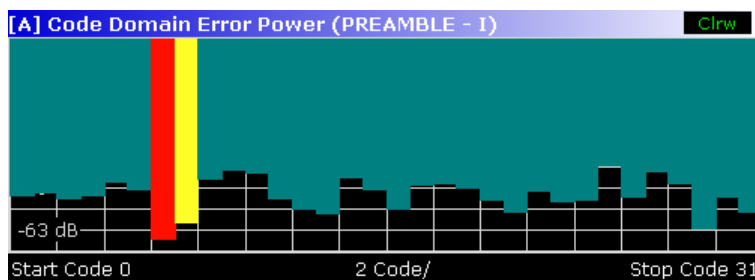

The power values of the assigned and unassigned codes are displayed in different colors:

- Yellow: assigned code
- Cyan: unassigned code

→ Remote: CALC:FEED "XTIM:CDP"

Symbol Constellation

Starts the Symbol Constellation result display.

This result display shows the channel constellation of the modulated signal at symbol level.

The measurement evaluates a single code over a single slot.

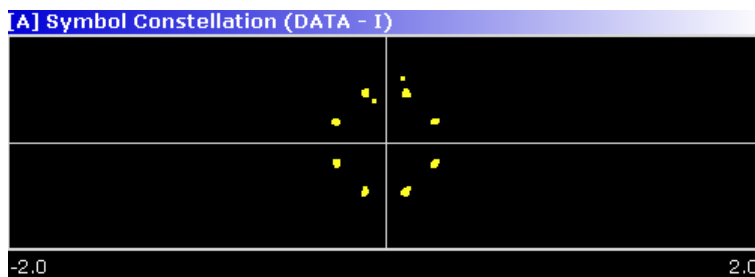

The R&S FSL-K84 supports BPSK, QPSK, 8PSK and 16QAM modulation schemes. The modulation scheme itself depends on the channel type. Refer to [Channel Type Characteristics](#) for further information.

In case of BPSK the constellation points are located on the x-axis. For the QPSK and 16QAM schemes the constellation points are located on neither axis. Unassigned codes can be measured, but the result is meaningless since these do not contain data.

→ Remote: CALC:FEED "XTIM:CDP:SYMB:CONS"

EVM vs Symbol

Starts the Symbol Error Vector Magnitude result display.

This result display shows the EVM on symbol level. The x-axis represents the symbols and the y-axis shows the EVM in %. The number of symbols depends on the channel type and is in the range from 2 to 100. Refer to [Channel Type Characteristics](#) for further information.

The measurement evaluates a single channel over a single slot.

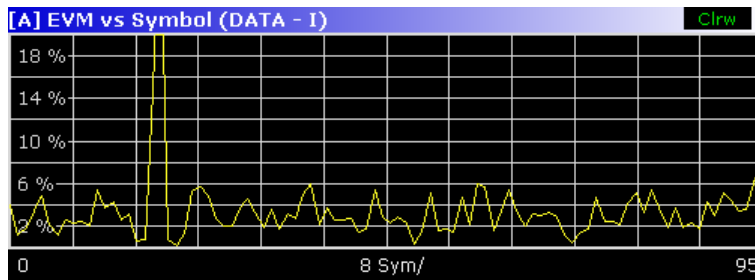

Inactive channels can be measured, but the result is meaningless since these channels do not contain data.

→ Remote: CALC:FEED "XTIM:CDP:SYMB:EVM"

Composite Constellation

Starts the Composite Constellation result display.

This result display provides information about the constellation points at chip level. For each chip, a constellation point is displayed in the diagram. The number of chips is between 64 and 1500. It depends on the channel type and, in case of Preamble and Data channels, on the length of the preamble. Refer to [Channel Type Characteristics](#) for further information.

The measurement evaluates the total signal over a single slot.

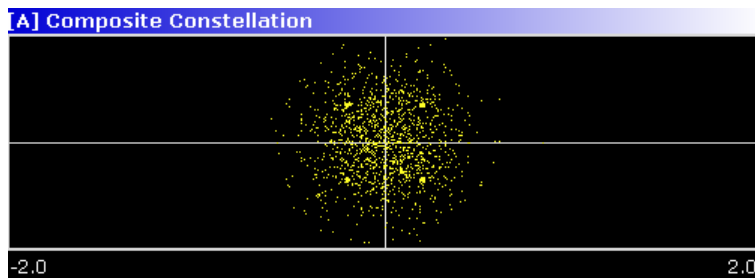

→ Remote: CALC:FEED "XTIM:CDP:COMP:CONS"

Chan Type

Opens submenu containing the following softkeys:

Command
Screen Focus A/B
Select Meas
Chan Type Pilot Mac
Chan Type Preamble Data
Code Dom Overview

Mapping Auto
Mapping Complex I Q

Screen Focus A/B

For details refer to **Screen Focus A/B**.

Select Meas

For details refer to **Select Meas**.

Chan Type Pilot Mac

Select either the Pilot or Mac channel type.

For further details on the characteristics of the channel types refer to [Channel Type Characteristics](#) on page 4.346.

→ Remote: CDP:CTYP MAC | PIL

Chan Type Preamble Data

Select either the Preamble or Data channel type.

For further details on the characteristics of the channel types refer to [Channel Type Characteristics](#) on page 4.346.

→ Remote: CDP:CTYP PRE | DATA

Code Dom Overview

For details refer to **Code Dom Overview**.

Mapping Auto

For details refer to **Mapping Auto**.

Mapping Complex I Q

For details refer to **Mapping**.

Select Code/Slot

For details refer to **Select Code Slot**.

Adjust Ref Level

Adjusts the reference level to the measured channel power. This ensures that the settings of the RF attenuation and reference level are optimally adjusted to the signal level without overloading the R&S FSL or limiting the dynamic range by a too small S/N ratio.

Current measurements are aborted when pressing the softkey and resumed after the automatic level detection is finished.

For further details refer also to the **Adjust Ref Level** softkey in the measurement menu of the base unit.

→ Remote: CDP:LEV:ADJ

Softkeys of the frequency menu (1xEV-DO BTS Analyzer mode)

The following table shows all softkeys available in the frequency menu in **1xEV-DO BTS Analyzer** mode. It is possible that your instrument configuration does not provide all softkeys. If a softkey is only available with a special option, model or (measurement) mode, this information is delivered in the corresponding softkey description.

Command
Center
Start
Stop
CF-Stepsize ↓

Center

For details refer to the **Center** softkey in the frequency menu of the base unit.

Start

Opens an edit dialog box to define the start frequency. For further details refer to the **Start** softkey in the frequency menu of the base unit.

Note that the softkey is unavailable for Code Domain and CCDF measurements.

→ Remote: `FREQ:STAR 800 MHz`

Stop

Opens an edit dialog box to define the stop frequency. For further details refer to the **Stop** softkey in the frequency menu of the base unit.

Note that the softkey is unavailable for Code Domain and CCDF measurements.

→ Remote: `FREQ:STOP 1.500 MHz`

CF-Stepsize

For details including the submenu refer to the **CF Stepsize** softkey in the frequency menu of the base unit.

Softkeys of the span menu (1xEV-DO BTS Analyzer mode)

The following table shows all softkeys available in the span menu in **1xEV-DO BTS Analyzer** mode. It is possible that your instrument configuration does not provide all softkeys. If a softkey is only available with a special option, model or measurement mode, this information is delivered in the corresponding softkey description.

Note that the span menu is not available for code domain measurements and the signal power measurement.

Command
Span Manual
Sweeptime Manual
Start
Stop
Full Span
Last Span

Span Manual

For details refer to the **Span Manual** softkey in the span menu of the base unit.

Sweeptime Manual

For details refer to the **Sweeptime Manual** softkey in the bandwidth menu of the base unit.

Start

For details refer to the **Start** softkey in the span menu of the base unit.

Stop

For details refer to the **Stop** softkey in the span menu of the base unit.

Full Span

For details refer to the **Full Span** softkey in the span menu of the base unit.

Last Span

For details refer to the **Last Span** softkey in the span menu of the base unit.

Softkeys of the amplitude menu (1xEV-DO BTS Analyzer mode)

The following table shows all softkeys available in the amplitude menu in **1xEV-DO BTS Analyzer** mode. It is possible that your instrument configuration does not provide all softkeys. If a softkey is only available with a special option, model or measurement mode, this information is delivered in the corresponding softkey description.

Menu / Command	Command
Ref Level	
Adjust Ref Level	
Ref Level Offset	
Preamp On/Off	
Scaling	Auto Scale Once
	y-Axis Maximum
	y-Axis Minimum
RF Atten Manual	
RF Atten Auto	

Ref Level

For details refer to the **Ref Level** softkey in the amplitude menu of the base unit.

Adjust Ref Level

For details refer to the **Adjust Ref Level** softkey in the Code Domain Analyzer menu.

Ref Level Offset

For details refer to the **Ref Level Offset** softkey in the amplitude menu of the base unit.

Preamp On/Off

For details refer to the **Preamp On/Off** softkey in the amplitude menu of the base unit.

Note that this softkey is only available if the hardware option RF Preamplifier B22 is installed.

Scaling

Opens a submenu with the following softkeys:

Auto Scale Once
y-Axis Maximum
y-Axis Minimum

This submenu is only available for code domain measurements.

Auto Scale Once

Automatically scales the y-axis of the grid of the selected screen with respect to the measured data.

The softkey is available for the following measurements: Code Domain Power, Code Domain Error, Composite EVM. Peak Code Domain Error, Peak Code Domain Error vs PCG, Power vs PCG, EVM vs Symbol and Power vs Symbol.

→ Remote: `DISP:TRAC:Y:AUTO ONCE`

y-Axis Maximum

Opens a dialog box to set the maximum value for the y-axis of the grid of the selected screen.

The softkey is available for the following measurements: Code Domain Power, Code Domain Error, Composite EVM. Peak Code Domain Error, Peak Code Domain Error vs PCG, Power vs PCG, EVM vs Symbol and Power vs Symbol.

→ Remote: `DISP:TRAC:Y:MAX -40`

y-Axis Minimum

Opens a dialog box to set the minimum value for the y-axis of the grid of the selected screen.

The softkey is available for the following measurements: Code Domain Power, Code Domain Error, Composite EVM. Peak Code Domain Error, Peak Code Domain Error vs PCG, Power vs PCG, EVM vs Symbol and Power vs Symbol.

→ Remote: `DISP:TRAC:Y:MIN 50`

RF Atten Manual

For details refer to the **RF Atten Manual** softkey in the amplitude menu of the base unit.

RF Atten Auto

For details refer to the **RF Atten Auto** softkey in the amplitude menu of the base unit.

Softkeys of the bandwidth menu (1xEV-DO BTS Analyzer mode)

The following table shows all softkeys available in the bandwidth menu in **1xEV-DO BTS Analyzer** mode. It is possible that your instrument configuration does not provide all softkeys. If a softkey is only available with a special option, model or measurement mode, this information is delivered in the corresponding softkey description.

Note that the softkeys of the bandwidth menu are not available for code domain measurements and are inactive for the CCDF measurement.

Command
Res BW Manual
Res BW Auto
Video BW Manual
Video BW Auto

Sweeptime Manual
Sweeptime Auto
Filter Type

Res BW Manual

For details refer to the **Res BW Manual** softkey in the bandwidth menu of the base unit.

Res BW Auto

For details refer to the **Res BW Auto** softkey in the bandwidth menu of the base unit.

Video BW Manual

For details refer to the **Video BW Manual** softkey in the bandwidth menu of the base unit.

Video BW Auto

For details refer to the **Video BW Auto** softkey in the bandwidth menu of the base unit.

Sweeptime Manual

For details refer to the **Sweeptime Manual** softkey in the bandwidth menu of the base unit.

Sweeptime Auto

For details refer to the **Sweeptime Auto** softkey in the bandwidth menu of the base unit.

Filter Type

For details refer to the **Filter Type** softkey in the bandwidth menu of the base unit.

Softkeys of the sweep menu (1xEV-DO BTS Analyzer mode)

The following table shows all softkeys available in the sweep menu in **1xEV-DO BTS Analyzer** mode. It is possible that your instrument configuration does not provide all softkeys. If a softkey is only available with a special option, model or measurement mode, this information is delivered in the corresponding softkey description.

Command
Continuous Sweep
Single Sweep
Sweeptime Manual
Sweeptime Auto
Sweep Count
Sweep Points

Continuous Sweep

For details refer to the **Continuous Sweep** softkey in the sweep menu of the base unit.

Single Sweep

For details refer to the **Single Sweep** softkey in the sweep menu of the base unit.

Continue Single Sweep

For details refer to the **Continue Single Sweep** softkey in the sweep menu of the base unit.

Sweeptime Manual

For details refer to the **Sweeptime Manual** softkey in the sweep menu of the base unit.

The softkey is not available for code domain and the CCDF measurements.

Sweeptime Auto

For details refer to the **Sweeptime Auto** softkey in the sweep menu of the base unit.

The softkey is not available for code domain and the CCDF measurements.

Sweep Count

For details refer to the **Sweep Count** softkey in the sweep menu of the base unit.

Sweep Points

For details refer to the **Sweep Points** softkey in the sweep menu of the base unit.

Softkeys of the trigger menu (1xEV-DO BTS Analyzer mode)

The following table shows all softkeys available in the trigger menu in **1xEV-DO BTS Analyzer** mode. It is possible that your instrument configuration does not provide all softkeys. If a softkey is only available with a special option, model or measurement mode, this information is delivered in the corresponding softkey description.

Command	
Trigger Source	
Trigger Polarity Pos/Neg	
Trigger Offset	

Trigger Source

For details refer to the **Trigger Source** softkey of the IQ Capture Settings dialog box.

Trigger Polarity Pos/Neg

For details refer to the **Trigger Polarity** softkey of the IQ Capture Settings dialog box.

Trigger Offset

For details refer to the **Trigger Offset** softkey in the trigger menu of the base unit.

Softkeys of the trace menu (1xEV-DO BTS Analyzer mode)

The following table shows all softkeys available in the trace menu in **1xEV-DO BTS Analyzer** mode. It is possible that your instrument configuration does not provide all softkeys. If a softkey is only available with a special option, model or measurement mode, this information is delivered in the corresponding softkey description.

Command	
Trace Mode	
Screen Focus A/B	
Screen Size Full/Split	
Scaling	Auto Scale Once
	y-Axis Maximum
	y-Axis Minimum
Sweep Count	

Trace Mode

Opens a dialog box, in which the trace mode can be selected. For details on the various trace modes refer to the [Trace mode overview](#) on page 4.36.

Note that the **Blank** trace mode is not available for the code domain measurements.

→ Remote: `DISP:TRAC:MODE AVER`

Screen Focus A/B

For details refer to the **Screen Focus A/B** softkey in the Code Domain Analyzer root menu (main menu).

Screen Size Full/Split

For details refer to the **Screen Size Split/Full** softkey in the Code Domain Analyzer root menu (main menu).

Scaling

For details refer to the **Scaling** softkey in the amplitude menu.

Auto Scale Once

For details refer to the **Auto Scale Once** softkey in the amplitude menu.

y-Axis Maximum

For details refer to the **y-Axis Maximum** softkey in the amplitude menu.

y-Axis Minimum

For details refer to the **y-Axis Minimum** softkey in the amplitude menu.

Sweep Count

For details refer to the **Sweep Count** softkey in the sweep menu of the base unit.

Softkeys of the marker menu (1xEV-DO BTS Analyzer mode)

The following table shows all softkeys available in the marker menu in **1xEV-DO BTS Analyzer** mode. It is possible that your instrument configuration does not provide all softkeys. If a softkey is only available with a special option, model or measurement mode, this information is delivered in the corresponding softkey description.

Command
Marker 1
Marker 2
Marker 3
Marker 4
Marker Norm/Delta
All Marker Off
Percent Marker

Marker 1/Marker 2/Marker 3/Marker 4/Marker Norm/Delta

The **Marker <no>** softkey activates the corresponding marker and opens an edit dialog box to enter a value for the marker to be set to. Pressing the softkey again deactivates the selected marker. If two screens are active in the Code Domain Analyzer, each of the screens has its own set of markers.

Marker 1 is always the reference marker for relative measurements. If activated, markers 2 to 4 are delta markers that refer to marker 1. These markers can be converted into markers with absolute value display by means of the **Marker Norm/Delta** softkey. If marker 1 is the active marker, pressing the **Marker Norm/Delta** softkey switches on an additional delta marker.

For the Channel Bitstream measurement only one marker (Marker 1) is available. It can be used for scrolling and to display the number and value of a bit.

- Remote: CALC:MARK ON
 - Remote: CALC:MARK:X <value>
 - Remote: CALC:MARK:Y?
 - Remote: CALC:DELT ON
 - Remote: CALC:DELT:X <value>
 - Remote: CALC:DELT:X:REL?
 - Remote: CALC:DELT:Y?
-

All Marker Off

For details refer to the **All Marker Off** softkey in the marker menu of the base unit.

Percent Marker

"Opens an edit dialog box to enter a probability value and to position marker 1. Thus, the power which is exceeded with a given probability can be determined very easily. If marker 1 is deactivated, it will be switched on automatically.

This softkey is only available for the CCDF measurement.

- Remote: CALC:MARK:Y:PERC 0...100%
-

Softkeys of the marker-> menu (1xEV-DO BTS Analyzer mode)

The following table shows all softkeys available in the marker-> menu in **1xEV-DO BTS Analyzer** mode. It is possible that your instrument configuration does not provide all softkeys. If a softkey is only available with a special option, model or measurement mode, this information is delivered in the corresponding softkey description.

The softkeys of the marker-> menu are not available for the Result Summary, Channel Table and CCDF measurements.

Command
Select 1 2 3 4 ↵
Peak
Next Peak
Next Peak Mode < abs>
Min

Next Min
Next Min Mode < abs>

Select 1 2 3 4 Δ

Selects the normal marker or the delta markers, activates the marker and opens an edit dialog box to enter a value for the marker to be set to. Δ stands for delta marker 1.

Since the Channel Bitstream measurements supports only one marker, this softkey is not available for that measurement.

- Remote: CALC:MARK1 ON
 - Remote: CALC:MARK1:X <value>
 - Remote: CALC:MARK1:Y?
-

Peak

For details refer to the **Peak** softkey in the MKR-> menu of the base unit.

Next Peak

For details refer to the **Next Peak** softkey in the MKR-> menu of the base unit.

Next Peak Mode < abs>

For details refer to the **Next Peak Mode < abs >** softkey in the MKR-> menu of the base unit.

Min

For details refer to the **Min** softkey in the MKR-> menu of the base unit.

Next Min

For details refer to the **Next Min** softkey in the MKR-> menu of the base unit.

Next Min Mode < abs>

For details refer to the **Next Min Mode < abs >** softkey in the MKR-> menu of the base unit.

Softkeys of the measurement menu (1xEV-DO BTS Analyzer mode)

The following table shows all softkeys available in the measurement menu in **1xEV-DO BTS Analyzer** mode. It is possible that your instrument configuration does not provide all softkeys. If a softkey is only available with a special option, model or (measurement) mode, this information is delivered in the corresponding softkey description.

Menu / Command	Submenu / Command
Code Domain Analyzer ↓	
Power	
Adjacent Channel Power ↓	Bandclass
	ACP Config ↓
	Sweep Time
	Fast ACP On/Off
	ACP Abs/Rel
	Adjust Ref Level
Spectrum Emission Mask ↓	Edit Sweep List
	List Evaluation
	Edit Reference Range
	Edit Power Classes
	Bandclass
	XML Import
	XML Export
	Meas Start/Stop
	Restore Default Files
Occupied Bandwidth ↓	% Power Bandwidth
	Channel Bandwidth
	Adjust Ref Level
	Adjust Settings
CCDF ↓	Percent Marker
	Res BW
	# of Samples
	Scaling
	Adjust Settings

Code Domain Analyzer

Activates the Code Domain Analyzer and opens the Code Domain Analyzer menu. Select the desired result display via this menu. For details refer to [Softkeys of the Code Domain Analyzer Menu \(1xEV-DO BTS Analyzer mode\)](#).

For details on the measurements in the code domain, initial configuration and screen layout refer to the description of the [Code Domain Analysis](#).

→ Remote: CONF:CDP:MEAS CDP

Power

Activates the Signal Channel Power measurement, in which the power of a single channel is determined.

For details on screen layout and default values see the description of the [Signal Channel Power](#).

- Remote: CONF:CDP:MEAS POW
- Remote: CALC:MARK:FUNC:POW:RES? CPOW (result query)

Adjacent Channel Power

Activates the Adjacent Channel Power measurement.

In this measurement the power of the carrier and its adjacent and alternate channels is determined. For details on screen layout and default values see the description of the [Adjacent Channel Power](#).

Also opens the Adjacent Channel Power submenu containing the following softkeys:

Command
Bandclass
ACP Config ↓
Sweep Time
Fast ACP On/Off
ACP Abs/Rel
Adjust Ref Level

- Remote: CONF:CDP:MEAS ACLR
- Remote: CALC:MARK:FUNC:POW:RES? ACP (result query)

Bandclass

softkey:Band Class (K84)"Opens a dialog box to select the bandclass. The following bandclasses are available:

Band Class 0	800 MHz Cellular Band
Band Class 1	1.9 GHz PCS Band
Band Class 2	TACS Band
Band Class 3	JTACS Band
Band Class 4	Korean PCS Band
Band Class 5	450 MHz NMT Band
Band Class 6	2 GHz IMT-2000 Band
Band Class 7	700 MHz Band
Band Class 8	1800 MHz Band
Band Class 9	900 MHz Band
Band Class 10	Secondary 800 MHz
Band Class 11	400 MHz European PAMR Band
Band Class 12	800 MHz PAMR Band
Band Class 13	2.5 GHz IMT-2000 Extension Band

Band Class 14	US PCS 1.9 GHz Band
Band Class 15	AWS Band
Band Class 16	US 2.5 GHz Band
Band Class 17	US 2.5 GHz Forward Link Only Band

→ Remote: CONF:CDP:BCL <value>

ACP Config

For details on the softkey and submenus refer to the **CP / ACP Config** softkey in the Adjacent Channel Power submenu of the base unit.

Sweep Time

For details refer to the **Sweep Time** softkey in the Adjacent Channel Power submenu of the base unit.

Fast ACP On/Off

For details refer to the **Fast ACP On/Off** softkey in the Adjacent Channel Power submenu of the base unit.

ACP Abs/Rel

For details refer to the **ACP Abs/Rel** softkey in the Adjacent Channel Power submenu of the base unit.

Adjust Ref Level

For details refer to the **Adjust Ref Level** softkey in the Code Domain Analyzer menu.

Spectrum Emission Mask

Performs a comparison of the signal power in different carrier offset ranges with the maximum values specified in the 1xEV-DO specification. With the exception of a few softkeys this measurement is identical to the Spectrum Emission Mask measurement of the base unit.

For details on screen layout and default values see the description of the [Spectrum Emission Mask](#).

Also opens the Spectrum Emission Mask submenu containing the following softkeys:

Edit Sweep List
List Evaluation
Edit Reference Range
Edit Power Classes
Bandclass
XML Import

XML Export
Meas Start/Stop
Restore Default Files

→ Remote: CONF:CDP:MEAS ESP

→ Remote: CALC:LIM:FAIL?

Edit Sweep List

For details on the Edit Sweep List softkey and its submenu refer to the **Edit Sweep List** softkey in the Spectrum Emission Mask submenu of the base unit.

List Evaluation

For details on the List Evaluation softkey and its submenu refer to the **List Evaluation** softkey in the Spectrum Emission Mask submenu of the base unit.

Edit Reference Range

Opens the Reference Range dialog box. For details refer to the **Edit Reference Range** softkey in the Spectrum Emission Mask submenu of the base unit.

Edit Power Classes

Opens the Power Classes dialog box. For details refer to the **Edit Power Classes** softkey in the Spectrum Emission Mask submenu of the base unit.

Bandclass

Opens a dialog box, to select a specific bandclass.

A list of the supported bandclasses can be found in the description of the **Bandclass** softkey in the ACP measurement menu.

The settings for each bandclass are provided in *.xml files that are located in the directory C:\R_S\INSTR\sem_std\EVDO\dl. The files themselves are named C2K_DL_BC01.XML (bandclass 1) to C2K_DL_BC17.XML (bandclass 17). By selecting one of the bandclasses from the dialog box, the correct file will be loaded automatically. The file can also be loaded manually (see **XML Import** softkey).

→ Remote: CONF:CDP:BCL <value>

XML Import

Opens the **XML Import** dialog box, in which the *.xml file to be imported can be selected. If a file is imported, the SEM settings specified in the file will be used. All previous SEM settings will be lost.

→ Remote: ESP:PRES "<file name>"

XML Export

Opens the **XML Export** dialog box, in which the currently used SEM settings and parameters can be saved and exported into an *.xml file. Enter the name of the file in the file name field.

It is also possible to save the settings under one of the default bandclass file names (see **Bandclass** softkey). When overwriting one of the default files, the customized settings will be linked to the corresponding bandclass while the default settings are lost.

To restore the default bandclass settings press the **Restore Default Files** softkey.

→ Remote: ESP:STOR "<file name>"

Meas Start/Stop

For details on the **Meas Start/Stop** softkey refer to the **Meas Start/Stop** softkey in the Spectrum Emission Mask submenu of the base unit.

Restore Default Files

"softkey:Restore FSL K84 Files (K84)"Restores all default files of the K84 option into the C:\R_S\INSTR\sem_std\1EVDO\dl directory. If changes have been applied to the files, these will be lost.

→ Remote: ESP:PRES:REST

Occupied Bandwidth

Activates measurement of the bandwidth assigned to the signal.

For details on screen layout and default values see the description of the [Occupied Bandwidth](#).

Also opens the Occupied Bandwidth submenu containing the following softkeys:

% Power Bandwidth
Channel Bandwidth
Adjust Ref Level
Adjust Settings

→ Remote: CONF:CDP:MEAS OBAN

→ Remote: CALC:MARK:FUNC:POW:RES? OBAN (result query)

% Power Bandwidth

For details refer to the **% Power Bandwidth** softkey in the OBW submenu of the base unit.

Channel Bandwidth

For details refer to the **Channel Bandwidth** softkey in the ACP Config submenu of the base unit.

Adjust Ref Level

For details refer to the **Adjust Ref Level** softkey in the Code Domain Analyzer menu.

Adjust Settings

Automatically optimizes all instrument settings for the selected channel configuration (channel bandwidth, channel spacing) within a specific frequency range (channel bandwidth). The adjustment is carried out only once. If necessary, the instrument settings can be changed later.

→ Remote: POW:ACH:PRES OBW

CCDF

Starts the measurement of the Complementary Cumulative Distribution Function and the Crest factor.

For details on screen layout and default values see the description of the [Complementary Cumulative Distribution Function \(CCDF\)](#).

Also opens the CCDF submenu containing the following softkeys:

Percent Marker
Res BW
of Samples
Scaling
Adjust Settings
Percent Marker

→ Remote: CONF:CDP:MEAS CCDF

Percent Marker

For details refer to the **Percent Marker** softkey in the CCDF submenu of the base unit.

Res BW

For details refer to the **Res BW** softkey in the CCDF submenu of the base unit.

of Samples

For details refer to the **# of Samples** softkey in the CCDF submenu of the base unit.

Scaling

For details refer to the **Scaling** softkey and the corresponding submenu in the CCDF submenu of the base unit.

Adjust Settings

Automatically optimizes all instrument settings for the selected channel configuration (channel bandwidth, channel spacing) within a specific frequency range (channel bandwidth). The adjustment is carried out only once. If necessary, the instrument settings can be changed later.

→ Remote: CALC:STAT:SCAL:AUTO ONCE

Power vs Time

Starts the measurement of the Power vs Time. This measurement is required by the standard for the Emission Envelope Mask.

For details on screen layout and default values see the description of the [Power vs Time](#).

Also opens the PvT submenu containing the following softkeys:

Command
No of HalfSlots
RF:Slot Full Idle
Burst Fit On Off
Reference Mean Pwr
Reference Manual
Set Mean To Manual
Restart On Fail
Restore STD Lines

→ Remote: CONF:CDP:MEAS PVT

No of HalfSlots

Change the number of halfslots used for averaging. The default value is 100.

→ Remote: SWE:COUN <numeric value>

RF:Slot Full Idle

Defines the expected signal. Set it to either FULL or IDLE mode. The limit lines and the borders for calculating the mean power are set. The lower and upper limit line are called DOPVTFL/ DOPVTFU for FULL and DOPVTIL/ DOPVTIU for IDLE mode. It is possible to change these lines with the standard limit line editor.

→ Remote: CONF:CDP:RFS FULL

Burst Fit On Off

Activate an automatic burst alignment to the center of the diagram. If active the burst fit algorithm searches the maximum and minimum gradient, between them the maximum peak is determined, and from this point the 7 dB down points are searched. If these are within plausible ranges the burst is centered in the screen, otherwise nothing will happen. The default setting is OFF.

The softkey is only available if the RF:Slot is set to idle mode (see **RF:Slot Full Idle**).

→ Remote: CONF:CDP:PVT:BURS ON

Reference Mean Pwr

The standard asks for the sequence to first measure the FULL slot with the limit line relative to the mean power of the averaged time response. Therefore you should activate the Reference Mean Power for Full slot measurements.

In this mode the mean power is calculated and the limit lines are relative to that mean power. This value should be used also as the reference for the IDLE slot measurement.

→ Remote: CALC:LIM:PVT:REF AUTO

Reference Manual

Select the reference value for the limits manually (also see Reference Mean Pwr and Set Mean To Manual).

→ Remote: CALC:LIM:PVT:REF MANUAL

→ Remote: CALC:LIM:PVT:RVAL <numeric value>

Set Mean To Manual

Pressing the softkey leads to the usage of the current mean power value of the averaged time response as the fixed reference value for the limit lines. The mode is switched to Reference Manual. Now the IDLE slot can be selected and the measurement sequence can be finished. (also see **Reference Mean Pwr** and **Reference Manual**).

→ Remote: CALC:LIM:PVT:REF ONCE

Restart On Fail

Evaluates the limit line over all results at the end of a single sweep. The sweep restarts if the result is FAIL. On a PASS or MARGIN result, the sweep ends.

This softkey is only available in single sweep mode.

→ Remote: CONF:CDP:PVT:FRES ON

Restore STD Lines

Restores the limit lines defined in the standard to the state they were in when the device was supplied. In this way unintended overwriting of the standard lines can be undone.

→ Remote: CALC:LIM:PVT:REST

WLAN TX Measurements (Option K91 / K91n)

The WLAN TX Measurements option extends the functionality of the R&S FSL spectrum analyzer to enable Wireless LAN TX measurements according to IEEE standards 802.11 a, b, g, j and n.

TX measurement of wireless LAN Device Under Test (DUT) according to the standards specified for the device can be performed:

- Modulation formats:
 - IEEE 802.11a, j, g (OFDM): BPSK, QPSK, 16QAM, 64QAM
 - IEEE 802.11b, g (single carrier): DBPSK, DQPSK, CCK (5.5 & 11 Mbps), PBCC (5.5, 11 & 22 Mbps)
 - IEEE 802.11n (OFDM): BPSK (6.5 & 7.2 Mbps), QPSK (13, 14.4, 19.5 & 21.7 Mbps), 16QAM (26, 28.9, 39 & 43.3 Mbps), 64QAM (52, 57.8, 58.5, 65 & 72.2 Mbps)
- Modulation measurements:
 - Constellation diagram
 - Constellation diagram per OFDM carrier
 - I/Q offset and I/Q imbalance
 - Carrier and symbol frequency errors
 - Modulation error (EVM) per OFDM carrier or symbol
 - Amplitude response and group-delay distortion (spectral flatness)
- Amplitude statistics (CCDF) and crest factor
- Transmit spectrum mask
- FFT, also over a selected part of the signal, e.g. preamble
- Payload bit information
- Capture time selectable up to 15 ms (dependent on selected standard), multiple sweeps possible for large number of bursts (10922).

The option R&S FSL-K91 is available from firmware version 1.20.

The option R&S FSL-K91n is available from firmware version 1.90.

To open the WLAN menu

- If the **WLAN** mode is not the active measurement mode, press the **MODE** key and activate the **WLAN** option.
- If the **WLAN** mode is already active, press the **MENU** or **MEAS** key.
The WLAN menu is displayed. .
- To exit the **WLAN** measurement mode, select another option. For details refer also to section "[Measurement Mode Selection - MODE Key](#)" on page 4.120.

Menu and softkey description

- "Softkeys of the WLAN menu" on page 4.396
- "Softkeys of the sweep menu (WLAN mode)" on page 4.418
- "Softkeys of the marker menu (WLAN mode)" on page 4.419
- "Softkeys of the marker-> menu (WLAN mode)" on page 4.420
- "Softkeys of the lines menu (WLAN mode)" on page 4.421
- "Softkeys of the trace menu (WLAN mode)" on page 4.421

The file, setup, and print menus are provided as described for the base unit. For details refer to the corresponding menu descriptions. The span and bandwidth menus are not available in the **WLAN** mode.

The **FREQ**, **AMPT**, and **TRIG** keys open the **General Settings** or the **Demod Settings** dialog box. For details refer to the **Settings General/Demod** softkey description (WLAN menu).

To display help to a softkey, press the **HELP** key and then the softkey for which you want to display help. To close the help window, press the **ESC** key. For further information refer to section "How to use the Help System".

Further information topics

- "Measurements and result displays" on page 4.392
- "Rise / fall time measurement" on page 4.395
- "Title bar information" on page 4.396
- "Status bar information" on page 4.396

Measurements and result displays

The WLAN option provides two main measurement types:

- IQ measurements (based on captured IQ data)
 - Power vs Time (see **PVT** softkey)
 - EVM vs Symbol, EVM vs Carrier (see **EVM vs Symbol/Carrier** softkey)
 - Phase vs Preamble, Frequency vs Preamble (see **Error Frequency/Phase** softkey)
 - Spectrum Flatness (see **Spectrum Flatness** softkey)
 - Spectrum FFT (see **Spectrum FFT** softkey)
 - Constellation vs Symbol, Constellation vs Carrier (see **Constell vs Symbol/Carrier** softkey)
 - Conditional Cumulative Distribution Function (see **CCDF** softkey)
 - Bit Stream (see **Bitstream** softkey)
 - Signal Field (see **Signal Field** softkey)
- frequency sweep measurements
 - Spectrum mask (see **Spectrum Mask** or **Spectrum IEEE/ETSI** softkeys)
 - Spectrum ACP/ACPR (see **Spectrum ACPR** or **ACP Rel/Abs** softkey)

The measurement result display is divided into two panes:

- [Measurement settings](#)
- Result displays

The results can be displayed in form of a list or a graph (see also **Display List/Graph** softkey).

- "Result summary list" on page 4.393
- "Result display graph" on page 4.394

Measurement settings

The overall measurement settings used to obtain the current measurement results are displayed below the title bar (see Fig. 4-45). The following settings are listed:

Setting	Description	Restrictions
Frequency	The frequency of the measured input signal.	
Preamble Type	The type of preamble of analyzed bursts.	
Ref Level	The reference level used for the input signal.	IEEE 802.11b, g (Single Carrier) only
Modulation	Shows the active setting selected in the Demod Settings dialog box: Demodulator or PSDU Modulation to Analyze .	
External Att	The attenuation (positive values) or gain (negative values) applied to the signal externally (i.e. before the RF or IQ connector of the spectrum analyzer), e.g.: External Att = 10 dB means that before the RF connector of the R&S FSL a 10 dB attenuator is used External Att = -20 dB means that before the RF connector of the R&S FSL a amplifier with 20 dB gain is used	
PSDU Data Length	Shows the minimum and maximum number of data bytes that a burst may have if it is to be considered in results analysis.	IEEE 802.11b, g (Single Carrier) only

IEEE 802.11g		
Frequency: 6 GHz	Ref Level: 7.4 dBm	External Att: 0 dB
Preamble Type: OFDM	Modulation: 54 Mbps 64 QAM	PSDU Len: 1/1366

Fig. 4-45 Measurement settings (example)

Result summary list

The result summary list shows the overall measurement results and provides limit checking for result values in accordance with the selected standard. Result values which are within the limit as specified by the standard are displayed in green. Result values which are outside of the limits specified by the standard are displayed in red with a "*" to the left. Results which have no limits specified by the standard are displayed in white. Limit values are displayed in white (not bold) and can be modified, if focused, via the keypad. To reset the limit values to the values specified in the standard, use the lines menu (**LINES** key).

The results displayed in this list are for the entire measurement. If a specific number of bursts have been requested which requires more than one sweep, the result summary list is updated at the end of each sweep. The number of bursts measured and the number of bursts requested are displayed to show the progress through the measurement. The Min / Mean / Max columns show the minimum, mean or maximum values of the burst results.

IEEE 802.11g						
Frequency:	1 GHz	Ref Level:	11.1 dBm	External Att:	0 dB	
Preamble Type:	OFDM	Modulation:	54 Mbps 64 QAM	PSDU Len:	1/1366	
* Result Summary						
Bursts:	3	Min	Mean	Limit	Max	Limit
EVM All Carr.		0.78	0.83	5.62	0.88	5.62
		-42.14	-41.59	-25.00	-41.12	-25.00
EVM Data Carr.		0.78	0.84	5.62	0.89	5.62
		-42.11	-41.50	-25.00	-41.00	-25.00
EVM Pilot Carr.		0.67	0.72	39.81	0.75	39.81
		-43.44	-42.88	-8.00	-42.45	-8.00
IQ Offset		-47.53	-46.87	-15.00	-46.17	-15.00
Gain Imbalance		-0.16	-0.10		-0.06	
		-0.01	-0.01		-0.01	
Quadrature Err		-0.08	-0.06		-0.05	
Freq. Err		-461.36	-471.38 ± 25000		-480.19 ± 25000	
Symb Clock Err		-0.60	-0.96 ± 25		-1.64 ± 25	
Burst Power		1.30	1.30		1.30	
Crest Factor		8.93	8.93		8.94	

Fig. 4-46 Result summary list (example)

Result display graph

Additionally to the selected graphical result display, the Magnitude Capture Buffer display is provided for all IQ measurements. The different result displays are described with the corresponding softkey.

The Magnitude Capture Buffer display shows the complete range of captured data for the last sweep. All analyzed bursts are identified with a green bar at the bottom of the Magnitude Capture Buffer display. If, in the **Demod Settings** dialog box, the **Signal Field Content** option is activated only bursts that match the required criteria are marked with a green bar.

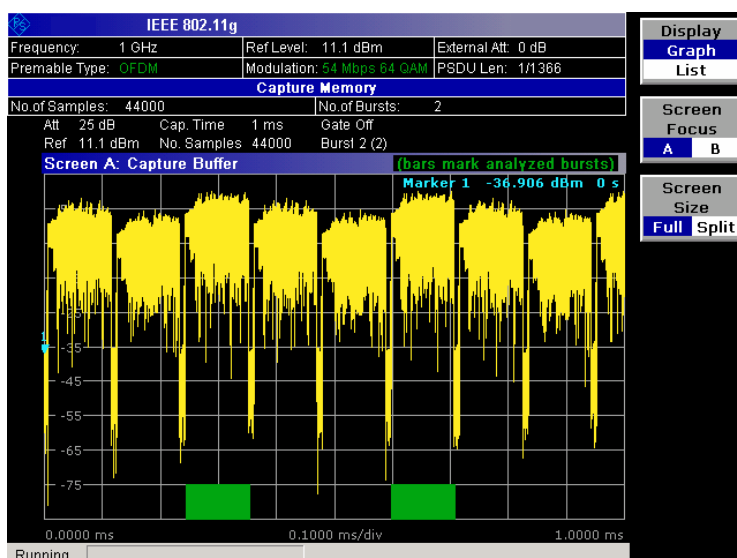

Fig. 4-47 Magnitude capture buffer results (example)

- IQ measurements

All IQ measurements process the same signal data and as such all IQ measurement results are available after a single IQ measurement execution.

IQ measurements can be run in split screen mode (allowing both the Magnitude Capture Buffer display and the selected IQ measurement results to be displayed simultaneously) or in full screen mode (with either the Magnitude Capture Buffer display or the selected IQ measurement results displayed).

- frequency sweep measurements

The frequency sweep measurements use different signal data to IQ measurements and as such it is not possible to run an IQ measurement and then view the results in the frequency sweep measurements and vice-versa. Also because each of the frequency sweep measurements uses different settings to obtain signal data it is not possible to run a frequency sweep measurement and view the results of another frequency sweep measurement.

All frequency sweep measurements are run in full screen mode.

Further information

This section provides background information on measurements and displayed information. For details on signal processing refer to chapter "Advanced Measurement Examples", section "Measurement Examples of the WLAN TX Measurements Option (K91/K91n)".

Rise / fall time measurement

The rise/fall time is calculated according to the following algorithm:

- Apply a moving average filter over the burst power (adjustable average length)
- If **Ref Pow Max** is set: Search maximum power P_{\max} over the whole burst. Set $P_{\text{ref}}=P_{\max}$
- If **Ref Pow Mean** is set: Calculate mean power P_{mean} of the whole burst. Set $P_{\text{ref}}=P_{\text{mean}}$
- Rise time
 - Search the first crossing of $0.5 \times P_{\text{ref}}$ from the left.
 - Search backwards for the 10% crossing $0.1 \times P_{\text{ref}}$ and note t_{10} .
 - Search forward for the 90% crossing $0.9 \times P_{\text{ref}}$ and note t_{90} .
 - Return $T_{\text{rise}}=t_{90}-t_{10}$.
- Fall time
 - Search the first crossing of $0.5 \times P_{\text{ref}}$ from the right.
 - search forwards for the 10% crossing $0.1 \times P_{\text{ref}}$ and note t_{10} .
 - search backwards for the 90% crossing $0.9 \times P_{\text{ref}}$ and note t_{90} .
 - Return $T_{\text{fall}}=t_{10}-t_{90}$.

Since the single carrier modes of 802.11b, g use linear modulation formats like BPSK or QPSK, the transmit signal power varies between symbol sampling times. These power variations are determined by the transmit filter, which is not defined in the standard. The R&S FSL-K91/K91n allows fine tuning of the PVT measurements on signals with high crest factors by an adjustable moving average filter and two different reference power settings.

The reference power equals the 100% setting for the rise / fall time calculation. Either the maximum burst power or the mean burst power can be chosen as reference power. Using the mean burst power, rarely power peaks within the burst does not influence the rise / fall time measurement.

The moving average filter smoothes the power trace and thus eliminates the modulation. While a long average length leads to more stable measurement results, it naturally increases the rise / fall times compared to no averaging.

Title bar information

The title bar displays the following information:

- wireless LAN standard applicable to the current measurement (in the middle)

Status bar information

The status bar displays the following information:

- parameter values
 If a parameter in a settings dialog box is selected, the minimum and maximum values for the selected parameter are displayed.
 If a Boolean parameter in a dialog box is selected, the minimum and maximum values are displayed as N/A for not applicable.
- measurement status
 During the measurement, the current measurement status along with detailed information about the progress is displayed.
- error messages (with red background)
- warning messages (with yellow background)

Softkeys of the WLAN menu

The following table shows all softkeys available in the WLAN menu. It is possible that your instrument configuration does not provide all softkeys. If a softkey is only available with a special option, model or (measurement) mode, this information is delivered in the corresponding softkey description.

Menu / Command	Command
Settings General/Demod	
Display List/Graph	
PVT ↓	Settings General/Demod
	Display List/Graph
	Full Burst
	Rising & Falling
	Ramp Up/Down/Up & Down
	Ref Pow Max/Mean
	Average Length
	More ↓
	Gating Settings On/Off
	Import
	Export
	R&S Support
EVM Constell ↓	Settings General/Demod
	Display List/Graph
	EVM vs Symbol/Carrier
	Error Frequency/Phase

Menu / Command	Command
	Constell vs Symbol/Carrier
	Carrier Selection
	More ↓
	Gating Settings On/Off
	Import
	Export
	Y-Axis/Div
	R&S Support
Spectrum ↓	Settings General/Demod
	Display List/Graph
	Spectrum Flatness
	Spectrum Mask / Spectrum IEEE/ETSI
	Spectrum FFT
	Spectrum ACPR / Spectrum ACP / ACP Rel/Abs
	More ↓
	same contents as PVT side menu
Statistics ↓	Settings General/Demod
	Display List/Graph
	CCDF
	Bitstream
	Signal Field / PLCP Header
	More ↓
	same contents as PVT side menu

Settings General/Demod

Opens the **General Settings** or the **Demod Settings** dialog box. Screenshots of the dialog boxes are provided in chapter "Advanced Measurement Examples", section "Measurement Examples of the WLAN TX Measurements Option (K91/K91n)".

Alternatively, the **General Settings** dialog box is opened as follows:

- **FREQ** key, with focus on the **Frequency** field
- **AMPT** key, with focus on the **Signal Level (RF)** field
- **TRIG** key, with focus on the **Trigger Mode** field

In the **General Settings** dialog box, all settings related to the overall measurement can be modified. The right pane with the advanced settings is only displayed if the **Advanced Settings** option is activated. The **General Settings** dialog box contains the following elements:

Signal Characteristics	Standard
	Frequency
	Channel No
Level Settings	Signal Level

	Auto Lvl
	Ext Att
Data Capture Settings	Capture Time
	Burst Count
	Analyze Bursts
	Sweep Count
Trigger Settings	Trigger Mode
	Trigger Offset
	Power Level
	Auto Lvl
IQ Settings	Swap IQ
Advanced Settings	Auto Level Time
	Ref Level
	Attenuation
	Sample Rate

In the **Demod Settings** dialog box, the settings associated with the signal modulation can be modified. The settings under **Burst to Analyze** specify the characteristics of the bursts to be considered in the measurement results. Only the bursts which meet the criteria specified in this group will be included in measurement analysis if the **Use Header Content** option is activated. The tracking settings allow various errors in measurement results to be compensated for.

The **Demod Settings** dialog box contains the following elements. If an element is only available for certain standards, the corresponding standards are listed.

Burst to Analyze	Signal Field Content
	Use Header Content
	Burst Type
	Preamble Type
	Auto Demodulation
	Analyze PSDU Mod
	Demodulator
	Auto Guard
	Guard Interval
	PPDU Frame Format
	Equal Burst Length
	Data Symbols
	Min Data Symbols
	Max Data Symbols
	Channel Estimation
	Payload Length
	Min Payload Length
	Max Payload Length
Tracking	Phase
	Timing
	Level

Standard (General Settings dialog box)

Displays a list of all installed standards to select the wireless LAN standard. This is necessary to ensure that the measurements are performed according to the specified standard with the correct limit values and limit lines.

→ Remote: CONF:STAN 0

Frequency (General Settings dialog box)

Specifies the center frequency of the signal to be measured. If the frequency is modified, the **Channel No** field is updated accordingly.

→ Remote: FREQ:CENT 100MHz

Channel No (General Settings dialog box)

Specifies the channel to be measured. If the **Channel No** field is modified, the frequency is updated accordingly.

→ Remote: CONF:CHAN 9

Signal Level (General Settings dialog box)

Specifies the expected mean level of the RF input signal. If an automatic level detection measurement has been executed the signal level (RF) is updated.

For all standards other than IEEE 802.11b & g (Single Carrier), the reference level is set 10 dB higher than the signal level (RF) because of the expected crest factor of the signal. For standards IEEE 802.11b & g (Single Carrier), the reference level is set to the signal level (RF).

→ Remote: CONF:POW:EXP:RF 9

Auto Lvl (General Settings dialog box)

Activates or deactivates the automatic setting of the reference level for measurements.

On The reference level is measured automatically at the start of each measurement sweep. This ensures that the reference level is always set at the optimal level for obtaining accurate results but will result in slightly increased measurement times. For details about automatic level detection refer to chapter "Advanced Measurement Examples".

Off The reference level is defined manually in the **Signal Level** field.

→ Remote: CONF:POW:AUTO 1

→ Remote: CONF:POW:AUTO:SWE:TIME 200MS

Ext Att (General Settings dialog box)

Specifies the external attenuation or gain applied to the RF signal. A positive value indicates attenuation, a negative value indicates gain. All displayed power level values are shifted by this value.

→ Remote: INP:ATT 30dB

Capture Time (General Settings dialog box)

Specifies the time (and therefore the amount of data) to be captured in a single measurement sweep.

→ Remote: `SWE:TIME 10ms`

Burst Count (General Settings dialog box)

Activates or deactivates a specified number of bursts for capture and analysis.

On The data analysis is performed over a number of consecutive sweeps until the required number of bursts has been captured and analyzed.

Off The data analysis is performed on a single measurement sweep.

→ Remote: `BURS:COUN:STAT ON`

Analyze Bursts (General Settings dialog box)

Specifies the number of bursts to be measured, if the **Burst Count** option is activated.

→ Remote: `BURS:COUN 16`

Sweep Count (General Settings dialog box)

Specifies the number of sweeps to be performed for Spectrum ACP/ACPR and Spectrum Mask measurements.

→ Remote: `SWEep:COUNT 64`

Trigger Mode (General Settings dialog box)

Sets the source of the trigger for the measurement sweep.

Free Run The measurement sweep starts immediately.

External Triggering via a TTL signal at the input connector EXT TRIGGER/GATE IN on the rear panel.

Power The measurement sweep starts when the signal power meets or exceeds the specified power trigger level. This trigger mode is not available for Spectrum Mask measurements in ETSI standard. If it is set and then the Spectrum Mask measurement in ETSI standard is selected, it automatically changes to **Free Run**.

→ Remote: `TRIG:MODE IMM`

Trigger Offset (General Settings dialog box)

Specifies the time offset between the trigger signal and the start of the sweep. A negative value indicates a pre-trigger. This field is not available in the **Free Run** trigger mode.

→ Remote: `TRIG:HOLD 500us`

Power Level (General Settings dialog box)

Specifies the trigger level if the **Power** trigger mode is set.

→ Remote: TRIG:LEV:POW 10 DBM

Auto Lvl (General Settings dialog box)

Activates or deactivates the automatic measurement of the power trigger level.

On The power trigger level is measured automatically at the start of each measurement sweep. This ensures that the power trigger level is always set at the optimal level for obtaining accurate results but will result in a slightly increased measurement times.

Off The power trigger level is defined manually in the **Power Level** field.

→ Remote: TRIG:LEV:POW:AUTO ON

Swap IQ (General Settings dialog box)

Activates or deactivates the inverted I/Q modulation.

On I and Q signals are interchanged.

Off Normal I/Q modulation.

→ Remote: SWAP ON

Auto Level Time (General Settings dialog box)

Specifies the sweep time used for the automatic level measurements.

→ Remote: CONF:POW:AUTO:SWE:TIME 200MS

Ref Level (General Settings dialog box)

Specifies the reference level to use for measurements. If the reference level is modified, the signal level is updated accordingly (depending on the currently selected standard and measurement type). This field is only editable if the **Auto Lvl** is deactivated.

→ Remote: DISP:TRAC:Y:RLEV?

Attenuation (General Settings dialog box)

Specifies the settings for the attenuator. This field is only editable if the **Auto Lvl** option is deactivated. If the **Auto Lvl** option is activated, the RF attenuator setting is coupled to the reference level setting.

→ Remote: INP:ATT 30dB

Sample Rate (General Settings dialog box)

Specifies the sample rate used for IQ measurements.

→ Remote: TRACE:IQ:SRAT 20000

Signal Field Content (Demod Settings dialog box, IEEE 802.11a, g (OFDM), j and n)

Activates or deactivates the decoding of the captured burst data.

- On Only the bursts are included in the results analysis whose modulation format specified in the signal symbol field matches the modulation format specified in the **Analyze PSDU Mod** field.
- Off The data is demodulated according to the modulation scheme specified in the **Demodulator** field. If any of the analyzed data has a modulation different to that specified the results will be of limited use.

→ Remote: DEM:FORM:SIGS ON

Use Header Content (Demod Settings dialog box, IEEE 802.11b, g - Single Carrier)

Activates or deactivates the PLCP header field decoding of the captured burst data.

- On Only the bursts are included in the results analysis whose modulation format specified in the signal symbol field matches the modulation format specified in the **Analyze PSDU Mod** field.
- Off The data is demodulated according to the modulation scheme specified in the **Demodulator** field. If any of the analyzed data has a modulation different to that specified the results will be of limited use.

→ Remote: DEM:FORM:AUT ON

Burst Type (Demod Settings dialog box, IEEE 802.11a, g (OFDM, Single Carrier), j and n)

Specifies the type of burst to be included in measurement analysis. Only one burst type can be selected for the measurement results. The following burst types are supported:

Direct Link Burst	IEEE 802.11a, j, n
OFDM	IEEE 802.11g
Long DSSS-OFDM	IEEE 802.11g
Short DSSS-OFDM	IEEE 802.11g
Long PLCP	IEEE 802.11g
Short PLCP	IEEE 802.11g

→ Remote: DEM:FORM:BAN:BTYPe 'DIRECT'

Preamble Type (Demod Settings dialog box, IEEE 802.11b)

Specifies the type of burst which should be included in measurement analysis. The following burst types are supported: Short PLCP, Long PLCP.

→ Remote: DEM:FORM:BAN:BTYPe 'SHORT'

Auto Demodulation

Activates or deactivates the automatic detection of the modulation. If activated, the modulation applied to the input data is determined from the modulation type of the first complete burst within the captured data. This option automatically activates the **Signal Field Content** option.

→ Remote: DEM:FORM:AUT ON

Analyze PSDU Mod

Specifies the modulation of the bursts to be analyzed. Only bursts using the selected modulation are considered in measurement analysis. This option is only available if the **Signal Field Content** or the **Use Header Content** option is activated.

→ Remote: DEM:FORM:AUT ON

Demodulator

Specifies the modulation to be applied to the measured data. If the captured data uses a different modulation scheme than specified by this field the results will be of limited use. This field is only available if the **Signal Field Content** or the **Use Header Content** option is deactivated.

→ Remote: DEM:FORM:BAN 'QAM16'

PPDU Frame Format (Demod Settings dialog box, IEEE 802.11n)

PPDU Frame Format specifies the type of PHY Protocol Data Unit (PPDU) which should be included in measurement analysis. The following PPDU formats are supported:

- Mixed 20 MHz
- Green Field 20 MHz

This field is available from firmware version 1.90.

→ Remote: DEM:FORM:BAN:BTYP 'MM20'

Auto Guard (Demod Settings dialog box, IEEE 802.11n)

Specifies whether the Guard interval of the measured data should be automatically detected or not. When Auto Guard Interval is set to ON then the Guard Interval is detected from the input signal .

When Use Auto Guard Interval is set to OFF then guard interval of the input signal can be specified with the Guard Interval parameter.

This field is available from firmware version 1.90.

→ Remote: CONF:WLAN:GTIM:AUTO ON

Guard Interval (Demod Settings dialog box, IEEE 802.11n)

Specifies the guard interval of the input signal.

When Auto Guard Interval is set to ON then Guard Interval is read only and display the detected guard interval.

This field is available from firmware version 1.90.

→ Remote: CONF:WLAN:GTIM SHOR

Equal Burst Length (Demod Settings dialog box)

Activates or deactivates the burst selection for measurement analysis according to the range or specific number of data symbols/bytes.

Standard	State	Description
IEEE 802.11a, j, n	On	Only bursts with exactly the number of symbols specified in the Data Symbols field are considered for measurement analysis.
	Off	Only bursts within the range of data symbols specified by the Min Data Symbols and Max Data Symbols fields are considered for measurement analysis.
IEEE 802.11b, g (Single Carrier)	On	Only bursts with exactly the number of data bytes or duration specified in the Payload Length field are considered for measurement analysis.
	Off	Only bursts within the range of data bytes or duration specified by the Min Payload Length and Max Payload Length fields are considered for measurement analysis.
IEEE 802.11g (OFDM)	On	Only bursts with exactly the number of data symbols or duration specified in the Payload Length field are considered for measurement analysis.
	Off	Only bursts within the range of data symbols or duration specified by the Min Payload Length and Max Payload Length fields are considered for measurement analysis.

→ Remote: DEM:FORM:BAN:SYMB:EQU ON

→ Remote: DEM:FORM:BAN:DBYTES:EQU ON

→ Remote: DEM:BAN:DUR:EQU ON (PVT)

Data Symbols (Demod Settings dialog box, IEEE 802.11a, j, n)

Specifies the number of data symbols of a burst to be considered in measurement analysis. This field is only available if the **Equal Burst Length** option is activated.

→ Remote: DEM:FORM:BAN:SYMB:MIN 16

Min Data Symbols (Demod Settings dialog box, IEEE 802.11a, j, n)

Specifies the minimum number of data symbols of a burst to be considered in measurement analysis. This field is only available if the **Equal Burst Length** option is deactivated.

→ Remote: DEM:FORM:BAN:SYMB:MIN 16

Max Data Symbols (Demod Settings dialog box, IEEE 802.11a, j, n)

Specifies the maximum number of data symbols of a burst to be considered in measurement analysis. This field is only available if the **Equal Burst Length** option is deactivated.

→ Remote: DEM:FORM:BAN:SYMB:MAX 1300

Channel Estimation (Demod Settings dialog box, IEEE 802.11a, g (OFDM), j, n)

Specifies how accurately the EVM results are calculated.

Preamble The channel estimation is performed in the preamble as required in the standard.

Payload The channel estimation is performed in the payload.

→ Remote: DEM:CEST ON

Payload Length (Demod Settings dialog box, IEEE 802.11b, g)

Specifies the number of symbols, bytes or duration of a burst to be considered in measurement analysis. This field is only available if the **Equal Burst Length** option is activated.

→ Remote: DEM:FORM:BAN:DBYTeS:MIN 16

→ Remote: DEM:BAN:DUR:MIN 45

Min Payload Length (Demod Settings dialog box, IEEE 802.11b, g)

Specifies the minimum number of symbols, bytes or duration of a burst to be considered in measurement analysis. This field is only available if the **Equal Burst Length** option is deactivated.

→ Remote: DEM:FORM:BAN:DBYTeS:MIN 16

→ Remote: DEM:BAN:DUR:MIN 45

Max Payload Length (Demod Settings dialog box, IEEE 802.11b, g)

Specifies the maximum number of symbols, bytes or duration of a burst to be considered in measurement analysis. This field is only available if the **Equal Burst Length** option is deactivated.

→ Remote: DEM:FORM:BAN:DBYTeS:MAX 1300

→ Remote: DEM:BAN:DUR:MAX 1300

Phase (Demod Settings dialog box)

Activates or deactivates the compensation for phase error. If activated, the measurement results are compensated for phase error on a per-symbol basis.

→ Remote: TRAC:PHAS 1

Timing (Demod Settings dialog box)

Activates or deactivates the compensation for timing error. If activated, the measurement results are compensated for timing error on a per-symbol basis.

→ Remote: TRAC:TIME ON

Level (Demod Settings dialog box)

Activates or deactivates the compensation for level error. If activated, the measurement results are compensated for level error on a per-symbol basis.

→ Remote: TRAC:LEV ON

Display List/Graph

Configures the result display. The measurement results are displayed either in form of a list of measurement points or as a graphical trace.

→ Remote: DISP:WIND1:TABL ON

→ Remote: for result queries see chapter "Remote Control - Commands", section FETCh Subsystem

PVT

Opens the PVT submenu to select the Power vs Time measurement results.

The PVT result displays show the minimum, average and maximum levels measured over the full range of the measured input data, or over complete bursts displayed within the gating lines if gating is switched on. The results are displayed as a single burst. Using screen B in full screen provides additional power information during this measurement.

For IEEE 802.11b and g (single carrier), the PVT results are displayed as percentage values of the reference power. The reference can be set to either the max or mean power of the burst. For both rising and falling edges two time lines are displayed, which mark the points 10% and 90% of the reference power. The time between these two points is compared against the limits specified for the rising and falling edges.

For further details see also "[Rise / fall time measurement](#)" on page 4.395.

→ Remote: CONF: BURS: PVT

Full Burst (IEEE 802.11a, g, j - OFDM and n)

Displays the PVT results in a single graph with all burst data being displayed.

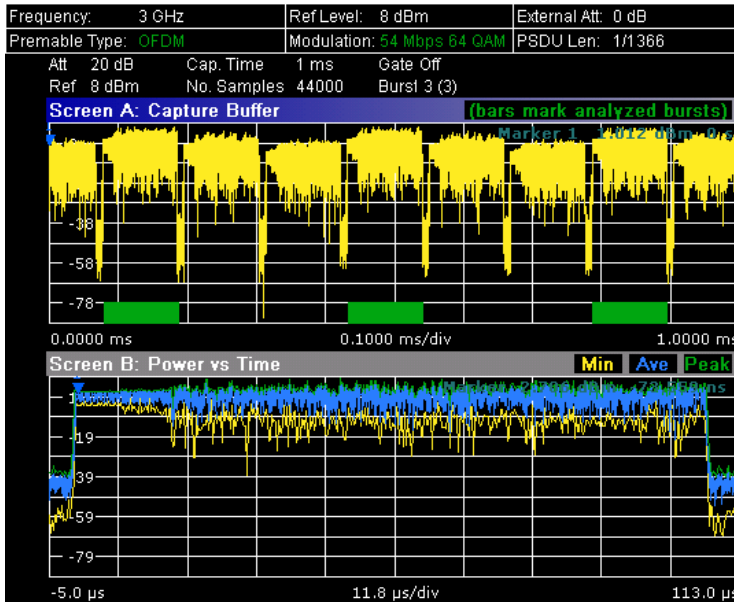

For further details refer to the PVT softkey.

→ Remote: CONF: BURS: PVT: SEL FULL

Rising & Falling (IEEE 802.11a, g, j - OFDM and n)

Displays the PVT results in two separate graphs, the left hand side showing the rising edge and the right hand side showing the falling edge.

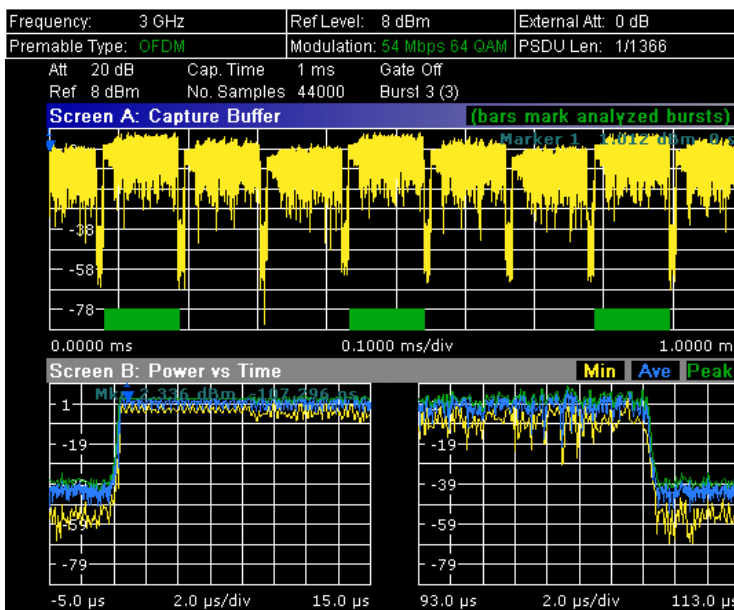

→ Remote: CONF: BURS: PVT: SEL EDGE

Ramp Up/Down/Up & Down (IEEE 802.11b, g - Single Carrier)

Sets the display of the rising/falling edge graph:

- Up** Displays the rising edge graph.
- Down** Displays the falling edge graph.
- Up & Down** Displays the rising and falling edge graph.

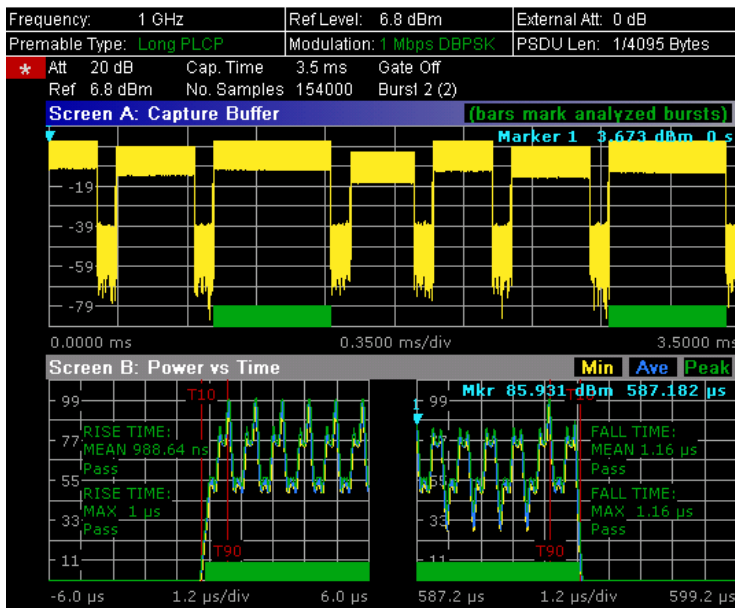

For further details refer to the PVT softkey.

→ Remote: CONF: BURS: PVT: SEL RISE

Ref Pow Max/Mean (IEEE 802.11b, g - Single Carrier)

Sets the reference for the rise and fall time calculation to the maximum or mean burst power.

For further details refer to the PVT softkey.

→ Remote: CONF: BURS: PVT: RPOW MEAN

Average Length (IEEE 802.11b, g - Single Carrier)

Opens an edit dialog box to enter the number of samples in order to adjust the length of the smoothing filter.

For further details refer to the PVT softkey.

→ Remote: CONF: BURS: PVT: AVER 31

Gating Settings On/Off

Activates or deactivates gating, or opens the **Gate Settings** dialog box to specify range of captured data used in results calculation.

- On** Uses only the specified range of captured data in results calculation. In the Magnitude Capture Buffer trace, two vertical lines mark the specified range.
- Off** Uses all the captured data in results calculation.

In the **Gate Settings** dialog box, the following parameters are set:

Delay	Start point of captured data to be used in results calculation, i.e. the delay from the start of the captured data in time or samples. If the delay is specified in time, the number of samples is updated accordingly, and vice versa.
Length	Amount of captured data to be used in results calculation. If the length is specified in time, the number of samples is updated accordingly, and vice versa.
Link Gate and Mark	If activated, the position of the marker and the gate lines are linked. The marker is positioned half way between gate start and end. The marker position alters when the gate is modified, and the gate lines move with the marker when the marker position is altered.

The gate settings are defined for following measurements: PVT, Spectrum FFT, CCDF, Spectrum Mask, Spectrum ACPR.

If a frequency sweep measurement is active (Spectrum Mask and Spectrum ACP) the result display is switched to the Magnitude Capture Buffer display in order to allow the gate to be set the correct part of the sweep.

- Remote: SWE:EGAT ON
- Remote: SWE:EGAT:HOLD 125us, SWE:EGAT:HOLD:SAMP 2500 (Delay)
- Remote: SWE:EGAT:LENG 20ms, SWE:EGAT:LENG:SAMP 200000 (Length)
- Remote: SWE:EGAT:LINK ON (Link Gate and Mark)

Import

Opens the **Choose the file to import** dialog box.

Select the IQ data file you want to import and press **ENTER**. The extension of data files is *.iqw.

- Remote: MMEM:LOAD:IQ:STAT

Export

Opens the **Choose the file to export** dialog box.

Enter the path and the name of the IQ data file you want to export and press **ENTER**. The extension of data files is *.iqw. If the file cannot be created or there is no valid IQ data to export an error message is displayed.

- Remote: MMEM:STOR:IQ:STAT

R&S Support

Creates files that help identifying the current problem. They are stored under C:\R_S\Instr\user\Support. If you contact the Rohde&Schwarz support to get help for a certain problem, send these files to the support in order to identify and solve the problem faster.

Y-Axis/Div

Opens a dialog box to modify the y-axis settings:

- Auto Scaling** If activated, the scaling of the y-axis is calculated automatically.
- Per Division** Specifies the scaling to be used if **Auto Scaling** is deactivated.
- Unit** Specifies the y-axis unit. With the unit is dB, **Auto Scaling** is always activated.

- Remote: DISP:WIND2:TRAC:Y:SCAL:AUTO ON
- Remote: DISP:WIND2:TRAC:Y:SCAL:DPIV 2

EVM Constell

Opens a submenu to select the error vector magnitude (EVM) or the constellation result displays.

EVM vs Symbol/Carrier

Selects the EVM vs Symbol or EVM vs Carrier result displays.

- EVM vs Symbol

This result display shows the EVM measured over the full range of the measured input data. The results are displayed on a per-symbol basis, with blue vertical lines marking the boundaries of each burst. Note that burst boundary lines are only displayed if the number of analyzed bursts is less than 250.

For IEEE 802.11a, j, g, n (OFDM) the minimum, average, and maximum traces are displayed.

For IEEE 802.11b, g (Single Carrier) two EVM traces are displayed. The trace labeled with VEC ERR IEEE shows the error vector magnitude as defined in the IEEE 802.11b, g standards. For the trace labeled with EVM a commonly used EVM definition is applied, which is the square root of the momentary error power normalized by the averaged reference power.

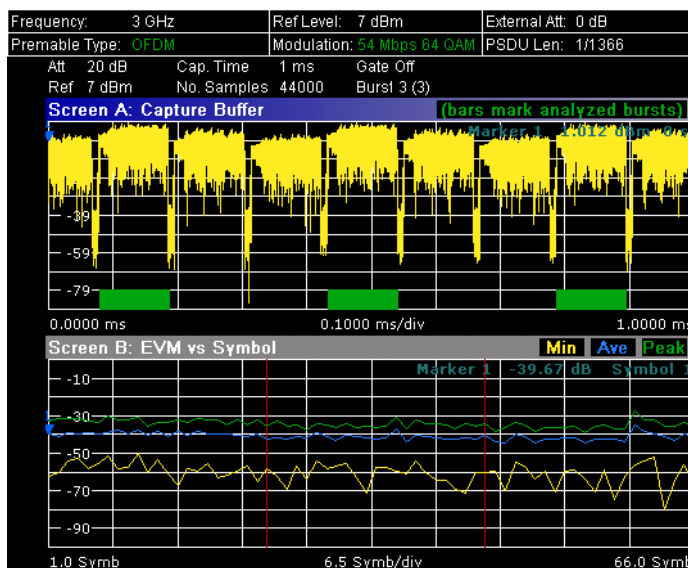

- EVM vs Carrier (IEEE 802.11a, g, j, n - OFDM)

This result display shows all EVM values recorded on a per-carrier basis over the full set of measured data. An average trace is also displayed.

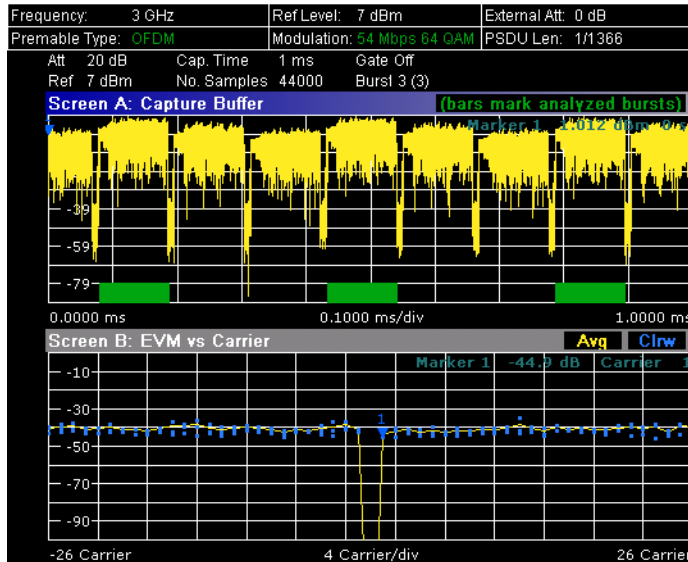

- Remote: CONF : BURS : EVM : ESYM (EVM vs Symbol)
- Remote: CONF : BURS : EVM : ECAR (EVM vs Carrier)

Error Frequency/Phase

Selects the Rel. Frequency Error vs Preamble or the Phase Error vs Preamble result displays.

These result displays show the error values recorded over the preamble part of the burst. A minimum, average and maximum trace are displayed. The results display either relative frequency error or phase error.

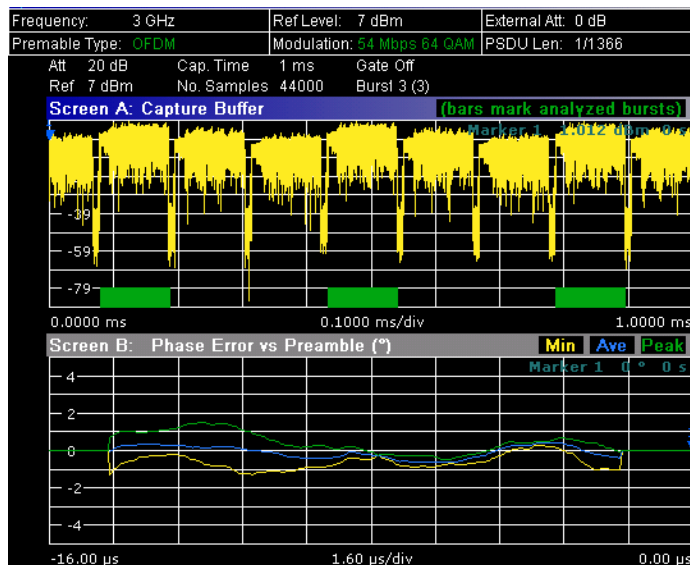

- Remote: CONF : BURS : PRE
- Remote: CONF : BURS : PRE : SEL_FREQ (Frequency Error vs Preamble)
- Remote: CONF : BURS : PRE : SEL_PHAS (Phase Error vs Preamble)

Constell vs Symbol/Carrier

Selects the Constellation vs Symbol or the Constellation vs Carrier result displays.

- Constellation vs Symbol (all standards)

This result display shows the in-phase and quadrature phase results over the full range of the measured input data. The ideal points for the selected modulations scheme are displayed for reference purposes.

The amount of data displayed in the Constellation result display can be reduced by selecting the carrier or carriers for which data is to be displayed (**Carrier Selection** softkey).

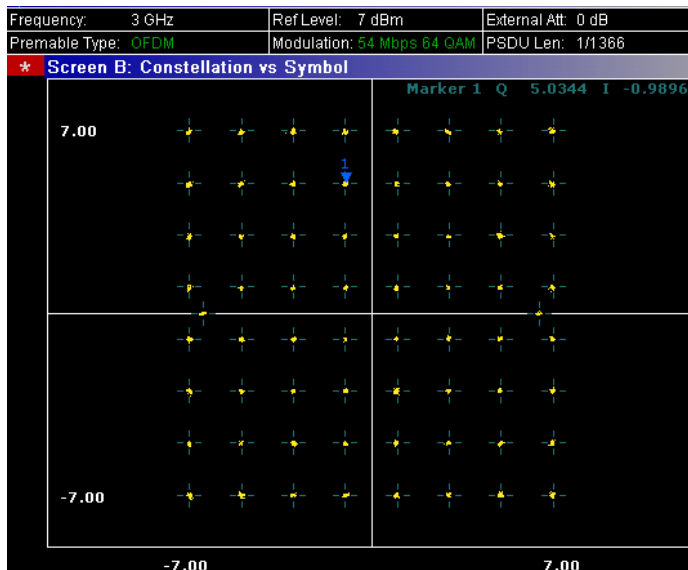

- Constellation vs Carrier (IEEE 802.11a, g, j, n - OFDM)

This result display shows the in-phase and quadrature phase results over the full range of the measured input data plotted on a per-carrier basis. The magnitude of the in-phase and quadrature part is shown on the y-axis, both are displayed as separate traces (I-> trace 1, Q-> trace 2).

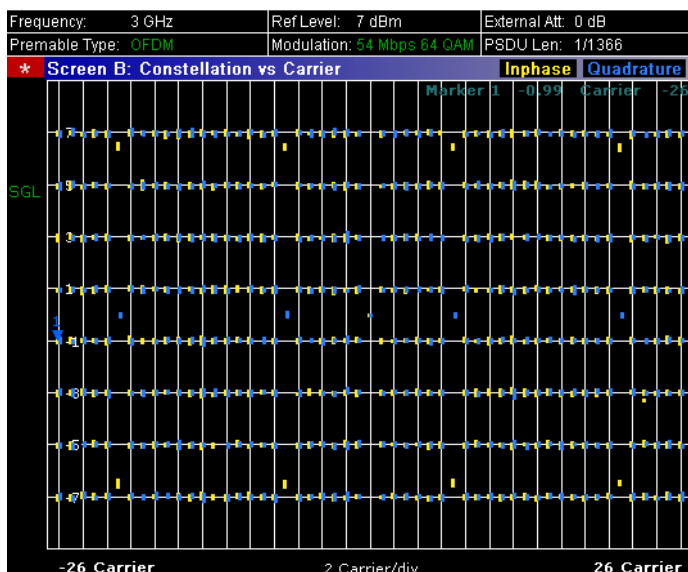

- Remote: CONF : BURS : CONS : CSYM (Constellation vs Symbol)
- Remote: CONF : BURS : CONS : CCAR (Constellation vs Carrier)

Carrier Selection (IEEE 802.11a, g, j, n - OFDM)

Opens a dialog box to select the carrier for data display. Either a specific carrier number, pilots only or all carriers can be selected.

→ Remote: CONF: BURS: CONS: CARR: SEL -26

Spectrum

Opens a submenu for frequency measurements.

Spectrum Flatness (IEEE 802.11a, g, j, n - OFDM)

Sets the Spectrum Flatness result display.

This result display shows the spectrum flatness and group delay values recorded on a per-carrier basis over the full set of measured data. An average trace is also displayed for each of the result types. An upper and lower limit line representing the limits specified for the selected standard are displayed and an overall pass/fail status is displayed for the obtained (average) results against these limit lines.

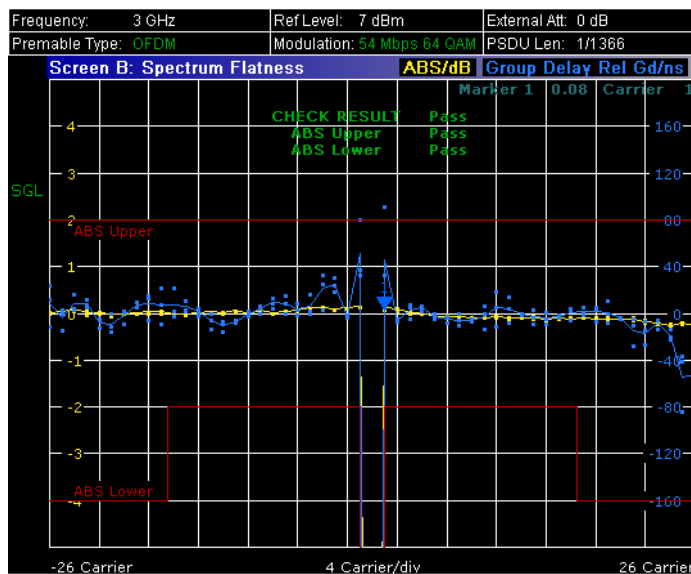

→ Remote: CONF: BURS: SPEC: FLAT

**Spectrum Mask (IEEE 802.11b, g - Single Carrier),
Spectrum IEEE/ETSI (IEEE 802.11a, g, j, n - OFDM)**

Sets the Spectrum Mask result display.

This result display shows power against frequency. The span of the results is 100 MHz for IEEE and 500 MHz for ETSI around the specified measurement frequency. A limit line representing the spectrum mask specified for the selected standard is displayed and an overall pass/fail status is displayed for the obtained results against this limit line.

The number of sweeps is set in the **General Settings** dialog box, **Sweep Count** field. If the measurement is performed over multiple sweeps both a max hold trace and an average trace are displayed.

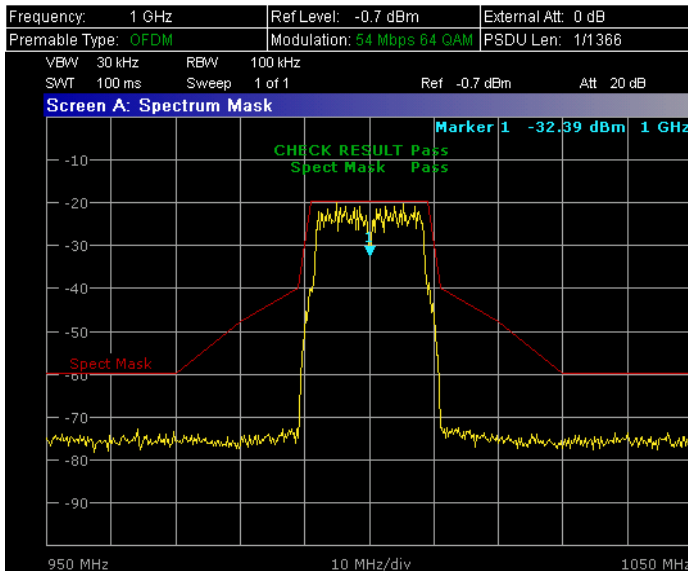

- Remote: CONF : BURS : SPEC : MASK
- Remote: CONF : BURS : SPEC : MASK : SEL ETSI

Spectrum FFT

Sets the Spectrum FFT result display.

This result display shows the Power vs Frequency results obtained from a FFT performed over the range of data in the Magnitude Capture Buffer which lies within the gate lines.

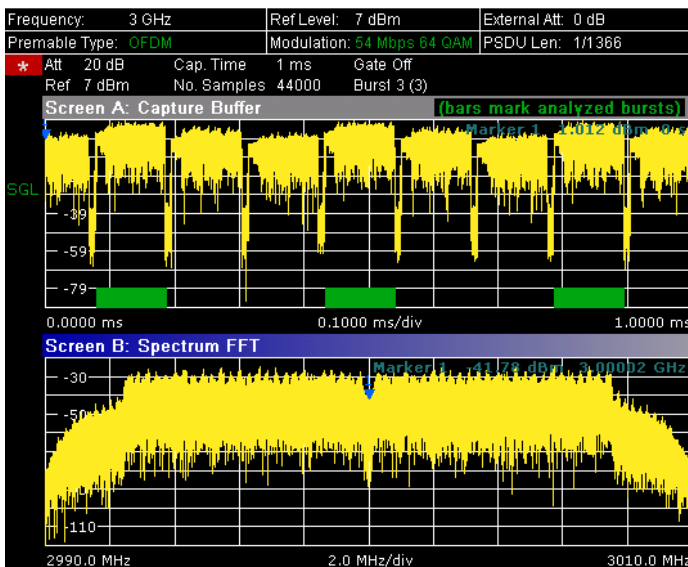

- Remote: CONF : BURS : SPEC : FFT

Spectrum ACPR (IEEE 802.11a, g, n, OFDM Turbo Mode)

Spectrum ACP (IEEE 802.11b)

ACP Rel/Abs (IEEE 802.11j)

Sets the ACP (Adjacent Channel Power) result display.

This result display is similar to the Spectrum Mask measurement, and provides information about leakage into adjacent channels. The results show the absolute or relative power measured in the three nearest channels either side of the measured channel. This measurement is the same as the adjacent channel power measurement provided by the spectrum analyzer.

The number of sweeps is set in the **General Settings** dialog box, **Sweep Count** field. If the measurement is performed over multiple sweeps both a max hold trace and an average trace are displayed.

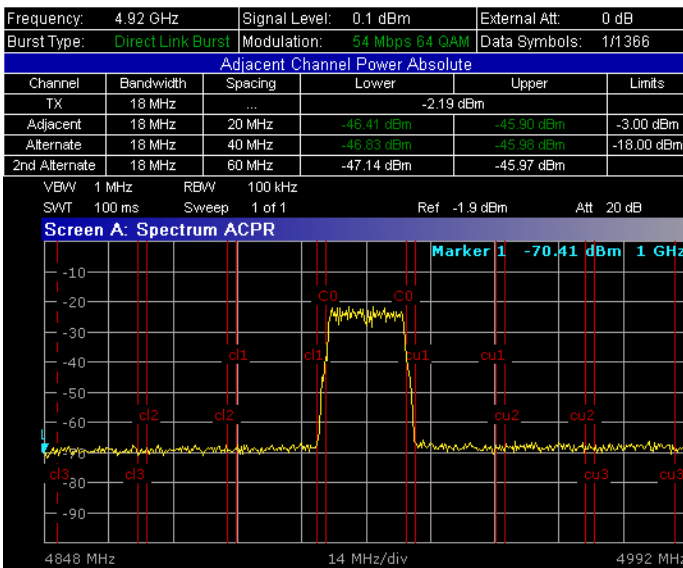

- Remote: CONF : BURS : SPEC : ACPR
- Remote: CALC : MARK : FUNC : POW : RES? (result query)
- Remote: CALC : MARK : FUNC : POW : RES : MAXH? (result query)

Statistics

Opens a submenu to display statistics measurement results.

CCDF

Sets the CCDF result display.

This result display shows the probability of an amplitude within the gating lines exceeding the mean power measured between the gating lines. The x-axis displays power relative to the measured mean power.

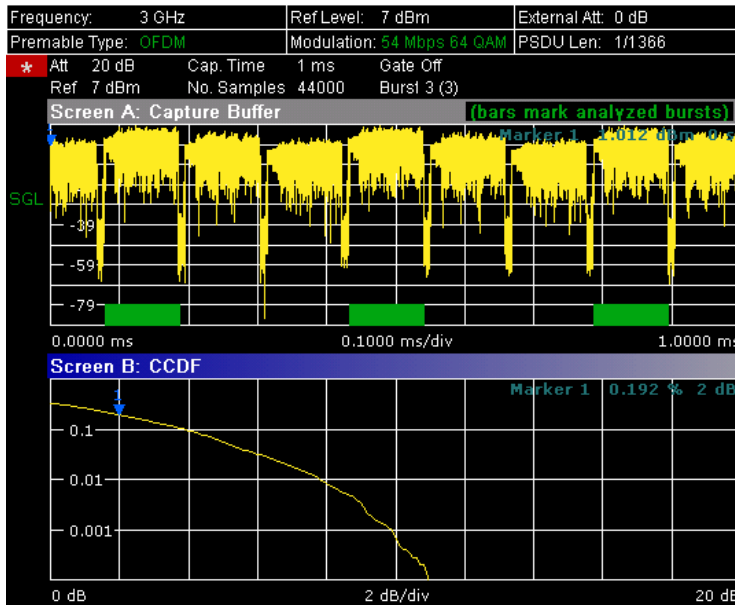

→ Remote: CONF: BURS: STAT: CCDF

Bitstream

Sets the Bitstream result display. This result display shows the demodulated data stream.

- IEEE 802.11a, j, g, n (OFDM):

The results are grouped by symbol and carrier.

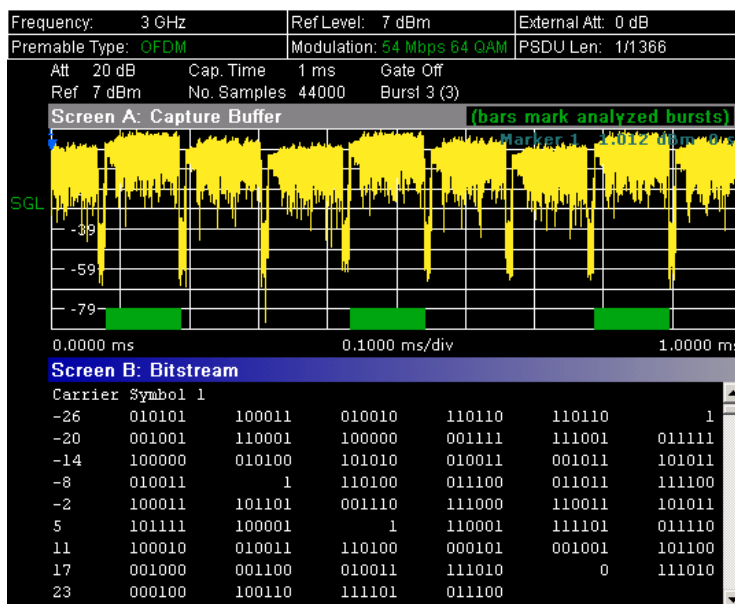

- IEEE 802.11b or g (Single Carrier)

The results are grouped by burst.

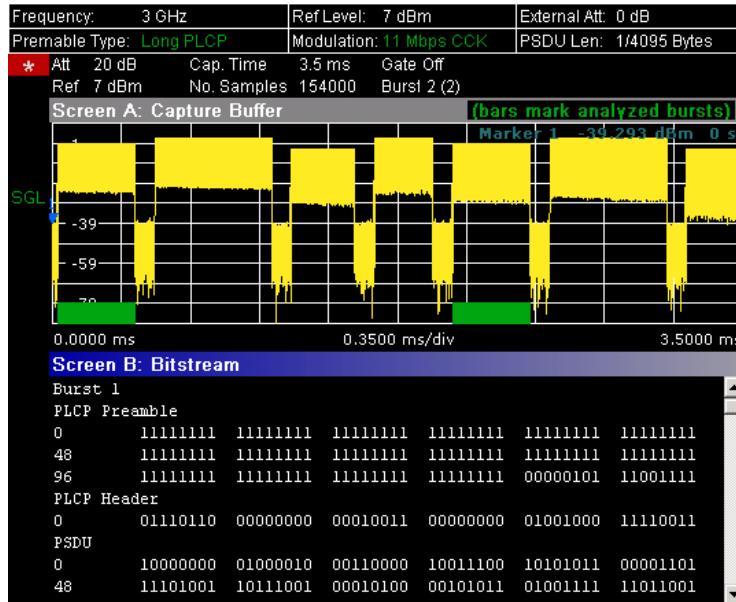

→ Remote: CONF: BURS: STAT: BSTR

**Signal Field (IEEE 802.11a, g, j, n - OFDM),
PLCP Header (IEEE 802.11b, g - Single Carrier)**

Sets the Signal Field result display or the PLCP Header result display, depending on the selected standard.

Signal Field

This result display shows the decoded data from the signal field of the burst. Therefore it is only available, if, in the **Demod Settings** dialog box, the **Signal Field Content** option is activated.

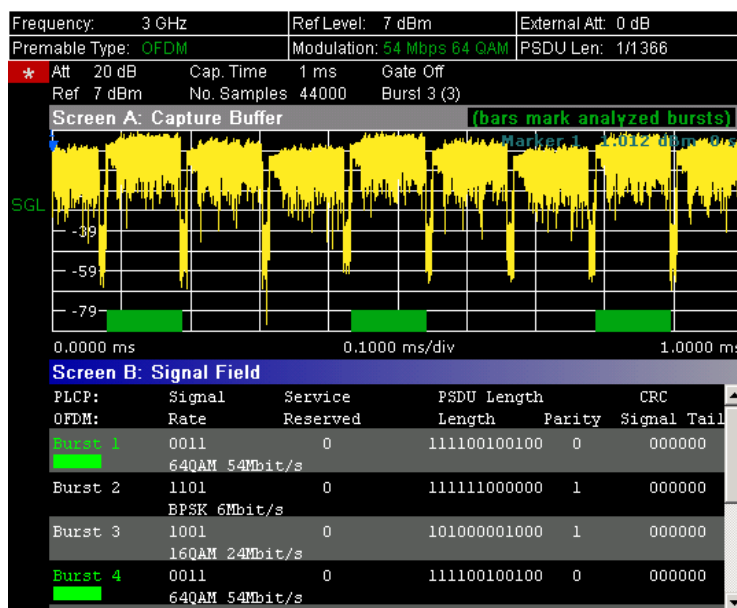

PLCP Header

This result display shows the decoded data from the PLCP header of the burst. The following details are listed:

Column header	Description	Example
Burst	number of the decoded burst A colored block indicates that the burst was successfully decoded.	Burst 1
Signal	signal field The decoded data rate is shown below.	00010100 2 Mbits/s
Service	service field The currently used bits are highlighted. The text below explains the decoded meaning of these bits.	00000000 --/--
PSDU Length	length field The decoded time to transmit the PSDU is shown below.	000000001111000 120 µs
CRC	CRC field The result is displayed below (OK for passed or Failed).	1110100111001110 OK

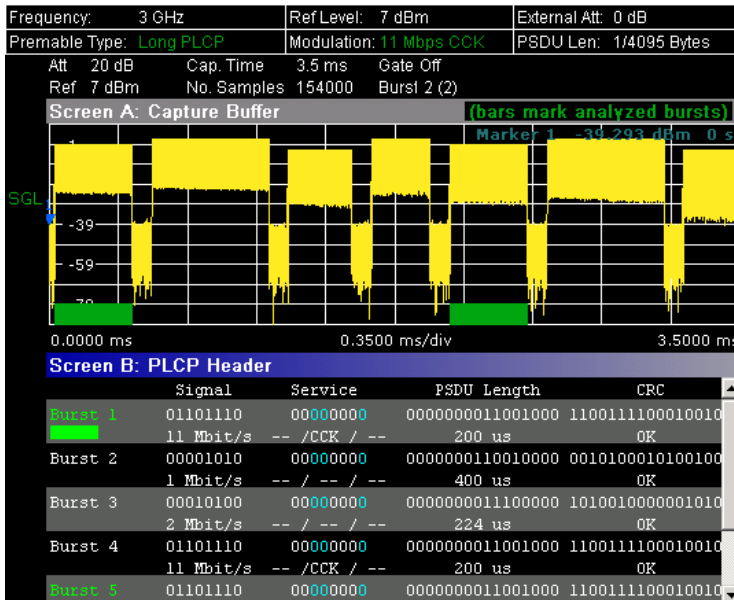

→ Remote: CONF:BURS:STAT:SFIeld

Softkeys of the sweep menu (WLAN mode)

The following table shows all softkeys available in the sweep menu in **WLAN** mode (**SWEEP** key). It is possible that your instrument configuration does not provide all softkeys. If a softkey is only available with a special option, model or (measurement) mode, this information is delivered in the corresponding softkey description.

Command
Meas Single/Cont
Auto Level
Refresh

Meas Single/Cont

Selects the sweep mode.

Single single sweep mode

Cont continuous sweep mode

- Remote: INIT:CONT OFF (single sweep mode)
- Remote: INIT:CONT ON (continuous sweep mode)

Auto Level

Starts an automatic level detection measurement. If this softkey is pressed while a measurement is running, the current measurement is aborted and the automatic level detection measurement is started. If the aborted measurement was a continuous measurement it is resumed after the automatic level detection is completed.

- Remote: CONF:POW:AUTO ON

Refresh

Updates the current measurement results with respect to the current gate settings. This softkey is only available if the measurement results are effected by the gate settings (Spectrum FFT, PVT and CCDF) and if the gate settings are modified after a measurement result has been obtained.

Softkeys of the marker menu (WLAN mode)

The following table shows all softkeys available in the marker menu in **WLAN** mode (**MKR** key). It is possible that your instrument configuration does not provide all softkeys. If a softkey is only available with a special option, model or (measurement) mode, this information is delivered in the corresponding softkey description. Close all settings dialog boxes before opening the marker menu.

Command
Marker 1
Unzoom
Marker Zoom
Marker Off

Marker 1

Opens a dialog box to adjust the marker. The contents of the dialog box depends on the type of graph the marker is adjusted to. After every change, the marker position in the trace and the marker information are updated.

- Remote: CALC:MARK ON
- Remote: CALC:MARK:X 2ms
- Remote: CALC2:MARK:Y -2
- Remote: CALC:MARK:SYMB 2
- Remote: CALC:MARK:CARR -7

Unzoom

Cancels the marker zoom.

→ Remote: CALC:MARK:FUNC:ZOOM 1

Marker Zoom

Opens an edit dialog box to select the magnification factor for the zoom. The zoom facility is provided for the following result displays: Magnitude Capture Buffer, PVT, Constellation vs Symbol, Constellation vs Carrier. The maximum magnification depends on the type of result display.

→ Remote: CALC:MARK:FUNC:ZOOM 3

Marker Off

Switches off all makers in the active result display.

→ Remote: CALC:MARK:AOFF

Softkeys of the marker-> menu (WLAN mode)

The following table shows all softkeys available in the marker-> menu in **WLAN** mode (**MKR->** key). It is possible that your instrument configuration does not provide all softkeys. If a softkey is only available with a special option, model or (measurement) mode, this information is delivered in the corresponding softkey description.

Command
Peak
Min
MKR -> Trace

Peak (Spectrum Flatness result display)

Sets the marker to the peak value of the assigned trace.

→ Remote: CALC:MARK:MAX

Min (Spectrum Flatness result display)

Sets the marker to the minimum value of the assigned trace.

→ Remote: CALC:MARK:MIN

MKR -> Trace

Opens an edit dialog box to enter the number of the trace, on which the marker is to be placed. This softkey is available for all result displays with more than one trace.

→ Remote: CALC:MARK:TRAC 2

Softkeys of the lines menu (WLAN mode)

The following table shows all softkeys available in the lines menu in **WLAN** mode (**LINES** key). It is possible that your instrument configuration does not provide all softkeys. If a softkey is only available with a special option, model or (measurement) mode, this information is delivered in the corresponding softkey description.

This menu is only available if the results are displayed in form of a list (for details see [Result summary list](#) and **Display List/Graph** softkey).

Command
Default Current
Default All

Default Current

Resets all limits for the current modulation scheme to the values specified in the selected standard.

→ Remote: see CALCulate:LIMit Subsystem

Default All

Resets all limits for all modulation schemes to the values specified in the selected standard.

→ Remote: see CALCulate:LIMit Subsystem

Softkeys of the trace menu (WLAN mode)

The following table shows all softkeys available in the trace menu in **WLAN** mode (**TRACE** key). It is possible that your instrument configuration does not provide all softkeys. If a softkey is only available with a special option, model or (measurement) mode, this information is delivered in the corresponding softkey description.

Command
Display List/Graph
Screen A/B
Screen Full/Split

Display List/Graph

For details refer to the **Display List/Graph** softkey in the WLAN menu.

Screen A/B

Selects the active screen for IQ measurement results in split and full screen mode. Only the markers of an active screen can be controlled.

→ Remote: DISP:WIND1:SSEL

Screen Full/Split

Changes the display between split and full screen for IQ measurement results. Frequency sweep measurement results are always displayed in full screen.

→ Remote: `DISP:FORM SING`

WiMAX, WiBro Measurements (Options K92/K93)

The WiMAX IEEE 802.16 OFDM, OFDMA Measurements option (R&S FSL-K93) extends the functionality of the R&S FSL to enable WiMAX IEEE 802.16e, WiBro Measurements according to the IEEE standards listed below. It includes the functionality of the WiMAX 802.16 OFDM Measurements option (R&S FSL-K92). Accordingly both options are described together in this section, differentiated by the corresponding standards: WiMAX 802.16 OFDM Measurements (R&S FSL-K92/K93)

- IEEE 802.16-2004/Cor 1-2005 OFDM physical layer mode

The short forms *IEEE 802.16-2004 OFDM* is used in this section to reference this standard.
The corresponding remote control mode is *OFDM*.

- WiMAX IEEE 802.16 OFDM, OFDMA Measurements option (R&S FSL-K93)

- IEEE 802.16-2004/Cor 1-2005, IEEE 802.16e-2005 OFDMA physical layer mode

The short form *IEEE 802.16e-2005 OFDMA* is used in this section to reference this standard.
The corresponding remote control mode is *OFDMA*.

- IEEE 802.16-2004/Cor 1-2005, IEEE 802.16e-2005 based WiBro

The short form *IEEE 802.16e-2005 WiBro* is used in this section to reference this standard. The corresponding remote control mode is *WiBro*.

The options are available from firmware version 1.40 (R&S FSL-K92) and 1.50 (R&S FSL-K93).

TX measurements of a WiMAX Device Under Test (DUT) according to the standards specified for the device are performed:

- Modulation formats
 - IEEE 802.16-2004: BPSK (IEEE 802.16-2004 OFDM), QPSK, 16QAM, 64QAM
- Modulation measurements
 - Constellation diagram
 - Constellation diagram per OFDM carrier
 - I/Q offset and I/Q imbalance
 - Carrier and symbol frequency errors
 - Modulation error (EVM) per OFDM carrier or symbol
 - Amplitude response and group-delay distortion (spectral flatness)
- Amplitude statistics (CCDF) and crest factor
- Frequency and Phase error vs Symbol
- Transmit spectrum mask
- Adjacent Channel Power (absolute and relative)
- FFT, also over a selected part of the signal, e.g. preamble
- Payload bit information
- Capture time selectable up to 50 ms, multiple sweeps possible for large number of bursts

To open the measurement menu

- If the **WiMAX** mode is not the active measurement mode, press the **MODE** key and activate the **WiMAX** option.

- If the **WiMAX** mode is already active, press the **MENU** or **MEAS** key.
The measurement menu is displayed. .
- To exit the **WiMAX** measurement mode, select another option. For details refer also to section "[Measurement Mode Selection - MODE Key](#)" on page 4.120.

Menu and softkey description

- "[Softkeys of the WiMAX menu \(WiMAX mode\)](#)" on page 4.430
- "[Softkeys of the sweep menu \(WiMAX mode\)](#)" on page 4.468
- "[Softkeys of the marker menu \(WiMAX mode\)](#)" on page 4.469
- "[Softkeys of the marker-> menu \(WiMAX mode\)](#)" on page 4.469
- "[Softkeys of the lines menu \(WiMAX mode\)](#)" on page 4.470
- "[Softkeys of the trace menu \(WiMAX mode\)](#)" on page 4.470

The file, setup, and print menus are provided as described for the base unit. For details refer to the corresponding menu descriptions. The span and bandwidth menus are not available in the **WiMAX** mode.

The **FREQ**, **AMPT** and **TRIG** keys open the **General Settings** or the **Demod Settings** dialog box. For details refer to the **Settings General/Demod** softkey description (measurement menu).

Further information topics

- "[Measurements and result displays](#)" on page 4.424
- "[Current restrictions to the IEEE 802.16e-2005 OFDMA/WiBro signal to be analyzed](#)" on page 4.425
- "[Title bar information](#)" on page 4.429
- "[Status bar information](#)" on page 4.429

Tasks topics

- "[To transfer the current R&S SMU WiMAX setting via LAN](#)" on page 4.429

Measurements and result displays

The WiMAX IEEE 802.16 OFDM, OFDMA Measurements option provides two main measurement types:

- IQ measurements (based on captured IQ data)
 - Power vs Time (see **PVT** softkey)
 - EVM vs Symbol, EVM vs Carrier (see **EVM vs Symbol/Carrier** softkey)
 - Phase vs Preamble, Frequency vs Preamble (see **Error Frequency/Phase** softkey)
 - Spectrum Flatness (see **Spectrum Flat./Diff./Group Delay** softkey)
 - Spectrum Group Delay (see **Spectrum Flat./Diff./Group Delay** softkey)
 - Spectrum Flatness Adjacent Carrier Power Difference (see **Spectrum Flat./Diff./Group Delay** softkey)
 - Spectrum FFT (see **Spectrum FFT** softkey)
 - Constellation vs Symbol (see **Constell vs Symbol/Carrier** softkey)

- Constellation vs Carrier (IEEE 802.16-2004 OFDM only, see **Constell vs Symbol/Carrier** softkey)
- Conditional Cumulative Distribution Function (see **CCDF** softkey)
- Bit Stream (see **Bitstream** softkey)
- frequency sweep measurements
 - Spectrum Mask (see **Spectrum IEEE/ETSI** softkey)
 - Spectrum ACP/ACPR (see **ACPR Abs/Rel** softkey)

For current restrictions refer to [Current restrictions to the IEEE 802.16e-2005 OFDMA/WiBro signal to be analyzed](#).

The measurement result display is divided into two panes:

- [Measurement settings](#)
- Result displays

The results can be displayed in form of a list or a graph (see also **Display List/Graph** softkey).

- [Result summary list](#)
- [Result display graph](#)

Current restrictions to the IEEE 802.16e-2005 OFDMA/WiBro signal to be analyzed

- standard
 - IEEE 16-2004/Cor1-2005, IEEE 802.16e-2005, OFDMA Physical Layer Mode, 1 October 2004/28 February 2006
 - IEEE 16-2004/Cor1-2005, IEEE 802.16e-2005 based WiBro

- FFT sizes

The FFT sizes 128, 512, 1024 and 2048 are supported.

- subframes

- Either a DL subframe or a UL subframe can be analyzed at one point in time.
- One DL-PUSC zone per DL subframe is supported.
- One DL-FUSC zone immediately following the first mandatory DL-PUSC zone is supported (DL subframe).
- One UL-PUSC zone per UL subframe is supported.
- The subframes have to be separated by sufficient power off gaps.

- segments

The first mandatory DL-PUSC zone must contain exclusively one segment. The assignment of subchannel groups to this segment is not restricted.

- symbols

The signal to be analyzed must contain at least two OFDMA data symbols. More OFDMA data symbols will improve the accuracy of the measurement results.

- burst

Each OFDMA symbol of a zone must contain at least one active burst, i.e. each OFDMA symbol of the zone must comprise subchannels belonging to an active burst. The zone/segment must be covered by active bursts, i.e. no gaps at the beginning, mid or end of the zone/segment are allowed.

- UL subframes

In case of UL subframe analysis, the frame number must be constant for the signal to be analyzed.

Measurement settings

The overall measurement settings used to obtain the current measurement results are displayed below the title bar (see Fig. 4-48). The following settings are listed:

Setting	Description	Standard restrictions
Frequency	The frequency of the measured input signal.	
Burst Type	The type of burst being analyzed	IEEE 802.16-2004 OFDM only
Zone/Seg	The zone and segment being analyzed	IEEE 802.16e-2005 OFDMA/WiBro only
Signal Level	The expected mean signal level for the input signal.	
Modulation	Shows the active setting selected in the Demod Settings dialog box, Demodulator list. If the Mod. Detection field is set to ALL , ALL is displayed.	IEEE 802.16-2004 OFDM only
	Shows the active setting selected in the Demod Settings dialog box, Demodulator list. If the Modulation Analysis Scope field is set to ALL , ALL is displayed.	IEEE 802.16e-2005 OFDMA/WiBro only
External Att	The attenuation (positive values) or gain (negative values) applied to the signal externally (i.e. before the RF or IQ connector of the spectrum analyzer), e.g.: External Att = 10 dB means that before the RF connector of the R&S FSL a 10 dB attenuator is used External Att = -20 dB means that before the RF connector of the R&S FSL a amplifier with 20 dB gain is used.	
Data Symbols	Shows the minimum and maximum number of data symbols that a burst may have to be considered in results analysis .	IEEE 802.16-2004 OFDM only
Zone Offset/Length	A combined display of the offset and length of the analyzed zone	IEEE 802.16e-2005 OFDMA/WiBro only

R&S FSL- K93 WIMAX		IEEE 802.16 - 2004	
Frequency: 1 GHz	Signal Level: -13.8 dBm	External Att: 0 dB	
Burst Type: OFDM DL Burst	Modulation: 64QAM3/4	Data Symbols: 1/2425	

Fig. 4-48 Measurement settings for IEEE 802.16-2004 OFDM (example)

R&S FSL- K93 WIMAX		IEEE 802.16e-2005 OFDMA	
Frequency: 1 GHz	External Att: 0 dB	Signal Level Setting: -31.4 dBm	
Zone/Seg: DL-PLUS Seg. 0, Zone/Seg	Modulation: ALL	Zone Offset/Length: 1/22 Symbols	

Fig. 4-49 Measurement settings for IEEE 802.16e-2005 OFDMA/WiBro (example)

Result summary list

If the results are displayed in tabular form (**Display Graph/List** softkey), the result summary list is displayed. It shows the overall measurement results and provides limit checking for result values in accordance with the selected standard. Result values which are within the limit as specified by the standard are displayed in green. Result values which are outside of the limits specified by the standard are displayed in red with a '*' to the left. Results which have no limits specified by the standard are displayed in white. Limit values are displayed in white (not bold) and can be modified, when focused,

via the keypad. Limits are modified for the currently selected modulation scheme. Each modulation scheme may have its own set of user defined limits. To reset the limit values to the values specified in the standard, use the lines menu (**LINES** key).

- IEEE 802.16-2004 OFDM

The results displayed in this list are for the entire measurement. If a specific number of bursts have been requested which requires more than one sweep, the result summary list is updated at the end of each sweep. The number of bursts measured and the number of bursts requested are displayed to show the progress through the measurement. The Min / Mean / Max columns show the minimum, mean or maximum values of the burst results.

R&S FSL - K93 WIMAX		IEEE 802.16 - 2004					
Frequency:	1 GHz	Signal Level:	-13.8 dBm	External Att:	0 dB		
Burst Type:	OFDM DL Burst	Modulation:	64QAM3/4	Data Symbols:	1/2425		
Result Summary							
Bursts:	19	Min	Mean	Limit	Max	Limit	Unit
EVM All Carr.		-42.77	-41.80	-31.00	-40.06	-31.00	dB
EVM Data Carr.		-42.82	-41.78		-39.99		dB
EVM Pilot Carr.		-43.60	-42.29		-41.22		dB
IQ Offset		-61.94	-59.59	-15.00	-57.53	-15.00	dB
Gain Imbalance		-0.01	-0.01		-0.01		dB
Quadrature Err		-0.017	-0.009		-0.004		°
Freq. Err		99.20	100.12	± 8000	100.85	± 8000	Hz
Clock Err		0.09	0.10	± 8	0.11	± 8	ppm
Burst Power		-11.08	-11.06		-11.04		dBm
Crest Factor		6.92	9.75		10.67		dB
RSSI		-8.10	-8.10		-8.10		dBm
RSSI Std. Dev.			-26.20				dB
CINR		39.50	42.52		43.69		dB
CINR Std. Dev.			31.23				dB

Fig. 4-50 Result summary list for IEEE 802.16-2004 OFDM (example)

- IEEE 802.16e-2005 OFDMA, WiBro

For these measurement results, the minimum, mean, and maximum is taken over the analyzed zones of the current capture buffer content.

Two lists are available:

- Result Summary of Analyzed Subframes (list 1)
- Result Summary of Analyzed Zone / Segment (list 2)

R&S FSL - K93 WIMAX		IEEE 802.16e-2005 OFDMA					
Frequency:	1 GHz	External Att:	0 dB	Signal Level Setting:	-31.4 dBm		
Zone/Seg:	DL-PUSC Seg. 0, Zone/Seg	Modulation:	ALL	Zone Offset/Length:	1/22 Symbols		
Result Summary of Analyzed Subframes							
No. of Subframes							2
Bursts:		Min	Mean	Limit	Max	Limit	Unit
Freq. Error		539.14	539.17	± 2000	539.21	± 2000	Hz
Clock Error		0.54	0.54	± 2	0.54	± 2	ppm
TD Pwr DL Preamble		-12.00	-12.00		-12.00		dBm
TD Pwr Subframe		-15.58	-15.58		-15.58		dBm
TD Pwr Zone		-15.84	-15.84		-15.84		dBm
Crest Factor		10.50	10.59		10.67		dB
RSSI		-12.62	-12.62		-12.62		dBm
RSSI Std. Dev.			-50.82				dBm
CINR		39.55	39.55		39.66		dB
CINR Std. Dev.			24.72				dB

Fig. 4-51 Result summary list 1 for IEEE 802.16e-2005 OFDMA/WiBro (example)

R&S FSL - K93 WIMAX		IEEE 802.16e-2005 OFDMA				Settings
Frequency: 1 GHz	External Att: 0 dB	Signal Level Setting: -31.4 dBm				General
Zone/Seg: DL-PUSC Seg. 0, Zone/Seg	Modulation: ALL	Zone Offset/Length: 1/22 Symbols				Demod
Result Summary of Analyzed Zone / Segment						
Zones/Segments						2
Bursts:	Min	Mean	Limit	Max	Limit	Unit
BER Pilots	0.00	0.00	0.00	0.00	0.00	%
EVM Data & Pilots	-43.29	-43.22	-30.00	-43.15	-30.00	dB
EVM Data	-43.66	-43.59	-30.00	-43.52	-30.00	dB
EVM Pilots	-41.55	-41.49		-41.43		dB
IQ Offset	-57.63	-57.62	-15.00	-57.61	-15.00	dB
Gain Imbalance	-0.01	-0.01		-0.01		dB
Quadrature Err	-0.021	-0.015		-0.008		°
Power DL Preamble	-6.42	-6.42		-6.42		dBm
Power Data & Pilots	-10.20	-10.20		-10.20		dBm
Power Data	-10.66	-10.66		-10.66		dBm
Power Pilots	-8.17	-8.17		-8.17		dBm
Refresh Complete						More ↓

Fig. 4-52 Result summary list 2 for IEEE 802.16e-2005 OFDMA/WiBro (example)

For details regarding how the results are calculated refer to chapter "Advanced Measurement Examples".

Result display graph

- IQ measurements

If the results are displayed in graphical form (**Display Graph/List** softkey), additionally to the selected graphical result display, the Magnitude Capture Buffer (power profile) display is provided for all IQ measurements. The different result displays are described with the corresponding softkey.

The Magnitude Capture Buffer display shows the complete range of captured data for the last sweep. All analyzed bursts are identified with a green bar at the bottom of the Magnitude Capture Buffer display. Only those bursts match the required criteria. The gate delay line (**GD**) and gate length line (**GL**) are displayed in red color.

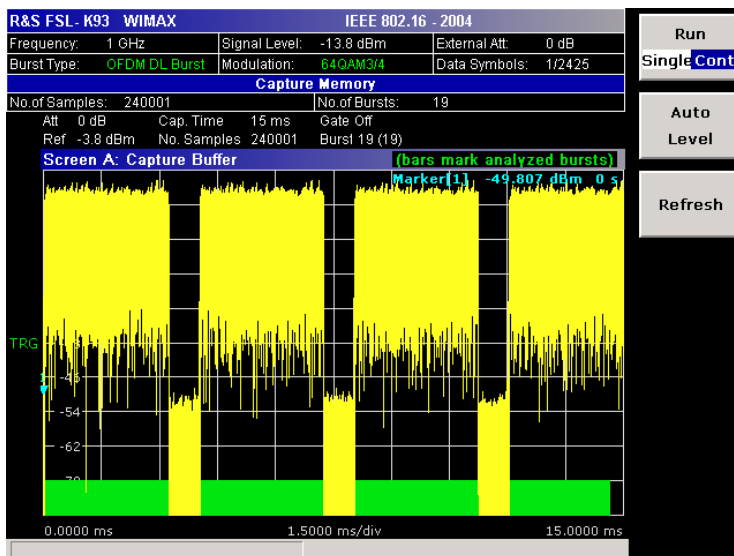

Fig. 4-53 Magnitude capture buffer results (example)

All IQ measurements process the same signal data and as such all IQ measurement results are available after a single IQ measurement execution.

IQ measurements can be run in split screen mode (allowing both the Magnitude Capture Buffer display and the selected IQ measurement results to be displayed simultaneously) or in full screen mode (with either the Magnitude Capture Buffer display or the selected IQ measurement results displayed).

When measuring OFDMA or WiBro measurements, the time from the start of the capture buffer to the start of the first frame is also displayed in the Magnitude Capture buffer. This time is marked with a vertical blue line, with the result displayed at the top of the graph.

- frequency sweep measurements

The frequency sweep measurements use different signal data to IQ measurements and as such it is not possible to run an IQ measurement and then view the results in the frequency sweep measurements and vice-versa. Also because each of the frequency sweep measurements uses different settings to obtain signal data it is not possible to run a frequency sweep measurement and view the results of another frequency sweep measurement.

All frequency sweep measurements are run in full screen mode.

Further information

This section provides background information on measurements and displayed information. For details on signal processing refer to chapter "Advanced Measurement Examples", section "WiMAX, WiBro Measurements (Options K92/K93)".

To transfer the current R&S SMU WiMAX setting via LAN

Prerequisite:

- The Windows Firewall of the R&S SMU is switched off.
1. Press the **Settings General/Demod** softkey to open the **General Settings** dialog box.
 2. Under **Signal Characteristics** in the **Standard** list, select the **IEEE 802.16e-2005 OFDMA** or **IEEE 802.16e-2005 WiBro** standard.
 3. Under **Setup** in the **SMU Address** field, specify the TCP/IP address of the R&S SMU.
 4. Press the More **↓** softkey to change into the side menu.
 5. Press the **File Manager** softkey to open the File Manager.
 6. Under **Folders**, select the **SMU** entry.
 7. Under **Files**, select the **Current SMU WiMAX Settings** entry using the **RIGHTARROW** key.
 8. Press the **Recall** softkey.

The selected WiMAX setting file is transferred from the R&S SMU to the R&S FSL.

Title bar information

The title bar displays the following information:

- standard applicable to the current measurement

Status bar information

The status bar displays the following information:

- parameter values

If a parameter in a settings dialog box is selected, the minimum and maximum values for the selected parameter are displayed.

If a Boolean parameter in a dialog box is selected, the minimum and maximum values are displayed as N/A for not applicable.

- measurement status
During the measurement, the current measurement status along with detailed information about the progress is displayed.
- error messages (with red background), for details refer to chapter "Error Messages".
- warning messages (with blue background), for details refer to chapter "Error Messages".

Softkeys of the WiMAX menu (WiMAX mode)

The following table shows all softkeys available in the WiMAX menu. It is possible that your instrument configuration does not provide all softkeys. If a softkey is only available with a special option, model or (measurement) mode, this information is delivered in the corresponding softkey description.

Menu / Command	Command
Settings General/Demod	
Display Graph/List	
PVT ↓	Settings General/Demod
	Display Graph/List
	Full Burst
	Start End
	Burst Selection
	Full Subframe
	Rising/Falling
	More ↓
	Gating Settings On/Off
	Import
	Export
	R&S Support
EVM Constell ↓	Settings General/Demod
	EVM vs Symbol/Carrier
	Error Frequency/Phase
	Constell vs Symbol/Carrier
	Carrier Selection
	Constell Selection
	More ↓
	Gating Settings On/Off
	Import
	Export
	Y-Axis/Div

Menu / Command	Command
	R&S Support
Spectrum ↓	Settings General/Demod
	Display Graph/List
	Spectrum Flat./Diff./Group Delay
	Spectrum IEEE/ETSI
	Spectrum Mask
	Spectrum FFT
	ACPR Abs/Rel
	More ↓
	Gating Settings On/Off
	SEM Settings
	ACP Settings
	Import
	Export
	R&S Support
Statistics ↓	Settings General/Demod
	Display Graph/List
	CCDF
	Bitstream
	Burst Summary
	Bit Selection
	More ↓
	Gating Settings On/Off
	Import
	Export
	R&S Support
File Manager ↓	For the available File Manager softkeys, see the description of the File Manager softkey.

Settings General/Demod

Opens the **General Settings** dialog box or the **Demod Settings** dialog box. Screenshots of the dialog boxes are provided in chapter "Advanced Measurement Examples", section "Measurement Examples of the WiMAX IEEE 802.16 OFDM, OFDMA Measurements option (K93)".

Alternatively, the **General Settings** dialog box is opened as follows:

- **FREQ** key, with focus on the **Frequency** field
- **AMPT** key, with focus on the **Signal Level (RF)** field
- **TRIG** key, with focus on the **Trigger Mode** list

In the **General Settings** dialog box, all settings related to the overall measurement are modified. The right pane with the advanced settings is only displayed, if the **Advanced Settings** option is activated. The **General Settings** dialog box contains the following elements:

Pane	Field/List	Standard Restrictions
Signal Characteristics	Standard	
	Frequency	
	Channel No	IEEE 802.16-2004 OFDM
	Frequency Band	
	FFT Size NFFT	IEEE 802.16e-2005 OFDMA/WiBro
	Channel BW	
	Sample Rate	
	G = Tg/Tb	
Level Settings	Signal Level	
	Auto Lev	
	Ext Att	
Data Capture Settings	Capture Time	
	Burst Count	
	Analyze Bursts	
	Sweep Time	
	Sweep Count	
Trigger Settings	Trigger Mode	
	Trigger Offset	
	Power Level	
	Auto Lvl	
Input Settings Advanced	Auto Level Time	
	Ref Level	
	Attenuation	
IQ Settings	Swap IQ	
Result Settings	RSSI, CINR avg.	
	List Results Unit	IEEE 802.16-2004 OFDM
Setup	SMU Address	IEEE 802.16e-2005 OFDMA/WiBro

In the **Demod Settings** dialog box, the settings associated with the signal modulation are modified. The content of the **Demod Settings** dialog box depends on the selected standard:

- IEEE 802.16-2004 OFDM

The settings under **Burst to Analyze** specify the characteristics of the bursts to be considered in the measurement results. Only the bursts which meet the criteria specified in this group will be included in measurement analysis. The settings under **Tracking** allow various errors in measurement results to be compensated for.

- IEEE 802.16e-2005 OFDMA/WiBro

The **Demod Settings** dialog box contains the three tabs. Use the left/right arrow keys to navigate between the tabs.

On the **Demod Settings** tab, the channel estimation range is set. The settings under **Bursts to Analyze** specify the characteristics of the bursts to be considered in the measurement results.

The settings under **Tracking** allow various errors in measurement results to be compensated for.

On the **Frame Global** tab, the common settings associated with the frame to be analyzed can be modified.

On the **Frame Config** tab, the settings associated with the frame configuration can be modified. The **Zone/Segment List** and the **Burst List** are displayed. The content of the selected list is graphically displayed under The content of the selected list is graphically displayed under the **Zone/Segment Map** and the **Burst Map** respectively. To edit **Frame Config** tab, softkeys are available (see the table below).

The **Demod Settings** dialog box contains the following elements:

Tab/Pane	Field/List or Softkey	Standard Restrictions
Demod Settings		
Burst to Analyze	Burst Type	IEEE 802.16-2004 OFDM
	Link Mode	IEEE 802.16-2004 OFDM
	Use FCH Content	IEEE 802.16-2004 OFDM
	Mod. Detection	IEEE 802.16-2004 OFDM
	Demodulator	IEEE 802.16-2004 OFDM
	Subchannelization	IEEE 802.16-2004 OFDM
	Index	IEEE 802.16-2004 OFDM
	UL Phys. Modifier	IEEE 802.16-2004 OFDM
	Equal Burst Length	IEEE 802.16-2004 OFDM
	Data Symbols	IEEE 802.16-2004 OFDM
	Min Data Symbols	IEEE 802.16-2004 OFDM
	Max Data Symbols	IEEE 802.16-2004 OFDM
	Channel Estimation	IEEE 802.16-2004 OFDM
Tracking	Phase	IEEE 802.16-2004 OFDM
	Timing	IEEE 802.16-2004 OFDM
	Level	IEEE 802.16-2004 OFDM
Demod Settings		
Channel Estimation Range	Downlink (DL)	IEEE 802.16e-2005 OFDMA/WiBro
	Uplink (UL)	IEEE 802.16e-2005 OFDMA/WiBro
Bursts To Analyze	Modulation Analysis Scope	IEEE 802.16e-2005 OFDMA/WiBro
	Demodulator	IEEE 802.16e-2005 OFDMA/WiBro
Tracking Settings	Phase	IEEE 802.16e-2005 OFDMA/WiBro
	Timing	IEEE 802.16e-2005 OFDMA/WiBro
	Pilots for Tracking DL	IEEE 802.16e-2005 OFDMA/WiBro
	Pilots for Tracking UL	IEEE 802.16e-2005 OFDMA/WiBro
Advanced	FFT start offset rel to CP center	IEEE 802.16e-2005 OFDMA/WiBro
Frame Global		
Frame	File Name	IEEE 802.16e-2005 OFDMA/WiBro
	IDCell	IEEE 802.16e-2005 OFDMA/WiBro
DL Subframe	Preamble Mode	IEEE 802.16e-2005 OFDMA/WiBro
	Preamble Index	
	Used Subchannel Bitmap	

Tab/Pane	Field/List or Softkey	Standard Restrictions
UL Subframe	Frame Number	IEEE 802.16e-2005 OFDMA/WiBro
	Allocated Subchannel Bitmap	IEEE 802.16e-2005 OFDMA/WiBro
Frame Config		
	List Zone/Burst	IEEE 802.16e-2005 OFDMA/WiBro
	Copy Zone/Burst	IEEE 802.16e-2005 OFDMA/WiBro
	Insert Zone/Burst	IEEE 802.16e-2005 OFDMA/WiBro
	New Zone/Burst	IEEE 802.16e-2005 OFDMA/WiBro
	New Segment	IEEE 802.16e-2005 OFDMA/WiBro
	Delete Zone/Burst	IEEE 802.16e-2005 OFDMA/WiBro
	File Manager ↓	IEEE 802.16e-2005 OFDMA/WiBro

Standard (General Settings dialog box)

Displays a list of all installed standards to select the WiMAX/WiBro standard:

Standard	Installed with Option
IEEE 802.16-2004 OFDM	R&S FSL-K92/K93
IEEE 802.16e-2005 OFDMA	R&S FSL-K93 only
IEEE 802.16e-2005 WiBro	R&S FSL-K93 only

All available entries represent a list of default settings in accordance to the specified standard. This ensures that the measurements are performed according to the specified standard with the correct limit values and limit lines.

→ Remote: CONF:STAN 0

Frequency (General Settings dialog box)

Specifies the center frequency of the signal to be measured. If the frequency is modified, the **Channel No** field is updated accordingly.

→ Remote: FREQ:CENT 100MHz

Channel No (General Settings dialog box, IEEE 802.16-2004 OFDM)

Specifies the channel to be measured. If the field entry is modified, the center frequency is derived according to the section in the standard mentioned below and updated.

- For the Licensed Bands {ETSI, MMDS, WCS}:
Channel numbers are supported according to IEEE Std 802.16-2004 "8.3.10.2 Transmitter channel bandwidth and RF carrier frequencies". For the target frequency bands see IEEE Std 802.16-2004 "B.1 Targeted frequency bands".
- For the License Exempt Bands {U-NII, CEPT}:
Channel numbers are supported according to IEEE Std 802.16-2004 "8.5.1 Channelization".

→ Remote: CONF:CHAN 9

Frequency Band (General Settings dialog box)

Specifies the relationship between the **Channel BW** and the **Sample Rate** parameters.

→ Remote: CONF:WIM:FBAN ETSI

FFT Size N_{FFT} (General Settings dialog box, IEEE 802.16e-2005 OFDMA/WiBro)

Specifies the maximum number of carriers supported by the signal to be measured.

→ Remote: CONF:WIM:NFFT FFT2048

Channel BW (General Settings dialog box)

Specifies the bandwidth of the channel to be measured.

→ Remote: BAND:CHAN 7MHZ

Sample Rate (General Settings dialog box)

Specifies the sample rate used for IQ measurements.

→ Remote: TRACE:IQ:SRAT 2000000

 $G = T_g/T_b$ (General Settings dialog box)

Specifies the guard time ratio.

→ Remote: CONF:WIM:IGR 16

Signal Level (General Settings dialog box)

Specifies the expected level of the RF input signal. If an automatic level detection measurement has been executed, the signal level (RF) is updated.

→ Remote: CONF:POW:EXP:RF -20

Auto Lev (General Settings dialog box)

Activates or deactivates the automatic setting of the reference level for measurements.

On The reference level is measured automatically at the start of each measurement sweep. This ensures that the reference level is always set at the optimal level for obtaining accurate results but will result in slightly increased measurement times. For details about level detection refer to chapter "Advanced Measurement Examples".

Off The reference level is defined manually in the **Signal Level** field.

→ Remote: CONF:POW:AUTO ON

→ Remote: CONF:POW:AUTO:SWE:TIME 200MS

Ext Att (General Settings dialog box)

Specifies the external attenuation or gain applied to the RF signal. A positive value indicates attenuation, a negative value indicates gain. All displayed power level values are shifted by this value.

→ Remote: `DISP:TRAC:Y:RLEV:OFFS 10`

Capture Time (General Settings dialog box)

Specifies the time (and therefore the amount of data) to be captured in a single measurement sweep.

→ Remote: `SWE:TIME 10ms`

Burst Count (General Settings dialog box)

Activates or deactivates a specified number of bursts for capture and analysis.

On The data analysis is performed over a number of consecutive sweeps until the required number of bursts has been captured and analyzed.

Off The data analysis is performed on a single measurement sweep.

→ Remote: `BURS:COUN:STAT ON`

Analyze Bursts (General Settings dialog box)

Specifies the number of bursts to be measured, if the **Burst Count** option is activated.

If the number of bursts of the specified type is not contained in a single measurement sweep, the measurement sweeps continue until the requested number of bursts have been captured.

→ Remote: `BURS:COUN 16`

Sweep Time (General Settings dialog box)

Specifies the sweep time for the Spectrum Mask and Spectrum ACP/ACPR measurements:

– If the **Auto** option is activated, the sweep time is calculated automatically.

– If the **Auto** option is deactivated, specify the sweep time.

→ Remote: `SWE:ACPR:TIME 1S`

→ Remote: `SWE:ACPR:TIME:AUTO OFF`

Sweep Count (General Settings dialog box)

Specifies the number of sweeps to be performed for Spectrum ACP/ACPR and Spectrum Mask measurements.

→ Remote: `SWE:COUNT 64`

Trigger Mode (General Settings dialog box)

Sets the trigger source for the measurement sweep.

- Free Run** The measurement sweep starts immediately.
- External** The measurement sweep starts if the external trigger signal meets or exceeds the external trigger level (a fixed value that cannot be altered) at the input connector EXT TRIGGER/GATE IN on the rear panel.
- Power** The measurement sweep starts if the signal power meets or exceeds the specified power trigger level.

→ Remote: TRIG:MODE IMM

Trigger Offset (General Settings dialog box)

Specifies the time offset between the trigger signal and the start of the sweep. A negative value indicates a pre-trigger. This field is not available in the **Free Run** trigger mode.

→ Remote: TRIG:HOLD 500us

Power Level (General Settings dialog box)

Specifies the trigger level if the Power trigger mode is set (see **Trigger Mode** field).

→ Remote: TRIG:LEV:POW 10 DBM

Auto Lvl (General Settings dialog box)

Activates or deactivates the automatic measurement of the power trigger level if the **Power** trigger mode is set (see **Trigger Mode** field).

- On** The power trigger level is measured automatically at the start of each measurement sweep. This ensures that the power trigger level is always set at the optimal level for obtaining accurate results but will result in a slightly increased measurement times.
- Off** The power trigger level is defined manually in the **Power Level** field.

→ Remote: TRIG:LEV:POW:AUTO ON

Auto Level Time (General Settings dialog box)

Specifies the sweep time used for the automatic level measurements.

→ Remote: CONF:POW:AUTO:SWE:TIME 200MS

Ref Level (General Settings dialog box)

Specifies the reference level used for measurements. If the reference level is modified, the signal level is updated accordingly (depending on the currently selected standard and measurement type). This field is only editable if the **Auto Lev** option is deactivated.

→ Remote: DISP:TRAC:Y:RLEV?

Attenuation (General Settings dialog box)

Specifies the settings for the attenuator. This field is only editable if the **Auto Lev** option is deactivated. If the **Auto Lev** option is activated, the RF attenuator setting is coupled to the reference level setting.

→ Remote: INP:ATT 30dB

Swap IQ (General Settings dialog box)

Activates or deactivates the inverted I/Q modulation.

On I and Q signals are interchanged.

Off Normal I/Q modulation.

→ Remote: SWAP ON

RSSI, CINR avg. (General Settings dialog box)

Specifies the mean and standard deviation for the RSSI and CINR results (see IEEE Std 802.16-2004 "8.3.9.2 RSSI mean and standard deviation", "8.3.9.3 CINR mean and standard deviation").

→ Remote: CONF:WIM:AVER 0.1

List Results Unit (General Settings dialog box, IEEE 802.16-2004 OFDM)

Specifies the units for the results in the results summary table.

→ Remote: UNIT:TABL DB

SMU Address (General Settings dialog box, IEEE 802.16e-2005 OFDMA/WiBro)

Specifies the TCP/IP address of an external R&S SMU signal generator connected via TCP/IP. This enables the R&S FSL to download the frame zone setup directly.

→ Remote: SYST:COMM:TCP:ADDR 192.168.1.1

Burst Type (Demod Settings dialog box, IEEE 802.16-2004 OFDM)

Specifies the type of burst to be included in measurement analysis. Only one burst type can be selected for the measurement results. The **OFDM** burst type is supported.

Link Mode (Demod Settings dialog box, IEEE 802.16-2004 OFDM)

Specifies the link mode of bursts that are to be included in measurement analysis. The following link mode types are supported:

UL Up Link

DL Down Link

→ Remote: CONF:WIM:LMOD UL

Use FCH Content (Demod Settings dialog box, IEEE 802.16-2004 OFDM)

Activates or deactivates the decoding of the captured burst data FCH field.

- OFF This is the default setting and cannot be altered currently.
- ON Only the bursts with a modulation format matching the format specified in the **Demodulator** list are included in the results analysis.

Mod. Detection (Demod Settings dialog box, IEEE 802.16-2004 OFDM)

Specifies the demodulation of the signal. The following values are supported:

- None** No modulation detection is performed. The signal will be analyzed according to the **Demodulator** setting. Therefore the **Demodulator** setting must match with the modulation format of the subframe. This setting excludes the analysis of multiple modulation formats in a subframe.
- First Symbol** The first data symbol specifies the modulation format, i.e. the signal will be analyzed according to the modulation format of the first data symbol. This setting supports multiple modulation formats in a subframe.
If **First Symbol** is selected, the **Demodulator** setting is disabled and is automatically updated with the modulation scheme detected in the first symbol.
- User** Only bursts matching the setting in the **Demodulator** list are analyzed. This setting supports multiple modulation formats in a subframe.
- All** All bursts individual payload modulations are analyzed accordingly. This setting is useful to get an overview of the signal content.

→ Remote: DEM:FORM:AUTO FIRS

Demodulator (Demod Settings dialog box, IEEE 802.16-2004 OFDM)

Defines the modulation format for signal analysis if the Mod. Detection is set to None or User (see **Mod. Detection** field).

The measurement application does not distinguish between different coding rates for the same modulation format. If the signal to be analyzed contains the profiles (modulation format A, coding rate B) and (modulation format C, coding rate D), the signal to be analyzed must hold the following condition in order to produce correct measurement results:

$$[A == C \Rightarrow B == D]$$

→ Remote: DEM:FORM:BAN '16QAM1/2

Subchannelization (Demod Settings dialog box, IEEE 802.16-2004 OFDM)

Activates or deactivates the subchannelization, if the **Up Link** mode is set (see **Link Mode** field). If activated, the subchannel index of uplink bursts is analyzed, defined by the **Index** field.

→ Remote: SUBC:STAT ON

Index (Demod Settings dialog box, IEEE 802.16-2004 OFDM)

Defines the subchannelization index of uplink bursts to be analyzed. Subchannelization index 16 is the default subchannel with full occupation.

→ Remote: SUBC 12

UL Phys. Modifier (Demod Settings dialog box, IEEE 802.16-2004 OFDM)

Specifies a common UL physical modifier for all uplink bursts.

→ Remote: SUBC:ULPH 1

Equal Burst Length (Demod Settings dialog box, IEEE 802.16-2004 OFDM)

Activates or deactivates the burst selection for measurement analysis according to the range or specific number of data symbols/bytes.

- On Only bursts with exactly the number of symbols specified in the **Data Symbols** field are considered for measurement analysis.
- Off Only bursts within the range of data symbols specified by the **Min Data Symbols** and **Max Data Symbols** fields are considered for measurement analysis.

→ Remote: DEM:FORM:BAN:SYMB:EQU ON

Data Symbols (Demod Settings dialog box, IEEE 802.16-2004 OFDM)

Specifies the number of symbols that a burst must have to be considered for measurement analysis. This field is only available if the **Equal Burst Length** option is activated.

→ Remote: DEM:FORM:BAN:SYMB:MIN 16

Min Data Symbols (Demod Settings dialog box, IEEE 802.16-2004 OFDM)

Specifies the minimum number of data symbols that a burst must have to be considered in measurement analysis. This field is only available if the **Equal Burst Length** option is deactivated.

→ Remote: DEM:FORM:BAN:SYMB:MIN 16

Max Data Symbols (Demod Settings dialog box, IEEE 802.16-2004 OFDM)

Specifies the maximum number of data symbols that a burst must have to be considered in measurement analysis. This field is only available if the **Equal Burst Length** option is deactivated.

→ Remote: DEM:FORM:BAN:SYMB:MAX 1300

Channel Estimation (Demod Settings dialog box, IEEE 802.16-2004 OFDM)

Specifies how accurately the EVM results are calculated.

Preamble The channel estimation is performed in the preamble as required in the standard.

Payload The channel estimation is performed in the payload.

→ Remote: DEM:CEST ON

Phase (Demod Settings dialog box)

Activates or deactivates the compensation for the phase error. If activated, the measurement results are compensated for phase error on a per-symbol basis.

→ Remote: TRAC:PHAS ON

Timing (Demod Settings dialog box)

Activates or deactivates the compensation for the timing error. If activated, the measurement results are compensated for timing error on a per-symbol basis.

→ Remote: TRAC:TIME ON

Level (Demod Settings dialog box, IEEE 802.16-2004 OFDM)

Activates or deactivates the compensation for the level error. If activated, the measurement results are compensated for level error on a per-symbol basis.

→ Remote: TRAC:LEV ON

Downlink (DL) (Demod Settings dialog box, IEEE 802.16e-2005 OFDMA/WiBro)

Specifies how channel estimation is performed for downlink signals.

Preamble Only The channel estimation is performed in the preamble only.

Preamble and Payload The channel estimation is performed in the preamble and in the payload (payload comprises pilots and data).

Payload Only The channel estimation is performed in the payload only.

→ Remote: DEM:CEST PREAMPAYL

Uplink (UL) (Demod Settings dialog box, IEEE 802.16e-2005 OFDMA/WiBro)

Displays the channel estimation performed for uplink signals.

This field is for information purposes only as channel estimation for uplink signals are always performed in payload only (payload comprises pilots and data).

Modulation Analysis Scope (Demod Settings dialog box, IEEE 802.16e-2005 OFDMA/WiBro)

Displays the modulation formats to be analyzed.

This field is for information purposes only as all detected modulation schemes are analyzed.

Demodulator (Demod Settings dialog box, IEEE 802.16e-2005 OFDMA/WiBro)

Displays the modulation scheme detected in the analyzed signal. For signals using multiple modulation schemes, the modulation scheme with the highest data rate is displayed. The field also indicates the limits that are applied to the EVM results in the table or results.

This field is for information purposes only.

→ Remote: DEM:FORM:BAN?

Pilots for Tracking DL (Demod Settings dialog box, IEEE 802.16e-2005 OFDMA/WiBro)

Specifies how, for downlink signals, the pilot sequence is determined for tracking purposes.

According to Standard	The pilot sequence is computed according to the standard.
Detected	The pilot sequence uses the values detected in the signal.

→ Remote: TRAC:PIL DET

Pilots for Tracking UL (Demod Settings dialog box, IEEE 802.16e-2005 OFDMA/WiBro)

Displays how, for uplink signals, the pilot sequence is determined for tracking purposes.

This field is for information purposes only as tracking is performed according to the selected standard.

FFT start offset rel to CP center (Demod Settings dialog box, IEEE 802.16e-2005 OFDMA/WiBro)

Adds an offset to the FFT starting point determined by the application.

The setting range is from -100% to +100% of the cyclic prefix (CP) length. In the case of 0%, the optimal FFT starting point, determined by the application, is used. This is the default setting.

→ Remote: FFT:OFF 0

File Name (Demod Settings dialog box, IEEE 802.16e-2005 OFDMA/WiBro)

Displays the name of the loaded *.WIMAX settings file. If no file is loaded the '...' is displayed.

This field is for information purposes only.

IDCell (Demod Settings dialog box, IEEE 802.16e-2005 OFDMA/WiBro)

Specifies the downlink IDCell number and affects the definition of the preamble sequence (in conjunction with the used segments according to the **Used Subchannel Bitmap** setting), the pilot sequence of the first zone and the subchannel definition of the first zone.

→ Remote: CONF:WIM:DLSF:IDC 0

Preamble Mode (Demod Settings dialog box, IEEE 802.16e-2005 OFDMA/WiBro)

Specifies how the preamble index is calculated.

Auto The preamble index is automatically calculated according to the **IDCell** and **Used Subchannel Bitmap** parameters.

User The preamble index can be specified manually, i.e. the preamble pattern is chosen according to the standard using the **Preamble Index** parameter.

→ Remote: CONF:WIM:DLSF:PRE:MODE AUTO

Preamble Index (Demod Settings dialog box, IEEE 802.16e-2005 OFDMA/WiBro)

Specifies the preamble pattern (according to the standard) to be used, if the **Preamble Mode** parameter is set to **User**.

→ Remote: CONF:WIM:DLSF:PRE:IND 31

Used Subchannel Bitmap (Demod Settings dialog box, IEEE 802.16e-2005 OFDMA/WiBro)

Assigns subchannel groups to segments, see [802.16e-2005], page 360, table 268a "Subchannel index of the six subchannel groups". This table defines how many subchannels are available for the **Burst List (Frame Config tab)** belonging to the corresponding segment of a DL-PUSC zone (with Use All Subchannels being false). In the burst list - corresponding to the segment - this selection controls the height of the white area in the burst map.

→ Remote: CONF:WIM:DLSF:SEGM1 63

Frame Number (Demod Settings dialog box, IEEE 802.16e-2005 OFDMA/WiBro)

Specifies the number of the frame to be analyzed. For UL subframe analysis, the frame number must be constant for the signal to be analyzed.

→ Remote: CONF:WIM:ULSF:FRAM 0

Allocated Subchannel Bitmap (Demod Settings dialog box, IEEE 802.16e-2005 OFDMA/WiBro)

Specifies the subchannels to be analyzed.

This parameter is for information purposes only as all subchannels are used in the UL subframe.

List Zone/Burst (IEEE 802.16e-2005 OFDMA/WiBro)

Sets the focus on the **Zone/Segment List** or the **Burst List** to enter and modify data. To insert, copy, and delete rows, use the softkeys available with the **Frame Config** tab.

The content of the selected list is graphically displayed under the **Zone/Segment Map** and the **Burst Map** respectively.

The **Zone/Segment List** contains the following columns:

Column	Description
ID	Provides a unique ID for the zone. This parameter is read only. If there are any errors in the zone/segment configuration, the background is displayed in red color.
Bursts	Pressing the rotary knob or the ENTER key with focus on this field changes the focus to the Burst List and displays the Burst Map .

Column	Description
Analyze	Defines the zone/segment to be analyzed. Only one zone/segment can be selected for analysis at any given time.
Zone	Defines the zone type. The following types are supported: DL-PUSC, DL-FUSC, UL-PUSC
Segment	Defines the segment for a DL-PUSC zone. For DL-FUSC zones, this parameter has no effect.
Length	Defines the length in OFDMA symbols of the zone. The zone length must be a multiple of the symbol numbers per slot. If this is not the case, an error message is displayed in the status bar and the measurement does not start.
Offset	Defines the offset in OFDMA symbols from the start of the subframe. The first DL-PUSC zone starts with 1. The first UL-PUSC zone starts with 0.
PermBase	Specifies the permbase that is required for the calculation of the subchannel - physical carrier assignment permutation.
PRBS_ID	Specifies the permbase ID that is required for the calculation of the pilot sequence.

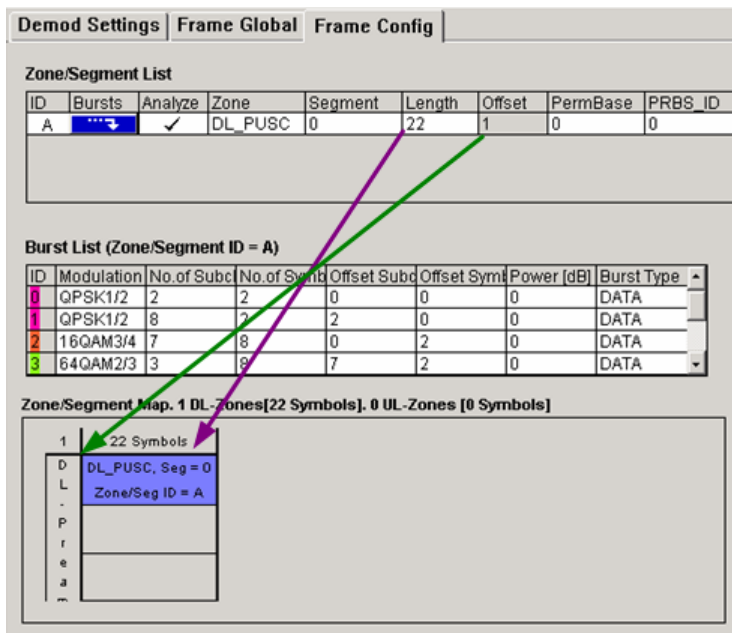

Fig. 4-54 Definition of the Zone Offset [green arrow] and the Zone Length [violet arrow] parameters from the Zone/Segment List

The **Burst List** contains the following parameters, depending on the zone selection:

Column	Description	Zone restrictions
ID	Provides a unique ID for the burst. This parameter is read only. The background color of this parameter reflects the modulation of the burst. If there are any errors in the burst configuration then the background of this item will be red.	
Modulation	Defines the modulation format of the burst. In the Burst Map , identical modulation formats are displays in the same color.	
No. of Subch.	Defines the number of logical subchannels occupied by the burst.	DL_FUSC, DL_PUSC
No. of Symb.	Defines the number of OFDMA symbols occupied by the burst. It must be a multiple of the symbol numbers per slot. If this is not the case, an error message is displayed in the status bar and the measurement does not start.	DL_FUSC, DL_PUSC

Duration [Slots]	Specifies the unit of time for the allocating bandwidth.	UL_PUSC
Auto	If selected, the Offset Subch. and the Offset Symb. parameters are set automatically.	UL_PUSC
Offset Subch.	Defines the offset in logical subchannels from subchannel 0.	
Offset Symb.	Defines the offset in OFDMA symbols. It must be a multiple of the number of symbols per slot. If this is not the case, an error message is displayed in the status bar and the measurement does not start. The start of the zone defines symbol 0.	
Power[dB]	Defines the boosting factor of the burst.	
Burst Type	Defines the burst type from the protocol layer perspective.	DL_FUSC, DL_PUSC

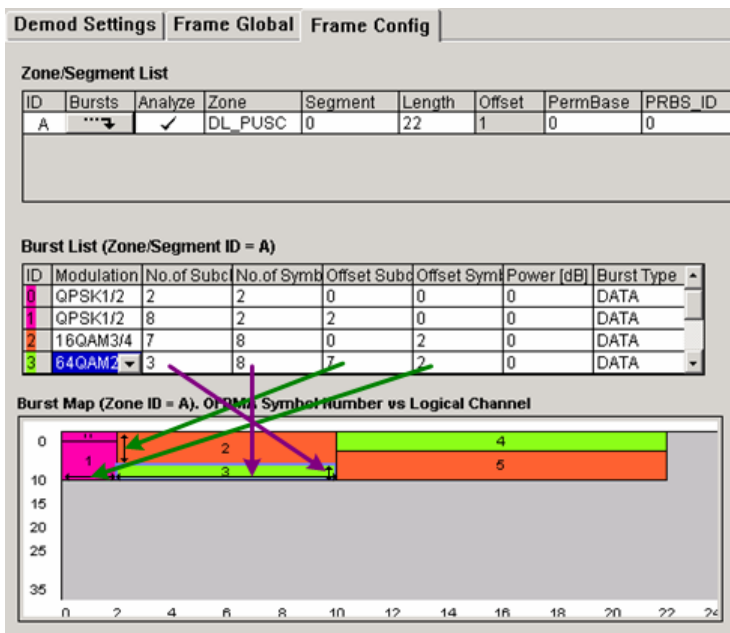

Fig. 4-55 Definition of the Burst Offset [green arrows] and the Burst Length [violet arrows] parameters from the Burst List

The **Zone/Segment Map** and the **Burst Map** display panes are located at the bottom of the **Frame Config** tab. They display a graphical view of the selected **Zone/Segment List**.

– **Zone/Segment Map**

Displays a graphical view of the selected **Zone/Segment List**.

– **Burst Map**

Displays a graphical view of the selected **Burst List**. The background color of each burst in the diagram match the modulation format of the burst. Any burst that is incorrectly configured is displayed with a red background. The measurement does only start if the frame definition is correct.

Example:

The **Burst Map** with burst 1 exceeds the available amount of logical subchannels. The area causing the problem is highlighted red.

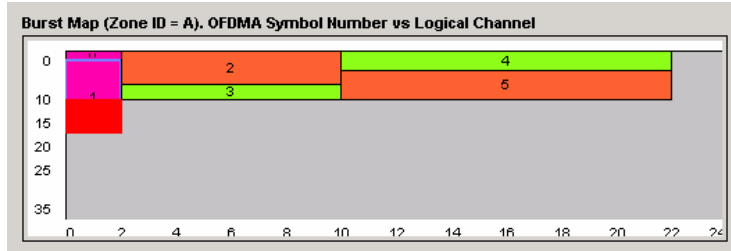

The configuration is corrected by doing one of the following:

- a) Reducing the number of subchannels for burst 1 in the **Burst List**.
- b) Assigning more subchannels to the zone/segment to which burst 1 belongs.
- c) Increasing N_{FFT} .

→ Remote: `CONF:WIMax:ZONE<1...26> . . .`, for details see **CONF:WIMax:ZONE** Subsystem (WiMAX/WiBro, K93)

Copy Zone/Burst (IEEE 802.16e-2005 OFDMA/WiBro)

Copies the selected zone or burst to the clipboard.

Insert Zone/Burst (IEEE 802.16e-2005 OFDMA/WiBro)

Pastes the zone or burst below the focused zone or burst.

New Zone/Burst (IEEE 802.16e-2005 OFDMA/WiBro)

Inserts a new zone or burst below the focused zone or burst.

- Remote: `CONF:WIM:ZONE1:CONT ON,DLFUSC,0,10,0,0,0` (zone)
- Remote: `CONF:WIM:ZONE1:BURS1:CONT QAM16_1_2,1D2,5,10,20,0,0,0, DATA` (burst)

New Segment (IEEE 802.16e-2005 OFDMA/WiBro)

Inserts a new segment below the focused zone/segment. This softkey is only available, if the focus is on the **Zone/Segment List**.

Delete Zone/Burst (IEEE 802.16e-2005 OFDMA/WiBro)

Deletes the focused zone or burst.

- Remote: `CONF:WIM:ZONE1:DEL` (zone)
- Remote: `CONF:WIM:ZONE1:BURS1:DEL` (burst)

Display Graph/List

Configures the result display. The measurement results are displayed either in form of a list of measurement points or as a graphical trace.

For details on the result displays refer to "[Result summary list](#)" on page 4.426 and "[Result display graph](#)" on page 4.428.

- Remote: DISP: TABL OFF
- Remote: for result queries see section FETCh Subsystem

PVT

Opens the PVT submenu to select the Power vs Time measurement results.

The PVT result displays show the measured input data over the full range or over complete bursts, displayed within the gating lines if gating is switched on. The results are displayed as a single burst. If the gate start or gate length are altered then the results can be updated to reflect these changes by pressing the **Refresh** softkey in the sweep menu.

- Remote: CONF: BURS: PVT

Full Burst (IEEE 802.16-2004 OFDM)

Displays the PVT results in a single graph with all burst data being displayed (**Display Graph** selected), or in a list (**Display List** selected).

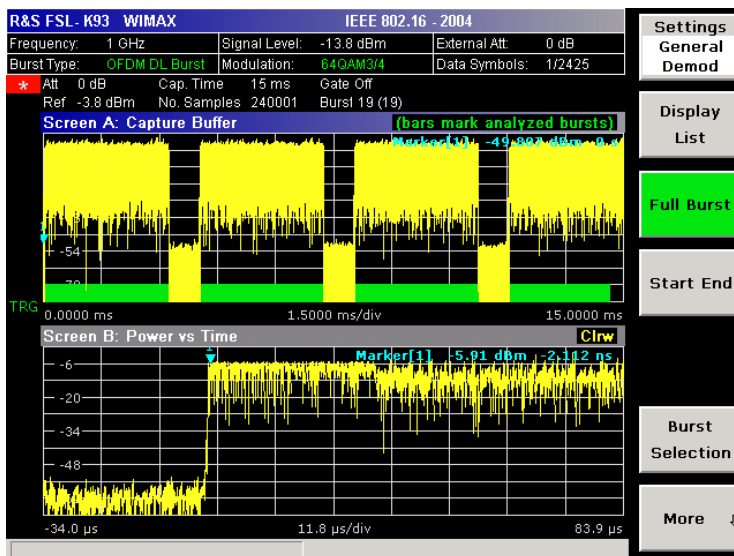

For further details refer to the PVT softkey.

- Remote: CONF: BURS: PVT: SEL FULL

Start End (IEEE 802.16-2004 OFDM)

Displays the results in two separate graphs, the left hand side showing the start and the right hand side showing the end of a burst (**Display Graph** selected), or in a list (**Display List** selected).

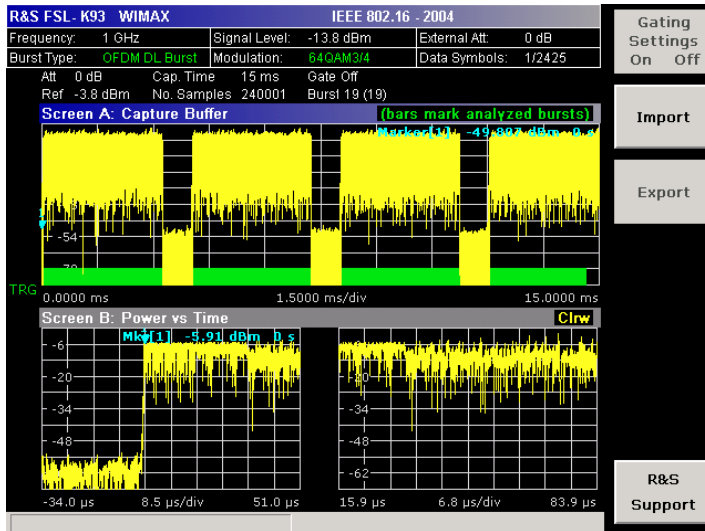

→ Remote: CONF : BURS : PVT : SEL EDGE

Burst Selection (IEEE 802.16-2004 OFDM)

Opens an edit dialog box to select a burst by entering its number.

→ Remote: CONF : BURS : PVT : BURS 1

Full Subframe (IEEE 802.16e-2005 OFDMA/WiBro)

Displays the results in a single graph with the minimum, mean, and maximum power profile of the subframe that contains the zone selected to be analyzed (**Display Graph** selected), or in two lists (**Display List 1/2** selected).

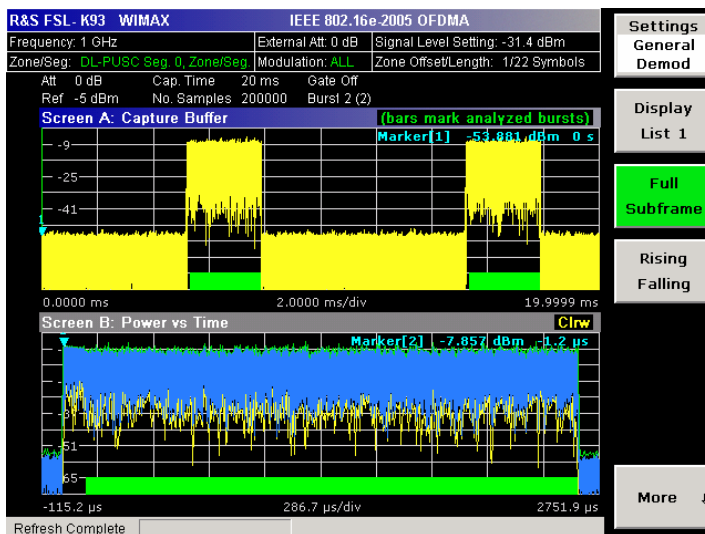

→ Remote: CONF : BURS : PVT : SEL FULL

Rising/Falling (IEEE 802.16e-2005 OFDMA/WiBro)

Displays the results in two separate graphs: the minimum, mean, and maximum power profile of rising (on the left hand) respective falling (on the right hand) edge of the subframe that contains the zone selected to be analyzed (**Display Graph** selected), or in two lists (**Display List 1/2** selected).

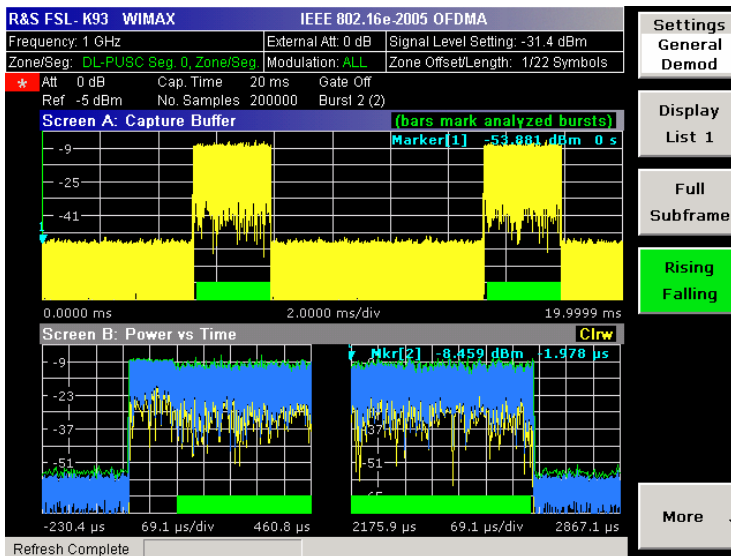

→ Remote: CONF : BURS : PVT : SEL EDGE

Gating Settings On/Off (Spectrum Mask, Spectrum FFT, Spectrum ACPR, CCDF)

Activates or deactivates gating, or opens the **Gate Settings** dialog box to specify range of captured data used in results calculation.

Gate Settings		
	Time	Samples
Delay	129 μs	2579
Length	196 μs	3920
Link Gate and Marker	<input type="checkbox"/>	

- On Uses only the specified range of captured data in results calculation. In the Magnitude Capture Buffer trace, two vertical lines mark the specified range.
- Off Uses all the captured data in results calculation.

In the **Gate Settings** dialog box, the following parameters are set:

- Delay** Start point of captured data to be used in results calculation, i.e. the delay from the start of the captured data in time or samples. If the delay is specified in time, the number of samples is updated accordingly, and vice versa.
- Length** Amount of captured data to be used in results calculation. If the length is specified in time, the number of samples is updated accordingly, and vice versa.
- Link Gate and Marker** If activated, the position of the marker and the gate lines are linked. The marker is positioned half way between gate start and end. The marker position alters if the gate is modified, and the gate lines move with the marker if the marker position is altered.

The gate settings are defined for following measurements: Spectrum FFT, CCDF, Spectrum Mask, Spectrum ACPR.

If a frequency sweep measurement is active (Spectrum Mask and Spectrum ACP), the result display is switched to the Magnitude Capture Buffer display in order to help defining the gate settings correctly.

- Remote: SWE:EGAT ON
- Remote: SWE:EGAT:HOLD 125us, SWE:EGAT:HOLD:SAMP 2500 (Delay)
- Remote: SWE:EGAT:LENG 100ms, SWE:EGAT:LENG:SAMP 2000000 (Length)
- Remote: SWE:EGAT:LINK ON (Link Gate and Mark)

SEM Settings (IEEE 802.16e-2005 WiBro)

Opens the **Spectrum Emission Mask Settings** dialog box to configure the Spectrum Emission Mask measurement.

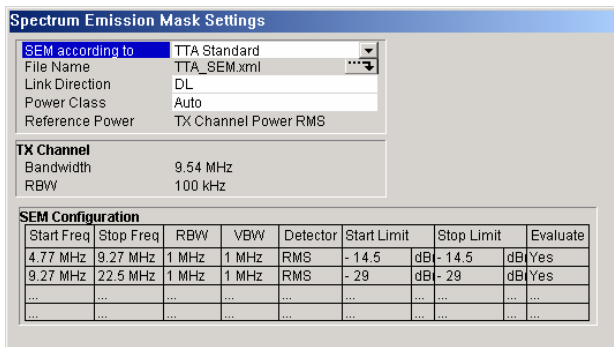

SEM according to Specifies how the Spectrum Emission Mask settings and limits are applied:

TTA Standard - as specified in the standard.

User - as specified in the selected XML file

File Name Specifies the XML file name

Link Direction Sets the link direction:

UL - uplink, **DL** - downlink

Power Class Sets the power class:

Auto - automatic selection

(-INF, 23) dBm, (23, INF) dBm - power class values for uplink

(-INF, 29) dBm, (29, 40) dBm, (40, INF) dBm - power class values for downlink

The other parameters are set by default.

The **SEM Configuration** shows the settings and limits applied over specified frequency ranges around the TX channel. The settings displayed are dependent on the selected **Link Direction** and **Power Class**.

This softkey is available from firmware version 1.60.

- Remote: POW:SEM:TTA STANDARD (SEM according to)
- Remote: POW:SEM:MOD UL (Link Direction)
- Remote: POW:SEM:CLAS 0 (Power Class)

Import

Opens the **Choose iqw file to import** dialog box.

Enter the path and the name of the IQ data file you want to import. Focus the **Select** button and press **ENTER** to load the specified IQ data file. The **Select** button becomes active only, if the entered name matches a file name in the selected directory.

→ Remote: MMEM:LOAD:IQ:STAT 1, 'C:\R_S\Instr\user\data.iqw'

Export

Opens the **Choose iqw file to export** dialog box.

Enter the path and the name of the IQ data file you want to export. Press **ENTER** to write the IQ data into the specified file. If the file cannot be created or there is no valid IQ data to export an error message is displayed.

→ Remote: MMEM:STOR:IQ:STAT 1, 'C:\R_S\Instr\user\data.iqw'

R&S Support

Creates files that help identifying the current problem. The files are stored under C:\R_S\Instr\user\Support. If you contact the Rohde&Schwarz support to get help for a certain problem, send these files to the support in order to identify and solve the problem faster.

EVM Constell

Opens a submenu to select the error vector magnitude (EVM) or the constellation result displays.

EVM vs Symbol/Carrier

Selects the EVM vs Symbol or EVM vs Carrier result displays.

- EVM vs Symbol (IEEE 802.16-2004 OFDM)

This result display shows the EVM measured over the full range of the measured input data. The results are displayed on a per-symbol basis, with blue vertical lines marking the boundaries of each burst. Note that burst boundary lines are only displayed if the number of analyzed bursts is less than 250. The minimum, average, and maximum traces are displayed.

For the trace labeled with EVM a commonly used EVM definition is applied, which is the square root of the momentary error power normalized by the averaged reference power. For details of this measurements please refer to chapter 2.

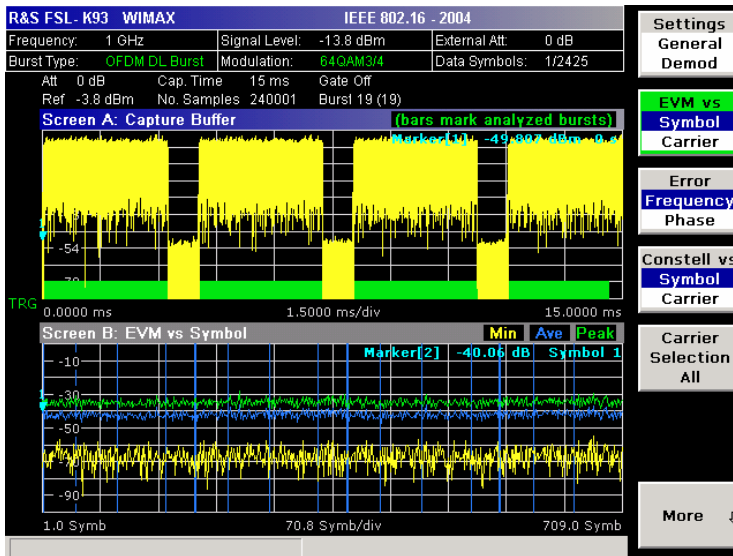

– EVM vs Symbol (IEEE 802.16e-2005 OFDMA/WiBro)

This result display shows all EVM values versus the symbols of the analyzed zone. If the capture buffer contains more than one analyzed zones, the corresponding result graphs will be appended. The minimum, mean, and maximum statistics is performed over carriers.

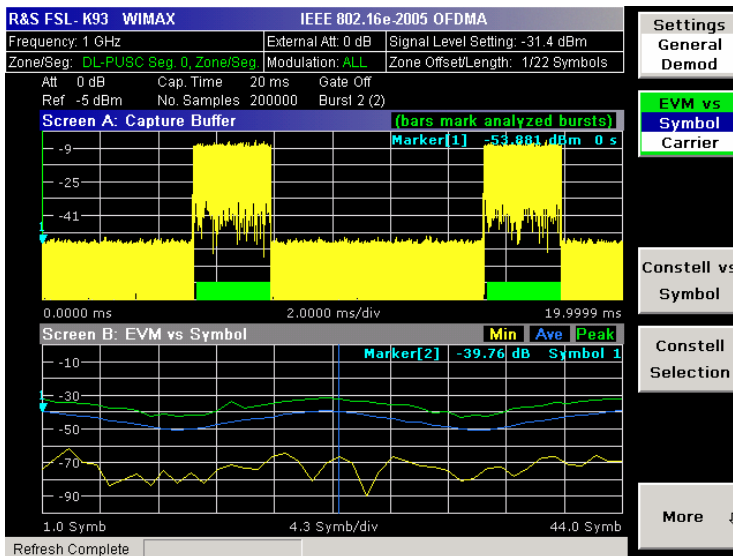

– EVM vs Carrier (IEEE 802.16-2004 OFDM)

This result display shows all EVM values recorded on a per-carrier basis over the full set of measured data. The minimum, average and maximum traces are displayed.

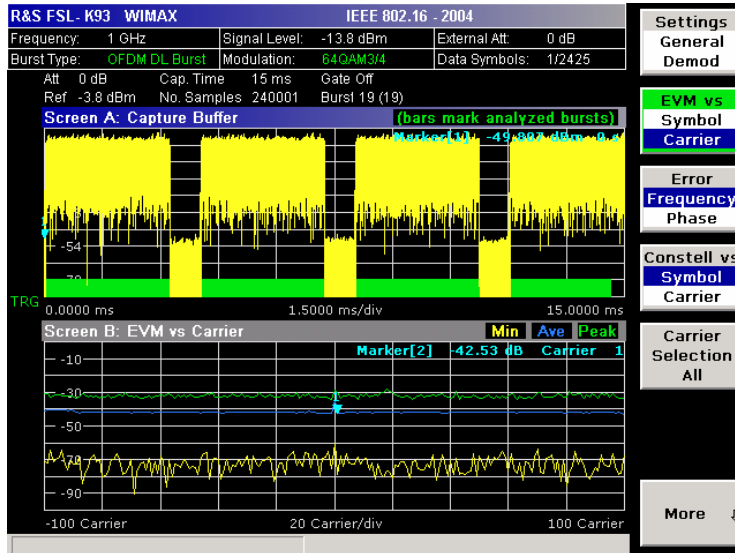

– EVM vs Carrier (IEEE 802.16e-2005 OFDMA/WiBro)

This result display shows all EVM values versus the physical carriers. The minimum, mean, and maximum statistics is performed over the symbols of all analyzed zones in the capture buffer.

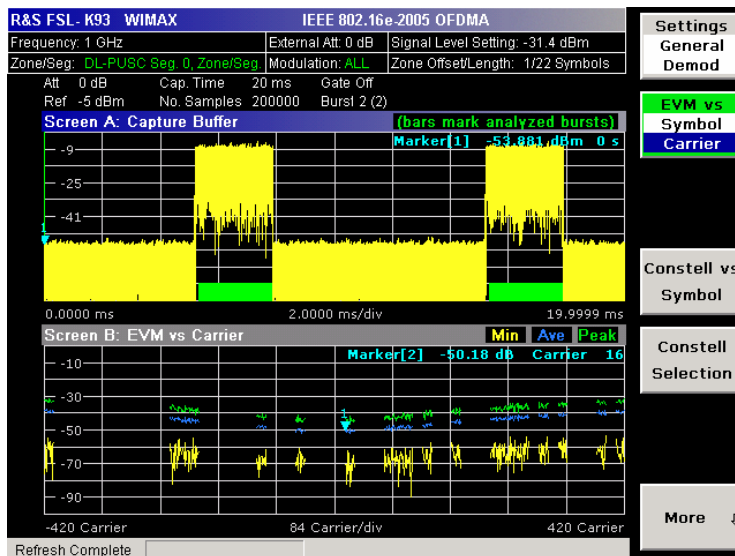

→ Remote: CONF : BURS : EVM : ESYM (EVM vs Symbol)

→ Remote: CONF : BURS : EVM : ECAR (EVM vs Carrier)

Error Frequency/Phase (IEEE 802.16-2004 OFDM)

Selects the Frequency Error vs Preamble or the Phase Error vs Preamble result displays.

These result displays show the error values recorded over the preamble part of the burst. A minimum, average and maximum trace are displayed. The results display either relative frequency error or phase error.

Using the **Y-Axis/Div** softkey, the scaling of the y-axis can be modified to allow the results to be scaled to an optimum level.

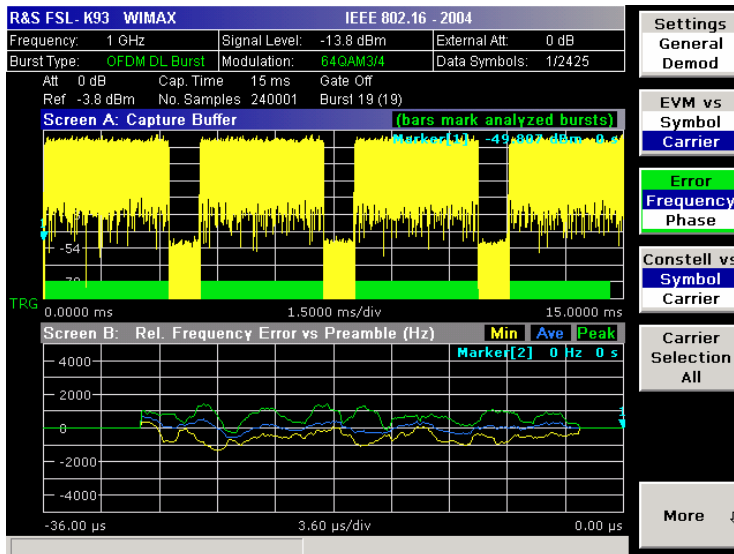

- Remote: CONF: BURS: PRE
- Remote: CONF: BURS: PRE: SEL FREQ (Frequency Error vs Preamble)
- Remote: CONF: BURS: PRE: SEL PHAS (Phase Error vs Preamble)

Constell vs Symbol/Carrier

Selects the Constellation vs Symbol or the Constellation vs Carrier result displays.

- Constellation vs Symbol (IEEE 802.16-2004 OFDM)

This result display shows the in-phase and quadrature phase results over the full range of the measured input data. The ideal points for the selected modulations scheme are displayed for reference purposes.

The amount of data displayed in the Constellation result display can be reduced by selecting the carrier or carriers for which data is to be displayed (**Carrier Selection** softkey).

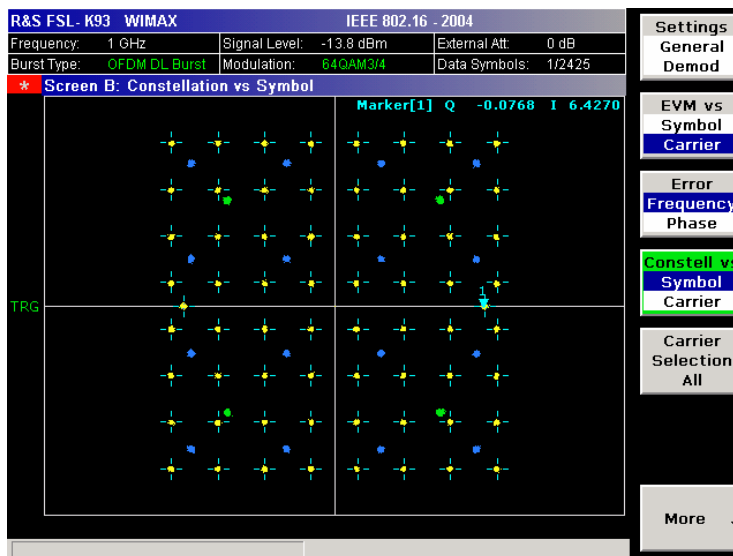

- Constellation vs Symbol (IEEE 802.16e-2005 OFDMA/WiBro)

This result display shows the complex constellation diagram of the modulation symbols. The modulation symbols belong to the bursts of the analyzed zone. The different modulation formats are displayed in unique colors. The same color assignment is used in the Bitstream result display.

The amount of data displayed in the Constellation result display can be reduced via the **Constell Selection** softkey.

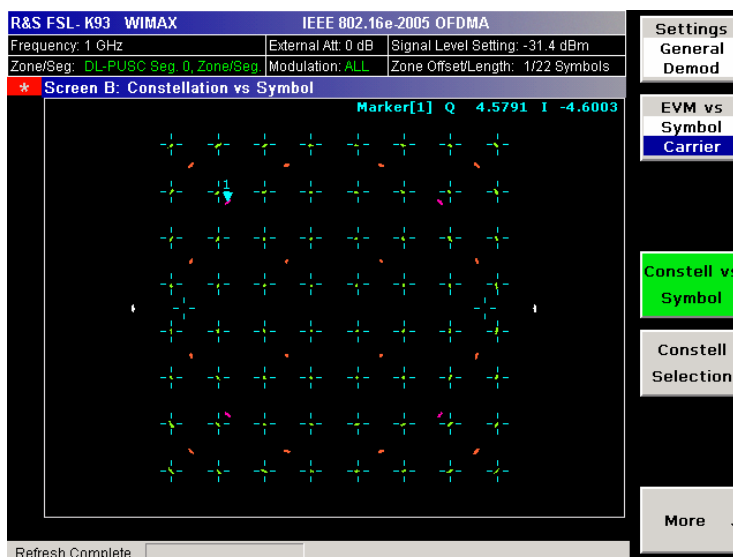

– Constellation vs Carrier (IEEE 802.16-2004 OFDM)

This result display shows the in-phase and quadrature phase results over the full range of the measured input data plotted on a per-carrier basis. The magnitude of the in-phase and quadrature part is shown on the y-axis, both are displayed as separate traces (I-> trace 1, Q-> trace 2).

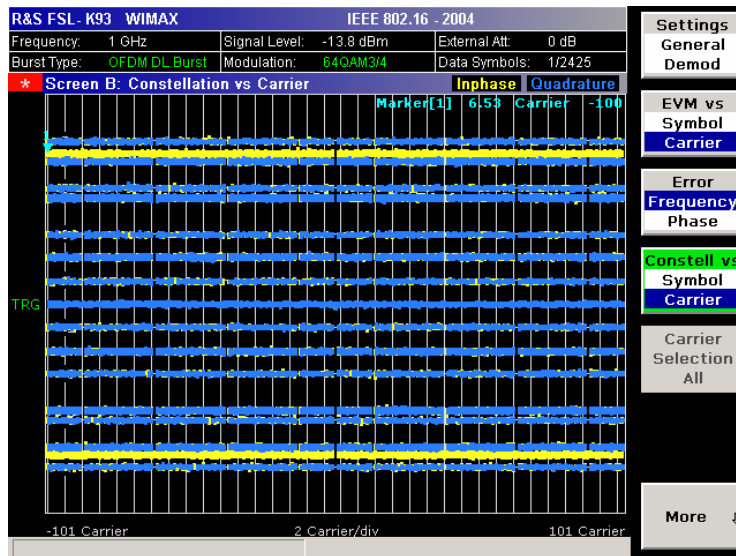

- Remote: CONF : BURS : CONS : CSYM (Constellation vs Symbol)
- Remote: CONF : BURS : CONS : CCAR (Constellation vs Carrier)

Carrier Selection (IEEE 802.16-2004 OFDM)

Opens a dialog box to select the carrier for data display. Either a specific carrier number, pilots only or all carriers can be selected.

- Remote: CONF : BURS : CONS : CARR : SEL -26

Constell Selection (IEEE 802.16e-2005 OFDMA/WiBro)

Opens a dialog box for filtering the displayed results. The results may be filtered by any combination of modulation, burst, symbol, or carrier. If the constellation selection parameters are changed, the result display is updated accordingly.

- Remote: CONF : BURS : CONS : SYMB : SEL 1 (symbol)
- Remote: CONF : BURS : CONS : FORM : SEL QPSK (modulation)
- Remote: CONF : BURS : CONS : BURS : SEL 1 (burst)

Y-Axis/Div (EVM vs Symbol/Carrier, Error Frequency/Phase)

Opens a dialog box to modify the y-axis settings:

- Auto Scaling** If activated, the scaling of the y-axis is calculated automatically.
- Per Division** Specifies the scaling to be used if **Auto Scaling** is deactivated.
- Unit** Specifies the y-axis unit.

This softkey is only available for the above mentioned measurements if trace data are displayed.

- Remote: DISP:WIND2:TRAC1:Y:AUTO ON (Auto Scaling)
- Remote: DISP:WIND2:TRAC1:Y:PDIV 2 (Per Division)
- Remote: UNIT:EVM PCT (Unit - EVM vs Symbol/Carrier)
- Remote: UNIT:PRE HZ (Unit - Error Frequency/Phase)

Spectrum

Opens a submenu for frequency measurements.

Spectrum Flat./Diff./Group Delay

Sets the Spectrum Flatness result displays in graphical form (**Display Graph** selected), or in tabular form (**Display List 1/2** selected).

- Spectrum Flatness and Spectrum Flatness Group Delay (IEEE 802.16-2004 OFDM)

These result displays show either the Spectrum Flatness or the Group Delay values recorded on a per-carrier basis over the full set of measured data. A minimum, average and maximum trace are displayed for each of the result types. If the Spectrum Flatness result display is selected an upper and lower limit line representing the limits specified for the selected standard are displayed. An overall pass/fail status is displayed for the obtained (average) results against these limit lines.

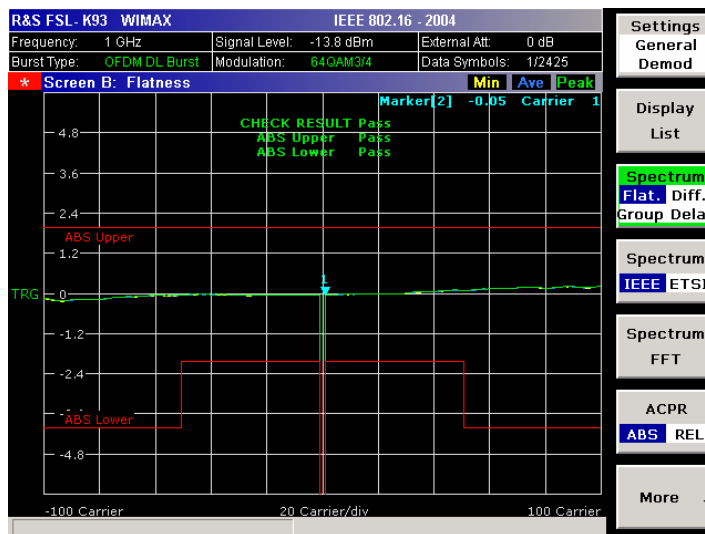

- Spectrum Flatness and Spectrum Flatness Group Delay (IEEE 802.16e-2005 OFDMA/WiBro)

This result display shows the average energy of the constellations for the physical carriers. The limit lines are displayed according to the requirements of the standard. The minimum, mean, and maximum statistics is performed over the analyzed zones in the capture buffer.

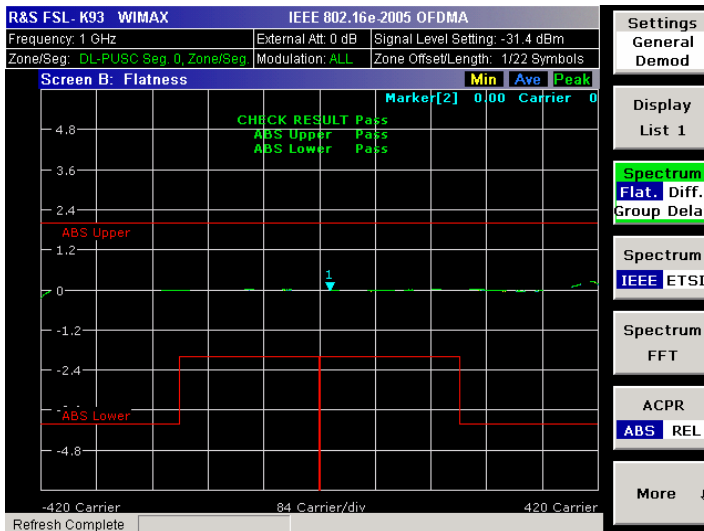

- Spectrum Flatness Difference (IEEE 802.16-2004 OFDM)

This result display shows the adjacent carrier power difference of the preamble part of the burst. A minimum, average and maximum trace are displayed.

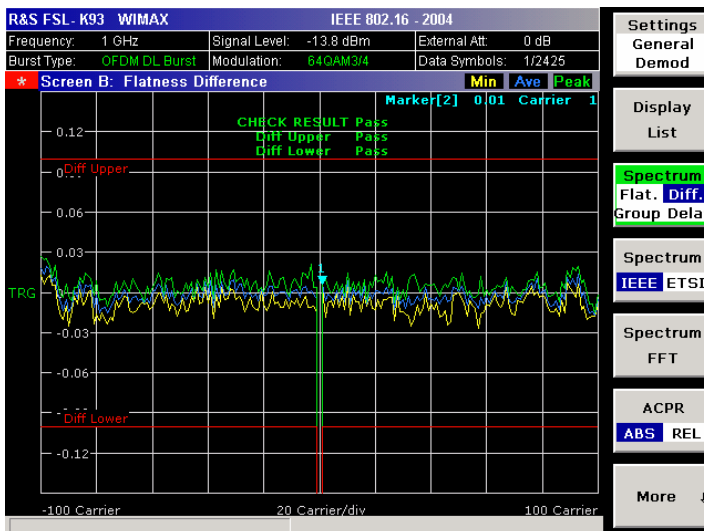

- Spectrum Flatness Difference (IEEE 802.16e-2005 OFDMA/WiBro)

This result display shows the absolute difference of adjacent carriers. The limit lines are displayed according to the requirements of the standard. The minimum, mean, and maximum statistics is performed over the analyzed zones in the capture buffer.

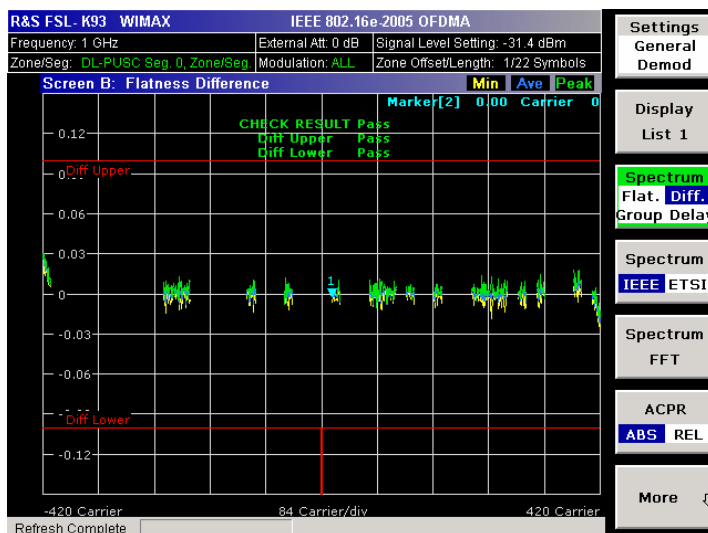

- Remote: CONF:BURS:SPEC:FLAT
- Remote: CONF:BURS:SPEC:FLAT:SEL FLAT (Spectrum Flatness)
- Remote: CONF:BURS:SPEC:FLAT:SEL GRD (Spectrum Flatness Group Delay)
- Remote: CONF:BURS:SPEC:FLAT:SEL DIFF (Spectrum Flatness Difference)

Spectrum IEEE/ETSI (IEEE 802.16-2004 OFDM, IEEE 802.16e-2005 OFDMA) / Spectrum Mask (IEEE 802.16e-2005 WiBro)

Sets the Spectrum (Emission) Mask result display. For the IEEE 802.16-2004 OFDM, IEEE 802.16e-2005 OFDMA standards, the result is displayed in graphical form (**Display Graph** selected), or in tabular form (**Display List 1/2** selected). For the IEEE 802.16e-2005 WiBro standard, graph and table are displayed combined.

This result display shows power against frequency. A limit line representing the spectrum mask specified for the selected standard is displayed and an overall pass/fail status is displayed for the obtained results against this limit line.

For the IEEE 802.16-2004 OFDM, IEEE 802.16e-2005 OFDMA standards, the span of the results is related to the specified sample rate.

For the IEEE 802.16e-2005 WiBro standard, the table contains the results for each of the individual frequency ranges. On the trace, the highest power value is marked for each of the specified frequency ranges with a marker.

The number of sweeps is set in the **General Settings** dialog box, **Sweep Count** field. If the measurement is performed over multiple sweeps both a max hold trace and an average trace are displayed. For the IEEE 802.16e-2005 WiBro standard, the Spectrum Emission Mask measurement is configured via the **SEM Settings** softkey.

- Spectrum IEEE (IEEE 802.16-2004 OFDM)

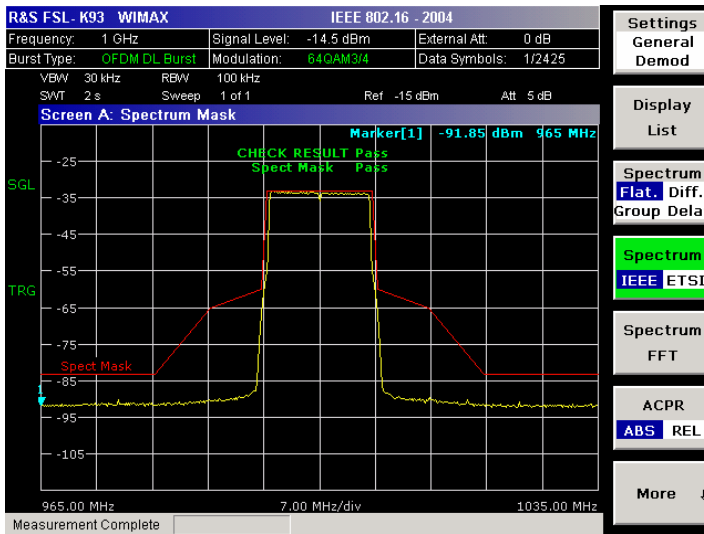

- Spectrum IEEE (IEEE 802.16e-2005 OFDMA)

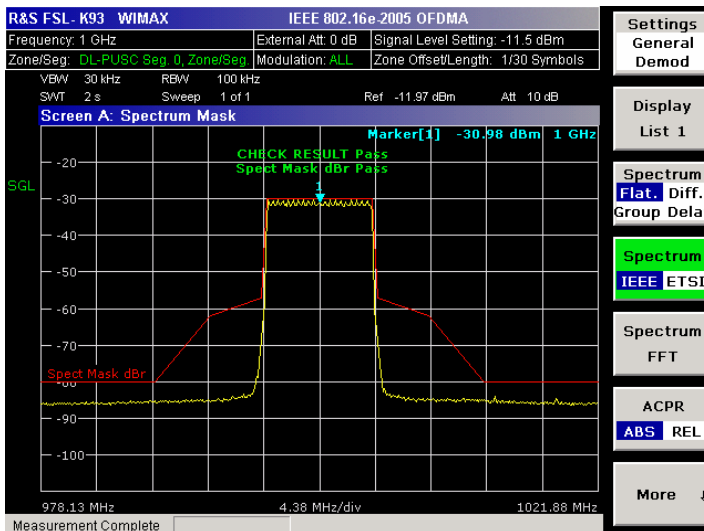

- Spectrum ETSI (IEEE 802.16-2004 OFDM)

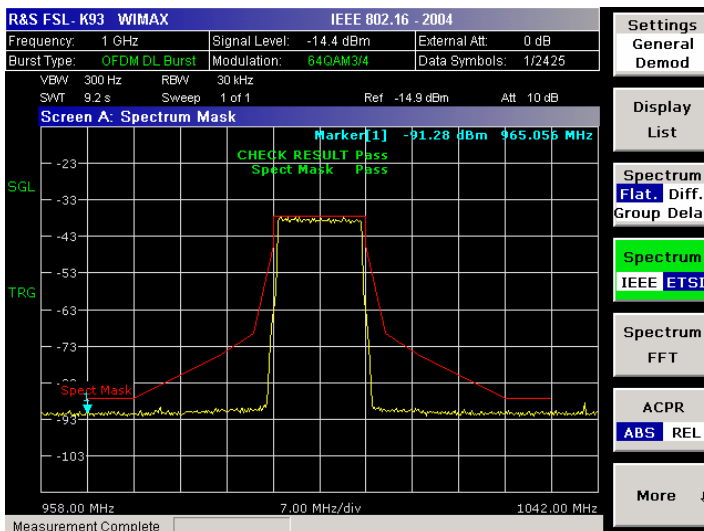

- Spectrum ETSI (IEEE 802.16e-2005 OFDMA)

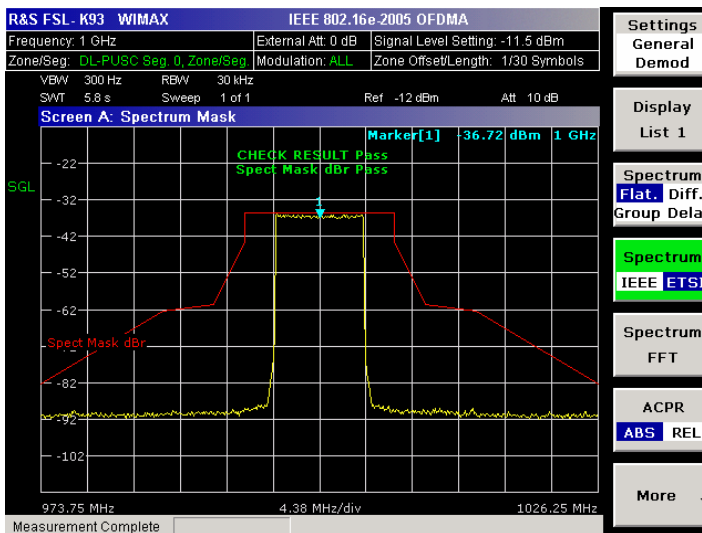

- IEEE 802.16e-2005 WiBro

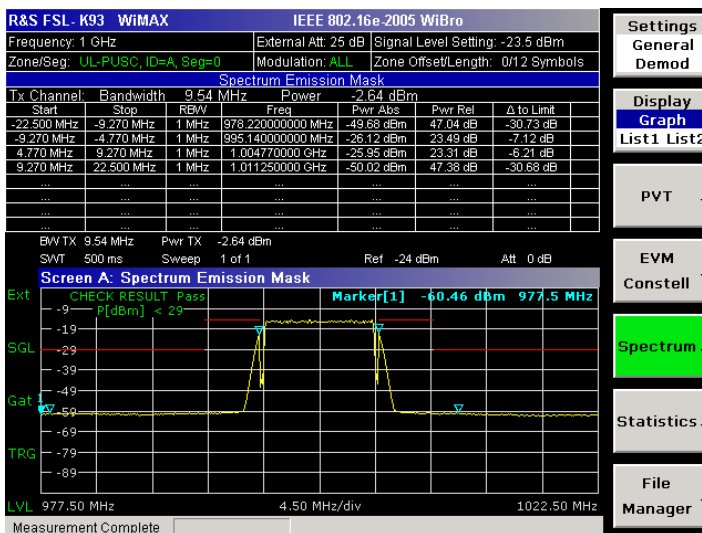

- Remote: CONF : BURS : SPEC : MASK
- Remote: CONF : BURS : SPEC : MASK : SEL IEEE
- Remote: CONF : BURS : SPEC : MASK : SEL ETSI

Spectrum FFT

Sets the Spectrum FFT result display in graphical form (**Display Graph** selected), or in tabular form (**Display List 1/2** selected).

This result display shows the Power vs Frequency results obtained from a FFT performed over the range of data in the Magnitude Capture Buffer which lies within the gate lines. If the gate start or gate length are altered then the results can be updated to reflect these changes by pressing the **Refresh** softkey in the sweep menu.

- IEEE 802.16-2004 OFDM

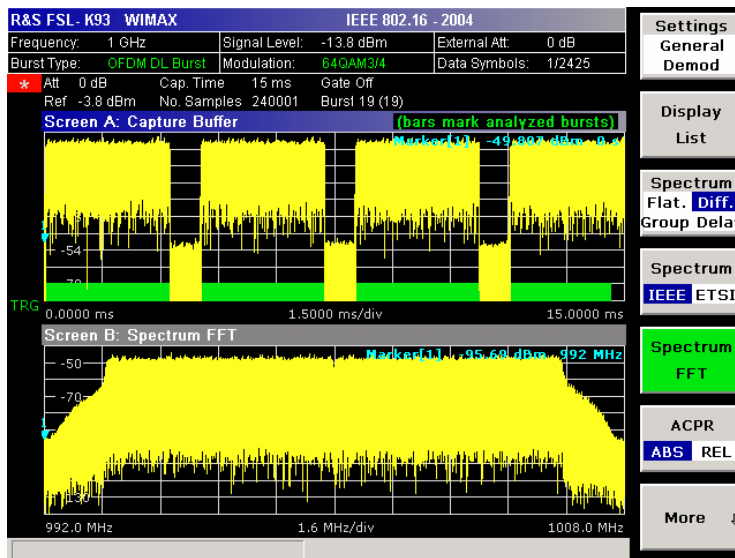

- IEEE 802.16e-2005 OFDMA/WiBro

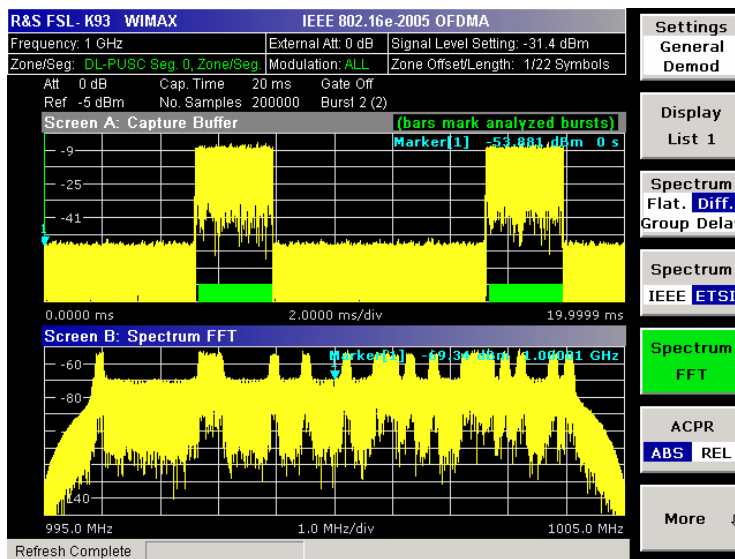

→ Remote: CONF : BURS : SPEC : FFT

ACPR Abs/Rel

Sets the ACPR (Adjacent Channel Power Relative) result display in graphical form (**Display Graph** selected), or in tabular form (**Display List 1/2** selected).

This result display is similar to the Spectrum Mask measurement, and provides information about leakage into adjacent channels. The results show the relative power measured in the three nearest channels either side of the measured channel. This measurement is the same as the adjacent channel power measurement provided by the spectrum analyzer.

The number of sweeps is set in the **General Settings** dialog box, **Sweep Count** field. If the measurement is performed over multiple sweeps both a max hold trace and an average trace are displayed.

– IEEE 802.16-2004 OFDM

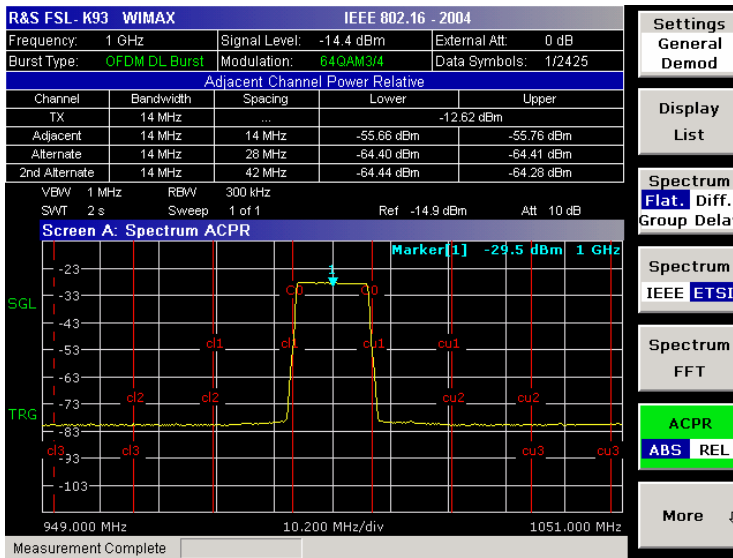

– IEEE 802.16e-2005 OFDMA/WiBro

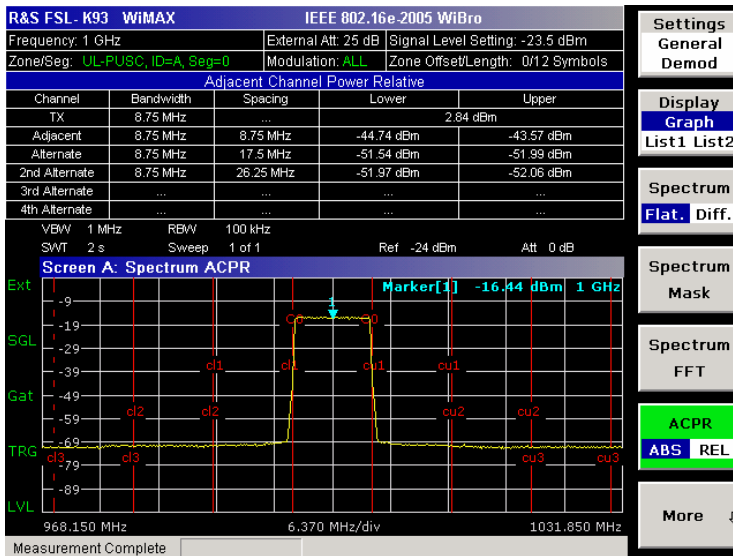

- Remote: CONF : BURS : SPEC : ACPR
- Remote: CONF : BURS : SPEC : ACPR : SEL ABS
- Remote: CALC2 : MARK : FUNC : POW : RES? (result query)
- Remote: CALC2 : MARK : FUNC : POW : RES : MAXH? (result query)

ACP Settings

Opens the **ACP Settings** dialog box to configure the ACPR result display. By default, the ACP settings are derived from the **General Settings** dialog box, **Channel BW** field.

Pane	Field	Description
Channels	No. of Channels	Specifies the number of channels adjacent to the transmit channel to be measured. If set to 0, only the transmit channel is measured.

Pane	Field	Description
TX/ACP Channel BW	TX	Specifies the bandwidth of the transmit channel to be measured by the ACP measurement.
	Adjacent, Alternate 1, Alternate 2, Alternate 3, Alternate 4	Specifies the bandwidth of the first to fifth channel before and after the transmit channel to be measured.
ACP Channel Spacing	Adjacent, Alternate 1, Alternate 2, Alternate 3, Alternate 4	Specifies the spacing of the first to fifth channel before and after the transmit channel to be measured.

- Remote: POW:ACH:ACP 3 (No. of Channels)
- Remote: POW:ACH:BAND 30kHz (TX)
- Remote: POW:ACH:SPAC 33kHz (Adjacent/TX)
- Remote: POW:ACH:SPAC:ALT1 100kHz (Alternate 1 to 4/TX)
- Remote: POW:ACH:BAND:ACH 30kHz (Adjacent)
- Remote: POW:ACH:BAND:ALT2 30kHz (Alternate 1 to 4)

Statistics

Opens a submenu to display statistics measurement results.

CCDF

Sets the CCDF result display in graphical form (**Display Graph** selected), or in tabular form (**Display List 1/2** selected).

This result display shows the probability of an amplitude within the gating lines exceeding the mean power measured between the gating lines. The x-axis displays power relative to the measured mean power.

If the gate start or gate length are altered then the results can be updated to reflect these changes by pressing the **Refresh** softkey in the sweep menu.

- IEEE 802.16-2004 OFDM

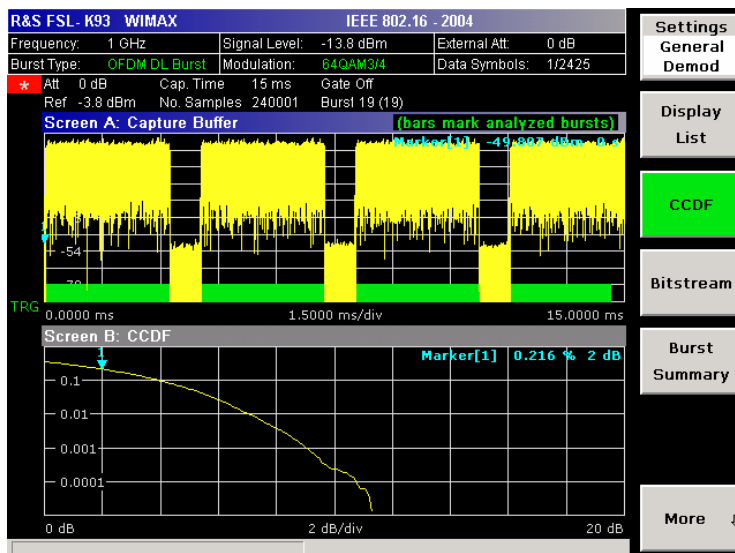

- IEEE 802.16e-2005 OFDMA/WiBro

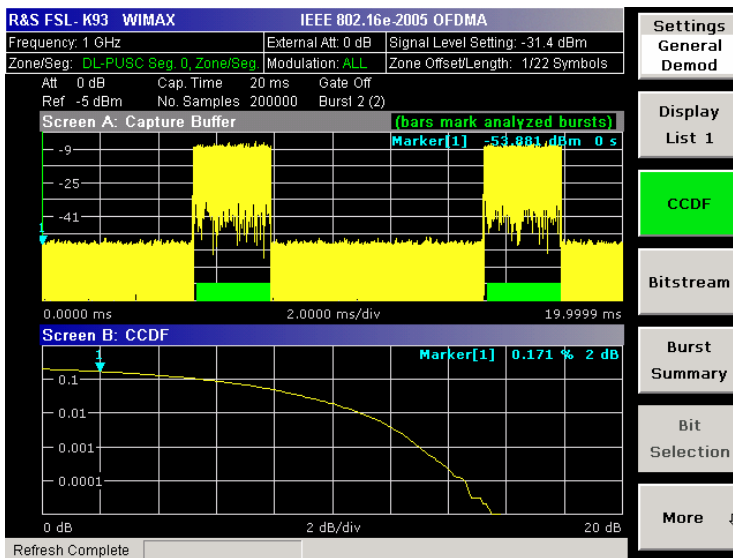

→ Remote: CONF: BURS: STAT: CCDF

Bitstream

Sets the Bitstream result display in graphical form (**Display Graph** selected), or in tabular form (**Display List 1/2** selected).

- IEEE 802.16-2004 OFDM

This result display shows the demodulated data stream. These results are grouped by burst and symbol. If no dialog boxes are displayed, the results can be scrolled through using the cursor keys or rotary knob.

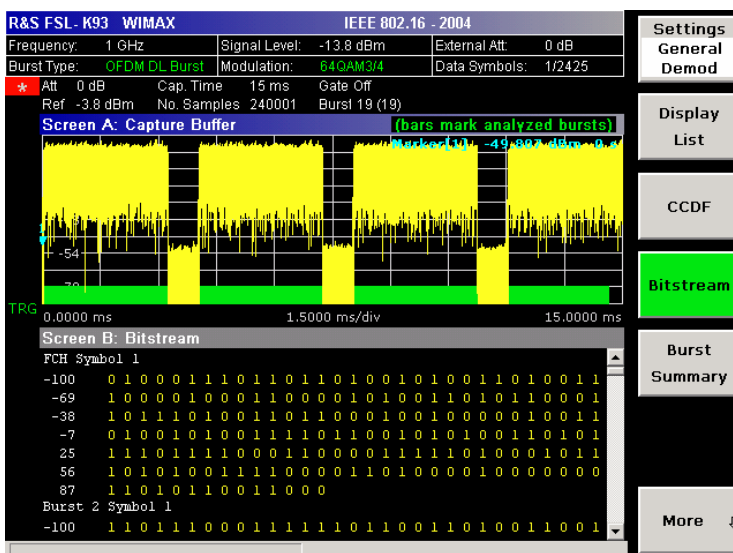

- IEEE 802.16e-2005 OFDMA/WiBro

This result display shows the modulation symbols of the bursts from the analyzed zone. The different modulation formats are displayed in unique colors. The same color assignment is used in the Constellation vs Symbol result display. The modulation symbols define bit sequences. The mapping is defined in the standard. Signals with erroneous pilot sequences (i.e where the

detected pilot sequence does not match that according to the standard) are highlighted with a red background.

The amount of data displayed in the Bitstream result display can be reduced via the **Bit Selection** softkey.

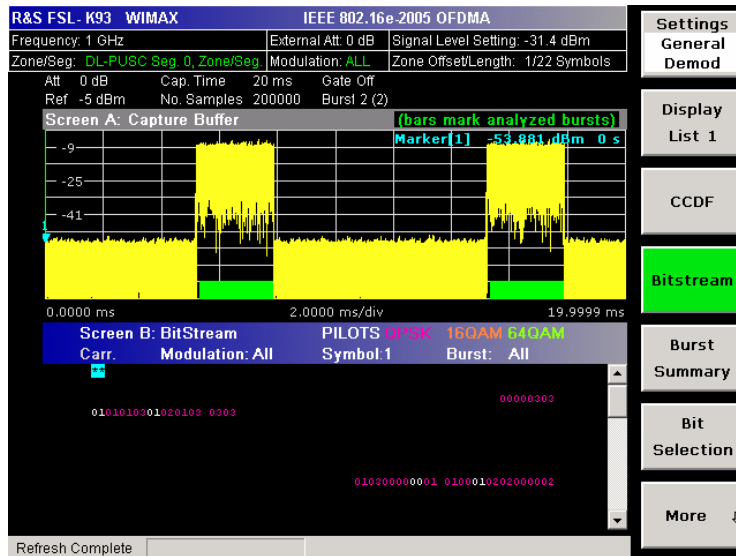

→ Remote: CONF : BURS : STAT : BSTR

Burst Summary

This result display shows the summary data for the analyzed bursts. If no dialog boxes are displayed, the results can be scrolled through using the cursor keys or rotary knob.

- IEEE 802.16-2004 OFDM

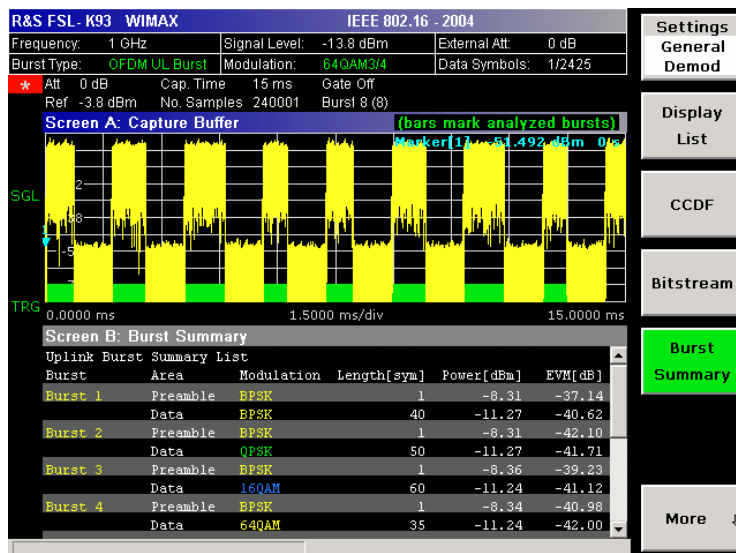

- IEEE 802.16e-2005 OFDMAWiBro

This result display provides information about the bursts from the analyzed zone, i.e. modulation of the burst, power boosting information, EVM of the burst. Each analyzed zone will produce a set of burst results.

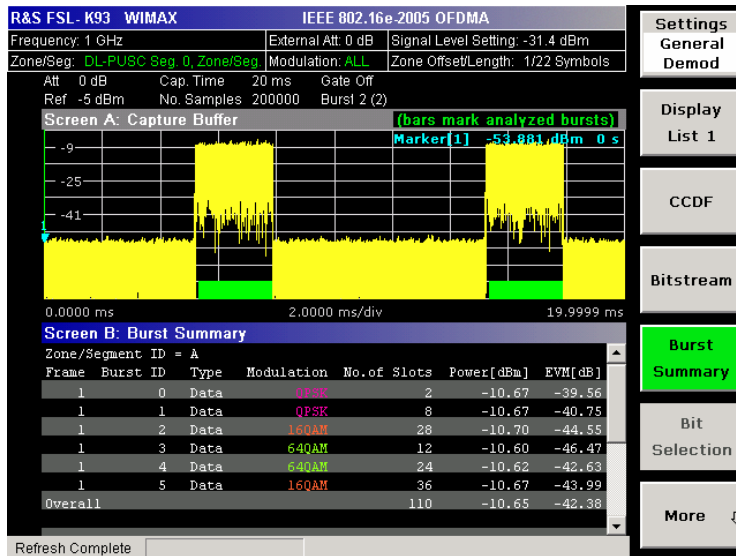

→ Remote: CONF: BURS: STAT: BSUM

Bit Selection (IEEE 802.16e-2005 OFDMA/WiBro)

Opens a dialog box for filtering the displayed results. The results may be filtered by any combination of modulation, symbol or burst. If the bit selection parameters are changed, the result display is updated accordingly.

This softkey is only available if the Bitstream measurement (**Bitstream** softkey) is selected.

- Remote: CONF: BURS: BSTR: SYMB: SEL 1 (symbol)
- Remote: CONF: BURS: BSTR: FORM: SEL QPSK (modulation)
- Remote: CONF: BURS: BSTR: BURS: SEL 1 (burst)

File Manager (IEEE 802.16e-2005 OFDMA/WiBro)

Opens the **File Manager** dialog box. The File Manager provides the possibility to transfer WiMAX settings from an R&S SMU signal generator via LAN. For step-by-step instructions see "[To transfer the current R&S SMU WiMAX setting via LAN](#)" on page 4.429. The File Manager also offers some general file management support.

The File Manager writes into the directory C:\R_S\Instr\user\WMAN and its subdirectories or a USB memory stick only.

Under **File Types**, filter the displayed files by selecting:

- All (*.*)** All file types are displayed. Use this selection to perform general file management tasks.
- SMU WiMax** Only files with the extension WiMAX are displayed.

Depending on the focus, the following softkeys are provided:

- Recall
- New Folder
- Copy
- Paste
- Rename

– **Delete File**

For further information refer to section "Instrument Functions - Basic Settings", "Saving and Recalling Settings Files - FILE Key".

Softkeys of the sweep menu (WiMAX mode)

The following table shows all softkeys available in the sweep menu in **WiMAX** mode (**SWEEP** key). It is possible that your instrument configuration does not provide all softkeys. If a softkey is only available with a special option, model or (measurement) mode, this information is delivered in the corresponding softkey description.

Command
Run Single/Cont
Auto Level
Refresh

Run Single/Cont

Selects the sweep mode.

- Single** single sweep mode
- Cont** continuous sweep mode

A single measurement will complete once the requested number of bursts have been obtained or a single sweep has been completed, depending on the measurement settings. If a measurement is completed in continuous mode, a new measurement will be started.

If a measurement is started while another measurement is in progress, the first measurement will be aborted and the new measurement started immediately.

- Remote: INIT:CONT OFF (single sweep mode)
- Remote: INIT:CONT ON (continuous sweep mode)

Auto Level

Starts an automatic level detection measurement. After the automatic level detection has been completed, the trace is displayed in the Magnitude Capture Buffer display.

If this softkey is pressed while a measurement is running, the current measurement is aborted and the automatic level detection measurement is started. If the aborted measurement was a continuous measurement, it is resumed after the automatic level detection is completed.

- Remote: CONF:POW:AUTO ON

Refresh

Updates the current measurement results with respect to the current gate settings. This softkey is only available if the measurement results are effected by the gate settings (Spectrum FFT, CCDF, Spectrum Mask, Spectrum ACPR) and if the gate settings are modified after a measurement result has been obtained.

- Remote: INIT:REFR

Softkeys of the marker menu (WiMAX mode)

The following table shows all softkeys available in the marker menu in **WiMAX** mode (**MKR** key). It is possible that your instrument configuration does not provide all softkeys. If a softkey is only available with a special option, model or (measurement) mode, this information is delivered in the corresponding softkey description. Close all settings dialog boxes before opening the marker menu.

Command
Marker 1
Unzoom
Marker Zoom
Marker Off

Marker 1

Opens a dialog box to adjust the marker. The contents of the dialog box depends on the type of graph the marker is adjusted to. After every change, the marker position in the trace and the marker information are updated.

- Remote: CALC1:MARK1 ON
- Remote: CALC:MARK:X 2ms
- Remote: CALC:MARK:Y?
- Remote: CALC2:MARK:SYMB 2
- Remote: CALC2:MARK:CARR -7

Unzoom

Cancels the marker zoom.

- Remote: CALC:MARK:FUNC:ZOOM 1

Marker Zoom (Magnitude Capture Buffer, PVT, Constellation vs Symbol, Constellation vs Carrier)

Opens an edit dialog box to select the magnification factor for the zoom. The maximum magnification depends on the type of result display.

- Remote: CALC:MARK:FUNC:ZOOM 4

Marker Off

Switches off all makers in the active result display.

- Remote: CALC2:MARK:AOFF

Softkeys of the marker-> menu (WiMAX mode)

The following table shows all softkeys available in the marker-> menu in **WiMAX** mode (**MKR->** key). It is possible that your instrument configuration does not provide all softkeys. If a softkey is only available with a special option, model or (measurement) mode, this information is delivered in the corresponding softkey description.

Command
MKR -> Trace

MKR -> Trace

Opens an edit dialog box to enter the number of the trace, on which the marker is to be placed. This softkey is available for all result displays with more than one trace.

→ Remote: CALC2:MARK:TRAC 2

Softkeys of the lines menu (WiMAX mode)

The following table shows all softkeys available in the lines menu in **WiMAX** mode (**LINES** key). It is possible that your instrument configuration does not provide all softkeys. If a softkey is only available with a special option, model or (measurement) mode, this information is delivered in the corresponding softkey description.

This menu is only available if the results are displayed in form of a list (for details see **Result summary list** and **Display Graph/List** softkey).

Command
Default Current
Default All

Default Current

Resets all limits for the current modulation scheme to the values specified in the selected standard.

→ Remote: see CALCulate:LIMit Subsystem

Default All

Resets all limits for all modulation schemes to the values specified in the selected standard.

→ Remote: see CALCulate:LIMit Subsystem

Softkeys of the trace menu (WiMAX mode)

The following table shows all softkeys available in the trace menu in **WiMAX** mode (**TRACE** key). It is possible that your instrument configuration does not provide all softkeys. If a softkey is only available with a special option, model or (measurement) mode, this information is delivered in the corresponding softkey description.

Command
Display List/Graph
Screen Focus A/B
Screen Size Full/Split

Display List/Graph

For details refer to the **Display Graph/List** softkey in the WiMAX menu.

Screen Focus A/B

Selects the active screen for IQ measurement results in split and full screen mode. Only the markers of an active screen can be controlled.

→ Remote: `DISP:WIND1:SSEL`

Screen Size Full/Split

Changes the display between split and full screen for IQ measurement results. Frequency sweep measurement results are always displayed in full screen.

→ Remote: `DISP:FORM SING`

Instrument Functions - Basic Settings

In this section, all basic settings functions of the R&S FSL and their application are explained in detail. The analyzer functions are described in section "Instrument Functions - Analyzer".

For every key a table is provided in which all submenus and corresponding commands are listed. The description of the submenus and commands follows the order of the table. The commands for the optional remote control (if any) are indicated for each softkey. The description includes the following:

- ["General Settings, Printout and Instrument Settings"](#) on page 4.473

This section provides information on how to prepare measurements and process their results: setting the instrument, managing and retrieving data, returning to manual operation, and printout.

More basic information on operation is given in the Quick Start Guide. The front and the rear view of the instrument together with a table of all available keys and a short description are provided in chapter "Front and Rear Panel". Chapter "Preparing for Use" informs how to start working with the instrument for the first time. A brief introduction on handling the instrument is given in chapter "Basic Operations". This includes also the description of the keys for basic operations like switching the instrument on and off or starting a measurement.

General Settings, Printout and Instrument Settings

After putting the instrument into operation and becoming familiar with the handling of the instrument (for details see Quick Start Guide), the preparations for measurements can start. In this section the general settings of the instrument, the data management and the processing of measurement results are described. This includes the following topics and keys:

- ["Instrument Setup and Interface Configuration - SETUP Key"](#) on page 4.474
- ["Saving and Recalling Settings Files - FILE Key"](#) on page 4.492
- ["Manual Operation - Local Menu"](#) on page 4.500
- ["Measurement Documentation - PRINT Key"](#) on page 4.501

Instrument Setup and Interface Configuration - SETUP Key

The **SETUP** key is used to set or display the default settings of the instrument: reference frequency, noise source, level correction values, date, time, LAN interface, firmware update and enabling of options, information about instrument configuration and service support functions. For further details refer also to the Quick Start Guide, chapter 2 "Preparing for Use".

To open the setup menu

- Press the **SETUP** key.
The setup menu is displayed.

Menu and softkey description

- ["Softkeys of the setup menu"](#) on page 4.474

To display help to a softkey, press the **HELP** key and then softkey for which you want to display help. To close the help window, press the **ESC** key. For further information refer to section "How to use the Help System".

Softkeys of the setup menu

The following table shows all softkeys available in the setup menu. It is possible that your instrument configuration does not provide all softkeys. If a softkey is only available with a special option, model or (measurement) mode, this information is delivered in the corresponding softkey description.

Menu Command	Submenu / Command	Submenu / Command	Command
Reference Int/Ext			
Transducer ↓	Active On/Off		
	Edit ↓	Insert Line	
		Delete Line	
		Edit Name	
		Edit Unit	
		Edit Value	
		Interpolation Lin/Log	
		Save Factor	
	New ↓	same contents as Edit menu	
	Copy to ↓	same contents as Edit menu	
	Delete		
	Ref Level Adjust Man/Auto		
	Show Directory		
IF Output			
Noise Src On/Off			
Alignment ↓	Self Align		
	Show Align Results		
	Corr Data On/Off		
General Setup ↓	Configure Network		

Menu Command	Submenu / Command	Submenu / Command	Command
	Network Address ↓	Computer Name	
		IP Address	
		Subnet Mask	
		DHCP On/Off	
	LXI ↓	LAN Status On/Off	
		Info	
		Password	
		Description	
		LAN Reset	
	GPIB ↓	GPIB Address	
		ID String Factory	
		ID String User	
		GPIB Language	
		Display Update On/Off	
		More ↓	
		GPIB Terminator LFEOI/EOI	
		*IDN Format Leg./New	
		I/O Logging On/Off	
	Time+Date		
	Meas Display ↓	Screen Title	
		Time+Date On/Off	
		Logo On/Off	
		Annotation On/Off	
		Screen Colors ↓	Select Screen Color Set
			Color On/Off
			Select Object
			Predefined Colors
			User Defined Colors
			Set to Default
		Print Colors ↓	Select Print Color Set
			Color On/Off
			Select Object
			Predefined Colors
			User Defined Colors
			Set to Default
		Display Pwr Save On/Off	
	Monitor Int/Ext		

Menu Command	Submenu / Command	Submenu / Command	Command
	Soft Frontpanel		
More ↓			
Firmware Update ↓	Firmware Update		
Option Licenses ↓	Install Option		
Shutdown Off/Standby			
System Info ↓	Hardware Info		
	Versions+Options		
	System Messages		
	Clear All Messages		
Service ↓	Input RF/Cal/TG		
	Comb Frequency		
	Reset Password		
	Selftest		
	Selftest Results		
	Password		
	Service Function		

Reference Int/Ext

Switches between the internal and external reference signal source. The default setting is internal reference. It is important, that the external reference signal is deactivated when switching from external to internal reference to avoid interactions.

If the reference signal is missing when switching to external reference, the message **EXREF** is displayed to indicate that no synchronization is performed.

The R&S FSL can use the internal reference source or an external reference source as frequency standard from which all internal oscillators are derived. A 10 MHz crystal oscillator is used as internal reference source. In the external reference setting, all internal oscillators of the R&S FSL are synchronized to the external reference frequency (also 10 MHz). For details on connectors refer to the Quick Start Guide, chapter 1 "Front and Rear Panel".

→ Remote: ROSC : SOUR INT

Transducer

Opens the **Select Transducer** dialog box and a submenu to activate or deactivate defined transducer factors, to generate new transducer factors or to edit existing ones.

In the **Select Transducer** dialog box, a transducer factor can be edited, deleted or copied, if selected, using the corresponding softkeys. The default directory, in which the transducer factors are saved, is displayed (C:\R_S\INSTR\TRD; the extension of transducer factor files is *.TDF). Subdirectories can be added or deleted via the file manager. They are displayed or hidden using the arrow keys or the **Show Directory** softkey / **Hide Directory** button.

Two different directory views are possible: If the **Show all** option is activated, all transducer factors in the directory are displayed. If the **Show compatible** option is activated, only the compatible transducer factors in the directory are displayed.

For details on transducer factors refer to chapter "Advanced Measurement Examples".

This softkey is available from firmware version 1.10.

→ Remote: CORR:TRAN:SEL FACTOR1

Active On/Off

Activates or deactivates the selected transducer factor. A maximum of 10 transducer factors can be activated at the same time. If an additional transducer factor is activated, its unit compatibility is checked. If one factor has a different unit than dB, all the other activated factors must have the unit dB.

This softkey is available from firmware version 1.10.

→ Remote: CORR:TRAN:SEL <name>

→ Remote: CORR:TRAN ON

Edit

Opens the **Edit Transducer** dialog box with the data of the selected factor. During editing, a transducer factor remains stored in the background until the factor is saved using the **Save Factor** softkey.

This softkey is available from firmware version 1.10.

→ Remote: Comment: CORR:TRAN:COMM <string>

Insert Line

Inserts an empty line above the selected reference value to enter a new reference value. When entering a new reference value in the line, the ascending order of frequencies must be taken into consideration, however.

This softkey is available from firmware version 1.10.

Delete Line

Deletes the selected reference value (complete line). The reference values that follow move one line up.

This softkey is available from firmware version 1.10.

Edit Name

Sets the focus on the **Name** field to enter a file name. The extension is added automatically.

This softkey is available from firmware version 1.10.

→ Remote: CORR:TRAN:SEL <name>

Edit Unit

Sets the focus on the **Unit** field to select the unit.

This softkey is available from firmware version 1.10.

→ Remote: CORR:TRAN:UNIT <string>

Edit Value

Sets the focus to enter positions and values as frequency/level pairs. The entered data are also displayed graphically. Using the **Shift x** or **Shift y** button, all entered values can be shifted in x or y direction.

This softkey is available from firmware version 1.10.

→ Remote: CORR:TRAN:DATA <freq>,<level>

Interpolation Lin/Log

Sets the scaling of the x-axis to linear or logarithmic.

This softkey is available from firmware version 1.10.

→ Remote: CORR:TRAN:SCAL LIN|LOG

Save Factor

Saves the changed factor to a file on the internal flash disk. If a transducer factor with the same name already exists, a confirmation query is displayed. If the new factor is active, the new values are immediately applied.

This softkey is available from firmware version 1.10.

→ Remote: In remote control, the save operation is performed automatically after the definition of the reference values.

New

Opens the **Edit Transducer** dialog box to enter data for a new factor.

This softkey is available from firmware version 1.10.

Copy to

Opens the **Edit Transducer** dialog box to copy the selected factor.

This softkey is available from firmware version 1.10.

Delete

Deletes the selected factor after confirmation.

This softkey is available from firmware version 1.10.

→ Remote: CORR:TRAN DEL

Ref Level Adjust Man/Auto

Activates or deactivates the automatic adjustment of the reference level to the selected transducer factor.

Auto Activates the automatic adjustment.

Man Deactivates the automatic adjustment. Adjust the reference level via the amplitude menu.

If a transducer factor is used (active), the trace is moved by a calculated shift. However, an upward shift reduces the dynamic range for the displayed values. With this softkey set to **Auto**, the original dynamic range is restored by also shifting the reference level by the maximum value of the transducer factor.

This softkey is available from firmware version 1.10.

→ Remote: CORR:TRAN:ADJ:RLEV ON

Show Directory

Displays the subdirectory of the selected directory.

This softkey is available from firmware version 1.10.

IF Output (option Additional Interfaces, B5 only)

Opens the **IF Output Source** dialog box to select the output of the IF/VIDEO OUT connector: **IF**, **Video 200 mV**, or **Video 1 V**.



The AF output available at the frontpanel can only be used if the IF output source is set to video.

For further details refer to the Quick Start Guide, chapter 1 "Front and Rear Panel".

→ Remote: OUPF IF VID

Noise Src On/Off (option Additional Interfaces, B5 only)

Switches the supply voltage for an external noise source on or off. For details on connectors refer to the Quick Start Guide, chapter 1 "Front and Rear Panel" .

→ Remote: DIAG:SERV:NSO ON

Alignment

Opens a submenu with the available functions for recording, displaying and activating the data for self alignment.

The correction data and characteristics required for the alignment are determined by comparison of the results at different settings with the known characteristics of the high-precision calibration signal source at 65.83 MHz. The correction data are stored as a file on flash disk and can be displayed using the **Show Align Results** softkey.

Self Align

Starts the recording of correction data of the instrument. If the correction data acquisition has failed or if the correction values are deactivated, a corresponding message is displayed in the status field.

As long as the self alignment data is collected the procedure can be cancelled using the **Abort** button.

→ Remote: *CAL?

Show Align Results

Opens a dialog box that displays the correction data of the alignment:

- date and time of last correction data record
- overall results of correction data record
- list of found correction values according to function/module

The results are classified as follows:

PASSED	calibration successful without any restrictions
CHECK	deviation of correction value larger than expected, correction could however be performed
FAILED	deviations of correction value too large, no correction was possible. The found correction data are not applicable.

As long as the self alignment data is collected the procedure can be cancelled using the **Abort** button.

- Remote: CAL:RES?
 - Remote: CAL:ABOR
-

Corr Data On/Off

Activates and deactivates the alignment data, e.g. for service purposes the correction data can be deactivated.

- Remote: CAL:STAT ON
-

General Setup

Opens a submenu for all general settings such as IP address and LAN settings, date and time, remote control (optional) and MEAS display.

Configure Network

Opens the **Network Connections** dialog box to change the LAN settings. For details refer to the Quick Start Guide, chapter 2 "Preparing for Use" and appendix B "LAN Interface".

Network Address

Opens a submenu to configure the internet protocol properties and the computer name.

Computer Name

Opens an edit dialog box to enter the computer name via the keypad. The naming conventions of Windows apply. If too many characters and/or numbers are entered, in the status line, an according message is displayed. For step-by-step instructions refer to the Quick Start Guide, appendix B "LAN Interface".

IP Address

Opens an edit dialog box to enter the IP address via the keypad. The TCP/IP protocol is preinstalled with the IP address 10.0.0.10. If the DHCP server is available (**DHCP On**), the dialog box entry is read-only.

The IP address consists of four number blocks separated by dots. Each block contains 3 numbers in maximum (e.g. 100.100.100.100), but also one or two numbers are allowed in a block (as an example see the preinstalled address). For step-by-step instructions refer to the Quick Start Guide, chapter 2 "Preparing for Use".

Subnet Mask

Opens an edit dialog box to enter the subnet mask via the keypad. The TCP/IP protocol is preinstalled with the subnet mask 255.255.255.0. If the DHCP server is available (**DHCP On**), the dialog box entry is read-only.

The subnet mask consists of four number blocks separated by dots. Each block contains 3 numbers in maximum (e.g. 100.100.100.100), but also one or two numbers are allowed in a block (as an example see the preinstalled address). For step-by-step instructions refer to the Quick Start Guide, chapter 2 "Preparing for Use".

DHCP On/Off

Switches between DHCP server available (On) or not available (Off). If a DHCP server is available in the network, the IP address and subnet mask of the instrument are obtained automatically from the DHCP server. For further details refer to the Quick Start Guide, chapter 2 "Preparing for Use".

LXI

Opens the LXI submenu containing the following softkeys:

LAN Status On/Off
Info
Password
Description
LAN Reset

As of firmware version 2.00, LXI functionality can be accessed only by administrators.

LAN Status On/Off

Activates the LAN status bar that shows the current status of the LAN connection.



Depending on the status of the connection, the LXI logo in the LAN Status Indicator window assumes the following states:

Red No connection is established

Green A connection is established
Blinking The device has not been identified

This softkey is available from firmware version 1.90.

Info

Shows the current parameter of LXI class C. The R&S FSL displays the current version, class and various computer parameter like computer name or IP adress.

While active, the dialog is not updated.

This softkey is available from firmware version 1.90.

→ Remote: SYST:LXI:INF?

Password

Shows the currently set password. You can also change the current password using this softkey.

The password is needed to change settings via the web browser (e.g. IP parameter). An empty password is not valid, i.e. you must enter a password.

By default, the password is LxiWebIfc.

This softkey is available from firmware version 1.90.

→ Remote: SYST:LXI:PASS <string>

Description

Opens a dialog box to view or change the LXI instrument description. This description is used on some of the LXI web sites.

By default, the description is '*Spectrum Analyzer/FSL/Serial #*'

This softkey is available from firmware version 1.90.

→ Remote: SYST:LXI:MDES <string>

LAN Reset

Resets the LAN configuration to a state required by the LXI standard. For example, the TCP/IP mode is set to DHCP and Dynamic DNS and ICMP Ping are enabled. In addition, the R&S FSL sets the password and the instrument description to their initial states (see **Password** and **Description** softkeys).

From firmware version 2.00 upwards, only user accounts with administrator rights are able to reset the LAN configuration.

This softkey is available from firmware version 1.90.

→ Remote: SYST:LXI:LANR

GPIB (option GPIB Interface, B10 only)

Opens a submenu to set the parameters of the remote control interface.

GPIB Address (option GPIB Interface, B10 only)

Opens an edit dialog box to enter the GPIB address. Values from 0 to 30 are allowed. The default address is 20.

If, e.g. after a firmware update, the R&S FSL does not maintain the GPIB address after reboot, the shutdown file needs to be recreated. Perform the following steps:

- Set the GPIB address.
- Create a shutdown file by switching the R&S FSL in the standby mode: Press the ON/STANDBY key on the front panel and wait until the yellow LED is on. With the battery pack option, use a USB keyboard and terminate the R&S FSL firmware with ALT+F4 to create the shutdown file.

If the shutdown file was created once, the R&S FSL boots with exactly those settings after a reboot with the main switch on the rear panel. During a firmware update or cold boot for service reasons the shutdown file is deleted, and the setup is necessary once again.

→ Remote: `SYST:COMM:GPIB:ADDR 20`

 ID String Factory (option GPIB Interface, B10 only)

Selects the default response to the *IDN? query.

 ID String User (option GPIB Interface, B10 only)

Opens an edit dialog box to enter a user-defined response to the *IDN? query. Max. 36 characters are allowed.

 GPIB Language (option GPIB Interface, B10 only)

Only the remote control language SCPI is available for the R&S FSL and is set by default.

→ Remote: `SYST:LANG 'SCPI'`

 Display Update On/Off

Defines whether the instrument display is switched off when changing from manual operation to remote control. In remote control mode, this softkey is displayed in the local menu (for details refer to section "[Manual Operation - Local Menu](#)" on page 4.500).

→ Remote: `SYST:DISP:UPD ON`

 GPIB Terminator LFEI/EOI (option GPIB Interface, B10 only)

Changes the GPIB receive terminator.

According to the standard the terminator in ASCII is <LF> and/or <EOI>. For binary data transfers (e.g. trace data) from the control computer to the instrument, the binary code used for <LF> might be included in the binary data block, and therefore should not be interpreted as a terminator in this particular case. This can be avoided by changing the receive terminator to EOI.

→ Remote: `SYST:COMM:GPIB:RTER EOI`

***IDN Format Leg./New**

Defines the response format to the *IDN? remote command. This function is intended for re-use of existing control programs together with the R&S FSL.

Leg. Legacy format, compatible to the R&S FSP/FSU/FSQ family
New R&S FSL format

→ Remote: SYST:FORM:IDEN LEG

I/O Logging On/Off (option GPIB Interface, B10 only)

Activates or deactivates the SCPI error log function. All remote control commands received by the R&S FSL are recorded in the following log file:

C:\R_S\Instr\ScpiLogging\ScpiLog.txt

Logging the commands may be extremely useful for debug purposes, e.g. in order to find misspelled keywords in control programs.

Time+Date

Opens an edit dialog box to enter time and date for the internal real time clock. For details refer to the Quick Start Guide, chapter 2 "Preparing for Use".

→ Remote: SYST:TIME 12,30

→ Remote: SYST:DATE 2004,10,01

Meas Display

Opens a submenu to configure the display and the print colors.

This softkey is available from firmware version 1.10.

Screen Title

Activates/deactivates the display of a diagram title (if available) and opens an edit dialog box to enter a new title for the active diagram. Max. 20 characters are allowed.

This softkey is available from firmware version 1.10.

→ Remote: DISP:TEXT 'Noise Meas'

→ Remote: DISP:TEXT:STATE ON

Time+Date On/Off

Activates/deactivates the display of date and time above the diagram.

This softkey is available from firmware version 1.10.

→ Remote: DISP:TIME OFF

Logo On/Off

Activates/deactivates the display of the Rohde & Schwarz company logo in the upper left corner.

This softkey is available from firmware version 1.10.

→ Remote: `DISP:LOGO ON`

Annotation On/Off

Activates/deactivates the display of the frequency information. For example to protect confidential data it can be useful to hide the frequency information.

This softkey is available from firmware version 1.10.

→ Remote: `DISP:ANN:FREQ ON`

Screen Colors

Opens a submenu to configure the screen colors. For details on screen colors refer to the Quick Start Guide, chapter 2 "Preparing for Use".

This softkey is available from firmware version 1.10.

→ Remote: `DISP:CMAP2:HSL 0.3,0.8,1.0`

Select Screen Color Set

Opens the **Select Screen Color Set** dialog box to select default or user defined color settings.

If one of the default settings is selected (**Default Colors 1/2**), the default settings for brightness, color tint and color saturation for all display screen elements are restored. The default color schemes provide optimum visibility of all picture elements at an angle of vision from above or below. Default setting is **Default Colors 1**.

If **User Defined Colors** is selected, a user-defined color set can be defined. For step-by-step instruction refer to the Quick Start Guide, chapter 2 "Preparing for Use".

This softkey is available from firmware version 1.10.

→ Remote: `DISP:CMAP:DEF2`

Color On/Off

Switches from color display to black-and-white display and back. The default setting is color display.

This softkey is available from firmware version 1.10.

Select Object

Opens the **Color Setup** dialog box to select the color settings for a selected object.

The **Selected Object** list is displayed to select the object. For setting the color the predefined colors are displayed.

This softkey is available from firmware version 1.10.

- Remote: `DISP:CMAP2:HSL 0.3,0.8,1.0` (screen colors)
 - Remote: `HCOP:CMAP2:HSL 0.3,0.8,1.0` (print colors)
-

Predefined Colors

In the **Color Setup** dialog box, displays the **Predefined Colors** (alternative to the **Predefined Colors** button). This softkey is only available if, in the **Select Color Set** dialog box, the **User Defined Colors** option is selected or the **Color Setup** dialog box is displayed. For further details refer to the Quick Start Guide, chapter 2 "Preparing for Use".

This softkey is available from firmware version 1.10.

- Remote: `DISP:CMAP2:PDEF GRE` (screen colors)
 - Remote: `HCOP:CMAP2:PDEF GRE` (print colors)
-

User Defined Colors

In the **Color Setup** dialog box, displays the **User Defined Colors** (alternative to the **User Defined Colors** button). This softkey is only available if, in the **Select Color Set** dialog box, the **User Defined Colors** option is selected or the **Color Setup** dialog box is displayed. For further details refer to the Quick Start Guide, chapter 2 "Preparing for Use".

This softkey is available from firmware version 1.10.

- Remote: `DISP:CMAP2:HSL 0.3,0.8,1.0` (screen colors)
 - Remote: `HCOP:CMAP2:HSL 0.3,0.8,1.0` (print colors)
-

Set to Default

Opens the **Set to Default** dialog box to select one of the factory default color settings.

This softkey is available from firmware version 1.10.

- Remote: `DISP:CMAP:DEF2` (screen colors)
 - Remote: `HCOP:CMAP:DEF2` (print colors)
-

Print Colors

Opens a submenu to select the colors for the printout. To facilitate color selection, the selected color combination is displayed when the menu is entered. The previous colors are restored when the menu is exited.

This softkey is available from firmware version 1.10.

Select Print Color Set

Opens the **Select Print Color Set** dialog box to select the color settings for printout.

Screen Colors (Print)	Selects the current screen colors for the printout. The background is always printed in white and the grid in black.
Screen Colors (Hardcopy)	Selects the current screen colors without any changes for a hardcopy. The output format is set via the Device Setup softkey in the print menu.
Optimized Colors	Selects an optimized color setting for the printout to improve the visibility of the colors (default setting). Trace 1 is blue, trace 2 black, trace 3 green, and the markers are turquoise. The background is always printed in white and the grid in black.
User Defined Colors	Enables the softkeys to define colors for the printout.

This softkey is available from firmware version 1.10.

→ Remote: HCOP:CMAP:DEF1

Color On/Off

Switches from color printout to black-and-white printout and back. All colored areas are printed in white and all colored lines in black. This improves the contrast. The default setting is color printout, provided that the selected printer can produce color printouts.

This softkey is available from firmware version 1.10.

→ Remote: HCOP:DEV:COL ON

Display Pwr Save On/Off

Switches the power-save mode for the display on/off and opens an edit dialog box to enter the time for the power-save function to respond. After the elapse of this time the display is completely switched off, i.e. including backlighting. This mode is recommended when the instrument is exclusively operated in remote control.

For details on the power-save mode for the display refer to the Quick Start Guide, chapter 2 "Preparing for Use".

This softkey is available from firmware version 1.10.

→ Remote: DISP:PSAV ON

→ Remote: DISP:PSAV:HOLD 15

Monitor Int/Ext

Switches from the internal instrument monitor to an external monitor and vice versa. The softkey is only effective, if an external monitor is connected. For further details refer to the Quick Start Guide, chapter 2 "Preparing for Use".

This softkey is available from firmware version 1.80.

Soft Frontpanel

Activates or deactivates the display of the instrument emulation.

deactivated Only the measurement screen is displayed. This is the setting for working at the R&S FSL.

activated Additionally to the measurement screen, the whole front panel is displayed. This is the setting for working at a computer with XP Remote Desktop or at an external monitor.

Alternatively to this softkey, you can use the F6 key.

→ Remote: SYST:DISP:FPAN ON

Open Start Menu

Opens the Windows Start Menu.

Firmware Update

Opens a submenu to install firmware versions. The installation of a new firmware version can be performed via USB or LAN interface. For details on installation refer to the Quick Start Guide, chapter 3 "Firmware Update and Installation of Firmware Options".

From firmware version 2.00 upwards, only user accounts with administrator rights are able to perform a firmware update.

Firmware Update

Opens the **Firmware Update** dialog box. The update path is changed by entering the new path or via the **Browse** button. The installation is started via the **Execute** button. For details on installation refer to the Quick Start Guide, chapter 3 "Firmware Update and Installation of Firmware Options".

From firmware version 2.00 upwards, only user accounts with administrator rights are able to perform a firmware update.

→ Remote: SYST:FIRM:UPD 'D:\FW_UPDATE'

Option Licenses

Opens a submenu to install options. For details on options refer to the Quick Start Guide, chapter 3 "Firmware Update and Installation of Firmware Options".

From firmware version 2.00 upwards, only user accounts with administrator rights are able to install options.

Install Option

Opens an edit dialog box to enter the license key for the option that you want to install.

A message box opens if an option is about to expire or has already expired (in which case all functions (including remote control) are unavailable until the R&S FSL is rebooted). For more information about the option in question refer to the **System Info** softkey in the setup menu.

From firmware version 2.00 upwards, only user accounts with administrator rights are able to install options.

Shutdown Off/Standby

Configures the shutdown behavior of the R&S FSL when switched off via the ON/STANDBY key on the front panel.

- Off** If activated, the R&S FSL is shutdown completely when switched off via the ON/STANDBY key on the front panel. When switched on the next time, the R&S FSL will completely reboot.
To prevent the instrument from overheating, the fan remains active.
- Standby** If activated, the R&S FSL goes into the standby mode when switched off via the ON/STANDBY key on the front panel. When switched on the next time, the boot time is shorter. This is the default setting.

This softkey is available from firmware version 1.80.

System Info

Opens a submenu to display detailed information on module data, device statistics and system messages.

Hardware Info

Opens a dialog box that displays hardware information, e.g. on the frontend and motherboard. Every listed component is described by its serial number, order number, model information, hardware code, and hardware revision.

→ Remote: `DIAG:SERV:HWIN?`

Versions+Options

Opens a dialog box that displays a list of hardware and firmware information, e.g. the firmware version, the image version, BIOS version, data sheet version of the basic device, installed options (hardware and firmware options).

For details on options refer to the Quick Start Guide, chapter 2 "Checking the Furnished Items".

→ Remote: `*IDN?`

→ Remote: `*OPT?`

System Messages

Opens the **System Messages** dialog box that displays the generated system messages in the order of their occurrence. The most recent messages are placed at the top of the list. Messages that have occurred since the last display of system messages menu are marked with an asterisk '*'. The following information is available:

- | | |
|------------------|--|
| No | device-specific error code |
| Message | brief description of the message |
| Component | hardware messages: name of the affected module
software messages: name of the affected software |
| Date/Time | date and time of the occurrence of the message |

If the number of error messages exceeds the capacity of the error buffer, **Message buffer overflow** is displayed. To delete messages see **Clear All Messages** softkey.

→ Remote: SYST:ERR:LIST?

Clear All Messages

Deletes all system messages. The softkey is only available if the **System Messages** dialog box is displayed.

→ Remote: SYST:ERR:CLE:ALL?

Service

Opens a submenu that contains additional functions for maintenance and/or trouble shooting. From firmware version 2.00 upwards, only user accounts with administrator rights are able to use the service functions.

NOTICE

Risk of improper operation

The service functions are not necessary for normal measurement operation. However, incorrect use can affect correct operation and / or data integrity of the R&S FSL. Therefore, many of the functions can only be used after entering a password. They are described in the instrument service manual.

Input RF/Cal/TG

Selects the input for measurement.

- | | |
|-----|--|
| RF | Switches the input of the R&S FSL to the input connector (normal position). This is the default setting. |
| Cal | Switches the RF input of the R&S FSL to the internal calibration source (65.83 MHz) and activates the data entry of the output level of the calibration source. Possible values are 0 dB and -30 dB. |
| TG | Switches the RF input of the R&S FSL to the tracking generator output. Only the models 13, 16 and 28 offer this setting. |

→ Remote: DIAG:SERV:INP RF|CAL|TG

Comb Frequency

Opens a dialog box to set the comb generator frequency for the internal calibration:

- | | |
|----------------|------------------|
| Comb/1 | 65.8333 MHz / 1 |
| Comb/64 | 65.8333 MHz / 64 |
| Comb/65 | 65.8333 MHz / 65 |

- Remote: Sine: DIAG:SERV:INP:PULS OFF
 - Remote: Comb: DIAG:SERV:INP:PULS ON
 - Remote: Comb: DIAG:SERV:INP:PRAT COMB64
-

Reset Password

Deactivates all set passwords.

- Remote: SYST:PASS:RES
-

Selftest

Initiates the self test of the instrument modules to identify a defective module in case of failure . All modules are checked consecutively and the test result is displayed.

- Remote: *TST?
-

Selftest Results

Opens the **Selftest Result** dialog box that contains the test results. In case of failure a short description of the failed test, the defective module, the associated value range and the corresponding test results are indicated.

- Remote: DIAG:SERV:STE:RES?
-

Password

Opens an edit dialog box to enter the password. This ensures that the service functions are only used by authorized personnel.

- Remote: SYST:PASS "Password"
-

Service Function

Opens the **Service Function** dialog box to start special service functions. For further information refer to the service manual.

- Remote: DIAG:SERV:SFUNC <value>,<value>...
-

Saving and Recalling Settings Files - FILE Key

The **FILE** key is used to store and load instrument settings and to manage stored files.

The file menu includes functions for storing (**Save** softkey) instrument settings such as instrument configurations (measurement/display settings, etc) and measurement results on permanent storage media, or to load (**Recall** softkey) stored data back onto the instrument.

Functions for management of storage media (**File Manager** softkey) include among others functions for listing, copying, and deleting/renaming files.

The R&S FSL is capable of internally storing complete instrument settings with instrument configurations and measurement data in the form of settings files. The respective data are stored on the internal flash disk or, if selected, on a memory stick or network drive. The mass media are assigned to the volume names as follows:

Drive	Designation	Comment
C	operating system, firmware and stored instrument settings	for customer data
A	USB floppy drive	if connected
D	USB memory stick or USB CD-ROM	if connected
E ...Z	additional USB mass storage devices or mounted LAN volumes	if connected

To open the file menu

- Press the **FILE** key.

The file menu is displayed.

Menu and softkey description

- ["Softkeys of the file menu"](#) on page 4.493

To display help to a softkey, press the **HELP** key and then softkey for which you want to display help. To close the help window, press the **ESC** key. For further information refer to section "How to use the Help System".

Further information

- ["Navigation in the dialog boxes for saving and loading settings files"](#) on page 4.492
- ["Navigation in the file manager"](#) on page 4.493

Navigation in the dialog boxes for saving and loading settings files

The **Save** and **Recall** dialog boxes are used to save and recall settings files. For both dialog boxes, the same navigation principle applies. Press the **Save** or **Recall** softkey to open the corresponding dialog box.

- **Path** field

To change the directory, press the **Select Path** softkey.

To select a folder, use the rotary knob or the **UPARROW** and **DNARROW** keys. To open a subfolder, press the **RIGHTARROW** key. To close subfolders, press the **LEFTARROW** key. To confirm the selection, press the rotary knob or the **ENTER** key.

- **Files list**

If the **Recall** or **Startup Recall** dialog box is opened, the focus is on the **Files** list. To set the focus on the **Files** list, press the **Select File** softkey.

To select a folder, use the rotary knob or the **UPARROW** and **DNARROW** keys. To open a subfolder, press the **ENTER** key. To select a file, use the rotary knob or the **UPARROW** and **DNARROW** keys. To load the selected file, press the rotary knob or the **ENTER** key. To delete the selected file, press the softkey.

- **File Name field**

If the **Save** dialog box is opened, the focus is on the **File Name** field. To set the focus on **File Name** field, press the **Edit File Name** softkey. Enter the name in the **File Name** field. The extension of the data name is ignored (for details on entering the name, see Quick Start Guide, chapter 4 "Basic Operations").

- **Comment field**

To enter a comment, press the **Edit Comment** softkey (for details on entering the name, see Quick Start Guide, chapter 4 "Basic Operations").

- Items saved in the settings file

- To select a special item, set the focus on the entry using the arrow keys or the rotary knob. To confirm the selection, press the **CHECKMARK** key. To deselect the item, press the **CHECKMARK** key again.

Navigation in the file manager

- To change from one subfolder to another, use the **ENTER** key.
- To change to the next higher directory, select the dots "..".
- To change into a subfolder, use the **RIGHTARROW** and **LEFTARROW** keys.
- To select a file or a folder, use the **UPARROW** and **DNARROW** keys.
- To confirm the selection of a file or folder, press the **ENTER** key.

Softkeys of the file menu

The following table shows all softkeys available in the file menu. It is possible that your instrument configuration does not provide all softkeys. If a softkey is only available with a special option, model or (measurement) mode, this information is delivered in the corresponding softkey description.

Menu / Command	Submenu / Command	Command
Save ↓	Save File	
	Select Path	
	Select File	
	Edit File Name	
	Edit Comment	
	Select Items ↓	Select Items
		Enable all Items
		Disable all Items
	Delete File	
Recall ↓	Recall File	
	Select Path	

Menu / Command	Submenu / Command	Command
	Select File	
	Edit File Name	
	Select Items ↓	Select Items
		Enable all Items
		Disable all Items
	Delete File	
Startup Recall		
Startup Recall Setup		
File Manager ↓	Edit Path	
	New Folder	
	Copy	
	Rename	
	Cut	
	Paste	
	More ↓	
	Delete	
	Sort Mode ↓	Name
		Date
		Extension
		Size
	File Lists 1/2	
	Current File List 1/2	
	Network Drive	Map Network Drive
		Disconnect Network Drive
Export		
Import		
Hardcopy		

Save

Opens the **Save** dialog box to define and store the settings file. To navigate in the dialog box and define/enter data, use the corresponding softkeys. For details see also "[Navigation in the dialog boxes for saving and loading settings files](#)" on page 4.492.

- Path Directory in which the settings file is stored. The default path for user settings files is C:\r_s\instr\user
- Files List of settings files already stored
- File Name Name of settings file
- Comment Comment regarding the settings file
- [Items] Selection of items to be saved in the settings file

Save File / Recall File

Saves the settings file with the defined file name (**Save** dialog box), or recalls the selected settings file (**Recall** dialog box). If the file name already exists, upon saving, a message is displayed. Selecting **Yes** overwrites the existing file, selecting **No** aborts the saving process.

For details on the file name conventions refer to the **Edit File Name** softkey description.

This softkey is available from firmware version 1.70.

- Remote: MMEM:STOR:STAT 1, 'Save'
 - Remote: MMEM:STOR:STAT:NEXT
 - Remote: MMEM:LOAD:STAT 1, 'C:\R_S\Instr\user\TEST01'
-

Select Path

Opens the directory list to select the drive and folder for the settings file to be stored or loaded. The default path is C:\r_s\instr\user. For details see also ["Navigation in the dialog boxes for saving and loading settings files"](#) on page 4.492.

Select File

Sets the focus on the **Files** list. For details see also ["Navigation in the dialog boxes for saving and loading settings files"](#) on page 4.492.

- Remote: MMEM:CAT? 'C:\R_S\Instr\user*.DFL'
-

Edit File Name

Sets the focus on the **File Name** field.

In the **Save** dialog box, the field already contains a suggestion for a new name: the file name used in the last saving process is counted up to the next unused name. For example, if the name last used was "test_004", the new name "test_005" is suggested, but only if this name is not in use. If the name "test_005" is already in use, the next free name is suggested, e.g. "test_006". You can change the suggested name to any name conform to the following naming conventions.

The name of a settings file consists of a base name followed by an underscore and three numbers, e.g. limit_lines_005. In the example, the base name is "limit_lines". The base name can contain characters, numbers and underscores. The file extension is added automatically.

This softkey is available from firmware version 1.70.

Edit Comment

Sets the focus on the **Comment** field to enter a comment for the settings file. Max. 60 characters are allowed. For details see also ["Navigation in the dialog boxes for saving and loading settings files"](#) on page 4.492.

Select Items

Displays the softkey submenu for selecting the items to be stored or loaded.

Select Items

Sets the focus on the items list. For details see also ["Navigation in the dialog boxes for saving and loading settings files"](#) on page 4.492.

In the **Save** dialog box, all items that can be saved are displayed. The number of displayed items depends on the installed options, as for some options additional items can be stored.

In the **Recall** dialog box, the items saved in the selected file are displayed.

- Remote: MMEM:SEL:HWS ON
 - Remote: MMEM:SEL:LIN:ALL ON
 - Remote: MMEM:SEL:TRAC ON
 - Remote: MMEM:SEL:TRAN:ALL ON
-

Enable all Items

Selects all items for saving or loading.

This softkey is available from firmware version 1.70.

- Remote: MMEM:SEL:ALL
-

Disable all Items

Selects none of the items for saving or loading.

This softkey is available from firmware version 1.70.

- Remote: MMEM:SEL:NONE
-

Delete File

Deletes the selected settings file.

- Remote: MMEM:CLE:STAT 1, 'TEST'
-

Recall

Opens the **Recall** dialog box to load a settings file. To navigate in the dialog box, use the corresponding softkeys. For details see also ["Navigation in the dialog boxes for saving and loading settings files"](#) on page 4.492.

Path	Directory from which the settings file is loaded. The default path for user settings files is C:\r_s\instr\user
Files	List of stored settings files
File Name	Name of settings file
Comment	Comment of the settings file
[Items]	Items saved in the settings file

Startup Recall

Activates or deactivates the startup recall function. If activated, the settings stored in the file selected via the **Startup Recall Setup** softkey are loaded when booting or for preset. If deactivated, the default settings are loaded.

This softkey is available from firmware version 1.10.

→ Remote: MMEM:LOAD:AUTO 1, 'C:\R_S\Instr\user\TEST'

Startup Recall Setup

Opens the **Startup Recall** dialog box to select the settings file for the startup recall function (see also **Startup Recall** softkey).

This softkey is available from firmware version 1.10.

→ Remote: MMEM:LOAD:AUTO 1, 'C:\R_S\Instr\user\TEST'

File Manager

Opens the **File Manager** dialog box and a submenu to manage mass storage media and files. In the upper left corner, the current drive is displayed. Below the folders and subfolders of the current directory are displayed. For details on navigation see also "[Navigation in the file manager](#)" on page 4.493.

The following tasks can be performed:

- to copy files from flash disk to other media
 - to copy files into another directory
 - to rename and delete files
-

Edit Path

For details see **Select Path** softkey.

→ Remote: MMEM:MSIS "D:"

→ Remote: MMEM:CDIR "C:\R_S\Instr\user"

New Folder

Creates a new folder and opens an edit dialog box to enter name and path (absolute or relative to the current directory) of the new folder.

→ Remote: MMEM:MDIR "C:\R_S\Instr\user\TEST"

Copy

Copies the selected item to the clipboard. The item can be copied later using the **Paste** softkey. For details on navigation see also "[Navigation in the file manager](#)" on page 4.493.

→ Remote: MMEM:COPY "C:\R_S\Instr\user\set.cfg", "E:"

Rename

Opens an edit dialog box to enter a new file or folder name:. For details on navigation see also "[Navigation in the file manager](#)" on page 4.493.

→ Remote: MMEM:MOVE "test02.cfg", "set2.cfg"

Cut

Copies the selected file to the clipboard. If the file is later copied to a different directory using the **Paste** softkey, it is deleted in the current directory. For details on navigation see also "[Navigation in the file manager](#)" on page 4.493.

Paste

Copies a file from the clipboard to the currently selected directory. For details on navigation see also "[Navigation in the file manager](#)" on page 4.493.

Delete

Deletes the selected item after confirmation. For details on navigation see also "[Navigation in the file manager](#)" on page 4.493.

→ Remote: MMEM:DEL "test01.hcp"

→ Remote: MMEM:RDIR "C:\R_S\Instr\user\TEST"

Sort Mode

Opens a submenu to select the sorting mode for the displayed files. The entry for the next higher directory level ("..") and the folders are always located at the top of the list.

Name

Sorts the displayed files in alphabetical order of the file names.

Date

Sorts the displayed files in respect to the date.

Extension

Sorts the displayed files in respect to the extension.

Size

Sorts the displayed files in respect to the size.

File Lists 1/2

Splits the screen to copy files from one directory to the other. The focus between the two panes is switched using the **FIELD RIGHT** and **FIELD LEFT** keys.

Current File List 1/2

Changes the focus to the selected file list.

Network Drive

Opens the **Map Network Drive** dialog box. For further information refer to the Quick Start Guide.

This softkey is available from firmware version 1.70.

Map Network Drive

Sets the focus on the **Drive** list. For further information refer to the Quick Start Guide.

This softkey is available from firmware version 1.70.

- Remote: MMEM:NETW:MAP 'T:', '\\server\folder'
 - Remote: MMEM:NETW:USED ON
 - Remote: MMEM:NETW:UNUS?
-

Disconnect Network Drive

Opens the **Disconnect Network Drive** dialog box. In the **Drive** list, select the drive you want to disconnect and confirm with **OK**.

This softkey is available from firmware version 1.70.

- Remote: MMEM:NETW:DISC 'T: '
-

Export

Opens a submenu to configure exports of trace data. For details see **ASCII File Export** softkey in the trace menu.

ASCII File Export
Decim Sep

Import

This function is currently not available in spectrum analyzer mode.

Hardcopy

Opens the print menu. For details on submenus and softkeys refer to Measurement Documentation - PRINT Key.

Manual Operation - Local Menu

When switched on, the instrument is always in the manual measurement mode and can be operated via the front panel. As soon as the instrument receives a remote command, it is switched to the remote control mode.

In remote control mode, all keys of the instrument except the **PRESET** key are disabled. The **LOCAL** softkey and the **Display Update On/Off** softkey are displayed. Depending on the setting of the **Display Update On/Off** softkey, the diagrams, traces and display fields are displayed or hidden. For further details on the **Display Update On/Off** softkey refer to section "Instrument Setup and Interface Configuration - SETUP Key".

For details on remote control refer to chapter 5 "Remote Control - Basics".

The change to manual operation consists of:

- Enabling the Front Panel Keys

Returning to manual mode enables all inactive keys. The main softkey menu of the current mode is displayed.

- Displaying the measurement diagrams again.

The diagrams, traces and display fields are displayed again.

- Generating the **OPERATION COMPLETE** message

If, at the time of pressing the **LOCAL** softkey, the synchronization mechanism via *OPC, *OPC? or *WAI is active, the currently running measurement procedure is aborted and synchronization is achieved by setting the corresponding bits in the registers of the status reporting system.

- Setting Bit 6 (User Request) of the Event Status Register

With a corresponding configuration of the status reporting system, this bit immediately causes the generation of a service request (SRQ) to inform the control software that the user wishes to return to front panel control. For example this can be used to interrupt the control program and to correct instrument settings manually. This bit is set each time the **LOCAL** softkey is pressed.

To return to manual operation

- Press the **LOCAL** softkey.

The instrument switches from remote to manual operation, but only if the local lockout function has not been activated in the remote control mode.

Measurement Documentation - PRINT Key

The **PRINT** key is used to select and configure the printer and to customize the screen printout. For detailed information on printer selection and installation refer to the Quick Start Guide.

To open the print menu

- Press the **PRINT** key.
The print menu is displayed.

Menu and softkey description

- ["Softkeys of the print menu"](#) on page 4.501

To display help to a softkey, press the **HELP** key and then softkey for which you want to display help. To close the help window, press the **ESC** key. For further information refer to section "How to use the Help System".

Softkeys of the print menu

The following table shows all softkeys available in the print menu. It is possible that your instrument configuration does not provide all softkeys. If a softkey is only available with a special option, model or (measurement) mode, this information is delivered in the corresponding softkey description.

Menu / Command	Submenu / Command
Print Screen	
Device Setup	
Device 1/2	
Colors	Select Print Color Set
	Color On/Off
	Select Object
	Predefined Colors
	User Defined Colors
	Set to Default
Comment	
Install Printer	

Print Screen

Starts to printout all test results displayed on the screen: diagrams, traces, markers, marker lists, limit lines etc. Comments, title, date, and time are included at the bottom margin of the printout. All displayed items belonging to the instrument software (softkeys, tables, dialog boxes) are not printed out. The date and time can be excluded from the printout via the **Device Setup** softkey.

The output is defined via the **Device Setup** softkey. If the output is saved in a file, the file name used in the last saving process is counted up to the next unused name. If you use a file name that already exists, upon saving, a message is displayed. Selecting **Yes** overwrites the existing file, selecting **No** aborts the saving process. For further details on the file name and an example, refer to the file menu, **Edit File Name** softkey.

Path	Directory in which the file is stored. The default path is C:\r_s\instr\user
Files	List of the existing files in the same format
File Name	Name of the file

- Remote: HCOP:ITEM:ALL
- Remote: HCOP
- Remote: HCOP:NEXT

Device Setup

Opens the **Hardcopy Setup** dialog box to define the output: image file, clipboard, or the printer. The dialog box consists of two tabs which are selected via the **Device 1/2** softkey. For further information refer to the Quick Start Guide.

- Remote: HCOP:DEV:LANG GDI
- Remote: SYST:COMM:PRIN:ENUM:FIRS?
- Remote: SYST:COMM:PRIN:ENUM:NEXT?
- Remote: SYST:COMM:PRIN:SEL <Printer>
- Remote: HCOP:PAGE:ORI PORT
- Remote: HCOP:DEST "SYST:COMM:PRIN"
- Remote: HCOP:TDST:STAT?
- Remote: HCOP:TDST:STAT OFF

Device 1/2

Selects the tab of the device in the **Device Setup** dialog box. The analyzer is able to manage two print settings independently of each other. For each device the print setting is displayed on the corresponding tab of the **Device Setup** dialog box (**Device Setup** softkey). For further information refer to the Quick Start Guide.

Colors

For details see **Print Colors** softkey of the setup menu.
This softkey is available from firmware version 1.10.

Select Print Color Set

For details see **Select Print Color Set** softkey of the setup menu.
This softkey is available from firmware version 1.10.

Color On/Off

For details see **Color On/Off** softkey of the setup menu.
This softkey is available from firmware version 1.10.

Select Object

For details see **Select Object** softkey of the setup menu.

This softkey is available from firmware version 1.10.

Predefined Colors

For details see **Predefined Colors** softkey of the setup menu.

This softkey is available from firmware version 1.10.

User Defined Colors

For details see **User Defined Colors** softkey of the setup menu.

This softkey is available from firmware version 1.10.

Set to Default

For details see **Set to Default** softkey of the setup menu.

This softkey is available from firmware version 1.10.

Comment

Opens dialog box to enter a comment. Max. 120 characters are allowed. 60 characters fit in one line. In the first line, at any point a manual line-feed can be forced by entering "@".

Date and time are inserted automatically. The comment is printed below the diagram area, but not displayed on the screen. If a comment should not be printed, it must be deleted.

For details on the alphanumeric entries refer to the Quick Start Guide, chapter 4 "Basic Operations".

!!!Verweis prüfen! This softkey is available from firmware version 1.10.

Install Printer

Opens the **Printers and Faxes** window to install a new printer. All printers that are already installed are displayed. For details refer to the Quick Start Guide, appendix A, "Printer Interface".

From firmware version 2.00 upwards, only user accounts with administrator rights are able to install a printer.

Contents of Chapter 5

5 Remote Control - Basics.....	5.1
Introduction.....	5.1
Getting Started.....	5.3
Setting the Remote Control (IP/GPIB) Address	5.3
Starting Remote Control	5.4
Returning to Manual Operation.....	5.4
SCPI Command Structure and Syntax	5.5
Structure of a Command.....	5.5
Structure of a Command Line	5.7
Responses to Queries.....	5.8
Parameters.....	5.8
Overview of Syntax Elements	5.10
Instrument Model and Command Processing	5.10
Command Sequence and Command Synchronization	5.12
Status Reporting System.....	5.13
Structure of an SCPI Status Register.....	5.13
Overview of the Status Registers.....	5.15
Status Byte (STB) and Service Request Enable Register (SRE).....	5.16
IST Flag and Parallel Poll Enable Register (PPE).....	5.17
Event Status Register (ESR) and Event Status Enable Register (ESE)	5.17
STATUS:OPERation Register.....	5.18
STATUS:QUEStionable Register	5.18
STATUS:QUEStionable:ACPLimit Register.....	5.20
STATUS:QUEStionable:FREQuency Register	5.20
STATUS:QUEStionable:LIMit Register	5.21
STATUS:QUEStionable:LMARgin Register	5.22
STATUS:QUEStionable:POWEr Register.....	5.22
STATUS:QUEStionable:SYNC Register.....	5.23
Application of the Status Reporting Systems	5.24
Service Request.....	5.24
Serial Poll	5.24
Parallel Poll	5.24
Query by Means of Commands	5.25
Error Queue Query.....	5.25
Reset Values of the Status Reporting System	5.25
Interfaces and Protocols.....	5.26
LAN Interface	5.26
VXI Basics.....	5.27
VXI-11 Interface Messages.....	5.28
RSIB Protocol Basics	5.29
RSIB Interface Functions	5.29
GPIB Interface (Option R&S FSL-B10)	5.30
GPIB Basics	5.31
GPIB Interface Functions	5.31
GPIB Interface Messages	5.32
Instrument Messages.....	5.33

Noise Figure Measurements (K30) - Status Reporting System	5.34
STATus:OPERation Register	5.34
STATus:QUESTionable Register	5.34
STATus:QUESTionable:CORRection Register	5.35
Error Reporting	5.35
3GPP Base Station Measurements (K72) - Status Reporting System.....	5.36
STATus:QUESTionable:SYNC Register	5.36
CDMA2000 BTS Analyzer (K82) - Status Reporting System.....	5.37
STATus:QUESTionable:SYNC Register	5.37
WLAN TX Measurements (K91) - Status Reporting System.....	5.38
STATus:OPERation Register	5.38
STATus:QUESTionable:LIMit Register	5.38
STATus:QUESTionable:SYNC Register	5.39
Error Reporting.....	5.40
WiMAX, WiBro Measurements (K92/K93) - Status Reporting System.....	5.41
STATus:OPERation Register	5.41
STATus:QUESTionable:LIMit Register	5.41
STATus:QUESTionable:SYNC Register	5.42
Error Reporting.....	5.42

5 Remote Control - Basics

This chapter assumes basic knowledge of programming and operation of the controller. It provides the following:

- Instructions on how to put the R&S FSL into operation via remote control.
- A general introduction to remote control of programmable instruments. This includes the description of the command structure and syntax according to the SCPI standard, the description of command execution and of the status registers.
- Diagrams and tables describing the status registers used in the R&S FSL.
- A description of the interfaces and protocols used for remote control.

In chapter "Instrument Functions" of this manual and in the Online Help, the remote control commands available for an instrument function are listed after each function description. In the Online Help, these remote control commands are linked to their description, provided in the manual in chapter "Remote Control - Commands". Program examples for the R&S FSL are given in chapter 7 "Remote Control - Programming Examples".

Introduction

The instrument is equipped with the following interfaces for remote control:

- LAN interface: The protocol is based on TCP/IP and supports the VXI-11 standard.
- Option GPIB Interface, R&S FSL-B10: GPIB interface according to standard IEC 625/IEEE 488

The connectors are located at the rear of the instrument and permit a connection to a controller for remote control via a local area network (LAN) or directly (option GPIB Interface, R&S FSL-B10).

SCPI (**S**tandard **C**ommands for **P**rogrammable **I**nstruments) commands - messages - are used for remote control. Commands that are not taken from the SCPI standard follow the SCPI syntax rules. The instrument supports the SCPI version 1999. The SCPI standard is based on standard IEEE 488.2 and aims at the standardization of device-specific commands, error handling and the status registers. The tutorial "Automatic Measurement Control - A tutorial on SCPI and IEEE 488.2" from John M. Pieper (R&S order number 0002.3536.00) offers detailed information on concepts and definitions of SCPI.

The requirements that the SCPI standard places on command syntax, error handling and configuration of the status registers are explained in detail in the following sections. Tables provide a fast overview of the bit assignment in the status registers. The tables are supplemented by a comprehensive description of the status registers.

VISA is a standardized software interface library providing input and output functions to communicate with instruments. The I/O channel (LAN, GPIB...) is selected at initialization time by means of a channel-specific resource string. For more information about VISA refer to its user documentation.

The programming examples for remote control are all written in Microsoft® VISUAL BASIC®. Access to the VISA functions require the declaration of the functions and constants prior to their use in the project. This can be accomplished either by adding the modules VISA32.BAS and VPPTYPE.BAS or a reference to the VISA32.DLL to the project.

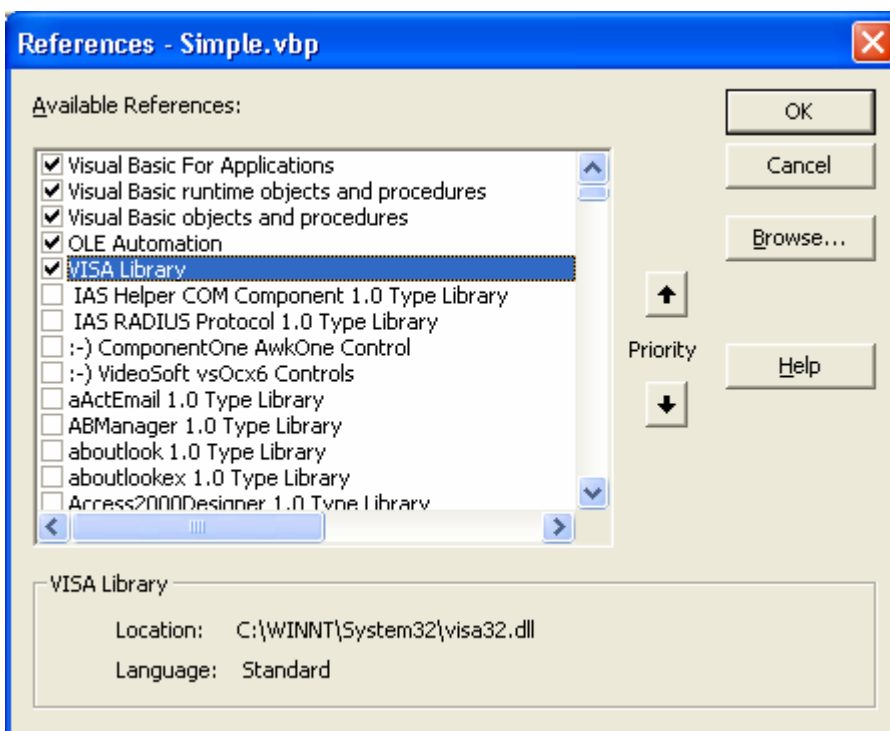
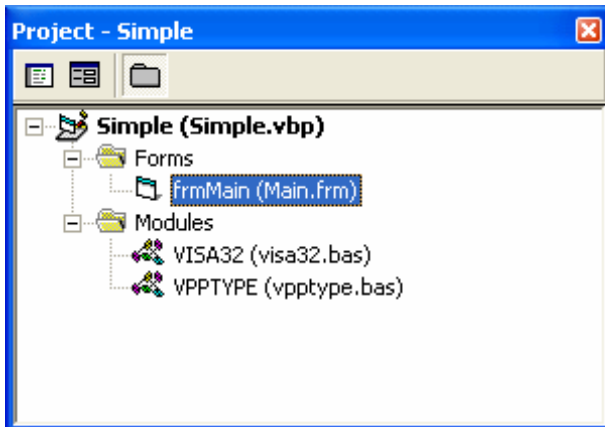

The modules `visa32.bas` and `vpptype.bas` can be found in the `<VXIlnpPath>\WinNT\include` (typically `C:\VXIlnp\WinNT\include`).



Manual operation is designed for maximum possible operating convenience. In contrast, the priority of remote control is the "predictability" of the device status. Therefore, control programs should always define an initial device status (e.g. with the command `*RST`) and then implement the required settings.

To make remote control operation more comfortable and faster, you can use IVI drivers. They bundle remote control commands, reduce the I/O to the instrument by status caching, check status and parameters and offer simulation modes.

Getting Started

The short and simple operating sequence below shows how to put the instrument into operation and quickly set its basic functions. The remote control address, which is factory-set to 10.0.0.10, subnet mask 255.255.255.0 for LAN operation and 20 for operation via GPIB, is used. If you want to change the IP address, see "[Setting the Remote Control \(IP/GPIB\) Address](#)".

To prepare for remote control

1. Connect the instrument to the LAN or directly to the GPIB controller (option GPIB Interface, R&S FSL-B10).

For details refer to the Quick Start Guide, appendix B.

2. Switch on the instruments.

3. Write and start the following program on the controller:

```

status = viOpenDefaultRM(defaultRM)           ' Open default resource manager
Cmd = "*RST;*CLS"                             ' Reset instrument and clear status
status = viWrite(vi, Cmd, Len(Cmd),          registers
retCount)

Cmd = "FREQ:CENT 100MHz"                       ' Set center frequency to 100 MHz
status = viWrite(vi, Cmd, Len(Cmd),
retCount)
Cmd = "FREQ:SPAN 10MHz"                       ' Set span to 10 MHz
status = viWrite(vi, Cmd, Len(Cmd),
retCount)
Cmd = "DISP:TRAC:Y:RLEV -10dBm"              ' Set reference level to -10 dBm
status = viWrite(vi, Cmd, Len(Cmd),
retCount)

```

The instrument now performs a sweep in the frequency range of 95 MHz to 105 MHz.

Setting the Remote Control (IP/GPIB) Address

In order to operate the instrument via remote control, it must be addressed using the set IP or GPIB address. The remote control address is factory-set (for details refer to "[Getting Started](#)"), but it can be changed, if it does not fit in the network environment.

To change the GPIB address via R&S FSL

For details see Quick Start Guide, chapter 2 "Preparing for Use".

To change the GPIB address via GPIB

```

status = viOpenDefaultRM(defaultRM)           ' Open default resource manager
status = viOpen(defaultRM, "GPIB:20::INSTR", 0, ' Open connection to instrument
5000, vi)                                     with old address
Cmd = "SYST:COMM:GPIB:ADDR 18"               ' Set instrument to new address
status = viWrite(vi, Cmd, Len(Cmd), retCount)
status = viClose(vi)                         ' Close old connection and reopen
status = viOpen(defaultRM, "GPIB:18::INSTR", 0, with new address
5000, vi)

```

To change the IP address via R&S FSL

For details see Quick Start Guide, chapter 2 "Preparing for Use".

Starting Remote Control

On power-on, the instrument is always in the manual operating state ("local" state) and can be operated via the front panel.

To start remote control

- Send an addressed command from a controller to the instrument.

The instrument is switched to remote control ("remote" state). Operation via the front panel is disabled. Only the **Local** softkey is displayed to return to manual operation. The instrument remains in the remote state until it is reset to the manual state via the instrument or via remote control interfaces. Switching from manual operation to remote control and vice versa does not affect the other instrument settings.

- During program execution, send the `SYSTem:DISPlay:UPDate ON` command to activate the display of results.

The changes in the device settings and the recorded measurement curves are displayed on the instrument screen.

- To obtain optimum performance during remote control, send the `SYSTem:DISPlay:UPDate OFF` command to hide the display of results and diagrams again (default setting in remote control).

- To prevent unintentional return to manual operation, disable the keys of the R&S FSL by the universal command LLO.

Then the transition to manual mode is only possible via remote control.

This function is only available for the GPIB interface.

- To enable the keys of the R&S FSL again, switch the instrument to local mode, i.e. deactivate the REN line of the remote control interface.



If the instrument is exclusively operated in remote control, it is recommended to switch on the power-save mode for the display. For more details on this mode refer to the Quick Start Guide.

Returning to Manual Operation

Before the transition, command processing must be completed. If command processing is not completed, it is not possible to return to manual operation and the instrument will switch back to remote control immediately.

To return to manual operation via R&S FSL

- Press the **Local** softkey or the **Preset** key.

To return to manual operation via GPIB

```
...
status = viGpibControlREN(vi,
VI_GPIB_REN_ADDRESS_GTL)
...
```

' Set instrument to manual operation

SCPI Command Structure and Syntax

SCPI (Standard Commands for Programmable Instruments) describes a standard command set for programming instruments, irrespective of the type of instrument or manufacturer. The goal of the SCPI consortium is to standardize the device-specific commands to a large extent. For this purpose, a model was developed which defines the same functions inside a device or for different devices. Command systems were generated which are assigned to these functions. Thus it is possible to address the same functions with identical commands. The command systems are of a hierarchical structure.

SCPI is based on standard IEEE 488.2, i.e. it uses the same syntactic basic elements as well as the common commands defined in this standard. Part of the syntax of the device responses is defined with greater restrictions than in standard IEEE 488.2 (see section "Responses to Queries").

Structure of a Command

The commands consist of a so-called header and, in most cases, one or more parameters. Header and parameter are separated by a "white space" (ASCII code 0 to 9, 11 to 32 decimal, e.g. blank). The headers may consist of several key words. Queries are formed by directly appending a question mark to the header.



Not all commands used in the following examples are implemented in the instrument.

Common commands

Common commands consist of a header preceded by an asterisk "*" and one or several parameters, if any.

Examples:	*RST	RESET, resets the device
	*ESE 253	EVENT STATUS ENABLE, sets the bits of the event status enable register
	*ESR?	EVENT STATUS QUERY, queries the contents of the event status register.

Device-specific commands

- Hierarchy

Device-specific commands are of hierarchical structure (see [Fig. 5-1](#)). The different levels are represented by combined headers. Headers of the highest level (root level) have only one key word. This key word denotes a complete command system.

Example: SENSE

This key word denotes the SENSE command system.

For commands of lower levels, the complete path has to be specified, starting on the left with the highest level, the individual key words being separated by a colon ":".

Example: SENSE:FREQuency:SPAN 10MHZ

This command lies in the third level of the SENSE system. It sets the frequency span.

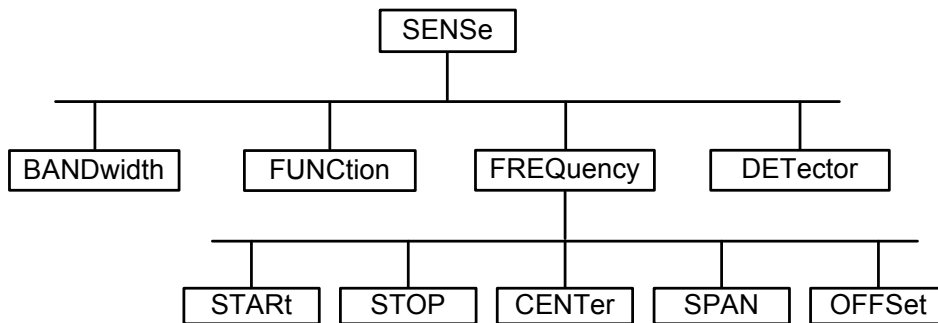

Fig. 5-1 Tree structure the SCPI command systems using the SENSE system as example

- Multiple key words

Some key words occur in several levels within one command system. Their effect depends on the structure of the command, i.e. at which position in the header of a command they are inserted.

Example: `SOURce:FM:POLarity NORMal`

This command contains key word POLarity in the third command level. It defines the polarity between modulator and modulation signal.

Example: `SOURce:FM:EXTernal:POLarity NORMal`

This command contains key word POLarity in the fourth command level. It defines the polarity between modulation voltage and the resulting direction of the modulation only for the external signal source indicated.

- Optional key words

Some command systems permit certain key words to be inserted into the header or omitted. These key words are marked by square brackets in the description. The full command length must be recognized by the instrument for reasons of compatibility with the SCPI standard. Some commands are considerably shortened by these optional key words.

Example: `[SENSe]:BANDwidth[:RESolution]:AUTO`

This command couples the resolution bandwidth of the instrument to other parameters. The following command has the same effect: `BANDwidth:AUTO`



An optional key word must not be omitted if its effect is specified in detail by a numeric suffix.

- Long and short form

The key words feature a long form and a short form. Either the short form or the long form can be entered, other abbreviations are not permitted.

Example: `STATus:QUEStionable:ENABle 1= STAT:QUES:ENAB 1`



Upper-case and lower-case notation only serves to distinguish the two forms in the manual, the instrument itself does not distinguish upper-case and lower-case letters.

- Parameter

The parameter must be separated from the header by a "white space". If several parameters are specified in a command, they are separated by a comma ",". A few queries permit the parameters MINimum, MAXimum and DEFault to be entered. For a description of the types of parameter, refer to section "Parameters".

Example: `SENSe:FREQuency:STOP? MAXimum, Response: 3.5E9`

This query requests the maximal value for the stop frequency.

- Numeric suffix

If a device features several functions or features of the same kind, e.g. inputs, the desired function can be selected by a suffix added to the command. Entries without suffix are interpreted like entries with the suffix 1. Optional keywords must be specified if they select a function with the suffix.

Example: `SYSTem:COMMunicate:SERial2:BAUD 9600`

This command sets the baud rate of a second serial interface.



In case of remote control, suffix counting may differ from the numbers of the corresponding selection used in manual operation. SCPI prescribes that suffix counting starts with 1. Suffix 1 is the default state and used when no specific suffix is specified.

Some standards define a fixed numbering, starting with 0. With GSM, for instance, slots are counted from 0 to 7. In the case of remote control, the slots are selected with the suffixes 1 to 8. If the numbering differs in manual operation and remote control, it is indicated with the respective command.

Structure of a Command Line

A command line may consist of one or several commands. It is terminated by an EOI signal together with the last data byte.

Several commands in a command line must be separated by a semicolon ";". If the next command belongs to a different command system, the semicolon is followed by a colon. A colon ":" at the beginning of a command marks the root node of the command tree.

Example:

```
CALL InstrWrite(analyzer, "SENSe:FREQuency:CENTer 100MHz;:INPut:ATTenuation 10")
```

This command line contains two commands. The first one is part of the SENSe command system and is used to determine the center frequency of the instrument. The second one is part of the INPut command system and sets the input signal attenuation.

If the successive commands belong to the same system, having one or several levels in common, the command line can be abbreviated. For that purpose, the second command after the semicolon starts with the level that lies below the common levels (see also [Fig. 5-1](#)). The colon following the semicolon must be omitted in this case.

Example:

```
CALL InstrWrite(analyzer, "SENSe:FREQuency:START 1E6;:SENSe:FREQuency:STOP 1E9")
```

This command line is represented in its full length and contains two commands separated from each other by the semicolon. Both commands are part of the SENSe command system, subsystem FREQuency, i.e. they have two common levels.

When abbreviating the command line, the second command begins with the level below `SENSe:FREQuency`. The colon after the semicolon is omitted. The abbreviated form of the command line reads as follows:

```
CALL InstrWrite(analyzer, "SENSe:FREQuency:START 1E6;STOP 1E9")
```

However, a new command line always begins with the complete path.

Example:

```
CALL InstrWrite(analyzer, "SENSe:FREQuency:START 1E6")
CALL InstrWrite(analyzer, "SENSe:FREQuency:STOP 1E9")
```

Responses to Queries

A query is defined for each setting command unless explicitly specified otherwise. It is formed by adding a question mark to the associated setting command. According to SCPI, the responses to queries are partly subject to stricter rules than in standard IEEE 488.2.

- The requested parameter is transmitted without header.
Example: `INPut:COUPling?`, Response: DC
- Maximum values, minimum values and all further quantities, which are requested via a special text parameter are returned as numerical values.
Example: `SENSe:FREQuency:STOP? MAX`, Response: 3.5E9
- Numerical values are output without a unit. Physical quantities are referred to the basic units or to the units set using the Unit command.
Example: `SENSe:FREQuency:CENTer?`, Response: 1E6 (for 1 MHz)
- Truth values <Boolean values> are returned as 0 (for OFF) and 1 (for ON).
Example: `SENSe:BANDwidth:AUTO?`, Response: 1 (for ON)
- Text (character data) is returned in a short form.
Example: `SYSTem:COMMunicate:SERial:CONTRol:RTS?`, Response STAN (for standard)

Parameters

Most commands require a parameter to be specified. The parameters must be separated from the header by a "white space". Permissible parameters are numerical values, Boolean parameters, text, character strings and block data. The type of parameter required for the respective command and the permissible range of values are specified in the command description.

Numerical values

Numerical values can be entered in any form, i.e. with sign, decimal point and exponent. Values exceeding the resolution of the instrument are rounded up or down. The mantissa may comprise up to 255 characters, the exponent must lie inside the value range -32000 to 32000. The exponent is introduced by an "E" or "e". Entry of the exponent alone is not permissible. In the case of physical quantities, the unit can be entered. Permissible unit prefixes are G (giga), MA (mega), MOHM and MHZ are also permissible), K (kilo), M (milli), U (micro) and N (nano). If the unit is missing, the basic unit is used.

Example: `SENSe:FREQuency:STOP 1.5GHz = SENSe:FREQuency:STOP 1.5E9`

Special numerical

The texts MINimum, MAXimum, DEFault, UP and DOWN are interpreted as values special numerical values. In the case of a query, the numerical value is provided.

Example:

Setting command: `SENSe:FREQuency:STOP MAXimum`

Query: `SENSe:FREQuency:STOP?`, Response: `3.5E9`

- `MIN/MAX`
MINimum and MAXimum denote the minimum and maximum value.
- `DEF`
DEFault denotes a preset value which has been stored in the EPROM. This value conforms to the default setting, as it is called by the `*RST` command
- `UP/DOWN`
UP, DOWN increases or reduces the numerical value by one step. The step width can be specified via an allocated step command (see annex C, List of Commands) for each parameter which can be set via UP, DOWN.
- `INF/NINF`
INFinity, Negative INFinity (NINF) Negative INFinity (NINF) represent the numerical values `-9.9E37` or `9.9E37`, respectively. INF and NINF are only sent as device responses.
- `NAN`
Not A Number (NAN) represents the value `9.91E37`. NAN is only sent as device response. This value is not defined. Possible causes are the division of zero by zero, the subtraction of infinite from infinite and the representation of missing values.

Boolean parameters

Boolean parameters represent two states. The ON state (logically true) is represented by ON or a numerical value unequal to 0. The OFF state (logically untrue) is represented by OFF or the numerical value 0. The numerical values are provided as response for query.

Example:

Setting command: `DISPlay:WINDow:STATe ON`

Query: `DISPlay:WINDow:STATe?`, Response: `1`

Text

Text parameters observe the syntactic rules for key words, i.e. they can be entered using a short or long form. Like any parameter, they have to be separated from the header by a white space. In the case of a query, the short form of the text is provided.

Example:

Setting command: `INPut:COUPling GROund`

Query: `INPut:COUPling?`, Response: `GRO`

Strings

Strings must always be entered in quotation marks (' or ").

Example:

`SYSTem:LANGUage "SCPI"` or `SYSTem:LANGUage 'SCPI'`

Block data

Block data are a transmission format which is suitable for the transmission of large amounts of data. A command using a block data parameter has the following structure:

Example:

`HEADer:HEADer #45168xxxxxxxx`

ASCII character # introduces the data block. The next number indicates how many of the following digits describe the length of the data block. In the example the 4 following digits indicate the length to be 5168 bytes. The data bytes follow. During the transmission of these data bytes all end or other control signs are ignored until all bytes are transmitted.

Overview of Syntax Elements

The following survey offers an overview of the syntax elements.

- : The colon separates the key words of a command. In a command line the separating semicolon marks the uppermost command level.
- ; The semicolon separates two commands of a command line. It does not alter the path.
- ,
- ? The question mark forms a query.
- * The asterisk marks a common command.
- " Quotation marks introduce a string and terminate it.
- # The hash symbol # introduces binary, octal, hexadecimal and block data.

Binary: #B10110
 Octal: #O7612
 Hexa: #HF3A7
 Block: #21312

A "white space" (ASCII-Code 0 to 9, 11 to 32 decimal, e.g. blank) separates header and parameter.

Instrument Model and Command Processing

The block diagram in Fig. 5-2 shows how SCPI commands are serviced in the instrument. The individual components work independently and simultaneously. They communicate with each other by means of so-called "messages".

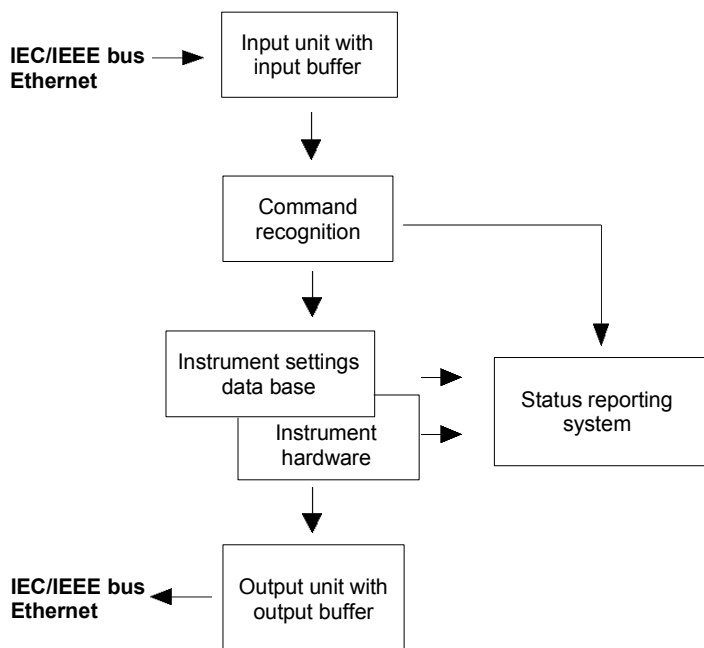

Fig. 5-2 Instrument model in the case of remote control

Input unit

The input unit receives commands character by character from the controller and collects them in the input buffer. The input unit sends a message to the command recognition as soon as the input buffer is full or as soon as it receives a delimiter, <PROGRAM MESSAGE TERMINATOR>, as defined in IEEE 488.2, or the interface message `DCL`.

If the input buffer is full, the traffic is stopped and the data received up to then are processed. Subsequently the traffic is continued. If, however, the buffer is not yet full when receiving the delimiter, the input unit can already receive the next command during command recognition and execution. The receipt of `DCL` clears the input buffer and immediately resets the command recognition.

Command recognition

The command recognition analyses the data received from the input unit. It proceeds in the order in which it receives the data. Only `DCL` is serviced with priority, for example `GET` (Group Execute Trigger) is only executed after the commands received before. Each recognized command is immediately transferred to the internal instrument settings data base but not executed immediately.

The command recognition detects syntax errors in the commands and transfers them to the status reporting system. The rest of a command line after a syntax error is analyzed further if possible and serviced. After the syntax test, the value range of the parameter is checked, if required.

If the command recognition detects a delimiter, it passes the command to an execution unit that performs the instrument settings. In the meantime, the command recognition is ready to process new commands (overlapping execution). A `DCL` command is processed in the same way.

Data base and instrument hardware

Here the expression "instrument hardware" denotes the part of the instrument fulfilling the actual instrument function - signal generation, measurement etc. The controller is not included. The term "data base" denotes a database that manages all the parameters and associated settings required for setting the instrument hardware.

Setting commands lead to an alteration in the data set. The data set management enters the new values (e.g. frequency) into the data set, however, only passes them on to the hardware when requested by the command recognition. This only takes place at the end of a command line.

The data are checked for compatibility with the current instrument settings before they are transmitted to the instrument hardware. If the execution is not possible, an "execution error" is signaled to the status reporting system. The corresponding settings are discarded.

Before passing on the data to the hardware, the settling bit in the `STATus:OPERation` register is set (refer to section "[STATus:OPERation Register](#)"). The hardware executes the settings and resets the bit again as soon as the new state has settled. This fact can be used to synchronize command servicing.

Queries induce the data set management to send the desired data to the output unit.

Status reporting system

For detailed information refer to section "[Status Reporting System](#)".

Output unit

The output unit collects the information requested by the controller, which it receives from the data base management. It processes it according to the SCPI rules and makes it available in the output buffer.

If the instrument is addressed as a talker without the output buffer containing data or awaiting data from the data base management, the output unit sends error message "Query UNTERMINATED" to the

status reporting system. No data are sent on the GPIB or via the Ethernet, the controller waits until it has reached its time limit. This behavior is specified by SCPI.

Command Sequence and Command Synchronization

What has been said above makes clear that all commands can potentially be carried out overlapping. In order to prevent an overlapping execution of commands, one of the commands *OPC, *OPC? or *WAI must be used. All three commands cause a certain action only to be carried out after the hardware has been set. By suitable programming, the controller can be forced to wait for the respective action to occur (refer to [Table 5-1](#)).

Table 5-1 Synchronization using *OPC, *OPC? and *WAI

Command	Action	Programming the controller
*OPC	Sets the Operation Complete bit in the ESR after all previous commands have been executed.	- Setting bit 0 in the ESE - Setting bit 5 in the SRE - Waiting for service request (SRQ)
*OPC?	Stops command processing until 1 is returned. This is only the case after the Operation Complete bit has been set in the ESR. This bit indicates that the previous setting has been completed.	Sending *OPC? directly after the command whose processing should be terminated before other commands can be executed.
*WAI	Stops further command processing until all commands sent before *WAI have been executed.	Sending *WAI directly after the command whose processing should be terminated before other commands are executed.

An example for command synchronization can be found in chapter 7 "Remote Control - Programming Examples".

For a couple of commands the synchronization to the end of command execution is mandatory in order to obtain the desired result. The affected commands require either more than one measurement in order to accomplish the desired instrument setting (e.g. auto range functions), or they require a longer period of time for execution. If a new command is received during execution of the corresponding function this may either lead to either to an aborted measurement or to incorrect measurement data.

The following list includes the commands, for which a synchronization via *OPC, *OPC? or *WAI is mandatory:

Table 5-2 Commands with mandatory synchronization (overlapping commands)

Command	Purpose
INIT	start measurement
INIT:CONM	continue measurement
CALC:MARK:FUNC:ZOOM	zoom frequency range around marker 1
CALC:STAT:SCAL:AUTO ONCE	optimize level settings for signal statistic measurement functions
[SENS:]POW:ACH:PRES:RLEV	optimize level settings for adjacent channel power measurements

Status Reporting System

The status reporting system (refer to Fig. 5-4) stores all information on the present operating state of the instrument, and on errors which have occurred. This information is stored in the status registers and in the error queue. The status registers and the error queue can be queried via GPIB or via the Ethernet.

The information is of a hierarchical structure. The register status byte (STB) defined in IEEE 488.2 and its associated mask register service request enable (SRE) form the uppermost level. The STB receives its information from the standard event status register (ESR) which is also defined in IEEE 488.2 with the associated mask register standard event status enable (ESE) and registers STATus:OPERation and STATus:QUESTionable which are defined by SCPI and contain detailed information on the instrument.

The IST flag ("Individual SStatus") and the parallel poll enable register (PPE) allocated to it are also part of the status reporting system. The IST flag, like the SRQ, combines the entire instrument status in a single bit. The PPE fulfills the same function for the IST flag as the SRE for the service request.

The output buffer contains the messages the instrument returns to the controller. It is not part of the status reporting system but determines the value of the MAV bit in the STB.

Structure of an SCPI Status Register

Each standard SCPI register consists of 5 parts which each have a width of 16 bits and have different functions (refer to Fig. 5-3). The individual bits are independent of each other, i.e. each hardware status is assigned a bit number that applies to all five parts. For example, bit 3 of the STATus:OPERation register is assigned to the hardware status "wait for trigger" in all five parts. Bit 15 (the most significant bit) is set to zero for all parts. Thus the contents of the register parts can be processed by the controller as positive integer.

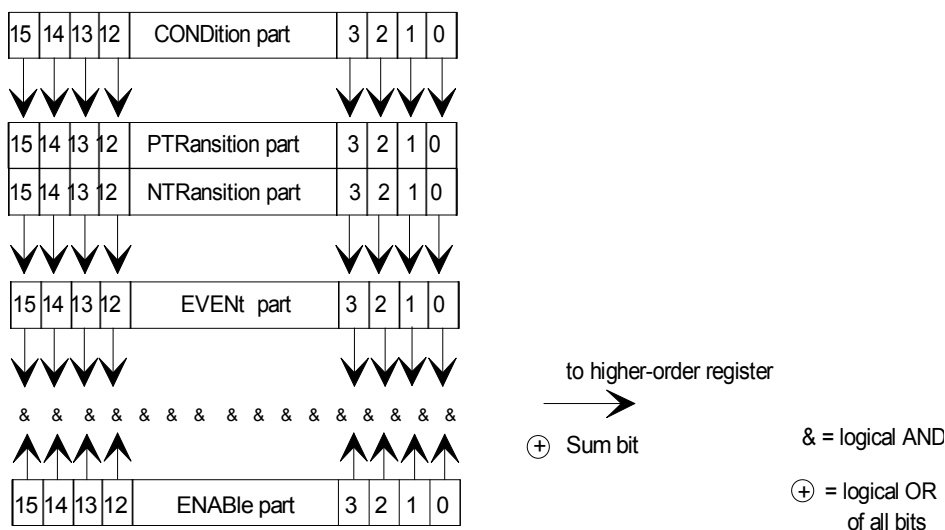

Fig. 5-3 The status-register model

CONDition part

The CONDition part is directly written into by the hardware or the sum bit of the next lower register. Its contents reflects the current instrument status. This register part can only be read, but not written into or cleared. Its contents is not affected by reading.

PTRansition part

The Positive-TRansition part acts as an edge detector. When a bit of the CONDition part is changed from 0 to 1, the associated PTR bit decides whether the EVENT bit is set to 1.

PTR bit =1: the EVENT bit is set.

PTR bit =0: the EVENT bit is not set.

This part can be written into and read at will. Its contents is not affected by reading.

NTRansition part

The Negative-TRansition part also acts as an edge detector. When a bit of the CONDition part is changed from 1 to 0, the associated NTR bit decides whether the EVENT bit is set to 1.

NTR-Bit = 1: the EVENT bit is set.

NTR-Bit = 0: the EVENT bit is not set.

This part can be written into and read at will. Its contents is not affected by reading.

With these two edge register parts the user can define which state transition of the condition part (none, 0 to 1, 1 to 0 or both) is stored in the EVENT part.

EVENT part

The EVENT part indicates whether an event has occurred since the last reading, it is the "memory" of the condition part. It only indicates events passed on by the edge filters. It is permanently updated by the instrument. This part can only be read by the user. Reading the register clears it. This part is often equated with the entire register.

ENABLE part

The ENABLE part determines whether the associated EVENT bit contributes to the sum bit (see below). Each bit of the EVENT part is ANDed with the associated ENABLE bit (symbol '&'). The results of all logical operations of this part are passed on to the sum bit via an OR function (symbol '+').

ENABLE-Bit = 0: the associated EVENT bit does not contribute to the sum bit

ENABLE-Bit = 1: if the associated EVENT bit is "1", the sum bit is set to "1" as well.

This part can be written into and read by the user at will. Its contents is not affected by reading.

Sum bit

As indicated above, the sum bit is obtained from the EVENT and ENABLE part for each register. The result is then entered into a bit of the CONDition part of the higher-order register.

The instrument automatically generates the sum bit for each register. Thus an event, e.g. a PLL that has not locked, can lead to a service request throughout all levels of the hierarchy.



The service request enable register SRE defined in IEEE 488.2 can be taken as ENABLE part of the STB if the STB is structured according to SCPI. By analogy, the ESE can be taken as the ENABLE part of the ESR.

Overview of the Status Registers

The following figure shows the status registers used by the R&S FSL base unit. The status registers used by the R&S FSL options are described in separate sections at the end of this chapter.

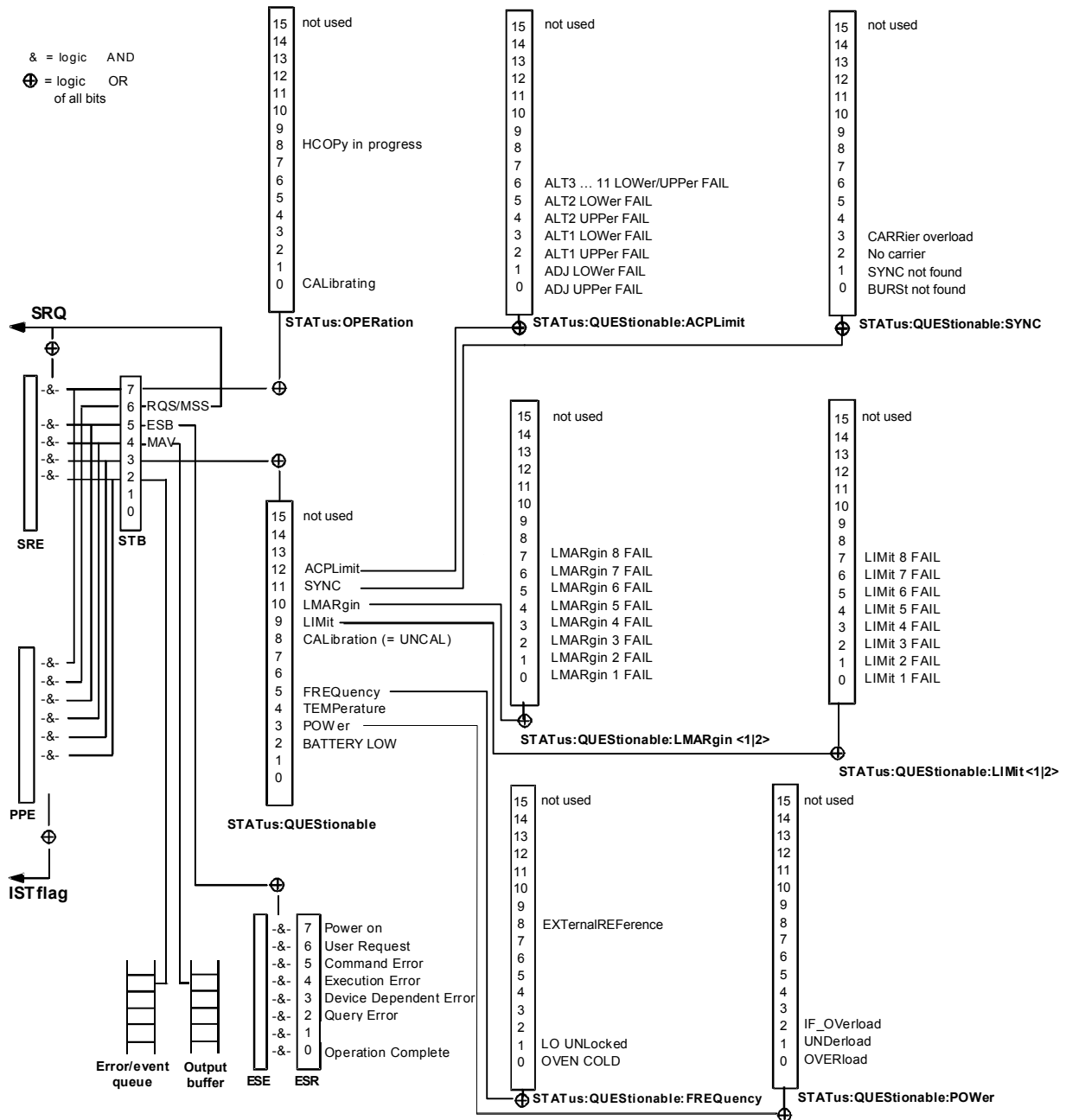

Fig. 5-4 Overview of the status registers (base unit)

Status Byte (STB) and Service Request Enable Register (SRE)

The STB is already defined in IEEE 488.2. It provides a rough overview of the instrument status by collecting the pieces of information of the lower registers. It can thus be compared with the CONDition part of an SCPI register and assumes the highest level within the SCPI hierarchy. A special feature is that bit 6 acts as the sum bit of the remaining bits of the status byte.

The STATUS BYTE is read using the command "***STB?**" or a serial poll.

The STB is linked to the SRE. The latter corresponds to the ENABle part of the SCPI registers in its function. Each bit of the STB is assigned a bit in the SRE. Bit 6 of the SRE is ignored. If a bit is set in the SRE and the associated bit in the STB changes from 0 to 1, a service request (SRQ) is generated on the GPIB or via the Ethernet, which triggers an interrupt in the controller if this is appropriately configured and can be further processed there.

The SRE can be set using the command "***SRE**" and read using the command "***SRE?**"

Table 5-3 Meaning of the bits used in the status byte

Bit No.	Meaning
0...1	Not used
2	<p>Error Queue not empty</p> <p>The bit is set when an entry is made in the error queue. If this bit is enabled by the SRE, each entry of the error queue generates a service request. Thus an error can be recognized and specified in greater detail by polling the error queue. The poll provides an informative error message. This procedure is to be recommended since it considerably reduces the problems involved with remote control.</p>
3	<p>QUESTionable status sum bit</p> <p>The bit is set if an EVENT bit is set in the QUESTionable: status register and the associated ENABle bit is set to 1. A set bit indicates a questionable instrument status, which can be specified in greater detail by polling the QUESTionable status register.</p>
4	<p>MAV bit (message available)</p> <p>The bit is set if a message is available in the output buffer which can be read. This bit can be used to enable data to be automatically read from the instrument to the controller.</p>
5	<p>ESB bit</p> <p>Sum bit of the event status register. It is set if one of the bits in the event status register is set and enabled in the event status enable register. Setting of this bit indicates a serious error which can be specified in greater detail by polling the event status register.</p>
6	<p>MSS bit (master status summary bit)</p> <p>The bit is set if the instrument triggers a service request. This is the case if one of the other bits of this registers is set together with its mask bit in the service request enable register SRE.</p>

Bit No.	Meaning
7	<p>OPERation status register sum bit</p> <p>The bit is set if an EVENT bit is set in the OPERation status register and the associated ENABLE bit is set to 1.</p> <p>A set bit indicates that the instrument is just performing an action. The type of action can be determined by polling the OPERation status register.</p>

IST Flag and Parallel Poll Enable Register (PPE)

By analogy with the SRQ, the IST flag combines the entire status information in a single bit. It can be read by means of a parallel poll (refer to section "[Parallel Poll](#)") or using the command `*IST?`.

The parallel poll enable register (PPE) determines which bits of the STB contribute to the IST flag. The bits of the STB are ANDed with the corresponding bits of the PPE, with bit 6 being used as well in contrast to the SRE. The IST flag results from the ORing of all results. The PPE can be set using commands `*PRE` and read using command `*PRE?`.

Event Status Register (ESR) and Event Status Enable Register (ESE)

The ESR is defined in IEEE 488.2. It can be compared with the EVENT part of a SCPI register. The event status register can be read out using command `*ESR?`.

The ESE is the associated ENABLE part. It can be set using the command `*ESE` and read using the command `*ESE?`.

Table 5-4 Meaning of the bits in the event status register

Bit No.	Meaning
0	<p>Operation Complete</p> <p>This bit is set on receipt of the command <code>*OPC</code> exactly when all previous commands have been executed.</p>
1	Not used
2	<p>Query Error</p> <p>This bit is set if either the controller wants to read data from the instrument without having sent a query, or if it does not fetch requested data and sends new instructions to the instrument instead. The cause is often a query which is faulty and hence cannot be executed.</p>
3	<p>Device-dependent Error</p> <p>This bit is set if a device-dependent error occurs. An error message with a number between -300 and -399 or a positive error number, which denotes the error in greater detail, is entered into the error queue.</p>

Bit No.	Meaning
4	Execution Error This bit is set if a received command is syntactically correct but cannot be performed for other reasons. An error message with a number between -200 and -300, which denotes the error in greater detail, is entered into the error queue.
5	Command Error This bit is set if a command is received, which is undefined or syntactically incorrect. An error message with a number between -100 and -200, which denotes the error in greater detail, is entered into the error queue.
6	User Request This bit is set on pressing the Local softkey.
7	Power On (supply voltage on) This bit is set on switching on the instrument.

STATus:OPERation Register

In the CONDition part, this register contains information on which actions the instrument is being executing or, in the EVEnt part, information on which actions the instrument has executed since the last reading. It can be read using the commands STATus:OPERation:CONDition? or STATus:OPERation[:EVEnt]?

Table 5-5 Meaning of the bits in the STATus:OPERation register

Bit No.	Meaning
0	CALibrating This bit is set as long as the instrument is performing a calibration.
1 to 7	Not used
8	HardCOPy in progress This bit is set while the instrument is printing a hardcopy.
9 to 14	Not used
15	This bit is always 0

STATus:QUEStionable Register

This register contains information about indefinite states which may occur if the unit is operated without meeting the specifications. It can be read using the commands STATus:QUEStionable:CONDition? and STATus:QUEStionable[:EVEnt]?

Table 5-6 Meaning of bits in STATus:QUEStionable register

Bit No.	Meaning
0 to 1	These bits are not used
2	BATTERY LOW If the instrument is running without any external power supply and the charging level of the internal battery is approximately lower than 5% this bit is set to indicate that the system will be shut down automatically in approx. 5 minutes.
3	POWER This bit is set if a questionable power occurs (refer also to section " STATus:QUEStionable:POWER Register ")
4	TEMPERature This bit is set if a questionable temperature occurs.
5	FREQuency The bit is set if a frequency is questionable (refer to section " STATus:QUEStionable:FREQuency Register ")
6 to 7	Not used
8	CALibration The bit is set if a measurement is performed unaligned (label UNCAL)
9	LIMit (device-specific) This bit is set if a limit value is violated (see also section " STATus:QUEStionable:LIMit Register ")
10	LMARgin (device-specific) This bit is set if a margin is violated (see also section " STATus:QUEStionable:LMARgin Register ")
11	SYNC (device-dependent) This bit is set if, in measurements or pre-measurements, synchronization to midamble fails or no burst is found. This bit is also set if, in pre-measurements mode, the result differs too strongly from the expected value (see also " STATus:QUEStionable:SYNC Register ").
12	ACPLimit (device-specific) This bit is set if a limit for the adjacent channel power measurement is violated (see also section " STATus:QUEStionable:ACPLimit Register ")
13 to 14	Not used
15	This bit is always 0.

STATUS:QUESTIONABLE:ACPLimit Register

This register contains information about the observance of limits during adjacent power measurements. It can be read using the commands 'STATUS:QUESTIONABLE:ACPLimit :CONDITION?' and 'STATUS:QUESTIONABLE:ACPLimit[:EVENT]?'

Table 5-7 Meaning of bits in STATUS:QUESTIONABLE:ACPLimit register

Bit No.	Meaning
0	ADJ UPPER FAIL This bit is set if the limit is exceeded in the upper adjacent channel
1	ADJ LOWER FAIL This bit is set if the limit is exceeded in the lower adjacent channel.
2	ALT1 UPPER FAIL This bit is set if the limit is exceeded in the upper 1st alternate channel.
3	ALT1 LOWER FAIL This bit is set if the limit is exceeded in the lower 1st alternate channel.
4	ALT2 UPPER FAIL This bit is set if the limit is exceeded in the upper 2nd alternate channel.
5	ALT2 LOWER FAIL This bit is set if the limit is exceeded in the lower 2nd alternate channel.
6	ALT3 ... 11 LOWER/UPPER FAIL This bit is set if the limit is exceeded in one off the lower or upper alternate channels 3 ... 11
7 to 14	Not used
15	This bit is always set to 0.

STATUS:QUESTIONABLE:FREQUENCY Register

This register contains information about the reference and local oscillator. It can be read using the commands STATUS:QUESTIONABLE:FREQUENCY:CONDITION? and STATUS :QUESTIONABLE:FREQUENCY[:EVENT]?

Table 5-8 Meaning of bits in STATUS:QUESTIONABLE:FREQUENCY register

Bit No.	Meaning
0	OVEN COLD This bit is set if the reference oscillator has not yet attained its operating temperature. OCXO is displayed.
1	LO UNLOCKED This bit is set if the local oscillator no longer locks. LOUNL is displayed.
2 to 7	Not used

Bit No.	Meaning
8	EXTernalREFerence Bit 8 indicates that the external reference oscillator is selected and no useable external reference source is connected to the instrument. Therefore the synthesizer can not lock and the frequency accuracy is not guaranteed.
9 to 14	Not used
15	This bit is always 0.

STATus:QUEStionable:LIMit Register

This register contains information about the observance of limit lines. It can be read using the commands `STATus:QUEStionable:LIMit:CONDition?` and `STATus:QUEStionable:LIMit[:EVENT]?`.

Table 5-9 Meaning of bits in STATus:QUEStionable:LIMit register

Bit No.	Meaning
0	LIMit 1 FAIL This bit is set if limit line 1 is violated.
1	LIMit 2 FAIL This bit is set if limit line 2 is violated.
2	LIMit 3 FAIL This bit is set if limit line 3 is violated.
3	LIMit 4 FAIL This bit is set if limit line 4 is violated.
4	LIMit 5 FAIL This bit is set if limit line 5 is violated.
5	LIMit 6 FAIL This bit is set if limit line 6 is violated.
6	LIMit 7 FAIL This bit is set if limit line 7 is violated.
7	LIMit 8 FAIL This bit is set if limit line 8 is violated.
8 to 14	Not used
15	This bit is always 0.

STATUS:QUESTIONABLE:LMARGIN Register

This register contains information about the observance of limit margins. It can be read using the commands `STATUS:QUESTIONABLE:LMARGIN:CONDITION?` and `STATUS:QUESTIONABLE:LMARGIN[:EVENT]?`.

Table 5-10 Meaning of bits in STATUS:QUESTIONABLE:LMARGIN register

Bit No.	Meaning
0	LMARGIN 1 FAIL This bit is set if limit margin 1 is violated.
1	LMARGIN 2 FAIL This bit is set if limit margin 2 is violated.
2	LMARGIN 3 FAIL This bit is set if limit margin 3 is violated.
3	LMARGIN 4 FAIL This bit is set if limit margin 4 is violated.
4	LMARGIN 5 FAIL This bit is set if limit margin 5 is violated.
5	LMARGIN 6 FAIL This bit is set if limit margin 1 is violated.
6	LMARGIN 7 FAIL This bit is set if limit margin 7 is violated.
7	LMARGIN 8 FAIL This bit is set if limit margin 8 is violated.
8 to 14	Not used
15	This bit is always 0.

STATUS:QUESTIONABLE:POWER Register

This register contains all information about possible overloads of the unit. It can be read using the commands `STATUS:QUESTIONABLE:POWER:CONDITION?` and `STATUS:QUESTIONABLE:POWER[:EVENT]?`.

Table 5-11 Meaning of bits in STATUS:QUESTIONABLE:POWER register

Bit No.	Meaning
0	OVERload This bit is set if the RF input is overloaded. OVLD is displayed.
1	UNDERload This bit is set if the RF input is underloaded. UNLD is displayed.

Bit No.	Meaning
2	IF_Overload This bit is set if the IF path is overloaded. IFOVL is displayed.
3 to 14	Not used
15	This bit is always 0.

STATus:QUEStionable:SYNC Register

This register contains information about sync and bursts not found, and about pre-measurement results exceeding or falling short of expected values (for details on GSM power measurements refer to chapter "Advanced Measurement Examples", and the Quick Start Guide, chapter 5, "Basic Measurement Examples").

It can be read using the commands `STATus:QUEStionable:SYNC:CONDition?` and `STATus:QUEStionable:SYNC[:EVENT]?`.

Table 5-12 Meaning of bits in STATus:QUEStionable:SYNC register

Bit No.	Meaning
0	BURSt not found This bit is set if no burst is found in the measurements/pre-measurements for phase/frequency error (PFE) or carrier power versus time (PVT). If a burst is found in these measurements/pre-measurements, the bit is reset.
1	SYNC not found This bit is set if the synchronization sequence (training sequence) of the midamble is not found in the measurements/pre-measurements for phase/frequency error (PFE) or carrier power versus time (PVT). If the synchronization sequence (training sequence) of the midamble is found in these measurements/pre-measurements, the bit is reset. With option TV Trigger (B6), this bis is set in the free run trigger mode if the trigger does not return data.
2	No carrier This bit is set if the level value determined in the pre-measurements for carrier power versus time (PVT) and spectrum due to modulation is too low. The bit is reset at the beginning of the pre-measurement.
3	Carrier overload This bit is set if the level value determined in the pre-measurements for carrier versus time (PVT) and spectrum due to modulation is too high. The bit is reset at the beginning of the pre-measurement.
4-14	Not used.
15	This bit is always 0.

Application of the Status Reporting Systems

In order to be able to effectively use the status reporting system, the information contained there must be transmitted to the controller and further processed there. There are several methods which are represented in the following. For detailed program examples refer to chapter 7 "Remote Control - Programming Examples".

Service Request

Under certain circumstances, the instrument can send a service request (SRQ) to the controller. Usually this service request initiates an interrupt at the controller, to which the control program can react appropriately. As evident from

Fig. 5-4, an SRQ is always initiated if one or several of bits 2, 3, 4, 5 or 7 of the status byte are set and enabled in the SRE. Each of these bits combines the information of a further register, the error queue or the output buffer. The ENABLE parts of the status registers can be set so that arbitrary bits in an arbitrary status register initiate an SRQ. In order to make use of the possibilities of the service request effectively, all bits should be set to "1" in enable registers SRE and ESE.

Example: Use of the command *OPC to generate an SRQ at the end of a sweep

1. `CALL InstrWrite(analyzer, "*ESE 1")` 'Set bit 0 in the ESE (Operation Complete)
2. `CALL InstrWrite(analyzer, "*SRE 32")` 'Set bit 5 in the SRE (ESB)?

After its settings have been completed, the instrument generates an SRQ.

The SRQ is the only possibility for the instrument to become active on its own. Each controller program should set the instrument in a way that a service request is initiated in the case of malfunction. The program should react appropriately to the service request. A detailed example for a service request routine is to be found in chapter 7 "Remote Control - Programming Examples".

Serial Poll

In a serial poll, just as with command *STB, the status byte of an instrument is queried. However, the query is realized via interface messages and is thus clearly faster. The serial-poll method has already been defined in IEEE 488.1 and used to be the only standard possibility for different instruments to poll the status byte. The method also works with instruments which do not adhere to SCPI or IEEE 488.2.

The VISUAL BASIC command for executing a serial poll is `IBRSP()`. Serial poll is mainly used to obtain a fast overview of the state of several instruments connected to the controller.

Parallel Poll

In a parallel poll, the controller uses a single command to request up to eight instruments to transmit one bit of information each on the data lines, i.e., to set the data line allocated to each instrument to a logical "0" or "1". In addition to the SRE register, which determines the conditions under which an SRQ is generated, there is a parallel poll enable register (PPE). This register is ANDed with the STB bit by bit, considering bit 6 as well. The results are ORed, the result is possibly inverted and then sent as a response to the parallel poll of the controller. The result can also be queried without parallel poll by means of the command *IST?.

The instrument first has to be set for the parallel poll using the VISUAL BASIC command `IBPPC()`. This command allocates a data line to the instrument and determines whether the response is to be inverted. The parallel poll itself is executed using `IBRPP()`.

The parallel poll method is mainly used to find out quickly which one of the instruments connected to the controller has sent a service request. To this effect, SRE and PPE must be set to the same value.

Query by Means of Commands

Each part of any status register can be read by means of queries. The individual commands are listed in the description of the STATus Subsystem. The returned value is always a number that represents the bit pattern of the queried register. This number is evaluated by the controller program.

Queries are usually used after an SRQ in order to obtain more detailed information on the cause of the SRQ.

Error Queue Query

Each error state in the instrument leads to an entry in the error queue. The entries of the error queue are detailed plain-text error messages that can be displayed via manual operation using the setup menu or queried via remote control using the command `SYSTem:ERRor?`. Each call of `SYSTem:ERRor?` provides one entry from the error queue. If no error messages are stored there any more, the instrument responds with 0, "No error".

The error queue should be queried after every SRQ in the controller program as the entries describe the cause of an error more precisely than the status registers. Especially in the test phase of a controller program the error queue should be queried regularly since faulty commands from the controller to the instrument are recorded there as well.

Reset Values of the Status Reporting System

Table 5-13 contains the different commands and events causing the status reporting system to be reset. None of the commands, except `*RST` and `SYSTem:PRESet`, influences the functional instrument settings. In particular, `DCL` does not change the instrument settings.

Table 5-13 Resetting the status reporting system

Event	Switching on supply voltage		DCL,SDC (Device Clear, Selected Device Clear)	*RST or SYSTem:PRE Set	STATus:PRE Set	*CLS
	Power-On-Status-Clear					
	0	1				
Clear STB,ESR	—	yes	—	—	—	yes
Clear SRE,ESE	—	yes	—	—	—	—
Clear PPE	—	yes	—	—	—	—
Clear EVENT parts of the registers	—	yes	—	—	—	yes

Event	Switching on supply voltage		DCL,SDC (Device Clear, Selected Device Clear)	*RST or SYSTem:PRE Set	STATus:PRE Set	*CLS
	Power-On-Status-Clear					
	0	1				
Effect						
Clear ENABLE parts of all OPERation and QUEStionable registers; Fill ENABLE parts of all other registers with "1".	—	yes	—	—	yes	—
Fill PTRansition parts with "1"; Clear NTRansition parts	—	yes	—	—	yes	—
Clear error queue	yes	yes	—	—	—	yes
Clear output buffer	yes	yes	yes	1)	1)	1)
Clear command processing and input buffer	yes	yes	yes	—	—	—

1)Every command being the first in a command line, i.e., immediately following a <PROGRAM MESSAGE TERMINATOR> clears the output buffer.

Interfaces and Protocols

The standard instrument is accessed via LAN in order to perform for remote control. Optional a GPIB interface can be used for remote control, provided by option GPIB Interface, R&S FSL-B10.

LAN Interface

To be integrated in a LAN, the instrument is equipped with a LAN interface, consisting of a connector, a network interface card and protocols (VXI-11 and RSIB). For details on the connector and its use refer to the Quick Start Guide, chapter 1 "Front and Rear Panel".

Instrument access via VXI11 or RSIB is usually achieved from high level programming platforms by using VISA as an intermediate abstraction layer. VISA encapsulates the low level VXI, RSIB or even GPIB function calls and thus makes the transport interface transparent for the user. The necessary VISA library is available as a separate product. For details contact your local R&S sales representative.

VXI Basics

The VXI-11 standard is based on the RPC protocol which in turn relies on TCP/IP as the network/transport layer. The TCP/IP network protocol and the associated network services are preconfigured. TCP/IP ensures connection-oriented communication, where the order of the exchanged messages is adhered to and interrupted links are identified. With this protocol, messages cannot be lost.

Remote control of an instrument via a network is based on standardized protocols which follow the OSI reference model (see Fig. below).

Application	SCPI
Presentation	XDR (VXI-11)
Session	ONC-RPC
Transport	TCP / UDP
Network	IP
Data Link	Ethernet/802.3
Physical	802.3/10BASE-T

Fig. 5-5 Example for LAN remote control based on the OSI reference model

Based on TCP/UDP, messages between the controller and the instrument are exchanged via open network computing (ONC) - remote procedure calls (RPC). With XDR (VXI-11), legal RPC messages are known as VXI-11 standard. Based on this standard, messages are exchanged between the controller and the instrument. The messages are identical with SCPI commands. They can be organized in four groups:

- program messages (control command to the instrument)
- response messages (values returned by the instrument)
- service request (spontaneous queries of the instrument)
- low-level control messages (interface messages).

A VXI-11 link between a controller and an instrument uses three channels: core, abort and interrupt channel. Instrument control is mainly performed on the core channel (program, response and low-level control messages). The abort channel is used for immediate abort of the core channel; the interrupt channel transmits spontaneous service requests of the instrument. Link setup itself is very complex. For more details refer to the VXI-11 specification.

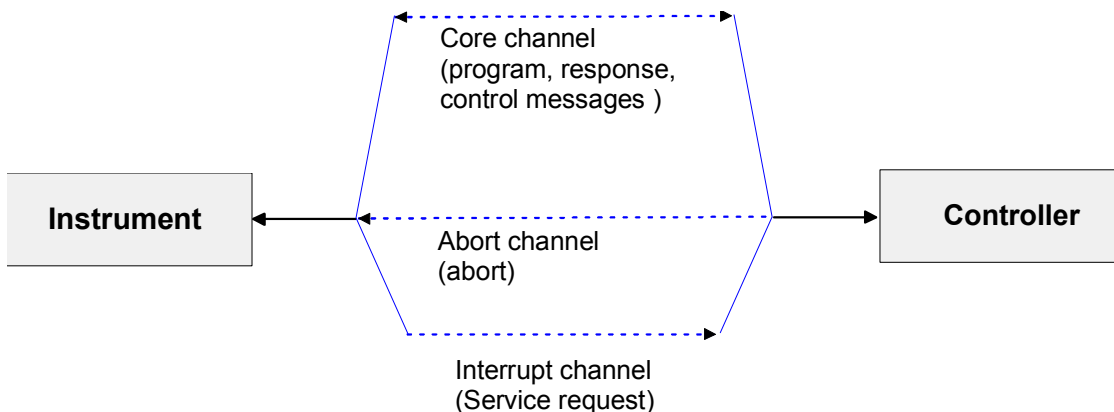

Fig. 5-6 VXI-11 channels between instrument and controller

The number of controllers that can address an instrument is practically unlimited in the network. In the instrument, the individual controllers are clearly distinguished. This distinction continues up to the application level in the controller, i.e. two applications on a computer are identified by the instrument as two different controllers.

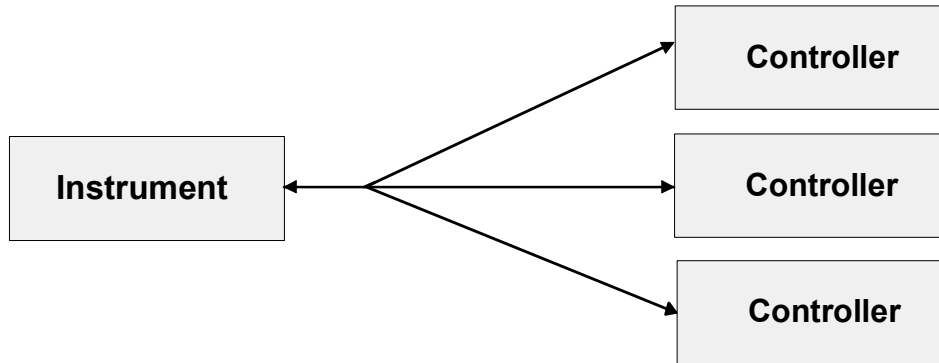

Fig. 5-7 Remote control via LAN from several controllers

The controllers can lock and unlock the instrument for exclusive access. This regulates access to the instrument of several controllers.

VXI-11 Interface Messages

On the Ethernet link, the interface messages are called low-level control messages. These messages can be used to emulate interface messages of the GPIB.

Table 5-14 VXI-11 Interface Messages

Command	Effect on the instrument
&ABO (Abort)	Aborts the processing of the commands just received.
&DCL (Device Clear)	Aborts the processing of the commands just received and sets the command processing software to a defined initial state. Does not change the instrument setting.
>L (Go to Local)	Transition to the "Local" state (manual operation)
>R (Go to Remote)	Transition to the "Remote" state (remote control)
&GET (Group Execute Trigger)	Triggers a previously active device function (e.g. a sweep). The effect of the command is the same as with that of a pulse at the external trigger signal input.
&LLO (Local Lockout)	Disables switchover from remote control to manual operation by means of the front panel keys
&POL (Serial Poll)	Starts a serial poll
&NREN (Not Remote Enable)	Enables switchover from remote control to manual operation by means of the front panel keys

RSIB Protocol Basics

The R&S defined RSIB protocol uses the TCP/IP protocol for communication with the instrument. Remote control over RSIB is done on a message level basis using the SCPI command set of the instrument. The RSIB protocol allows you to control the instrument not only via Visual C++- and Visual Basic programs but also via the two Windows applications WinWord and Excel as well as via National Instruments LabView, LabWindows/CVI and Agilent VEE. The control applications run on an external computer in the network.

A UNIX operating system can be installed on an external computer in addition to a Windows operating system. In this case, the control applications are created either in C or C++. The supported UNIX operating systems include:

- Sun Solaris 2.6 Sparc Station
- Sun Solaris 2.6 Intel Platform
- Red Hat Linux 6.2 x86 Processors

RSIB Interface Functions

The library functions are adapted to the interface functions of National Instruments for GPIB programming. The functions supported by the libraries are listed in the following table.

Function	Description
RSDLLibfind()	Provides a handle for access to a device.
RSDLLibwrt()	Sends a zero-terminated string to a device.
RSDLLilwrt()	Sends a certain number of bytes to a device.
RSDLLibwrtf()	Sends the contents of a file to a device.
RSDLLibrd()	Reads data from a device into a string.
RSDLLilrd()	Reads a certain number of bytes from a device.
RSDLLibrdf()	Reads data from a device into a file.
RSDLLibtmo()	Sets timeout for RSIB functions.
RSDLLibsre()	Switches a device to the local or remote state.
RSDLLibloc()	Temporarily switches a device to the local state.
RSDLLibeot()	Enables/disables the END message for write operations.
RSDLLibrsp()	Performs a serial poll and provides the status byte.
RSDLLibonl()	Sets the device online/offline.
RSDLLTestSrqr()	Checks whether a device has generated an SRQ.
RSDLLWaitSrqr()	Waits until a device generates an SRQ.
RSDLLSwapBytes	Swaps the byte sequence for binary numeric display (only required for non-Intel platforms).

As with the National Instrument interface, the successful execution of a command can be checked by means of the variables `ibsta`, `iberr` and `ibcntl`. For this purpose, all RSIB functions are assigned references to these three variables.

Status word - `ibsta`

The status word `ibsta` provides information on the status of the RSIB interface. The following bits are defined:

Bit designation	Bit	Hex code	Description
ERR	15	8000	Is set when an error has occurred on calling a function. If this bit is set, <code>iberr</code> contains an error code that specifies the error in greater detail.
TIMO	14	4000	Is set when a timeout has occurred on calling a function.
CMPL	8	0100	Is set if the response of the GPIB parser has been read out completely. If a parser response is read out with the function <code>RSDLl1rd()</code> and the length of the buffer is insufficient for the answer, the bit will be cleared.

Error variable - `iberr`

If the ERR bit (8000h) is set in the status word, `iberr` contains an error code which allows the error to be specified in greater detail. Extra error codes are defined for the RSIB protocol, independent of the National Instruments interface.

Error	Error code	Description
IBERR_CONNECT	2	Setup of the connection to the measuring instrument has failed.
IBERR_NO_DEVICE	3	A function of the interface has been called with an illegal device handle.
IBERR_MEM	4	No empty memory available.
IBERR_TIMEOUT	5	Timeout has occurred.
IBERR_BUSY	6	The RSIB protocol is blocked by a function that is still running.
IBERR_FILE	7	Error when reading or writing to a file.
IBERR_SEMA	8	Error upon creating or assigning a semaphore (only under UNIX).

Count variable - `ibcnt1`

The variable `ibcnt1` is updated with the number of transferred bytes each time a read or write function is called.

GPIB Interface (Option R&S FSL-B10)

The standard instrument is not equipped with an GPIB connector, but can be accessed via the LAN interface for remote control. The option R&S FSL-B10 provides a GPIB interface. For details on the connector and its use refer to the Quick Start Guide, chapter 1 "Front and Rear Panel".

GPIB Basics

The GPIB interface is described by the following characteristics:

- 8-bit parallel data transfer
- bi-directional data transfer
- three-line handshake
- high data transfer rate of max. 700 kbyte/s
- up to 15 instruments can be connected
- maximal length of the interconnecting cables 15 m (single connection, 2m)
- wired-OR connection if several instruments are connected in parallel.

Depending on the bus type the following bus lines are used:

- Data bus with 8 lines D0 to D7.
The transmission is bit-parallel and byte-serial in the ASCII/ISO code. D0 is the least significant bit, D7 the most significant bit.
- Control bus with 5 lines

IFC (Interface Clear)	active LOW resets the interfaces of the instruments connected to the default setting.
ATN (Attention)	active LOW signals the transmission of interface messages. inactive HIGH signals the transmission of device messages.
SRQ (Service Request)	active LOW enables the connected device to send a service request to the controller.
REN (Remote Enable)	active LOW permits switchover to remote control.
EOI (End or Identify)	has two functions in connection with ATN: ATN = HIGH active LOW marks the end of data transmission. ATN = LOW active LOW triggers a parallel poll.
- Handshake bus with three lines

DAV (Data Valid)	active LOW signals a valid data byte on the data bus.
NRFD (Not Ready For Data)	active LOW signals that one of the connected devices is not ready for data transfer.
NDAC (Not Data Accepted)	active LOW signals that the instrument connected is accepting the data on the data bus.

GPIB Interface Functions

Instruments which can be remote controlled via the GPIB can be equipped with different interface functions. Table 5-1 lists the interface functions appropriate for the instrument.

Table 5-1 Interface functions

Control character	Interface function
SH1	Handshake source function (source handshake), full capability
AH1	Handshake sink function (acceptor handshake), full capability
L4	Listener function, full capability, unaddress if MTA.

Control character	Interface function
T6	Talker function, full capability, ability to respond to serial poll, unaddress if MLA
SR1	Service request function (Service Request), full capability
PP1	Parallel poll function, full capability
RL1	Remote/Local switch over function, full capability
DC1	Reset function (Device Clear), full capability
DT1	Trigger function (Device Trigger), full capability
C0	No controller function

GPIB Interface Messages

The messages transferred via the data lines of the GPIB can be divided into two groups: interface messages and device messages

Interface messages are transferred on the data lines of the GPIB if the "ATN" control line is active (LOW). They are used for communication between controller and instruments and can only be sent by the controller which currently has control of the GPIB.

Universal Commands

The universal commands are encoded 10 - 1F hex. They affect all instruments connected to the bus without addressing.

Table 5-2 Universal Commands

Command	QuickBASIC command	Effect on the instrument
DCL (Device Clear)	IBCMD (controller%, CHR\$(20))	Aborts the processing of the commands just received and sets the command processing software to a defined initial state. Does not change the instrument settings.
IFC (Interface Clear)	IBSIC (controller%)	Resets the interfaces to the default setting.
LLO (Local Lockout)	IBCMD (controller%, CHR\$(17))	The LOC/IEC ADDR key is disabled.
SPE (Serial Poll Enable)	IBCMD (controller%, CHR\$(24))	Ready for serial poll.
SPD (Serial Poll Disable)	IBCMD (controller%, CHR\$(25))	End of serial poll.
PPU (Parallel Poll Unconfigure)	IBCMD (controller%, CHR\$(21))	End of the parallel-poll state.

Addressed Commands

The addressed commands are encoded 00 - 0F hex. They are only effective for instruments addressed as listeners.

Table 5-3: Addressed Commands

Command	QuickBASIC command	Effect on the instrument
SDC(Selected Device Clear)	IBCLR (device%)	Aborts the processing of the commands just received and sets the command processing software to a defined initial state. Does not change the instrument setting.
GET(Group Execute Trigger)	IBTRG (device%)	Triggers a previously active device function (e.g. a sweep). The effect of the command is the same as with that of a pulse at the external trigger signal input.
GTL (Go to Local)	IBLOC (device%)	Transition to the "Local" state (manual operation).
PPC (Parallel Poll Configure)	IBPPC (device%, data%)	Configure instrument for parallel poll. Additionally, the QuickBASIC command executes PPE/PPD.

Instrument Messages

For different interfaces, device messages are more or less alike. They are divided into two groups, depending on the direction they are sent: commands and device responses.

Commands

Commands (program messages) are messages the controller sends to the instrument. They operate the device functions and request information. The commands are subdivided according to two criteria:

- According to the effect they have on the instrument:
 - *Setting commands* cause instrument settings such as a reset of the instrument or setting the frequency.
 - *Queries* cause data to be provided for remote control, e.g. for identification of the device or polling a parameter value. Queries are formed by directly appending a question mark to the header.
- According to their definition in standard:
 - *Common commands* are exactly defined as to their function and notation in standard IEEE 488.2. They refer to functions such as management of the standardized status registers, reset and self test.
 - *Device-specific commands* refer to functions depending on the features of the instrument such as frequency setting. A majority of these commands has also been standardized by the SCPI committee. Device-specific extensions following the SCPI rules are permitted by the standard.

Device responses

Device responses (response messages and service request) are messages the instrument sends to the controller after a query. They can contain measurement results, instrument settings and information on the instrument status (refer to section "Responses to Queries").

Noise Figure Measurements (K30) - Status Reporting System

Additionally to the registers provided by the base system, the following registers are used or modified in the Noise Figure Measurements option (K30):

- [STATus:OPERation Register](#)
Although this register is provided by the base system, the Noise Figure Measurements option makes use of bits not used within the base system.
- [STATus:QUEStionable Register](#)
Although this register is provided by the base system, the Noise Figure Measurements option uses different bits and definitions.
- [STATus:QUEStionable:CORRection Register](#)
This register is provided by the R&S FS-K30 option.

The following registers are provided by the base system and are not available from the Noise Figure Measurements option (K30) command tree:

- [STATus:QUEStionable:ACPLimit Register](#)
- [STATus:QUEStionable:LIMit Register](#)
- [STATus:QUEStionable:LMARgin Register](#)
- [STATus:QUEStionable:POWer Register](#)

Detailed information on the status registers of the base system is given in section [Status Reporting System](#). In this section, only the new and altered status registers / bits for the Noise Figure Measurements option (K30) are described.

This option is available from firmware version 1.50.

STATus:OPERation Register

Additionally to the bits assigned by the base system (for details refer to [STATus:OPERation Register](#)), the bits no. 4 and 7 are defined:

Bit No	Meaning
4	MEASuring A '1' in this bit position indicates that a measurement is in progress.
7	CORRection Indicates that a user calibration is in progress.

STATus:QUEStionable Register

Additionally to the bits assigned by the base system (for details refer to [STATus:QUEStionable Register](#)), the bit no. 11 is defined differently:

Bit No	Meaning
11	CORRection This bit is set if a questionable correction data occurs (see also section STATus:QUEStionable:CORRection Register).

STATus:QUEStionable:CORRection Register

This register comprises information about the correction state of noise measurements. It can be queried by `STATus:QUEStionable:CONDition?` and `STATus:QUEStionable[:EVENT]?` commands.

Bit No	Meaning
0	NO CORRection User calibration is required (i.e. not done, or setup changed). Will remain 1 until a user calibration is done. Set to 1 at the start of a user calibration. It will go to 0 at the end of a user calibration only if at least all points on one range have been calibrated. Initial value is 1.
1	These bits are not used
2	UNCORRected measurement Uncorrected measurement data (one or more points could not be corrected using existing user calibration). Set to 0 at the start of each sweep/redisplay of result. Will remain 0 until an attempt is made to correct a point and the calibration data does not exist (the required range has not been calibrated). If no calibration data exist, this bit will not be set when an attempt is made to make a corrected measurement.
3 to 14	These bits are not used
15	This bit is always 0

Error Reporting

Error reporting for the Noise Figure Measurements option is carried out using the Service Request (SRQ) interrupt in the GPIB interface. When an error occurs a Service Request interrupt will be generated. The master can then query the slave instrument for the error that triggered the interrupt. Errors are queried through the "SYSTem:ERRor" command.

3GPP Base Station Measurements (K72) - Status Reporting System

Additionally to the registers provided by the base system, the following registers are used or modified in the 3GPP Base Station Measurements option (K72):

- [STATus:QUEStionable:SYNC Register](#)
Although this register is provided by the base system, the 3GPP Base Station Measurements option (K72) uses different bits and definitions.

Detailed information on the status registers of the base system is given in section [Status Reporting System](#). In this section, only the new and altered status registers / bits for the 3GPP Base Station Measurements option (K72) are described.

This option is available from firmware version 1.60.

STATus:QUEStionable:SYNC Register

This register contains information about failed synchronization and incorrect pilot symbols. The bits can be queried with commands `STATus:QUEStionable:SYNC:CONDition?` and `STATus:QUEStionable:SYNC[:EVENT]?`.

Bit No	Meaning
0	This bit is not used.
1	<p>K72/K74 Frame Sync failed This bit is set when synchronization is not possible within the application. Possible reasons:</p> <ul style="list-style-type: none"> • Incorrectly set frequency • Incorrectly set level • Incorrectly set scrambling code • Incorrectly set values for Invert Q • Invalid signal at input
2 to 4	These bits are not used.
5	<p>K72/K74 Incorrect Pilot Symbol This bit is set when one or more of the received pilot symbols are not equal to the specified pilot symbols of the 3GPP standard. Possible reasons:</p> <ul style="list-style-type: none"> • Incorrectly sent pilot symbols in the received frame. • Low signal to noise ratio (SNR) of the WCDMA signal. • One or more code channels have a significantly lower power level compared to the total power. The incorrect pilots are detected in these channels because of low channel SNR. • One or more channels are sent with high power ramping. In slots with low relative power to total power, the pilot symbols might be detected incorrectly (check the signal quality by using the symbol constellation display).
6 to 14	These bits are not used.
15	This bit is always 0.

CDMA2000 (K82) and 1xEV-DO (K84) BTS Analyzer - Status Reporting System

Additionally to the registers provided by the base system, the following register is used in the CDMA2000 BTS Analyzer option (K82):

- [STATus:QUEstionable:SYNC Register](#)
Although this register is provided by the base system, the CDMA2000 BTS Analyzer option (K82) uses different bits and definitions.

Detailed information on the status registers of the base system is given in section [Status Reporting System](#). In this section, only the new and altered status registers / bits for the CDMA2000 BTS Analyzer option (K82) are described.

This option is available from firmware version 1.90.

STATus:QUEstionable:SYNC Register

This register contains information on the error situation in the code domain analysis of the CDMA2000 BTS Analyzer option.

The bits can be queried with commands `STATus:QUEstionable:SYNC:CONDition?` and `STATus:QUEstionable:SYNC[:EVENT]?`.

Bit No	Meaning
0	This bit is not used.
1	K82 Frame Sync failed This bit is set when synchronization is not possible within the application. Possible reasons: <ul style="list-style-type: none">• Incorrectly set frequency• Incorrectly set level• Incorrectly set PN Offset• Incorrectly set values for Swap IQ• Invalid signal at input
2 to 14	These bits are not used.
15	This bit is always 0.

WLAN TX Measurements (K91) - Status Reporting System

Additionally to the registers provided by the base system, the following registers are used or modified in the WLAN TX Measurements option (K91):

- [STATus:OPERation Register](#)
Although this register is provided by the base system, the WLAN TX Measurements option (K91) makes use of bits not used within the base system.
- [STATus:QUEStionable:LIMit Register](#), [STATus:QUEStionable:SYNC Register](#)
Although this register is provided by the base system, the WLAN TX Measurements option (K91) uses different bits and definitions.

The following registers are provided by the base system and are not available from the WLAN TX Measurements option (K91) command tree:

- [STATus:QUEStionable:ACPLimit Register](#)
- [STATus:QUEStionable:LMARgin Register](#)

Detailed information on the status registers of the base system is given in section [Status Reporting System](#). In this section, only the new and altered status registers / bits for the WLAN TX Measurements option (K91) are described.

This option is available from firmware version 1.20.

STATus:OPERation Register

Additionally to the bits assigned by the base system (for details refer to [STATus:OPERation Register](#)), bit no. 4 is defined:

Bit No	Meaning
4	MEASuring This bit is set while a measurement is in progress.

STATus:QUEStionable:LIMit Register

This register comprises information about the observance of limit lines in the corresponding measurement window (LIMit 1 corresponds to screen A, LIMit 2 to screen B). It can be queried with the `STATus:QUEStionable:LIMit<1|2>:CONDition?` and `STATus:QUEStionable:LIMit<1|2>[:EVENT]? commands.`



No limit lines are displayed in screen A and therefore all bits in the LIMit1 register will always be set to 0.

Bit No	Meaning
0 to 1	These bits are not used.
2	LIMit FAIL This bit is set if the ETSI Spectrum Mask limit line is violated.
3	LIMit FAIL This bit is set if the Spectrum Flatness (Upper) limit line is violated.
4	LIMit FAIL This bit is set if the Spectrum Flatness (Lower) limit line is violated.
5	LIMit FAIL This bit is set if the IEEE Spectrum Mask limit line is violated.
6	LIMit FAIL This bit is set if the PVT Rising Edge max limit is violated.
7	LIMit FAIL This bit is set if the PVT Rising Edge mean limit is violated.
8	LIMit FAIL This bit is set if the PVT Falling Edge max limit is violated.
9	LIMit FAIL This bit is set if the PVT Falling Edge mean limit is violated.
10 to 14	These bits are not used.
15	This bit is always 0.

STATus:QUEStionable:SYNC Register

This register contains information about sync and bursts not found, and about pre-measurement results exceeding or falling short of expected values.

The bits can be queried with commands "STATus:QUEStionable:SYNC:CONDition?" and "STATus:QUEStionable:SYNC[:EVENT]?".

Bit No	Meaning
0	BURSt not found This bit is set if an IQ measurement is performed and no bursts are detected.
1	This bit is not used
2	no bursts of REQuired type This bit is set if an IQ measurement is performed and no bursts of the specified type are detected.
3	GATE length too small This bit is set if gating is used in a measurement and the gate length is not set sufficiently large enough.
4	BURSt count too small This bit is set if a PVT measurement is performed with gating active and there is not at least 1 burst within the gate lines.
5	auto level OVERload This bit is set if a signal overload is detected when an auto-level measurement is performed.
6	auto level NoSIGnal This bit is set if no signal is detected by the auto-level measurement.
7 to 14	These bits are not used.
15	This bit is always 0.

Error Reporting

Error reporting for the WLAN TX Measurements option (K91) is carried out using the Service Request (SRQ) interrupt in the GPIB interface. When an error occurs a Service Request interrupt will be generated. The master can then query the slave instrument for the error that triggered the interrupt errors are queried through the "SYSTem:ERRor" command.

WiMAX, WiBro Measurements (K92/K93) - Status Reporting System

Additionally to the registers provided by the base system, the following registers are used or modified in the WiMAX IEEE 802.16 OFDM, OFDMA Measurements option (R&S FSL-K93):

- [STATus:OPERation Register](#)
Although this register is provided by the base system, the WiMAX IEEE 802.16 OFDM, OFDMA Measurements option (R&S FSL-K93) makes use of bits not used within the base system.
- [STATus:QUEStionable:LIMit Register](#), [STATus:QUEStionable:SYNC Register](#)
Although these registers are provided by the base system, the WiMAX IEEE 802.16 OFDM, OFDMA Measurements option (R&S FSL-K93) uses different bits and definitions.

The following registers are provided by the base system and are not available from the WiMAX IEEE 802.16 OFDM, OFDMA Measurements option (R&S FSL-K93) command tree:

- [STATus:QUEStionable:ACPLimit Register](#)
- [STATus:QUEStionable:LMARgin Register](#)

Detailed information on the status registers of the base system is given in section [Status Reporting System](#). In this section, only the new and altered status registers / bits for the WiMAX IEEE 802.16 OFDM, OFDMA Measurements option (R&S FSL-K93) are described.

The WiMAX IEEE 802.16 OFDM, OFDMA Measurements option (R&S FSL-K93) includes the functionality of the WiMAX 802.16 OFDM Measurements option (R&S FSL-K92). Accordingly both options are described together in this section. The options are available from firmware version 1.40 (R&S FSL-K92) and 1.50 (R&S FSL-K93).

STATus:OPERation Register

Additionally to the bits assigned by the base system (for details refer to [STATus:OPERation Register](#)), bit no. 4 is defined:

Bit No	Meaning
4	MEASuring This bit is set while a measurement is in progress.

STATus:QUEStionable:LIMit Register

This register comprises information about the observance of limit lines in the corresponding measurement window (LIMit 1 corresponds to screen A, LIMit 2 to screen B). It can be queried with the `STATus:QUEStionable:LIMit<1|2>:CONDition?` and `STATus:QUEStionable:LIMit<1|2>[:EVENT]? commands`.



No limit lines are displayed in screen A and therefore all bits in the LIMit1 register will always be set to 0.

Bit No	Meaning
0 to 1	These bits are not used.
2	LIMit FAIL This bit is set if the ETSI Spectrum Mask limit line is violated.
3	LIMit FAIL This bit is set if the IEEE Spectrum Mask limit line is violated.
4	LIMit FAIL This bit is set if the Spectrum Flatness (Upper) limit line is violated.
5	LIMit FAIL This bit is set if the Spectrum Flatness (Lower) limit line is violated.
6	LIMit FAIL This bit is set if the Spectrum Flatness Difference (Upper) limit line is violated.
7	LIMit FAIL This bit is set if the Spectrum Flatness Difference (Lower) limit line is violated.
8 to 14	These bits are not used.
15	This bit is always 0.

STATus:QUEStionable:SYNC Register

This register contains information about sync and bursts not found, and about pre-measurement results exceeding or falling short of expected values.

The bits can be queried with commands "STATus:QUEStionable:SYNC:CONDition?" and "STATus:QUEStionable:SYNC[:EVENT]?".

Bit No	Meaning
0	BURSt not found This bit is set if an IQ measurement is performed and no bursts are detected.
1	This bit is not used.
2	no bursts of REQuired type This bit is set if an IQ measurement is performed and no bursts of the specified type are detected.
3	GATE length too small This bit is set if gating is used in a measurement and the gate length is not set sufficiently large enough.
4	BURSt count too small This bit is set if a PVT measurement is performed with gating active and there is not at least 1 burst within the gate lines.
5	auto level OVERload This bit is set if a signal overload is detected when an auto-level measurement is performed.
6	auto level NoSIGnal This bit is set if no signal is detected by the auto-level measurement.
7 to 14	These bits are not used.
15	This bit is always 0.

Error Reporting

Error reporting for the WiMAX IEEE 802.16 OFDM, OFDMA Measurements option (R&S FSL-K92/K93) is carried out using the Service Request (SRQ) interrupt in the GPIB interface. When an error occurs a Service Request interrupt will be generated. The master can then query the slave instrument for the error that triggered the interrupt errors are queried through the "SYSTem:ERRor" command.

6 Remote Control - Commands

This chapter describes all remote control commands for the analyzer functions, firmware options (see list below) and the basic settings functions of the R&S FSL in detail. Commands that are used both for analyzer functions and firmware options are described in the analyzer commands section. The mode information is provided for each command.

A few commands are implemented for reasons of compatibility with the R&S FSP family only. These commands are not described in the R&S FSL documentation, because they have no effect.

Each subsystem starts with a list of commands, which provides quick access to all commands of the subsystem. Be aware, that for one subsystem more than one SCPI command lists can exist, depending on the functionality (analyzer and basic settings, options). For details on the notation refer to "[Notation](#)".

Remote commands of firmware and firmware options

- "[Remote Commands of the Base Unit](#)" on page 6.5
- "[Remote Commands of the Analog Demodulation Option \(K7\)](#)" on page 6.277
- "[Remote Commands of the Bluetooth Measurements Option \(K8\)](#)" on page 6.325
- "[Remote Commands of the Power Meter Option \(K9\)](#)" on page 6.370
- "[Remote Commands of the Spectrogram Measurement Option \(K14\)](#)" on page 6.384
- "[Remote Commands of the Cable TV Measurements Option \(K20\)](#)" on page 6.406
- "[Remote Commands of the Noise Figure Measurements Option \(K30\)](#)" on page 6.517
- "[Remote Commands of the 3GPP Base Station Measurements Option \(K72\)](#)" on page 6.559
- "[Remote Commands of the CDMA2000 BTS Analyzer Option \(K82\)](#)" on page 6.594
- "[Remote Commands of the 1xEV-DO BTS Analyzer Option \(K84\)](#)" on page 6.627
- "[Remote Commands of the WLAN TX Measurements Option \(K91 / K91n\)](#)" on page 6.665
- "[Remote Commands of the WiMAX, WiBro Measurements Option \(K92/K93\)](#)" on page 6.748

Notation

In the following sections, all commands implemented in the instrument are first listed and then described in detail, arranged according to the command subsystems. The notation is adapted to the SCPI standard. The SCPI conformity information is included in the individual description of the commands.

- [Individual Description](#)
- [Upper/Lower Case Notation](#)
- [Special Characters](#)
- [Description of Parameters](#)

Individual Description

The individual description contains the complete notation of the command. An example for each command, the *RST value and the SCPI information are included as well.

The options and operating modes for which a command can be used are indicated by the following abbreviations:

Abbreviation	Description
A	spectrum analysis
A-F	spectrum analysis - span > 0 only (frequency mode)
A-T	spectrum analysis - zero span only (time mode)
ADEMOD	analog demodulation (option R&S FSL-K7)
BT	Bluetooth measurements (option R&S FSL-K8)
CATV	cable TV measurements (option R&S FSL-K20)
CDMA	CDMA2000 Base Station measurements (option R&S FSL-K82)
EVDO	1xEV-DO Base Station measurements (option R&S FSL-K84)
NF	noise figure measurements (option R&S FSL-K30)
OFDM	WiMAX IEEE 802.16 OFDM measurements (options R&S FSL-K92/K93)
OFDMA/WiBro	WiMAX IEEE 802.16e OFDMA/WiBro measurements (option R&S FSL-K93)
PSM	power sensor measurements (option R&S FSL-K9)
SPECM	spectrogram measurements (option R&S FSL-K14)
WCDMA	3GPP Base Station measurements (option R&S FSL-K72)
WLAN	WLAN TX measurements (option R&S FSL-K91 / K91n)



The spectrum analysis (analyzer) mode is implemented in the basic unit. For the other modes, the corresponding options are required.

Upper/Lower Case Notation

Upper/lower case letters are used to mark the long or short form of the key words of a command in the description (see chapter 5 "Remote Control - Basics"). The instrument itself does not distinguish between upper and lower case letters.

Special Characters

- | A selection of key words with an identical effect exists for several commands. These keywords are indicated in the same line; they are separated by a vertical stroke. Only one of these keywords needs to be included in the header of the command. The effect of the command is independent of which of the keywords is used.

Example:

```
SENSe:FREQUency:CW]:FIXed
```

The two following commands with identical meaning can be created. They set the frequency of the fixed frequency signal to 1 kHz:

```
SENSe:FREQUency:CW 1E3
```

```
SENSe:FREQUency:FIXed 1E3
```

A vertical stroke in parameter indications marks alternative possibilities in the sense of "or". The effect of the command is different, depending on which parameter is used.

Example: Selection of the parameters for the command

```
[SENSe<1|2>:]AVERAge:TYPE VIDEo | LINear
```

If parameter `SINGLE` is selected, full screen is displayed, in the case of `SPLIT`, split screen is displayed.

- [] Key words in square brackets can be omitted when composing the header. The full command length must be accepted by the instrument for reasons of compatibility with the SCPI standards.

Parameters in square brackets can be incorporated optionally in the command or omitted as well.

- { } Parameters in braces can be incorporated optionally in the command, either not at all, once or several times.

Description of Parameters

Due to the standardization, the parameter section of SCPI commands consists always of the same syntactical elements. SCPI has therefore specified a series of definitions, which are used in the tables of commands. In the tables, these established definitions are indicated in angled brackets (<...>) and will be briefly explained in the following (see also chapter 5 "Remote Control - Basics", section "Parameters").

<Boolean>

This keyword refers to parameters which can adopt two states, "on" and "off". The "off" state may either be indicated by the keyword OFF or by the numeric value 0, the "on" state is indicated by ON or any numeric value other than zero. Parameter queries are always returned the numeric value 0 or 1.

<numeric_value> <num>

These keywords mark parameters which may be entered as numeric values or be set using specific keywords (character data). The following keywords given below are permitted:

MAXimum: This keyword sets the parameter to the largest possible value.

MINimum: This keyword sets the parameter to the smallest possible value.

DEFault: This keyword is used to reset the parameter to its default value.

UP: This keyword increments the parameter value.

DOWN: This keyword decrements the parameter value.

The numeric values associated to MAXimum/MINimum/DEFault can be queried by adding the corresponding keywords to the command. They must be entered following the quotation mark.

Example:

SENSe:FREQuency:CENTer? MAXimum

Returns the maximum possible numeric value of the center frequency as result.

<arbitrary block program data>

This keyword is provided for commands the parameters of which consist of a binary data block.

Remote Commands of the Base Unit

In this section all remote control commands for base unit functions are described in detail.

Subsystems of the analyzer

- ["Common Commands"](#) on page 6.6
- ["ABORt Subsystem"](#) on page 6.10
- ["CALCulate Subsystem"](#) on page 6.11
- ["CALibration Subsystem"](#) on page 6.118
- ["DIAGnostic Subsystem"](#) on page 6.120
- ["DISPlay Subsystem"](#) on page 6.124
- ["FORMat Subsytem"](#) on page 6.135
- ["HCOPY Subsystem"](#) on page 6.136
- ["INITiate Subsystem"](#) on page 6.143
- ["INPut Subsystem"](#) on page 6.146
- ["INSTrument Subsystem"](#) on page 6.149
- ["MMEMory Subsystem"](#) on page 6.150
- ["OUTPut Subsystem"](#) on page 6.165
- ["SENSe Subsystem"](#) on page 6.167
- ["SOURce Subsystem"](#) on page 6.229
- ["STATus Subsystem"](#) on page 6.231
- ["SYSTem Subsystem"](#) on page 6.246
- ["TRACe Subsystem"](#) on page 6.256
- ["TRIGger Subsystem"](#) on page 6.270
- ["UNIT Subsystem"](#) on page 6.276

Common Commands

The common commands are taken from the IEEE 488.2 (IEC 625-2) standard. A particular command has the same effect on different devices. The headers of these commands consist of an asterisk "*" followed by three letters. Many common commands refer to the status reporting system which is described in detail in chapter 5 "Remote Control - Basics".

Available Common Commands

- *CAL?
- *CLS
- *ESE
- *ESR?
- *IDN?
- *IST?
- *OPC
- *OPT?
- *PCB
- *PRE
- *PSC
- *RST
- *SRE
- *STB?
- *TRG
- *TST?
- *WAI

*CAL?

CALIBRATION QUERY initiates a calibration of the instrument and subsequently queries the calibration status. Responses > 0 indicate errors.

*CLS

CLEAR STATUS sets the status byte (STB), the standard event register (ESR) and the EVENT part of the QUESTIONable and the OPERATION register to zero. The command does not alter the mask and transition parts of the registers. It clears the output buffer.

*ESE

EVENT STATUS ENABLE sets the event status enable register to the value indicated. The query form *ESE? returns the contents of the event status enable register in decimal form.

Parameter

0 to 255

***ESR?**

STANDARD EVENT STATUS QUERY returns the contents of the event status register in decimal form (0 to 255) and subsequently sets the register to zero.

Parameter

0 to 255

***IDN?**

IDENTIFICATION QUERY queries the instrument identification.

Return values (examples)

LEGacy format, example for R&S FSL6:

Rohde&Schwarz,FSL-6,100005/016,1.80

NEW format, example for R&S FSL6:

Rohde&Schwarz,FSL-6,1300.2502K16/100005,1.80

FSL-6	device name
100005/016	serial number/model
1300.2502K16/100005	part number/serial number
1.80	firmware version

***IST?**

INDIVIDUAL STATUS QUERY returns the contents of the IST flag in decimal form. The IST flag is the status bit which is sent during a parallel poll (see chapter 5 "Remote Control - Basics").

Parameter

0 | 1

***OPC**

OPERATION COMPLETE sets bit 0 in the event status register after all preceding commands have been executed. This bit can be used to initiate a service request (see chapter 5 "Remote Control - Basics").

***OPT?**

OPTION IDENTIFICATION QUERY queries the options included in the instrument and returns a list of the options installed. The options are separated from each other by means of commas.

Parameter

B<number> hardware options

K<number> software options

For a list of all available options and their description refer to the CD-ROM.

Example

B4,B5,B6,B7,B8,B10,B22,B30,B31,K7,K9

***PCB**

PASS CONTROL BACK indicates the controller address which the remote control is to be returned to after termination of the triggered action.

Parameter

0 to 30

***PRE**

PARALLEL POLL REGISTER ENABLE sets the parallel poll enable register to the indicated value. The query form ***PRE?** returns the contents of the parallel poll enable register in decimal form.

Parameter

0 to 255

***PSC**

POWER ON STATUS CLEAR determines whether the contents of the ENABLE registers are preserved or reset during power-up.

The query form ***PSC?** reads out the contents of the power-on-status-clear flag. The response can be 0 or 1.

Parameter

- | | |
|---|---|
| 0 | Causes the contents of the status registers to be preserved. Thus a service request can be generated when switching on the instrument, if the status registers ESE and SRE are suitably configured. |
| 1 | Resets the registers. |
-

***RST**

RESET sets the instrument to a defined default status. The command essentially corresponds to pressing the **PRESET** key. The default settings are described in section "Remote Commands of the Base Unit", "Initializing the Configuration - PRESET Key".

***SRE**

SERVICE REQUEST ENABLE sets the service request enable register to the indicated value. Bit 6 (MSS mask bit) remains 0. This command determines under which conditions a service request is generated. The query form ***SRE?** reads the contents of the service request enable register in decimal form. Bit 6 is always 0.

Parameter

0 to 255

***STB?**

READ STATUS BYTE QUERY reads out the contents of the status byte in decimal form.

***TRG**

TRIGGER initiates all actions in the currently active test screen expecting a trigger event. This command corresponds to the `INITiate:IMMEDIATE` command. For details refer to section "Remote Commands of the Base Unit", "TRIGger Subsystem".

***TST?**

SELF TEST QUERY initiates the self test of the instrument and outputs an error code in decimal form.

Parameter

0 = no error

***WAI**

WAIT-to-CONTINUE permits servicing of subsequent commands only after all preceding commands have been executed and all signals have settled (see chapter 5 "Remote Control - Basics", and `*OPC` command).

ABORt Subsystem

The ABORt subsystem contains the commands for aborting triggered actions. An action can be triggered again immediately after being aborted. All commands trigger events, and therefore they have no *RST value.

Commands of the ABORt Subsystem

– ABORt

ABORt

This command aborts a current measurement and resets the trigger system.

Example

```
ABOR; INIT: IMM
```

Characteristics

RST value: -

SCPI: conform

Mode

all

CALCulate Subsystem

The CALCulate subsystem contains commands for converting instrument data, transforming and carrying out corrections. These functions are carried out subsequent to data acquisition, i.e. following the SENSE subsystem.

The following subsystems are included:

- ["CALCulate:DELTamarker Subsystem"](#) on page 6.12
- ["CALCulate:DLINe Subsystem"](#) on page 6.23
- ["CALCulate:ESPectrum Subsystem"](#) on page 6.24
- ["CALCulate:FLINe Subsystem"](#) on page 6.26
- ["CALCulate:LIMit Subsystem"](#) on page 6.27
- ["CALCulate:MARKer Subsystem"](#) on page 6.55
- ["CALCulate:MATH Subsystem"](#) on page 6.106
- ["CALCulate:PSEarch|PEAKsearch Subsystem"](#) on page 6.108
- ["CALCulate:STATistics Subsystem"](#) on page 6.110
- ["CALCulate:THReshold Subsystem"](#) on page 6.115
- ["CALCulate:TLINE Subsystem"](#) on page 6.116
- ["CALCulate:UNIT Subsystem"](#) on page 6.117

CALCulate:DELTamarker Subsystem

The CALCulate:DELTamarker subsystem controls the delta marker functions of the instrument.

Commands of the CALCulate:DELTamarker Subsystem

- CALCulate<1|2>:DELTamarker<1...4>[:STATe]
- CALCulate<1|2>:DELTamarker<1...4>:AOFF
- CALCulate<1|2>:DELTamarker<1...4>:FUNCTion:FIXed[:STATe]
- CALCulate<1|2>:DELTamarker<1...4>:FUNCTion:FIXed:RPOint:MAXimum[:PEAK]
- CALCulate<1|2>:DELTamarker<1...4>:FUNCTion:FIXed:RPOint:X
- CALCulate<1|2>:DELTamarker<1...4>:FUNCTion:FIXed:RPOint:Y
- CALCulate<1|2>:DELTamarker<1...4>:FUNCTion:FIXed:RPOint:Y:OFFSet
- CALCulate<1|2>:DELTamarker<1...4>:FUNCTion:PNOise[:STATe]
- CALCulate<1|2>:DELTamarker<1...4>:FUNCTion:PNOise:RESult?
- CALCulate<1|2>:DELTamarker<1...4>:MAXimum[:PEAK]
- CALCulate<1|2>:DELTamarker<1...4>:MAXimum:LEFT
- CALCulate<1|2>:DELTamarker<1...4>:MAXimum:NEXT
- CALCulate<1|2>:DELTamarker<1...4>:MAXimum:RIGHT
- CALCulate<1|2>:DELTamarker<1...4>:MINimum[:PEAK]
- CALCulate<1|2>:DELTamarker<1...4>:MINimum:LEFT
- CALCulate<1|2>:DELTamarker<1...4>:MINimum:NEXT
- CALCulate<1|2>:DELTamarker<1...4>:MINimum:RIGHT
- CALCulate<1|2>:DELTamarker<1...4>:MODE
- CALCulate<1|2>:DELTamarker<1...4>:TRACe
- CALCulate<1|2>:DELTamarker<1...4>:X
- CALCulate<1|2>:DELTamarker<1...4>:X:RELative?
- CALCulate<1|2>:DELTamarker<1...4>:Y?

CALCulate<1|2>:DELTamarker<1...4>[:STATe]

This command switches on and off the delta marker when delta marker 1 is selected. The corresponding marker becomes the delta marker when delta marker 2 to 4 is selected. If the corresponding marker is not activated, it will be activated and positioned on the maximum of the measurement curve.

If no numeric suffix with DELTmarker is indicated, delta marker 1 is selected automatically.

For CDMA2000 and 1xEV-DO code domain measurements (option K82 and K84) the numeric suffix <1|2> selects the measurement screen. In the other modes the numeric suffix <1|2> is irrelevant.

Parameter

ON | OFF

Example

```
CALC:DELT3 ON
```

Switches marker 3 to delta marker mode.

Characteristics

RST value: OFF

SCPI: device-specific

Mode

all

CALCulate<1|2>:DELTamarker<1...4>:AOFF

This command switches off all active delta markers.

For CDMA2000 and 1xEV-DO code domain measurements (option K82 and K84) the numeric suffix <1|2> selects the measurement screen. In the other modes the numeric suffix <1|2> is irrelevant.

Example

```
CALC:DELT:AOFF
```

Switches off all delta markers.

Characteristics

RST value: -

SCPI: device-specific

Mode

A, ADEMOD, CATV, CDMA, EVDO, WCDMA

CALCulate<1|2>:DELTamarker<1...4>:FUNCTION:FIXed[:STATe]

This command switches the relative measurement to a fixed reference value on or off. Marker 1 will be activated previously and a peak search will be performed, if necessary. If marker 1 is activated, its position becomes the reference point for the measurement. The reference point can then be modified with the

`CALCulate<1|2>:DELTamarker<1...4>:FUNCTION:FIXed:RPOINT:X` commands and `CALCulate<1|2>:DELTamarker<1...4>:FUNCTION:FIXed:RPOINT:Y` independently of the position of marker 1 and of a trace. It applies to all delta markers as long as the function is active.

The numeric suffixes <1|2> are irrelevant for this command.

Parameter

ON | OFF

Example

```
CALC:DELT:FUNC:FIX ON
```

Switches on the measurement with fixed reference value for all delta markers.

```
CALC:DELT:FUNC:FIX:RPO:X 128 MHZ
```

Sets the frequency reference to 128 MHz.

```
CALC:DELT:FUNC:FIX:RPO:Y 30 DBM
```

Sets the reference level to +30 dBm.

Characteristics

RST value: OFF

SCPI: device-specific

Mode

A

CALCulate<1|2>:DELTamarker<1...4>:FUNction:FIXed:RPOint:MAXimum[:PEAK]

This command sets the reference point level for all delta markers for a measurement with fixed reference point (`CALCulate<1|2>:DELTamarker<1...4>:FUNction:FIXed[:STATe]`) to the peak of the selected trace.

For phase-noise measurements

(`CALCulate<1|2>:DELTamarker<1...4>:FUNction:PNOise[:STATe]`), the command defines a new reference point level for delta marker 2.

The numeric suffixes <1|2> are irrelevant for this command.

This command is an event and therefore has no *RST value and no query.

Parameter

<numeric_value>

Example

```
CALC:DELT:FUNC:FIX:RPO:MAX
```

Sets the reference point level for delta markers to the peak of the selected trace.

Characteristics

RST value: -

SCPI: device-specific

Mode

A

CALCulate<1|2>:DELTamarker<1...4>:FUNction:FIXed:RPOint:X

This command defines a new frequency reference (span > 0) or time (span = 0) for all delta markers for a measurement with fixed reference value

(`CALCulate<1|2>:DELTamarker<1...4>:FUNction:FIXed[:STATe]`).

For phase-noise measurements

(`CALCulate<1|2>:DELTamarker<1...4>:FUNction:PNOise[:STATe]`), the command defines a new frequency reference or time for delta marker 2.

The numeric suffixes <1|2> are irrelevant for this command.

Parameter

<numeric_value>

Example

```
CALC:DELT:FUNC:FIX:RPO:X 128MHz
```

Sets the frequency reference to 128 MHz.

Characteristics

RST value: - (`CALCulate<1|2>:DELTamarker<1...4>:FUNction:FIXed[:STATe]` is set to OFF)

SCPI: device-specific

Mode

A

CALCulate<1|2>:DELTamarker<1...4>:FUNction:FIXed:RPOint:Y

This command defines a new reference point level for all delta markers for a measurement with fixed reference point

(`CALCulate<1|2>:DELTamarker<1...4>:FUNction:FIXed[:STATe]`).

For phase-noise measurements

([CALCulate<1|2>:DELTamarker<1...4>:FUNCTION:PNOise\[:STATe\]](#)), the command defines a new reference point level for delta marker 2.

The numeric suffixes <1|2> are irrelevant for this command.

Parameter

<numeric_value>

Example

```
CALC:DELT:FUNC:FIX:RPO:Y -10dBm
```

Sets the reference point level for delta markers to -10 dBm.

Characteristics

RST value: - ([CALCulate<1|2>:DELTamarker<1...4>:FUNCTION:FIXed\[:STATe\]](#) is set to OFF)

SCPI: device-specific

Mode

A

CALCulate<1|2>:DELTamarker<1...4>:FUNCTION:FIXed:RPOint:Y:OFFSet

This command defines an additional level offset for the measurement with fixed reference value ([CALCulate:DELTamarker:FUNCTION:FIXed:STATe ON](#)). For this measurement, the offset is included in the display of all delta markers.

For phase-noise measurements

([CALCulate<1|2>:DELTamarker<1...4>:FUNCTION:PNOise\[:STATe\]](#)), the command defines an additional level offset which is included in the display of delta marker 2.

The numeric suffixes <1|2> are irrelevant for this command.

Parameter

<numeric_value>

Example

```
CALC:DELT:FUNC:FIX:RPO:Y:OFFS 10dB
```

Sets the level offset for the measurement with fixed reference value or the phase-noise measurement to 10 dB.

Characteristics

RST value: 0 dB

SCPI: device-specific

Mode

A

CALCulate<1|2>:DELTamarker<1...4>:FUNCTION:PNOise[:STATe]

This command switches on or off the phase-noise measurement with all active delta markers. The correction values for the bandwidth and the log amplifier are taken into account in the measurement.

Marker 1 will be activated, if necessary, and a peak search will be performed. If marker 1 is activated, its position becomes the reference point for the measurement.

The reference point can then be modified with the

[CALCulate<1|2>:DELTamarker<1...4>:FUNCTION:FIXed:RPOint:X](#) and

[CALCulate<1|2>:DELTamarker<1...4>:FUNCTION:FIXed:RPOint:Y](#) commands

independently of the position of marker 1 and of a trace (the same commands used for the measurement with fixed reference point).

The numeric suffixes <1|2> and <1...4> are irrelevant for this command.

Parameter

ON | OFF

Example

```
CALC:DELT:FUNC:PNO ON
```

Switches on the phase-noise measurement with all delta markers.

```
CALC:DELT:FUNC:FIX:RPO:X 128 MHZ
```

Sets the frequency reference to 128 MHz.

```
CALC:DELT:FUNC:FIX:RPO:Y 30 DBM
```

Sets the reference level to +30 dBm

Characteristics

RST value: OFF

SCPI: device-specific

Mode

A

CALCulate<1|2>:DELTaMarker<1...4>:FUNCtion:PNOise:RESult?

This command queries the result of the phase-noise measurement. The measurement will be switched on, if necessary.

The numeric suffixes <1|2> are irrelevant for this command.

This command is only a query and therefore has no *RST value.

Example

```
CALC:DELT:FUNC:PNO:RES?
```

Outputs the result of phase-noise measurement of the selected delta marker.

Characteristics

RST value: -

SCPI: device-specific

Mode

A

CALCulate<1|2>:DELTaMarker<1...4>:MAXimum[:PEAK]

This command positions the delta marker to the current maximum value on the measured curve. If necessary, the corresponding delta marker will be activated first.

For CDMA2000 and 1xEV-DO code domain measurements (option K82 and K84) the numeric suffix <1|2> selects the measurement screen. In the other modes the numeric suffix <1|2> is irrelevant.

This command is an event and therefore has no *RST value and no query.

Example

```
CALC:DELT3:MAX
```

Sets delta marker 3 to the maximum value of the associated trace.

Characteristics

RST value: -

SCPI: device-specific

Mode

A, ADEMOD, CATV, CDMA, EVDO, SPECM, WCDMA

CALCulate<1|2>:DELTamarker<1...4>:MAXimum:LEFT

This command positions the delta marker to the next smaller maximum value to the left of the current value (i.e. descending X values). The corresponding delta marker will be activated first, if necessary.

For CDMA2000 and 1xEV-DO code domain measurements (option K82 and K84) the numeric suffix <1|2> selects the measurement screen. In the other modes the numeric suffix <1|2> is irrelevant.

This command is an event and therefore has no *RST value and no query.

Example

```
CALC:DELT:MAX:LEFT
```

Sets delta marker 1 to the next smaller maximum value to the left of the current value.

Characteristics

RST value: -

SCPI: device-specific

Mode

A, ADEMOD, CATV, CDMA, EVDO, SPECM, WCDMA

CALCulate<1|2>:DELTamarker<1...4>:MAXimum:NEXT

This command positions the delta marker to the next smaller maximum value on the measured curve. The corresponding delta marker will be activated first, if necessary.

For CDMA2000 and 1xEV-DO code domain measurements (option K82 and K84) the numeric suffix <1|2> selects the measurement screen. In the other modes the numeric suffix <1|2> is irrelevant.

This command is an event and therefore has no *RST value and no query.

Example

```
CALC:DELT2:MAX:NEXT
```

Sets delta marker 2 to the next smaller maximum value.

Characteristics

RST value: -

SCPI: device-specific

Mode

A, ADEMOD, CATV, CDMA, EVDO, SPECM, WCDMA

CALCulate<1|2>:DELTamarker<1...4>:MAXimum:RIGHT

This command positions the delta marker to the next smaller maximum value to the right of the current value (i.e. ascending X values). The corresponding delta marker is activated first, if necessary.

For CDMA2000 and 1xEV-DO code domain measurements (option K82 and K84) the numeric suffix <1|2> selects the measurement screen. In the other modes the numeric suffix <1|2> is irrelevant.

This command is an event and therefore has no *RST value and no query.

Example

```
CALC:DELT:MAX:RIGH
```

Sets delta marker 1 to the next smaller maximum value to the right of the current value.

Characteristics

RST value: -

SCPI: device-specific

Mode

A, ADEMOD, CATV, CDMA, EVDO, SPECM, WCDMA

CALCulate<1|2>:DELTamarker<1...4>:MINimum[:PEAK]

This command positions the delta marker to the current minimum value on the measured curve. The corresponding delta marker will be activated first, if necessary.

For CDMA2000 and 1xEV-DO code domain measurements (option K82 and K84) the numeric suffix <1|2> selects the measurement screen. In the other modes the numeric suffix <1|2> is irrelevant.

This command is an event and therefore has no *RST value and no query.

Example

```
CALC:DELT3:MIN
```

Sets delta marker 3 to the minimum value of the associated trace.

Characteristics

RST value: -

SCPI: device-specific

Mode

A, ADEMOD, CATV, CDMA, EVDO, SPECM, WCDMA

CALCulate<1|2>:DELTamarker<1...4>:MINimum:LEFT

This command positions the delta marker to the next higher minimum value to the left of the current value (i.e. descending X values). The corresponding delta marker will be activated first, if necessary.

For CDMA2000 and 1xEV-DO code domain measurements (option K82 and K84) the numeric suffix <1|2> selects the measurement screen. In the other modes the numeric suffix <1|2> is irrelevant.

This command is an event and therefore has no *RST value and no query.

Example

```
CALC:DELT:MIN:LEFT
```

Sets delta marker 1 to the next higher minimum to the left of the current value.

Characteristics

RST value: -

SCPI: device-specific

Mode

A, ADEMOD, CATV, CDMA, EVDO, SPECM, WCDMA

CALCulate<1|2>:DELTamarker<1...4>:MINimum:NEXT

This command positions the delta marker to the next higher minimum value of the measured curve. The corresponding delta marker will be activated first, if necessary.

For CDMA2000 and 1xEV-DO code domain measurements (option K82 and K84) the numeric suffix <1|2> selects the measurement screen. In the other modes the numeric suffix <1|2> is irrelevant.

This command is an event and therefore has no *RST value and no query.

Example

```
CALC:DELT2:MIN:NEXT
```

Sets delta marker 2 to the next higher minimum value.

Characteristics

RST value: -

SCPI: device-specific

Mode

A, ADEMOD, CATV, CDMA, EVDO, SPECM, WCDMA

CALCulate<1|2>:DELTamarker<1...4>:MINimum:RIGHT

This command positions the delta marker to the next higher minimum value to the right of the current value (i.e. ascending X values). The corresponding delta marker will be activated first, if necessary.

For CDMA2000 and 1xEV-DO code domain measurements (option K82 and K84) the numeric suffix <1|2> selects the measurement screen. In the other modes the numeric suffix <1|2> is irrelevant.

This command is an event and therefore has no *RST value and no query.

Example

```
CALC:DELT:MIN:RIGH
```

Sets delta marker 1 to the next higher minimum value to the right of the current value.

Characteristics

RST value: -

SCPI: device-specific

Mode

A, ADEMOD, CATV, CDMA, EVDO, SPECM, WCDMA

CALCulate<1|2>:DELTamarker<1...4>:MODE

This command switches between relative and absolute frequency input of the delta marker (or time with span = 0).

The numeric suffixes <1|2> are irrelevant for this command.

Parameter

ABSolute | RELative

Example

```
CALC:DELT:MODE ABS
```

Switches the frequency/time indication for all delta markers to absolute values.

```
CALC:DELT:MODE REL
```

Switches the frequency/time indication for all delta markers to relative to marker 1.

Characteristics

RST value: REL

SCPI: device-specific

Mode

all

CALCulate<1|2>:DELTamarker<1...4>:TRACe

This command assigns the selected delta marker to the indicated trace. The selected trace must be active, i.e. its state must be different from "BLANK".

The numeric suffixes <1|2> are irrelevant for this command.

Parameter

1 to 6

Example

```
CALC:DELT3:TRAC 2
```

Assigns delta marker 3 to trace 2.

Characteristics

RST value: -

SCPI: device-specific

Mode

A, ADEMOD, CATV

CALCulate<1|2>:DELTamarker<1...4>:X

This command positions the selected delta marker to the indicated frequency (span > 0), time (span = 0) or level (APD measurement = ON or CCDF measurement = ON). The input is in absolute values or relative to marker 1 depending on the command

[CALCulate<1|2>:DELTamarker<1...4>:MODE](#). If reference fixed measurement ([CALCulate<1|2>:DELTamarker<1...4>:FUNCTION:FIXed\[:STATE\]](#) is ON) is active, relative values refer to the reference position are entered. The query always returns absolute values.

The numeric suffixes <1|2> are irrelevant for this command.

Parameter

0 to MAX (frequency | sweep time)

Example

```
CALC:DELT:MOD REL
```

Switches the input for all delta markers to relative to marker 1.

```
CALC:DELT2:X 10.7MHz
```

Positions delta marker 2 10.7 MHz to the right of marker 1.

```
CALC:DELT:X?
```

Outputs the absolute frequency/time of delta marker 1.

```
CALC:DELT:X:REL?
```

Outputs the relative frequency/time/level of delta marker 1.

Characteristics

RST value: -

SCPI: device-specific

Mode

A, ADEMOD, CATV, CDMA, EVDO, WCDMA

CALCulate<1|2>:DELTaMarker<1...4>:X:RELative?

This command queries the frequency (span > 0) or time (span = 0) of the selected delta marker relative to marker 1 or to the reference position (for `CALCulate<1|2>:DELTaMarker<1...4>:FUNctIon:FIXed[:STATe]` is ON). The command activates the corresponding delta marker, if necessary.

The numeric suffixes <1|2> are irrelevant for this command.

Example

```
CALC:DELT3:X:REL?
```

Outputs the frequency of delta marker 3 relative to marker 1 or relative to the reference position.

Characteristics

RST value: -

SCPI: device-specific

Mode

A, ADEMOD, CATV, CDMA, EVDO, WCDMA

CALCulate<1|2>:DELTaMarker<1...4>:Y?

This command queries the measured value of the selected delta marker. The corresponding delta marker will be activated, if necessary. The output is always a relative value referred to marker 1 or to the reference position (reference fixed active).

To obtain a correct query result, a complete sweep with synchronization to the sweep end must be performed between the activation of the delta marker and the query of the y value. This is only possible in single sweep mode.

Depending on the unit defined with `CALCulate<1|2>:UNIT:POWer` or on the activated measuring functions, the query result is output in the units below:

Parameter or measuring functions	Output unit
DBM DBPW DBUV DBMV DBUA	dB (lin/log)
WATT VOLT AMPere	dB (lin), % (log)
statistics function (APD or CCDF) on	dimensionless output

For CDMA2000 and 1xEV-DO code domain measurements (option K82 and K84) the numeric suffix <1|2> selects the measurement screen. In the other modes the numeric suffix <1|2> is irrelevant.

Example

```
INIT:CONT OFF
```

Switches to single sweep mode.

```
CALC:DELT2 ON
```

Switches on delta marker 2.

```
INIT;*WAI
```

Starts a sweep and waits for its end.

CALC:DELT2:Y?

Outputs measurement value of delta marker 2.

Characteristics

RST value: -

SCPI: device-specific

Mode

A, ADEMOD, BT, CATV, CDMA, EVDO, WCDMA

CALCulate:DLINe Subsystem

The CALCulate:DLINe subsystem defines the position of the display lines.

Commands of the CALCulate:DLINe Subsystem

- CALCulate<1|2>:DLINe<1|2>
- CALCulate<1|2>:DLINe<1|2>:STATe

CALCulate<1|2>:DLINe<1|2>

This command defines the position of display line 1 or 2. These lines enable the user to mark any levels in the diagram. The unit depends on the setting made with [CALCulate<1|2>:UNIT:POWer](#).

The numeric suffixes <1|2> at CALCulate are irrelevant for this command.

Parameter

MINimum to MAXimum (depending on current unit)

Example

```
CALC:DLIN -20dBm
```

Characteristics

*RST value: - (STATe to OFF)

SCPI: device-specific

Mode

A

CALCulate<1|2>:DLINe<1|2>:STATe

This command switches display line 1 or 2 (level lines) on or off.

The numeric suffixes <1|2> are irrelevant for this command.

Parameter

ON | OFF

Example

```
CALC:DLIN2:STAT OFF
```

Characteristics

*RST value: OFF

SCPI: device-specific

Mode

A

CALCulate:ESpectrum Subsystem

The CALCulate:ESpectrum subsystem contains the remote commands for Spectrum Emission Mask (SEM) measurements. Both groups of commands (PSEarch and PEAKsearch) perform the same functions.

Commands of the CALCulate:ESpectrum Subsystem

- [CALCulate<1|2>:ESpectrum:PSEarch|PEAKsearch:AUTO](#)
- [CALCulate<1|2>:ESpectrum:PSEarch|PEAKsearch:MARGIN](#)
- [CALCulate<1|2>:ESpectrum:PSEarch|PEAKsearch:PSHOW](#)

CALCulate<1|2>:ESpectrum:PSEarch|PEAKsearch:AUTO

This command activates or deactivates the list evaluation.

The numeric suffixes <1|2> are not relevant.

This command is available from firmware version 1.80.

Parameter

ON | OFF

Example

```
CALC:ESP:PSE:AUTO OFF
```

Deactivates the list evaluation.

Characteristics

RST value: ON

SCPI: device-specific

Mode

A, CDMA, EVDO

CALCulate<1|2>:ESpectrum:PSEarch|PEAKsearch:MARGIN

This command sets the margin used for the limit check/peak search.

The numeric suffixes <1|2> are not relevant.

This command is available from firmware version 1.80.

Parameter

-200 to 200 dB

Example

```
CALC:ESP:PSE:MARG 100
```

Sets the margin to 100 dB.

Characteristics

RST value: 200 dB

SCPI: device-specific

Mode

A, CDMA, EVDO

CALCulate<1|2>:ESPectrum:PSEarch|:PEAKsearch:PSHow

This command marks all peaks with blue squares in the diagram.

The numeric suffixes <1|2> are not relevant.

This command is available from firmware version 1.80.

Parameter

ON | OFF

Example

```
CALC:ESP:PSE:PSH ON
```

Marks all peaks with blue squares.

Characteristics

RST value: OFF

SCPI: device-specific

Mode

A, CDMA, EVDO

CALCulate:FLINE Subsystem

The CALCulate:FLINE subsystem defines the position of the frequency lines.

Commands of the CALCulate:FLINE Subsystem

- CALCulate<1|2>:FLINE<1|2>
- CALCulate<1|2>:FLINE<1|2>:STATe

CALCulate<1|2>:FLINE<1|2>

This command defines the position of the frequency lines that mark the frequencies.
The numeric suffixes <1|2> are irrelevant for this command.

Parameter

0 to f_{\max}

Example

```
CALC:FLIN2 120MHz
```

Characteristics

*RST value: - (STATe to OFF)

SCPI: device-specific

Mode

A-F

CALCulate<1|2>:FLINE<1|2>:STATe

This command switches the frequency line on or off.
The numeric suffixes <1|2> are irrelevant for this command.

Parameter

ON | OFF

Example

```
CALC:FLIN2:STAT ON
```

Characteristics

*RST value: OFF

SCPI: device-specific

Mode

A-F

CALCulate:LIMit Subsystem

The CALCulate:LIMit subsystem contains commands for the limit lines and the corresponding limit checks. Limit lines can be defined as upper or lower limit lines. The individual Y values of the limit lines correspond to the values of the x-axis (CONTRol). The number of X and Y values must be identical. For details on limit lines refer to chapter "Instrument Functions", section "Using Limit Lines and Display Lines - LINES Key".

The following subsystems are included:

- "CALCulate:LIMit:ACPower Subsystem" on page 6.33
- "CALCulate:LIMit:CONTRol Subsystem" on page 6.41
- "CALCulate:LIMit:ESpectrum Subsystem" on page 6.44
- "CALCulate:LIMit:LOWer Subsystem" on page 6.47
- "CALCulate:LIMit:UPPer Subsystem" on page 6.51

Commands of the CALCulate:LIMit Subsystem

- CALCulate<1|2>:LIMit<1...8>:ACTive?
- CALCulate<1|2>:LIMit<1...8>:CLEar[:IMMEDIATE]
- CALCulate<1|2>:LIMit<1...8>:COMMEnt
- CALCulate<1|2>:LIMit<1...8>:COpy
- CALCulate<1|2>:LIMit<1...8>:DELEte
- CALCulate<1|2>:LIMit<1...8>:FAIl?
- CALCulate<1|2>:LIMit<1...8>:NAME
- CALCulate<1|2>:LIMit<1...8>:STATe
- CALCulate<1|2>:LIMit<1...8>:TRACe
- CALCulate<1|2>:LIMit<1...8>:UNIT

Further information

- Example (analyzer mode)
- Definition of the limit line
- Switching on and evaluating the line

Example (analyzer mode)

Definition and use of a new limit line 5 for trace 2 with the following features:

- upper limit line
- absolute x-axis with span > 0.
- 5 ref. values: 126 MHz/-40 dB, 127 MHz/-40 dB, 128 MHz/-20 dB, 129 MHz/-40 dB, 130 MHz/-40 dB
- relative y-axis with unit dB
- absolute threshold value at -35 dBm
- no safety margin

Definition of the limit line

1. Defining the name:

```
CALC:LIM5:NAME 'TEST1'
```

2. Entering the comment:

```
CALC:LIM5:COMM 'Upper limit line'
```

3. Associated trace:

```
CALC:LIM5:TRAC 2
```

4. Defining the x-axis range:

```
CALC:LIM5:CONT:DOM FREQ
```

5. Defining the x-axis scaling:

```
CALC:LIM5:CONT:MODE ABS
```

6. Defining the y-axis unit:

```
CALC:LIM5:UNIT DB
```

7. Defining the y-axis scaling:

```
CALC:LIM5:UPP:MODE REL
```

8. Defining the x-axis values:

```
CALC:LIM5:CONT 126MHZ, 127MHZ, 128MHZ, 129 MHZ, 130MHZ
```

9. Defining the y values:

```
CALC:LIM5:UPP -40, -40, -30, -40, -40
```

10. Defining the y threshold value:

```
CALC:LIM5:UPP:THR -35DBM
```

The definition of the safety margin and shifting in X and/or Y direction can take place as from here (see commands below).

Switching on and evaluating the line

1. Switching on the line:

```
CALC:LIM5:UPP:STAT ON
```

2. Switching on the limit check:

```
CALC:LIM5:STAT ON
```

3. Starting a new measurement with synchronization:

```
INIT; *WAI
```

4. Querying the limit check result:

```
CALC:LIM5:FAIL?
```

CALCulate<1|2>:LIMit<1...8>:ACTive?

This command queries the names of all active limit lines.

The numeric suffixes <1|2> and <1...8> are irrelevant for this command.

This command is only a query and therefore has no *RST value.

This command is available from firmware version 1.60.

Example

```
CALC:LIM:ACT?
```

Queries the names of all active limit lines.

Return values

```
'3GBAA,3GBBA,3GBCR'
```

Returns the names of the active limit lines in alphabetical order, separated by commas.

Characteristics

RST value: -

SCPI: device-specific

Mode

A, CDMA, EVDO

CALCulate<1|2>:LIMit<1...8>:CLEar[:IMMediate]

This command deletes the result of the current limit check for all limit lines.

The numeric suffixes <1|2> and <1...8> are irrelevant for this command.

This command is an event and therefore has no *RST value.

This command is available from firmware version 1.10.

Example

```
CALC:LIM:CLE
```

Deletes the result of the limit check.

Characteristics

*RST value: -

SCPI: conform

Mode

A, ADEMOD, CDMA, EVDO, NF

CALCulate<1|2>:LIMit<1...8>:COMMent

This command defines a comment for the limit line selected (max. 40 characters).

The numeric suffixes <1|2> are irrelevant for this command.

This command is available from firmware version 1.10.

Parameter

<string>, max. 40 alphanumeric characters

Example

```
CALC:LIM5:COMM 'Upper limit for spectrum'
```

Defines the comment for limit line 5.

Characteristics

*RST value: blank comment

SCPI: device-specific

Mode

A, ADEMOD, CDMA, EVDO, NF

CALCulate<1|2>:LIMit<1...8>:COPY

This command copies one limit line onto another one
The numeric suffixes <1|2> are irrelevant for this command.
This command is an event and therefore has no *RST value and no query.
This command is available from firmware version 1.10.

Parameter

1 to 8 number of the new limit line
<name> name of the new limit line given as a string

Example

```
CALC:LIM1:COPY 2  
Copies limit line 1 to line 2.  
CALC:LIM1:COPY 'FM2'  
Copies limit line 1 to a new line named FM2.
```

Characteristics

*RST value: -
SCPI: device-specific

Mode

A, ADEMOD, CDMA, EVDO, NF

CALCulate<1|2>:LIMit<1...8>:DELeTe

This command deletes the selected limit line.
The numeric suffixes <1|2> are irrelevant for this command.
This command is an event and therefore has no *RST value and no query.
This command is available from firmware version 1.10.

Example

```
CALC:LIM1:DEL  
Deletes limit line 1.
```

Characteristics

*RST value: -
SCPI: device-specific

Mode

A, ADEMOD, CDMA, EVDO, NF

CALCulate<1|2>:LIMit<1...8>:FAIL?

This command queries the result of the limit check of the indicated limit line. It should be noted that a complete sweep must have been performed to obtain a correct result. A synchronization with *OPC, *OPC? or *WAI should therefore be provided. The result of the limit check is given with 0 for PASS, 1 for FAIL, and 2 for MARGIN.

The numeric suffixes <1|2> are irrelevant for this command.
This command is available from firmware version 1.10.

Return values

0 for pass, 1 for fail

Example

```
INIT; *WAI
```

Starts a new sweep and waits for its end.

```
CALC:LIM3:FAIL?
```

Queries the result of the check for limit line 3.

Characteristics

*RST value: -

SCPI: conform

Mode

A, ADEMOD, NF, CDMA, EVDO, WLAN

CALCulate<1|2>:LIMit<1...8>:NAME

This command assigns a name to a limit line numbered 1 to 8. If it does not exist already, a limit line with this name is created.

The numeric suffixes <1|2> are irrelevant for this command.

This command is available from firmware version 1.10.

Parameter

<name of limit line>

Example

```
CALC:LIM1:NAME 'FM1'
```

Assigns the name FM1 to limit line 1.

Characteristics

*RST value: REM1 to REM8 for lines 1 to 8

SCPI: device-specific

Mode

A, ADEMOD, CDMA, EVDO

CALCulate<1|2>:LIMit<1...8>:STATe

This command switches on or off the limit check for the selected limit line.

The result of the limit check can be queried with [CALCulate<1|2>:LIMit<1...8>:FAIL?](#).

The numeric suffixes <1|2> are irrelevant for this command.

This command is available from firmware version 1.10.

Parameter

ON | OFF

Example

```
CALC:LIM:STAT ON
```

Switches on the limit check for limit line 1.

Characteristics

*RST value: OFF

SCPI: conform

Mode

A, BT, ADEMOD, CDMA, EVDO, NF

CALCulate<1|2>:LIMit<1...8>:TRACe

This command assigns a limit line to a trace.
The numeric suffixes <1|2> are irrelevant for this command.
This command is available from firmware version 1.10.

Parameter

1 to 6

Example

```
CALC:LIM2:TRAC 3
```

Assigns limit line 2 to trace 3.

Characteristics

*RST value: 1
SCPI: device-specific

Mode

A, ADEMOD, CDMA, EVDO

CALCulate<1|2>:LIMit<1...8>:UNIT

This command defines the unit of the selected limit line.
Upon selection of the unit DB the limit line is automatically switched to the relative mode. For units different from DB the limit line is automatically switched to absolute mode.
The units DEG, RAD, S, HZ, PCT are not available in spectrum analyzer mode.
The numeric suffixes <1|2> are irrelevant for this command.
This command is available from firmware version 1.10.

Parameter

DBM | DBPW | WATT | DBUV | DBMV | VOLT | DBUA | AMPere | DB | DEG | RAD | HZ | PCT

Example

```
CALC:LIM4:UNIT DBUV
```

Sets the unit of limit line 4 to dB μ V.

Characteristics

*RST value: DBM
SCPI: device-specific

Mode

A, ADEMOD, CDMA, EVDO

CALCulate:LIMit:ACPower Subsystem

The CALCulate:LIMit:ACPower subsystem defines the limit check for adjacent channel power measurement.

Commands of the CALCulate:LIMit:ACPower Subsystem

- CALCulate<1|2>:LIMit<1...8>:ACPower[:STATe]
- CALCulate<1|2>:LIMit<1...8>:ACPower:ACHannel[:RELative]
- CALCulate<1|2>:LIMit<1...8>:ACPower:ACHannel[:RELative]:STATe
- CALCulate<1|2>:LIMit<1...8>:ACPower:ACHannel:ABSolute
- CALCulate<1|2>:LIMit<1...8>:ACPower:ACHannel:ABSolute:STATe
- CALCulate<1|2>:LIMit<1...8>:ACPower:ACHannel:RESult?
- CALCulate<1|2>:LIMit<1...8>:ACPower:ALternate<1...11>[:RELative]
- CALCulate<1|2>:LIMit<1...8>:ACPower:ALternate<1...11>[:RELative]:STATe
- CALCulate<1|2>:LIMit<1...8>:ACPower:ALternate<1...11>:ABSolute
- CALCulate<1|2>:LIMit<1...8>:ACPower:ALternate<1...11>:ABSolute:STATe
- CALCulate<1|2>:LIMit<1...8>:ACPower:ALternate<1...11>:RESult?

CALCulate<1|2>:LIMit<1...8>:ACPower[:STATe]

This command switches on and off the limit check for adjacent-channel power measurements. The `CALCulate<1|2>:LIMit<1...8>:ACPower:ACHannel[:RELative]:STATe` or `CALCulate<1|2>:LIMit<1...8>:ACPower:ALternate<1...11>[:RELative]:STATe` commands must be used in addition to specify whether the limit check is to be performed for the upper/lower adjacent channel or for the alternate adjacent channels. The numeric suffixes <1|2> and <1...8> are irrelevant for this command.

Parameter

ON | OFF

Example

```
CALC:LIM:ACP ON
Switches on the ACP limit check.
```

Characteristics

*RST value: OFF
SCPI: device-specific

Mode

A, CDMA, EVDO

CALCulate<1|2>:LIMit<1...8>:ACPower:ACHannel[:RELative]

This command defines the relative limit of the upper/lower adjacent channel for adjacent-channel power measurements. The reference value for the relative limit value is the measured channel power.

It should be noted that the relative limit value has no effect on the limit check as soon as it is below the absolute limit value defined with the `CALCulate<1|2>:LIMit<1...8>:ACPower:ACHannel:ABSolute` command. This mechanism allows automatic checking of the absolute basic values of adjacent-channel power as defined in mobile radio standards.

The numeric suffixes <1|2> and <1...8> are irrelevant for this command.

Parameter

first value: 0 to 100dB; limit for the upper (lower) adjacent channel

second value: 0 to 100dB; is ignored but must be indicated for reasons of compatibility with the FSP family

Example

```
CALC:LIM:ACP:ACH 30DB, 30DB
```

Sets the relative limit value for the power in the lower and upper adjacent channel to 30 dB below the channel power.

Characteristics

*RST value: 0 dB

SCPI: device-specific

Mode

A, CDMA, EVDO

CALCulate<1|2>:LIMit<1...8>:ACPpower:ACHannel[:RELative]:STATe

This command activates the limit check for the relative limit value of the adjacent channel when adjacent-channel power measurement is performed. Before the command, the limit check must be activated using `CALCulate<1|2>:LIMit<1...8>:ACPpower[:STATe]`.

`CALCulate<1|2>:LIMit<1...8>:ACPpower:ACHannel:RESult?` queries the result. It should be noted that a complete measurement must be performed between switching on the limit check and the result query, since otherwise no correct results are available.

The numeric suffixes <1|2> and <1...8> are irrelevant for this command.

Parameter

ON | OFF

Example

```
CALC:LIM:ACP:ACH 30DB, 30DB
```

Sets the relative limit value for the power in the lower and upper adjacent channel to 30 dB below the channel power.

```
CALC:LIM:ACP:ACH:ABS -35DBM, -35DBM
```

Sets the absolute limit value for the power in the lower and upper adjacent channel to -35 dBm.

```
CALC:LIM:ACP ON
```

Switches on globally the limit check for the channel/adjacent channel measurement.

```
CALC:LIM:ACP:ACH:STAT ON
```

Switches on the check of the relative limit values for adjacent channels.

```
CALC:LIM:ACP:ACH:ABS:STAT ON
```

Switches on the check of absolute limit values for the adjacent channels.

```
INIT;*WAI
```

Starts a new measurement and waits for the sweep end.

```
CALC:LIM:ACP:ACH:RES?
```

Queries the limit check result in the adjacent channels.

Characteristics

*RST value: OFF

SCPI: device-specific

Mode

A, CDMA, EVDO

CALCulate<1|2>:LIMit<1...8>:ACPpower:ACHannel:ABSolute

This command defines the absolute limit value for the lower/upper adjacent channel during adjacent-channel power measurement (Adjacent Channel Power).

It should be noted that the absolute limit value has no effect on the limit check as soon as it is below the relative limit value defined with

`CALCulate<1|2>:LIMit<1...8>:ACPpower:ACHannel[:RELative]`. This mechanism allows automatic checking of the absolute basic values of adjacent-channel power as defined in mobile radio standards.

The numeric suffixes <1|2> and <1...8> are irrelevant for this command.

Parameter

first value: -200DBM to 200DBM; limit for the lower and the upper adjacent channel

second value: -200 to 200DBM; is ignored but must be indicated for reasons of compatibility with the FSP family

Example

```
CALC:LIM:ACP:ACH:ABS -35DBM, -35DBM
```

Sets the absolute limit value for the power in the lower and upper adjacent channel to -35 dBm.

Characteristics

*RST value: -200DBM

SCPI: device-specific

Mode

A, CDMA, EVDO

CALCulate<1|2>:LIMit<1...8>:ACPpower:ACHannel:ABSolute:STATe

This command activates the limit check for the adjacent channel when adjacent-channel power measurement (Adjacent Channel Power) is performed. Before the command, the limit check for the channel/adjacent-channel measurement must be globally switched on using

`CALCulate<1|2>:LIMit<1...8>:ACPpower[:STATe]`.

The result can be queried with

`CALCulate<1|2>:LIMit<1...8>:ACPpower:ACHannel:RESult?`. It should be noted that a complete measurement must be performed between switching on the limit check and the result query, since otherwise no correct results are available.

The numeric suffixes <1|2> and <1...8> are irrelevant for this command.

Parameter

ON | OFF

Example

```
CALC:LIM:ACP:ACH 30DB, 30DB
```

Sets the relative limit value for the power in the lower and upper adjacent channel to 30 dB below the channel power.

```
CALC:LIM:ACP:ACH:ABS -35DBM, -35DBM
```

Sets the absolute limit value for the power in the lower and upper adjacent channel to -35 dBm.

```
CALC:LIM:ACP ON
```

Switches on globally the limit check for the channel/adjacent-channel measurement.

```
CALC:LIM:ACP:ACH:REL:STAT ON
```

Switches on the check of the relative limit values for adjacent channels.

```
CALC:LIM:ACP:ACH:ABS:STAT ON
```

Switches on the check of absolute limit values for the adjacent channels.

```
INIT; *WAI
```

Starts a new measurement and waits for the sweep end.

```
CALC:LIM:ACP:ACH:RES?
```

Queries the limit check result in the adjacent channels.

Characteristics

*RST value: OFF

SCPI: device-specific

Mode

A, CDMA, EVDO

CALCulate<1|2>:LIMit<1...8>:ACPpower:ACHannel:RESult?

This command queries the result of the limit check for the upper/lower adjacent channel when adjacent channel power measurement is performed.

If the power measurement of the adjacent channel is switched off, the command produces a query error.

The numeric suffixes <1|2> and <1...8> are irrelevant for this command.

This command is a query and therefore has no *RST value.

Parameter

The result is returned in the form <result>, <result> where <result> = PASSED | FAILED, and where the first returned value denotes the lower, the second denotes the upper adjacent channel.

Example

```
CALC:LIM:ACP:ACH 30DB, 30DB
```

Sets the relative limit value for the power in the lower and upper adjacent channel to 30 dB below the channel power.

```
CALC:LIM:ACP:ACH:ABS -35DBM, -35DBM
```

Sets the absolute limit value for the power in the lower and upper adjacent channel to -35 dB.

```
CALC:LIM:ACP ON
```

Switches on globally the limit check for the channel/adjacent channel measurement.

```
CALC:LIM:ACP:ACH:STAT ON
```

Switches on the limit check for the adjacent channels.

```
INIT; *WAI
```

Starts a new measurement and waits for the sweep end.

```
CALC:LIM:ACP:ACH:RES?
```

Queries the limit check result in the adjacent channels.

Characteristics

*RST value: -

SCPI: device-specific

Mode

A, CDMA, EVDO, WLAN

CALCulate<1|2>:LIMit<1...8>:ACPpower:ALTErnate<1...11>[:RELative]

This command defines the limit for the alternate adjacent channels for adjacent channel power measurements. The reference value for the relative limit value is the measured channel power.

The numeric suffix after ALTErnate denotes the alternate channel. The numeric suffixes <1|2> with CALCulate and <1...8> with LIMit are irrelevant for this command.

It should be noted that the relative limit value has no effect on the limit check as soon as it is below the absolute limit defined with `CALCulate<1|2>:LIMit<1...8>:ACPpower:ALTernate<1...11>:ABSolute`. This mechanism allows automatic checking of the absolute basic values of adjacent-channel power as defined in mobile radio standards.

Parameter

first value: 0 to 100dB; limit for the lower and the upper alternate adjacent channel
second value: 0 to 100dB; is ignored but must be indicated for reasons of compatibility with the FSP family

Example

```
CALC:LIM:ACP:ALT2 30DB, 30DB
```

Sets the relative limit value for the power in the lower and upper second alternate adjacent channel to 30 dB below the channel power.

Characteristics

*RST value: 0 DB

SCPI: device-specific

Mode

A, CDMA, EVDO

CALCulate<1|2>:LIMit<1...8>:ACPpower:ALTernate<1...11>[:RELative]:STATe

This command activates the limit check for the alternate adjacent channels for adjacent channel power measurements. Before the command, the limit check must be activated using `CALCulate<1|2>:LIMit<1...8>:ACPpower[:STATe]`.

The numeric suffix after `ALTernate` denotes the alternate channel. The numeric suffixes `<1|2>` with `CALCulate` and `<1...8>` with `LIMit` are irrelevant for this command.

The result can be queried with

`CALCulate<1|2>:LIMit<1...8>:ACPpower:ALTernate<1...11>:RESult?`. It should be noted that a complete measurement must be performed between switching on the limit check and the result query, since otherwise no correct results are obtained.

Parameter

ON | OFF

Example

```
CALC:LIM:ACP:ALT2 30DB, 30DB
```

Sets the relative limit value for the power in the lower and upper second alternate adjacent channel to 30 dB below the channel power.

```
CALC:LIM:ACP:ALT2:ABS -35DBM, -35DBM
```

Sets the absolute limit value for the power in the lower and upper second alternate adjacent channel to -35 dBm.

```
CALC:LIM:ACP ON
```

Switches on globally the limit check for the channel/adjacent channel measurement.

```
CALC:LIM:ACP:ALT2:STAT ON
```

Switches on the check of the relative limit values for the lower and upper second alternate adjacent channel.

```
CALC:LIM:ACP:ALT2:ABS:STAT ON
```

Switches on the check of absolute limit values for the lower and upper second alternate adjacent channel.

```
INIT;*WAI
```

Starts a new measurement and waits for the sweep end.

CALC:LIM:ACP:ALT2:RES?

Queries the limit check result in the second alternate adjacent channels.

Characteristics

*RST value: OFF

SCPI: device-specific

Mode

A, CDMA, EVDO

CALCulate<1|2>:LIMit<1...8>:ACPpower:ALTernate<1...11>:ABSolute

This command defines the absolute limit value for the lower/upper alternate adjacent-channel power measurement (Adjacent Channel Power).

The numeric suffix after `ALTernate` denotes the alternate channel. The numeric suffixes <1|2> with `CALCulate` and <1...8> with `LIMit` are irrelevant for this command.

It should be noted that the absolute limit value for the limit check has no effect as soon as it is below the relative limit value defined with

`CALCulate<1|2>:LIMit<1...8>:ACPpower:ALTernate<1...11>[:RELative]`. This mechanism allows automatic checking of the absolute basic values defined in mobile radio standards for the power in adjacent channels.

Parameter

first value: -200DBM to 200DBM; limit for the lower and the upper alternate adjacent channel

second value: -200DBM to 200DBM; is ignored but must be indicated for reasons of compatibility with the FSP family

Example

CALC:LIM:ACP:ALT2:ABS -35DBM, -35DBM

Sets the absolute limit value for the power in the lower and upper second alternate adjacent channel to -35 dBm.

Characteristics

*RST value: -200DBM

SCPI: device-specific

Mode

A, CDMA, EVDO

CALCulate<1|2>:LIMit<1...8>:ACPpower:ALTernate<1...11>:ABSolute:STATe

This command activates the limit check for the alternate adjacent channels for adjacent-channel power measurement (Adjacent Channel Power).

Before the command, the limit check must be globally switched on for the channel/adjacent-channel power with the `CALCulate<1|2>:LIMit<1...8>:ACPpower[:STATe]` command.

The numeric suffix after `ALTernate` denotes the alternate channel. The numeric suffixes <1|2> with `CALCulate` and <1...8> with `LIMit` are irrelevant for this command.

The result can be queried with

`CALCulate<1|2>:LIMit<1...8>:ACPpower:ALTernate<1...11>:RESult?`. It should be noted that a complete measurement must be performed between switching on the limit check and the result query, since otherwise no correct results are available.

Parameter

ON | OFF

Example

```
CALC:LIM:ACP:ALT2 30DB, 30DB
```

Sets the relative limit value for the power in the lower and upper second alternate adjacent channel to 30 dB below the channel power.

```
CALC:LIM:ACP:ALT2:ABS -35DBM, -35DBM
```

Sets the absolute limit value for the power in the lower and upper second alternate adjacent channel to -35 dBm.

```
CALC:LIM:ACP ON
```

Switches on globally the limit check for the channel/adjacent channel measurement.

```
CALC:LIM:ACP:ALT2:STAT ON
```

Switches on the check of the relative limit values for the lower and upper second alternative adjacent channels.

```
CALC:LIM:ACP:ALT2:ABS:STAT ON
```

Switches on the check of absolute limit values for the lower and upper second alternative adjacent channels.

```
INIT;*WAI
```

Starts a new measurement and waits for the sweep end.

```
CALC:LIM:ACP:ALT2:RES?
```

Queries the limit check result in the second alternate adjacent channels.

Characteristics

*RST value: OFF

SCPI: device-specific

Mode

A, CDMA, EVDO

CALCulate<1|2>:LIMit<1...8>:ACPpower:ALTErnate<1...11>:RESult?

This command queries the result of the limit check for the alternate adjacent channels for adjacent channel power measurements.

The numeric suffix after `ALTErnate` denotes the alternate channel. The numeric suffixes `<1|2>` with `CALCulate` and `<1...8>` with `LIMit` are irrelevant for this command.

If the power measurement of the adjacent channel is switched off, the command produces a query error.

This command is a query and therefore has no *RST value.

Parameter

The result is returned in the form `<result>, <result>` where `<result>` = PASSED | FAILED and where the first (second) returned value denotes the lower (upper) alternate adjacent channel.

Example

```
CALC:LIM:ACP:ALT2 30DB, 30DB
```

Sets the relative limit value for the power in the lower and upper second alternate adjacent channel to 30 dB below the channel power.

```
CALC:LIM:ACP:ALT2:ABS -35DBM, -35DBM
```

Sets the absolute limit value for the power in the lower and upper second alternate adjacent channel to -35 dBm.

```
CALC:LIM:ACP ON
```

Switches on globally the limit check for the channel/adjacent channel measurement.

```
CALC:LIM:ACP:ALT2:STAT ON
```

Switches on the limit check for the lower and upper second adjacent channel.

```
INIT;*WAI
```

Starts a new measurement and waits for the sweep end.

CALC:LIM:ACP:ALT2:RES?

Queries the limit check result in the second alternate adjacent channels.

Characteristics

*RST value: -

SCPI: device-specific

Mode

A, CDMA, EVDO, WLAN

CALCulate:LIMit:CONTrol Subsystem

The CALCulate:LIMit:CONTrol subsystem defines the x-axis (CONTrol axis).

This subsystem is available from firmware version 1.10.

Commands of the CALCulate:LIMit:CONTrol Subsystem

- CALCulate<1|2>:LIMit<1...8>:CONTrol[:DATA]
- CALCulate<1|2>:LIMit<1...8>:CONTrol:DOMain
- CALCulate<1|2>:LIMit<1...8>:CONTrol:MODE
- CALCulate<1|2>:LIMit<1...8>:CONTrol:OFFSet
- CALCulate<1|2>:LIMit<1...8>:CONTrol:SHIFt
- CALCulate<1|2>:LIMit<1...8>:CONTrol:SPACing

CALCulate<1|2>:LIMit<1...8>:CONTrol[:DATA]

This command defines the x-axis values (frequencies or times) of the upper or lower limit lines. The number of values for the CONTrol axis and for the corresponding UPPer and/or LOWer limit lines has to be identical. Otherwise default values are entered for missing values or not required values are deleted.

In analyzer mode, the unit of values depends on the span setting of the x-axis. For details refer to [CALCulate<1|2>:LIMit<1...8>:CONTrol:DOMain](#).

The numeric suffixes <1|2> are irrelevant for this command.

This command is available from firmware version 1.10.

Parameter

<numeric_value>,<numeric_value>

Example

```
CALC:LIM2:CONT 1MHz,30MHz,100MHz,300MHz,1GHz
```

Defines 5 reference values for the x-axis of limit line 2.

```
CALC:LIM2:CONT?
```

Outputs the reference values for the x-axis of limit line 2 separated by a comma.

Characteristics

*RST value: - ([CALCulate<1|2>:LIMit<1...8>:STATe](#) is set to OFF)

SCPI: conform

Mode

A, ADEMOD, CDMA, EVDO, NF

CALCulate<1|2>:LIMit<1...8>:CONTrol:DOMain

This command defines the span setting for the x-axis values.

The numeric suffixes <1|2> are irrelevant for this command.

This command is available from firmware version 1.10.

Parameter

FREQuency | TIME

Example

```
CALC:LIM2:CONT:DOM TIME
```

Defines zero span for the x-axis of limit line 2.

Characteristics

*RST value: FREQuency

SCPI: device-specific

Mode

A, ADEMOD, CDMA, EVDO

CALCulate<1|2>:LIMit<1...8>:CONTrol:MODE

This command selects the relative or absolute scaling for the x-axis of the selected limit line.

The numeric suffixes <1|2> are irrelevant for this command.

This command is available from firmware version 1.10.

Parameter

RELative | ABSolute

Example

```
CALC:LIM2:CONT:MODE REL
```

Defines the x-axis of limit line 2 as relatively scaled.

Characteristics

*RST value: ABSolute

SCPI: device-specific

Mode

A, ADEMOD, CDMA, EVDO

CALCulate<1|2>:LIMit<1...8>:CONTrol:OFFSet

This command defines an offset for the x-axis value of the selected relative limit line for span > 0 or zero span.

In analyzer mode, the unit of values depends on the span setting of the x-axis. For details refer to [CALCulate<1|2>:LIMit<1...8>:CONTrol:DOMain](#).

The numeric suffixes <1|2> are irrelevant for this command.

This command is available from firmware version 1.10.

Parameter

<numeric_value>

Example

```
CALC:LIM2:CONT:OFFS 100us
```

Sets the X offset for limit line 2 (defined in zero span) to 100µs.

Characteristics

*RST value: 0

SCPI: device-specific

Mode

A, ADEMOD, CDMA, EVDO

CALCulate<1|2>:LIMit<1...8>:CONTrol:SHIFt

This command moves a limit line by the indicated value in x direction. In contrast to [CALCulate<1|2>:LIMit<1...8>:CONTrol:OFFSet](#), the line is shifted by modifying the individual x values and not by means of an additive offset.

In analyzer mode, the unit of values depends on the span setting of the x-axis. For details refer to [CALCulate<1|2>:LIMit<1...8>:CONTrol:DOMain](#).

The numeric suffixes <1|2> are irrelevant for this command.

This command is an event and therefore has no *RST value and no query.

This command is available from firmware version 1.10.

Parameter

<numeric_value>

Example

```
CALC:LIM2:CONT:SHIF 50KHZ
```

Shifts all reference values of limit line 2 by 50 kHz.

Characteristics

*RST value: -

SCPI: device-specific

Mode

A, ADEMOD, CDMA, EVDO, NF

CALCulate<1|2>:LIMit<1...8>:CONTrol:SPACing

This command selects linear or logarithmic interpolation for the calculation of limit lines from frequency points.

The numeric suffixes <1|2> are irrelevant for this command.

This command is available from firmware version 1.10.

Parameter

LINear | LOGarithmic

Example

```
CALC:LIM:CONT:SPAC LIN
```

Characteristics

*RST value: LIN

SCPI: device-specific

Mode

A, CDMA, EVDO

CALCulate:LIMit:ESpectrum Subsystem

The CALCulate:LIMit:ESpectrum subsystem defines the power classes used in Spectrum Emission Mask measurements. This subsystem is available from firmware version 1.90.

Commands of the CALCulate:LIMit:ESpectrum subsystem

- CALCulate<1|2>:LIMit<1...8>:ESpectrum:PCLass<1...4>[:EXCLusive]
- CALCulate<1|2>:LIMit<1...8>:ESpectrum:PCLass<1...4>:MINimum
- CALCulate<1|2>:LIMit<1...8>:ESpectrum:PCLass<1...4>:MAXimum
- CALCulate<1|2>:LIMit<1...8>:ESpectrum:PCLass<1...4>:COUNT
- CALCulate<1|2>:LIMit<1...8>:ESpectrum:PCLass<1...4>:LIMit[:STATe]

CALCulate<1|2>:LIMit<1...8>:ESpectrum:PCLass<1...4>[:EXCLusive]

This command sets the power classes used in the measurement. It is only possible to use power classes for which limits are defined. Also, either only one power class at a time or all power classes together can be selected.

The numeric suffixes <1|2> and <1...8> are irrelevant for this command.

Parameter

ON | OFF

Example

```
CALC:LIM:ESP:PCL1 ON
```

Activates the first defined power class.

Characteristics

*RST value: -

SCPI: conform

Mode

A, CDMA, EVDO

CALCulate<1|2>:LIMit<1...8>:ESpectrum:PCLass<1...4>:MINimum

This command sets the lower limit level for one power class. The unit is dBm. The limit always start at - 200 dBm, i.e. the first lower limit can not be set. If more than one power class is in use, the lower limit must equal the upper limit of the previous power class.

The numeric suffix at PCLass<1...4> denotes the power class to be defined.

The numeric suffixes <1|2> and <1...8> are irrelevant for this command.

Parameter

<numeric_value>

Example

```
CALC:LIM:ESP:PCL2:MIN -40 dBm
```

Sets the minimum power value of the second power class to -40 dBm.

Characteristics:

*RST value: -

SCPI: conform

Mode

A, CDMA, EVDO

CALCulate<1|2>:LIMit<1...8>:ESPectrum:PCLass<1...4>:MAXimum

This command sets the upper limit level for one power class. The unit is dBm. The limit always ends at + 200 dBm, i.e. the upper limit of the last power class can not be set. If more than one power class is in use, the upper limit must equal the lower limit of the next power class.

The numeric suffix at PCLass<1...4> denotes the power class to be defined.

The numeric suffixes <1|2> and <1...8> are irrelevant for this command.

Parameter

<numeric_value>

Example

```
CALC:LIM:ESP:PCL1:MAX -40 dBm
```

Sets the maximum power value of the first power class to -40 dBm.

Characteristics:

*RST value: -

SCPI: conform

Mode

A, CDMA, EVDO

CALCulate<1|2>:LIMit<1...8>:ESPectrum:PCLass<1...4>:COUNT

This command sets the number of power classes to be defined.

The numeric suffixes are irrelevant

Parameter

1 to 4

Example

```
CALC:LIM:ESP:PCL:COUN 2
```

Two power classes can be defined.

Characteristics:

*RST value: -

SCPI: conform

Mode

A, CDMA, EVDO

CALCulate<1|2>:LIMit<1...8>:ESPectrum:PCLass<1...4>:LIMit[:STATe]

This command defines which limits are evaluated in the measurement.

The numeric suffix at PCLass<1..4> defines the power class to be evaluated. The numeric suffixes <1|2> and <1..8> are irrelevant

Parameter

ABSolute	Evaluates only limit lines with absolute power values
RELative	Evaluates only limit lines with relative power values
OR	Evaluates limit lines with relative and absolute power values. A negative result is returned if both limits fail.
AND	Evaluates limit lines with relative and absolute power values. A negative result is returned if at least one limit failed.

Example

```
CALC:LIM:ESP:PCL:COUN ABS
```

Characteristics:

*RST value: -
SCPI: conform

Mode

A, CDMA

CALCulate<1|2>:LIMit<1...8>:ESPectrum:LIMits

This command sets the limits for all power classes you want to use. The limit defined by the string always starts at -200 dBm and always ends at 200 dBm. Between these up to three limits can be defined. See also [CALCulate<1|2>:LIMit<1...8>:ESPectrum:PCLass<1...4>:MINimum](#) and [CALCulate<1|2>:LIMit<1...8>:ESPectrum:PCLass<1...4>:MAXimum](#)

The numeric suffixes <1|2> and <1...8> are irrelevant for this command.

Parameter

<numeric value>

Example

```
-200, -90, 0, 90, 200
```

Sets the minimum power value of the first power class to -200 dBm and the maximum power value of the first power class to -90 dBm. The second power class begins at -90 dBm and ends at 0 dBm etc.

Characteristics

*RST value: -
SCPI: conform

Mode

A, CDMA, EVDO

CALCulate:LIMit:LOWer Subsystem

The CALCulate:LIMit:LOWer subsystem defines the lower limit line. This subsystem is available from firmware version 1.10.

Commands of the CALCulate:LIMit:LOWer Subsystem

- CALCulate<1|2>:LIMit<1...8>:LOWer[:DATA]
- CALCulate<1|2>:LIMit<1...8>:LOWer:STATe
- CALCulate<1|2>:LIMit<1...8>:LOWer:OFFSet
- CALCulate<1|2>:LIMit<1...8>:LOWer:MARGIn
- CALCulate<1|2>:LIMit<1...8>:LOWer:MODE
- CALCulate<1|2>:LIMit<1...8>:LOWer:SHIFt
- CALCulate<1|2>:LIMit<1...8>:LOWer:SPACing
- CALCulate<1|2>:LIMit<1...8>:LOWer:THReshold

CALCulate<1|2>:LIMit<1...8>:LOWer[:DATA]

This command defines the values for the selected lower limit line.

The number of values for the CONTrol axis and for the corresponding LOWer limit line has to be identical. Otherwise default values are entered for missing values or not necessary values are deleted.

The unit must be identical with the unit selected by CALCulate<1|2>:LIMit<1...8>:UNIT. If no unit is indicated, the unit defined with CALCulate<1|2>:LIMit<1...8>:UNIT is automatically used.

If the measured values are smaller than the LOWer limit line, the limit check signals errors.

The units DEG, RAD, S, HZ, PCT are not available in the spectrum analyzer mode.

The numeric suffixes <1|2> are irrelevant for this command.

This command is available from firmware version 1.10.

Parameter

<numeric_value>,<numeric_value>

Example

```
CALC:LIM2:LOW -30,-40,-10,-40,-30
```

Defines 5 lower limit values for limit line 2 in the preset unit.

```
CALC:LIM2:LOW?
```

Outputs the lower limit values of limit line 2 separated by a comma.

Characteristics

*RST value: - (LIMit:STATe is set to OFF)

SCPI: conform

Mode

A, ADEMOD, CDMA, EVDO, NF

CALCulate<1|2>:LIMit<1...8>:LOWer:STATe

This command switches on or off the indicated limit line. The limit check is activated separately with `CALCulate<1|2>:LIMit<1...8>:STATe`.

In spectrum analyzer mode, the result of the limit check can be queried with `CALCulate<1|2>:LIMit<1...8>:FAIL?`.

The numeric suffixes <1|2> are irrelevant for this command.

This command is available from firmware version 1.10.

Parameter

ON | OFF

Example

```
CALC:LIM4:LOW:STAT ON
Switches on limit line 4 (lower limit).
```

Characteristics

*RST value: OFF

SCPI: conform

Mode

A, ADEMOD, CDMA, EVDO, NF

CALCulate<1|2>:LIMit<1...8>:LOWer:OFFSet

This command defines an offset for the y-axis of the selected relative lower limit line. In contrast to `CALCulate<1|2>:LIMit<1...8>:LOWer:SHIFt`, the line is not shifted by modifying the individual Y values but by means of an additive offset.

The numeric suffixes <1|2> are irrelevant for this command.

This command is available from firmware version 1.10.

Parameter

<numeric_value>

Example

```
CALC:LIM2:LOW:OFFS 3dB
Shifts limit line 2 by 3 dB upwards.
```

Characteristics

*RST value: 0

SCPI: device-specific

Mode

A, ADEMOD, CDMA, EVDO

CALCulate<1|2>:LIMit<1...8>:LOWer:MARGin

This command defines a margin to a lower limit line, at which out-of-limit values are signaled (if the limit check is active), but not handled as a violation of the limit value.

Only the unit dB is available in spectrum analyzer mode.

The numeric suffixes <1|2> are irrelevant for this command.

This command is available from firmware version 1.10.

Parameter

<numeric_value>

Example

CALC:LIM:LOW:MARG 10dB

Characteristics

*RST value: 0

SCPI: device-specific

Mode

A, ADEMOD, CDMA, EVDO

CALCulate<1|2>:LIMit<1...8>:LOWer:MODE

This command selects the relative or absolute scaling for the y-axis of the selected lower limit line.

Selecting RELative causes the unit to be switched to DB.

The numeric suffixes <1|2> are irrelevant for this command.

This command is available from firmware version 1.10.

Parameter

RELative | ABSolute

Example

CALC:LIM:LOW:MODE REL

Defines the y-axis of limit line 2 as relative scaled.

Characteristics

*RST value: ABSolute

SCPI: device-specific

Mode

A, ADEMOD, CDMA, EVDO

CALCulate<1|2>:LIMit<1...8>:LOWer:SHIFt

This command shifts a limit line by the indicated value in Y direction. In contrast to [CALCulate<1|2>:LIMit<1...8>:LOWer:OFFSet](#), the line is shifted by modifying the individual Y values but not by means of an additive offset.

The numeric suffixes <1|2> are irrelevant for this command.

This command is an event and therefore has no *RST value and no query.

This command is available from firmware version 1.10.

Parameter

<numeric_value>

Example

CALC:LIM3:LOW:SHIF 20DB

Shifts all Y values of limit line 3 by 20 dB.

Characteristics

*RST value: -

SCPI: device-specific

Mode

A, ADEMOD, CDMA, EVDO, NF

CALCulate<1|2>:LIMit<1...8>:LOWer:SPACing

This command selects linear or logarithmic interpolation for the lower limit line.

The numeric suffixes <1|2> are irrelevant for this command.

This command is available from firmware version 1.10.

Parameter

LINear | LOGarithmic

Example

```
CALC:LIM:LOW:SPAC LIN
```

Characteristics

*RST value: LIN

SCPI: device-specific

Mode

A, CDMA, EVDO

CALCulate<1|2>:LIMit<1...8>:LOWer:THReshold

This command defines an absolute threshold value for limit lines with relative y-axis scaling. The absolute threshold value is used in the limit check as soon as it exceeds the relative limit value.

The unit must correspond to the unit selected with `CALCulate<1|2>:LIMit<1...8>:UNIT` (except dB which is not allowed). If no unit is indicated, the unit defined with `CALCulate<1|2>:LIMit<1...8>:UNIT` is automatically used (exception: dBm instead of dB).

The units DEG, RAD, S, HZ, PCT are not available in the spectrum analyzer mode.

The numeric suffixes <1|2> are irrelevant for this command.

This command is available from firmware version 1.10.

Parameter

<numeric_value>

Example

```
CALC:LIM2:LOW:THR -35DBM
```

Defines an absolute threshold value for limit line 2.

Characteristics

*RST value: -200 dBm

SCPI: device-specific

Mode

A, ADEMOD, CDMA, EVDO

CALCulate:LIMit:UPPer Subsystem

The CALCulate:LIMit:UPPer subsystem defines the upper limit line. This subsystem is available from firmware version 1.10.

Commands of the CALCulate:LIMit:UPPer Subsystem

- CALCulate<1|2>:LIMit<1...8>:UPPer[:DATA]
- CALCulate<1|2>:LIMit<1...8>:UPPer:MARGin
- CALCulate<1|2>:LIMit<1...8>:UPPer:MODE
- CALCulate<1|2>:LIMit<1...8>:UPPer:OFFSet
- CALCulate<1|2>:LIMit<1...8>:UPPer:SHIFt
- CALCulate<1|2>:LIMit<1...8>:UPPer:SPACing
- CALCulate<1|2>:LIMit<1...8>:UPPer:STATe
- CALCulate<1|2>:LIMit<1...8>:UPPer:THReshold

CALCulate<1|2>:LIMit<1...8>:UPPer[:DATA]

This command defines the values for the upper limit lines

The number of values for the CONTROL axis and for the corresponding UPPER and/or LOWER limit line has to be identical. Otherwise default values are entered for missing values or not necessary values are deleted.

The unit must be identical with the unit selected by CALCulate<1|2>:LIMit<1...8>:UNIT. If no unit is indicated, the unit defined with CALCulate<1|2>:LIMit<1...8>:UNIT is automatically used.

In spectrum analyzer mode, the limit check indicates errors if the measured values exceed the UPPER limit line. The units DEG, RAD, S, HZ, PCT are not available in spectrum analyzer mode.

The numeric suffixes <1|2> are irrelevant for this command.

This command is available from firmware version 1.10.

Parameter

<numeric_value>,<numeric_value>

Example

```
CALC:LIM2:UPP -10,0,0,-10,-5
```

Defines 5 upper limit values for limit line 2 in the preset unit.

```
CALC:LIM2:UPP?
```

Outputs the upper limit values for limit line 2 separated by a comma.

Characteristics

*RST value: - (CALCulate<1|2>:LIMit<1...8>:STATe is set to OFF)

SCPI: conform

Mode

A, ADEMOD, CDMA, EVDO, NF

CALCulate<1|2>:LIMit<1...8>:UPPer:MARGin

This command defines a margin to an upper limit line, at which out-of-limit values are signaled (if the limit check is active), but not handled as a violation of the limit value.

Only the unit dB is available in spectrum analyzer mode.

The numeric suffixes <1|2> are irrelevant for this command.

This command is available from firmware version 1.10.

Parameter

<numeric_value>

Example

```
CALC:LIM2:UPP:MARG 10dB
```

Defines the margin of limit line 2 to 10 dB below the limit value.

Characteristics

*RST value: 0

SCPI: device-specific

Mode

A, ADEMOD, CDMA, EVDO

CALCulate<1|2>:LIMit<1...8>:UPPer:MODE

This command selects the relative or absolute scaling for the y-axis of the selected upper limit line.

Selecting RELative causes the unit to be switched to DB.

The numeric suffixes <1|2> are irrelevant for this command.

This command is available from firmware version 1.10.

Parameter

RELative | ABSolute

Example

```
CALC:LIM2:UPP:MODE REL
```

Defines the y-axis of limit line 2 as relative scaled.

Characteristics

*RST value: ABSolute

SCPI: device-specific

Mode

A, ADEMOD, CDMA, EVDO

CALCulate<1|2>:LIMit<1...8>:UPPer:OFFSet

This command defines an offset for the y-axis of the selected relative upper limit line. In contrast to [CALCulate<1|2>:LIMit<1...8>:UPPer:SHIFt](#), the line is not shifted by modifying the individual Y values but by means of an additive offset.

Only the unit dB is available in the spectrum analyzer mode.

The numeric suffixes <1|2> are irrelevant for this command.

This command is available from firmware version 1.10.

Parameter

<numeric_value>

Example

```
CALC:LIM2:UPP:OFFS 3dB
```

Shifts limit line 2 by 3 dB upwards.

Characteristics

*RST value: 0

SCPI: device-specific

Mode

A, ADEMOD, CDMA, EVDO

CALCulate<1|2>:LIMit<1...8>:UPPer:SHIFt

This command moves a limit line by the indicated value in Y direction. In contrast to `CALCulate<1|2>:LIMit<1...8>:UPPer:OFFSet`, the line is shifted by modifying the individual Y values and not by means of an additive offset.

The numeric suffixes <1|2> are irrelevant for this command.

This command is an event and therefore has no *RST value and no query.

This command is available from firmware version 1.10.

Parameter

<numeric_value>

Example

```
CALC:LIM3:UPP:SHIF 20
```

Shifts all Y values of limit line 3 by 20 limit line units, e.g. dB.

Characteristics

*RST value: -

SCPI: device-specific

Mode

A, ADEMOD, CDMA, EVDO, NF

CALCulate<1|2>:LIMit<1...8>:UPPer:SPACing

This command selects linear or logarithmic interpolation for the upper limit line.

The numeric suffixes <1|2> are irrelevant for this command.

This command is available from firmware version 1.10.

Parameter

LINear | LOGarithmic

Example

```
CALC:LIM:UPP:SPAC LIN
```

Characteristics

*RST value: LIN

SCPI: device-specific

Mode

A, CDMA, EVDO

CALCulate<1|2>:LIMit<1...8>:UPPer:STATe

This command switches on or off the indicated limit line. The limit check is activated separately with `CALCulate<1|2>:LIMit<1...8>:STATe`.

In spectrum analyzer mode, the result of the limit check can be queried with `CALCulate<1|2>:LIMit<1...8>:FAIL?`.

The numeric suffixes <1|2> are irrelevant for this command.

This command is available from firmware version 1.10.

Parameter

ON | OFF

Example

```
CALC:LIM4:UPP:STAT ON
```

Switches on limit line 4 (upper limit).

Characteristics

*RST value: OFF

SCPI: conform

Mode

A, ADEMOD, CDMA, EVDO, NF

CALCulate<1|2>:LIMit<1...8>:UPPer:THReshold

This command defines an absolute threshold value for limit lines with relative y-axis scaling. The absolute threshold value is used in the limit check as soon as it exceeds the relative limit value.

The unit must correspond to the unit selected with `CALCulate<1|2>:LIMit<1...8>:UNIT` (except dB which is not possible). If no unit is indicated, the unit defined with `CALCulate<1|2>:LIMit<1...8>:UNIT` is automatically used (exception: dBm instead of dB).

The units DEG, RAD, S, HZ, PCT are not available in the spectrum analyzer mode.

The numeric suffixes <1|2> are irrelevant for this command.

This command is available from firmware version 1.10.

Parameter

<numeric_value>

Example

```
CALC:LIM2:UPP:THR -35DBM
```

Defines an absolute threshold value for limit line 2.

Characteristics

*RST value: -200 dBm

SCPI: device-specific

Mode

A, ADEMOD, CDMA, EVDO

CALCulate:MARKer Subsystem

The CALCulate:MARKer subsystem checks the marker functions of the instrument.

The following subsystem is included:

- "CALCulate:MARKer:FUNCTION Subsystem" on page 6.67

Commands of the CALCulate:MARKer Subsystem

- CALCulate<1|2>:MARKer<1...4>[:STATe]
- CALCulate<1|2>:MARKer<1...4>:AOFF
- CALCulate<1|2>:MARKer<1...4>:COUNT
- CALCulate<1|2>:MARKer<1...4>:COUNT:FREQuency?
- CALCulate<1|2>:MARKer<1...4>:COUNT:RESolution
- CALCulate<1|2>:MARKer<1...4>:LOEXclude
- CALCulate<1|2>:MARKer<1...4>:MAXimum[:PEAK]
- CALCulate<1|2>:MARKer<1...4>:MAXimum:AUTO
- CALCulate<1|2>:MARKer<1...4>:MAXimum:LEFT
- CALCulate<1|2>:MARKer<1...4>:MAXimum:NEXT
- CALCulate<1|2>:MARKer<1...4>:MAXimum:RIGHT
- CALCulate<1|2>:MARKer<1...4>:MINimum[:PEAK]
- CALCulate<1|2>:MARKer<1...4>:MINimum:AUTO
- CALCulate<1|2>:MARKer<1...4>:MINimum:LEFT
- CALCulate<1|2>:MARKer<1...4>:MINimum:NEXT
- CALCulate<1|2>:MARKer<1...4>:MINimum:RIGHT
- CALCulate<1|2>:MARKer<1...4>:PEXCursion
- CALCulate<1|2>:MARKer<1...4>:TRACe
- CALCulate<1|2>:MARKer<1...4>:X
- CALCulate<1|2>:MARKer<1...4>:X:SLIMits[:STATe]
- CALCulate<1|2>:MARKer<1...4>:X:SLIMits:LEFT
- CALCulate<1|2>:MARKer<1...4>:X:SLIMits:RIGHT
- CALCulate<1|2>:MARKer<1...4>:X:SSIZE
- CALCulate<1|2>:MARKer<1...4>:Y?
- CALCulate<1|2>:MARKer<1...4>:Y:PERCent

CALCulate<1|2>:MARKer<1...4>[:STATe]

This command switches on or off the currently selected marker. If no indication is made, marker 1 is selected automatically. If marker 2, 3 or 4 is selected and used as a delta marker, it is switched to marker mode.

For CDMA2000 and 1xEV-DO code domain measurements (option K82 and K84) the numeric suffix <1|2> selects the measurement screen. In the other modes the numeric suffix <1|2> is irrelevant.

Parameter

ON | OFF

Example

CALC:MARK3 ON

Switches on marker 3 or switches to marker mode.

Characteristics

*RST value: OFF

SCPI: device-specific

Mode

A, ADEMOD, CATV, CDMA, EVDO, SPECM, WCDMA

CALCulate<1|2>:MARKer<1...4>:AOFF

This command switches off all active markers and all delta markers and active marker/delta marker measurement functions.

For CDMA2000 and 1xEV-DO code domain measurements (option K82 and K84) the numeric suffix <1|2> selects the measurement screen. In the other modes the numeric suffix <1|2> is irrelevant.

This command is an event and therefore has no *RST value and no query.

Example

CALC:MARK:AOFF

Switches off all markers.

Characteristics

*RST value: -

SCPI: device-specific

Mode

A, ADEMOD, CATV, CDMA, EVDO, WCDMA

CALCulate<1|2>:MARKer<1...4>:COUNT

This command switches on or off the frequency counter at the marker position.

The count result is queried with [CALCulate<1|2>:MARKer<1...4>:COUNT:FREQuency?](#).

Frequency counting is possible only for one marker at a time. If it is activated for another marker, it is automatically deactivated for the previous marker.

It should be noted that a complete sweep must be performed after switching on the frequency counter to ensure that the frequency to be measured is actually reached. The synchronization to the sweep end required for this is only possible in single sweep mode.

The numeric suffixes <1|2> are irrelevant for this command.

Parameter

ON | OFF

Example

INIT:CONT OFF

Switches to single sweep mode.

CALC:MARK ON

Switches on marker 1.

CALC:MARK:COUN ON

Switches on the frequency counter for marker 1.

```
INIT; *WAI
```

Starts a sweep and waits for the end.

```
CALC:MARK:COUN:FREQ?
```

Outputs the measured value.

Characteristics

*RST value: OFF

SCPI: device-specific

Mode

A

CALCulate<1|2>:MARKer<1...4>:COUNT:FREQUency?

This command queries the result of the frequency counter for the indicated marker. Before the command, the frequency counter should be switched on and a complete measurement performed to obtain a correct count result. Therefore, a single sweep with synchronization must be performed between switching on the frequency counter and querying the count result.

The numeric suffixes <1|2> are irrelevant for this command.

This command is only a query and therefore has no *RST value.

Example

```
INIT:CONT OFF
```

Switches to single sweep mode.

```
CALC:MARK2 ON
```

Switches on marker 2.

```
CALC:MARK2:COUN ON
```

Switches the frequency counter for marker 2.

```
INIT; *WAI
```

Starts a sweep and waits for the end.

```
CALC:MARK2:COUN:FREQ?
```

Outputs the measured value of marker 2.

Characteristics

*RST value: -

SCPI: device-specific

Mode

A

CALCulate<1|2>:MARKer<1...4>:COUNT:RESolution

This command specifies the resolution of the frequency counter.

The numeric suffixes <1|2> and <1...4> are irrelevant for this command.

Parameter

0.1 | 1 | 10 | 100 | 1000 | 10000 Hz

Example

```
CALC:MARK:COUN:RES 1kHz
```

Sets the resolution of the frequency counter to 1 kHz.

Characteristics

*RST value: 1kHz

SCPI: device-specific

Mode

A

CALCulate<1|2>:MARKer<1...4>:LOEXclude

This command switches the local oscillator suppression for peak search on or off. This setting applies to all markers and delta markers.

The numeric suffixes <1|2> and <1...4> are irrelevant.

Parameter

ON | OFF

Example

```
CALC:MARK:LOEX ON
```

Characteristics

*RST value: ON

SCPI: device-specific

Mode

A-F, ADEMOD, CATV, SPECM

CALCulate<1|2>:MARKer<1...4>:MAXimum[:PEAK]

This command positions the marker to the current maximum value of the corresponding trace. The corresponding marker is activated first or switched to the marker mode.

For CDMA2000 and 1xEV-DO code domain measurements (option K82 and K84) the numeric suffix <1|2> selects the measurement screen. In the other modes the numeric suffix <1|2> is irrelevant.

This command is an event and therefore has no *RST value and no query.

Note: *If no maximum value is found on the trace (level spacing to adjacent values < peak excursion), an execution error (error code: -200) is produced.*

Example

```
CALC:MARK2:MAX
```

Positions marker 2 to the maximum value of the trace.

Characteristics

*RST value: -

SCPI: device-specific

Mode

A, ADEMOD, CATV, CDMA, EVDO, SPECM, WCDMA

CALCulate<1|2>:MARKer<1...4>:MAXimum:AUTO

Activates the automatic peak search function for marker 1 at the end of each particular sweep. This function may be used during adjustments of a device under test to keep track of the actual peak marker position and level.

For CDMA2000 and 1xEV-DO code domain measurements (option K82 and K84) the numeric suffix <1|2> selects the measurement screen. In the other modes the numeric suffix <1|2> is irrelevant.

This command is available from firmware version 1.50.

Note: If no maximum value is found on the trace (level spacing to adjacent values < peak excursion), an execution error (error code: -200) is produced.

Parameter

ON | OFF

Example

CALC:MARK:MAX:AUTO ON

Activates the automatic peak search function for marker 1 at the end of each particular sweep.

Characteristics

*RST value: OFF

SCPI: device-specific

Mode

A

CALCulate<1|2>:MARKer<1...4>:MAXimum:LEFT

This command positions the marker to the next smaller maximum value to the left of the current value (i.e. in descending X values) on the trace.

For CDMA2000 and 1xEV-DO code domain measurements (option K82 and K84) the numeric suffix <1|2> selects the measurement screen. In the other modes the numeric suffix <1|2> is irrelevant.

This command is an event and therefore has no *RST value and no query.

Note: If no next smaller maximum value is found on the trace (level spacing to adjacent values < peak excursion), an execution error (error code: -200) is produced.

Example

CALC:MARK2:MAX:LEFT

Positions marker 2 to the next lower maximum value to the left of the current value.

Characteristics

*RST value: -

SCPI: device-specific

Mode

A, ADEMOD, BT, CATV, CDMA, EVDO, SPECM, WCDMA

CALCulate<1|2>:MARKer<1...4>:MAXimum:NEXT

This command positions the marker to the next smaller maximum value of the corresponding trace.

For CDMA2000 and 1xEV-DO code domain measurements (option K82 and K84) the numeric suffix <1|2> selects the measurement screen. In the other modes the numeric suffix <1|2> is irrelevant.

This command is an event and therefore has no *RST value and no query.

Note: If no next smaller maximum value is found on the trace (level spacing to adjacent values < peak excursion), an execution error (error code: -200) is produced.

Example

CALC:MARK2:MAX:NEXT

Positions marker 2 to the next lower maximum value.

Characteristics

*RST value: -

SCPI: device-specific

Mode

A, ADEMOD, CATV, CDMA, EVDO, SPECM, WCDMA

CALCulate<1|2>:MARKer<1...4>:MAXimum:RIGHT

This command positions the marker to the next smaller maximum value to the right of the current value (i.e. in ascending X values) on the corresponding trace.

For CDMA2000 and 1xEV-DO code domain measurements (option K82 and K84) the numeric suffix <1|2> selects the measurement screen. In the other modes the numeric suffix <1|2> is irrelevant.

This command is an event and therefore has no *RST value and no query.

Note: *If no next smaller maximum value is found on the trace (level spacing to adjacent values < peak excursion), an execution error (error code: -200) is produced.*

Example

```
CALC:MARK2:MAX:RIGH
```

Positions marker 2 to the next lower maximum value to the right of the current value.

Characteristics

*RST value: -

SCPI: device-specific

Mode

A, ADEMOD, CATV, CDMA, EVDO, SPECM, WCDMA

CALCulate<1|2>:MARKer<1...4>:MINimum[:PEAK]

This command positions the marker to the current minimum value of the corresponding trace. The corresponding marker is activated first or switched to marker mode, if necessary.

For CDMA2000 and 1xEV-DO code domain measurements (option K82 and K84) the numeric suffix <1|2> selects the measurement screen. In the other modes the numeric suffix <1|2> is irrelevant.

This command is an event and therefore has no *RST value and no query.

Note: *If no minimum value is found on the trace (level spacing to adjacent values < peak excursion), an execution error (error code: -200) is produced.*

Example

```
CALC:MARK2:MIN
```

Positions marker 2 to the minimum value of the trace.

Characteristics

*RST value: -

SCPI: device-specific

Mode

A, ADEMOD, CATV, CDMA, EVDO, SPECM, WCDMA

CALCulate<1|2>:MARKer<1...4>:MINimum:AUTO

Activates the automatic minimum value search function for marker 1 at the end of each particular sweep. This function may be used during adjustments of a device under test to keep track of the actual peak marker position and level.

The numeric suffixes <1|2> are irrelevant for this command.

This command is available from firmware version 1.50.

Note: *If no minimum value is found on the trace (level spacing to adjacent values < peak excursion), an execution error (error code: -200) is produced.*

Parameter

ON | OFF

Example

CALC:MARK:MIN:AUTO ON

Activates the automatic minimum value search function for marker 1 at the end of each particular sweep.

Characteristics

*RST value: OFF

SCPI: device-specific

Mode

A

CALCulate<1|2>:MARKer<1...4>:MINimum:LEFT

This command positions the marker to the next higher minimum value to the left of the current value (i.e. in descending X direction) on the corresponding trace.

For CDMA2000 and 1xEV-DO code domain measurements (option K82 and K84) the numeric suffix <1|2> selects the measurement screen. In the other modes the numeric suffix <1|2> is irrelevant.

This command is an event and therefore has no *RST value and no query.

Note: *If no next higher minimum value is found on the trace (level spacing to adjacent values < peak excursion), an execution error (error code: -200) is produced.*

Example

CALC:MARK2:MIN

Positions marker 2 to the minimum value of the trace.

CALC:MARK2:MIN:LEFT

Positions marker 2 to the next higher minimum value to the left of the current value.

Characteristics

*RST value: -

SCPI: device-specific

Mode

A, ADEMOD, CATV, CDMA, EVDO, SPECM, WCDMA

CALCulate<1|2>:MARKer<1...4>:MINimum:NEXT

This command positions the marker to the next higher minimum value of the corresponding trace.

For CDMA2000 and 1xEV-DO code domain measurements (option K82 and K84) the numeric suffix <1|2> selects the measurement screen. In the other modes the numeric suffix <1|2> is irrelevant.

This command is an event and therefore has no *RST value and no query.

Note: *If no next higher minimum value is found on the trace (level spacing to adjacent values < peak excursion), an execution error (error code: -200) is produced.*

Example

```
CALC:MARK2:MIN
```

Positions marker 2 to the minimum value of the trace.

```
CALC:MARK2:MIN:NEXT
```

Positions marker 2 to the next higher maximum value.

Characteristics

*RST value: -

SCPI: device-specific

Mode

A, ADEMOD, CATV, CDMA, EVDO, SPECM, WCDMA

CALCulate<1|2>:MARKer<1...4>:MINimum:RIGHT

This command positions the marker to the next higher minimum value to the right of the current value (i.e. in ascending X direction) on the corresponding trace.

For CDMA2000 and 1xEV-DO code domain measurements (option K82 and K84) the numeric suffix <1|2> selects the measurement screen. In the other modes the numeric suffix <1|2> is irrelevant.

This command is an event and therefore has no *RST value and no query.

Note: *If no next higher minimum value is found on the trace (level spacing to adjacent values < peak excursion), an execution error (error code: -200) is produced.*

Example

```
CALC:MARK2:MIN
```

Positions marker 2 to the minimum value of the trace.

```
CALC:MARK2:MIN:RIGH
```

Positions marker 2 to the next higher minimum value to the right of the current value.

Characteristics

*RST value: -

SCPI: device-specific

Mode

A, ADEMOD, CATV, CDMA, EVDO, SPECM, WCDMA

CALCulate<1|2>:MARKer<1...4>:PEXCursion

This command defines the peak excursion, i.e. the spacing below a trace maximum which must be attained before a new maximum is recognized, or the spacing above a trace minimum which must be attained before a new minimum is recognized. The set value applies to all markers and delta markers. The unit depends on the selected operating mode.

The numeric suffixes <1|2> and <1...4> are irrelevant.

Parameter

<numeric_value>

Example

```
CALC:MARK:PEXC 10dB
```

Defines peak excursion 10 dB in spectrum **Spectrum Analyzer** mode.

Characteristics

*RST value: 6dB in **Spectrum Analyzer** mode

SCPI: device-specific

Mode

A, ADEMOD, BT, CATV, SPECM

CALCulate<1|2>:MARKer<1...4>:TRACe

This command assigns the selected marker (1 to 4) to the indicated measurement curve. The corresponding trace must be active, i.e. its status must be different from "BLANK".

If necessary the corresponding marker is switched on prior to the assignment.

The numeric suffixes <1|2> are irrelevant for this command.

Parameter

1 to 6

Example

```
CALC:MARK3:TRAC 2
```

Assigns marker 3 to trace 2.

Characteristics

*RST value: -

SCPI: device-specific

Mode

A, ADEMOD, CATV

CALCulate<1|2>:MARKer<1...4>:X

This command positions the selected marker to the indicated frequency (span > 0), time (span = 0) or level (APD measurement or CCDF measurement ON).

If marker 2, 3 or 4 is selected and used as delta marker, it is switched to marker mode.

For CDMA2000 and 1xEV-DO code domain measurements (option K82 and K84) the numeric suffix <1|2> selects the measurement screen. In the other modes the numeric suffix <1|2> is irrelevant.

Parameter

0 to MAX (frequency | sweep time)

Example

CALC:MARK2:X 10.7MHz
Positions marker 2 to frequency 10.7 MHz.

Characteristics

*RST value: -
SCPI: device-specific

Mode

A, ADEMOD, CATV, CDMA, EVDO, SPECM, WCDMA

CALCulate<1|2>:MARKer<1...4>:X:SLIMits[:STATe]

This command switches between a limited (ON) and unlimited (OFF) search range. If the power measurement in zero span is active, this command limits the evaluation range on the trace. The numeric suffixes <1|2> and <1...4> are irrelevant for this command.

Parameter

ON | OFF

Example

CALC:MARK:X:SLIM ON
Switches on search limitation.

Characteristics

*RST value: OFF
SCPI: device-specific

Mode

A, ADEMOD, CATV, SPECM

CALCulate<1|2>:MARKer<1...4>:X:SLIMits:LEFT

This command sets the left limit of the search range for markers and delta markers. Depending on the span setting of the x-axis the indicated value defines a frequency (span > 0) or time (span = 0).

The numeric suffixes <1|2> and <1...4> are irrelevant for this command.

If the power measurement in zero span is active, this command limits the evaluation range to the trace.

Note: The function is only available if the search limit for marker and delta marker is switched on (CALCulate<1|2>:MARKer<1...4>:X:SLIMits[:STATe]).

Parameter

0 to MAX (frequency | sweep time)

Example

CALC:MARK:X:SLIM ON
Switches the search limit function on.
CALC:MARK:X:SLIM:LEFT 10MHz
Sets the left limit of the search range to 10 MHz.

Characteristics

*RST value: - (is set to the left diagram border when switching on search limits)
SCPI: device-specific

Mode

A, ADEMOD, CATV, SPECM

CALCulate<1|2>:MARKer<1...4>:X:SLIMits:RIGHT

This command sets the right limit of the search range for markers and delta markers. Depending on the span setting of the x-axis the indicated value defines a frequency (span > 0) or time (span = 0).

The numeric suffixes <1|2> and <1...4> are irrelevant for this command.

If the power measurement in zero span is active, this command limits the evaluation range to the trace.

Note: The function is only available if the search limit for marker and delta marker is switched on (CALCulate<1|2>:MARKer<1...4>:X:SLIMits[:STATe]).

Parameter

0 to MAX (frequency | sweep time)

Example

```
CALC:MARK:X:SLIM ON
```

Switches the search limit function on.

```
CALC:MARK:X:SLIM:RIGH 20MHz
```

Sets the right limit of the search range to 20 MHz.

Characteristics

*RST value: - (is set to the right diagram border when switching on search limits)

SCPI: device-specific

Mode

A, ADEMOD, CATV, SPECM

CALCulate<1|2>:MARKer<1...4>:X:SSIZe

This command defines the step size of the rotary knob for marker or delta marker value changes. It takes only effect in manual operation. It is available for all base unit measurements with the exception of statistics.

The numeric suffixes <1|2> and <1...4> are irrelevant for this command.

This command is available from firmware version 1.60.

Parameter

STANdard measurement point step size

POINts measured value step size (number of measured values is defined via the
[SENSe<1|2>:]SWEep:POINts command)

Example

```
CALC:MARK:X:SSIZ POIN
```

Sets the measured value step size.

Characteristics

RST value: STANdard

SCPI: device-specific

Mode

A

CALCulate<1|2>:MARKer<1...4>:Y?

This command queries the measured value of the selected marker. The corresponding marker is activated before or switched to marker mode, if necessary.

To obtain a correct query result, a complete sweep with synchronization to the sweep end must be performed between the activation of the marker and the query of the Y value. This is only possible in single sweep mode.

The query result is output in the unit determined with `CALCulate<1|2>:UNIT:POWer`.

In the default setting, the output is made depending on the unit determined with `CALCulate<1|2>:UNIT:POWer`; only with linear level scaling is the output in %.

For CDMA2000 and 1xEV-DO code domain measurements (option K82 and K84) the numeric suffix <1|2> selects the measurement screen. In the other modes the numeric suffix <1|2> is irrelevant.

Example

```
INIT:CONT OFF
```

Switches to single sweep mode.

```
CALC:MARK2 ON
```

Switches marker 2.

```
INIT;*WAI
```

Starts a sweep and waits for the end.

```
CALC:MARK2:Y?
```

Outputs the measured value of marker 2.

Characteristics

*RST value: -

SCPI: device-specific

Mode

A, ADEMOD, BT, CATV, CDMA, EVDO, SPECM, WCDMA

CALCulate<1|2>:MARKer<1...4>:Y:PERCent

This command positions the selected marker to the given probability. If marker 2, 3 or 4 is selected and used as a delta marker, it is switched to marker mode.

The numeric suffixes <1|2> are irrelevant for this command.

Note: *The command is only available with the CCDF measurement switched on. The associated level value can be determined with the `CALCulate<1|2>:MARKer<1...4>:X` command.*

Parameter

0 to 100%

Example

```
CALC1:MARK:Y:PERC 95PCT
```

Positions marker 1 to a probability of 95%.

Characteristics

*RST value: -

SCPI: device-specific

Mode

A, CATV, CDMA, EVDO

CALCulate:MARKer:FUNCTion Subsystem

The CALCulate:MARKer:FUNCTion subsystem checks the marker functions in the instrument.

The following subsystems are included:

- "CALCulate:MARKer:FUNCTion:HARMonics Subsystem" on page 6.81
- "CALCulate:MARKer:FUNCTion:POWer Subsystem" on page 6.85
- "CALCulate:MARKer:FUNCTion:STRack Subsystem" on page 6.91
- "CALCulate:MARKer:FUNCTion:SUMMary Subsystem" on page 6.93

Commands of the CALCulate:MARKer:FUNCTion Subsystem

- CALCulate<1|2>:MARKer<1...4>:FUNCTion:DEModulation[:STATe]
- CALCulate<1|2>:MARKer<1...4>:FUNCTion:DEModulation:CONTInuous
- CALCulate<1|2>:MARKer<1...4>:FUNCTion:DEModulation:HOLDoff
- CALCulate<1|2>:MARKer<1...4>:FUNCTion:DEModulation:SElect
- CALCulate<1|2>:MARKer<1...4>:FUNCTion:CENTer
- CALCulate<1|2>:MARKer<1...4>:FUNCTion:CSTep
- CALCulate<1|2>:MARKer<1...4>:FUNCTion:FPEaks[:IMMediate]
- CALCulate<1|2>:MARKer<1...4>:FUNCTion:FPEaks:COUNt?
- CALCulate<1|2>:MARKer<1...4>:FUNCTion:FPEaks:SORT
- CALCulate<1|2>:MARKer<1...4>:FUNCTion:FPEaks:X?
- CALCulate<1|2>:MARKer<1...4>:FUNCTion:FPEaks:Y?
- CALCulate<1|2>:MARKer<1...4>:FUNCTion:MDEPth[:STATe]
- CALCulate<1|2>:MARKer<1...4>:FUNCTion:MDEPth:RESult?
- CALCulate<1|2>:MARKer<1...4>:FUNCTion:MDEPth:SEARChsignal
- CALCulate<1|2>:MARKer<1...4>:FUNCTion:NDBDown
- CALCulate<1|2>:MARKer<1...4>:FUNCTion:NDBDown:FREQUency?
- CALCulate<1|2>:MARKer<1...4>:FUNCTion:NDBDown:QFACtor?
- CALCulate<1|2>:MARKer<1...4>:FUNCTion:NDBDown:RESult?
- CALCulate<1|2>:MARKer<1...4>:FUNCTion:NDBDown:STATe
- CALCulate<1|2>:MARKer<1...4>:FUNCTion:NDBDown:TIME?
- CALCulate<1|2>:MARKer<1...4>:FUNCTion:NOISe[:STATe]
- CALCulate<1|2>:MARKer<1...4>:FUNCTion:NOISe:RESult?
- CALCulate<1|2>:MARKer<1...4>:FUNCTion:REFerence
- CALCulate<1|2>:MARKer<1...4>:FUNCTion:TOI[:STATe]
- CALCulate<1|2>:MARKer<1...4>:FUNCTion:TOI:RESult?
- CALCulate<1|2>:MARKer<1...4>:FUNCTion:TOI:SEARChsignal
- CALCulate<1|2>:MARKer<1...4>:FUNCTion:ZOOM

CALCulate<1|2>:MARKer<1...4>:FUNCtion:DEModulation[:STATe]

This command switches on or off the audio demodulator when the indicated marker is reached. With span > 0 the hold time can be defined at the corresponding marker position with `CALCulate<1|2>:MARKer<1...4>:FUNCtion:DEModulation:HOLDoff`. In zero span the demodulation is permanently active.

The numeric suffixes <1|2> are irrelevant for this command.

Parameter

ON | OFF

Example

```
CALC:MARK3:FUNC:DEM ON
```

Switches on the demodulation for marker 3.

Characteristics

*RST value: OFF

SCPI: device-specific

Mode

A

CALCulate<1|2>:MARKer<1...4>:FUNCtion:DEModulation:CONTinuous

This command switches on or off the continuous demodulation for span >0. Thus acoustic monitoring of the signals can be performed.

The numeric suffixes <1|2> and <1...4> are irrelevant for this command.

This command is available from firmware version 1.10.

Parameter

ON | OFF

Example

```
CALC2:MARK3:FUNC:DEM:CONT ON
```

Switches on the continuous ' demodulation.

Characteristics

RST value: OFF

SCPI: device-specific

Mode

A

CALCulate<1|2>:MARKer<1...4>:FUNCtion:DEModulation:HOLDoff

This command defines the hold time at the marker position for the demodulation with span > 0. The setting is independent of the selected marker, the suffixes <1|2> and <1...4> are irrelevant.

The numeric suffixes <1|2> are irrelevant for this command.

Parameter

10ms to 1000s

Example:

```
CALC:MARK:FUNC:DEM:HOLD 3s
```

Characteristics:

*RST value: - (DEModulation is set to OFF)

SCPI: device-specific

Mode:

A

CALCulate<1|2>:MARKer<1...4>:FUNCtion:DEModulation:SElect

This command selects the demodulation type for the audio demodulator. The command is independent of the selected marker, the suffixes 1|2 and 1 to 4 are irrelevant.

The numeric suffixes <1|2> are irrelevant for this command.

Parameter

AM | FM

Example

```
CALC:MARK:FUNC:DEM:SEL FM
```

Characteristics

*RST value: AM

SCPI: device-specific

Mode

A

CALCulate<1|2>:MARKer<1...4>:FUNCtion:CENter

This command sets the center frequency equal to the frequency of the indicated marker.

If marker 2, 3 or 4 is selected and used as delta marker, the marker is switched to the marker mode.

The numeric suffix <1|2> are irrelevant for this command.

This command is an "event" and therefore has no *RST value and no query.

Example

```
CALC:MARK2:FUNC:CENT
```

Sets the center frequency to the frequency of marker 2.

Characteristics

*RST value: -

SCPI: device-specific

Mode

A-F, CATV, SPECM

CALCulate<1|2>:MARKer<1...4>:FUNCtion:CSTep

This command sets the step size of the center frequency to the X value of the current marker.

If marker 2, 3 or 4 is selected and used as delta marker, it is switched to the marker mode.

The numeric suffix <1|2> are irrelevant for this command.

This command is an event and therefore has no *RST value and no query.

Example

```
CALC:MARK3:FUNC:CST
```

Sets the center frequency to the same value as the frequency of marker 3.

Characteristics

*RST value: -

SCPI: device-specific

Mode

A-F

CALCulate<1|2>:MARKer<1...4>:FUNCTION:FPEaks[:IMMEDIATE]

This command searches the selected trace for the indicated number of maxima. The results are entered in a list and can be queried with the

`CALCulate<1|2>:MARKer<1...4>:FUNCTION:FPEaks:X?` and

`CALCulate<1|2>:MARKer<1...4>:FUNCTION:FPEaks:Y?` commands. The number of maxima found can be queried with

`CALCulate<1|2>:MARKer<1...4>:FUNCTION:FPEaks:COUNT?`. The trace to be examined

is selected with `CALCulate<1|2>:MARKer<1...4>:TRACe`. The order of the results in the

list can be defined with `CALCulate<1|2>:MARKer<1...4>:FUNCTION:FPEaks:SORT`.

The numeric suffixes <1|2> are irrelevant for this command.

This command is available from firmware version 1.30.

Note: *The number of maxima found depends on the waveform and value set for the Peak Excursion parameter (`CALCulate<1|2>:MARKer<1...4>:PEXCursion`), however, a maximum number of 200 maxima are determined. Only the signals which exceed their surrounding values at least by the value indicated by the peak excursion parameter will be recognized as maxima. Therefore, the number of maxima found is not automatically the same as the number of maxima desired.*

Parameter

1 to 200

Example

```
INIT:CONT OFF
```

Switches to single sweep mode

```
INIT;*WAI
```

Starts measurement and synchronizes to end

```
CALC:MARK:TRAC 1
```

Sets marker 1 to trace 1

```
CALC:MARK:FUNC:FPE:SORT X
```

Sets the sort mode to increasing X values

```
CALC:MARK:FUNC:FPE 3
```

Searches the 3 highest maxima for trace 1

```
CALC:MARK:FUNC:FPE:COUN?
```

Queries the number of maxima found

```
CALC:MARK:FUNC:Y?
```

Queries the level of maxima found

```
CALC:MARK:FUNC:X?
```

Queries the frequencies (span <> 0) or time (span = 0) of maxima found.

Characteristics

*RST value: -

SCPI: device-specific

Mode

A

CALCulate<1|2>:MARKer<1...4>:FUNCtion:FPEaks:COUNT?

This query reads out the number of maxima found during the search. If no search for maxima has been performed, 0 is returned.

The numeric suffixes <1|2> are irrelevant for this command.

This command is available from firmware version 1.30.

Example

```
CALC:MARK:FUNC:FPE 3
```

Searches the 3 highest maxima for trace 1

```
CALC:MARK:FUNC:FPE:COUN?
```

Queries the number of maxima found

Characteristics

*RST value: -

SCPI: device-specific

Mode

A

CALCulate<1|2>:MARKer<1...4>:FUNCtion:FPEaks:SORT

This command sets the sort mode for the search for maxima:

X: the maxima are sorted in the list of responses according to increasing X values

Y: the maxima are sorted in the list of responses according to decreasing Y values

The numeric suffixes <1|2> are irrelevant for this command.

This command is available from firmware version 1.30.

Parameter

X | Y

Example

```
CALC:MARK:FUNC:FPE:SORT Y
```

Sets the sort mode to decreasing y values

Characteristics

*RST value: -

SCPI: device-specific

Mode

A

CALCulate<1|2>:MARKer<1...4>:FUNCtion:FPEaks:X?

This query reads out the list of X values of the maxima found. The number of available values can be queried with `CALCulate<1|2>:MARKer<1...4>:FUNCtion:FPEaks:COUNT?`.

With sort mode X, the X values are in increasing order; with sort mode Y the order corresponds to the decreasing order of the Y values.

The numeric suffixes <1|2> are irrelevant for this command.

This command is available from firmware version 1.30.

Example

CALC:MARK:FUNC:FPE:SORT Y

Sets the sort mode to decreasing y values

CALC:MARK:FUNC:FPE 3

Searches the 3 highest maxima for trace 1

CALC:MARK:FUNC:FPE:COUN?

Queries the number of maxima found

CALC:MARK:FPE:FUNC:X?

Queries the frequencies (span <> 0) or. time (span = 0) of the maxima found

Return values

107.5E6, 153.8E6, 187.9E6

frequencies in increasing order

2.05E-3, 2.37E-3, 3.71e-3

times in increasing order

Characteristics

*RST value: -

SCPI: device-specific

Mode

A

CALCulate<1|2>:MARKer<1...4>:FUNction:FPEaks:Y?

This query reads out the list of X values of the maxima found. The number of available values can be queried with `CALCulate<1|2>:MARKer<1...4>:FUNction:FPEaks:COUNT?`.

With sort mode X, the X values are in increasing order; with sort mode Y the order corresponds to the decreasing order of the Y values.

The numeric suffixes <1|2> are irrelevant for this command.

This command is available from firmware version 1.30.

Example

CALC:MARK:FUNC:FPE:SORT Y

Sets the sort mode to decreasing y values

CALC:MARK:FUNC:FPE 3

Searches the 3 highest maxima for trace 1

CALC:MARK:FUNC:FPE:COUN?

Queries the number of maxima found

CALC:MARK:FUNC:FPE:Y?

Queries the levels of the maxima found

Return values

-37.5, -58.3, -59.6

level in decreasing order

Characteristics

*RST value: -

SCPI: device-specific

Mode

A

CALCulate<1|2>:MARKer<1...4>:FUNCtion:MDEPth[:STATe]

This command switches on the measurement of the AM modulation depth. An AM-modulated carrier is required on the screen for correct operation. If necessary, marker 1 is previously activated and set to the largest signal available.

The level value of marker 1 is regarded as the carrier level. On activating the function, marker 2 and marker 3 are automatically set as delta markers symmetrically to the carrier to the adjacent maxima of the trace.

If the position of delta marker 2 is changed, delta marker 3 is moved symmetrically with respect to the reference marker (marker 1). If the position of delta marker 3 is changed, fine adjustment can be performed independently of delta marker 2.

The power at the marker positions is calculated from the measured levels.

The AM modulation depth is calculated from the ratio of power values at the reference marker and the delta markers. If the two AM sidebands differ in power, the average value of the two power values is used for calculating the AM modulation depth.

The numeric suffix <1|2> and <1...4> are irrelevant for this command.

Example

```
CALC:MARK:X 10MHZ
```

Sets the reference marker (marker 1) to the carrier signal at 10 MHz.

```
CALC:MARK:FUNC:MDEP ON
```

Switches on the modulation depth measurement.

```
CALC:DELT2:X 10KHZ
```

Sets delta markers 2 and 3 to the signals at 10 kHz from the carrier signal.

```
CALC:DELT3:X 9.999KHZ
```

Corrects the position of delta marker 3 relative to delta marker 2.

Characteristics

*RST value: OFF

SCPI: device-specific

Mode

A

CALCulate<1|2>:MARKer<1...4>:FUNCtion:MDEPth:RESult?

This command queries the AM modulation depth.

A complete sweep with synchronization to sweep end must be performed between switching on the function and querying the measured value to obtain a correct query result. This is only possible in single sweep mode.

The numeric suffix <1|2> and <1...4> are irrelevant for this command.

This command is only a query and therefore has no *RST value.

Example

```
INIT:CONT OFF
```

Switches to single sweep mode.

```
CALC:MARK:X 10MHZ
```

Sets the reference marker (marker 1) to the carrier signal at 10 MHz.

```
CALC:MARK:FUNC:MDEP ON
```

Switches on the modulation depth measurement.

```
INIT;*WAI
```

Starts a sweep and waits for the end.

```
CALC:MARK:FUNC:MDEP:RES?
```

Outputs the measured value.

Characteristics

*RST value: -

SCPI: device-specific

Mode

A

CALCulate<1|2>:MARKer<1...4>:FUNCtion:MDEPth:SEARChsignal

This command starts the search of the signals required for the modulation depth measurement.

The numeric suffix <1|2> are irrelevant for this command.

Note: *No new measurement is done. Only the currently available trace selected for the modulation depth measurement is used*

Parameter

ONCE

Example

```
CALC:MARK:FUNC:MDEP:SEAR ONCE
```

Executes the search of an AM modulated signal at the currently available trace.

Characteristics

*RST value: -

SCPI: conform

Mode

A

CALCulate<1|2>:MARKer<1...4>:FUNCtion:NDBDown

This command defines the level spacing of the two temporary markers to the right and left of marker 1.

The temporary markers T1 and T2 are positioned by n dB below the active reference marker.

The value measured by these markers can be queried with

```
CALCulate<1|2>:MARKer<1...4>:FUNCtion:NDBDown:RESult??.
```

The numeric suffixes <1|2> and <1...4> are irrelevant for this command.

Parameter

<numeric_value>

Example

```
CALC:MARK:FUNC:NDBD 3dB
```

Sets the level spacing to 3 dB.

Characteristics

*RST value: 6dB

SCPI: device-specific

Mode

A

CALCulate<1|2>:MARKer<1...4>:FUNCtion:NDBDown:FREQuency?

This command queries the values of the two temporary markers for span>0. The frequency values are separated by comma and output in ascending order.

A complete sweep with synchronization to sweep end must be performed between switching on the function and querying the measured value to obtain a correct query result. This is only possible in single sweep mode.

The numeric suffixes <1|2> and <1...4> are irrelevant for this command.

This command is only a query and therefore has no *RST value.

Example

```
INIT:CONT OFF
```

Switches to single sweep mode.

```
CALC:MARK:FUNC:NDBD ON
```

Switches on the n dB down function.

```
INIT;*WAI
```

Starts a sweep and waits for the end.

```
CALC:MARK:FUNC:NDBD:FREQ?
```

Outputs the frequencies of the temporary markers.

Characteristics

*RST value: -

SCPI: device-specific

Mode

A

CALCulate<1|2>:MARKer<1...4>:FUNCtion:NDBDown:QFACtor?

This command queries the Q factor (quality) of the measured bandwidth for span>0.

This command is only a query and therefore has no *RST value.

This command is available from firmware version 1.80.

Example

```
INIT:CONT OFF
```

Switches to single sweep mode.

```
CALC:MARK:FUNC:NDBD ON
```

Switches on the n dB down function.

```
INIT;*WAI
```

Starts a sweep and waits for the end.

```
CALC:MARK:FUNC:NDBD:QFAC?
```

Queries the Q factor of the measured bandwidth.

Characteristics

RST value: -

SCPI: device-specific

Mode

A

CALCulate<1|2>:MARKer<1...4>:FUNCtion:NDBDown:RESult?

This command queries the measured value. The value depends on the span setting:

- span > 0: frequency spacing of the two temporary markers (in Hz)
- span = 0: pulse width between the two temporary markers (in s)

A complete sweep with synchronization to sweep end must be performed between switching on the function and querying the measured value in order to obtain a correct query result. This is only possible in single sweep mode.

The numeric suffixes <1|2> and <1...4> are irrelevant for this command.

This command is only a query and therefore has no *RST value.

Example

```
INIT:CONT OFF
```

Switches to single sweep mode.

```
CALC:MARK:FUNC:NDBD ON
```

Switches on the n dB down function.

```
INIT;*WAI
```

Starts a sweep and waits for the end.

```
CALC:MARK:FUNC:NDBD:RES?
```

Outputs the measured value.

Characteristics

*RST value: -

SCPI: device-specific

Mode

A

CALCulate<1|2>:MARKer<1...4>:FUNCtion:NDBDown:STATe

This command switches the "N dB Down" function on or off. Marker 1 is activated first, if necessary.

The numeric suffixes <1|2> and <1...4> are irrelevant for this command.

Parameter

ON | OFF

Example

```
CALC:MARK:FUNC:NDBD:STAT ON
```

Switches on the "N dB Down" function.

Characteristics

*RST value: OFF

SCPI: device-specific

Mode

A

CALCulate<1|2>:MARKer<1...4>:FUNCtion:NDBDown:TIME?

This command queries the values of the two temporary markers in zero span. The time values are separated by comma and output in ascending order.

A complete sweep with synchronization to sweep end must be performed between switching on the function and querying the measured value to obtain a correct query result. This is only possible in single sweep mode.

The numeric suffixes <1|2> and <1...4> are irrelevant for this command.

This command is only a query and therefore has no *RST value.

Example

```
INIT:CONT OFF
```

Switches to single sweep mode

```
CALC:MARK:FUNC:NDBD ON
```

Switches on the n dB down function.

```
INIT;*WAI
```

Starts a sweep and waits for the end.

```
CALC:MARK:FUNC:NDBD:TIME?
```

Outputs the time values of the temporary markers.

Characteristics

*RST value: -

SCPI: device-specific

Mode

A-T

CALCulate<1|2>:MARKer<1...4>:FUNCtion:NOISe[:STATe]

This command switches the noise measurement on or off for all markers. The noise power density is measured at the position of the markers. The result can be queried with [CALCulate<1|2>:MARKer<1...4>:FUNCtion:NOISe:RESult?](#).

The numeric suffixes <1|2> are irrelevant for this command.

Parameter

ON | OFF

Example

```
CALC:MARK:FUNC:NOIS ON
```

Switches on the noise measurement.

Characteristics

*RST value: OFF

SCPI: device-specific

Mode

A

CALCulate<1|2>:MARKer<1...4>:FUNCtion:NOISe:RESult?

This command queries the result of the noise measurement.

A complete sweep with synchronization to the sweep end must be performed between switching on the function and querying the measured value in order to obtain a correct query result. This is only possible in single sweep mode.

The numeric suffixes <1|2> are irrelevant for this command.

This command is an event and therefore has no *RST value and no query.

Example

```
INIT:CONT OFF
```

Switches to single sweep mode.

```
CALC:MARK2 ON
```

Switches on marker 2.

```
CALC:MARK2:FUNC:NOIS ON
```

Switches on noise measurement for marker 2.

```
INIT;*WAI
```

Starts a sweep and waits for the end.

```
CALC:MARK2:NOIS:RES?
```

Outputs the noise result of marker 2.

Characteristics

*RST value: -

SCPI: device-specific

Mode

A

CALCulate<1|2>:MARKer<1...4>:FUNctioN:REFerence

This command sets the reference level to the power measured by the indicated marker. If marker 2, 3 or 4 is selected and used as delta marker, it is switched to marker mode.

The numeric suffix <1|2> are irrelevant for this command.

This command is an event and therefore has no *RST value and no query.

Example

```
CALC:MARK2:FUNC:REF
```

Sets the reference level to the level of marker 2.

Characteristics

*RST value: -

SCPI: device-specific

Mode

A, CATV, SPECM

CALCulate<1|2>:MARKer<1...4>:FUNctioN:TOI[:STATe]

This command initiates the measurement of the third-order intercept point.

A two-tone signal with equal carrier levels is expected at the RF input of the instrument. Marker 1 and marker 2 (both normal markers) are set to the maximum of the two signals. Delta marker 3 and delta marker 4 are positioned to the intermodulation products. The delta markers can be modified separately afterwards with the `CALCulate<1|2>:DELTaMarker<1...4>:X` command.

The third-order intercept is calculated from the level spacing between the normal markers and the delta markers.

The numeric suffix <1|2> and <1...4> are irrelevant for this command.

Parameter

ON | OFF

Example

```
CALC:MARK:FUNC:TOI ON
```

Switches on the measurement of the third-order intercept.

Characteristics

*RST value: OFF

SCPI: device-specific

Mode

A

CALCulate<1|2>:MARKer<1...4>:FUNCTION:TOI:RESult?

This command queries the third-order intercept point measurement.

A complete sweep with synchronization to sweep end must be performed between switching on the function and querying the measured value to obtain a correct query result. This is only possible in single sweep mode.

The numeric suffix <1|2> and <1...4> are irrelevant for this command.

This command is only a query and therefore has no *RST value.

Example

```
INIT:CONT OFF
```

Switches to single sweep mode.

```
CALC:MARK:FUNC:TOI ON
```

Switches the intercept measurement.

```
INIT;*WAI
```

Starts a sweep and waits for the end.

```
CALC:MARK:FUNC:TOI:RES?
```

Outputs the measured value.

Characteristics

*RST value: -

SCPI: device-specific

Mode

A

CALCulate<1|2>:MARKer<1...4>:FUNCTION:TOI:SEARChsignal

This command starts the search of the signals required for the third order intercept measurement.

The numeric suffix <1|2> are irrelevant for this command.

Note: *No new measurement is done. Only the currently available trace selected for the TOI measurement is used*

Parameter

ONCE

Example

```
CALC:MARK:FUNC:TOI:SEAR ONCE
```

Executes the search for 2 signals and their intermodulation product at the currently available trace.

Characteristics

*RST value: -
SCPI: conform

Mode

A

CALCulate<1|2>:MARKer<1...4>:FUNCtion:ZOOM

This command defines the range to be zoomed around marker 1. Marker 1 is activated first, if necessary.

The subsequent frequency sweep is stopped at the marker position and the frequency of the signal is counted. This frequency becomes the new center frequency, and the zoomed span is set. In order to recognize the end of the operation the synchronization to the sweep end should be activated. This is only possible in single sweep mode.

The numeric suffixes <1|2> are irrelevant for this command.

This command is an event and therefore has no *RST value and no query.

Parameter

<numeric_value>

Example

```
INIT:CONT OFF
```

Switches to single sweep mode

```
CALC:MARK:FUNC:ZOOM 1kHz;*WAI
```

Activates zooming and waits for its end.

```
CALC:MARK1:FUNC:ZOOM 10
```

Zooms in around marker 1 by a factor of 10.

Characteristics

*RST value: -
SCPI: device-specific

Mode

A-F

CALCulate:MARKer:FUNCTion:HARMonics Subsystem

The CALCulate:MARKer:FUNCTion:POWER subsystem contains the commands to define the settings for harmonics measurement.

This subsystem is available from firmware version 1.10.

Commands of the CALCulate:MARKer:FUNCTion:HARMonics Subsystem

- CALCulate<1|2>:MARKer<1...4>:FUNCTion:HARMonics[:STATe]
- CALCulate<1|2>:MARKer<1...4>:FUNCTion:HARMonics:BANDwidth:AUTO
- CALCulate<1|2>:MARKer<1...4>:FUNCTion:HARMonics:DISToRtion?
- CALCulate<1|2>:MARKer<1...4>:FUNCTion:HARMonics:LIST?
- CALCulate<1|2>:MARKer<1...4>:FUNCTion:HARMonics:NHARmonics
- CALCulate<1|2>:MARKer<1...4>:FUNCTion:HARMonics:PRESet

CALCulate<1|2>:MARKer<1...4>:FUNCTion:HARMonics[:STATe]

This command activates/deactivates the harmonic distortion measurement.

If the measurement is started in span > 0, the last span defines the search range for the first harmonic. The level is determined for the first harmonic.

If the measurement is started in zero span, center frequency and level are used unchanged.

The numeric suffix <1|2> and <1...4> are irrelevant for this command.

This command is available from firmware version 1.10.

Parameter

ON | OFF

Example

```
CALC:MARK:FUNC:HARM ON
```

Activates the harmonic distortion measurement.

Characteristics

RST value: OFF

SCPI: device-specific

Mode

A-F, A-T

CALCulate<1|2>:MARKer<1...4>:FUNCTion:HARMonics:BANDwidth:AUTO

This command defines the resolution bandwidth of the harmonic in respect to the bandwidth of the first harmonic. For details refer to chapter "Instrument Functions", section "Harmonic RBW Auto".

The numeric suffix <1|2> are irrelevant for this command.

This command is available from firmware version 1.10.

Parameter

OFF identical

ON a multiple

Example

CALC:MARK:FUNC:HARM:BAND:AUTO OFF
Deactivates the automatic bandwidth enlargement.

Characteristics

RST value: ON
SCPI: device-specific

Mode

A-F, A-T

CALCulate<1|2>:MARKer<1...4>:FUNCTION:HARMonics:DISTortion?

This command queries the distortion results (THD: total harmonic distortion). Two values separated by a comma are returned: <THD in %>, <THD in dB>.
To obtain a correct result, a complete sweep with synchronization to the end of the sweep must be performed before a query is output. Synchronization is possible only in the single sweep mode.
The numeric suffix <1|2> and <1...4> are irrelevant for this command.
This command is available from firmware version 1.10.

Parameter

TOTAL

Example

INIT:CONT OFF
Switches to single sweep mode.
CALC:MARK:FUNC:HARM:NHARM 3
Sets the number of harmonics to be measured to 3.
CALC:MARK:FUNC:HARM ON
Activates the harmonic distortion measurement.
INIT;*WAI
Starts a sweep and waits for the end of the sweep.
CALC:MARK:FUNC:HARM:DIST? TOT
Returns the total distortion in % and dB.

Characteristics

RST value: -
SCPI: device-specific

Mode

A-F, A-T

CALCulate<1|2>:MARKer<1...4>:FUNCTION:HARMonics:LIST?

This command reads out the list of the harmonics. The first value is the absolute power of the first harmonic (the unit is set via the CALCulate<1|2>:UNIT:POWER command). The following values are relative to the carrier signal and have the unit dB. They are separated by commas and correspond to the harmonics to be measured (set via the [CALCulate<1|2>:MARKer<1...4>:FUNCTION:HARMonics:NHARmonics](#) command).
To obtain a correct result, a complete sweep with synchronization to the end of the sweep must be performed before a query is output. Synchronization is possible only in the single sweep mode.
The numeric suffixes <1|2> are not relevant.

This command is available from firmware version 1.10.

Example

```
INIT:CONT OFF
```

Switches to single sweep mode.

```
CALC:MARK:FUNC:HARM:NHARM 3
```

Sets the number of harmonics to be measured to 3.

```
CALC:MARK:FUNC:HARM ON
```

Activates the harmonic distortion measurement.

```
INIT;*WAI
```

Starts a sweep and waits for the end of the sweep.

```
CALC:MARK:FUNC:HARM:LIST?
```

Returns the values for the 3 measured harmonics.

Characteristics

RST value: -

SCPI: device-specific

Mode

A-F, A-T

CALCulate<1|2>:MARKer<1...4>:FUNCTION:HARMonics:NHARmonics

This command sets the number of harmonics to be measured.

The numeric suffix <1|2> and <1...4> are irrelevant for this command.

This command is available from firmware version 1.10.

Parameter

1...26

Example

```
CALC:MARK:FUNC:HARM:NHARM 3
```

Sets the number of harmonics to be measured to 3.

Characteristics

RST value: 10

SCPI: device-specific

Mode

A-F, A-T

CALCulate<1|2>:MARKer<1...4>:FUNCTION:HARMonics:PRESet

This command optimizes the device settings depending on the span setting:

span > 0	Frequency and level of the first harmonic are determined and used for the measurement list.
zero span	The level of the first harmonic is determined. The frequency remains unchanged.

The numeric suffixes <1|2> and <1...4> are irrelevant.

This command is an event and therefore has no *RST value.

This command is available from firmware version 1.10.

Example

CALC:MARK:FUNC:HARM:PRES

Optimizes the device settings for the harmonic measurement.

Characteristics

RST value: -

SCPI: device-specific

Mode

A-F, A-T

CALCulate:MARKer:FUNCTION:POWER Subsystem

The CALCulate:MARKer:FUNCTION:POWER subsystem contains the commands for control of power measurement.

Commands of the CALCulate:MARKer:FUNCTION:POWER Subsystem

- [CALCulate<1|2>:MARKer:FUNCTION:POWer\[:STATe\]](#)
- [CALCulate<1|2>:MARKer:FUNCTION:POWer:MODE](#)
- [CALCulate<1|2>:MARKer:FUNCTION:POWer:PRESet](#)
- [CALCulate<1|2>:MARKer:FUNCTION:POWer:RESult?](#)
- [CALCulate<1|2>:MARKer:FUNCTION:POWer:RESult:PHZ](#)
- [CALCulate<1|2>:MARKer:FUNCTION:POWer:SElect](#)

Further information

- ["Predefined CP / ACP standards"](#) on page 6.85

Predefined CP / ACP standards

Parameter	Standard
AWLan	WLAN 802.11A
BWLan	WLAN 802.11B
CDPD	CDPD
D2CDma	CDMA 2000 direct sequence
FIS95A, F8CDma	CDMA IS95A forward
FIS95C0	CDMA IS95C Class 0 forward
FIS95C1	CDMA IS95C Class 1 forward
FJ008, F19CDma	CDMA J-STD008 forward
FTCDMa / TCDMa	TD-SCDMA forward
FW3Gppcdma	W-CDMA 3.84 MHz forward
M2CDma	CDMA 2000 MC3 multi carrier with 3 carriers
NADC	NADC IS136
PDC	PDC
PHS	PHS
RFID14443	RFID 14443
RIS95A, R8CDma	CDMA IS95A reverse
RIS95C0	CDMA IS95C Class 0 reverse
RIS95C1	CDMA IS95C Class 1 reverse
RJ008, R19CDma	CDMA J-STD008 reverse
RTCDMA	TD-SCDMA reverse
RW3Gppcdma	W-CDMA 3.84 MHz reverse
S2CDma	CDMA 2000 MC1 multi carrier with 1 carrier
TETRA	TETRA
WIBRo	WIBRO
WIMax	WIMAX

CALCulate<1|2>:MARKer:FUNCTION:POWER[:STATe]

This command switches off the power measurement.
 The numeric suffixes <1|2> are not relevant.
 This command is an event and therefore has no *RST value.

Parameter

OFF

Example

```
CALC:MARK:FUNC:POW OFF
```

Switches off the power measurement.

Characteristics

*RST value: -
 SCPI: device-specific

Mode

A-F

CALCulate<1|2>:MARKer:FUNCTION:POWER:MODE

This commands defines the method by which the channel power values are calculated from the current trace.
 The numeric suffixes <1|2> are not relevant.
 This command is available from firmware version 1.30.

Parameter

WRITE	The channel power and the adjacent channel powers are calculated directly from the current trace
MAXHold	The power values are calculated from the current trace and compared with the previous power value using a maximum algorithm.

Example

```
CALC:MARK:FUNC:POW:MODE MAXH
```

Sets the Maxhold channel power mode.

Characteristics

*RST value: -
 SCPI: device-specific

Mode

A-F

CALCulate<1|2>:MARKer:FUNCTION:POWER:PRESet

This command selects the power measurement setting for a standard and previously switches on the corresponding measurement, if required.
 The configuration for a standard comprises of the parameters weighting filter, channel bandwidth and spacing, resolution and video bandwidth, as well as detector and sweep time.
 The numeric suffixes <1|2> are not relevant.

Note: *The settings for standards IS95A and C differ as far as the calculation method of channel spacings is concerned. For IS95A and J-STD008 the spacing is calculated from the center of the main channel to the center of the corresponding adjacent channel, for*

IS95C from the center of the main channel to the nearest border of the adjacent channel.

Parameter

NADC | TETRA | PDC | PHS | CDPD | FWCDma | RWCDma | F8CDma | R8CDma | F19Cdma | R19Cdma | FW3Gppcdma | RW3Gppcdma | S2CDma | FIS95A | RIS95A | FIS95C0 | RIS95C0 | FIS95C1 | RIS95C1 | FJ008 | RJ008 | TCDMa | FTCDMa | RTCDMa | AWLan | BWLan | WIMax | WIBRo | RFID14443 | NONE

For further details refer to "[Predefined CP / ACP standards](#)" on page 6.85.

The parameters WIMax and WIBRo are available from firmware version 1.30.

Example

```
CALC:MARK:FUNC:POW:PRES NADC
Selects the standard setting for NADC
```

Characteristics

*RST value: -

SCPI: device-specific

Mode

A-F

CALCulate<1|2>:MARKer:FUNCTION:POWER:RESult?

This command queries the result of the performed power measurement. If necessary, the measurement is switched on prior to the query.

The channel spacings and channel bandwidths are configured in the "[SENSe:POWER Subsystem](#)" on page 6.214.

To obtain a correct result, a complete sweep with synchronization to the end of the sweep must be performed before a query is output. Synchronization is possible only in the single sweep mode.

The numeric suffixes <1|2> are not relevant.

This command is a query and therefore has no *RST value.

Parameter

ACPower Adjacent-channel power measurement

Results are output in the following sequence, separated by commas:

Power of transmission channel
 Power of lower adjacent channel
 Power of upper adjacent channel
 Power of lower alternate channel 1
 Power of upper alternate channel 1
 Power of lower alternate channel 2
 Power of upper alternate channel 2

The number of measured values returned depends on the number of adjacent/alternate channels selected with [\[SENSe<1|2>:\]POWER:ACHannel:ACPairs](#).

With logarithmic scaling (RANGE LOG), the power is output in the currently selected level unit; with linear scaling (RANGE LIN dB or LIN %), the power is output in W. If [\[SENSe<1|2>:\]POWER:ACHannel:MODE](#) is set to REL, the adjacent/alternate-channel power is output in dB.

CN Measurement of carrier-to-noise ratio

The carrier-to-noise ratio in dB is returned.

CN0	Measurement of carrier-to-noise ratio referenced to 1 Hz bandwidth. The carrier-to-noise ratio in dB/Hz is returned.
CPOWer	Channel power measurement In a Spectrum Emission Mask measurement, the query returns the power result for the reference range, if this power reference type is selected. With logarithmic scaling (RANGE LOG), the channel power is output in the currently selected level unit; with linear scaling (RANGE LIN dB or LIN %), the channel power is output in W.
MCACpower	Channel/adjacent-channel power measurement with several carrier signals Results are output in the following sequence, separated by commas: Power of carrier signal 1 to 12 in ascending order Total power of all carrier signals Power of lower adjacent channel Power of upper adjacent channel Power of lower alternate channel 1 Power of upper alternate channel 1 Power of lower alternate channel 2 Power of upper alternate channel 2 The number of measured values returned depends on the number of carrier signals and adjacent/alternate channels selected with <code>[SENSe<1 2>:]POWer:ACHannel:TXChannel:COUNT</code> and <code>[SENSe<1 2>:]POWer:ACHannel:ACPairs</code> . If only one carrier signal is measured, the total value of all carrier signals will not be output. With logarithmic scaling (RANGE LOG), the power is output in dBm; with linear scaling (RANGE LIN dB or LIN %), the power is output in W. If <code>[SENSe<1 2>:]POWer:ACHannel:MODE</code> is set to REL, the adjacent/alternate-channel power is output in dB.
OBANdwidth OBWidth	Measurement of occupied bandwidth The occupied bandwidth in Hz is returned.
PPOWer	Power of the highest peak In a Spectrum Emission Mask measurement, the query returns the power result for the reference range, if this power reference type is selected.

Example of channel/adjacent-channel power measurement

`POW:ACH:ACP 3`

Sets the number of adjacent/alternate channels to 3.

`POW:ACH:BAND 30KHZ`

Sets the bandwidth of the transmission channel to 30 kHz.

`POW:ACH:BAND:ACH 40KHZ`

Sets the bandwidth of each adjacent channel to 40 kHz.

`POW:ACH:BAND:ALT1 50KHZ`

Sets the bandwidth of each alternate channel to 50 kHz.

`POW:ACH:BAND:ALT2 60KHZ`

Sets the bandwidth of alternate channel 2 to 60 kHz.

`POW:ACH:SPAC 30KHZ`

Sets the spacing between the transmission channel and the adjacent channel to 30 kHz, the spacing between the transmission channel and alternate channel 1 to 60 kHz, and the spacing between the transmission channel and alternate channel 2 to 90 kHz.

POW:ACH:SPAC:ALT1 100KHZ

Sets the spacing between the alternate adjacent channels and the TX channel. For details refer to the [\[SENSe<1|2>:\]POWer:ACHannel:SPACing:ALTerNate<1...11>](#) command.

POW:ACH:SPAC:ALT2 140KHZ

Sets the spacing between the transmission channel and alternate channel 2 to 140 kHz.

POW:ACH:MODE ABS

Switches on absolute power measurement.

CALC:MARK:FUNC:POW:SEL ACP

Switches on the adjacent-channel power measurement.

INIT:CONT OFF

Switches over to single sweep mode.

INIT;*WAI

Starts a sweep and waits for the end of the sweep.

CALC:MARK:FUNC:POW:RES? ACP

Queries the result of adjacent-channel power measurement.

POW:ACH:REF:AUTO ONCE

Defines the measured channel power as the reference value for relative power measurements.

Note: *If the channel power only is to be measured, all commands relating to adjacent/alternate channel bandwidth and channel spacings are omitted. The number of adjacent/alternate channels is set to 0 with [\[SENSe<1|2>:\]POWer:ACHannel:ACPairs](#).*

Example of occupied bandwidth measurement

POW:BAND 90PCT

Defines 90% as the percentage of the power to be contained in the bandwidth range to be measured.

INIT:CONT OFF

Switches over to single sweep mode.

INIT;*WAI

Starts a sweep and waits for the end of the sweep.

CALC:MARK:FUNC:POW:RES? OBW

Queries the occupied bandwidth measured.

Characteristics

*RST value: -

SCPI: device-specific

Mode

A-F, CDMA, EVDO, WCDMA

CALCulate<1|2>:MARKer:FUNCtion:POWer:RESult:PHZ

This command switches the query response of the power measurement results between output of absolute values and output referred to the measurement bandwidth.

The measurement results are output with the

[CALCulate<1|2>:MARKer:FUNCtion:POWer:RESult?](#) command.

The numeric suffixes <1|2> are not relevant.

This command is available from firmware version 1.50.

Parameter

ON Results output: channel power density in dBm/Hz

OFF Results output: channel power is displayed in dBm

Example

```
CALC:MARK:FUNC:POW:RES:PHZ ON
```

Output of results referred to the channel bandwidth.

For details on a complete measurement example refer to [Example of channel/adjacent-channel power measurement](#).

Characteristics

*RST value: OFF

SCPI: device-specific

Mode

A-F

CALCulate<1|2>:MARKer:FUNCtion:POWER:SElect

This command selects - and switches on - specified power measurement type.

The channel spacings and channel bandwidths are configured in the "[SENSe:POWER Subsystem](#)" on page 6.214.

The numeric suffixes <1|2> are not relevant.

Note: *If CPower is selected, the number of adjacent channels ([SENSe<1|2>:]POWer:ACHannel:ACPairs) is set to 0. If ACPower is selected, the number of adjacent channels is set to 1, unless adjacent-channel power measurement is switched on already.*

The channel/adjacent-channel power measurement is performed for the trace selected with [SENSe<1|2>:]POWer:TRACe.

The occupied bandwidth measurement is performed for the trace on which marker 1 is positioned. To select another trace for the measurement, marker 1 is to be positioned on the desired trace by means of [CALCulate<1|2>:MARKer<1...4>:TRACe](#).

Parameter

ACPower	Adjacent-channel power measurement with a single carrier signal
CPower	Channel power measurement with a single carrier signal (equivalent to adjacent-channel power measurement with <i>NO. OF ADJ CHAN = 0</i>)
MCACpower	Channel/adjacent-channel power measurement with several carrier signals
OBANdwidth OBWidth	Measurement of occupied bandwidth
CN	Measurement of carrier-to-noise ratio
CN0	Measurement of carrier-to-noise ratio referenced to 1 Hz bandwidth

Example

```
CALC:MARK:FUNC:POW:SEL ACP
```

Switches on adjacent-channel power measurement.

Characteristics

*RST value: -

SCPI: device-specific

Mode

A-F

CALCulate:MARKer:FUNCtion:STRack Subsystem

The CALCulate:MARKer:FUNCtion:STRack subsystem defines the settings of the signal track.

Commands of the CALCulate:MARKer:FUNCtion:STRack Subsystem

- CALCulate<1|2>:MARKer:FUNCtion:STRack[:STATe]
- CALCulate<1|2>:MARKer:FUNCtion:STRack:BANDwidth|BWIDth
- CALCulate<1|2>:MARKer:FUNCtion:STRack:THReshold
- CALCulate<1|2>:MARKer:FUNCtion:STRack:TRACe

CALCulate<1|2>:MARKer:FUNCtion:STRack[:STATe]

This command switches the signal-track function on or off.

With signal track activated, the maximum signal is determined after each frequency sweep and the center frequency is set to the frequency of this signal. Thus with drifting signals the center frequency follows the signal.

The numeric suffixes <1|2> are not relevant.

Parameter

ON | OFF

Example

```
CALC:MARK:FUNC:STR ON
```

Switches on the signal track function.

Characteristics

*RST value: OFF

SCPI: device-specific

Mode

A-F

CALCulate<1|2>:MARKer:FUNCtion:STRack:BANDwidth|BWIDth

These commands have the same function. They define the bandwidth around the center frequency within which the largest signal is searched.

The numeric suffixes <1|2> are not relevant.

Note: *The entry of the search bandwidth is only possible if the Signal Track function is switched on (CALCulate<1|2>:MARKer:FUNCtion:STRack[:STATe]).*

Parameter

10Hz to MAX (span)

Example

```
CALC:MARK:FUNC:STR:BAND 1MHZ
```

Sets the search bandwidth to 1 MHz.

```
CALC:MARK:FUNC:STR:BWID 1MHZ
```

Alternative command for the same function.

Characteristics

*RST value: - (= span/10 on activating the function)

SCPI: device-specific

Mode

A-F

CALCulate<1|2>:MARKer:FUNCtion:STRack:THReshold

This command defines the threshold above which the largest signal is searched for.

The response unit depends on the settings defined with `CALCulate<1|2>:UNIT:POWer`.

The numeric suffixes <1|2> are not relevant.

Note: *The entry of the search bandwidth is only possible if the Signal Track function is switched on (`CALCulate<1|2>:MARKer:FUNCtion:STRack[:STATE]`).*

Parameter

-330dBm to +30dBm

Example

```
CALC:MARK:FUNC:STR:THR -50DBM
```

Sets the threshold for signal tracking to -50 dBm.

Characteristics

*RST value: -120 dBm

SCPI: device-specific

Mode

A-F

CALCulate<1|2>:MARKer:FUNCtion:STRack:TRACe

This command defines the trace on which the largest signal is searched for.

The numeric suffixes <1|2> are not relevant.

Parameter

1 to 6

Example

```
CALC:MARK:FUNC:STR:TRAC 3
```

Defines trace 3 as the trace for signal tracking.

Characteristics

*RST value: 1

SCPI: device-specific

Mode

A-F

CALCulate:MARKer:FUNCTION:SUMMARY Subsystem

This subsystem contains the commands for controlling the power functions in zero span.

Commands of the CALCulate:MARKer:FUNCTION:SUMMARY Subsystem

- CALCulate<1|2>:MARKer:FUNCTION:MSUMmary?
- CALCulate<1|2>:MARKer:FUNCTION:SUMMARY[:STATe]
- CALCulate<1|2>:MARKer:FUNCTION:SUMMARY:AOFF
- CALCulate<1|2>:MARKer:FUNCTION:SUMMARY:AVERage
- CALCulate<1|2>:MARKer:FUNCTION:SUMMARY:MEAN[:STATe]
- CALCulate<1|2>:MARKer:FUNCTION:SUMMARY:MEAN:AVERage:RESult?
- CALCulate<1|2>:MARKer:FUNCTION:SUMMARY:MEAN:PHOLd:RESult?
- CALCulate<1|2>:MARKer:FUNCTION:SUMMARY:MEAN:RESult?
- CALCulate<1|2>:MARKer:FUNCTION:SUMMARY:MODE
- CALCulate<1|2>:MARKer:FUNCTION:SUMMARY:PHOLd
- CALCulate<1|2>:MARKer:FUNCTION:SUMMARY:PPEak[:STATe]
- CALCulate<1|2>:MARKer:FUNCTION:SUMMARY:PPEak:AVERage:RESult?
- CALCulate<1|2>:MARKer:FUNCTION:SUMMARY:PPEak:PHOLd:RESult?
- CALCulate<1|2>:MARKer:FUNCTION:SUMMARY:PPEak:RESult?
- CALCulate<1|2>:MARKer:FUNCTION:SUMMARY:REFerence:AUTO
- CALCulate<1|2>:MARKer:FUNCTION:SUMMARY:RMS[:STATe]
- CALCulate<1|2>:MARKer:FUNCTION:SUMMARY:RMS:AVERage:RESult?
- CALCulate<1|2>:MARKer:FUNCTION:SUMMARY:RMS:PHOLd:RESult?
- CALCulate<1|2>:MARKer:FUNCTION:SUMMARY:RMS:RESult?
- CALCulate<1|2>:MARKer:FUNCTION:SUMMARY:SDEViation[:STATe]
- CALCulate<1|2>:MARKer:FUNCTION:SUMMARY:SDEViation:AVERage:RESult?
- CALCulate<1|2>:MARKer:FUNCTION:SUMMARY:SDEViation:PHOLd:RESult?
- CALCulate<1|2>:MARKer:FUNCTION:SUMMARY:SDEViation:RESult?

CALCulate<1|2>:MARKer:FUNCTION:MSUMmary?

The commands of this subsystem are used to determine the power of a sequence of signal pulses having the same interval, as are typical for the slots of a GSM signal, for example. The number of pulses to be measured as well as the measurement time and the period can be set. To define the position of the first pulse in the trace, a suitable offset can be entered.

The evaluation is performed on the measurement data of a previously recorded trace. The data recorded during the set measurement time is combined to a measured value for each pulse according to the detector specified and the indicated number of results is output as a list.

Trace 1 is always used by the function.

The numeric suffixes <1|2> are not relevant.

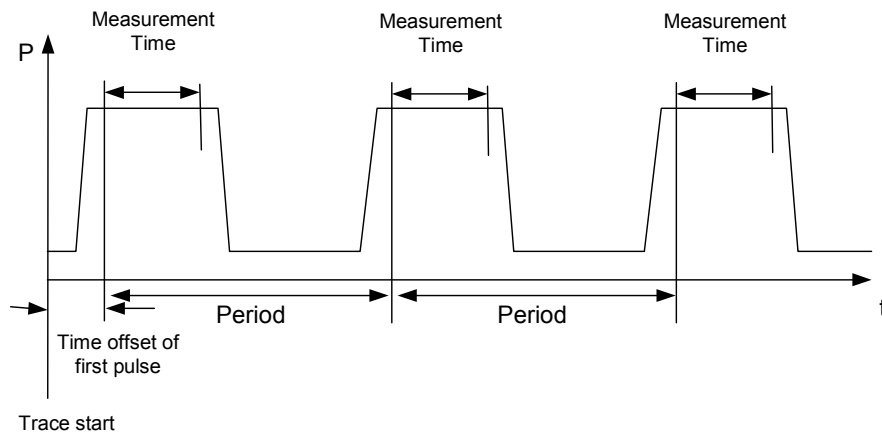
**Parameter**

<time offset of first pulse>, <measurement time>, <period>, < # of pulses to measure>

Example

```
DISP:WIND:TRAC:Y:RLEV -10dBm
```

Sets the reference level to 10 dB

```
INP:ATT 30 dB
```

Sets the input attenuation to 30 dB

```
FREQ:CENT 935.2MHz;SPAN 0Hz
```

Sets the receive frequency to 935.2 MHz and the span to 0 Hz

```
BAND:RES 1MHz;VID 3MHz
```

Sets the resolution bandwidth to 1 MHz and the video bandwidth to 3 MHz

```
DET RMS
```

Sets the RMS detector

```
TRIG:SOUR VID;LEV:VID 50 PCT
```

Selects the trigger source VIDEO and sets the level of the video trigger source to 50 PCT

```
SWE:TIME 50ms
```

Sets the sweep time to 50 ms

```
INIT;*WAI
```

Starts the measurement with synchronization

```
CALC:MARK:FUNC:MSUM? 50US,450US,576.9US,8
```

Queries 8 bursts with an offset of 50 μ s, a test time of 450 μ s and a period of 576.9 μ s

Characteristics

*RST value: -

SCPI: device-specific

Mode

A-T

CALCulate<1|2>:MARKer:FUNCtion:SUMMary[:STATe]

This command switches on or off the previously selected power measurements in zero span. Thus one or several measurements can be first selected and then switched on and off together with CALCulate<1|2>:MARKer:FUNCtion:SUMMary[:STATe].

The numeric suffixes <1|2> are not relevant.

Parameter

ON | OFF

Example

CALC:MARK:FUNC:SUMM:STAT ON

Characteristics

*RST value: OFF

SCPI: device-specific

Mode

A-T

CALCulate<1|2>:MARKer:FUNCtion:SUMMary:AOFF

This command switches off all measurements in zero span.

The numeric suffixes <1|2> are not relevant.

This command is an event and therefore has no *RST value and no query.

Example

CALC:MARK:FUNC:SUMM:AOFF

Switches off the functions for power measurement in zero span.

Characteristics

*RST value: -

SCPI: device-specific

Mode

A-T

CALCulate<1|2>:MARKer:FUNCtion:SUMMary:AVERage

This command switches on or off averaging for the active power measurement in zero span.

Averaging is reset by switching it off and on again.

The number of results required for the calculation of average is defined with

[\[SENSe<1|2>:\]AVERage:COUNT](#).

Synchronization to the end of averaging is only possible in single sweep mode.

The numeric suffixes <1|2> are not relevant.

Parameter

ON | OFF

Example

INIT:CONT OFF

Switches to single sweep mode.

CALC:MARK:FUNC:SUMM:AVER ON

Switches on the calculation of average.

AVER:COUN 200

Sets the measurement counter to 200.

INIT;*WAI

Starts a sweep and waits for the end.

Characteristics

*RST value: OFF

SCPI: device-specific

Mode

A-T

CALCulate<1|2>:MARKer:FUNCtion:SUMMery:MEAN[:STATe]

This command switches on or off the measurement of the mean value.

The numeric suffixes <1|2> are not relevant.

Note: *The measurement is performed on the trace on which marker 1 is positioned. In order to evaluate another trace, marker 1 must be positioned on another trace with*

CALCulate<1|2>:MARKer<1...4>:TRACe.

Parameter

ON | OFF

Example

```
CALC:MARK:FUNC:SUMM:MEAN ON
```

Switches on the function.

Characteristics

*RST value: OFF

SCPI: device-specific

Mode

A-T

CALCulate<1|2>:MARKer:FUNCtion:SUMMery:MEAN:AVERAge:RESult?

This command queries the result of the measurement of the averaged mean value. The query is only possible if averaging has been activated previously using

[CALCulate<1|2>:MARKer:FUNCtion:SUMMery:AVERAge.](#)

A complete sweep with synchronization to sweep end must be performed between switching on the function and querying the measured value to obtain a correct query result. This is only possible in single sweep mode.

The numeric suffixes <1|2> are not relevant.

This command is only a query and therefore has no *RST value.

Example

```
INIT:CONT OFF
```

Switches to single sweep mode.

```
CALC:MARK:FUNC:SUMM:MEAN ON
```

Switches on the function.

```
CALC:MARK:FUNC:SUMM:AVER ON
```

Switches on the average value calculation.

```
INIT;*WAI
```

Starts a sweep and waits for the end.

```
CALC:MARK:FUNC:SUMM:MEAN:AVER:RES?
```

Outputs the result.

Characteristics

*RST value: -

SCPI: device-specific

Mode

A-T

CALCulate<1|2>:MARKer:FUNCtion:SUMMery:MEAN:PHOLd:RESult?

This command queries the result of the measurement of the mean value with active peak hold. The query is only possible if the peak hold function has been switched on previously using `CALCulate<1|2>:MARKer:FUNCtion:SUMMery:PHOLd`.

The query is possible only if the peak hold function is active.

A complete sweep with synchronization to sweep end must be performed between switching on the function and querying the measured value to obtain a correct query result. This is only possible in single sweep mode.

The numeric suffixes <1|2> are not relevant.

This command is only a query and therefore has no *RST value.

Example

```
INIT:CONT OFF
```

Switches to single sweep mode.

```
CALC:MARK:FUNC:SUMM:MEAN ON
```

Switches on the function.

```
CALC:MARK:FUNC:SUMM:PHOL ON
```

Switches on the peak value measurement.

```
INIT;*WAI
```

Starts a sweep and waits for the end.

```
CALC:MARK:FUNC:SUMM:MEAN:PHOL:RES?
```

Outputs the result.

Characteristics

*RST value: -

SCPI: device-specific

Mode

A-T

CALCulate<1|2>:MARKer:FUNCtion:SUMMery:MEAN:RESult?

This command queries the result of the measurement of the mean value.

A complete sweep with synchronization to sweep end must be performed between switching on the function and querying the measured value to obtain a correct query result. This is only possible in single sweep mode.

The numeric suffixes <1|2> are not relevant.

This command is only a query and therefore has no *RST value.

Example

```
INIT:CONT OFF
```

Switches to single sweep mode.

```
CALC:MARK:FUNC:SUMM:MEAN ON
```

Switches on the function.

```
INIT;*WAI
```

Starts a sweep and waits for the end.

```
CALC:MARK:FUNC:SUMM:MEAN:RES?
```

Outputs the result.

Characteristics

*RST value: -

SCPI: device-specific

Mode

A-T

CALCulate<1|2>:MARKer:FUNCtion:SUMMary:MODE

This command selects absolute or relative power measurement in zero span.

The reference power for relative measurement is defined with

`CALCulate<1|2>:MARKer:FUNCtion:SUMMary:REFeRence:AUTO`. If the reference power is not defined, the value 0 dBm is used.

The numeric suffixes <1|2> and <1...4> are irrelevant for this command.

Parameter

ABSolute | RELative

Example

```
CALC:MARK:FUNC:SUMM:MODE REL
```

Switches the power measurement in zero span to relative.

Characteristics

RST value: ABSolute

SCPI: device-specific

Mode

A-T

CALCulate<1|2>:MARKer:FUNCtion:SUMMary:PHOLd

This command switches on or off the peak-hold function for the active power measurement in zero span.

The peak-hold function is reset by switching it off and on again.

The numeric suffixes <1|2> are not relevant.

Parameter

ON | OFF

Example

```
CALC:MARK:FUNC:SUMM:PHOL ON
```

Switches on the function.

Characteristics

*RST value: OFF

SCPI: device-specific

Mode

A-T

CALCulate<1|2>:MARKer:FUNCtion:SUMMary:PPEak[:STATe]

This command switches on or off the measurement of the positive peak value.

The numeric suffixes <1|2> are not relevant.

Parameter

ON | OFF

Example

CALC:MARK:FUNC:SUMM:PPE ON
Switches on the function.

Characteristics

*RST value: OFF
SCPI: device-specific

Mode

A-T

CALCulate<1|2>:MARKer:FUNction:SUMMary:PPEak:AVERage:RESult?

This command is used to query the result of the measurement of the averaged positive peak value. The query is only possible if averaging has been activated previously using [CALCulate<1|2>:MARKer:FUNction:SUMMary:AVERage](#).

A complete sweep with synchronization to sweep end must be performed between switching on the function and querying the measured value to obtain a correct query result. This is only possible in single sweep mode.

The numeric suffixes <1|2> are not relevant.

This command is only a query and therefore has no *RST value.

Example

INIT:CONT OFF
Switches to single sweep mode.
CALC:MARK:FUNC:SUMM:PPE ON
Switches on the function.
CALC:MARK:FUNC:SUMM:AVER ON
Switches on the calculation of average.
INIT;*WAI
Starts a sweep and waits for the end.
CALC:MARK:FUNC:SUMM:PPE:AVER:RES?
Outputs the result.

Characteristics

*RST value: -
SCPI: device-specific

Mode

A-T

CALCulate<1|2>:MARKer:FUNction:SUMMary:PPEak:PHOLd:RESult?

This command is used to query the result of the measurement of the positive peak value with active peak hold function. The query is only possible if the peak hold function has been activated previously using [CALCulate<1|2>:MARKer:FUNction:SUMMary:PHOLd](#).

A complete sweep with synchronization to sweep end must be performed between switching on the function and querying the measured value to obtain a correct query result. This is only possible in single sweep mode.

The numeric suffixes <1|2> are not relevant.

This command is only a query and therefore has no *RST value.

Example

```
INIT:CONT OFF
```

Switches to single sweep mode.

```
CALC:MARK:FUNC:SUMM:PPE ON
```

Switches on the function.

```
CALC:MARK:FUNC:SUMM:PHOL ON
```

Switches on the measurement of the peak value.

```
INIT;*WAI
```

Starts a sweep and waits for the end.

```
CALC:MARK:FUNC:SUMM:PPE:PHOL:RES?
```

Outputs the result.

Characteristics

*RST value: -

SCPI: device-specific

Mode

A-T

CALCulate<1|2>:MARKer:FUNCTION:SUMMary:PPEak:RESult?

This command is used to query the result of the measurement of the positive peak value. The measurement may have to be switched on previously.

A complete sweep with synchronization to sweep end must be performed between switching on the function and querying the measured value to obtain a correct query result. This is only possible in single sweep mode.

The numeric suffixes <1|2> are not relevant.

This command is only a query and therefore has no *RST value.

Example

```
INIT:CONT OFF
```

Switches to single sweep mode.

```
CALC:MARK:FUNC:SUMM:PPE ON
```

Switches on the function.

```
INIT;*WAI
```

Starts a sweep and waits for the end.

```
CALC:MARK:FUNC:SUMM:PPE:RES?
```

Outputs the result.

Characteristics

*RST value: -

SCPI: device-specific

Mode

A-T

CALCulate<1|2>:MARKer:FUNCTION:SUMMary:REFerence:AUTO

This command sets the currently measured average value

([CALCulate<1|2>:MARKer:FUNCTION:SUMMary:MEAN\[:STATe\]](#)) and RMS value

([CALCulate<1|2>:MARKer:FUNCTION:SUMMary:RMS\[:STATe\]](#)) as reference values for relative measurements in zero span.

If the measurement of RMS value and average is not activated, the reference value 0 dBm is used.

If the function `CALCulate<1|2>:MARKer:FUNction:SUMMary:AVERage` or `CALCulate<1|2>:MARKer:FUNction:SUMMary:PHOLd` is switched on, the current value is the accumulated measurement value at the time considered.

The numeric suffixes <1|2> and <1...4> are irrelevant for this command.

This command is an event and therefore has no *RST value and no query.

Parameter

ONCE

Example

```
CALC:MARK:FUNC:SUMM:REF:AUTO ONCE
```

Takes the currently measured power as reference value for the relative power measurement in zero span.

Characteristics

RST value: -

SCPI: device-specific

Mode

A-T

CALCulate<1|2>:MARKer:FUNction:SUMMary:RMS[:STATe]

This command switches on or off the measurement of the effective (RMS) power. If necessary the function is switched on previously.

The numeric suffixes <1|2> are not relevant.

Parameter

ON | OFF

Example

```
CALC:MARK:FUNC:SUM:RMS ON
```

Switches on the function.

Characteristics

*RST value: OFF

SCPI: device-specific

Mode

A-T

CALCulate<1|2>:MARKer:FUNction:SUMMary:RMS:AVERage:RESult?

This command queries the result of the measurement of the averaged RMS value. The query is only possible if averaging has been activated previously using `CALCulate<1|2>:MARKer:FUNction:SUMMary:AVERage`.

A complete sweep with synchronization to sweep end must be performed between switching on the function and querying the measured value to obtain a correct query result. This is only possible in single sweep mode.

The numeric suffixes <1|2> are not relevant.

This command is only a query and therefore has no *RST value.

Example

```
INIT:CONT OFF
```

Switches to single sweep mode.

```
CALC:MARK:FUNC:SUMM:RMS ON
```

Switches on the function.

```
CALC:MARK:FUNC:SUMM:AVER ON
```

Switches on the average value calculation.

```
INIT;*WAI
```

Starts a sweep and waits for the end.

```
CALC:MARK:FUNC:SUMM:RMS:AVER:RES?
```

Outputs the result.

Characteristics

*RST- value: -

SCPI: device-specific

Mode

A-T

CALCulate<1|2>:MARKer:FUNCtion:SUMMary:RMS:PHOLd:RESult?

This command queries the result of the measurement of the RMS value with active peak hold. The query is only possible only if the peak hold function has been activated previously using [CALCulate<1|2>:MARKer:FUNCtion:SUMMary:PHOLd](#).

A complete sweep with synchronization to sweep end must be performed between switching on the function and querying the measured value to obtain a correct query result. This is only possible in single sweep mode.

The numeric suffixes <1|2> are not relevant.

This command is only a query and therefore has no *RST value.

Example

```
INIT:CONT OFF
```

Switches to single sweep mode.

```
CALC:MARK:FUNC:SUMM:RMS ON
```

Switches on the function.

```
CALC:MARK:FUNC:SUMM:PHOL ON
```

Switches on the peak value measurement.

```
INIT;*WAI
```

Starts a sweep and waits for the end.

```
CALC:MARK:FUNC:SUMM:RMS:PHOL:RES?
```

Outputs the result.

Characteristics

*RST- value: -

SCPI: device-specific

Mode

A-T

CALCulate<1|2>:MARKer:FUNCtion:SUMMary:RMS:RESult?

This command queries the result of the measurement of the RMS power value.

A complete sweep with synchronization to sweep end must be performed between switching on the function and querying the measured value to obtain a correct query result. This is only possible in single sweep mode.

The numeric suffixes <1|2> are not relevant.

This command is only a query and therefore has no *RST value.

Example

```
INIT:CONT OFF
```

Switches to single sweep mode.

```
CALC:MARK:FUNC:SUMM:RMS ON
```

Switches on the function.

```
INIT;*WAI
```

Starts a sweep and waits for the end.

```
CALC:MARK:FUNC:SUMM:RMS:RES?
```

Outputs the result.

Characteristics

*RST value: -

SCPI: device-specific

Mode

A-T

CALCulate<1|2>:MARKer:FUNCtion:SUMMary:SDEViation[:STATe]

This command switches on or off the measurement of the standard deviation.

On switching on the measurement, the mean power measurement is switched on as well.

The numeric suffixes <1|2> are not relevant.

Parameter

ON | OFF

Example

```
CALC:MARK:FUNC:SUMM:SDEV ON
```

Switches on the measurement of the standard deviation.

Characteristics

*RST value: OFF

SCPI: device-specific

Mode

A

CALCulate<1|2>:MARKer:FUNCtion:SUMMary:SDEViation:AVERage:RESult?

This command queries the result of the averaged standard deviation determined in several sweeps. The query is possible only if averaging is active.

A complete sweep with synchronization to sweep end must be performed between switching on the function and querying the measured value to obtain a correct query result. This is only possible in single sweep mode.

The numeric suffixes <1|2> are not relevant.

This command is only a query and therefore has no *RST value.

Example

```
INIT:CONT OFF
```

Switches to single sweep mode.

```
CALC:MARK:FUNC:SUMM:SDEV ON
```

Switches on the function.

```
CALC:MARK:FUNC:SUMM:AVER ON
```

Switches on the calculation of average.

```
INIT;*WAI
```

Starts a sweep and waits for the end.

```
CALC:MARK:FUNC:SUMM:MEAN:SDEV:RES?
```

Outputs the result.

Characteristics

*RST value: -

SCPI: device-specific

Mode

A-T

CALCulate<1|2>:MARKer:FUNCTION:SUMMery:SDEViation:PHOLd:RESult?

This command queries the maximum standard deviation value determined in several sweeps. The query is possible only if the peak hold function is active.

A complete sweep with synchronization to sweep end must be performed between switching on the function and querying the measured value to obtain a correct query result. This is only possible in single sweep mode.

The numeric suffixes <1|2> are not relevant.

This command is only a query and therefore has no *RST value.

Example

```
INIT:CONT OFF
```

Switches to single sweep mode.

```
CALC:MARK:FUNC:SUMM:SDEV ON
```

Switches on the function.

```
CALC:MARK:FUNC:SUMM:PHOL ON
```

Switches on the peak value measurement.

```
INIT;*WAI
```

Starts a sweep and waits for the end.

```
CALC:MARK:FUNC:SUMM:SDEV:PHOL:RES?
```

Outputs the result.

Characteristics

*RST value: -

SCPI: device-specific

Mode

A-T

CALCulate<1|2>:MARKer:FUNCtion:SUMMery:SDEViation:RESult?

This command queries the results of the standard deviation measurement.

A complete sweep with synchronization to sweep end must be performed between switching on the function and querying the measured value to obtain a correct query result. This is only possible in single sweep mode.

The numeric suffixes <1|2> are not relevant.

This command is only a query and therefore has no *RST value.

Example

```
INIT:CONT OFF
```

Switches to single sweep mode.

```
CALC:MARK:FUNC:SUMM:SDEV ON
```

Switches on the function.

```
INIT;*WAI
```

Starts a sweep and waits for the end.

```
CALC:MARK:FUNC:SUMM:SDEV:RES?
```

Outputs the result.

Characteristics

*RST value: -

SCPI: device-specific

Mode

A-T

CALCulate:MATH Subsystem

The CALCulate:MATH subsystem allows to process data from the SENSE-subsystem in numeric expressions.

Commands of the CALCulate:MATH Subsystem

- CALCulate<1|2>:MATH[:EXpression][:DEFine]
- CALCulate<1|2>:MATH:MODE
- CALCulate<1|2>:MATH:POSition
- CALCulate<1|2>:MATH:STATe

CALCulate<1|2>:MATH[:EXpression][:DEFine]

This command defines the mathematical expression for relating traces to trace1.
This command is available from firmware version 1.30.

Parameter

- (TRACE1-TRACE2) Subtracts trace 2 from trace 1.
- (TRACE1-TRACE3) Subtracts trace 3 from trace 1.
- (TRACE1-TRACE4) Subtracts trace 4 from trace 1.
- (TRACE1-TRACE5) Subtracts trace 5 from trace 1.
- (TRACE1-TRACE6) Subtracts trace 6 from trace 1.

Example

```
CALC1:MATH (TRACE1 - TRACE2)
```

Selects the subtraction of trace 2 from trace 1.

Characteristics

*RST value: -
SCPI: conform

Mode

A

CALCulate<1|2>:MATH:MODE

This command selects the averaging method for the average trace mode.

The numeric suffixes <1|2> are irrelevant.
This command is available from firmware version 1.90.

Parameter

LIN | LOG | POWer

Example

```
CALC:MATH:MODE LIN
```

Selects linear averaging for average trace mode.

Characteristics

*RST value: LOG
SCPI: device-specific

ModeA

CALCulate<1|2>:MATH:POSition

This command defines the position of the result of the trace mathematics. The indication is in % of the screen height, with 100% corresponding to the upper diagram border.

This command is available from firmware version 1.30.

Parameter

-100PCT to 200PCT

Example

```
CALC:MATH:POS 50PCT
```

Sets the position to the horizontal diagram center.

Characteristics

*RST value: 50PCT

SCPI: device-specific

ModeA

CALCulate<1|2>:MATH:STATe

This command switches the mathematical relation of traces on or off.

This command is available from firmware version 1.30.

Parameter

ON | OFF

Example

```
CALC:MATH:STAT ON
```

Switches on the trace mathematics.

Characteristics

*RST value: OFF

SCPI: conform

ModeA

CALCulate:PSEarch|PEAKsearch Subsystem

The CALCulate:PSEarch|PEAKsearch subsystem contains the remote commands for Spurious Emissions measurements. Both groups of commands (PSEarch and PEAKsearch) perform the same functions.

Commands of the CALCulate:PSEarch|PEAKsearch Subsystem

- [CALCulate<1|2>:PSEarch|PEAKsearch\[:IMMEDIATE\]](#)
- [CALCulate<1|2>:PSEarch|PEAKsearch:AUTO](#)
- [CALCulate<1|2>:PSEarch|PEAKsearch:MARGIN](#)
- [CALCulate<1|2>:PSEarch|PEAKsearch:PSHOW](#)
- [CALCulate<1|2>:PSEarch|PEAKsearch:SUBRANGES](#)

CALCulate<1|2>:PSEarch|PEAKsearch[:IMMEDIATE]

This command determines the list of the subrange maximums from the existing sweep results. The numeric suffixes <1|2> are not relevant. This command is an event and therefore has no *RST value and no query. This command is available from firmware version 1.80.

Example

```
CALC:PSE
Starts to determine the list.
```

Characteristics

RST value: -
SCPI: device-specific

Mode

A

CALCulate<1|2>:PSEarch|PEAKsearch:AUTO

For details refer to "[CALCulate<1|2>:ESpectrum:PSEarch|PEAKsearch:AUTO](#)" on page 6.24. This command is available from firmware version 1.80.

CALCulate<1|2>:PSEarch|PEAKsearch:MARGIN

For details refer to "[CALCulate<1|2>:ESpectrum:PSEarch|PEAKsearch:MARGIN](#)" on page 6.25. This command is available from firmware version 1.80.

CALCulate<1|2>:PSEarch|PEAKsearch:PSHOW

For details refer to "[CALCulate<1|2>:ESpectrum:PSEarch|PEAKsearch:PSHOW](#)" on page 6.24. This command is available from firmware version 1.80.

CALCulate<1|2>:PSEarch|PEAKsearch:SUBRanges

This command sets the number of peaks per range that are stored in the list. Once the selected number of peaks has been reached, the peak search is stopped in the current range and continued in the next range.

The numeric suffixes <1|2> are not relevant.

This command is available from firmware version 1.80.

Parameter

1 to 50

Example

```
CALC:PSE:SUBR 10
```

Sets 10 peaks per range to be stored in the list.

Characteristics

RST value: 25

SCPI: device-specific

Mode

A

CALCulate:STATistics Subsystem

The CALCulate:STATistics subsystem controls the statistical measurement functions in the instrument.

Commands of the CALCulate:STATistics Subsystem

- CALCulate:STATistics:APD[:STATe]
- CALCulate:STATistics:CCDF[:STATe]
- CALCulate:STATistics:NSAMples
- CALCulate:STATistics:PRESet
- CALCulate:STATistics:RESult<1...6>?
- CALCulate:STATistics:SCALE:AUTO
- CALCulate:STATistics:SCALE:X:RANGe
- CALCulate:STATistics:SCALE:X:RLEVel
- CALCulate:STATistics:SCALE:Y:LOWer
- CALCulate:STATistics:SCALE:Y:UNIT
- CALCulate:STATistics:SCALE:Y:UPPer

CALCulate:STATistics:APD[:STATe]

This command switches on or off the measurement of amplitude distribution (APD). On activating this function, the CCDF measurement is switched off.

Parameter

ON | OFF

Example

```
CALC:STAT:APD ON  
Switches on the APD measurement.
```

Characteristics

*RST value: OFF
SCPI: device-specific

Mode

A

CALCulate:STATistics:CCDF[:STATe]

This command switches on or off the measurement of the complementary cumulative distribution function (CCDF). On activating this function, the APD measurement is switched off.

Parameter

ON | OFF

Example

```
CALC:STAT:CCDF ON  
Switches on the CCDF measurement.
```

Characteristics

*RST value: OFF
SCPI: device-specific

Mode

A, CDMA, EVDO

CALCulate:STATistics:NSAMples

This command sets the number of measurement points to be acquired for the statistical measurement functions.

Parameter

100 to 1E9

Example

```
CALC:STAT:NSAM 500
```

Sets the number of measurement points to be acquired to 500.

Characteristics

*RST value: 100000

SCPI: device-specific

Mode

A, CATV, CDMA, EVDO

CALCulate:STATistics:PRESet

This command resets the scaling of the X and Y axes in a statistical measurement. The following values are set:

x-axis ref level: -20 dBm

x-axis range APD: 100 dB

x-axis range CCDF: 20 dB

y-axis upper limit: 1.0

y-axis lower limit: 1E-6

This command is an event and therefore has no *RST value and no query.

Example

```
CALC:STAT:PRES
```

Resets the scaling for statistical functions

Characteristics

*RST value: -

SCPI: device-specific

Mode

A, CATV, CDMA, EVDO

CALCulate:STATistics:RESult<1...6>?

This command reads out the results of statistical measurements of a recorded trace. The trace is selected with the numeric suffix <1...6> attached to RESult.

Parameter

The required result is selected via the following parameters:

MEAN	Average (=RMS) power in dBm measured during the measurement time.
PEAK	Peak power in dBm measured during the measurement time.
CFACtor	Determined CREST factor (= ratio of peak power to average power) in dB.
ALL	Results of all three measurements mentioned before, separated by commas: <mean power>,<peak power>,<crest factor>

Example

```
CALC:STAT:RES2? ALL
```

Reads out the three measurement results of trace 2. Example of answer string:

5.56,19.25,13.69 i.e. mean power: 5.56 dBm, peak power 19.25 dBm, CREST factor 13.69 dB

Characteristics

*RST value: -

SCPI: device-specific

Mode

A, CATV, CDMA, EVDO

CALCulate:STATistics:SCALE:AUTO

This command optimizes the level setting of the instrument depending on the measured peak power, in order to obtain maximum instrument sensitivity.

To obtain maximum resolution, the level range is set as a function of the measured spacing between peak power and the minimum power for the APD measurement and of the spacing between peak power and mean power for the CCDF measurement. In addition, the probability scale for the number of test points is adapted.

This command is an event and therefore has no *RST value and no query.

Note: *Subsequent commands have to be synchronized with *WAI, *OPC or *OPC? to the end of the auto range process which would otherwise be aborted.*

Parameter

ONCE

Example

```
CALC:STAT:SCALE:AUTO ONCE;*WAI
```

Adapts the level setting for statistical measurements.

Characteristics

*RST value: -

SCPI: device-specific

Mode

A, CATV, CDMA, EVDO

CALCulate:STATistics:SCALE:X:RANGE

This command defines the level range for the x-axis of the measurement diagram. The setting is identical to the level range setting defined with the [DISPlay:WINDow<1|2>:TRACe<1...6>:Y\[:SCALE\]](#) command.

Parameter

10dB to 200dB

Example

```
CALC:STAT:SCAL:X:RANG 20dB
```

Characteristics

*RST value: 100dB

SCPI: device-specific

Mode

A, CATV, CDMA, EVDO

CALCulate:STATistics:SCALe:X:RLEVel

This command defines the reference level for the x-axis of the measurement diagram. The setting is identical to the reference level setting using the

`DISPlay[:WINDow<1|2>]:TRACe<1...6>:Y[:SCALe]:RLEVel` command.

With the reference level offset $\neq 0$ the indicated value range of the reference level is modified by the offset.

The unit depends on the setting performed with `CALCulate<1|2>:UNIT:POWer`.

Parameter

-120dBm to 20dBm

Example

```
CALC:STAT:SCAL:X:RLEV -60dBm
```

Characteristics

*RST value: -20dBm

SCPI: device-specific

Mode

A, CATV, CDMA, EVDO

CALCulate:STATistics:SCALe:Y:LOWer

This command defines the lower limit for the y-axis of the diagram in statistical measurements. Since probabilities are specified on the y-axis, the entered numeric values are dimensionless.

Parameter

1E-9 to 0.1

Example

```
CALC:STAT:SCAL:Y:LOW 0.001
```

Characteristics

*RST value: 1E-6

SCPI: device-specific

Mode

A, CATV, CDMA, EVDO

CALCulate:STATistics:SCALe:Y:UNIT

This command defines the scaling type of the y-axis.
This command is available from firmware version 1.80.

Parameter

PCT | ABS

Example

```
CALC:STAT:SCAL:Y:UNIT PCT
```

Sets the percentage scale.

Characteristics

RST value: ABS

SCPI: device-specific

Mode

A, EVDO

CALCulate:STATistics:SCALe:Y:UPPer

This command defines the upper limit for the y-axis of the diagram in statistical measurements.
Since probabilities are specified on the y-axis, the entered numeric values are dimensionless.

Parameter

1E-8 to 1.0

Example

```
CALC:STAT:Y:UPP 0.01
```

Characteristics

*RST value: 1.0

SCPI: device-specific

Mode

A, CATV, CDMA, EVDO

CALCulate:THReshold Subsystem

The CALCulate:THReshold subsystem controls the threshold value for the maximum/minimum search of markers.

Commands of the CALCulate:THReshold Subsystem

- CALCulate<1|2>:THReshold
- CALCulate<1|2>:THReshold:STATe

CALCulate<1|2>:THReshold

This command defines the threshold value for the maximum/minimum search of markers with marker search functions. The associated display line is automatically switched on.

The numeric suffixes <1|2> are not relevant.

Parameter

MINimum to MAXimum (depending on current unit)

Example

```
CALC:THR -82DBM
```

Sets the threshold value to -82 dBm.

Characteristics

*RST value: - (STATe to OFF)

SCPI: device-specific

Mode

A, ADEMOD, SPECM

CALCulate<1|2>:THReshold:STATe

This command switches on or off the threshold line. The unit depends on the setting performed with CALCulate<1|2>:UNIT:POWer.

The numeric suffixes <1|2> are not relevant.

Parameter

ON | OFF

Example

```
CALC:THR:STAT ON
```

Switches on the threshold line.

Characteristics

*RST value: OFF

SCPI: device-specific

Mode

A, ADEMOD, SPECM

CALCulate:TLINe Subsystem

The CALCulate:TLINe subsystem defines the position of the time lines.

Commands of the CALCulate:TLINe Subsystem

- [CALCulate<1|2>:TLINe<1|2>](#)
- [CALCulate<1|2>:TLINe<1|2>:STATe](#)

CALCulate<1|2>:TLINe<1|2>

This command defines the position of the time lines that mark the times.
The numeric suffixes <1|2> are not relevant.

Parameter

0 to 1000s

Example

```
CALC:TLIN 10ms
```

Characteristics

*RST value: - (STATe to OFF)

SCPI: device-specific

Mode

A-T

CALCulate<1|2>:TLINe<1|2>:STATe

This command switches the time line on or off.
The numeric suffixes <1|2> are not relevant.

Parameter

ON | OFF

Example

```
CALC:TLIN2:STAT ON
```

Characteristics

*RST value: OFF

SCPI: device-specific

Mode

A-T

CALCulate:UNIT Subsystem

The CALCulate:UNIT subsystem defines the units for the parameters that can be set and the measurement results.

Commands of the CALCulate:UNIT Subsystem

- [CALCulate<1|2>:UNIT:POWer](#)

CALCulate<1|2>:UNIT:POWer

This command selects the unit for power.
The numeric suffixes <1|2> are not relevant.

Parameter

DBM | V | A | W | DBPW | WATT | DBPT | DBUV | DBMV | VOLT | DBUA | AMPere

Example

```
CALC:UNIT:POW DBM
```

Sets the power unit to dBm.

Characteristics

*RST value: dBm
SCPI: device-specific

Mode

A

CALibration Subsystem

The commands of the CALibration subsystem determine the data for system error correction in the instrument.

Commands of the CALibration Subsystem

- CALibration[:ALL]?
- CALibration:ABORt
- CALibration:RESult?
- CALibration:STATe

CALibration[:ALL]?

This command initiates the acquisition of system error correction data. A "0" is returned if the acquisition was successful.

Note: *During the acquisition of correction data the instrument does not accept any remote control commands.*

In order to recognize when the acquisition of correction data is completed, the MAV bit in the status byte can be used. If the associated bit is set in the Service Request Enable Register, the instrument generates a service request after the acquisition of correction data has been completed.

Example

*CLS

Resets the status management.

*SRE 16

Enables MAV bit in the Service Request Enable Register.

*CAL?

Starts the correction data recording, and then a service request is generated.

Characteristics

*RST value: -

SCPI: conform

Mode

all

CALibration:ABORt

This command has no effect, but is implemented to provide compatibility with the FSP family. The collection of self alignment data can only be aborted via manual operation. For details refer to chapter 4 "Instrument Functions - Basic Settings", section "Instrument Setup and Interface Configuration - SETUP Key" - "Alignment".

This command is an event and therefore has no *RST value and no query.

Example

CAL:ABOR

Characteristics

*RST value: -

SCPI: device-specific

Modeall

CALibration:RESult?

This command outputs the results of the correction data acquisition. The lines of the result table are output as string data separated by commas:

```
Total Calibration Status: PASSED, Date (dd/mm/yyyy): 12/07/2004,  
Time: 16:24:54, Runtime: 00.06
```

Example

CAL:RES?

Characteristics

*RST value: -

SCPI: device-specific

Modeall

CALibration:STATe

This command determines whether the current calibration data are taken into account by the instrument (ON) or not (OFF).

Parameter

ON | OFF

Example

CAL:STAT OFF

Sets up the instrument to ignore the calibration data.

Characteristics

*RST value: -

SCPI: conform

Modeall

DIAGnostic Subsystem

The DIAGnostic subsystem contains the commands which support instrument diagnostics for maintenance, service and repair. In accordance with the SCPI standard, all of these commands are device-specific.

Commands of the DIAGnostic Subsystem

- DIAGnostic<1|2>:SERVice:BIOSinfo?
- DIAGnostic<1|2>:SERVice:HWInfo?
- DIAGnostic<1|2>:SERVice:INPut[:SElect]
- DIAGnostic<1|2>:SERVice:INPut:PULSed[:STATe]
- DIAGnostic<1|2>:SERVice:INPut:PULSed:PRATe
- DIAGnostic<1|2>:SERVice:NSOource (option Additional Interfaces, B5)
- DIAGnostic<1|2>:SERVice:SFUNction
- DIAGnostic<1|2>:SERVice:STESt:RESult?

DIAGnostic<1|2>:SERVice:BIOSinfo?

This command reads the CPU board BIOS version and returns it as ASCII string.
The numeric suffixes <1|2> are irrelevant for this command.

Example

```
DIAG:SERV:BIOS?
Returns the BIOS version.
```

Return values (example)

```
47.11
```

Characteristics

*RST value: -
SCPI: device-specific

Mode

```
all
```

DIAGnostic<1|2>:SERVice:HWInfo?

This command queries the hardware information.
The numeric suffixes <1|2> are irrelevant for this command.

Return values

```
"<component 1>|<serial #>|<order #>|<model>|<hardware code>|<revision>|<subrevision>",
"<component 2>|<serial #>|<order #>|<model>|<hardware code>|<revision>|<subrevision>",
...
```

Table lines are output as string data and are separated by commas. The individual columns of the table are separated from each other by |.

Example

```
DIAG:SERV:HWIN?
Queries the hardware information.
```

```
"FRONTEND|100001/003|1300.3009|03|01|00|00",
"MOTHERBOARD|123456/002|1300.3080|02|00|00|00",
...
```

Characteristics

*RST value: -

SCPI: device-specific

Mode

all

DIAGnostic<1|2>:SERVice:INPut[:SElect]

This command toggles between the RF input on the front panel and the internal 65.83 MHz reference signal.

Parameter

CALibration | RF | TG

Example

DIAG:SERV:INP CAL

Characteristics

*RST value: RF

SCPI: device-specific

Mode

all

DIAGnostic<1|2>:SERVice:INPut:PULSed[:STATe]

This command has no effect (only the comb generator is available), but is implemented to provide compatibility with the FSP family.

Parameter

ON | OFF

Example

DIAG:SERV:INP:PULS ON

Characteristics

*RST value: ON

SCPI: conform

Mode

all

DIAGnostic<1|2>:SERVice:INPut:PULSed:PRATe

This command sets the comb generator frequency. This command only takes effect, if the internal reference signal is selected for calibration ([DIAGnostic<1|2>:SERVice:INPut\[:SElect\]](#)).

Parameter

COMB1 65.8333 MHz / 1

COMB64 65.8333 MHz / 64

COMB65 65.8333 MHz / 65

Example

```
DIAG:SERV:INP:PULS:PRAT COMB64
```

Sets the comb generator frequency to $\frac{1}{64}$ of 65.8333 MHz.

Characteristics

*RST value: COMB1

SCPI: conform

Mode

all

DIAGnostic<1|2>:SERVice:NSOource (option Additional Interfaces, B5)

This command switches the 28 V supply of the noise source at the rear panel on or off.

The numeric suffixes <1|2> are irrelevant for this command.

Parameter

ON | OFF

Example

```
DIAG:SERV:NSO ON
```

Characteristics

*RST value: OFF

SCPI: device-specific

Mode

all

DIAGnostic<1|2>:SERVice:SFUNction

This command activates a service function which can be selected by indicating the five parameters: function group number, board number, function number, parameter 1 and parameter 2 (see service manual). The contents of the parameter string are identical to the code to be entered in the edit dialog box of manual operation.

The entry of a service function is accepted only if the system password level 1 or level 2 has been entered previously (`SYSTEM:PASSWORD[:CENable]`).

The numeric suffixes <1|2> are irrelevant for this command.

Parameter

<string>

Example

```
DIAG:SERV:SFUN 2.0.2.12.1
```

Characteristics

*RST value: -

SCPI: device-specific

Mode

all

DIAGnostic<1|2>:SERVice:STESt:RESult?

This command reads the results of the self test out of the instrument. The lines of the result table are output as string data separated by commas:

```
"Total Selftest Status: PASSED", "Date (dd/mm/yyyy): 09/07/2004  
TIME: 16:24:54", "Runtime: 00:06", "...
```

The numeric suffixes <1|2> are irrelevant for this command.

Example

```
DIAG:SERV:STES:RES?
```

Characteristics

*RST value: -

SCPI: device-specific

Mode

all

DISPlay Subsystem

The DISPlay subsystem controls the selection and presentation of textual and graphic information as well as of measurement data on the display.

Commands of the DISPlay Subsystem

- DISPlay:ANNOtation:FREQuency
- DISPlay:CMAP<1...26>:DEFault<1|2>
- DISPlay:CMAP<1...26>:HSL
- DISPlay:CMAP<1...26>:PDEFined
- DISPlay:FORMat
- DISPlay:LOGO
- DISPlay:PSAVe[:STATe]
- DISPlay:PSAVe:HOLDoff
- DISPlay[:WINDow<1|2>]:SIZE
- DISPlay[:WINDow<1|2>]:TEXT[:DATA]
- DISPlay[:WINDow<1|2>]:TEXT:STATe
- DISPlay[:WINDow<1|2>]:TIME
- DISPlay[:WINDow<1|2>]:TRACe<1...6>[:STATe]
- DISPlay[:WINDow<1|2>]:TRACe<1...6>:MODE
- DISPlay[:WINDow<1|2>]:TRACe<1...6>:MODE:HCONtinuous
- DISPlay[:WINDow<1|2>]:TRACe<1...6>:X:SPACing
- DISPlay[:WINDow<1|2>]:TRACe<1...6>:Y:SPACing
- DISPlay[:WINDow<1|2>]:TRACe<1...6>:Y[:SCALe]
- DISPlay[:WINDow<1|2>]:TRACe<1...6>:Y[:SCALe]:MODE
- DISPlay[:WINDow<1|2>]:TRACe<1...6>:Y[:SCALe]:RLEVel
- DISPlay[:WINDow<1|2>]:TRACe<1...6>:Y[:SCALe]:RLEVel:OFFSet
- DISPlay[:WINDow<1|2>]:TRACe<1...6>:Y[:SCALe]:RPOSition (models with tracking generator)
- DISPlay[:WINDow<1|2>]:TRACe<1...6>:Y[:SCALe]:RVALue (models with tracking generator)
- DISPlay[:WINDow<1|2>]:TRACe<1...6>:Y[:SCALe]:RVALue:AUTO

Further Information

- CMAP suffix assignment

CMAP suffix assignment

Each numeric suffix of CMAP is assigned one or several graphical elements which can be modified by varying the corresponding color setting. The following assignment applies:

Suffix	Description
CMAP1	Background
CMAP2	Grid
CMAP3	Common Text
CMAP4	Check Status OK
CMAP5	Check Status Error
CMAP6	Text Special 1
CMAP7	Text Special 2
CMAP8	Trace 1
CMAP9	Trace 2
CMAP10	Trace 3
CMAP11	Marker Info Text
CMAP12	Limit Lines
CMAP13	Limit and Margin Check - "Pass"
CMAP14	Limit and Margin Check - "Fail"
CMAP15	Softkey Text
CMAP16	Softkey Background
CMAP17	Selected Field Text
CMAP18	Selected Field Background
CMAP19	Softkey 3D Bright Part
CMAP20	Softkey 3D Dark Part
CMAP21	Softkey State "On"
CMAP22	Softkey State "Dialog open"
CMAP23	Softkey Text Disabled
CMAP24	Logo
CMAP25	Trace 4
CMAP26	Grid - Minorlines

DISPlay:ANNotation:FREQuency

This command switches the x-axis annotation on or off.

This command is available from firmware version 1.10.

Parameter

ON | OFF

Example

```
DISP:ANN:FREQ OFF
```

Characteristics

*RST value: ON

SCPI: conform

Mode

all

DISPlay:CMAP<1...26>:DEFault<1|2>

This command resets the screen colors of all display items to their default settings. Two default settings DEFault1 and DEFault2 are available. The numeric suffix of CMAP is irrelevant.

This command is an event and therefore has no query and no *RST value.

This command is available from firmware version 1.10.

Example

```
DISP:CMAP:DEF2
```

Selects default setting 2 for setting the colors.

Characteristics

*RST value: -

SCPI: conform

Mode

all

DISPlay:CMAP<1...26>:HSL

This command defines the color table of the instrument.

For the numeric suffix assignment of CMAP refer to "[CMAP suffix assignment](#)" on page 6.125.

The set values are not changed by *RST.

This command is available from firmware version 1.10.

Parameter

hue = TINT

sat = SATURATION

lum = BRIGHTNESS

The value range is 0 to 1 for all parameters.

Example

```
DISP:CMAP2:HSL 0.3,0.8,1.0
```

Changes the grid color.

Characteristics

*RST value: -

SCPI: conform

Mode

all

DISPlay:CMAP<1...26>:PDEFined

This command defines the color table of the instrument using predefined color values. Each numeric suffix of CMAP is assigned to one or several graphical elements which can be modified by varying the corresponding color setting.

For the numeric suffix assignment of CMAP refer to "[CMAP suffix assignment](#)" on page 6.125.

The values set are not changed by *RST.

This command is available from firmware version 1.10.

Parameter

BLACK | BLUE | BROWN | GREEN | CYAN | RED | MAGENTA | YELLOW | WHITE | DGRAY |
LGRAY | LBLUE | LGREEN | LCYAN | LRED | LMAGENTA

Example

```
DISP:CMAP2:PDEF GRE
```

Characteristics

*RST value: -
SCPI: conform

Mode

all

DISPlay:FORMat

This command has no effect but is implemented for reasons of compatibility with the FSP family. It switches the measurement result display between FULL SCREEN and SPLIT SCREEN.

This command is available from firmware version 1.10.

Parameter

SINGLE | SPLit

Example

```
DISP:FORM SPL
```

Switches the display to 2 measurement windows.

Characteristics

*RST value: SINGLE
SCPI: device-specific

Mode

A

DISPlay:LOGO

This command switches the company logo on the screen on or off.

This command is available from firmware version 1.10.

Parameter

ON | OFF

Example

```
DISP:LOGO OFF
```

Characteristics

*RST value: ON
SCPI: device-specific

Mode

all

DISPlay:PSAVe[:STATe]

This command switches on or off the power-save mode of the display. With the power-save mode activated the display including backlight is completely switched off after the elapse of the response time (see [DISPlay:PSAVe:HOLDoff](#) command).

Note: *This mode is recommended for preserving the display especially if the instrument is exclusively operated via remote control.*

This command is available from firmware version 1.20.

Parameter

ON | OFF

Example

```
DISP:PSAVe ON
```

Switches on the power-save mode.

Characteristics

*RST value: OFF

SCPI: device-specific

Mode

all

DISPlay:PSAVe:HOLDoff

This command sets the holdoff time for the power-save mode of the display. The available value range is 1 to 60 minutes, the resolution 1 minute. The entry is dimensionless.

This command is available from firmware version 1.20.

Parameter

1 to 60

Example

```
DISP:PSAV:HOLD 30
```

Characteristics

*RST value: 15

SCPI: device-specific

Mode

all

DISPlay[:WINDow<1|2>]:SIZE

This command configures the measurement display.

Channel and adjacent-channel power measurements: Only "1" is allowed as a numeric suffix.

Spectrum Emission Mask and Spurious Emissions measurements: The numeric suffix <1|2> selects the item that is displayed in full size; 1 for measurement diagram, 2 for list

Parameter

LARGE Channel and adjacent-channel power measurements: diagram in full screen.
Spectrum Emission Mask and Spurious Emissions measurements: diagram or list in full screen, depending on the value of the numeric suffix.

SMALL split screen (diagram and list)

Example

```
DISP:SIZE LARG
```

Displays the measurement diagram in full screen size.

```
DISP:WIND2:SIZE LARG
```

Displays the list in full screen size.

Characteristics

*RST value: SMALLI

SCPI: device-specific

Mode

A, ADEMOD

DISPlay[:WINDow<1|2>]:TEXT[:DATA]

This command defines a comment (max. 20 characters) which can be displayed on the screen.

This command is available from firmware version 1.10.

Parameter

<string>

Example

```
DISP:WIND:TEXT 'Noise Measurement'
```

Defines the screen title.

Characteristics

*RST value: "" (empty)

SCPI: conform

Mode

all

DISPlay[:WINDow<1|2>]:TEXT:STATe

This command switches on or off the display of the comment (screen title).

This command is available from firmware version 1.10.

Parameter

ON | OFF

Example

```
DISP:TEXT:STAT ON
```

Switches on the title.

Characteristics

*RST value: OFF

SCPI: conform

Mode

all

DISPlay[:WINDow<1|2>]:TIME

This command switches on or off the screen display of date and time. The numeric suffix in WINDow<1| 2> is irrelevant.

This command is available from firmware version 1.10.

Parameter

ON | OFF

Example

```
DISP:TIME ON
```

Characteristics

*RST value: OFF

SCPI: device-specific

Mode

all

DISPlay[:WINDow<1|2>]:TRACe<1...6>[:STATe]

This command switches on or off the display of the corresponding trace.

The numeric suffixes <1|2> are irrelevant.

Parameter

ON | OFF

Example

```
DISP:TRAC3 ON
```

Characteristics

*RST value: ON for TRACe1, OFF for TRACe2 to 6

SCPI: conform

Mode

all

DISPlay[:WINDow<1|2>]:TRACe<1...6>:MODE

This command defines the type of display and the evaluation of the traces. WRITE corresponds to the Clr/Write mode of manual operation. The trace is switched off (= BLANK in manual operation) with `DISPlay[:WINDow<1|2>]:TRACe<1...6>[:STATe]`.

The number of measurements for AVERage, MAXHold and MINHold is defined with the `[SENSe<1|2>:]AVERage:COUNT` or `[SENSe<1|2>:]SWEep:COUNT` commands. It should be noted that synchronization to the end of the indicated number of measurements is only possible in single sweep mode.

If calculation of average values is active, selection between logarithmic and linear averaging is possible. For more detail see `[SENSe<1|2>:]AVERage:TYPE` command.

The numeric suffixes <1|2> are irrelevant.

Parameter

WRITE | VIEW | AVERage | MAXHold | MINHold |RMS

For details on trace modes refer to chapter "Instrument Functions", section "Trace mode overview".

Example

```
SWE:CONT OFF
```

Switching to single sweep mode.

```
SWE:COUN 16
```

Sets the number of measurements to 16.

```
DISP:TRAC3:MODE MAXH
```

Switches on the calculation of the for trace 3.

```
INIT;*WAI
```

Starts the measurement and waits for the end of the 16 sweeps.

Characteristics

*RST value: WRITe for TRACe1, STATe OFF for TRACe2/3/4/5/6

SCPI: device-specific

Mode

all

DISPlay[:WINDow<1|2>]:TRACe<1...6>:MODE:HCONtinuous

This command defines, whether traces in Min Hold, Max Hold and Average mode are reset after parameter change or not.

Normally, the measurement is started anew after parameter changes, before the measurement results are evaluated (e.g. using a marker). In all cases that require a new measurement after parameter changes, the trace is reset automatically to avoid false results (e.g. with span changes). For applications that require no reset after parameter changes, the automatic reset can be switched off.

The numeric suffixes <1|2> are irrelevant.

Parameter

OFF After certain parameter changes the traces are reset.

ON The automatic reset is switched off.

Example

```
DISP:WIND:TRAC3:MODE:HCON ON
```

Switches off the reset function.

Characteristics

*RST value: OFF

SCPI: device-specific

Mode

A, CATV

DISPlay[:WINDow<1|2>]:TRACe<1...6>:X:SPACing

This command toggles between linear and logarithmic scaling of the x-axis.

Parameter

LINear | LOGarithmic

Example

```
DISP:TRAC:X:SPAC LOG
```

Sets the x-axis to a logarithmic scale

Characteristics

*RST value: LOG

SCPI: conform

Mode

A-F

DISPlay[:WINDow<1|2>]:TRACe<1...6>:Y:SPACing

This command selects the scaling for the level display range.
The numeric suffixes <1|2> and <1...6> are irrelevant.

Parameter

LOGarithmic Selects logarithmic scaling.
LINear Selects linear scaling in %.
LDB Selects linear scaling in dB.

Example

```
DISP:TRAC:Y:SPAC LIN
```

Characteristics

*RST value: LOGarithmic
SCPI: conform

Mode

A, ADEMOD, CATV

DISPlay[:WINDow<1|2>]:TRACe<1...6>:Y[:SCALe]

This command defines the display range of the y-axis (level axis) with logarithmic scaling ([DISPlay\[:WINDow<1|2>\]:TRACe<1...6>:Y:SPACing](#)).
For linear scaling, the display range is fixed and cannot be modified.
The numeric suffixes <1|2> and <1...6> are irrelevant.

Parameter

10 dB to 200 dB or value in Hz

Example

```
DISP:TRAC:Y 110dB
```

Characteristics

*RST value: 100dB
SCPI: device-specific

Mode

all

DISPlay[:WINDow<1|2>]:TRACe<1...6>:Y[:SCALe]:MODE

This command defines the scale type of the y-axis (absolute or relative).
When `SYSTem:DISPlay:UPDate` is set to OFF, this command has no immediate effect on the screen. The numeric suffixes <1|2> and <1...6> are irrelevant.

Parameter

ABSolute | RELative

Example

```
DISP:TRAC:Y:MODE REL
```

Characteristics

*RST value: ABS
SCPI: device-specific

Mode

all

DISPlay[:WINDow<1|2>]:TRACe<1...6>:Y[:SCALe]:RLEVel

This command defines the reference level.

With the reference level offset $\neq 0$, the indicated value range of the reference level is modified by the offset.

The unit depends on the setting defined with `CALCulate<1|2>:UNIT:POWer`.

The numeric suffixes $\langle 1|2 \rangle$ and $\langle 1...6 \rangle$ are irrelevant.

Parameter

$\langle \text{numeric_value} \rangle$ in dBm, range specified in data sheet

Example

```
DISP:TRAC:Y:RLEV -60dBm
```

Characteristics

*RST value: -20dBm

SCPI: conform

Mode

A, CATV, CDMA, EVDO, WCDMA

DISPlay[:WINDow<1|2>]:TRACe<1...6>:Y[:SCALe]:RLEVel:OFFSet

This command defines the offset of the reference level.

The numeric suffixes $\langle 1|2 \rangle$ and $\langle 1...6 \rangle$ are irrelevant.

Parameter

-200dB to 200dB

Example

```
DISP:TRAC:Y:RLEV:OFFS -10dB
```

Characteristics

*RST value: 0dB

SCPI: conform

Mode

A, CATV, CDMA, EVDO, PSM, WCDMA, WLAN

DISPlay[:WINDow<1|2>]:TRACe<1...6>:Y[:SCALe]:RPOSition (models with tracking generator)

This command requires a tracking generator and active normalization in the **Tracking Generator** mode. It defines the position of the reference value.

The numeric suffixes $\langle 1|2 \rangle$ and $\langle 1...6 \rangle$ are irrelevant.

Parameter

0 to 100PCT

Example

```
DISP:TRAC:Y:RPOS 50PCT
```

Characteristics

*RST value:

100 PCT Spectrum Analyzer mode

50 PCT Tracking Generator mode

SCPI: conform

Mode

A, ADEMOD, BT, CATV, CDMA, EVDO, WCDMA

DISPlay[:WINDow<1|2>]:TRACe<1...6>:Y[:SCALe]:RVALue (models with tracking generator)

This command requires a tracking generator and active normalization in the **Tracking Generator** mode. The command defines the power value assigned to the reference position. The numeric suffixes <1|2> and <1...6> are irrelevant.

Parameter

<numeric_value>

Example

```
DISP:TRAC:Y:RVAL -20dBm
```

(Analyzer)

```
DISP:TRAC:Y:RVAL 0
```

Sets the power value assigned to the reference position to 0 dB (tracking generator)

Characteristics

*RST value: 0 dB, coupled to reference level

SCPI: device-specific

Mode

A, ADEMOD, BT, CDMA, EVDO

DISPlay[:WINDow<1|2>]:TRACe<1...6>:Y[:SCALe]:RVALue:AUTO

This command defines whether the reference value for the y-axis is coupled to the reference level (default) or not.

The numeric suffixes <1|2> and <1...6> are irrelevant.

Parameter

ON | OFF

Example

```
DISP:TRAC:Y:RVAL:AUTO ON
```

Characteristics

*RST value: ON

SCPI: device-specific

Mode

A, CDMA, EVDO

FORMat Subsystem

The FORMat subsystem specifies the data format of the data transmitted from and to the instrument.

Commands of the FORMat Subsystem

- FORMat[:DATA]
- FORMat:DEXPort:DSEPARATOR

FORMat[:DATA]

This command specifies the data format for the data transmitted from the instrument to the control PC. It is used for the transmission of trace data. The data format of trace data received by the instrument is automatically recognized, regardless of the format which is programmed. In the spectrum mode, the format setting REAL, 32 is used for the binary transmission of trace data (see also TRACe<1 | 2>[:DATA] command).

Parameter

ASCII | REAL | UINT | MATLAB [,8 | 32]

ASCII data are transmitted in plain text, separated by commas. REAL data are transmitted as 32-bit IEEE 754 floating-point numbers in the "definite length block format". The format UINT is only used in operating mode vector signal analysis, for the symbol table.

Example

```
FORM REAL, 32
FORM ASC
FORM UINT, 8
```

Characteristics

*RST value: ASCII
SCPI: conform

Mode

all

FORMat:DEXPort:DSEPARATOR

This command defines which decimal separator (decimal point or comma) is to be used for outputting measurement data to the file in ASCII format. Different languages of evaluation programs (e.g. MS Excel) can thus be supported.

Parameter

POINT | COMMA

Example

```
FORM:DEXP:DSEP POIN
Sets the decimal point as separator.
```

Characteristics

*RST value: - (factory setting is POINT; *RST does not affect setting)
SCPI: device-specific

Mode

all

HCOPY Subsystem

The HCOpy subsystem controls the output of display information for documentation purposes on output devices or files. The instrument allows two independent printer configurations which can be set separately with the numeric suffix <1|2>.

Commands of the HCOpy Subsystem

- HCOpy[:IMMEDIATE<1|2>]
- HCOpy[:IMMEDIATE<1|2>]:NEXT
- HCOpy:ABORT
- HCOpy:CMAP<1...26>:DEFAULT
- HCOpy:CMAP<1...26>:HSL
- HCOpy:CMAP<1...26>:PDEFINED
- HCOpy:DESTINATION<1|2>
- HCOpy:DEVICE:COLOR
- HCOpy:DEVICE:LANGUAGE<1|2>
- HCOpy:ITEM:ALL
- HCOpy:ITEM:WINDOW<1|2>:TEXT
- HCOpy:ITEM:WINDOW<1|2>:TRACE:STATE
- HCOpy:PAGE:ORIENTATION<1|2>

HCOPY[:IMMEDIATE<1|2>]

This command starts a hardcopy output. The numeric suffix selects which printer configuration (device 1 or 2) is to be used for the hardcopy output. If there is no suffix, configuration 1 is automatically selected.

This command is an event and therefore has no *RST value and no query.

Example

```
HCOPY:DEV:LANG BMP
```

Selects the data format.

```
HCOPY:DEST 'MMEM'
```

Directs the hardcopy to a file.

```
MMEM:NAME 'C:\R_S\instr\user\Print.bmp'
```

Selects the file name. If the file Print.bmp already exists, it is replaced.

```
HCOPY
```

Saves the hardcopy output into the file Print.bmp.

Characteristics

*RST value: -

SCPI: conform

Mode

all

HCOPY[:IMMEDIATE<1|2>]:NEXT

This command starts a hardcopy output. The numeric suffix selects which printer configuration (device 1 or 2) is to be used for the hardcopy output. If there is no suffix, configuration 1 is automatically selected. If the output is printed to a file (see [HCOPY:DESTINATION<1|2>](#) command), the file name used in the last saving process is automatically counted up to the next unused name.

This command is an event and therefore has no *RST value and no query.

This command is available from firmware version 1.70.

Example

```
HCOP:DEV:LANG BMP
```

Selects the data format.

```
HCOP:DEST 'MMEM'
```

Directs the hardcopy to a file.

```
MMEM:NAME 'C:\R_S\instr\user\Print.bmp'
```

Selects the file name.

```
HCOP
```

Saves the hardcopy output into the file Print.bmp.

```
HCOP:NEXT
```

Saves the hardcopy output into the file Print_001.bmp.

```
HCOP:NEXT
```

Saves the hardcopy output into the file Print_002.bmp.

Characteristics

RST value: -

SCPI: device-specific

Mode

all

HCOPY:ABORT

This command aborts a running hardcopy output.

This command is an event and therefore has no *RST value and no query.

Example

```
HCOP:ABOR
```

Characteristics

*RST value: -

SCPI: conform

Mode

all

HCOPY:CMAP<1...26>:DEFAULT

This command sets the colors for a printout or hardcopy. The numeric suffix in CMAP is not significant.

This command is an event and therefore has no query and no *RST value.

This command is available from firmware version 1.10.

Parameter

- 1 current screen colors with the background in white and the grid in black.
- 2 optimized color set
- 3 user defined color set
- 4 current screen colors without any changes (setting for hardcopies)

Example

HCOP:CMAP:DEF2

Selects the optimized color set for the color settings of a printout or a hardcopy.

Characteristics

*RST value: -
 SCPI: conform

Mode

all

HCOPy:CMAP<1...26>:HSL

This command defines the color table in user defined colors.

To each numeric suffix of CMAP is assigned one or several picture elements which can be modified by varying the corresponding color setting. For details on the CMAP assignment refer to "[CMAP suffix assignment](#)" on page 6.125.

The values set are not changed by *RST.

This command is available from firmware version 1.10.

Parameter

hue = tint
 sat = saturation
 lum = brightness

The value range is 0 to 1 for all parameters.

Example

HCOP:CMAP2:HSL 0.3,0.8,1.0

Changes the grid color

Characteristics

*RST value: -
 SCPI: conform

Mode

all

HCOPy:CMAP<1...26>:PDEFined

This command defines the color table in user defined colors using predefined color values. To each numeric suffix of CMAP is assigned one or several picture elements which can be modified by varying the corresponding color setting. For details on the CMAP assignment refer to "[CMAP suffix assignment](#)" on page 6.125.

The values set are not changed by *RST.

This command is available from firmware version 1.10.

Parameter

BLACK | BLUE | BROWN | GREEN | CYAN | RED | MAGENTA | YELLOW | WHITE | DGRAY |
LGRAY | LBLUE | LGREEN | LCYAN | LRED | LMAGENTA

Example

HCOPY:CMAP2:PDEF GRE

Characteristics

*RST value: -

SCPI: conform

Mode

all

HCOPY:DESTINATION<1|2>

This command selects the printer output medium (Disk, Printer or Clipboard) associated with configuration 1 or 2.

Note: *The type of instrument is selected with `SYSTEM:COMMUNICATE:PRINTER:SELECT <1|2>`, which will automatically select a default output medium. Therefore the `HCOPY:DESTINATION<1|2>` command should always be sent after setting the device type.*

Parameter

MMEM	Directs the hardcopy to a file. The <code>MMEMORY:NAME</code> command defines the file name. All formats can be selected for <code>HCOPY:DEVICE:LANGUAGE<1 2></code> .
SYST:COMM:PRIN	Directs the hardcopy to the printer. The printer is selected with the <code>SYSTEM:COMMUNICATE:PRINTER:SELECT <1 2></code> command. GDI should be selected for <code>HCOPY:DEVICE:LANGUAGE<1 2></code> .
SYST:COMM:CLIP	Directs the hardcopy to the clipboard. EWMF should be selected for <code>HCOPY:DEVICE:LANGUAGE<1 2></code> .

Example

SYST:COMM:PRIN:SEL2 'LASER on LPT1'

Selects the printer and output medium for device 2.

HCOPY:DEST2 'SYST:COMM:PRIN'

Selects the printer interface as device 2.

Characteristics

*RST value: SYST:COMM:CLIP

SCPI: conform

Mode

all

HCOPy:DEvIce:COLor

This command selects between color and monochrome hardcopy of the screen.
 This command is available from firmware version 1.10.

Parameter

ON | OFF

Example

HCOP:DEV:COL ON

Characteristics

*RST value: OFF

SCPI: conform

Mode

all

HCOPy:DEvIce:LANGUage<1|2>

This command determines the data format of the printout.

Parameter

- | | |
|---------------|---|
| GDI | Graphics Device Interface:

Default format for the output to a printer configured under Windows. Must be selected for the output to the printer interface.

Can be used for the output to a file. The printer driver configured under Windows is used in this case and a printer-specific file format is thus generated.

(see also HCOPy:DESTination<1 2> command) |
| WMF, EWMF | WINDOWS Metafile and Enhanced Metafile Format:

Data formats for output files which can be integrated in corresponding programs for documentation purposes at a later time. WMF can only be used for output to a file and EWMF also for the output to the clipboard.

(see also HCOPy:DESTination<1 2> command) |
| BMP, JPG, PNG | Data format for output to files only. |

Example

HCOP:DEV:LANG WMF

Characteristics

*RST value: -

SCPI: conform

Mode

all

HCOPY:ITEM:ALL

This command selects the complete screen to be output.

The hardcopy output is always provided with comments, title, time and date. As an alternative to the whole screen, e.g. only traces ([HCOPY:ITEM:WINDow<1|2>:TRACe:STATe](#) command) can be output.

Example

```
HCOP:ITEM:ALL
```

Characteristics

*RST value: -

SCPI: conform

Mode

all

HCOPY:ITEM:WINDow<1|2>:TEXT

This command defines the comment text for the printout.

The numeric suffixes <1|2> are irrelevant for this command.

Parameter

<string> with a maximum of 100 characters; line feed by means of character @

Example

```
HCOP:ITEM:WIND:TEXT 'comment'
```

Characteristics

RST value: -

SCPI: device-specific

Mode

all

HCOPY:ITEM:WINDow<1|2>:TRACe:STATe

This command selects the output of the currently displayed trace.

The numeric suffixes <1|2> are irrelevant for this command.

Both the [HCOPY:ITEM:WINDow<1|2>:TRACe:STATe](#) command and the [HCOPY:ITEM:ALL](#) command enable the output of the whole screen.

Parameter

ON | OFF

Example

```
HCOP:ITEM:WIND:TRACe:STAT ON
```

Characteristics

*RST value: OFF

SCPI: device-specific

Mode

all

HCOPy:PAGE:ORIENTATION<1|2>

The command selects the format of the output (portrait and landscape) (hardcopy unit 1 or 2).

Note: *The command is only available provided that the output device "printer" (HCOPy:DESTINATION<1|2>) has been selected.*

Parameter

LANDscape | PORTrait

Example

```
HCOP:PAGE:ORI LAND
```

Characteristics

*RST value: PORT

SCPI: conform

Mode

all

HCOPy:TDSTAMP:STATE<1|2>

This command activates and deactivates if the time and date are on the printout.

The numeric suffixes <1|2> define the print device number.

Parameter

ON | OFF

Example

```
HCOP:TDST:STAT OFF
```

Deactivates the time and time for printouts.

```
HCOP:TDST:STAT?
```

Queries if time and date are activated or not.

Characteristics

*RST value: OFF

SCPI: device-specific

Mode

all

INITiate Subsystem

The INITiate subsystem is used to control the init-measurement function.

Commands of the INITiate Subsystem

- INITiate<1|2>[:IMMediate]
- INITiate<1|2>:CONMeas
- INITiate<1|2>:CONTInuous
- INITiate<1|2>:DISPlay
- INITiate<1|2>:ESpectrum
- INITiate<1|2>:SPURious

INITiate<1|2>[:IMMediate]

The command initiates a new measurement sequence.

With sweep count > 0 or average count > 0, this means a restart of the indicated number of measurements. With trace functions MAXHold, MINHold and AVERage, the previous results are reset on restarting the measurement.

In single sweep mode, synchronization to the end of the indicated number of measurements can be achieved with the command *OPC, *OPC? or *WAI. In continuous-sweep mode, synchronization to the sweep end is not possible since the overall measurement never ends.

The numeric suffixes <1|2> are irrelevant for this command.

This command is an event and therefore has no *RST value and no query.

Example

```
INIT:CONT OFF
```

Switches to single sweep mode.

```
DISP:WIND:TRAC:MODE AVER
```

Activates trace averaging.

```
SWE:COUN 20
```

Setting the sweep counter to 20 sweeps.

```
INIT;*WAI
```

Starts the measurement and waits for the end of the 20 sweeps.

Characteristics

*RST value: -

SCPI: conform

Mode

all

INITiate<1|2>:CONMeas

This command continues a stopped measurement at the current position in single sweep mode. The function is useful especially for trace functions MAXHold, MINHold and AVERage, if the previous results are not to be cleared with sweep count > 0 or average count > 0 on restarting the measurement (INIT:IMMediate resets the previous results on restarting the measurement).

The single sweep mode is automatically switched on. Synchronization to the end of the indicated number of measurements can then be performed with the commands *OPC, *OPC? or

*WAI. In the continuous sweep mode, synchronization to the sweep end is not possible since the overall measurement "never" ends.

The numeric suffixes <1|2> are irrelevant for this command.

This command is an event and therefore has no *RST value and no query.

Example

```
INIT:CONT OFF
```

Switches to single sweep mode.

```
DISP:WIND:TRAC:MODE AVER
```

Switches on trace averaging.

```
SWE:COUN 20
```

Setting the sweep counter to 20 sweeps.

```
INIT;*WAI
```

Starts the measurement and waits for the end of the 20 sweeps.

```
INIT:CONM;*WAI
```

Continues the measurement (next 20 sequences) and waits for the end.

Characteristics

*RST value: -

SCPI: device-specific

Mode

A, CATV, CDMA, EVDO

INITiate<1|2>:CONTinuous

This command determines whether the trigger system is continuously initiated (continuous) or performs single measurements (single).

This setting refers to the sweep sequence (switching between continuous/single sweep).

The numeric suffixes <1|2> are irrelevant for this command.

Parameter

ON | OFF

Example

```
INIT:CONT OFF
```

Switches the sequence single sweep.

```
INIT:CONT ON
```

Switches the sequence to continuous sweep.

Characteristics

*RST value: ON

SCPI: conform

Mode

all

INITiate<1|2>:DISPlay

This command switches the display during a single sweep measurement on (ON) or off (OFF).

The numeric suffixes <1|2> are irrelevant for this command.

Parameter

ON | OFF

Example

```
INIT:CONT OFF
```

Switches to single sweep mode

```
INIT:DISP OFF
```

Sets the display behavior to OFF

```
INIT;*WAI
```

Starts the measurement with display switched off.

Characteristics

*RST value: ON

SCPI: device-specific

Mode

A

INITiate<1|2>:ESpectrum

This command starts a Spectrum Emission Mask measurement.

The numeric suffixes <1|2> are not relevant.

This command is an event and therefore has no *RST value and no query.

This command is available from firmware version 1.80.

Example

```
INIT:ESP
```

Starts a Spectrum Emission Mask measurement.

Characteristics

RST value: -

SCPI: device-specific

Mode

A

INITiate<1|2>:SPURious

This command starts a Spurious Emissions measurement.

The numeric suffixes <1|2> are not relevant.

This command is an event and therefore has no *RST value and no query.

This command is available from firmware version 1.80.

Example

```
INIT:SPUR
```

Starts a Spurious Emissions measurement.

Characteristics

RST value: -

SCPI: device-specific

Mode

A

INPut Subsystem

The INPut subsystem controls the input characteristics of the RF inputs of the instrument.

Commands of the INPut Subsystem

- INPut<1|2>:ATTenuation
- INPut<1|2>:ATTenuation:AUTO
- INPut<1|2>:GAIN:STATe (option RF Preamplifier, B22)
- INPut<1|2>:IMPedance
- INPut<1|2>:UPORt[:VALue]?
- INPut<1|2>:UPORt:STATe

INPut<1|2>:ATTenuation

This command programs the input attenuator. To protect the input mixer against damage from overloads, the setting 0 dB can be obtained by entering numerals, not by using the DEC command.

The attenuation can be set in 5 dB steps. If the defined reference level cannot be set for the set RF attenuation, the reference level will be adjusted accordingly.

In the default state with **Spectrum Analyzer** mode, the attenuation set on the step attenuator is coupled to the reference level of the instrument. If the attenuation is programmed directly, the coupling to the reference level is switched off.

Parameter

<numeric_value> in dB; range specified in data sheet

Example

```
INP:ATT 30dB
```

Sets the attenuation on the attenuator to 30 dB and switches off the coupling to the reference level.

Characteristics

*RST value: 0 dB (AUTO is set to ON)

SCPI: conform

Mode

all

INPut<1|2>:ATTenuation:AUTO

This command automatically couples the input attenuation to the reference level (state ON) or switches the input attenuation to manual entry (state OFF).

Parameter

ON | OFF

Example

```
INP:ATT:AUTO ON
```

Couples the attenuation set on the attenuator to the reference level.

Characteristics

*RST value: ON

SCPI: conform

Mode

all

INPut<1|2>:GAIN:STATe (option RF Preamplifier, B22)

This command switches the preamplifier on or off. The preamplifier only has an effect below 6 GHz.

Parameter

ON | OFF

Example

```
INP:GAIN:STAT ON
```

Switches on 20 dB preamplification.

Characteristics

*RST value: OFF

SCPI: conform

Mode

A, NF, CATV, WCDMA, CDMA, EVDO

INPut<1|2>:IMPedance

This command sets the nominal input impedance of the instrument. The set impedance is taken into account in all level indications of results.

The setting 75 Ω should be selected, if the 50 Ω input impedance is transformed to a higher impedance using a 75 Ω adapter of the RAZ type (= 25 Ω in series to the input impedance of the instrument). The correction value in this case is 1.76 dB = 10 log (75 Ω / 50 Ω).

Parameter

50 | 75

Example

```
INP:IMP 75
```

Characteristics

*RST value: 50 Ω

SCPI: conform

Mode

All

INPut<1|2>:UPORt[:VALue]?

This command queries the control lines of the user ports.
This command is a query and therefore has no *RST value.

Example

```
INP:UPOR?
```

Characteristics

RST value: -

SCPI: device-specific

Mode

all

INPut<1|2>:UPORt:STATe

This command toggles the control lines of the user ports between INPut and OUTPut. With ON, the user port is switched to INPut, with OFF to OUTPut.

Parameter

ON | OFF

Example

```
INP:UPOR:STAT ON
```

Characteristics

RST value: ON

SCPI: device-specific

Mode

all

INSTRUMENT Subsystem

The INSTRUMENT subsystem selects the operating mode of the unit either via text parameters or fixed numbers.

Commands of the INSTRUMENT Subsystem

- [INSTRUMENT\[:SElect\]](#)
- [INSTRUMENT:NSElect](#)

INSTRUMENT[:SElect]

This command switches between the measurement modes by means of text parameters.

Parameter

SANalyzer spectrum analyzer

The parameters of the other measurement modes are included in the option descriptions.

Example

```
INST SAN
```

Switches the instrument to spectrum analyzer mode.

Characteristics

*RST value: SANalyzer

SCPI: conform

Mode

all

INSTRUMENT:NSElect

This command switches between the measurement modes by means of numbers.

Parameter

1 spectrum analyzer

The parameters of the other measurement modes are included in the option descriptions.

Example

```
INST:NSEL 1
```

Switches the instrument to spectrum analyzer mode.

Characteristics

*RST value: 1

SCPI: conform

Mode

all

MMEMory Subsystem

The MMEMory (mass memory) subsystem provides commands which allow for access to the storage media of the instrument and for storing and loading various instrument settings.

The various drives can be addressed via the "mass storage unit specifier" <msus> using the conventional DOS syntax. The internal hard disk is addressed by "C:". For details on drives refer to chapter 4 "Instrument Functions - Basic Settings", section "Saving and Recalling Settings Files - FILE Key".

The file names <file_name> are indicated as string parameters with the commands being enclosed in quotation marks. They also comply with DOS conventions.

DOS file names consist of max. 8 ASCII characters and an extension of up to three characters separated from the file name by a dot "." Both, the dot and the extension are optional. The dot is not part of the file name. DOS file names do not distinguish between uppercase and lowercase notation. All letters and digits are permitted as well as the special characters "_", "^", "\$", "~", "!", "#", "%", "&", "-", "{", "}", "(", ")", "@", and "'". Reserved file names are CLOCK\$, CON, AUX, COM1 to COM4, LPT1 to LPT3, NUL and PRN.

The two characters "*" and "?" have the function of so-called "wildcards", i.e., they are variables for selection of several files. The question mark "?" replaces exactly one character, the asterisk means any of the remaining characters in the file name. "*. *" thus means all files in a directory.

Commands of the MMEMory Subsystem

- MMEMory:CATalog?
- MMEMory:CDIRectory
- MMEMory:CLEar:ALL
- MMEMory:CLEar:STATe
- MMEMory:COMMeNt
- MMEMory:COpy
- MMEMory:DATA
- MMEMory:DELeTe
- MMEMory:LOAD:AUTO
- MMEMory:LOAD:STATe
- MMEMory:MDIRectory
- MMEMory:MOVE
- MMEMory:MSIS
- MMEMory:NAME
- MMEMory:NETWork:MAP
- MMEMory:NETWork:DISConnect
- MMEMory:NETWork:UNUSeddrives?
- MMEMory:NETWork:USEDdrives?
- MMEMory:RDIRectory
- MMEMory:SELEct[:ITEM]:ALL
- MMEMory:SELEct[:ITEM]:DEFault
- MMEMory:SELEct[:ITEM]:FINAl

- MMEMory:SElect[:ITEM]:HWSettings
- MMEMory:SElect[:ITEM]:LINes:ALL
- MMEMory:SElect[:ITEM]:NONE
- MMEMory:SElect[:ITEM]:SCData (models with tracking generator)
- MMEMory:SElect[:ITEM]:TRACe[:ACTive]
- MMEMory:SElect[:ITEM]:TRANsducer:ALL
- MMEMory:STORe<1|2>:LIST
- MMEMory:STORe<1|2>:PEAK
- MMEMory:STORe<1|2>:STATe
- MMEMory:STORe<1|2>:STATe:NEXT
- MMEMory:STORe<1|2>:TRACe

MMEMory:CATalog?

This command reads the indicated directory. According to DOS convention, wild card characters can be entered in order to query e.g. a list of all files of a certain type.

This command is an event and therefore has no *RST value and no query.

Parameter

<path> = DOS Path name

The path name should be in conformance with DOS conventions and may also include the drive name.

Example

```
MMEM:CAT? 'C:\R_S\Instr\user\*.DFL'
```

Returns all files in C:\R_S\Instr\user with extension ".DFL"

```
MMEM:CAT? 'C:\R_S\Instr\user\SPOOL?.WMF'
```

Returns all files in C:\R_S\Instr\user whose names start with SPOOL, have 6 letters and the extension ".WMF".

Response value

List of file names in the form of strings separated by commas, i.e.

SPOOL1.WMF,SPOOL2.WMF,SPOOL3.WMF

Characteristics

*RST value: -

SCPI: conform

Mode

all

MMEMory:CDIRectory

This command changes the current directory.

Parameter

<directory_name> = DOS path name

In addition to the path name, the indication of the directory may contain the drive name. The path name complies with the DOS conventions.

Example

```
MMEM:CDIR 'C:\R_S\Instr\user'
```

Selects the directory C:\R_S\Instr\user.

Characteristics

*RST value: -
SCPI: conform

Mode

all

MMEMory:CLEar:ALL

This command deletes all settings files in the current directory. The current directory can be selected with the [MMEMory:CDIRectory](#) command. The default directory is C:\R_S\instr\user. This command is an event and therefore has no *RST value and no query.

Example

```
MMEM:CLE:ALL
```

Characteristics

*RST value: -
SCPI: device-specific

Mode

all

MMEMory:CLEar:STATe

This command deletes the instrument settings file selected by <file_name>. All associated files on the mass memory storage are cleared.

This command is an event and therefore has no *RST value and no query.

Parameter

1,<file_name>

with <file_name> = DOS file name without extension

The file name includes indication of the path and may also include the drive. The path name complies with DOS conventions.

Example

```
MMEM:CLE:STAT 1, 'TEST'
```

Characteristics

*RST value: -
SCPI: device-specific

Mode

all

MMEMory:COMMeNT

This command defines a comment (max. 60 characters) for a device setting to be stored.

Example

```
MMEM:COMM 'Setup for FM measurement'
```

Characteristics

*RST value: blank comment

SCPI: device-specific

Mode

A

MMEMory:COpy

This command copies the files indicated in <file_source> to the destination directory indicated with <file_destination> or to the destination file indicated by <file_destination> if <file_source> is just a file.

This command is an event and therefore has no *RST value and no query.

Parameter

<file_source>,<file_destination> = <file_name> = DOS file name

The indication of the file name may include the path and the drive name. The file names and path information must be in accordance with the DOS conventions.

Example

```
MMEM:COpy 'C:\R_S\Instr\user\SETUP.CFG','E:'
```

Characteristics

*RST value: -

SCPI: conform

Mode

all

MMEMory:DATA

This command writes the block data contained in <block> into the file characterized by <file_name>. The delimiter must be set to EOI to obtain error-free data transfer.

The associated query command reads the indicated file from the mass memory and transfers it to the remote control computer. It should be noted that the buffer memory of the control computer should be large enough to store the file. The setting of the delimiter is irrelevant in this case.

The command is useful for reading stored settings files or trace data from the instrument or for transferring them to the instrument.

Parameter

<file_name>[,<block>]

<file_name> selects the file to be transferred

<block> binary data block with the following structure:

- character '#'
- digit for the length of the length information

- indicated number of digits as length information (number of bytes) for the binary data themselves
- binary data with the indicated number of bytes

Example

MMEM:DATA 'TEST01.HCP,#216This is the file'
 means: #2: the next 2 characters are the length indication; 16: number of subsequent binary data bytes; This is the file: 16 bytes stored as binary data in the file TEST01.HCP.

MMEM:DATA? 'TEST01.HCP'
 Transfers the file TEST01.HCP from the instrument to the control computer.

Characteristics

*RST value: -
 SCPI: conform

Mode

all

MMEMory:DELeTe

This command deletes the indicated files.

Parameter

<file_name> = DOS file name

The indication of the file name contains the path and, optionally, the drive name. Indication of the path complies with DOS conventions.

Example

MMEM:DEL 'TEST01.HCP'
 The file TEST01.HCP is deleted.

Characteristics

*RST value: -
 SCPI: conform

Mode

all

MMEMory:LOAD:AUTO

This command defines which settings file is automatically loaded after the device is switched on. The contents of the file are read after switching on the device and used to define the new device state.

The settings file defined as auto recall set can also be restored by the *RST command.

This command is an event and therefore has no *RST value and no query.

Parameter

- 1,'FACTORY' deactivates the startup recall function
- 1,'<file_name>' activates the startup recall function and defines the settings file to be loaded

with <file_name> = DOS file name without extension

The file name includes indication of the path and may also include the drive name. The path name complies with DOS conventions.

Example

```
MMEM:LOAD:AUTO 1, 'C:\R_S\Instr\user\TEST'
```

Characteristics

*RST value: -

SCPI: device-specific

Mode

all

MMEMory:LOAD:STATe

This command loads the device settings from *.FSL.dfl files. The contents of the file are loaded and set as the new device state.

Parameter

1,<file_name>

with <file_name> = DOS file name without extension

The file name includes indication of the path and may also include the drive name. The path name complies with DOS conventions.

Example

```
MMEM:LOAD:STAT 1, 'C:\R_S\Instr\user\TEST01'
```

Characteristics

*RST value: -

SCPI: conform

Mode

all

MMEMory:MDIRectory

This command creates a new directory. The file name includes indication of the path and may also include the drive name. The path name complies with DOS conventions.

This command is an event and therefore has no *RST value and no query.

Parameter

<directory_name> = DOS path name

Example

```
MMEM:MDIR 'C:\R_S\Instr\user'
```

Characteristics

*RST value: -

SCPI: device-specific

Mode

all

MMEMory:MOVE

This command renames existing files, if <file_destination> contains no path indication. Otherwise the file is moved to the indicated path and stored under the file name specified there, if any.

This command is an event and therefore has no *RST value and no query.

Parameter

<file_source>,<file_destination> = <file_name> = DOS file name

The file name includes indication of the path and may also include the drive. The path name complies with DOS conventions.

Example

```
MMEM:MOVE 'C:\TEST01.CFG', 'SETUP.CFG'
```

Renames TEST01.CFG in SETUP.CFG in directory C:\.

```
MMEM:MOVE 'C:\TEST01.CFG', 'C:\R_S\Instr\user'
```

Moves TEST01.CFG from C:\ to C:\R_S\Instr\user.

```
MMEM:MOVE 'C:\TEST01.CFG', 'C:\R_S\Instr\user\SETUP.CFG'
```

Moves TEST01.CFG from C:\ to C:\R_S\Instr\user and renames the file in SETUP.CFG.

Characteristics

*RST value: -

SCPI: conform

Mode

all

MMEMemory:MSIS

This command changes to the drive indicated. The drive may be the internal hard disk C:.

Parameter

<device> = A: | C: ... Z:

The path name complies with DOS conventions.

Example

```
MMEM:MSIS 'C:'
```

Characteristics

*RST value: "C:"

SCPI: conform

Mode

all

MMEMemory:NAME

This command defines a destination file for the printout started with the [HCOPY\[:IMMEDIATE<1|2>\]](#) command. In this case the printer output must be routed to a file as destination.

This command is an event and therefore has no *RST value and no query.

Parameter

<file_name> = DOS file name

The file name includes indication of the path and may also include the drive name. The file name and path information comply with DOS conventions.

Example

```
MMEM:NAME 'C:\R_S\instr\user\PRINT1.BMP'
```

Selects the file name.

Characteristics

*RST value: -
 SCPI: conform

Mode

all

MMEMory:NETWork:MAP

This command maps a drive to a server or server folder of the network. As a prerequisite in Microsoft networks, sharing of this server or server folder must be enabled.

This command is an event and therefore has no *RST value and no query.

This command is available from firmware version 1.70.

Parameter

'<string>', '<string>', '<string>', '<string>', '<string>', [<Boolean>]

with '<string>', '<string>' = '<drive>', '<\\host name or IP address\share name>'
 [<string>', '<string>'], [<Boolean>] = '<user name>', '<password>', ON | OFF for
 connecting under a different user name, and enabling/disabling reconnect at logon.

The entry is optional. The Boolean parameter can be omitted.

Example

```
MMEM:NETW:MAP 'T:', '\\server\folder'
```

Maps drive T: to folder on server.

Characteristics

RST value: -
 SCPI: device-specific

Mode

all

MMEMory:NETWork:DISConnect

This command disconnects the selected drive.

This command is an event and therefore has no *RST value and no query.

This command is available from firmware version 1.70.

Parameter

'<string>' = <drive name>

Example

```
MMEM:NETW:DISC 'T:'
```

Disconnects network drive T:

Characteristics

RST value: -
 SCPI: device-specific

Mode

all

MMEMemory:NETWork:UNUSeddrives?

This command lists all unused network drive names.
This command is only a query and therefore has no *RST value.
This command is available from firmware version 1.70.

Example

MMEM:NETW:UNUS?
Lists all unused network drive names.

Characteristics

RST value: -
SCPI: device-specific

Mode

all

MMEMemory:NETWork:USEDdrives?

This command lists all mapped network drives.
This command is available from firmware version 1.70.

Parameter

ON Lists all mapped network drives including the folder information.
OFF Lists all mapped network drive names.

Example

MMEM:NETW:USED ON
Lists all mapped network drives including the folder information.

Characteristics

RST value: OFF
SCPI: device-specific

Mode

all

MMEMemory:RDIRectory

This command deletes the indicated directory. The directory name includes indication of the path and may also include the drive name. The path name complies with DOS conventions.
This command is an event and therefore has no *RST value and no query.

Parameter

<directory_name> = DOS path name

Example

MMEM:RDIR 'C:\RUS\INSTR\USER\TEST'

Characteristics

*RST value: -
SCPI: device-specific

Mode

all

MMEMory:SElect[:ITEM]:ALL

This command includes all data subsets in the list of device settings to be stored/loaded.
This command is an event and therefore has no *RST value.

Example

```
MMEM:SEL:ALL
```

Characteristics

*RST value: -

SCPI: device-specific

Mode

all

MMEMory:SElect[:ITEM]:FINal

This command includes the final measurement data in the list of partial datasets of a device setting to be stored/loaded.

Parameter

ON | OFF

Example

```
"MMEM:SEL:FIN ON"
```

inserts the final measurement data in the list of partial data sets

Characteristics:

*RST value: ON

SCPI: device-specific

Mode

R, A

MMEMory:SElect[:ITEM]:DEFault

This command includes the default list in the settings file to be stored/loaded. For details on hardware settings refer to the [MMEMory:SElect\[:ITEM\]:HWSettings](#) command.

Example

```
MMEM:SEL:DEFault
```

Characteristics

*RST value: -

SCPI: device-specific

Mode

all

MMEMory:SElect[:ITEM]:HWSettings

This command includes the hardware settings in the settings file to be stored/loaded. The hardware settings include:

- current configuration of general device parameters (general setup)
- current setting of the measurement hardware including markers
- activated limit lines:

A settings file may include 8 limit lines at maximum. This number includes the activated limit lines and, if available, the de-activated limit lines last used.

Therefore the combination of the non-activated restored limit lines depends on the sequence of use with the `MMEMory:LOAD:STATe` command.

- user-defined color setting
- configuration for the hardcopy output
- tracking generator settings (models 13, 16 and 28)
- correction data for source calibration (models 13, 16 and 28)

Parameter

ON | OFF

Example

```
MMEM:SEL:HWS ON
```

Characteristics

*RST value: ON

SCPI: device-specific

Mode

all

MMEMory:SElect[:ITEM]:LInes:ALL

This command includes all limit lines (activated and de-activated) in the settings file to be stored/loaded.

This command is available from firmware version 1.10.

Parameter

ON | OFF

Example

```
MMEM:SEL:LIN:ALL ON
```

Characteristics

*RST value: ON

SCPI: device-specific

Mode

all

MMEMory:SElect[:ITEM]:NONE

This command excludes all items from the settings file to be stored/loaded.
This command is an event and therefore has no *RST value.

Example

```
MMEM:SEL:NONE
```

Characteristics

*RST value: -
SCPI: device-specific

Mode

all

MMEMory:SElect[:ITEM]:SCData (models with tracking generator)

This command includes the tracking generator calibration data in the settings file to be stored/loaded.

This command is only available in conjunction with the tracking generator.**Parameter**

ON | OFF

Example

```
MMEM:SEL:SCD ON
```

Adds the tracking generator correction data to the items list.

Characteristics

*RST value: OFF
SCPI: device-specific

Mode

all

MMEMory:SElect[:ITEM]:TRACe[:ACTive]

This command includes the active traces in the settings file to be stored/loaded. Active traces are all traces whose state is not blank.

Parameter

ON | OFF

Example

```
MMEM:SEL:TRAC ON
```

Characteristics

*RST value: OFF, i.e. no traces will be stored
SCPI: device-specific

Mode

all

MMEMory:SElect[:ITEM]:TRANsducer:ALL

This command includes all transducer factors and sets in the settings file to be stored/loaded.
This command is available from firmware version 1.10.

Parameter

ON | OFF

Example

MME:SEL:TRAN:ALL ON

Characteristics

*RST value: ON

SCPI: device-specific

Mode

all

MMEMemory:STORe<1|2>:LIST

This command stores the current list evaluation results in a *.dat file. The file consists of a data section containing the list evaluation results.

The numeric suffixes <1|2> are not relevant.

This command is an event and therefore has no *RST value and no query.

This command is available from firmware version 1.80.

Example

MME:STOR:LIST 'test'

Stores the current list evaluation results in the a test.dat file.

Characteristics

RST value: -

SCPI: device-specific

Mode

A

MMEMemory:STORe<1|2>:PEAK

This command stores the current marker peak list in a *.dat file. The file consists of a data section containing the peak list.

The numeric suffixes <1|2> are irrelevant for this command.

This command is an event and therefore has no *RST value and no query.

This command is available from firmware version 1.80.

Parameter

<file_name> = DOS file name without extension

The file name includes the indication of the path and may also include the drive name. The path name complies with DOS conventions.

Example

MME:STOR:PEAK 'test'

Saves the current marker peak list in the file test.dat.

Characteristics

RST value: -

SCPI: device-specific

Mode

all

MMEMory:STORe<1|2>:STATe

This command stores the current device settings in a *.FSL.dfl file.

The numeric suffixes <1|2> are irrelevant for this command.

This command is an event and therefore has no *RST value and no query.

Parameter

1,<file_name>

with <file_name> = DOS file name without extension

The file name includes the indication of the path and may also include the drive name. The path name complies with DOS conventions.

Example

```
MMEM:STOR:STAT 1, 'Save'
```

Saves the current device settings in the file Save.FSL.dfl.

Characteristics

*RST value: -

SCPI: conform

Mode

all

MMEMory:STORe<1|2>:STATe:NEXt

This command stores the current device settings in a *.FSL.dfl file. The file name used in the last saving process is automatically counted up to the next unused name. The numeric suffix in STORe<1|2> is irrelevant with this command.

This command is an event and therefore has no *RST value and no query.

Example

```
MMEM:STOR:STAT 1, 'Save'
```

Saves the current device settings in the file Save.FSL.dfl.

```
MMEM:STOR:STAT:NEXT
```

Saves the current device settings in the file Save_001.FSL.dfl

```
MMEM:STOR:STAT:NEXT
```

Saves the current device settings in the file Save_002.FSL.dfl

Characteristics

RST value: -

SCPI: device-specific

Mode

all

MMEMory:STORe<1|2>:TRACe

This command stores the selected trace in a file with ASCII format. The file format is described in chapter 4 "Instrument Functions - Analyzer", section "Setting Traces - TRACE Key", **ASCII File Export** softkey.

The decimal separator (decimal point or comma) for floating-point numerals contained in the file is defined with the `FORMat:DEXPort:DSEParator` command.

This command is an event and therefore has no *RST value and no query.

Parameter

1 to 6,<file_name>

with 1 to 6 = selected measurement curve trace 1 to 6 and <file_name> = DOS file name

The file name includes indication of the path and the drive name. Indication of the path complies with DOS conventions.

Example

```
MMEM:STOR:TRAC 3, 'TEST.ASC'
```

Stores trace 3 in the file TEST.ASC.

Characteristics

*RST value: -

SCPI: device-specific

Mode

all

OUTPut Subsystem

The OUTPut subsystem controls the output features of the instrument.

Commands of the OUTPut Subsystem

- OUTPut<1|2>[:STATe] (models with tracking generator)
- OUTPut<1|2>:IF[:SOURce]
- OUTPut:UPORt[:VALue]
- OUTPut:UPORt:STATe

OUTPut<1|2>[:STATe] (models with tracking generator)

This command switches the tracking generator on or off.

Note: *With the tracking generator switched on, the maximum stop frequency is limited to 3 GHz. This upper limit is automatically modified by the set frequency offset of the generator.*

If measurements in compliance with specs are to be performed with the tracking generator, the start frequency has to be $\geq 3 \times$ resolution bandwidth.

If a sweep time shorter than recommended in the data sheet is selected, the sweep time indicator SWT on the screen is marked with a red asterisk and the message UNCAL is also displayed.

With the tracking generator switched on, the FFT filters

([SENSe<1|2>:]BANDwidth|BWIDth[:RESolution]:TYPE) are not available.

To switch off the tracking generator without losing the the corresponding hardware settings and the normalization see the

SOURce<1|2>:POWer[:LEVel][:IMMediate][:AMPLitude] command.

Parameter

ON | OFF

Example

OUTP ON

Switches on the tracking generator.

Characteristics

*RST value: -

SCPI: conform

Mode

A

OUTPut<1|2>:IF[:SOURce]

This command switches the source of the IF output between the demodulated signal (2 possible values) and the IF signal.

Note: *The AF output available at the frontpanel can only be used if the IF output source is set to video.*

Parameter

IF intermediate frequency output

VIDeo video output, 200 mV

HVIDeo video output, 1V

Example

```
OUTP IF VID
```

Selects the video signal for the IF output connector.

Characteristics

*RST value: IF

SCPI: conform

Mode

A

OUTPut:UPORt[:VALue]

This command sets the control lines of the user ports.

The user port is written to with the given binary pattern. If the user port is programmed to INPut instead of OUTPut, the output value is temporarily stored.

Parameter

#B00000000 to #B11111111

Example

```
OUTP:UPOR #B10100101
```

Characteristics

*RST value: -

SCPI: device-specific

Mode

all

OUTPut:UPORt:STATe

This command switches the control line of the user ports between INPut and OUTPut. The user port is switched to OUTPut with parameter ON, to INPut with OFF.

Parameter

ON | OFF

Example

```
OUTP:UPOR:STAT ON
```

Characteristics

*RST value: OFF

SCPI: device-specific

Mode

all

SENSe Subsystem

The SENSe subsystem is organized in several subsystems. The commands of these subsystems directly control device-specific settings, they do not refer to the signal characteristics of the measurement signal.

The SENSe subsystem controls the essential parameters of the analyzer. In accordance with the SCPI standard, the keyword "SENSe" is optional for this reason, which means that it is not necessary to include the SENSe node in command sequences.

The following subsystems are included:

- "SENSe:AVERage Subsystem" on page 6.167
- "SENSe:BANDwidth Subsystem" on page 6.170
- "SENSe:CORRection Subsystem (Models with tracking generator)" on page 6.174
- "SENSe:DETEctor Subsystem" on page 6.180
- "SENSe:ESPEctrum Subsystem" on page 6.181
- "SENSe:FREQUency Subsystem" on page 6.194
- "SENSe:LIST Subsystem" on page 6.199
- "SENSe:MPOWer Subsystem" on page 6.209
- "SENSe:POWEr Subsystem" on page 6.214
- "SENSe:ROSCillator Subsystem" on page 6.222
- "SENSe:SWEep Subsystem" on page 6.223

SENSe:AVERage Subsystem

The SENSe:AVERage subsystem calculates the average of the acquired data. A new test result is obtained from several successive measurements.

There are two types of average calculation: logarithmic and linear. In case of logarithmic average calculation (denoted with VIDEO), the average value of the measured logarithmic power is calculated and in case of linear average calculation, the linear power is averaged before the logarithm is applied.

Commands of the SENSe:AVERage Subsystem

- [SENSe<1|2>:]AVERage[:STATe<1...6>]
- [SENSe<1|2>:]AVERage:COUNt
- [SENSe<1|2>:]AVERage:COUNt:AUTO
- [SENSe<1|2>:]AVERage:TYPE

[SENSe<1|2>:]AVERage[:STATe<1...6>]

This command switches on or off the average calculation for the selected trace (STATe<1...4>). The numeric suffixes <1|2> are not relevant.

Parameter

ON | OFF

Example

```
AVER OFF
```

Switches off the average calculation for trace 1.

AVER:STAT3 ON

Switches on the average calculation for trace 3.

Characteristics

*RST value: OFF

SCPI: conform

Mode

all

[SENSe<1|2>:]AVERAge:COUNT

This command defines the number of measurements which contribute to the average value.

It should be noted that continuous averaging will be performed after the indicated number has been reached in continuous sweep mode.

In single sweep mode, the sweep is stopped as soon as the indicated number of measurements (sweeps) is reached. Synchronization to the end of the indicated number of measurements is only possible in single sweep mode.

The [SENSe<1|2>:]AVERAge:COUNT command effects the same as the [SENSe<1|2>:]SWEep:COUNT command. In both cases, the number of measurements is defined whether the average calculation is active or not.

The number of measurements applies to all traces.

The numeric suffixes <1|2> are not relevant.

Parameter

0 to 32767

Example

SWE:CONT OFF

Switching to single sweep mode.

AVER:COUN 16

Sets the number of measurements to 16.

AVER:STAT ON

Switches on the calculation of average.

INIT;*WAI

Starts the measurement and waits for the end of the 16 sweeps.

Characteristics

*RST value: 0

SCPI: conform

Mode

all

[SENSe<1|2>:]AVERAge:COUNT:AUTO

This command is implemented only for reasons of compatibility with the FSP family. It selects a suitable number of counts for the selected measurement type.

The numeric suffixes <1|2> are not relevant.

Parameter

ON | OFF

Example

```
AVER:COUN:AUTO ON
```

Characteristics

RST value: OFF

SCPI: conform

Mode

all

[SENSe<1|2>:]AVERAge:TYPE

This command selects the type of average function.

Parameter

VIDeo The logarithmic power values are averaged.

LINear The power values are averaged before they are converted to logarithmic values.

Example

```
AVER:TYPE LIN
```

Switches to linear average calculation.

Characteristics

RST value: VIDeo

SCPI: device-specific

Mode

A

SENSe:BANDwidth Subsystem

This subsystem controls the setting of the instruments filter bandwidths. Both groups of commands (BANDwidth and BWIDth) perform the same functions.

Commands of the SENSe:BANDwidth Subsystem

- [SENSe<1|2>:]BANDwidth|BWIDth[:RESolution]
- [SENSe<1|2>:]BANDwidth|BWIDth[:RESolution]:AUTO
- [SENSe<1|2>:]BANDwidth|BWIDth[:RESolution]:RATio
- [SENSe<1|2>:]BANDwidth|BWIDth[:RESolution]:TYPE
- [SENSe<1|2>:]BANDwidth|BWIDth:VIDeo
- [SENSe<1|2>:]BANDwidth|BWIDth:VIDeo:AUTO
- [SENSe<1|2>:]BANDwidth|BWIDth:VIDeo:RATio
- [SENSe<1|2>:]BANDwidth|BWIDth:VIDeo:TYPE

[SENSe<1|2>:]BANDwidth|BWIDth[:RESolution]

This command defines the analyzers resolution bandwidth.

The available resolution bandwidths are specified in the data sheet. For details on the correlation between resolution bandwidth and filter type refer to chapter "Instrument Functions", section "To choose the appropriate filter type".

If the resolution bandwidth is modified, the coupling to the span is automatically switched off.

The numeric suffixes <1|2> are not relevant.

Parameter

refer to data sheet

Example

```
BAND 1MHz
```

Sets the resolution bandwidth to 1 MHz

Characteristics

*RST value: - (AUTO is set to ON)

SCPI: conform

Mode

all, except ADEMOD

[SENSe<1|2>:]BANDwidth|BWIDth[:RESolution]:AUTO

This command either automatically couples the resolution bandwidth of the instrument to the span or cancels the coupling.

The automatic coupling adapts the resolution bandwidth to the currently set frequency span according to the relationship between frequency span and resolution bandwidth. The 6 dB bandwidths 200 Hz, 9 kHz and 120 kHz and the channel filters available are not set by the automatic coupling.

The ratio resolution bandwidth/span can be modified with the

[SENSe<1|2>:]BANDwidth|BWIDth[:RESolution]:RATio command.

The numeric suffixes <1|2> are not relevant.

Parameter

ON | OFF

Example

BAND:AUTO OFF

Switches off the coupling of the resolution bandwidth to the span.

Characteristics

*RST value: ON

SCPI: conform

Mode

A-F, CATV, CDMA, EVDO

[SENSe<1|2>:]BANDwidth|BWIDth[:RESolution]:RATio

This command defines the ratio resolution bandwidth (Hz) / span (Hz). The ratio to be entered is reciprocal to the ratio span/RBW used in manual operation.

The numeric suffixes <1|2> are not relevant.

Parameter

0.0001 to 1

Example

BAND:RAT 0.1

Characteristics

*RST value: 0.02 with BAND:TYPE NORMAl or RBW > 30 kHz; 0.01 with BAND:TYPE FFT for RBW ≤ 30 kHz

SCPI: conform

Mode

A, EVDO

[SENSe<1|2>:]BANDwidth|BWIDth[:RESolution]:TYPE

This command switches the filter type for the resolution bandwidth between "normal" analog or FIR filters in 1, 3, 10 steps and the FFT filtering for bandwidths <100 kHz.

For detailed information on filters see chapter "Instrument Functions", section "To choose the appropriate filter" and "List of available RRC and channel filters".

The numeric suffixes <1|2> are not relevant.

Note: When changing the filter type, the next larger filter bandwidth is selected if the same filter bandwidth is not available for the new filter type.

Parameter

NORMAl Gaussian filters

FFT FFT filters

CFILter channel filters

RRC RRC filters

PULSe EMI (6dB) filters (available from firmware version 1.30)

Example

```
BAND:TYPE NORM
```

Characteristics

*RST value: NORMal

SCPI: device-specific

Mode

all, except ADEMOD

[SENSe<1|2>:]BANDwidth|BWIDth:VIDeo

This command defines the instruments video bandwidth. The available video bandwidths are specified in the data sheet. The command is not available if FFT filtering is switched on and the set bandwidth is ≤ 30 kHz or if the quasi-peak detector is switched on.

The numeric suffixes <1|2> are not relevant.

Parameter

refer to data sheet

Example

```
BAND:VID 10kHz
```

Characteristics

*RST value: - (AUTO is set to ON)

SCPI: conform

Mode

A, CATV, EVDO

[SENSe<1|2>:]BANDwidth|BWIDth:VIDeo:AUTO

This command either automatically couples the instruments video bandwidth to the resolution bandwidth or cancels the coupling.

The ratio video bandwidth/resolution bandwidth can be modified with the [\[SENSe<1|2>:\]BANDwidth|BWIDth\[:RESolution\]:RATio](#) command.

The numeric suffixes <1|2> are not relevant.

Parameter

ON | OFF

Example

```
BAND:VID:AUTO OFF
```

Characteristics

*RST value: ON

SCPI: conform

Mode

A, CATV, CDMA, EVDO

[SENSe<1|2>:]BANDwidth|BWIDth:VIDeo:RATio

This command defines the ratio video bandwidth (Hz) / resolution bandwidth (Hz). The ratio to be entered is reciprocal to the ratio RBW/VBW used in manual operation.

The numeric suffixes <1|2> are not relevant.

Parameter

0.01 to 1000

Example

```
BAND:VID:RAT 3
```

Sets the coupling of video bandwidth to video bandwidth = 3*resolution bandwidth

Characteristics

*RST value: 3

SCPI: conform

Mode

A, EVDO

[SENSe<1|2>:]BANDwidth|BWIDth:VIDeo:TYPE

This command selects the position of the video filter in the signal path, provided that the resolution bandwidth is ≤ 100 kHz.

The essential difference between the two modes is the transient response at falling signal edges: If LINear is selected, the measurement with logarithmic level scaling yields a much "flatter" falling edge than LOGarithmic. This behavior is due to the conversion of linear power into logarithmic level. If the linear power is halved, the level decreases by only 3 dB.

The numeric suffixes <1|2> are not relevant.

Parameter

LINear The video filter is connected ahead of the logarithmic amplifier (default).

LOGarithmic The video filter follows the logarithmic amplifier

Example

```
BAND:VID:TYPE LIN
```

Video filter ahead of the logarithmic amplifier

Characteristics

RST value: LIN

SCPI: device-specific

Mode

A, CDMA, EVDO

SENSe:CORRection Subsystem (Models with tracking generator)

This subsystem controls calibration and normalization during operation with the tracking generator.

Commands of the SENSe:CORRection Subsystem

- [SENSe<1|2>:]CORRection[:STATe]
- [SENSe<1|2>:]CORRection:COLLect[:ACQuire]
- [SENSe<1|2>:]CORRection:EGAIN:INPut[:MAGNitude]
- [SENSe<1|2>:]CORRection:METhod
- [SENSe<1|2>:]CORRection:RECall
- [SENSe<1|2>:]CORRection:TRANsdUcer[:STATe]
- [SENSe<1|2>:]CORRection:TRANsdUcer:ADJust:RLEVel[:STATe]
- [SENSe<1|2>:]CORRection:TRANsdUcer:COMMent
- [SENSe<1|2>:]CORRection:TRANsdUcer:DATA
- [SENSe<1|2>:]CORRection:TRANsdUcer:DELeTe
- [SENSe<1|2>:]CORRection:TRANsdUcer:SCALing
- [SENSe<1|2>:]CORRection:TRANsdUcer:SELeCt
- [SENSe<1|2>:]CORRection:TRANsdUcer:UNIT
- [SENSe<1|2>:]CORRection:TRANsdUcer:VIEW

[SENSe<1|2>:]CORRection[:STATe]

This command activates/deactivates the normalization of the measurement results provided that the tracking generator is active. The command is available only after acquisition of a reference trace for the selected type of measurement (transmission/reflection, see [SENSe<1|2>:]CORRection:COLLect[:ACQuire] command).

The numeric suffixes <1|2> are not relevant.

Parameter

ON | OFF

Example

CORR ON
Activates normalization.

Characteristics

*RST value: OFF

SCPI: conform

Mode

A

[SENSe<1|2>:]CORRection:COLLect[:ACQuire]

When the tracking generator is active, this command determines the type of result acquisition for the normalization reference measurement and starts the measurement selected:

To obtain a correct reference measurement, a complete sweep with synchronization to the end of the sweep must have been carried out. This is only possible in the single sweep mode.

The numeric suffixes <1|2> are not relevant.

This command is an "event" and therefore has no *RST value and no query.

Parameter

THRough	"TRANsmission" mode	calibration with direct connection between tracking generator and device input
	"REFLection" mode	calibration with short circuit at the input
OPEN	only allowed in "REFLection" mode	calibration with open input

Example

```
INIT:CONT OFF
```

Selects single sweep operation

```
CORR:COLL THR;*WAI
```

Starts the measurement of reference data using direct connection between generator and device input and waits for the sweep end.

Characteristics

*RST value: -

SCPI: conform

Mode

A

[SENSe<1|2>:]CORRection:EGAIN:INPut[:MAGNitude]

This command makes an external gain known to the analyzer, which will take it into account during the display of measurement results. With this function the gain of an antenna or of an external preamplifier can be taken into account for the measurement values.

The numeric suffixes <1|2> are not relevant.

Parameter

-200...200dB

Example

```
CORR:EGA:INP 10DB
```

Takes 10 dB external gain into account.

Characteristics

*RST value: 0 dB

SCPI: device-specific

Mode

A

[SENSe<1|2>:]CORRection:METHod

This command selects the type of measurement with active tracking generator (transmission/reflection).

The numeric suffixes <1|2> are not relevant.

Parameter

TRANsmission | REFLection

Example

CORR:METH TRAN

Sets the type of measurement to "transmission".

Characteristics

*RST value: TRANsmision

SCPI: device-specific

Mode

A

[SENSe<1|2>:]CORRection:RECall

This command restores the instrument setting that was applied to the measurement of the reference data, provided that the tracking generator is active.

The numeric suffixes <1|2> are not relevant.

This command is an event and therefore has no *RST value and no query.

Example

CORR:REC

Characteristics

*RST value: -

SCPI: conform

Mode

A

[SENSe<1|2>:]CORRection:TRANsducer[:STATe]

This command switches the selected transducer factor on or off.

Note: Prior to this command, the `[SENSe<1|2>:]CORRection:TRANsducer:SElect` command must be sent.

This command is available from firmware version 1.10.

Parameter

ON | OFF

Example

CORR:TRAN ON

Characteristics

*RST value: OFF

SCPI: device-specific

Mode A**[SENSe<1|2>:]CORRection:TRANsducer:ADJust:RLEVel[:STATe]**

This command switches the automatic adjustment of the reference level to the selected transducer factor on or off. For details refer to chapter 4, section "Instrument Setup and Interface Configuration - SETUP Key", **Ref Level Adjust Man/Auto** softkey.

Note: Prior to this command, the `[SENSe<1|2>:]CORRection:TRANsducer:SElect` command must be sent.

This command is available from firmware version 1.10.

Parameter

ON | OFF

Example

```
CORR:TRAN:ADJ:RLEV ON
```

Characteristics

*RST value: OFF

SCPI: device-specific

Mode

A

[SENSe<1|2>:]CORRection:TRANsducer:COMMeNt

This command defines the comment for the selected transducer factor.

Note: Prior to this command, the [SENSe<1|2>:]CORRection:TRANsducer:SELeCt command must be sent.

This command is available from firmware version 1.10.

Parameter

<string>

Example

```
CORR:TRAN:COMM 'FACTOR FOR ANTENNA'
```

Characteristics

*RST value: (empty comment)

SCPI: device-specific

Mode A

[SENSe<1|2>:]CORRection:TRANsducer:DATA

This command defines the reference values of the transducer factor selected. These values are entered as a sequence of frequency/level pairs. The frequencies must be sent in ascending order.

Note: Prior to this command, the [SENSe<1|2>:]CORRection:TRANsducer:SELeCt command must be sent. The level values are sent as dimensionless numbers; the unit is specified by means of the [SENSe<1|2>:]CORRection:TRANsducer:UNIT command.

This command is available from firmware version 1.10.

Parameter

<freq>, <level>

Example

```
SENS:CORR:TRAN:SEL 'TRAN_1'
```

Selects the transducer factor

```
CORR:TRAN:UNIT 'DB'
```

Selects the unit for the transducer.

```
CORR:TRAN:DATA 1MHZ,-30,2MHZ,-40
```

Defines the frequency/level pairs 1 MHz, -30 dB and 2 MHz, -40 dB.

Characteristics

*RST value: -

SCPI: device-specific

Mode

A

[SENSe<1|2>:]CORRection:TRANsducer:DELeTe

This command deletes the selected transducer factor.

This command is an event and therefore has no *RST value.

Note: *Prior to this command, the [SENSe<1|2>:]CORRection:TRANsducer:SELeT command must be sent.*

This command is available from firmware version 1.10.

Example

CORR:TRAN:DEL

Characteristics

*RST value: -

SCPI: device-specific

Mode

A

[SENSe<1|2>:]CORRection:TRANsducer:SCALing

This command defines whether the frequency scaling of the transducer factor is linear or logarithmic.

Note: *Prior to this command, the [SENSe<1|2>:]CORRection:TRANsducer:SELeT command must be sent.*

This command is available from firmware version 1.10.

Parameter

LINear | LOGarithmic

Example

CORR:TRAN:SCAL LOG

Characteristics

*RST value: LINear

SCPI: device-specific

Mode

A

[SENSe<1|2>:]CORRection:TRANsducer:SELeT

This command selects the transducer factor designated by <name>. If <name> does not exist yet, a new transducer factor is created.

Note: *This command must be sent prior to the subsequent commands for modifying/activating transducer factors.*

This command is available from firmware version 1.10.

Parameter

<name> = Name of the transducer factor in string data form with a maximum of 8 characters.

Example

```
CORR:TRAN:SEL 'FACTOR1'
```

Characteristics

*RST value: -

SCPI: device-specific

Mode

A

[SENSe<1|2>:]CORRection:TRANsducer:UNIT

This command defines the unit of the transducer factor selected.

Note: Prior to this command, the `[SENSe<1|2>:]CORRection:TRANsducer:SElect` command must be sent.

This command is available from firmware version 1.10.

Parameter

<string> = DB | DBM | DBMV | DBUV | DBUV/M | DBUA DBUA/M | DBPW | DBPT

Example

```
CORR:TRAN:UNIT 'DBUV'
```

Characteristics

*RST value: DB

SCPI: device-specific

Mode

A

[SENSe<1|2>:]CORRection:TRANsducer:VIEW

This command switches on the display of the active transducer factor or set.

Note: Prior to this command, the `[SENSe<1|2>:]CORRection:TRANsducer:SElect` command must be sent.

This command is available from firmware version 1.10.

Parameter

ON | OFF

Example

```
CORR:TRAN:VIEW ON
```

Characteristics

*RST value: OFF

SCPI: device-specific

Mode

A

SENSe:DETECTOR Subsystem

The SENSe:DETECTOR subsystem controls the acquisition of measurement data via the selection of the detector for the corresponding trace.

Commands of the SENSe:DETECTOR Subsystem

- [SENSe<1|2>:]DETECTOR<1...6>[:FUNCTION]
- [SENSe<1|2>:]DETECTOR<1...6>[:FUNCTION]:AUTO

[SENSe<1|2>:]DETECTOR<1...6>[:FUNCTION]

This command switches on the detector for the data acquisition in the selected trace.

The trace is indicated as numeric suffix in DETECTOR.

The numeric suffixes <1|2> are not relevant.

Parameter

APEak | NEGative | POSitive | SAMPlE | RMS | AVERAge | QPEak

For details on detectors refer to chapter "Instrument Functions", section "Detector overview".

Example

```
DET POS
```

Sets the detector to "positive peak".

Characteristics

*RST value: APEak

SCPI: conform

Mode

A, CATV

[SENSe<1|2>:]DETECTOR<1...6>[:FUNCTION]:AUTO

This command either couples the detector to the current trace setting or turns coupling off. The trace is selected by the numeric suffix at DETECTOR.

The numeric suffixes <1|2> are not relevant.

Parameter

ON | OFF

Example

```
DET:AUTO OFF
```

Characteristics

*RST value: ON

SCPI: conform

Mode

A, CATV

SENSe:ESpectrum Subsystem

The SENSe:ESpectrum subsystem contains the remote commands to configure Spectrum Emission Mask (SEM) measurements.

Commands of the SENSe:ESpectrum Subsystem

- [SENSe<1|2>:]ESpectrum:BWID
- [SENSe<1|2>:]ESpectrum:FILTer[:RRC][:STATe]
- [SENSe<1|2>:]ESpectrum:FILTer[:RRC]:ALPHa
- [SENSe<1|2>:]ESpectrum:PRESet[:STANdard]
- [SENSe<1|2>:]ESpectrum:PRESet:REStore
- [SENSe<1|2>:]ESpectrum:PRESet:StORe
- [SENSe<1|2>:]ESpectrum:RANGe<1...20>:BANDwidth
- [SENSe<1|2>:]ESpectrum:RANGe<1...20>:BANDwidth:RESolution
- [SENSe<1|2>:]ESpectrum:RANGe<1...20>:BANDwidth:VIDeo
- [SENSe<1|2>:]ESpectrum:RANGe<1...20>:COUNt?
- [SENSe<1|2>:]ESpectrum:RANGe<1...20>:DELete
- [SENSe<1|2>:]ESpectrum:RANGe<1...20>[:FREQuency]:StARt
- [SENSe<1|2>:]ESpectrum:RANGe<1...20>[:FREQuency]:StOP
- [SENSe<1|2>:]ESpectrum:RANGe<1...20>:FILTer:TYPE
- [SENSe<1|2>:]ESpectrum:RANGe<1...20>:INPut:ATTenuation
- [SENSe<1|2>:]ESpectrum:RANGe<1...20>:INPut:ATTenuation:AUTO
- [SENSe<1|2>:]ESpectrum:RANGe<1...20>:INPut:GAIN:STATe
- [SENSe<1|2>:]ESpectrum:RANGe<1...20>:INSert
- [SENSe<1|2>:]ESpectrum:RANGe<1...20>:LIMit:ABSolute:StARt
- [SENSe<1|2>:]ESpectrum:RANGe<1...20>:LIMit:ABSolute:StOP
- [SENSe<1|2>:]ESpectrum:RANGe<1...20>:LIMit:RELative:StARt
- [SENSe<1|2>:]ESpectrum:RANGe<1...20>:LIMit:RELative:StOP
- [SENSe<1|2>:]ESpectrum:RANGe<1...20>:LIMit:STATe
- [SENSe<1|2>:]ESpectrum:RANGe<1...20>:RLEVel
- [SENSe<1|2>:]ESpectrum:RANGe<1...20>:SWEep:TIME
- [SENSe<1|2>:]ESpectrum:RANGe<1...20>:SWEep:TIME:AUTO
- [SENSe<1|2>:]ESpectrum:RANGe<1...20>:TRANsducer
- [SENSe<1|2>:]ESpectrum:RRANGe?
- [SENSe<1|2>:]ESpectrum:RTYPE

[SENSe<1|2>:]ESpectrum:BWID

This command defines the bandwidth used for measuring the channel power (reference range). This setting takes only effect if channel power is selected as power reference type (`[SENSe<1|2>:]ESpectrum:RTYPE` command).
The numeric suffixes <1|2> are not relevant.
This command is available from firmware version 1.80.

Parameter

minimum span \leq value \leq span of reference range

Example

```
ESP:RTYP CPOW
Sets the power reference type to channel power.
ESP:BWID 1MHZ
Sets the Tx bandwidth to 1 MHz.
```

Characteristics

RST value: 3.84 MHz
SCPI: device-specific

Mode

A, CDMA, EVDO

[SENSe<1|2>:]ESpectrum:FILTer[:RRC][:STATE]

This command activates or deactivates the use of an RRC filter. This setting takes only effect if channel power is selected as power reference type (`[SENSe<1|2>:]ESpectrum:RTYPE` command).
The numeric suffixes <1|2> are not relevant.
This command is available from firmware version 1.80.

Parameter

ON | OFF

Example

```
ESP:RTYP CPOW
Sets the power reference type to channel power.
ESP:FILT OFF
Deactivates the use of an RRC filter.
```

Characteristics

RST value: ON
SCPI: device-specific

Mode

A, CDMA, EVDO

[SENSe<1|2>:]ESpectrum:FILTer[:RRC]:ALPHA

This command sets the alpha value of the RRC filter. This setting takes only effect if channel power is selected as power reference type (`[SENSe<1|2>:]ESpectrum:RTYPE` command) and if the RRC filter is activated (`[SENSe<1|2>:]ESpectrum:FILTer[:RRC][:STATE]` command).

The numeric suffixes <1|2> are not relevant.
This command is available from firmware version 1.80.

Parameter

0 to 1

Example

```
ESP:RTYP CPOW
```

Sets the power reference type to channel power.

```
ESP:FILT ON
```

Activates the use of an RRC filter.

```
ESP:FILT:ALPH 0.5
```

Sets the alpha value of the RRC filter to 0.5.

Characteristics

RST value: 0.22

SCPI: device-specific

Mode

A, CDMA, EVDO

[SENSe<1|2>:]ESpectrum:PRESet[:STANdard]

This command selects the specified XML file under `C:\r_s\instr\sem_std`. If the file is stored in a subdirectory, include the relative path.

The numeric suffixes <1|2> are not relevant.

This command is an event and therefore has no *RST value and no query.

This command is available from firmware version 1.80.

Example

```
ESP:PRES 'WCDMA\3GPP\DL\PowerClass_31_39.xml'
```

Selects the `PowerClass_31_39.xml` XML file in the `C:\R_S\instr\sem_std\WCDMA\3GPP\DL` directory.

```
ESP:PRES?
```

```
W-CDMA 3GPP DL (31,39) dBm
```

The query returns information about the selected standard, the link direction and the power class. If no standard has been selected, the query returns *None*.

Characteristics

RST value: -

SCPI: device-specific

Mode

A, CDMA, EVDO

[SENSe<1|2>:]ESpectrum:PRESet:REStore

This command copies the XML files from the `C:\R_S\instr\sem_backup` folder to the `C:\R_S\instr\sem_std` folder. Files of the same name are overwritten.

The numeric suffixes <1|2> are not relevant.

This command is an event and therefore has no *RST value and no query.

This command is available from firmware version 1.80.

Example

```
ESP: PRES: REST
```

Restores the originally provided XML files.

Characteristics

RST value: -

SCPI: device-specific

Mode

A, CDMA, EVDO

[SENSe<1|2>:]ESpectrum:PRESet:STORe

This command saves the specified XML file under *C:\r_sl\instr\sem_std*. To save the file in subdirectory, include the relative path.

The numeric suffixes <1|2> are not relevant.

This command is an event and therefore has no *RST value and no query.

Example

```
ESP: STOR 'DL\BandClass_20.xml'
```

Saves the *BandClass_20.xml* XML file in the *C:\R_S\instr\sem_std\DL* directory.

Characteristics

RST value: -

SCPI: device-specific

Mode

A, CDMA, EVDO

**[SENSe<1|2>:]ESpectrum:RANGe<1...20>:BANDwidth /
[SENSe<1|2>:]ESpectrum:RANGe<1...20>:BANDwidth:RESolution**

This command sets the RBW value for the specified range.

The numeric suffixes <1...20> specify the range. The numeric suffixes <1|2> are not relevant.

This command is available from firmware version 1.80.

Parameter

Refer to the data sheet.

Example

```
ESP: RANG2: BAND: RES 5000
```

Sets the RBW for range 2 to 5 kHz.

Characteristics

RST value: 30.0 kHz

SCPI: device-specific

Mode

A, CDMA, EVDO

[SENSe<1|2>:]ESpectrum:RANGe<1...20>:BANDwidth:VIDeo

This command sets the VBW value for the specified range.
 The numeric suffixes <1...20> specify the range. The numeric suffixes <1|2> are not relevant.
 This command is available from firmware version 1.80.

Parameter

Refer to the data sheet.

Example

```
ESP:RANG1:BAND:VID 5000000
```

Sets the VBW for range 1 to 5 MHz.

Characteristics

RST value: 10.0 MHz
 SCPI: device-specific

Mode

A, CDMA, EVDO

[SENSe<1|2>:]ESpectrum:RANGe<1...20>:COUNT?

This command returns the number of defined ranges.
 The numeric suffixes are not relevant.
 This command is only a query and therefore has no *RST value.
 This command is available from firmware version 1.80.

Example

```
ESP:RANG:COUNT?
```

Returns the number of defined ranges.

Characteristics

RST value: -
 SCPI: device-specific

Mode

A, CDMA, EVDO

[SENSe<1|2>:]ESpectrum:RANGe<1...20>:DELeTe

This command deletes the specified range. The range numbers are updated accordingly. The reference range cannot be deleted. A minimum of three ranges is mandatory.
 The numeric suffixes <1...20> specify the range. The numeric suffixes <1|2> are not relevant.
 This command is an event and therefore has no *RST value and no query.
 This command is available from firmware version 1.80.

Example

```
ESP:RANG4:DEL
```

Deletes range 4.

Characteristics

RST value: -
 SCPI: device-specific

Mode

A, CDMA, EVDO

[SENSe<1|2>:]ESpectrum:RANGe<1...20>[:FREQUENCY]:STARt

This command sets the start frequency for the specified range.

In order to change the start/stop frequency of the first/last range, select the appropriate span. If you set a span that is smaller than the overall span of the ranges, the measurement includes only the ranges that lie within the defined span and have a minimum span of 20 Hz. The first and last range are adapted to the given span as long as the minimum span of 20 Hz is not violated.

The numeric suffixes <1...20> specify the range. The numeric suffixes <1|2> are not relevant. This command is available from firmware version 1.80.

Parameter

see rules in chapter 4, "Ranges and settings"

Example

```
ESP:RANG1:STAR 100000000
```

Sets the start frequency for range 1 to 100 MHz.

Characteristics

RST value: -250.0 MHz (range 1), -2.52 MHz (range 2), 2.52 MHz (range 3)

SCPI: device-specific

Mode

A, CDMA, EVDO

[SENSe<1|2>:]ESpectrum:RANGe<1...20>[:FREQUENCY]:STOP

This command sets the stop frequency for the specified range. For further details refer to the [\[SENSe<1|2>:\]ESpectrum:RANGe<1...20>\[:FREQUENCY\]:STARt](#) command.

The numeric suffixes <1...20> specify the range. The numeric suffixes <1|2> are not relevant. This command is available from firmware version 1.80.

Parameter

see rules in chapter 4, "Ranges and settings"

Example

```
ESP:RANG3:STOP 10000000
```

Sets the stop frequency for range 2 to 10 MHz.

Characteristics

RST value: -2.52 MHz (range 1), 2.52 MHz (range 2), 250.0 MHz (range 3)

SCPI: device-specific

Mode

A, CDMA, EVDO

[SENSe<1|2>:]ESpectrum:RANGe<1...20>:FILTer:TYPE

This command sets the filter type for the specified range.

The numeric suffixes <1...20> specify the range. The numeric suffixes <1|2> are not relevant. This command is available from firmware version 1.80.

Parameter

NORMal	Gaussian filters
CFILter	channel filters
RRC	RRC filters
PULSe	EMI (6dB) filters

The available bandwidths of the filters are specified in the data sheet.

Example

```
ESP:RANG1:FILT:TYPE RRC
```

Sets the RRC filter type for range 1.

Characteristics

RST value: NORM
SCPI: device-specific

Mode

A, CDMA, EVDO

[SENSe<1|2>:]ESpectrum:RANGe<1...20>:INPut:ATTenuation

This command sets the attenuation for the specified range.
The numeric suffixes <1...20> specify the range. The numeric suffixes <1|2> are not relevant.
This command is available from firmware version 1.80.

Parameter

Refer to the data sheet.

Example

```
ESP:RANG3:INP:ATT 10
```

Sets the attenuation of range 3 to 10 dB.

Characteristics

RST value: 0 dB
SCPI: device-specific

Mode

A, CDMA, EVDO

[SENSe<1|2>:]ESpectrum:RANGe<1...20>:INPut:ATTenuation:AUTO

This command activates or deactivates the automatic RF attenuation setting for the specified range.
The numeric suffixes <1...20> specify the range. The numeric suffixes <1|2> are not relevant.
This command is available from firmware version 1.80.

Parameter

ON | OFF

Example

```
ESP:RANG2:INP:ATT:AUTO OFF
```

Deactivates the RF attenuation auto mode for range 2.

Characteristics

RST value: ON

SCPI: device-specific

Mode

A, CDMA, EVDO

[SENSe<1|2>:]ESpectrum:RANGe<1...20>:INPut:GAIN:STATe

This command switches the preamplifier on or off for the specified range.

The numeric suffixes <1...20> specify the range. The numeric suffixes <1|2> are not relevant.

This command is available from firmware version 1.80.

Parameter

ON | OFF

Example

```
ESP:RANG3:INP:GAIN:STATe ON
```

Switches the preamplifier for range 3 on or off.

Characteristics

RST value: OFF

SCPI: device-specific

Mode

A, CDMA, EVDO

[SENSe<1|2>:]ESpectrum:RANGe<1...20>:INSert

This command inserts a new range before or after the specified range. The range numbers are updated accordingly.

The numeric suffixes <1...20> specify the range. The numeric suffixes <1|2> are not relevant.

This command is available from firmware version 1.80.

Parameter

AFTer | BEFore

Example

```
ESP:RANG3:INS BEF
```

Inserts a new range before range 3.

```
ESP:RANG1:INS AFT
```

Inserts a new range after range 1.

Characteristics

RST value:

SCPI: device-specific

Mode

A, CDMA, EVDO

[SENSe<1|2>:]ESpectrum:RANGe<1...20>:LIMit:ABSolute:STARt

This command sets an absolute limit value at the start frequency of the specified range. Different from manual operation, this setting is independently of the defined limit check type. The numeric suffixes <1...20> specify the range. The numeric suffixes <1|2> are not relevant. This command is available from firmware version 1.80.

Parameter

-400 to in 400 dBm

Example

```
ESP:RANG1:LIM:ABS:STAR 10
```

Sets an absolute limit of 10 dBm at the start frequency of the range.

Characteristics

RST value: -13 dBm

SCPI: device-specific

Mode

A, CDMA, EVDO

[SENSe<1|2>:]ESpectrum:RANGe<1...20>:LIMit:ABSolute:STOP

This command sets an absolute limit value at the stop frequency of the specified range. Different from manual operation, this setting is independently of the defined limit check type. The numeric suffixes <1...20> specify the range. The numeric suffixes <1|2> are not relevant. This command is available from firmware version 1.80.

Parameter

-400 to in 400 dBm

Example

```
ESP:RANG1:LIM:ABS:STOP 20
```

Sets an absolute limit of 20 dBm at the stop frequency of the range.

Characteristics

RST value: -13 dBm

SCPI: device-specific

Mode

A, CDMA, EVDO

[SENSe<1|2>:]ESpectrum:RANGe<1...20>:LIMit:RELative:STARt

This command sets a relative limit value at the start frequency of the specified range. Different from manual operation, this setting is independently of the defined limit check type. The numeric suffixes <1...20> specify the range. The numeric suffixes <1|2> are not relevant. This command is available from firmware version 1.80.

Parameter

-400 to in 400 dBc

Example

```
ESP:RANG3:LIM:REL:STAR -20
```

Sets a relative limit of -20 dBc at the start frequency of the range.

Characteristics

RST value: -50 dBc

SCPI: device-specific

Mode

A, CDMA, EVDO

[SENSe<1|2>:]ESpectrum:RANGe<1...20>:LIMit:RELative:STOP

This command sets a relative limit value at the stop frequency of the specified range. Different from manual operation, this setting is independently of the defined limit check type.

The numeric suffixes <1...20> specify the range. The numeric suffixes <1|2> are not relevant.

This command is available from firmware version 1.80.

Parameter

-400 to in 400 dBc

Example

```
ESP:RANG3:LIM:REL:STOP 20
```

Sets a relative limit of 20 dBc at the stop frequency of the range.

Characteristics

RST value: -50 dBc

SCPI: device-specific

Mode

A, CDMA, EVDO

[SENSe<1|2>:]ESpectrum:RANGe<1...20>:LIMit:STATe

This command sets the type of limit check for all ranges.

The numeric suffixes are not relevant.

This command is available from firmware version 1.80.

Parameter

ABSolute	Checks only the absolute limits defined.
RELative	Checks only the relative limits. Relative limits are defined as relative to the measured power in the reference range.
AND	Combines the absolute and relative limit. The limit check fails when both limits are violated.
OR	Combines the absolute and relative limit. The limit check fails when one of the limits is violated.

Example

```
ESP:RANG3:LIM:STAT AND
```

Sets for all ranges the combined absolute/relative limit check.

Characteristics

RST value: REL

SCPI: device-specific

Mode

A, CDMA, EVDO

[SENSe<1|2>:]ESpectrum:RANGe<1...20>:RLEVel

This command sets the reference level for the specified range.
 The numeric suffixes <1...20> specify the range. The numeric suffixes <1|2> are not relevant.
 This command is available from firmware version 1.80.

Parameter

Refer to the data sheet.

Example

```
ESP:RANG2:RLEV 0
```

Sets the reference level of range 2 to 0 dBm.

Characteristics

RST value: -20 dBm

SCPI: device-specific

Mode

A, CDMA, EVDO

[SENSe<1|2>:]ESpectrum:RANGe<1...20>:SWEep:TIME

This command sets the sweep time for the specified range.
 The numeric suffixes <1...20> specify the range. The numeric suffixes <1|2> are not relevant.
 This command is available from firmware version 1.80.

Parameter

Allowed values depend on the ratio of span to RBW and RBW to VBW. For details refer to the data sheet.

Example

```
ESP:RANG1:SWE:TIME 1
```

Sets the sweep time for range 1 to 1 s.

Characteristics

RST value: 0.27 s

SCPI: device-specific

Mode

A, CDMA, EVDO

[SENSe<1|2>:]ESpectrum:RANGe<1...20>:SWEep:TIME:AUTO

This command activates or deactivates the automatic sweep time setting for the specified range.
 The numeric suffixes <1...20> specify the range. The numeric suffixes <1|2> are not relevant.
 This command is available from firmware version 1.80.

Parameter

ON | OFF

Example

```
ESP:RANG3:SWE:TIME:AUTO OFF
```

Deactivates the sweep time auto mode for range 3.

Characteristics

RST value: ON

SCPI: device-specific

Mode

A, CDMA, EVDO

[SENSe<1|2>:]ESpectrum:RANGe<1...20>:TRANsducer

This command sets a transducer for the specified range. You can only choose a transducer that fulfills the following conditions:

- The transducer overlaps or equals the span of the range.
- The x-axis is linear.
- The unit is dB.

The numeric suffixes <1...20> specify the range. The numeric suffixes <1|2> are not relevant. This command is available from firmware version 1.80.

Parameter

'string' = name of the transducer

Example

```
ESP:RANG1:TRAN 'test'
```

Sets the transducer called test for range 1.

Characteristics

RST value: -

SCPI: device-specific

Mode

A, CDMA, EVDO

[SENSe<1|2>:]ESpectrum:RRANGe?

This command returns the current position (number) of the reference range.

The numeric suffixes <1|2> are not relevant.

This command is only a query and therefore has no *RST value.

This command is available from firmware version 1.80.

Example

```
ESP:RRAN?
```

Returns the current position (number) of the reference range.

Characteristics

RST value: -

SCPI: device-specific

Mode

A, CDMA, EVDO

[SENSe<1|2>:]ESpectrum:RTYPe

This command sets the power reference type.
The numeric suffixes <1|2> are not relevant.
This command is available from firmware version 1.80.

Parameter

PEAK Measures the highest peak within the reference range.
CPOWer Measures the channel power within the reference range (integral bandwidth method).

Example

```
ESP:RTYP PEAK
```

Sets the peak power reference type.

Characteristics

RST value: CPOWer
SCPI: device-specific

Mode

A, CDMA, EVDO

SENSe:FREQUENCY Subsystem

The SENSe:FREQUENCY subsystem defines the frequency axis of the active display. The frequency axis can either be defined via the start/stop frequency or via the center frequency and span.

Commands of the SENSe:FREQUENCY Subsystem

- [SENSe<1|2>:]FREQUENCY:CENTer
- [SENSe<1|2>:]FREQUENCY:CENTer:STEP
- [SENSe<1|2>:]FREQUENCY:CENTer:STEP:AUTO
- [SENSe<1|2>:]FREQUENCY:CENTer:STEP:LINK
- [SENSe<1|2>:]FREQUENCY:CENTer:STEP:LINK:FACTor
- [SENSe<1|2>:]FREQUENCY:MODE
- [SENSe<1|2>:]FREQUENCY:OFFSet
- [SENSe<1|2>:]FREQUENCY:SPAN
- [SENSe<1|2>:]FREQUENCY:SPAN:FULL
- [SENSe<1|2>:]FREQUENCY:START
- [SENSe<1|2>:]FREQUENCY:STOP

[SENSe<1|2>:]FREQUENCY:CENTer

This command defines the center frequency of the analyzer or the measuring frequency for span = 0.

The numeric suffixes <1|2> are not relevant.

Parameter

0 to f_{max}

f_{max} is specified in the data sheet. To help analyze signals located at the end of the frequency range, for R&S FSL models with an upper frequency limit of 6 GHz or less, the f_{max} value is extended by 0.05 GHz for direct entry. The preset and maximum values remain unchanged.

Example

```
FREQ:CENT 100MHz
```

Characteristics

*RST value: $f_{max} / 2$ with f_{max} = maximum frequency

SCPI: conform

Mode

all

[SENSe<1|2>:]FREQUENCY:CENTer:STEP

This command defines the step size of the center frequency.

The numeric suffixes <1|2> are not relevant.

Parameter

0 to f_{max}

Example

```
FREQ:CENT:STEP 120MHz
```

Characteristics

*RST value: - (AUTO 0.1 × SPAN is switched on)

SCPI: conform

Mode

all

[SENSe<1|2>:]FREQuency:CENTer:STEP:AUTO

This command couples the step size of the center frequency to the span (ON) or sets the value of the center frequency entered via [SENSe<1|2>:]FREQuency:CENTer:STEP (OFF).

The numeric suffixes <1|2> are not relevant.

Parameter

ON | OFF

Example

```
FREQ:CENT:STEP:AUTO ON
```

Activates the coupling of the step size to the span.

Characteristics

*RST value: ON

SCPI: device-specific

Mode

all

[SENSe<1|2>:]FREQuency:CENTer:STEP:LINK

This command couples the step size of the center frequency to span (span >0) or to the resolution bandwidth (span = 0) or cancels the couplings.

The numeric suffixes <1|2> are not relevant.

Parameter

SPAN coupling to frequency display range (for span > 0)

RBW coupling to resolution bandwidth (for span = 0)

OFF manual input, no coupling

Example

```
FREQ:CENT:STEP:LINK SPAN
```

Characteristics

*RST value: SPAN

SCPI: device-specific

Mode

A, ADEMOD, CDMA, EVDO

[SENSe<1|2>:]FREQUency:CENTer:STEP:LINK:FACTor

This command couples the step size of the center frequency with a factor to the span (span >0) or to the resolution bandwidth (span = 0).

The numeric suffixes <1|2> are not relevant.

Parameter

1 to 100 PCT

Example

```
FREQ:CENT:STEP:LINK:FACT 20PCT
```

Characteristics

*RST value: - (AUTO 0.1 × SPAN is switched on)

SCPI: device-specific

Mode

A, CDMA, EVDO

[SENSe<1|2>:]FREQUency:MODE

This command switches between span > 0 (SWEep) and zero span (CW | FIXed) in the **Spectrum Analyzer** mode.

For CW and FIXed, the frequency setting is via the `[SENSe<1|2>:]FREQUency:CENTer` command. In the sweep mode, the setting is via the `[SENSe<1|2>:]FREQUency:START`, `[SENSe<1|2>:]FREQUency:STOP`, `[SENSe<1|2>:]FREQUency:CENTer`, and `[SENSe<1|2>:]FREQUency:SPAN` commands.

The numeric suffixes <1|2> are not relevant.

Parameter

CW | FIXed | SWEep | SCAN

Example

```
FREQ:MODE SWE
```

Characteristics

*RST value: SWEep

SCPI: conform

Mode

A, CDMA

[SENSe<1|2>:]FREQUency:OFFSet

This command defines the frequency offset of the instrument.

The numeric suffixes <1|2> are not relevant.

Parameter

-100 GHz to 100 GHz

Example

```
FREQ:OFFS 1GHZ
```

Characteristics

*RST value: 0 Hz

SCPI: conform

Mode

A, ADEMOD, CDMA, EVDO, WCDMA

[SENSe<1|2>:]FREQUENCY:SPAN

This command defines the frequency span in the **Spectrum Analyzer** mode.
The numeric suffixes <1|2> are not relevant.

Parameter

0 to f_{max}

f_{max} is specified in the data sheet. To help analyze signals located at the end of the frequency range, for R&S FSL models with an upper frequency limit of 6 GHz or less, the f_{max} value is extended by 0.05 GHz for direct entry. The preset and maximum values remain unchanged.

Example

```
FREQ:SPAN 10MHz
```

Characteristics

*RST value: f_{max} with f_{max} = maximum frequency

SCPI: conform

Mode

A, CATV, CDMA, EVDO

[SENSe<1|2>:]FREQUENCY:SPAN:FULL

This command sets the frequency span to its maximum.
The numeric suffixes <1|2> are not relevant.

Parameter

f_{max} , specified in the data sheet.

Example

```
FREQ:SPAN:FULL
```

Characteristics

*RST value: -

SCPI: conform

Mode

A, CATV, CDMA, EVDO

[SENSe<1|2>:]FREQUENCY:START

This command defines the start frequency of the analyzer. This command is only available with span > 0.

The numeric suffixes <1|2> are not relevant.

Parameter

0 to f_{max}

f_{max} is specified in the data sheet. To help analyze signals located at the end of the frequency range, for R&S FSL models with an upper frequency limit of 6 GHz or less, the f_{max} value is extended by 0.05 GHz for direct entry. The preset and maximum values remain unchanged.

Example

FREQ:STAR 20MHz

Characteristics

*RST value: 0

SCPI: conform

ModeA-F, CATV, CDMA, EVDO

[SENSe<1|2>:]FREQuency:STOP

This command defines the stop frequency of the analyzer. This command is only available with span > 0.

The numeric suffixes <1|2> are not relevant.

Parameter0 to f_{max}

f_{max} is specified in the data sheet. To help analyze signals located at the end of the frequency range, for R&S FSL models with an upper frequency limit of 6 GHz or less, the f_{max} value is extended by 0.05 GHz for direct entry. For the R&S FSL18 model, the f_{max} value is extended to 20 GHz. The preset and maximum values remain unchanged.

For the R&S FSL18, the query returns a maximum frequency of 20 GHz.

Example

FREQ:STOP 2000MHz

Characteristics*RST value: f_{max}

SCPI: conform

ModeA-F, CATV, CDMA, EVDO

SENSe:LIST Subsystem

The commands of this subsystem are used for measuring the power at a list of frequency points with different device settings. The measurement is always performed in zero span. A new trigger event is required for each test point (exception: trigger FREE RUN).

The results are output as a list in the order of the entered frequency points. The number of results per test point depends on the number of concurrently active measurements (peak/RMS/average). The number of frequencies is limited to 100 entries.

Selection of concurrently active measurements and setting of parameters that are constant for the whole measurement is performed via a configuration command (`[SENSe<1|2>:]LIST:POWer:SET`). This also includes the setting for trigger and gate parameters.



Settings that are not directly included in commands of this subsystem can be configured by sending the corresponding commands prior to the [SENSe:LIST Subsystem](#) commands.

Please note that changes to the trigger level have to be executed in zero span in order to take effect for the [SENSe:LIST Subsystem](#) commands.

The following subsystem is included:

- "[SENSe:LIST:RANGe Subsystem](#)" on page 6.204

Commands of the SENSe:LIST Subsystem

- `[SENSe<1|2>:]LIST:POWer[:SEQuence]`
- `[SENSe<1|2>:]LIST:POWer:RESult?`
- `[SENSe<1|2>:]LIST:POWer:SET`
- `[SENSe<1|2>:]LIST:POWer:STATe`

Further information

- [More details on the SENSe:LIST Subsystem](#)

More details on the SENSe:LIST Subsystem

The following setting parameters can be selected independently for each frequency point:

- analyzer frequency
- reference level
- resolution filter
- resolution bandwidth
- video bandwidth
- measurement time
- detector

The commands of this subsystem can be used in two different ways:

- Instrument setup, measurement and querying of the results in a single command line. With this method, there is the least delay between the measurement and the result output. However, it requires the control computer to wait for the response from the instrument.

- Instrument setup and querying of the result list at the end of the measurement: With this method, the control computer may be used for other activities while the measurement is being performed. However, more time is needed for synchronization via service request.

[SENSe<1|2>:]LIST:POWer[:SEQUence]

This command configures the list of settings (max. 200 entries) for the multiple power measurement and starts a measurement sequence. When synchronizing the command with *OPC, a service request is generated as soon as all frequency points are processed and the defined number of individual measurements is reached.

To reduce the setting time, all indicated parameters are set up simultaneously at each test point.

The query form of the command processes the list and immediately returns the list of results.

The number of results per test point depends on the setting of the

[SENSe<1|2>:]LIST:POWer:SET command.

The numeric suffixes <1|2> are not relevant.

Parameter

The following parameters are the settings for an individual frequency point. They are repeated for every other frequency point.

<analyzer freq>	Receive frequency for the signal to be measured (= center frequency in manual operation) Range of values: 0 Hz to max. frequency, depending on the instrument model.
<ref level>	Reference level Range of values: +20 dBm to -130 dBm in 0.1 dB steps
<rf att>	RF input attenuation Range of values: 0 dB to 30 dB in 5 dB steps
<rf att 2>	Only listed due to reasons of compatibility with the FSP family. Takes no effect.
<filter type>	For details refer to "[SENSe<1 2>:]BANDwidth BWIDth[:RESolution]:TYPE" on page 6.171
<rbw>	Resolution bandwidth For the range of values refer to chapter "Instrument Functions", section "Res BW Manual". Refer to chapter "Instrument Functions", section "To choose the appropriate filter type", for possible combinations of filter type and filter bandwidth for the <filter type> = CFILter and <filter type> = RRC.
<vbw>	Video bandwidth Range of values: 1 Hz to 10 MHz in 1, 3, 10 steps. The value is ignored for <filter type> = CFILter or RRC
<meas time>	Measurement time Range of values: 1us to 16000s For details refer to chapter "Instrument Functions", section "Sweep-time Manual"
<trigger level>	Reserved. Must be set to 0.

Return values

The query command returns a list of comma-separated values (CSV) which contains the power measurement results in floating-point format. The unit depends on the setting with `CALCulate<1|2>:UNIT:POWer`

The command

```
SENSe:LIST:POWer?
935.2MHz,0dBm,10dB,OFF,NORM,1MHz,3MHz,440us,0,
935.4MHz,0dBm,10dB,10dB,NORM,30kHz,100kHz,440us,0,
935.6MHz,0dBm,10dB,20dB,NORM,30kHz,100kHz,440us,0
```

thus returns the following list, for example:

-28.3,-30.6,-38.1

If the command sequence is extended to

```
SENSe:LIST:POWer:SET ON,ON,ON,IMM,POS,0,0
SENSe:LIST:POWer?
935.2MHz,0dBm,10dB,OFF,NORM,1MHz,3MHz,440us,0,
935.4MHz,0dBm,10dB,10dB,NORM,30kHz,100kHz,440us,0,
935.6MHz,0dBm,10dB,20dB,NORM,30kHz,100kHz,440us,0
```

the result list is extended to 3 results per frequency point (peak, RMS and average):

-28.3, -29.6, 1.5, -30.6, -31.9, 0.9, -38.1, -40.0, 2.3

Example

```
SENSe:LIST:POWer
935.2MHz,0dBm,10dB,OFF,NORM,1MHz,3MHz,440us,0,
935.4MHz,0dBm,10dB,10dB,CFIL,30kHz,100kHz,440us,0,
935.6MHz,0dBm,10dB,20dB,CFIL,30kHz,100kHz,440us,0
```

Performs a measurement sequence with the following settings:

Step	Freq. [MHz]	Ref Level [dBm]	RF Att [dB]	el Att [dB]	Filter type	RBW	VBW	Meas Time [us]	TRG Level (reserved)
1	935.2	0	10	OFF	Normal	1 MHz	3 MHz	440	0
2	935.4	0	10	10	Channel	30 kHz	100 kHz	440	0
3	935.6	0	10	20	Channel	30 kHz	100 kHz	440	0

```
SENSe:LIST:POWer?
935.2MHz,0dBm,10dB,OFF,NORM,1MHz,3MHz,440us,0,
935.4MHz,0dBm,10dB,10dB,CFIL,30kHz,100kHz,440us,0,
935.6MHz,0dBm,10dB,20dB,CFIL,30kHz,100kHz,440us,0
```

Performs the same measurement and returns the result list immediately after the last frequency point.

Note: *The measurement is performed in zero span and therefore the span is set to 0 Hz. If the span > 0 is set, the function is automatically switched off.*

The measurement is not compatible with other measurements, especially as far as marker, adjacent channel power measurement or statistics are concerned. The corresponding commands thus automatically deactivate the function.

The function is only available in REMOTE operation. It is deactivated when switching the instrument back to LOCAL.

Characteristics

*RST value: -

SCPI: device-specific

Mode

A-F, A-T

[SENSe<1|2>:]LIST:POWer:RESult?

This command queries the result of a previous list measurement as configured and initiated with `[SENSe<1|2>:]LIST:POWer[:SEQuence]`. The measured results are output in a list of floating point values separated by commas. The unit of the results depends on the setting made with the `CALCulate<1|2>:UNIT:POWer` command.

This command may be used to obtain measurement results in an asynchronous way, using the service request mechanism for synchronization with the end of the measurement.

If no measurement results are available, the command will return a query error.

The numeric suffixes <1|2> are not relevant.

Example

```
*ESE 1
*SRE 32
```

Configuration of the status reporting system for the generation of an SRQ on operation complete

```
SENSe:LIST:POWer
935.2MHz,-20dBm,10dB,OFF,NORM,1MHz,3MHz,434us,0,
935.4MHz,-20dBm,10dB,10dB,NORM,30kHz,100kHz,434us,0,
935.6MHz,-20dBm,10dB,20dB,NORM,30kHz,100kHz,434us,0;
*OPC
```

Configuring and starting the measurement

...

Further actions of the control computer during measurement

```
On SRQ:
SENSe:LIST:POWer:RESult?
Response to service request
```

Characteristics

*RST value: -

SCPI: device-specific

Mode

A-F, A-T

[SENSe<1|2>:]LIST:POWer:SET

This command defines the constant settings for the list during multiple power measurement.

Parameters <PEAK meas>, <RMS meas> and <AVG meas> define, which measurements are to be performed at the same time at the frequency point. Correspondingly, one, two or three results per frequency point are returned for the `[SENSe<1|2>:]LIST:POWer[:SEQuence]` command. If all three parameters are set to OFF, the command generates an execution error.

The numeric suffixes <1|2> are not relevant.

Parameter

<PEAK meas>	ON: activates the measurement of the peak power (peak detector) OFF: deactivates the measurement of the peak power
<RMS meas>	ON: activates the measurement of the RMS power (RMS detector) OFF: deactivates the measurement of the RMS power
<AVG meas>	ON: activates the measurement of the average power (average detector) OFF: deactivates the measurement of the average power

<trigger mode>	Selection of the trigger source used for the list measurement Possible values: IMMEDIATE EXTERNAL VIDEO IFFPOWER
<trigger slope>	Used trigger slope Possible values: POSITIVE NEGATIVE
<trigger offset>	Offset between the detection of the trigger signal and the start of the measurement at the next frequency point. Range of values: 0 s, 125 ns to 100s
<gate length>	Gate length with gated sweep Range of values: 0 s, 125 ns to 100s The value 0 s deactivates the use of gated trigger; other values activate the gated trigger function. Values <> 0 s are only possible if <trigger mode> is different from IMMEDIATE. Otherwise, an execution error is triggered.

Return values

The query command returns a list of comma-separated values (CSV) of the settings, i.e.

```
ON, ON, ON, IMM, POS, 0, 0
```

if the configuration has been set with the command

```
SENSe:LIST:POWer:SET ON, ON, ON, IMM, POS, 0, 0
```

Example

```
SENSe:LIST:POWer:SET ON, OFF, OFF, EXT, POS, 10US, 434US
```

Characteristics

*RST value: ON, OFF, OFF, IMM, POS, 0S, 0S

SCPI: device-specific

Mode

A-F, A-T

[SENSe<1|2>:]LIST:POWer:STATe

This command deactivates the list measurement.

The numeric suffixes <1|2> are not relevant.

Parameter

OFF

Example

```
SENSe:LIST:POWer:STATe OFF
```

Characteristics

*RST value: -

SCPI: device-specific

Mode

A-F, A-T

SENSe:LIST:RANGe Subsystem

The SENSe:LIST:RANGe Subsystem contains the remote commands to configure Spurious Emissions measurements.

Commands of the SENSe:LIST:RANGe Subsystem

- [SENSe<1|2>:]LIST:RANGe<1...20>:BANDwidth
- [SENSe<1|2>:]LIST:RANGe<1...20>:BANDwidth:RESolution
- [SENSe<1|2>:]LIST:RANGe<1...20>:BANDwidth:VIDeo
- [SENSe<1|2>:]LIST:RANGe<1...20>:BREak
- [SENSe<1|2>:]LIST:RANGe<1...20>:DELeTe
- [SENSe<1|2>:]LIST:RANGe<1...20>:COUnT?
- [SENSe<1|2>:]LIST:RANGe<1...20>:DETEctor
- [SENSe<1|2>:]LIST:RANGe<1...20>[:FREQuency]:STARt
- [SENSe<1|2>:]LIST:RANGe<1...20>[:FREQuency]:STOP
- [SENSe<1|2>:]LIST:RANGe<1...20>:FILTer:TYPE
- [SENSe<1|2>:]LIST:RANGe<1...20>:INPut:ATTenuation
- [SENSe<1|2>:]LIST:RANGe<1...20>:INPut:ATTenuation:AUTO
- [SENSe<1|2>:]LIST:RANGe<1...20>:INPut:GAIN:STATe
- [SENSe<1|2>:]LIST:RANGe<1...20>:POINts
- [SENSe<1|2>:]LIST:RANGe<1...20>:RLEVel
- [SENSe<1|2>:]LIST:RANGe<1...20>:SWEep:TIME
- [SENSe<1|2>:]LIST:RANGe<1...20>:SWEep:TIME:AUTO
- [SENSe<1|2>:]LIST:RANGe<1...20>:LIMit:STARt
- [SENSe<1|2>:]LIST:RANGe<1...20>:LIMit:STOP
- [SENSe<1|2>:]LIST:RANGe<1...20>:LIMit:STATe
- [SENSe<1|2>:]LIST:RANGe<1...20>:TRANsducer

[SENSe<1|2>:]LIST:RANGe<1...20>:BANDwidth

For details refer to "[SENSe<1|2>:]ESpectrum:RANGe<1...20>:BANDwidth" on page 6.184.

This command is available from firmware version 1.80.

[SENSe<1|2>:]LIST:RANGe<1...20>:BANDwidth:RESolution

For details refer to "[SENSe<1|2>:]ESpectrum:RANGe<1...20>:BANDwidth:RESolution" on page 6.184.

This command is available from firmware version 1.80.

[SENSe<1|2>:]LIST:RANGe<1...20>:BANDwidth:VIDeo

For details refer to "[SENSe<1|2>:]ESpectrum:RANGe<1...20>:BANDwidth:VIDeo" on page 6.185.

This command is available from firmware version 1.80.

[SENSe<1|2>:]LIST:RANGe<1...20>:BREak

This command configures the sweep behavior.

The numeric suffixes are not relevant.

This command is available from firmware version 1.80.

Parameter

- ON The R&S FSL stops after one range is swept and continues only if you confirm (a message box is displayed).
- OFF The R&S FSL sweeps all ranges in one go.

Example

```
LIST:RANG:BRE ON
```

Configures a stop after each range.

Characteristics

RST value: OFF

SCPI: device-specific

Mode

A

[SENSe<1|2>:]LIST:RANGe<1...20>:DELeTe

For details refer to "[SENSe<1|2>:]ESpectrum:RANGe<1...20>:DELeTe" on page 6.185.

This command is available from firmware version 1.80.

[SENSe<1|2>:]LIST:RANGe<1...20>:COUNt?

For details refer to "[SENSe<1|2>:]ESpectrum:RANGe<1...20>:COUNt?" on page 6.185.

This command is available from firmware version 1.80.

[SENSe<1|2>:]LIST:RANGe<1...20>:DETector

This command sets the detector for the specified range. For details refer to chapter 4, "Detector overview".

The numeric suffixes <1...20> specify the range. The numeric suffixes <1|2> are not relevant.

This command is available from firmware version 1.80.

Parameter

- APEak auto peak detector
- NEGative minimum peak detector
- POSitive peak detector

SAMPlE	sample detector
RMS	RMS detector
AVERage	average detector

Example

```
LIST:RANGe3:DET SAMP
```

Sets the sample detector for range 3.

Characteristics

RST value: RMS

SCPI: device-specific

Mode

A

[SENSe<1|2>:]LIST:RANGe<1...20>[:FREQuency]:STARt

For details refer to "[\[SENSe<1|2>:\]ESpectrum:RANGe<1...20>\[:FREQuency\]:STARt](#)" on page 6.186.

This command is available from firmware version 1.80.

[SENSe<1|2>:]LIST:RANGe<1...20>[:FREQuency]:STOP

For details refer to "[\[SENSe<1|2>:\]ESpectrum:RANGe<1...20>\[:FREQuency\]:STOP](#)" on page 6.186.

This command is available from firmware version 1.80.

[SENSe<1|2>:]LIST:RANGe<1...20>:FILTer:TYPE

For details refer to "[\[SENSe<1|2>:\]ESpectrum:RANGe<1...20>:FILTer:TYPE](#)" on page 6.186.

This command is available from firmware version 1.80.

[SENSe<1|2>:]LIST:RANGe<1...20>:INPut:ATTenuation

For details refer to "[\[SENSe<1|2>:\]ESpectrum:RANGe<1...20>:INPut:ATTenuation](#)" on page 6.187.

This command is available from firmware version 1.80.

[SENSe<1|2>:]LIST:RANGe<1...20>:INPut:ATTenuation:AUTO

For details refer to "[\[SENSe<1|2>:\]ESpectrum:RANGe<1...20>:INPut:ATTenuation:AUTO](#)" on page 6.187.

This command is available from firmware version 1.80.

[SENSe<1|2>:]LIST:RANGe<1...20>:INPut:GAIN:STATe

For details refer to "[\[SENSe<1|2>:\]ESpectrum:RANGe<1...20>:INPut:GAIN:STATe](#)" on page 6.188.

This command is available from firmware version 1.80.

[SENSe<1|2>:]LIST:RANGe<1...20>:POINTs

This command sets the number of sweep points for the specified range.
The numeric suffixes <1...20> specify the range. The numeric suffixes <1|2> are not relevant.
This command is available from firmware version 1.80.

Parameter

For details on possible values refer to chapter 4, **Sweep Points** softkey of the sweep menu.

Example

```
LIST:RANG3:POIN 601
```

Sets 601 sweep points for range 3.

Characteristics

RST value: 501
SCPI: device-specific

Mode

A

[SENSe<1|2>:]LIST:RANGe<1...20>:RLEVel

For details refer to "[\[SENSe<1|2>:\]ESpectrum:RANGe<1...20>:RLEVel](#)" on page 6.191.
This command is available from firmware version 1.80.

[SENSe<1|2>:]LIST:RANGe<1...20>:SWEep:TIME

For details refer to "[\[SENSe<1|2>:\]ESpectrum:RANGe<1...20>:SWEep:TIME](#)" on page 6.191.
This command is available from firmware version 1.80.

[SENSe<1|2>:]LIST:RANGe<1...20>:SWEep:TIME:AUTO

For details refer to "[\[SENSe<1|2>:\]ESpectrum:RANGe<1...20>:SWEep:TIME:AUTO](#)" on page 6.191.
This command is available from firmware version 1.80.

[SENSe<1|2>:]LIST:RANGe<1...20>:LIMit:STARt

For details refer to "[\[SENSe<1|2>:\]ESpectrum:RANGe<1...20>:LIMit:ABSolute:STARt](#)" on page 6.189.
This command is available from firmware version 1.80.

[SENSe<1|2>:]LIST:RANGe<1...20>:LIMit:STOP

For details refer to "[\[SENSe<1|2>:\]ESpectrum:RANGe<1...20>:LIMit:ABSolute:STOP](#)" on page 6.189.
This command is available from firmware version 1.80.

[SENSe<1|2>:]LIST:RANGe<1...20>:LIMit:STATe

For details refer to "[SENSe<1|2>:]ESpectrum:RANGe<1...20>:LIMit:STATe" on page 6.190.
This command is available from firmware version 1.80.

[SENSe<1|2>:]LIST:RANGe<1...20>:TRANsducer

For details refer to "[SENSe<1|2>:]ESpectrum:RANGe<1...20>:TRANsducer" on page 6.192.
This command is available from firmware version 1.80.

SENSe:MPOWER Subsystem

The commands of this subsystem are used to determine the mean burst power or peak burst power for a given number of signal bursts, and for outputting the results in a list. Since all the settings required for a measurement are combined in a single command, the measurement speed is considerably higher than when using individual commands.

For measuring the signal bursts, the gated sweep function is used in zero span. The gate is controlled either by an external trigger signal or by the video signal. An individual trigger event is required for each burst to be measured. If an external trigger signal is used, the threshold is fixed to TTL level, while with a video signal the threshold can be set as desired.

Commands of the SENSe:MPOWER Subsystem

- [SENSe<1|2>:]MPOWER[:SEQuence]
- [SENSe<1|2>:]MPOWER:FTYPE
- [SENSe<1|2>:]MPOWER:RESult[:LIST]?
- [SENSe<1|2>:]MPOWER:RESult:MIN?

Further information

- [More details on the SENSe:MPOWER Subsystem](#)

More details on the SENSe:MPOWER Subsystem

The following graphics shows the relation between trigger time, trigger offset (for delayed gate opening) and measurement time.

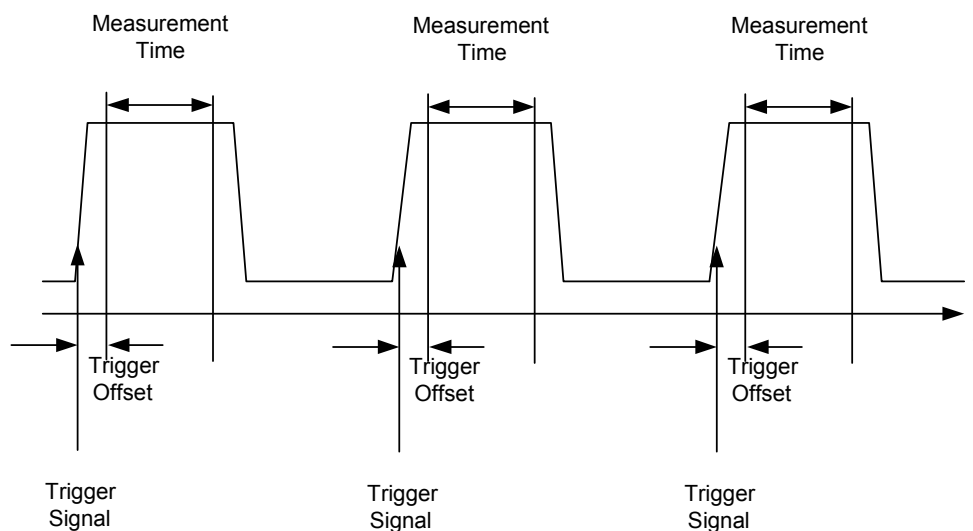

Depending on the settings made, the measurements are performed with the RMS detector for RMS power or the PEAK detector for peak power. For all these measurements, trace 1 of the selected system is used.

The setting parameters for this measurement are:

- analyzer frequency
- resolution bandwidth
- measurement time used for a single burst

- trigger source
- trigger level
- trigger offset
- type of power measurement (PEAK, MEAN)
- number of bursts to be measured

The commands of this subsystem can be used in two different ways:

- Setting up the instrument and at the same time querying the result list: This method ensures the smallest delay between measurement and the output of the measured values, but requires the control computer to wait actively for the response of the instrument.
- Setting up the instrument and querying the result list after synchronization to the end of measurement: With this method the control computer can be used for other activities while the instrument is performing the measurement at the cost of additional time needed for synchronization via service request.

[SENSe<1|2>:]MPOWER[:SEquence]

This command configures the instrument setup for multiple burst power measurement and starts a measurement sequence. When synchronizing the command with *OPC, a service request is generated as soon as the defined number of individual measurements (# of meas) is reached.

To reduce the setting time, the setup is performed simultaneously for all selected parameters.

The command in the form of a query makes the instrument settings, performs the defined number of measurements and outputs the measurement results list.

The numeric suffixes <1|2> are not relevant.

Parameter

<analyzer freq>	Receive frequency for the burst signals to be measured (= center frequency in manual operation) Range: 0 Hz to max. frequency, depending on instrument model
<rbw>	resolution bandwidth for the measurement Range: 10 Hz to 10 MHz in steps of 1, 3, 10
<meas time>	Time span during which measurement samples are sampled for RMS / peak measurement. The type of measurement is selected by <type of meas>. Range: 1us to 30s
<trigger source>	trigger signal source. Possible settings: EXTernal: The trigger signal is fed from the "Ext. Trigger/Gate" input on the rear of the unit. VIDeo: The internal video signal is used as trigger signal.
<trigger level>	Signal level at which the trigger becomes active. For <trigger source> = VIDEO this is the level of the video signal as a percentage of the diagram height. If <trigger source> = EXTernal is selected, the value entered here is ignored, as in this case the trigger input uses TTL levels. Range: 0 - 100PCT(<trigger source> = VIDEO)
<trigger offset>	Offset between the detection of the trigger signal and the start of the measurement. Range: 125 ns to 100s

<type of meas>	Determines whether mean power (RMS) or peak power (PEAK) is to be measured. The detector is selected accordingly. Possible values: MEAN, PEAK
<# of meas>	Number of individual bursts to be measured. Range: 1 to 32001

Return values

The query command returns a list separated by commas (comma separated values = CSV), which contains the power measurement results in floating-point format. The unit used for the return values is always dBm.

The command `SENSe:MPOWer? 935.2MHz,1MHz,434us,VIDEO,50PCT,5us,MEAN,20`

may, for instance, cause the following list to be returned:

18.3,18.6,18.1,18.0,17.9,18.3,18.6,18.1,18.0,17.9,18.3,18.6,18.1,18.0,17.9,18.3,18.6,18.1,18.0,17.9

Example

`SENSe:MPOWer 935.2MHz,1MHz,434us,VIDEO,50PCT,5us,MEAN,20`

Performs a measurement sequence with the following settings:

Frequency = 935.2 MHz,

Resolution bandwidth = 1 MHz

Measurement time = 434 μ s

Trigger source = VIDEO

Trigger threshold = 50%

Trigger offset = 5 μ s

Type of measurement = MEAN power

No. of measurements = 20

`SENSe:MPOWer? 935.2MHz,1MHz,434us,VIDEO,50PCT,5us,MEAN,20`

Performs the same measurement and in addition returns the results list immediately after completion of the last measurement.

Note: *The measurement function always uses trace 1.*

Repeated use of the command without changes to its parameters (i.e. using the same settings again) will speed up the measurement since the previous hardware settings will be cached and therefore additional hardware settling times will be avoided. This also holds true if only part of the parameters (e.g. only the trigger delay) are changed, as in this case the rest of the parameters will be cached.

This measurement is not compatible with other measurements, especially as far as marker functions, adjacent-channel measurement or statistics are concerned. The corresponding functions are therefore automatically switched off. In return incompatible commands will automatically deactivate the multi burst power function.

The function is only available in the REMOTE operation. It is deactivated on switching back to LOCAL.

Characteristics

*RST value: -

SCPI: device-specific

Mode

A

[SENSe<1|2>:]MPOWer:FTYPE

This command defines the filter type for the measurement.
The numeric suffixes <1|2> are not relevant.

Parameter

NORMal | CFILter | RRC

Example

```
SENSe:MPOWer:FTYPE CFILter
```

Characteristics

*RST value: -

SCPI: device-specific

Mode

A

[SENSe<1|2>:]MPOWer:RESult[:LIST]?

This command queries the results of a multiple burst power measurement as configured and initiated with `[SENSe<1|2>:]MPOWer[:SEquence]`. The results are output in a comma-separated list of floating point values. The unit used for the return values is always dBm.

This command may be used to obtain measurement results in an asynchronous way using the service request mechanism for synchronization with the end of the measurement.

The numeric suffixes <1|2> are not relevant.

If no measurement results are available, the command will return a query error.

Example

```
*ESE 1
```

```
*SRE 32
```

Configuration of status reporting systems for the generation of an SRQ on operation complete

```
SENSe:MPOWer 935.2MHz,1MHz,434us,VIDEO,50PCT,5us,MEAN,20;*OPC
```

Configuring and starting the measurement

...

Further actions of the control computer during measurement

On SRQ:

Response to service request

```
SENSe:MPOWer:RESult?
```

Characteristics

*RST value: -

SCPI: device-specific

Mode

A

[SENSe<1|2>:]MPOWer:RESult:MIN?

This command queries the minimum power value in a multiple burst power measurement as configured and initiated with `[SENSe<1|2>:]MPOWer[:SEquence]`. The unit used for the return values is always dBm.

The numeric suffixes <1|2> are not relevant.

If no measurement result is available, the command will return a query error.

Example

```
*ESE 1
```

```
*SRE 32
```

Configuration of status reporting systems for the generation of an SRQ on operation complete

```
SENSe:MPOWer 935.2MHz,1MHz,434us,VIDEO,50PCT,5us,MEAN,20;*OPC
```

Configuring and starting the measurement

```
...
```

Further actions of the control computer during measurement

On SRQ:

Response to service request

```
SENSe:MPOWer:RESult:MIN?
```

Characteristics

*RST value: -

SCPI: device-specific

Mode

A

SENSe:POWer Subsystem

This subsystem controls the setting of the instruments channel and adjacent channel power measurements.

Commands of the SENSe:POWer Subsystem

- [SENSe<1|2>:]POWer:ACHannel:ACPairs
- [SENSe<1|2>:]POWer:ACHannel:BANDwidth|BWIDth[:CHANnel]
- [SENSe<1|2>:]POWer:ACHannel:BANDwidth|BWIDth:ACHannel
- [SENSe<1|2>:]POWer:ACHannel:BANDwidth|BWIDth:ALTErnate<1...11>
- [SENSe<1|2>:]POWer:ACHannel:MODE
- [SENSe<1|2>:]POWer:ACHannel:PRESet
- [SENSe<1|2>:]POWer:ACHannel:PRESet:RLEVel
- [SENSe<1|2>:]POWer:ACHannel:REFerence:AUTO
- [SENSe<1|2>:]POWer:ACHannel:REFerence:TXCHannel:AUTO
- [SENSe<1|2>:]POWer:ACHannel:REFerence:TXCHannel:MANual
- [SENSe<1|2>:]POWer:ACHannel:SPACing[:ACHannel]
- [SENSe<1|2>:]POWer:ACHannel:SPACing:ALTErnate<1...11>
- [SENSe<1|2>:]POWer:ACHannel:SPACing:CHANnel
- [SENSe<1|2>:]POWer:ACHannel:TXCHannel:COUNT
- [SENSe<1|2>:]POWer:BANDwidth|BWIDth
- [SENSe<1|2>:]POWer:HSPeed
- [SENSe<1|2>:]POWer:TRACe

[SENSe<1|2>:]POWer:ACHannel:ACPairs

This command sets the number of adjacent channels (upper and lower channel in pairs). The figure 0 stands for pure channel power measurement.

The numeric suffixes <1|2> are not relevant.

Parameter

1 to 12

Example

```
POW:ACH:ACP 3
```

Sets the number of adjacent channels to 3, i.e. the adjacent channel and alternate adjacent channels 1 and 2 are switched on.

Characteristics

*RST value: 1

SCPI: device-specific

Mode

A-F

[SENSe<1|2>:]POWer:ACHannel:BANDwidth|BWIDth[:CHANnel]

This command sets the channel bandwidth of the radio communication system. The bandwidths of adjacent channels are not influenced by this modification.

With [SENSe<1|2>:]POWer:HSPeed set to ON, steep-edged channel filters are available. For further information on filters refer to chapter "Instrument Functions", section "List of available RRC and channel filters".

The numeric suffixes <1|2> are not relevant.

Parameter

100 Hz to 1000 MHz

Example

```
POW:ACH:BWID 30kHz
```

Sets the bandwidth of the TX channel to 30 kHz.

Characteristics

*RST value: 14 kHz

SCPI: device-specific

Mode

A-F

[SENSe<1|2>:]POWer:ACHannel:BANDwidth|BWIDth:ACHannel

This command defines the channel bandwidth of the adjacent channel of the radio transmission system. If the bandwidth of the adjacent channel is changed, the bandwidths of all alternate adjacent channels are automatically set to the same value.

With [SENSe<1|2>:]POWer:HSPeed set to ON, steep-edged channel filters are available. For further information on filters refer to chapter "Instrument Functions", section "List of available RRC and channel filters".

The numeric suffixes <1|2> are not relevant.

Parameter

100 Hz to 1000 MHz

Example

```
POW:ACH:BWID:ACH 30kHz
```

Sets the bandwidth of all adjacent channels to 30 kHz.

Characteristics

*RST value: 14 kHz

SCPI: device-specific

Mode

A-F

[SENSe<1|2>:]POWer:ACHannel:BANDwidth|BWIDth:ALternate<1...11>

This command defines the channel bandwidth of the alternate adjacent channels of the radio transmission system. If the channel bandwidth of alternate adjacent channel 1 is changed, the bandwidth of alternate adjacent channels 2 to 11 is automatically set to the same value.

With [SENSe<1|2>:]POWer:HSPeed set to ON, steep-edged channel filters are available. For further information on filters refer to chapter "Instrument Functions", section "List of available RRC and channel filters".

Parameter

100 Hz to 1000 MHz

Example

POW:ACH:BWID:ALT2 30kHz

Characteristics

*RST value: 14 kHz

SCPI: device-specific

Mode

A-F

[SENSe<1|2>:]POWer:ACHannel:MODE

This command switches between absolute and relative adjacent channel measurement. The command is only available with span > 0 and if the number of adjacent channel is greater than 0.

The numeric suffixes <1|2> are not relevant.

This command is available from firmware version 1.10.

Parameter

ABSolute | RELative

Example

POW:ACH:MODE REL

Sets the adjacent channel measurement mode to relative.

Characteristics

RST value: RELative

SCPI: device-specific

Mode

A-F

[SENSe<1|2>:]POWer:ACHannel:PRESet

This command adjusts the frequency span, the measurement bandwidths and the detector as required for the number of channels, the channel bandwidths and the channel spacings selected in the active power measurement. If necessary, adjacent-channel power measurement is switched on prior to the adjustment.

To obtain correct results, a complete sweep with synchronization to the end of the sweep must be performed after the adjustment. Synchronization is possible only in the single sweep mode.

The result is queried with the `CALCulate<1|2>:MARKer:FUNction:POWer:RESult?` command.

The numeric suffixes <1|2> are not relevant.

Parameter

ACPower | CPOWer | MCACpower | OBANdwidth | OBWidth | CN | CNO

Example

POW:ACH:PRES ACP

Sets the frequency span, the measurement bandwidths and the detector as required for the ACP measurement.

INIT:CONT OFF

Switches over to single sweep mode.

INIT; *WAI

Starts a sweep and waits for the end of the sweep.

CALC:MARK:FUNC:POW:RES? ACP

Queries the result of the adjacent-channel power measurement.

Characteristics

*RST value: -

SCPI: device-specific

Mode

A-F

[SENSe<1|2>]:POWer:ACHannel:PRESet:RLEVel

This command adapts the reference level to the measured channel power and - if required - switches on previously the adjacent channel power measurement. This ensures that the signal path of the instrument is not overloaded. Since the measurement bandwidth is significantly smaller than the signal bandwidth in channel power measurements, the signal path can be overloaded although the trace is still significantly below the reference level. If the measured channel power equals the reference level, the signal path is not overloaded.

The numeric suffixes <1|2> are not relevant.

This command is an event and therefore has no *RST value and no query.

Note: *Subsequent commands have to be synchronized with *WAI, *OPC or *OPC? to the end of the auto range process which would otherwise be aborted.*

Example

POW:ACH:PRESet:RLEV; *WAI

Adapts the reference level to the measured channel power.

Characteristics

*RST value: -

SCPI: device-specific

Mode

A-F, CATV, WCDMA

[SENSe<1|2>]:POWer:ACHannel:REference:AUTO

This command sets the reference value to the currently measured channel power for the relative measurement.

The numeric suffixes <1|2> are not relevant.

This command is an event and therefore has no *RST value and no query.

Parameter

ONCE

Example

POW:ACH:REF:AUTO ONCE

Characteristics

RST value: -

SCPI: device-specific

Mode

A-F

[SENSe<1|2>:]POWer:ACHannel:REFerence:TXCHannel:AUTO

This command activates the automatic selection of a transmission channel to be used as a reference channel in relative adjacent-channel power measurements.

The transmission channel with the highest power, the transmission channel with the lowest power, or the transmission channel nearest to the adjacent channels can be defined as a reference channel.

The command is available only for multicarrier channel and adjacent-channel power measurements with span > 0 (`CALCulate<1|2>:MARKer:FUNction:POWer:SElect`).

The numeric suffixes <1|2> are not relevant.

Parameter

MINimum	Transmission channel with the lowest power
MAXimum	Transmission channel with the highest power
LHIGhest	Lowermost transmission channel for the lower adjacent channels, uppermost transmission channel for the upper adjacent channels

Example

```
POW:ACH:REF:TXCH:AUTO MAX
```

The transmission channel with the highest power is used as a reference channel.

Characteristics

*RST value: -

SCPI: device-specific

Mode

A-F

[SENSe<1|2>:]POWer:ACHannel:REFerence:TXCHannel:MANual

This command selects a transmission channel to be used as a reference channel in relative adjacent-channel power measurements.

The command is available only for multicarrier channel and adjacent-channel power measurements with span > 0 (`CALCulate<1|2>:MARKer:FUNction:POWer:SElect`).

The numeric suffixes <1|2> are not relevant.

Parameter

1 to 12

Example

```
POW:ACH:REF:TXCH:MAN 3
```

Transmission channel 3 is used as a reference channel.

Characteristics

*RST value: 1

SCPI: device-specific

Mode

A-F

[SENSe<1|2>:]POWer:ACHannel:SPACing[:ACHannel]

This command defines the spacing between the carrier signal and the adjacent channel (ADJ). The modification of the adjacent-channel spacing (ADJ) causes a change in all higher adjacent-channel spacings (ALT1, ALT2, ...): they are all multiplied by the same factor (new spacing value / old spacing value).

The numeric suffixes <1|2> are not relevant.

Parameter

100 Hz to 2000 MHz

Example

```
POW:ACH:SPAC 33kHz
```

Sets the spacing between the carrier signal and the adjacent channel to 33 kHz, the alternate adjacent channel 1 to 66 kHz, the alternate adjacent channel 2 to 99 kHz, and so on.

Characteristics

*RST value: 14 kHz

SCPI: device-specific

Mode

A-F

[SENSe<1|2>:]POWer:ACHannel:SPACing:ALTErnate<1...11>

This command defines the spacing between the alternate adjacent channels and the TX channel (ALT1, ALT2, ...). A modification of a higher adjacent-channel spacing causes a change by the same factor (new spacing value / old spacing value) in all higher adjacent-channel spacings, while the lower adjacent-channel spacings remain unchanged.

The numeric suffixes <1...11> defines the alternate adjacent channel. The numeric suffixes <1|2> are not relevant.

Parameter

100 Hz to 2000 MHz

Example

```
POW:ACH:SPAC:ALT1 100kHz
```

Sets the spacing between TX channel and alternate adjacent channel 1 (ALT1) from 40 kHz to 100 kHz. In consequence, the spacing between the TX channel and all higher alternate adjacent channels is increased by the factor $100/40 = 2.5$: ALT2 = 150 kHz, ALT3 = 200 kHz, ALT4 = 250 kHz.

Characteristics

*RST value: 40 kHz (ALT1), 60 kHz (ALT2), 80 kHz (ALT3), ...

SCPI: device-specific

Mode

A-F

[SENSe<1|2>:]POWer:ACHannel:SPACing:CHANnel<1...11>

This command defines the channel spacing for the carrier signals.

The numeric suffixes <1...11> defines the TX channel. The numeric suffixes <1|2> are not relevant.

Parameter

14 kHz to 2000 MHz

Example

POW:ACH:SPAC:CHAN 25kHz

Characteristics

*RST value: 20 kHz

SCPI: device-specific

Mode

A-F

[SENSe<1|2>:]POWer:ACHannel:TXChannel:COUNT

This command selects the number of carrier signals.

The command is available only for multicarrier channel and adjacent-channel power measurements with span > 0 ([CALCulate<1|2>:MARKer:FUNCTION:POWer:SElect](#)).

The numeric suffixes <1|2> are not relevant.

Parameter

1 to 12

Example

POW:ACH:TXCH:COUN 3

Characteristics

*RST value: 1

SCPI: device-specific

Mode

A

[SENSe<1|2>:]POWer:BANDwidth|BWIDth

This command defines the percentage of the power with respect to the total power. This value is the basis for the occupied bandwidth measurement

([\[SENSe<1|2>:\]POWer:ACHannel:PRESet](#)).

The numeric suffixes <1|2> are not relevant.

Parameter

10 to 99.9PCT

Example

POW:BWID 95PCT

Characteristics

*RST value: 99PCT

SCPI: device-specific

Mode

A-F

[SENSe<1|2>:]POWer:HSPeed

This command switches on or off the high-speed channel/adjacent channel power measurement. The measurement itself is performed in zero span on the center frequencies of the individual channels. The command automatically switches to zero span and back.

Depending on the selected mobile radio standard, weighting filters with $\sqrt{\cos}$ characteristic or very steep-sided channel filters are used for band limitation.

The numeric suffixes <1|2> are not relevant.

Parameter

ON | OFF

Example

POW:HSP ON

Characteristics

*RST value: OFF

SCPI: device-specific

Mode

A-F

[SENSe<1|2>:]POWer:TRACe

This command assigns the channel/adjacent channel power measurement to the indicated trace. The corresponding trace must be active, i.e. its state must be different from blank.

The numeric suffixes <1|2> are not relevant.

Note: *The measurement of the occupied bandwidth (OBW) is performed on the trace on which marker 1 is positioned. To evaluate another trace, marker 1 must be positioned to another trace with `CALCulate<1|2>:MARKer<1...4>:TRACe`.*

Parameter

1 to 6

Example

POW:TRAC 2

Assigns the measurement to trace 2.

Characteristics

*RST value: -

SCPI: device-specific

Mode

A

SENSe:ROSCillator Subsystem

This subsystem controls the reference oscillator. The numeric suffix in SENSe is irrelevant for the commands of this subsystem.

Commands of the SENSe:ROSCillator Subsystem

– [SENSe<1|2>:]ROSCillator:SOURce

[SENSe<1|2>:]ROSCillator:SOURce

This command controls selection of the reference oscillator.

If the external reference oscillator is selected, the reference signal must be connected to the rear panel of the instrument.

Parameter

INTernal | EXTernal

Example

ROSC:SOUR EXT

Characteristics

*RST value: -

SCPI: conform

Mode

all

SENSe:SWEEp Subsystem

The SENSe:SWEEp subsystem controls the sweep parameters.

Commands of the SENSe:SWEEp Subsystem

- [SENSe<1|2>:]SWEEp:COUNT
- [SENSe<1|2>:]SWEEp:COUNT:CURRent?
- [SENSe<1|2>:]SWEEp:EGATe
- [SENSe<1|2>:]SWEEp:EGATe:HOLDoff
- [SENSe<1|2>:]SWEEp:EGATe:LENGth
- [SENSe<1|2>:]SWEEp:EGATe:POLarity
- [SENSe<1|2>:]SWEEp:EGATe:SOURce
- [SENSe<1|2>:]SWEEp:EGATe:TYPE
- [SENSe<1|2>:]SWEEp:MODE
- [SENSe<1|2>:]SWEEp:POINts
- [SENSe<1|2>:]SWEEp:TIME
- [SENSe<1|2>:]SWEEp:TIME:AUTO

[SENSe<1|2>:]SWEEp:COUNT

In analyzer mode, the command defines the number of sweeps started with single sweep, which are used for calculating the average or maximum value. If the values 0 or 1 are set, one sweep is performed.

The numeric suffixes <1|2> are not relevant.

Parameter

0 to 32767

Example

```
SWE:COUN 64
```

Sets the number of sweeps to 64.

```
INIT:CONT OFF
```

Switches to single sweep mode.

```
INIT;*WAI
```

Starts a sweep and waits for its end.

Characteristics

*RST value: 0

SCPI: conform

Mode

A, ADEMOD, CATV, CDMA, EVDO, WCDMA

[SENSe<1|2>:]SWEEp:COUNT:CURRent?

This query command returns the current number of started sweeps. A sweep count value should be set and the device should be in single sweep mode.

The numeric suffixes <1|2> are not relevant.

Example

```
SWE:COUNT 64
```

Sets sweep count to 64

```
INIT:CONT OFF
```

Switches to single sweep mode

```
INIT
```

Starts a sweep (without waiting for the sweep end!)

```
SWE:COUN:CURR?
```

Queries the number of started sweeps

Characteristics

*RST value: 0

SCPI: conform

Mode

A, ADEMOD

[SENSe<1|2>:]SWEep:EGATe

This command switches on/off the sweep control by an external gate signal. If the external gate is selected the trigger source is automatically switched to EXTERNAL as well.

In case of measurement with external gate, the measured values are recorded as long as the gate is opened. During a sweep the gate can be opened and closed several times. The synchronization mechanisms with *OPC, *OPC? and *WAI remain completely unaffected.

The sweep end is detected when the required number of measurement points (501 in **Spectrum Analyzer** mode) has been recorded.

The numeric suffixes <1|2> are not relevant.

Parameter

ON | OFF

Example

```
SWE:EGAT ON
```

Switches on the external gate mode.

```
SWE:EGAT:TYPE EDGE
```

Switches on the edge-triggered mode.

```
SWE:EGAT:HOLD 100US
```

Sets the gate delay to 100 μ s.

```
SWE:EGAT:LEN 500US
```

Sets the gate opening time to 500 μ s.

```
INIT;*WAI
```

Starts a sweep and waits for its end.

Characteristics

*RST value: OFF

SCPI: device-specific

Mode

A, WLAN, OFDM, OFDMA/WiBro

[SENSe<1|2>:]SWEep:EGATe:HOLDoff

This command defines the delay time between the external gate signal and the continuation of the sweep.

The numeric suffixes <1|2> are not relevant.

Parameter

125 μ s to 100 s

Example

```
SWE:EGAT:HOLD 100us
```

Characteristics

*RST value: 0s

SCPI: device-specific

Mode

A, BT

[SENSe<1|2>:]SWEep:EGATe:LENGth

In case of edge triggering, this command determines the time interval during which the instrument sweeps.

The numeric suffixes <1|2> are not relevant.

Parameter

0 to 100 s

Example

```
SWE:EGAT:LENG 10ms
```

Characteristics

*RST value: 0s

SCPI: device-specific

Mode

A, BT

[SENSe<1|2>:]SWEep:EGATe:POLarity

This command determines the polarity of the external gate signal. The setting applies both to the edge of an edge-triggered signal and the level of a level-triggered signal.

The numeric suffixes <1|2> are not relevant.

Parameter

POSitive | NEGative

Example

```
SWE:EGAT:POL POS
```

Characteristics

*RST value: POSitive

SCPI: device-specific

Mode

A

[SENSe<1|2>:]SWEep:EGATe:SOURce

This command toggles between external gate signal and IF power signal as a signal source for the gate mode. If an IF power signal is used, the gate is opened as soon as a signal at > -20 dBm is detected within the IF path bandwidth (10 MHz).

The numeric suffixes <1|2> are not relevant.

Parameter

EXTernal | IFPower | VIDEo

Example

```
SWE:EGAT:SOUR IFP
```

Switches the gate source to IF power.

Characteristics

*RST value: IFPower

SCPI: device-specific

Mode

A

[SENSe<1|2>:]SWEep:EGATe:TYPE

This command sets the type of triggering (level or edge) by the external gate signal.

The gate is edge-triggered ([SENSe<1|2>:]SWEep:EGATe:TYPE EDGE):

After detection of the set gate signal edge, the gate remains open until the gate delay ([SENSe<1|2>:]SWEep:EGATe:HOLDoff) has expired.

The gate is level-triggered ([SENSe<1|2>:]SWEep:EGATe:TYPE LEVel):

After detection of the gate signal, the gate remains open until the gate signal disappears. The gate opening time cannot be defined with the parameter

[SENSe<1|2>:]SWEep:EGATe:LENGth.

A delay between applying the gate signal and the start of recording measured values can be defined with [SENSe<1|2>:]SWEep:EGATe:HOLDoff.

The numeric suffixes <1|2> are not relevant.

Parameter

LEVel | EDGE

Example

```
SWE:EGAT:TYPE EDGE
```

Characteristics

*RST value: EDGE

SCPI: device-specific

Mode

A

[SENSe<1|2>:]SWEep:MODE

This command changes from Spectrum Analyzer to Spectrum Emission Mask or Spurious Emissions measurement mode and back.

The numeric suffixes <1|2> are not relevant.

This command is available from firmware version 1.80.

Parameter

AUTO	Switches to Spectrum Analyzer measurement mode or stays in the current mode if it is not ESP / LIST
ESpectrum	Spectrum Emission Mask measurement mode
LIST	Spurious Emissions measurement mode

Example

```
SWE:MODE ESP
```

Sets the Spectrum Emission Mask measurement mode.

Characteristics

RST value: AUTO

SCPI: device-specific

Mode

A, CDMA, EVDO

[SENSe<1|2>:]SWEep:POINts

This command defines the number of measurement points to be collected during one sweep. The numeric suffixes <1|2> are not relevant.

Parameter

101 to 32001

Example

```
SWE:POIN 251
```

Characteristics

*RST value: 501

SCPI: conform

Mode

A, CATV, CDMA, EVDO, SPECM

[SENSe<1|2>:]SWEep:TIME

In analyzer mode, this command defines the sweep time. The available time values vary depending on the span setting.

If [SENSe<1|2>:]SWEep:TIME is directly programmed, automatic coupling to resolution bandwidth and video bandwidth is switched off.

The numeric suffixes <1|2> are not relevant.

Parameter

refer to data sheet

Example

```
SWE:TIME 10s
```

Characteristics

*RST value: - (AUTO is set to ON)

SCPI: conform

Mode

A, ADEMOD, NF, CATV, CDMA, EVDO, OFDM, OFDMA/WiBro, SPECM, WLAN

[SENSe<1|2>:]SWEep:TIME:AUTO

This command controls the automatic coupling of the sweep time to the frequency span and bandwidth settings.

If [SENSe<1|2>:]SWEep:TIME is directly programmed, automatic coupling is switched off. The numeric suffixes <1|2> are not relevant.

Parameter

ON | OFF

Example

```
SWE:TIME:AUTO ON
```

Switches on the coupling to frequency span and bandwidths.

Characteristics

*RST value: ON

SCPI: conform

Mode

A, CATV, CDMA, EVDO, SPECM

SOURce Subsystem

The SOURce subsystem controls the output signals of the instrument.

The following subsystem is included:

- "SOURce:POWER Subsystem" on page 6.229

Commands of the SOURce subsystem

- SOURce<1|2>:EXTernal<1|2>:ROSCillator[:SOURce]
- SOURce:TEMPerature:APRobe?

SOURce<1|2>:EXTernal<1|2>:ROSCillator[:SOURce]

This command switches between external and internal reference oscillator.

Parameter

INTernal | EXTernal

Example

```
SOUR:EXT:ROSC EXT
```

Switches to external reference oscillator

Characteristics

*RST value: INT

SCPI: device-specific

Mode

all

SOURce:TEMPerature:APRobe?

This command queries the sensor temperature.

Parameter

1 (CPU)

Example

```
SOUR:TEMP:APR? 1
```

Queries the temperature of the CPU sensor.

Characteristics

RST value: -

SCPI: device-specific

Mode

all

SOURce:POWer Subsystem (models with tracking generator)

The SOURce:POWer subsystem controls the power of the tracking generator signal.

Commands of the SOURce:POWer Subsystem

- SOURce<1|2>:POWer[:LEVel][:IMMediate][:AMPLitude]
- SOURce<1|2>:POWer[:LEVel][:IMMediate]:OFFSet

SOURce<1|2>:POWer[:LEVel][:IMMediate][:AMPLitude]

This command defines the output level of the tracking generator.

Parameter

<numeric_value> in dBm, range specified in data sheet;

-400 dBm: switches off the tracking generator and keeps the corresponding hardware settings and the normalization

Example

```
SOUR:POW -20dBm
```

Sets the tracking generator level to -20 dBm.

Characteristics

*RST value: -20 dBm

SCPI: conform

Mode

all

SOURce<1|2>:POWer[:LEVel][:IMMediate]:OFFSet

This command defines a level offset for the tracking generator level. Thus, for example, attenuators or amplifiers at the output of the tracking generator can be taken into account for the setting.

Parameter

-200 dB to +200 dB

Example

```
SOUR:POW:OFFS -10dB
```

Sets the level offset of the tracking generator to - 20 dBm.

Characteristics

*RST value: 0dB

SCPI: conform

Mode

all

STATus Subsystem

The STATus subsystem contains the commands for the status reporting system (for details refer to chapter 5 "Remote Control - Basics", section "Status Reporting System"). *RST does not influence the status registers.

The following subsystem is included:

- ["STATus:QUEStionable Subsystem"](#) on page 6.233

Commands of the STATus subsystem

- [STATus:OPERation\[:EVENT\]?](#)
- [STATus:OPERation:CONDition?](#)
- [STATus:OPERation:ENABLE](#)
- [STATus:OPERation:PTRansition](#)
- [STATus:OPERation:NTRansition](#)
- [STATus:PRESet](#)

STATus:OPERation[:EVENT]?

This command queries the contents of the EVENT section of the STATus:OPERation register. The contents of the EVENT section are deleted after readout.

Example

```
STAT:OPER?
```

Characteristics

*RST value: -

SCPI: conform

Mode

all

STATus:OPERation:CONDition?

This command queries the CONDition section of the STATus:OPERation register. Readout does not delete the contents of the CONDition section. The value returned reflects the current hardware status.

Example

```
STAT:OPER:COND?
```

Characteristics

*RST value: -

SCPI: conform

Mode

all

STATus:OPERation:ENABle

This command sets the bits of the ENABle section of the STATus:OPERation register. The ENABle register selectively enables the individual events of the associated EVENT section for the summary bit in the status byte.

Parameter

0 to 65535

Example

STAT:OPER:ENAB 65535

Characteristics

*RST value: -

SCPI: conform

Mode

all

STATus:OPERation:PTRansition

This command sets the edge detectors of all bits of the STATus:OPERation register from 0 to 1 for the transitions of the CONDition bit.

Parameter

0 to 65535

Example

STAT:OPER:PTR 65535

Characteristics

*RST value: -

SCPI: conform

Mode

all

STATus:OPERation:NTRansition

This command sets the edge detectors of all bits of the STATus:OPERation register from 1 to 0 for the transitions of the CONDition bit.

Parameter

0 to 65535

Example

STAT:OPER:NTR 65535

Characteristics

*RST value: -

SCPI: conform

Mode

all

STATus:PRESet

This command resets the edge detectors and ENABle parts of all registers to a defined value. All PTRansition parts are set to FFFFh, i.e. all transitions from 0 to 1 are detected. All NTRansition parts are set to 0, i.e. a transition from 1 to 0 in a CONDition bit is not detected. The ENABle part of the STATus:OPERation and STATus:QUEStionable registers are set to 0, i.e. all events in these registers are not passed on.

Example

```
STAT:PRESet
```

Characteristics

*RST value: -
SCPI: conform

Mode

all

STATus:QUEStionable Subsystem

The STATus:QUEStionable subsystem contains information about the observance of limits during adjacent power measurements, the reference and local oscillator, the observance of limit lines and limit margins and possible overloads of the unit.

Commands of the STATus:QUEStionable Subsystem

- STATus:QUEStionable[:EVENT]?
- STATus:QUEStionable:CONDition?
- STATus:QUEStionable:ENABle
- STATus:QUEStionable:PTRansition
- STATus:QUEStionable:NTRansition
- STATus:QUEStionable:ACPLimit[:EVENT]?
- STATus:QUEStionable:ACPLimit:CONDition?
- STATus:QUEStionable:ACPLimit:ENABle
- STATus:QUEStionable:ACPLimit:NTRansition
- STATus:QUEStionable:ACPLimit:PTRansition
- STATus:QUEStionable:FREQuency[:EVENT]?
- STATus:QUEStionable:FREQuency:CONDition?
- STATus:QUEStionable:FREQuency:ENABle
- STATus:QUEStionable:FREQuency:NTRansition
- STATus:QUEStionable:FREQuency:PTRansition
- STATus:QUEStionable:LIMit<1|2>[:EVENT]?
- STATus:QUEStionable:LIMit<1|2>:CONDition?
- STATus:QUEStionable:LIMit<1|2>:ENABle
- STATus:QUEStionable:LIMit<1|2>:NTRansition
- STATus:QUEStionable:LIMit<1|2>:PTRansition
- STATus:QUEStionable:LMARgin<1|2>[:EVENT]?

- STATus:QUEStionable:LMARgin<1|2>:CONDition?
- STATus:QUEStionable:LMARgin<1|2>:ENABLE
- STATus:QUEStionable:LMARgin<1|2>:NTRansition
- STATus:QUEStionable:LMARgin<1|2>:PTRansition
- STATus:QUEStionable:POWer[:EVENT]?
- STATus:QUEStionable:POWer:CONDition?
- STATus:QUEStionable:POWer:ENABLE
- STATus:QUEStionable:POWer:NTRansition
- STATus:QUEStionable:POWer:PTRansition
- STATus:QUEStionable:SYNC[:EVENT]?
- STATus:QUEStionable:SYNC:CONDition?
- STATus:QUEStionable:SYNC:ENABLE
- STATus:QUEStionable:SYNC:NTRansition
- STATus:QUEStionable:SYNC:PTRansition

STATus:QUEStionable[:EVENT]?

This command queries the contents of the EVENT section of the STATus:QUEStionable register. The contents of the EVENT section are deleted after the readout.

Example

```
STAT:QUES?
```

Characteristics

*RST value: -
SCPI: conform

Mode

all

STATus:QUEStionable:CONDition?

This command queries the CONDition section of the STATus:QUEStionable register. Readout does not delete the contents of the CONDition section.

Example

```
STAT:QUES:COND?
```

Characteristics

*RST value: -
SCPI: conform

Mode

all

STATus:QUEStionable:ENABle

This command sets the bits of the ENABle section of the STATus:QUEStionable register. The ENABle register selectively enables the individual events of the associated EVENT section for the summary bit in the status byte.

Parameter

0 to 65535

Example

```
STAT:QUES:ENAB 65535
```

Characteristics

*RST value: -

SCPI: conform

Mode

all

STATus:QUEStionable:PTRansition

This command sets the edge detectors of all bits of the STATus:QUEStionable register from 0 to 1 for the transitions of the CONDition bit.

Parameter

0 to 65535

Example

```
STAT:QUES:PTR 65535
```

Characteristics

*RST value: -

SCPI: conform

Mode

all

STATus:QUEStionable:NTRansition

This command sets the edge detectors of all bits of the STATus:OPERation register from 1 to 0 for the transitions of the CONDition bit.

Parameter

0 to 65535

Example

```
STAT:QUES:NTR 65535
```

Characteristics

*RST value: -

SCPI: conform

Mode

all

STATus:QUEue[:NEXT?]

This command queries the earliest error queue entry and deletes it. Positive error numbers indicate device-specific errors, negative error numbers are error messages defined by SCPI. If the error queue is empty, the error number 0, "No error", is returned. This command is identical to the `SYSTem:ERRor[:NEXT]?` command.

Example

STAT:QUES?

Characteristics

*RST value: -

SCPI: conform

Mode

all

STATus:QUESTionable:ACPLimit[:EVENT?]

This command queries the contents of the EVENT section of the STATus:QUESTionable:ACPLimit register. Readout deletes the contents of the EVENT section.

Example

STAT:QUES:ACPL?

Characteristics

*RST value: -

SCPI: device-specific

Mode

all

STATus:QUESTionable:ACPLimit:CONDition?

This command queries the contents of the CONDition section of the STATus:QUESTionable:ACPLimit register. Readout does not delete the contents of the CONDition section.

Example

STAT:QUES:ACPL:COND?

Characteristics

*RST value: -

SCPI: device-specific

Mode

all

STATus:QUESTionable:ACPLimit:ENABLE

This command sets the bits of the ENABLE section of the STATus:QUESTionable:ACPLimit register. The ENABLE register selectively enables the individual events of the associated EVENT section for the summary bit.

Parameter

0 to 65535

Example

```
STAT:QUES:ACPL:ENAB 65535
```

Characteristics

*RST value: -

SCPI: device-specific

Mode

all

STATus:QUEStionable:ACPLimit:NTRansition

This command sets the edge detectors of all bits of the STATus:QUEStionable: ACPLimit register from 1 to 0 for the transitions of the CONDition bit.

Parameter

0 to 65535

Example

```
STAT:QUES:ACPL:NTR 65535
```

Characteristics

*RST value: -

SCPI: device-specific

Mode

all

STATus:QUEStionable:ACPLimit:PTRansition

This command sets the edge detectors of all bits of the STATus:QUEStionable: ACPLimit register from 0 to 1 for the transitions of the CONDition bit.

Parameter

0 to 65535

Example

```
STAT:QUES:ACPL:PTR 65535
```

Characteristics

*RST value: -

SCPI: device-specific

Mode

all

STATus:QUEStionable:FREQuency[:EVENT]?

This command queries the contents of the EVENT section of the STATus:QUEStionable: FREQuency register.

Readout deletes the contents of the EVENT section.

Example

```
STAT:QUES:FREQ?
```

Characteristics

*RST value: -
 SCPI: device-specific

Mode

all

STATus:QUEStionable:FREQuency:CONDition?

This command queries the contents of the CONDition section of the STATus:QUEStionable:FREQuency register. Readout does not delete the contents of the CONDition section.

Example

STAT:QUES:FREQ:COND?

Characteristics

*RST value: -
 SCPI: device-specific

Mode

all

STATus:QUEStionable:FREQuency:ENABle

This command sets the bits of the ENABle section of the STATus:QUEStionable:FREQuency register. The ENABle register selectively enables the individual events of the associated EVENT section for the summary bit.

Parameter

0 to 65535

Example

STAT:QUES:FREQ:ENAB 65535

Characteristics

*RST value: -
 SCPI: device-specific

Mode

all

STATus:QUEStionable:FREQuency:NTRansition

This command sets the edge detectors of all bits of the STATus:QUEStionable:FREQuency register from 1 to 0 for the transitions of the CONDition bit.

Parameter

0 to 65535

Example

STAT:QUES:FREQ:NTR 65535

Characteristics

*RST value: -
 SCPI: device-specific

Modeall, except NF

STATus:QUEStionable:FREQuency:PTRansition

This command sets the edge detectors of all bits of the STATus:QUEStionable:FREQuency register from 0 to 1 for the transitions of the CONDition bit.

Parameter

0 to 65535

Example

```
STAT:QUES:FREQ:PTR 65535
```

Characteristics

*RST value: -

SCPI: device-specific

Modeall, except NF

STATus:QUEStionable:LIMit<1|2>[:EVENT]?

This command queries the contents of the EVENT section of the STATus:QUEStionable:LIMit register. Readout deletes the contents of the EVENT section.

This command is available from firmware version 1.10.

Example

```
STAT:QUES:LIM?
```

Characteristics

*RST value: -

SCPI: device-specific

Modeall

STATus:QUEStionable:LIMit<1|2>:CONDition?

This command queries the contents of the CONDition section of the STATus:QUEStionable:LIMit register.

Readout does not delete the contents of the CONDition section.

This command is available from firmware version 1.10.

Example

```
STAT:QUES:LIM:COND?
```

Characteristics

*RST value: -

SCPI: device-specific

Modeall

STATus:QUEStionable:LIMit<1|2>:ENABle

This command sets the bits of the ENABle section of the STATus:QUEStionable register. The ENABle register selectively enables the individual events of the associated EVENT section for the summary bit.

This command is available from firmware version 1.10.

Parameter

0 to 65535

Example

STAT:QUES:LIM:ENAB 65535

Characteristics

*RST value: -

SCPI: device-specific

Mode

all

STATus:QUEStionable:LIMit<1|2>:NTRansition

This command sets the edge detectors of all bits of the STATus:QUEStionable:LIMit register from 1 to 0 for the transitions of the CONDition bit.

This command is available from firmware version 1.10.

Parameter

0 to 65535

Example

STAT:QUES:LIM:NTR 65535

Characteristics

*RST value: -

SCPI: device-specific

Mode

all, except NF

STATus:QUEStionable:LIMit<1|2>:PTRansition

This command sets the edge detectors of all bits of the STATus:QUEStionable:LIMit register from 0 to 1 for the transitions of the CONDition bit.

This command is available from firmware version 1.10.

Parameter

0 to 65535

Example

STAT:QUES:LIM:PTR 65535

Characteristics

*RST value: -

SCPI: device-specific

Mode

all, except NF

STATus:QUEStionable:LMARgin<1|2>[:EVENT]?

This command queries the contents of the EVENT section of the STATus:QUEStionable:LMARgin register. Readout deletes the contents of the EVENT section.

Example

```
STAT:QUES:LMAR?
```

Characteristics

*RST value: -

SCPI: device-specific

Mode

all

STATus:QUEStionable:LMARgin<1|2>:CONDition?

This command queries the contents of the CONDition section of the STATus:QUEStionable:LMARgin register. Readout does not delete the contents of the CONDition section.

Example

```
STAT:QUES:LMAR:COND?
```

Characteristics

*RST value: -

SCPI: device-specific

Mode

all

STATus:QUEStionable:LMARgin<1|2>:ENABle

This command sets the bits of the ENABle section of the STATus:QUEStionable:LMARgin register. The ENABle register selectively enables the individual events of the associated EVENT section for the summary bit.

Parameter

0 to 65535

Example

```
STAT:QUES:LMAR:ENAB 65535
```

Characteristics

*RST value: -

SCPI: device-specific

Mode

all

STATus:QUEStionable:LMARgin<1|2>:NTRansition

This command sets the edge detectors of all bits of the STATus:QUEStionable:LMARgin register from 1 to 0 for the transitions of the CONDition bit.

Parameter

0 to 65535

Example

STAT:QUES:LMAR:NTR 65535

Characteristics

*RST value: -

SCPI: device-specific

Mode

all

STATus:QUESTionable:LMARgin<1|2>:PTRansition

This command sets the edge detectors of all bits of the STATus:QUESTionable:LMARgin register from 0 to 1 for the transitions of the CONDition bit.

Parameter

0 to 65535

Example

STAT:QUES:LMAR:PTR 65535

Characteristics

*RST value: -

SCPI: device-specific

Mode

all

STATus:QUESTionable:POWer[:EVENT]?

This command queries the contents of the EVENT section of the STATus:QUESTionable:POWer register. Readout deletes the contents of the EVENT section.

Example

STAT:QUES:POW?

Characteristics

*RST value: -

SCPI: conform

Mode

all

STATus:QUESTionable:POWer:CONDition?

This command queries the contents of the CONDition section of the STATus:QUESTionable:POWer register. Readout does not delete the contents of the CONDition section.

Example

STAT:QUES:POW:COND?

Characteristics

*RST value: -

SCPI: conform

Modeall

STATus:QUEStionable:POWer:ENABle

This command sets the bits of the ENABle section of the STATus:QUEStionable:POWer register. The ENABle register selectively enables the individual events of the associated EVENT section for the summary bit.

Parameter

0 to 65535

Example`STAT:QUES:POW:ENAB 65535`**Characteristics**

*RST value: -

SCPI: conform

Modeall

STATus:QUEStionable:POWer:NTRansition

This command sets the edge detectors of all bits of the STATus:QUEStionable:POWer register from 1 to 0 for the transitions of the CONDition bit.

Parameter

0 to 65535

Example`STAT:QUE:POWS:NTR 65535`**Characteristics**

*RST value: -

SCPI: conform

Modeall

STATus:QUEStionable:POWer:PTRansition

This command sets the edge detectors of all bits of the STATus:QUEStionable:POWer register from 0 to 1 for the transitions of the CONDition bit.

Parameter

0 to 65535

Example`STAT:QUES:POW:PTR 65535`**Characteristics**

*RST value: -

SCPI: conform

Modeall

STATus:QUEStionable:SYNC[:EVENT]?

This command queries the contents of the EVENT section of the STATus:QUEStionable:SYNC register.

Readout deletes the contents of the EVENT section.

This command is available from firmware version 1.30.

Example

STAT:QUES:SYNC?

Characteristics

*RST value: -

SCPI: device-specific

Mode

all

STATus:QUEStionable:SYNC:CONDition?

This command queries the contents of the CONDition section of the STATus:QUEStionable:SYNC register. Readout does not delete the contents of the CONDition section.

This command is available from firmware version 1.30.

Example

STAT:QUES:SYNC:COND?

Characteristics

*RST value: -

SCPI: device-specific

Mode

all

STATus:QUEStionable:SYNC:ENABLE

This command sets the bits of the ENABLE section of the STATus:QUEStionable:SYNC register. The ENABLE register selectively enables the individual events of the associated EVENT section for the summary bit.

This command is available from firmware version 1.30.

Parameter

0 to 65535

Example

STAT:QUES:SYNC:ENAB 65535

Characteristics

*RST value: -

SCPI: device-specific

Mode

all

STATus:QUEStionable:SYNC:NTRansition

This command sets the edge detectors of all bits of the STATus:QUEStionable:SYNC register from 1 to 0 for the transitions of the CONDition bit.

This command is available from firmware version 1.30.

Parameter

0 to 65535

Example

```
STAT:QUES:SYNC:NTR 65535
```

Characteristics

*RST value: -

SCPI: device-specific

Mode

all

STATus:QUEStionable:SYNC:PTRansition

This command sets the edge detectors of all bits of the STATus:QUEStionable:SYNC register from 0 to 1 for the transitions of the CONDition bit.

This command is available from firmware version 1.30.

Parameter

0 to 65535

Example

```
STAT:QUES:SYNC:PTR 65535
```

Characteristics

*RST value: -

SCPI: device-specific

Mode

all

SYSTEM Subsystem

This subsystem contains a series of commands for general functions.

Commands of the SYSTEM Subsystem

- SYSTem:COMMunicate:GPIB[:SELF]:ADDRess
- SYSTem:COMMunicate:GPIB[:SELF]:RTERminator
- SYSTem:COMMunicate:PRINter:ENUMerate[:NEXT?]
- SYSTem:COMMunicate:PRINter:ENUMerate:FIRSt?
- SYSTem:COMMunicate:PRINter:SELEct <1|2>
- SYSTem:DATE
- SYSTem:DISPlay:FPANel
- SYSTem:DISPlay:UPDate
- SYSTem:ERRor[:NEXT]?
- SYSTem:ERRor:CLEar:ALL
- SYSTem:ERRor:LIST?
- SYSTem:FIRMware:UPDate
- SYSTem:FORMat:IDENt
- SYSTem:LANGuage
- SYSTem:LXI:INFo?
- SYSTem:LXI:LANReset
- SYSTem:LXI:PASSword
- SYSTem:LXI:MDEscription
- SYSTem:PASSword[:CENable]
- SYSTem:PASSword:RESet
- SYSTem:PRESet
- SYSTem:TIME
- SYSTem:VERSion?

SYSTem:COMMunicate:GPIB[:SELF]:ADDRess

This command changes the GPIB address of the unit.

Parameter

0 to 30

Example

SYST:COMM:GPIB:ADDR 18

Characteristics

*RST value: - (no influence on this parameter, factory default 20)

SCPI: conform

Mode

all

SYSTem:COMMunicate:GPIB[:SELF]:RTERminator

This command changes the GPIB receive terminator.

According to the standard the terminator in ASCII is <LF> and/or <EOI>. For binary data transfers (e.g. trace data) from the control computer to the instrument, the binary code (0AH) used for <LF> might be included in the binary data block, and therefore should not be interpreted as a terminator in this particular case. This can be avoided by changing the receive terminator to EOI.

Output of binary data from the instrument to the control computer does not require such a terminator change.

Parameter

LFEOI | EOI

Example

```
SYST:COMM:GPIB:RTER EOI
```

Characteristics

*RST value: - (no influence on this parameter, factory default LFEOI)

SCPI: device-specific

Mode

all

SYSTem:COMMunicate:PRINter:ENUMerate[:NEXT?]

This command queries the name of the next printer installed under Windows XP. After all available printer names have been output, an empty string enclosed by quotation marks (") is output for the next query. Further queries are answered by a query error.

The [SYSTem:COMMunicate:PRINter:ENUMerate:FIRSt?](#) command should be sent previously to return to the beginning of the printer list and query the name of the first printer.

Example

```
SYST:COMM:PRIN:ENUM?
```

Characteristics

*RST value: NONE

SCPI: device-specific

Mode

all

SYSTem:COMMunicate:PRINter:ENUMerate:FIRSt?

This command queries the name of the first printer (in the list of printers) available under Windows XP.

The names of other installed printers can be queried with the [SYSTem:COMMunicate:PRINter:ENUMerate\[:NEXT?\]](#) command.

If no printer is configured an empty string is output.

Example

```
SYST:COMM:PRIN:ENUM:FIRS?
```

Characteristics

*RST value: NONE

SCPI: device-specific

Mode

all

SYSTEM:COMMunicate:PRINter:SElect <1|2>

This command selects one of the printers configured under Windows XP including the associated output destination.

The specified printer name must be a string as returned by the commands

`SYSTEM:COMMunicate:PRINter:ENUMerate:FIRSt?` or

`SYSTEM:COMMunicate:PRINter:ENUMerate[:NEXT?]`

Note: *The `HCOPY:DESTination<1|2>` command is used to select an output medium other than the default one.*

Parameter

<printer_name>

Example

`SYST:COMM:PRIN:SEL LASER on LPT1`

Characteristics

*RST value: NONE

SCPI: device-specific

Mode

all

SYSTEM:DATE

This command is used to enter the date for the internal calendar.

The sequence of entry is year, month, day.

Only a user account with administrator rights can set the date.

Parameter

1980 to 2099, 1 to 12, 1 to 31

Example

`SYST:DATE 2000,6,1`

Characteristics

*RST value: -

SCPI: conform

Mode

all

SYSTEM:DISPlay:FPANel

This command activates or deactivates the display of the front panel keys on the screen.

With the display activated, the instrument can be operated on the screen using the mouse by pressing the corresponding buttons.

Parameter

ON | OFF

Example

```
SYST:DISP:FPAN ON
```

Characteristics

*RST value: OFF

SCPI: device-specific

Mode

all

SYSTem:DISPlay:UPDate

In remote control mode, this command switches on or off the instrument display. If switched on, only the diagrams, traces and display fields are displayed and updated.

Note: *The best performance is obtained if the display output is switched off during remote control.*

Parameter

ON | OFF

Example

```
SYST:DISP:UPD ON
```

Characteristics

*RST value: OFF

SCPI: device-specific

Mode

all

SYSTem:ERRor[:NEXT]?

This command queries the earliest error queue entry and deletes it.

Positive error numbers indicate device-specific errors, negative error numbers are error messages defined by SCPI. If the error queue is empty, the error number 0, "No error", is returned.

This command is a query and therefore has no *RST value.

Example

```
STAT:ERR?
```

Characteristics

*RST value: -

SCPI: conform

Mode

all

SYSTEM:ERRor:CLEar:ALL

This command deletes all entries in the table SYSTEM MESSAGES.

This command is an event and therefore has no query and no *RST value.

Example

```
SYST:ERR:CLE:ALL
```

Characteristics

*RST value: -

SCPI: device-specific

Mode

all

SYSTEM:ERRor:LIST?

This command reads all system messages and returns a list of comma separated strings. Each string corresponds to an entry in the table SYSTEM MESSAGES.

If the error list is empty, an empty string "" will be returned.

This command is a query and therefore has no *RST value.

Example

```
SYST:ERR:LIST?
```

Characteristics

*RST value: -

SCPI: device-specific

Mode

all

SYSTEM:FIRMware:UPDate

This command starts a firmware update using the *.msi files in the selected directory. The default path is D:\FW_UPDATE. The path is changed via the [MMEMory:CDIRectory](#) command. To store the update files the [MMEMory:DATA](#) command is used.

Only a user account with administrator rights can perform a firmware update.

This command is an event and therefore has no query and no *RST value.

Example

```
SYST:FIRM:UPD 'D:\FW_UPDATE'
```

Starts the firmware update from directory D:\FW_UPDATE.

Characteristics

*RST value: -

SCPI: device-specific

Mode

all

SYSTem:FORMat:IDENt

This command defines the response format to the *IDN? command. This function is intended for re-use of existing control programs together with the R&S FSL.

Parameter

LEGacy format is compatible to the R&S FSP/FSU/FSQ family
 NEW R&S FSL format

Example

```
SYST:FORM:IDEN LEG
```

Adapts the return value of *IDN? to the R&S FSP/FSU/FSQ family.

Characteristics

RST value: LEG
 SCPI: device-specific

Mode

all

SYSTem:LANGuage

This command defines the system language.

Parameter

SCPI

Example

```
SYST:LANG 'SCPI'
```

Sets the system language to SCPI.

Characteristics

RST value: SCPI
 SCPI: device-specific

Mode

all

SYSTem:LXI:INFo?

This query returns the current parameters of the LXI class C.

This command is available from firmware version 1.90.

Return values (example)

```
"<current version>|<LXI class>|<Computername>|<MAC address>|<IP address>|<Auto MDIX>"
```

Characteristics

RST value: -
 SCPI: device-specific

Mode

all

SYSTEM:LXI:LANReset

This command resets the LAN configuration to the values required by the LXI standard. In addition, the password is reset to its initial state as well as the LXI instrument description.

Only a user accounts with administrator rights can reset the LAN configuration.

This command is an event and therefore has no *RST value and no query.

This command is available from firmware version 1.90.

Example

```
SYST:LXI:LANR
```

Characteristics

*RST value: -

SCPI: device-specific

Mode

all

SYSTEM:LXI:MDEScript

This command shows the LXI instrument description. Also, the instrument description can be changed using this command.

This command is available from firmware version 1.90.

Parameter

<string>

Example

```
SYST:LXI:MDES
```

Characteristics

*RST value: -

SCPI: device-specific

Mode

all

SYSTEM:LXI:PASSWORD

This command shows or changes the LXI password.

This command is available from firmware version 1.90.

Parameter

<password>

Example

```
SYST:LXI:PASS
```

Characteristics

*RST value:

SCPI: device-specific

Mode

all

SYSTEM:PASSword[:CENable]

This command enables access to the service functions by means of the password.
This command is an event and therefore has no *RST value and no query.

Parameter

<password>

Example

```
SYST:PASS XXXX
```

Characteristics

*RST value: -

SCPI: conform

Mode

all

SYSTEM:PASSword:RESet

This command resets the service password.
This command is an event and therefore has no *RST value and no query.

Example

```
SYST:PASS:RES
```

Characteristics

*RST value: -

SCPI: conform

Mode

all

SYSTEM:PRESet

This command initiates an instrument reset.
The effect of this command corresponds to that of the **PRESET** key with manual operation or to the *RST command. For details on preset settings refer to chapter 4 "Instrument Functions - Analyzer", section "Initializing the Configuration - PRESET Key".

Example

```
SYST:PRES
```

Characteristics

*RST value: -

SCPI: conform

Mode

all

SYSTem:TIME

This command sets the internal clock. The sequence of entry is hour, minute, second.
Only a user account with administrator rights can set the time.

Parameter

0 to 23, 0 to 59, 0 to 59

Example

```
SYST:TIME 12,30,30
```

Characteristics

*RST value: -

SCPI: conform

Mode

all

SYSTem:VERSion?

This command queries the number of the SCPI version, which is relevant for the instrument.
This command is a query and therefore has no *RST value.

Example

```
SYST:VERS?
```

Characteristics

*RST value: -

SCPI: conform

Mode

all

SYSTem:SPEaker Subsystem

This subsystem controls the headset functions.

Commands of the SYSTem:SPEaker Subsystem

- [SYSTem:SPEaker:VOLume](#)

SYSTem:SPEaker:VOLume

This command sets the volume of the headset for demodulated signals.

Parameter

0 to 1; value 0 is the lowest volume, value 1 the highest volume.

Example

```
SYST:SPE:VOL 0.5
```

Characteristics

*RST value: 0

SCPI: device-specific

Mode

all

TRACe Subsystem

The TRACe subsystem controls access to the instruments internal trace memory.

The following subsystem is included:

- ["TRACe:IQ Subsystem"](#) on page 6.258

Commands of the TRACe Subsystem

- [TRACe<1|2>\[:DATA\]](#)
- [TRACe:COPY](#)

TRACe<1|2>[:DATA]

This command transfers trace data from the control computer to the instrument, the query reads trace data out of the instrument. The transfer of trace data from the control computer to the instrument takes place by indicating the trace name and then the data to be transferred.

For details on saving and recalling data refer to chapter 5 "Remote Control - Basics", section "MMEMory Subsystem".

Parameter

TRACE1 | TRACE2 | TRACE3 | TRACE4 | TRACE5 | TRACE6 | LIST | SPURious,<block> | <numeric_value>

TRACE1, ... , TRACE6 trace memory to be read out

<block> or <numeric_value> data to be transferred

query only:

LIST lists all results of the Spectrum Emission Mask and Spurious Emissions measurement

SPURious lists all peaks of the Spurious Emissions measurement

Return values for trace data

The number of returned results depends on the sweep points that have been set. By default 501 results are returned. The returned values are scaled in the current level unit.

FORMat REAL, 32 is used as format for binary transmission, and FORMat ASCii for ASCII transmission. For details on formats refer to ["Formats for returned values: ASCII format and binary format"](#) on page 6.294.

Note: *With the auto peak detector, only positive peak values can be read out.*

Return values for Spectrum Emission Mask/Spurious Emissions measurement results

Returns the list evaluation results.

<no>, <start>, <stop>, <rbw>, <freq>, <power abs>, <power rel>, <delta>, <limit check>, <unused1>, <unused2>

Value	Description
<no>	range number
<start>	start frequency
<stop>	stop frequency
<rbw>	resolution bandwidth of range
<freq>	frequency of peak
<power abs>	absolut power in dBm of peak

<power rel>	relative power in dBc (related to the channel power) of peak
<delta>	distance to the limit line in dB (positive indicates value above the limit, fail)
<limit check>	limit fail (pass = 0, fail =1)
<unused1>	reserved (0.0)
<unused2>	reserved (0.0)

Example

```
TRAC TRACE1
TRAC? TRACE1
```

Characteristics

*RST value: -
 SCPI: conform

Mode

all

TRACe:COPY

This command copies data from one trace to another.

This command is an event and therefore has no query and no *RST value.

Parameter

TRACE1 | TRACE2 | TRACE3 | TRACE4 | TRACE5 | TRACE6,TRACE1 | TRACE2 | TRACE3 |
 TRACE4 | TRACE5 | TRACE6

The first operand the destination of the data to be copied, the second operand describes the source.

Example

```
TRAC:COPY TRACE1,TRACE2
```

Characteristics

*RST value: -
 SCPI: conform

Mode

A, CATV

TRACe:IQ Subsystem

The commands of this subsystem are used for collection and output of measured IQ data. A special memory is therefore available in the instrument for about 512k complex samples (pairs of I and Q data). The measurement is always performed in zero span at the selected center frequency. The number of complex samples to be collected and the sample rate can be set (for details refer to "Sample rate and maximum usable bandwidth" on page 6.260). Prior to being stored in memory or output via GPIB, the measurement data are corrected in terms of frequency response.

The block diagrams below show the analyzer hardware from the IF section to the processor. The block diagrams differ between the instrument models because two different motherboards are fitted. The main difference is the position of the fractional resampling and the analog IF bandwidth. For details on the distinction refer to "Sample rate and maximum usable bandwidth" on page 6.260.

The A/D converter samples the IF signal (47.9 MHz) at a rate of $65.8\bar{3}$ MHz. The digital signal is down-converted to the complex baseband, lowpass-filtered, and the sampling rate is reduced. The continuously adjustable sampling rates are realized using an optimal decimation filter and subsequent resampling on the set sampling rate.

The I/Q data are written to separate memories of 512 k words each. The memories are hardware-triggered. 512 samples are designated as buffer for triggering, which leads to a max. recording length of 523776 (=512k - 512) complex samples.

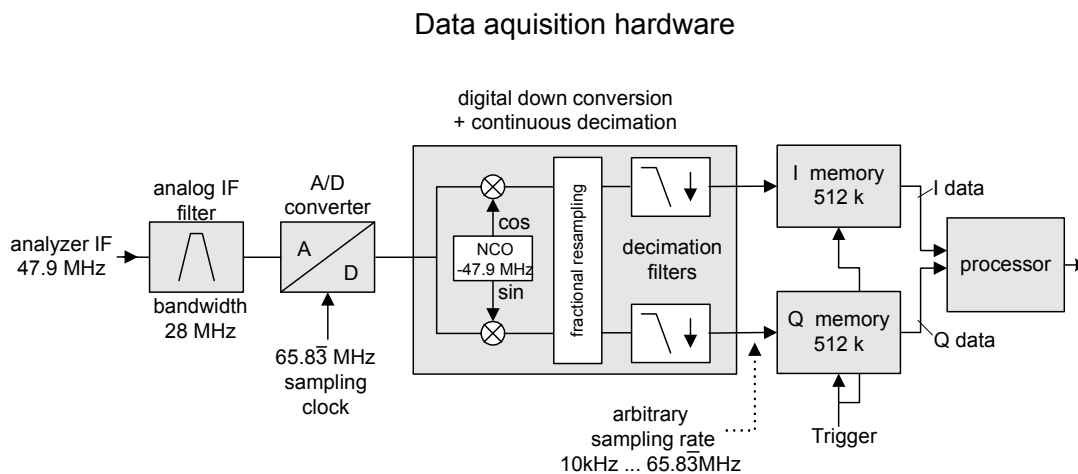

Fig. 6-1 Signal processing in models with UDC motherboards

Data acquisition hardware

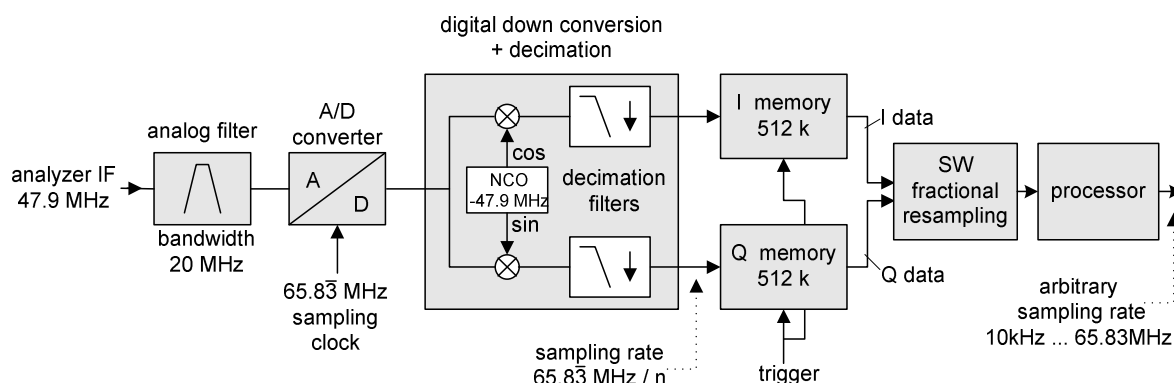

Fig. 6-2 Signal processing in models with WDDC motherboards

The trigger sources EXT (external trigger) and IFP (IF Power Trigger) can be used for triggering, additionally IMM (Free Run). The number of complex sample to be recorded prior to the trigger event can be selected (`TRACe<1|2>:IQ:SET` command) for all available trigger sources, except for FREE RUN.

The measurement results are output in the form of a list, with the Q values following immediately after the list of I values in the output buffer. The `FORMAT` command can be used to select between binary output (32 bit IEEE 754 floating-point values) and output in ASCII format.

For details on formats refer to "[Formats for returned values: ASCII format and binary format](#)" on page 6.294.

The commands of this subsystem can be used in two ways:

- Measurement and result query with one command:
This method causes the least delay between measurement and output of the result data, but it requires the control computer to wait actively for the response data.
- Setting up the instrument, start of the measurement via `INIT` and query of the result list at the end of the measurement:
With this method the control computer can be used for other activities during the measurement. In this case the additional time needed for synchronization via service request must be taken into account.

Commands of the TRACe:IQ Subsystem

- `TRACe<1|2>:IQ[:STATe]`
- `TRACe<1|2>:IQ:AVERAge[:STATe]`
- `TRACe<1|2>:IQ:AVERAge:COUNT`
- `TRACe<1|2>:IQ:DATA?`
- `TRACe<1|2>:IQ:DATA:MEMory?`
- `TRACe<1|2>:IQ:SET`
- `TRACe<1|2>:IQ:SRATe`

Further information

- [Sample rate and maximum usable bandwidth](#)

Sample rate and maximum usable bandwidth

Within the usable bandwidth range, the analog IF filter of the R&S FSL is equalized in regard to amplitude characteristic and group delay (provided that the R&S FSL is aligned; for details see chapter 4, section "Instrument Setup and Interface Configuration - SETUP Key", "Alignment"). In consequence, signals within this bandwidth range are hardly distorted at all (provided the R&S FSL is not overloaded).

For the I/Q data acquisition, digital decimation filters are used internally. The passband of these digital filters corresponds to the maximum usable bandwidth. In consequence, signals within the usable bandwidth (passband) remain unchanged, while signals outside the usable bandwidth (passband) are suppressed. Usually, the suppressed signals are noise, artifacts, and the second IF side band. If frequencies of interest to you are also suppressed, you should try to increase the output sample rate, since this increases the maximum usable IQ bandwidth.

As a rule, the usable bandwidth is proportional to the output sample rate (see section [Instrument models with UDC motherboard](#) or [Instrument models with WDDC motherboard](#)). Yet, when the I/Q bandwidth reaches the bandwidth of the analog IF filter (at very high output sample rates), the curve breaks. For the base unit, the sample rate ranges from 10 kHz to 65.83 MHz .

The maximum usable bandwidth is listed in the data sheet. The value differs between the instrument models due to different motherboards:

- UDC motherboard (order # 2112.1800)
- WDDC motherboard (order # 1300.3080)

If you are not sure which motherboard your model has, check the **Hardware Information** list (**SETUP** key - More - **System Info** - **Hardware Info**; for details see chapter 4).

Instrument models with UDC motherboard

The following diagram shows the maximum usable IQ bandwidths depending on the output sample rates. The values are rounded off to two decimal places.

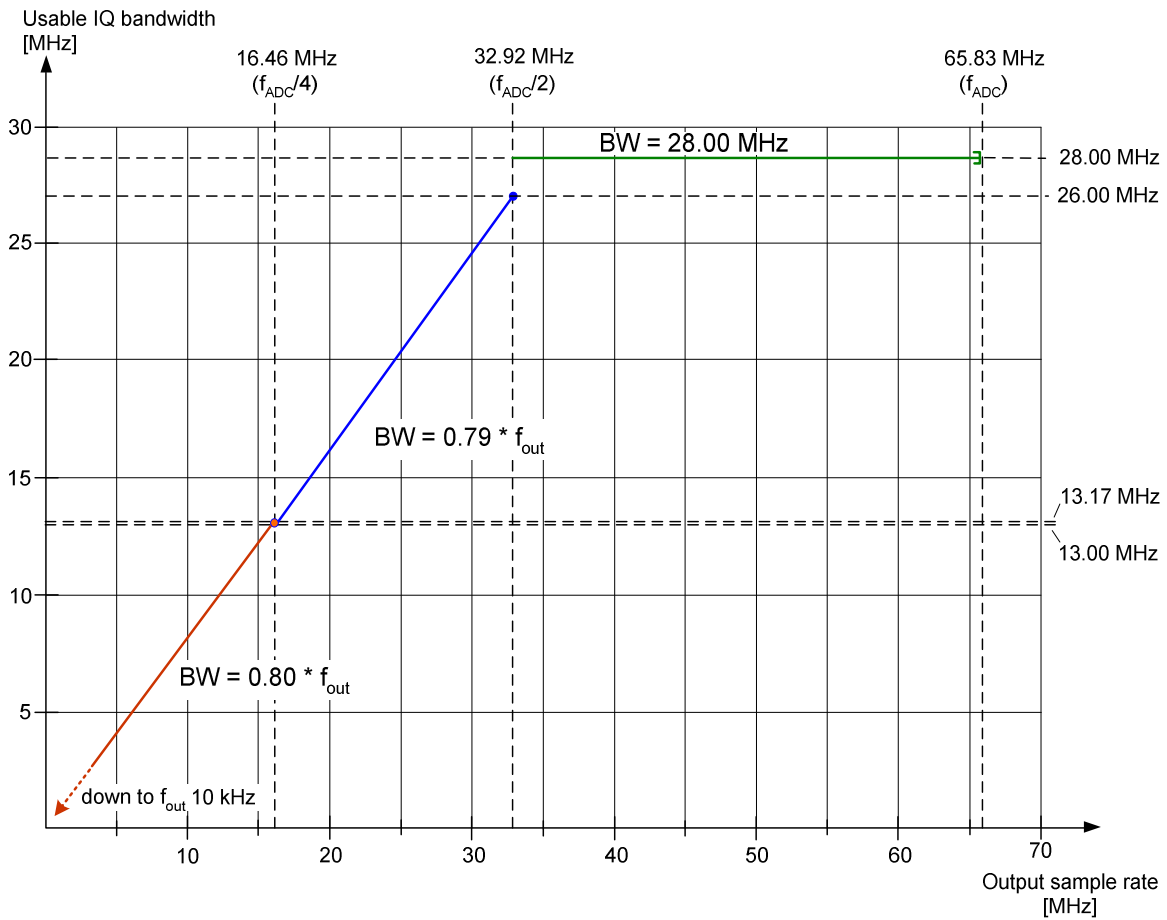

Fig. 6-3 Relation between maximum usable bandwidth and output sample rate



Do not use an output sample rate in the range from 65.833333.0 MHz to 65.83 MHz for measurements. This range is for test purposes only.

At this sample rate, the whole bandwidth of the IF filter is equalized, but the digital filters are switched to bypass. In consequence, not only the effective signal but all signals pass, including noise and image-spectra.

Instrument models with WDDC motherboard

The following tables list the maximum bandwidths depending on the output sample rates.

- 65,833,333.333 MHz to 65,833,333.000 MHz
- 65,833,332.999 MHz to 10.7 MHz
- 10.7 MHz to 3.2 MHz
- 3.2 MHz to 1 MHz
- 1 MHz to 105 kHz
- 105 kHz to 10 kHz

65,833,333.333 MHz to 65,833,333.000 MHz

This small range of the sample rate is for test purposes only and is not recommended for normal measurements!

Sample rate from [Hz]	Sample rate to [Hz]	Max bandwidth [Hz]
65 833 333.333	65 833 333.000	20 000 000.000 Beware: decimation filters are bypassed!

65,833,332.999 MHz to 10.7 MHz

Sample rate from [Hz]	Sample rate to [Hz]	Max bandwidth [Hz]
65 833 332.999	32 916 666.670	20 000 000.000
22 500 000.000	20 248 687.500	17 998 833.330
20 248 687.500	16 401 436.880	14 579 055.000
16 401 436.880	14 812 500.000	13 166 666.670
14 812 500.000	13 331 250.000	11 850 000.000
13 331 250.000	11 998 125.000	10 665 000.000
11 998 125.000	10 798 312.500	9 598 500.000

10.7 MHz to 3.2 MHz

Sample rate from [Hz]	Sample rate to [Hz]	Max bandwidth [Hz]
10 798 312.500	9 875 000.000	8 777 777.778
9 875 000.000	8 887 500.000	7 900 000.000
8 887 500.000	7 998 750.000	7 110 000.000
7 998 750.000	7 406 250.000	6 583 333.333
7 406 250.000	6 665 625.000	5 925 000.000
6 665 625.000	6 583 333.333	5 851 851.852
6 583 333.333	5 925 000.000	5 266 666.667
5 925 000.000	5 332 500.000	4 740 000.000
5 332 500.000	4 937 500.000	4 388 888.889
4 937 500.000	4 443 750.000	3 950 000.000
4 443 750.000	4 232 142.857	3 761 904.762
4 232 142.857	3 950 000.000	3 511 111.111
3 950 000.000	3 703 125.000	3 291 666.667
3 703 125.000	3 332 812.500	2 962 500.000
3 332 812.500	3 291 666.667	2 925 925.926

3.2 MHz to 1 MHz

Sample rate from [Hz]	Sample rate to [Hz]	Max bandwidth [Hz]
3 291 666.667	2 962 500.000	2 633 333.333
2 962 500.000	2 821 428.571	2 507 936.508

Sample rate from [Hz]	Sample rate to [Hz]	Max bandwidth [Hz]
2 821 428.571	2 539 285.714	2 257 142.857
2 539 285.714	2 468 750.000	2 194 444.444
2 468 750.000	2 370 000.000	2 106 666.667
2 370 000.000	2 194 444.444	1 950 617.284
2 194 444.444	2 116 071.429	1 880 952.381
2 116 071.429	1 975 000.000	1 755 555.556
1 975 000.000	1 851 562.500	1 645 833.333
1 851 562.500	1 795 454.545	1 595 959.596
1 795 454.545	1 645 833.333	1 462 962.963
1 645 833.333	1 481 250.000	1 316 666.667
1 481 250.000	1 346 590.909	1 196 969.697
1 346 590.909	1 234 375.000	1 097 222.222
1 234 375.000	1 139 423.077	1 012 820.513
1 139 423.077	1 039 473.684	923 976.608

1 MHz to 105 kHz

Sample rate from [Hz]	Sample rate to [Hz]	Max bandwidth [Hz]
1 039 473.684	940 476.191	835 978.836
940 476.191	846 428.571	752 380.952
846 428.571	779 605.263	692 982.456
779 605.263	705 357.143	626 984.127
705 357.143	637 096.774	566 308.244
637 096.774	580 882.353	516 339.869
580 882.353	529 017.857	470 238.095
529 017.857	477 822.581	424 731.183
477 822.581	435 661.765	387 254.902
435 661.765	395 000.000	351 111.111
395 000.000	359 090.909	319 191.919
359 090.909	323 770.492	287 795.993
323 770.492	294 776.119	262 023.217
294 776.119	266 891.892	237 237.237
266 891.892	240 853.659	214 092.141
240 853.659	217 032.967	192 918.193
217 032.967	195 544.555	173 817.382
195 544.555	176 339.286	156 746.032
176 339.286	159 274.194	141 577.061
159 274.194	143 810.680	127 831.715
143 810.680	129 934.211	115 497.076
129 934.211	117 559.524	104 497.355
117 559.524	105 803.571	94 047.619

105 kHz to 10 kHz

Sample rate from [Hz]	Sample rate to [Hz]	Max bandwidth [Hz]
105 803.571	95 410.628	84 809.447
95 410.628	85 869.565	76 328.502
85 869.565	77 450.980	68 845.316
77 450.980	69 787.986	62 033.765
69 787.986	62 898.089	55 909.413
62 898.089	56 752.874	50 446.999
56 752.874	51 077.586	45 402.299
51 077.586	46 001.553	40 890.269
46 001.553	41 404.612	36 804.100
41 404.612	37 264.151	33 123.690
37 264.151	33 588.435	29 856.387
33 588.435	30 229.592	26 870.748
30 229.592	27 228.860	24 203.431
27 228.860	24 524.007	21 799.117
24 524.007	22 075.261	19 622.454
22 075.261	19 869.215	17 661.525
19 869.215	17 889.493	15 901.771
17 889.493	16 100.543	14 311.594
16 100.543	14 493.640	12 883.235
14 493.640	13 044.914	11 595.479
13 044.914	11 741.974	10 437.310
11 741.974	10 572.805	9 398.049
10 572.805	10 000.000	8 460.509

TRACe<1|2>:IQ[:STATe]

This command switches the I/Q data acquisition on or off.

Note: *The I/Q data acquisition is not compatible with other measurement functions. Therefore all other measurement functions will be switched off as soon as the I/Q measurement function is switched on. Additionally a trace display is not possible in this operating mode. Therefore all traces are set to "BLANK".*

Parameter

ON | OFF

Example

TRAC: IQ ON
Switches on I/Q data acquisition

Characteristics

*RST value: OFF
SCPI: device-specific

Mode

A-T

TRACe<1|2>:IQ:AVERage[:STATe]

The command enables averaging of the recorded I/Q data provided that I/Q data acquisition was previously enabled with [TRACe<1|2>:IQ\[:STATe\]](#).

Parameter

ON | OFF

Example

TRAC: IQ ON

Switches on acquisition of I/Q data.

TRAC: IQ: AVER ON

Enables averaging of the I/Q measurement data.

TRAC: IQ: AVER: COUN 10

Selects averaging over 10 data sets.

TRAC: IQ: DATA?

Starts the measurement and reads out the averaged data.

Characteristics

*RST value: OFF

SCPI: device-specific

Mode

A-T

TRACe<1|2>:IQ:AVERage:COUNT

This command defines the number of I/Q data sets that are to serve as a basis for averaging.

Parameter

0 to 32767

Example

TRAC: IQ ON

Switches on acquisition of I/Q data.

TRAC: IQ: AVER ON

Enables averaging of the I/Q measurement data

TRAC: IQ: AVER: COUN 10

Selects averaging over 10 data sets

TRAC: IQ: DATA?

Starts the measurement and reads out the averaged data.

Characteristics

*RST value: 0

SCPI: conform

Mode

A-T

TRACe<1|2>:IQ:DATA?

This command starts a measurement with the settings defined via [TRACe<1|2>:IQ:SET](#) and returns the list of measurement results immediately after they are corrected in terms of frequency response. The number of measurement results depends on the settings defined with [TRACe<1|2>:IQ:SET](#), the output format depends on the settings of the FORMat subsystem.

Note: The command requires that all response data are read out completely before the instrument accepts further commands.

Return values

The result values are scaled linear in unit *Volt* and correspond to the voltage at the RF input of the instrument. In ASCII format, the number of the returned values is 2 * the number of samples. The first set contains the I-data, the second the Q-data.

Note: If the sampling rate exceeds 512k (≈ 524288), the data are output in 512k blocks.

In binary format, the number of I- and Q-data can be calculated as follows:

$$\# \text{ of I-Data} = \# \text{ of Q-Data} = \frac{\# \text{ of DataBytes}}{8}$$

The offset of Q-data in the output buffer can be calculated as follows:

$$Q\text{-Data-Offset} = \frac{(\# \text{ of DataBytes})}{2} + \text{LengthIndicatorDigits}$$

with LengthIndicatorDigits being the number of digits of the length indicator including the #. In the example above (#41024...) this results in a value of 6 for LengthIndicatorDigits and the offset for the Q-data will result in 512 + 6 = 518.

For further details on formats refer to "[Formats for returned values: ASCII format and binary format](#)" on page 6.294.

Example

```
TRAC:IQ:STAT ON
```

Enables acquisition of I/Q data

```
TRAC:IQ:SET NORM,10MHz,32MHz,EXT,POS,0,4096
```

Measurement configuration:

Sample Rate: 32 MHz

Trigger Source: External

Trigger Slope: Positive

Pretrigger Samples: 0

of Samples: 4096

```
FORMat REAL,32
```

Selects format of response data

```
TRAC:IQ:DATA?
```

Starts measurement and reads results

Characteristics

*RST value: -

Note: Using the command with the *RST values for the TRACe<1|2>:IQ:SET command, the following minimum buffer sizes for the response data are recommended: ASCII format 10 kBytes, binary format: 2 kBytes

SCPI: device-specific

Mode

A-T

TRACe<1|2>:IQ:DATA:MEMory?

This command permits the readout of previously acquired (and frequency response corrected) I/Q data from the memory, with indication of the offset related to the start of measurement and with indication of the number of measurement values. Therefore a previously acquired data set can be read out in smaller portions. The maximum amount of available data depends on the

settings of the `TRACe<1 | 2>:IQ:SET` command, the output format on the settings in the `FORMat` subsystem.

Note: *The command requires that all response data are read out completely before the instrument accepts further commands.
If there are not I/Q data available in memory because the corresponding measurement had not been started, the command will cause a query error.*

Parameter

- <offset samples> Offset of the values to be read related to the start of the acquired data.
Value range: 0 to <# of samples> - 1, with <# of samples> being the value indicated with the `TRACe<1 | 2>:IQ:SET` command.
- <# of samples> Number of measurement values to be read.
Value range: 1 to <# of samples> - <offset samples> with <# of samples> being the value indicated with the `TRACe<1 | 2>:IQ:SET` command.

Return values

The returned values are scaled linear in unit Volt and correspond to the voltage at the RF input of the instrument.

The format of the output buffer corresponds to the `TRACe<1 | 2>:IQ:DATA?` command.

Example

```
TRAC:IQ:STAT ON
```

Enables acquisition of I/Q data

```
TRAC:IQ:SET NORM,10MHz,32MHz,EXT,POS,100,4096
```

To configure the measurement:

Sample Rate: 32 MHz

Trigger Source: External

Slope: Positive

Pretrigger Samples: 100

of Samples: 4096

```
INIT;*WAI
```

Starts measurement and wait for sync

```
FORMat REAL,32
```

Determines output format

To read the results:

```
TRAC:IQ:DATA:MEM? 0,2048
```

Reads 2048 I/Q data starting at the beginning of data acquisition

```
TRAC:IQ:DATA:MEM? 2048,1024
```

Reads 1024 I/Q data from half of the recorded data

```
TRAC:IQ:DATA:MEM? 100,512
```

Reads 512 I/Q data starting at the trigger point (<Pretrigger Samples> was 100)

Characteristics

*RST value: -

SCPI: device-specific

Mode

A-T, WLAN, OFDM, OFDMA/WiBro

TRACe<1|2>:IQ:SET

This command defines the settings of the analyzer hardware for the measurement of I/Q data. This allows setting the bandwidth of the analog filters in front of the A/D converter as well as setting the sample rate, trigger conditions and the record length.

Note: *If this command is omitted, the current analyzer settings will be used for the corresponding parameters.*

This command switches to IQ mode automatically (see also [TRACe<1|2>:IQ\[:STATe\]](#)).

The parameter <filter_type> has no effect but is indicated for reasons of compatibility with the FSP family.

The trigger level can be set using the [TRIGger<1|2>\[:SEquence\]:LEVel:IFPower](#) command.

Parameter

<filter type>	can be omitted
<rbw>	can be omitted
<sample rate>	Sampling rate for the data acquisition. Value range: 10 kHz to 65.83̄ MHz , continuously adjustable
<trigger mode>	Selection of the trigger source used for the measurement. Values: IMMEDIATE EXTERNAL IFPOWER
<trigger slope>	Used trigger slope. Values: POSITIVE
<pretrigger samples>	Number of measurement values to be recorded before the trigger point. Range: -16253439 (= -(2 ²⁴ -1-512k -512)) ... 523775 (= 512*1024 - 512 - 1). Negative values correspond to a trigger delay.
<# of samples>	Number of measurement values to record. Value range: 1 ... 523776(= 512*1024 - 512)

Example

```
TRAC:IQ:SET NORM,10MHz,32MHz,EXT,POS,0,2048
```

Reads 2048 I/Q-values starting at the trigger point.

sample rate: 32 MHz

trigger: External

slope: Positive

```
TRAC:IQ:SET NORM,10MHz,4MHz,EXT,POS,1024,512
```

Reads 512 I/Q-values from 1024 measurement points before the trigger point.

filter type: NORMAL

RBW: 10 MHz

sample rate: 4 MHz

trigger: External

slope: Positive

Characteristics

*RST values: -, -, 32MHz, IMM, POS, 0, 128

Note: For using these default settings with the `TRACe<1|2>:IQ:DATA?` command the following minimum buffer sizes for the response data are recommended: ASCII format 10 kBytes, Binary format 2 kBytes.

SCPI: device-specific

Mode

A-T

TRACe<1|2>:IQ:SRATe

This command sets the sampling rate for the I/Q data acquisition. Thus the sample rate can be modified without affecting the other settings.

Parameter

10 kHz to $65.8\bar{3}$ MHz , continuously adjustable

Example

`TRAC:IQ:SRAT 4MHZ`

Characteristics

*RST value: 32 MHz

SCPI: device-specific

Mode

A-T

TRIGger Subsystem

The TRIGger subsystem is used to synchronize instrument actions with events. It is thus possible to control and synchronize the start of a sweep.

Commands of the TRIGger Subsystem

- TRIGger<1|2>[:SEQuence]:HOLDoff[:TIME]
- TRIGger<1|2>[:SEQuence]:IFPower:HOLDoff
- TRIGger<1|2>[:SEQuence]:IFPower:HYSTerisis
- TRIGger<1|2>[:SEQuence]:LEVel:IFPower
- TRIGger<1|2>[:SEQuence]:LEVel:VIDeo
- TRIGger<1|2>[:SEQuence]:SLOPe
- TRIGger<1|2>[:SEQuence]:SOURce
- TRIGger<1|2>[:SEQuence]:TIME:RINTerval
- TRIGger<1|2>[:SEQuence]:VIDeo:CONTinuous (option TV Trigger, B6)
- TRIGger<1|2>[:SEQuence]:VIDeo:FIELD:SElect (option TV Trigger, B6)
- TRIGger<1|2>[:SEQuence]:VIDeo:FORMat:LPFRame (option TV Trigger, B6)
- TRIGger<1|2>[:SEQuence]:VIDeo:LINE:NUMBer (option TV Trigger, B6)
- TRIGger<1|2>[:SEQuence]:VIDeo:SSIGNAL:POLarity (option TV Trigger, B6)

TRIGger<1|2>[:SEQuence]:HOLDoff[:TIME]

This command defines the length of the trigger delay.
A negative delay time (pretrigger) can be set in zero span only.

Parameter

-100 s to +100 s

for TV trigger (option B6, available from firmware version 1.10): -50 μ s to +50 μ s

Example

```
TRIG:HOLD 500us
```

Characteristics

*RST value: 0 s

SCPI: conform

Mode

all

TRIGger<1|2>[:SEQuence]:IFPower:HOLDoff

This command sets the holding time before the next IF power trigger event.
This command is available from firmware version 1.30.

Parameter

<numeric_value> in s: 150 ns to 1000 s

Example

```
TRIG:SOUR IFP
```

Sets the IF power trigger source.

```
TRIG:IFP:HOLD 200 ns
```

Sets the holding time to 200 ns.

Characteristics

*RST value: 150 ns

SCPI: device-specific

Mode

A-F

TRIGger<1|2>[:SEquence]:IFPower:HYSTerisis

sThis command sets the limit that the hysteresis value has to fall below in order to trigger the next measurement.

This command is available from firmware version 1.30.

Parameter

<numeric_value> in dB: 3 dB to 50 dB

Example

```
TRIG:SOUR IFP
```

Sets the IF power trigger source.

```
TRIG:IFP:HYST 10DB
```

Sets the hysteresis limit value.

Characteristics

*RST value: 3 dB

SCPI: device-specific

Mode

A-F

TRIGger<1|2>[:SEquence]:LEVel:IFPower

This command sets the level of the IF power trigger source.

Parameter

-50 to -10 DBM

Example

```
TRIG:LEV:IFP -30DBM
```

Characteristics

*RST value: -20 DBM

SCPI: device-specific

Mode

all

TRIGger<1|2>[:SEQuence]:LEVel[:EXTeRnal]

This command sets the level of the external trigger source.

Parameter

<numeric value>

Characteristics

*RST value: 50 PCT

SCPI: device-specific

Mode

all

TRIGger<1|2>[:SEQuence]:LEVel:VIDeo

This command sets the level of the video trigger source.

Parameter

0 to 100 PCT

Example

```
TRIG:LEV:VID 50PCT
```

Characteristics

*RST value: 50 PCT

SCPI: device-specific

Mode

all, except ADEMOD

TRIGger<1|2>[:SEQuence]:SLOPe

This command selects the slope of the trigger signal. The selected trigger slope applies to all trigger signal sources except the TV trigger (option B6, available from firmware version 1.10).

Parameter

POSitive | NEGative

Example

```
TRIG:SLOP NEG
```

Characteristics

*RST value: POSitive

SCPI: conform

Mode

all

TRIGger<1|2>[:SEQuence]:SOURce

This command selects the trigger source for the start of a sweep.

Parameter

IMMediate (Free Run) | EXTeRn | IFPower | VIDeo | TIME (available from firmware version 1.60)

TV (option TV Trigger, B6, available from firmware version 1.10)

For details on trigger modes refer to chapter "Instrument Functions", section "Trigger mode overview".

Example

```
TRIG:SOUR EXT
```

Selects the external trigger input as source of the trigger signal

Characteristics

*RST value: IMMEDIATE

SCPI: conform

Mode

A, ADEMOD, CATV, CDMA, EVDO, SPECM, WCDMA

TRIGger<1|2>[:SEQuence]:TIME:RINTerval

This command sets the time interval for the time trigger source.

The numeric suffixes <1|2> are irrelevant for this command.

Parameter

0.1 to 5000 s

Example

```
TRIG:SOUR TIME
```

Selects the time trigger input for triggering.

```
TRIG:TIME:RINT 50
```

The sweep starts after 50 s.

Characteristics

RST value: 1.0

SCPI: device-specific

Mode

A, SPECM

TRIGger<1|2>[:SEQuence]:VIDeo:CONTInuous (option TV Trigger, B6)

Activates or deactivates the free run trigger mode.

This command is available from firmware version 1.30.

Parameter

ON | OFF

Example

```
TRIG:VID:CONT ON
```

Characteristics

*RST value: OFF

SCPI: device-specific

Mode

A-T

TRIGger<1|2>[:SEQUence]:VIDeo:FIELD:SELEct (option TV Trigger, B6)

With active TV trigger this command activates triggering at the vertical sync signal.
Option TV Trigger, B6, is available from firmware version 1.10.

Parameter

ALL (both fields) | ODD (odd fields) | EVEN (even fields)

Example

```
TRIG:VID:FIEL:SEL ALL
```

Characteristics

*RST value: -

SCPI: conform

Mode

A-T

TRIGger<1|2>[:SEQUence]:VIDeo:FORMat:LPFRame (option TV Trigger, B6)

This command defines the line system in use (525 or 625 lines) with active TV trigger.
Option TV Trigger, B6, is available from firmware version 1.10.

Parameter

525 | 625

Example

```
TRIG:VID:FORM:LPFR 525
```

Characteristics

*RST value: 625

SCPI: conform

Mode

A-T

TRIGger<1|2>[:SEQUence]:VIDeo:LINE:NUMBer (option TV Trigger, B6)

With active TV trigger this command activates triggering at the horizontal sync signal of the indicated line number.

Option TV Trigger, B6, is available from firmware version 1.10.

Parameter

<numeric_value>

Example

```
TRIG:VID:LINE:NUMB 17
```

Characteristics

*RST value: -

SCPI: conform

Mode

A-T

TRIGger<1|2>[:SEQuence]:VIDeo:SSIGnal:POLarity (option TV Trigger, B6)

With active TV trigger this command selects the polarity of the video sync signal.
Option TV Trigger, B6, is available from firmware version 1.10.

Parameter

NEGative | POSitive

Example

```
TRIG:VID:SSIG:POL NEG
```

Characteristics

*RST value: NEGative

SCPI: conform

Mode

A-T

UNIT Subsystem

The UNIT subsystem sets the basic unit of the setting parameters.

Commands of the UNIT Subsystem

– UNIT<1|2>:POWer

UNIT<1|2>:POWer

This command selects the default unit.

Parameter

DBM | V | A | W | DBPW | WATT | DBPT | DBUV | DBMV | VOLT | DBUA | AMPere

Example

```
UNIT:POW DBUV
```

Sets the power unit to dBm.

Characteristics

*RST value: DBM

SCPI: conform

Mode

A

Remote Commands of the Analog Demodulation Option (K7)

In this section all remote control commands for Analog Demodulation option are described in detail. The abbreviation ADEMODO stands for the Analog Demodulation operating mode. For details on conventions used in this chapter refer to section "Notation" on page 6.2 at the beginning of this chapter.

For further information on analyzer or basic settings commands, refer to the corresponding subsystem in "Remote Commands of the Base Unit" on page 6.5.

This option is available from firmware version 1.10.

Subsystems of the Analog Demodulation option (K7)

- "CALCulate Subsystem (Analog Demodulation, K7)" on page 6.278
- "DISPlay Subsystem (Analog Demodulation, K7)" on page 6.289
- "INSTrument Subsystem (Analog Demodulation, K7)" on page 6.291
- "SENSe Subsystem (Analog Demodulation, K7)" on page 6.292
- "TRACe Subsystem (Analog Demodulation, K7)" on page 6.321
- "TRIGger Subsystem (Analog Demodulation, K7)" on page 6.322
- "UNIT Subsystem (Analog Demodulation, K7)" on page 6.324

CALCulate Subsystem (Analog Demodulation, K7)

The CALCulate subsystem contains commands for converting instrument data, transforming and carrying out corrections. These functions are carried out subsequent to data acquisition, i.e. following the SENSE subsystem.

The following subsystems are included:

- ["CALCulate:DELTamarker Subsystem"](#) on page 6.279
- ["CALCulate:FEED Subsystem"](#) on page 6.280
- ["CALCulate:FORMat Subsystem \(Analog Demodulation, K7\)"](#) on page 6.281
- ["CALCulate:MARKer Subsystem"](#) on page 6.282
- ["CALCulate:UNIT Subsystem"](#) on page 6.288

CALCulate:DELTamarker Subsystem (Analog Demodulation, K7)

The CALCulate:DELTamarker subsystem controls the delta marker functions of the instrument.

Commands of the CALCulate:DELTamarker Subsystem

– [CALCulate<1|2>:DELTamarker<1...4>:Y?](#)

CALCulate<1|2>:DELTamarker<1...4>:Y?

Depending on the unit defined with [CALCulate<1|2>:UNIT:POWer](#) or on the activated measuring functions, the query result is output in the units below:

Result display	Output unit
AM result display (R&S FSL-K7)	% (lin) dB (log)
FM result display (R&S FSL-K7)	Hz (lin) dB (log)
PM result display (R&S FSL-K7)	rad deg (lin) dB (log)
RF result display (R&S FSL-K7)	output unit defined with CALCulate<1 2>:UNIT:POWer

For further details refer to "[CALCulate<1|2>:DELTamarker<1...4>:Y?](#)" on page 6.21.

CALCulate:FEED Subsystem (Analog Demodulation, K7)

The CALCulate:FEED subsystem selects the evaluation method of the measured data. This corresponds to the selection of the result display in manual mode.

Commands of the CALCulate:FEED Subsystem

– [CALCulate<1|2>:FEED](#)

CALCulate<1|2>:FEED

This command selects the measured data that are to be displayed.
The numeric suffixes <1|2> are irrelevant.

Parameter

XTIM:AM:RELative[:TDOMain]	Demodulated AM signal in standardized display
XTIM:AM:RELative:AFSPectrum<1...6>	AF spectrum of the demodulated AM signal in standardized display, results referenced to traces 1 to 4
XTIM:AM[:ABSolute][:TDOMain]	Demodulated AM signal in level display Same as 'XTIM:RFPower'
XTIM:RFPower[:TDOMain]	RF power of the signal
XTIM:FM[:TDOMain]	Demodulated FM signal
XTIM:FM:AFSPectrum<1...6>	AF spectrum of the demodulated FM signal, results referenced to traces 1 to 4
XTIM:PM[:TDOMain]	Demodulated PM signal
XTIM:PM:AFSPectrum<1...6>	AF spectrum of the demodulated PM signal, results referenced to traces 1 to 4
XTIM:AMSummary<1...6>[:ABSolute]	AM results in level display, referenced to traces 1 to 4
XTIM:AMSummary<1...6>:RELative	AM results in standardized display, referenced to traces 1 to 4
XTIM:FMSummary<1...6>	FM results, referenced to traces 1 to 4
XTIM:PMSummary<1...6>	PM results, referenced to traces 1 to 4
XTIM:SPECTrum	RF spectrum of the signal determined from the measured data via FFT

Example

```
INST:SEL ADEM
Activates analog demodulator.
CALC:FEED 'XTIM:FM'
Selects the display of the FM signal.
```

Characteristics

RST value: -
SCPI: conform

Mode

ADEM0D

CALCulate:FORMat Subsystem (Analog Demodulation, K7)

The CALCulate:FORMat subsystem defines the conversion of measured data.

Commands of the CALCulate:FORMat Subsystem

– [CALCulate<1|2>:FORMat](#)

CALCulate<1|2>:FORMat

This command activates the limitation to $\pm 180^\circ$.

The numeric suffixes <1|2> are irrelevant.

Parameter

PHASe Limitation to $\pm 180^\circ$

UPHase Unwrapped

Example

```
CALC:FORM PHAS
```

Activates the limitation to $\pm 180^\circ$.

Characteristics

RST value: UPHase

SCPI: conform

Mode

ADEM0D

CALCulate:MARKer Subsystem (Analog Demodulation, K7)

The CALCulate:MARKer subsystem checks the marker functions of the instrument.

The following subsystem is included:

- ["CALCulate:MARKer:FUNCTION:ADEMod Subsystem \(Analog Demodulation, K7\)"](#) on page 6.283

Commands of the CALCulate:MARKer Subsystem

- [CALCulate<1|2>:MARKer<1...4>:PEXCursion](#)
- [CALCulate<1|2>:MARKer<1...4>:Y?](#)

CALCulate<1|2>:MARKer<1...4>:PEXCursion

The unit depends on the active display.

Example

CALC:MARK:PEXC 100 HZ
 Defines peak excursion 100 Hz

Characteristics

*RST value:

- 6dB RF displays
- 5 PCT AM displays
- 50 kHz FM displays
- 0.5 RAD PM displays

For further details refer to ["CALCulate<1|2>:MARKer<1...4>:PEXCursion"](#) on page 6.63.

CALCulate<1|2>:MARKer<1...4>:Y?

If the analog demodulator (option Analog Demodulation, R&S FSL-K7) is activated, the query result is output in the following units:

Result display	Output unit
AM	%
FM	Hz
PM	rad/deg (defined with CALCulate<1 2>:UNIT:ANGLE)
RF	output unit defined with CALCulate<1 2>:UNIT:POWER

For further details refer to ["CALCulate<1|2>:MARKer<1...4>:Y?"](#) on page 6.66.

CALCulate:MARKer:FUNCTion:ADEMod Subsystem (Analog Demodulation, K7)

The CALCulate:MARKer:FUNCTion:ADEMod subsystem contains the marker functions for the option Analog Demodulation, R&S FSL-K7.

Commands of the CALCulate:MARKer:FUNCTion:ADEMod Subsystem

- CALCulate<1|2>:MARKer:FUNCTion:ADEMod:AFRequency[:RESult<1...6>?]
- CALCulate<1|2>:MARKer:FUNCTion:ADEMod:AM[:RESult<1...6>?]
- CALCulate<1|2>:MARKer:FUNCTion:ADEMod:CARRier[:RESult<1...6>?]
- CALCulate<1|2>:MARKer:FUNCTion:ADEMod:FERRor[:RESult<1...6>?]
- CALCulate<1|2>:MARKer:FUNCTion:ADEMod:FM[:RESult<1...6>?]
- CALCulate<1|2>:MARKer:FUNCTion:ADEMod:PM[:RESult<1...6>?]
- CALCulate<1|2>:MARKer:FUNCTion:ADEMod:SINad:RESult<1...6>?
- CALCulate<1|2>:MARKer:FUNCTion:ADEMod:THD:RESult<1...6>?

CALCulate<1|2>:MARKer:FUNCTion:ADEMod:AFRequency[:RESult<1...6>?]

This command queries the audio frequency with analog demodulation. The numeric suffix (:RESult<1...6>) indicates whether trace 1, 2, 3, 4, 5 or 6 is selected. The numeric suffixes <1|2> are irrelevant.

Note: If several demodulation modes are activated simultaneously (e.g. with the [SENSe:]ADEMod:FM[:TDOMain] [:TYPE] command, the audio frequency of the display mode selected with CALCulate<1|2>:FEED is returned.

Example

```
ADEM ON
Switches on analog demodulator
CALC:FEED 'XTIM:AM:TDOM'
Switches on AM result display.
or
CALC:FEED 'XTIM:FM:TDOM'
Switches on FM result display.
or
CALC:FEED 'XTIM:FM:AFSP'
DISP:TRAC ON
Switches on AF spectrum result display of FM and trace.
CALC:MARK:FUNC:ADEM:AFR?
Queries the audio frequency.
```

Characteristics

*RST value: -
SCPI: device-specific

Mode

ADEMOD

CALCulate<1|2>:MARKer:FUNCtion:ADEMod:AM[:RESult<1...6>?]

This command queries the results of the AM modulation measurement. The numeric suffix (:RESult<1...6>) indicates whether trace 1, 2, 3, 4, 5 or 6 is selected. The numeric suffixes <1|2> are irrelevant.

Parameter

PPEak	Result of measurement with detector +PK
MPEak	Result of measurement with detector -PK
MIDDLE	Result of averaging \pm PK/2
RMS	Result of rms measurement

Example

```
ADEM ON
Switches on the analog demodulator.
CALC:FEED 'XTIM:AM:REL:TDOM'
Switches on the AM result display.
DISP:TRAC ON
Switches on the trace.
CALC:MARK:FUNC:ADEM:AM? PPE
Queries the peak value.
```

Characteristics

RST value: -
SCPI: device-specific

Mode

ADEMOD

CALCulate<1|2>:MARKer:FUNCtion:ADEMod:CARRier[:RESult<1...6>?]

This command queries the carrier power. The numeric suffix (:RESult<1...6>) indicates whether trace 1, 2, 3, 4, 5 or 6 is selected. The numeric suffixes <1|2> are irrelevant.

With RF Power result display, the carrier power is determined from trace 1 to 6 indicated in the numeric suffix. With all other result displays, the carrier power is determined from the current trace data (CLR/WRITE trace).

This command is only a query and therefore has no *RST value.

Example

```
ADEM ON
Switches on analog demodulator
CALC:FEED 'XTIM:RFP'
Switches on RF power result display
CALC:MARK:FUNC:ADEM:CARR?
Queries the carrier power
```

Characteristics

*RST value: -
SCPI: device-specific

Mode

ADEMOD

CALCulate<1|2>:MARKer:FUNCtion:ADEMod:FERRor[:RESult<1...6>?]

This command queries the frequency error with FM and PM demodulation. With FM demodulation, trace 1 to 6 is selected with the numeric suffix (:RESult<1...6>). With PM demodulation, the frequency error is determined from the current measurement data (CLR/WRITE trace). The numeric suffixes <1|2> are irrelevant.

The offset thus determined differs from that calculated in the `[SENSe:]ADEMod:FM:OFFSet?` command since, for determination of the frequency deviation, the modulation is removed by means of lowpass filtering, producing results that are different from those obtained by averaging with the `SENSe` command.

This command is only available for traces in the FM and PM result display. If another result display is selected, the command is disabled.

Example

ADEM ON

Switches on analog demodulator

CALC:FEED 'XTIM:FM:TDOM'

Switches on FM result display

CALC:MARK:FUNC:ADEM:FERR?

Queries the frequency error of trace 1

Characteristics

*RST value: -

SCPI: device-specific

Mode

ADEMOD

CALCulate<1|2>:MARKer:FUNCtion:ADEMod:FM[:RESult<1...6>?]

This command queries the results of FM modulation measurement. The numeric suffix (:RESult<1...6>) indicates whether trace 1, 2, 3, 4, 5 or 6 is selected. The numeric suffixes <1|2> are irrelevant.

Parameter

PPEak Result of measurement with detector +PK

MPEak Result of measurement with detector -PK

MIDDLE Result of averaging \pm PK/2

RMS Result of rms measurement

Example

ADEM ON

Switches on the analog demodulator.

CALC:FEED 'XTIM:FM:TDOM'

Switches on the FM result display.

CALC:MARK:FUNC:ADEM:FM? PPE

Queries the peak value.

Characteristics

*RST value: -

SCPI: device-specific

Mode

ADEMOD

CALCulate<1|2>:MARKer:FUNCtion:ADEMod:PM[:RESult<1...6>?]

This command queries the results of PM modulation measurement of analog demodulation. The numeric suffix (:RESult<1...6>) indicates whether trace 1, 2, 3, 4, 5 or 6 is selected. The numeric suffixes <1|2> are irrelevant.

Parameter

PPEak	Result of measurement with detector +PK
MPEak	Result of measurement with detector -PK
MIDDLE	Result of averaging \pm PK/2
RMS	Result of rms measurement

Example

ADEM ON

Switches on the analog demodulator.

CALC:FEED 'XTIM:PM:TDOM'

Switches on the FM result display.

CALC:MARK:FUNC:ADEM:PM? PPE

Queries the peak value.

Characteristics

*RST value: -

SCPI: device-specific

Mode

ADEMOD

CALCulate<1|2>:MARKer:FUNCtion:ADEMod:SINad:RESult<1...6>?

This command queries the result of the SINAD measurement. The numeric suffix (:RESult<1...6>) indicates whether trace 1, 2, 3, 4, 5 or 6 is selected. The numeric suffixes <1|2> are irrelevant.

This command is a query only and thus has no *RST value.

Example

ADEM ON

Switches on analog demodulator

CALC:FEED 'XTIM:FM:AFSP'

DISP:TRAC ON

Switches on AF spectrum of FM and trace

CALC:MARK:FUNC:ADEM:SIN:RES?

Queries SINAD value

Characteristics

*RST value: -

SCPI: device-specific

Mode

ADEMOD

CALCulate<1|2>:MARKer:FUNCtion:ADEMod:THD:RESult<1...6>?

This command queries the result of the THD measurement. The numeric suffix (:RESult<1...6>) indicates whether trace 1, 2, 3, 4, 5 or 6 is selected. The numeric suffixes <1|2> are irrelevant.

This command is a query only and thus has no *RST value.

Example

ADEM ON

Switches on analog demodulator

CALC:FEED 'XTIM:FM:AFSP'

Switches on AF spectrum of FM and trace

DISP:TRAC ON

Switches on the trace

CALC:MARK:FUNC:ADEM:THD:RES?

Queries THD result

Characteristics

*RST value: -

SCPI: device-specific

Mode

ADEMOD

CALCulate:UNIT Subsystem (Analog Demodulation, K7)

The CALCulate:Unit subsystem defines the units for the parameters that can be set and the measurement results.

Commands of the CALCulate:UNIT Subsystem

- [CALCulate<1|2>: UNIT:ANGLE](#)

CALCulate<1|2>: UNIT:ANGLE

This command selects the unit for angles.

Parameter

DEG | RAD

Example:

CALC:UNIT:ANGL DEG

Characteristics:

*RST value: RAD

SCPI: device-specific

Mode

ADEMODO

DISPlay Subsystem (Analog Demodulation, K7)

The DISPlay subsystem controls the selection and presentation of textual and graphic information as well as of measurement data on the display.

Commands of the DISPlay Subsystem

- [DISPlay\[:WINDow<1|2>\]:SIZE](#)
- [DISPlay\[:WINDow<1|2>\]:TRACe<1...6>:Y\[:SCALe\]:PDIVision](#)
- [DISPlay\[:WINDow<1|2>\]:TRACe<1...6>:Y\[:SCALe\]:RPOSition](#)
- [DISPlay\[:WINDow<1|2>\]:TRACe<1...6>:Y\[:SCALe\]:RVALue](#)
- [DISPlay\[:WINDow<1|2>\]:TRACe<1...6>:Y:SPACing](#)

DISPlay[:WINDow<1|2>]:SIZE

This command switches the measurement window for active analog demodulation to full screen or half screen.

For further details refer to "[DISPlay\[:WINDow<1|2>\]:SIZE](#)" on page 6.128.

DISPlay[:WINDow<1|2>]:TRACe<1...6>:Y[:SCALe]:PDIVision

This command defines the scaling of the y-axis in the current unit. The numeric suffix in TRACe<1...6> is irrelevant. The numeric suffixes <1|2> are irrelevant.

Parameter

<numeric_value>

Example

```
DISP:TRAC:Y:PDIV +10kHz
```

Sets the Y scale to 10 kHz/div.

Characteristics

*RST value:

20 PCT	linear AM display
50 kHz	linear FM display
2 rad	linear PM display
10 dB	logarithmic AF spectrum display

SCPI: conform

Mode

ADEMODO

DISPlay[:WINDow<1|2>]:TRACe<1...6>:Y[:SCALe]:RPOSition

Characteristics

*RST value:

100 PCT AF spectrum display of AM, FM, or PM

50 PCT AM, FM, or PM display

For further details refer to "[DISPlay\[:WINDow<1|2>\]:TRACe<1...6>:Y\[:SCALe\]:RPOSition \(models with tracking generator\)](#)" on page 6.133.

DISPlay[:WINDow<1|2>]:TRACe<1...6>:Y[:SCALe]:RVALue

This command defines the reference value assigned to the reference position. Separate reference values are maintained for the various displays.

Example

DISP:TRAC:Y:RVAL 0

Sets the value assigned to the reference position to 0 Hz (analog demodulation)

Characteristics

*RST value:

0 PCT AM display

0 Hz FM display

0 rad PM display

100 PCT AF spectrum display of AM signal

250 kHz AF spectrum display of FM signal

10 rad AF spectrum display of PM signal

For further details refer to "[DISPlay\[:WINDow<1|2>\]:TRACe<1...6>:Y\[:SCALe\]:RPOSition \(models with tracking generator\)](#)" on page 6.133.

DISPlay[:WINDow<1|2>]:TRACe<1...6>:Y:SPACing

When the AF spectrum result display is selected, only the parameters LINear and LOGarithmic are allowed.

For further details refer to "[DISPlay\[:WINDow<1|2>\]:TRACe<1...6>:Y:SPACing](#)" on page 6.132.

INSTrument Subsystem (Analog Demodulation, K7)

The INSTrument subsystem selects the operating mode of the unit either via text parameters or fixed numbers.

Commands of the INSTrument Subsystem

- [INSTrument\[:SElect\]](#)
- [INSTrument:NSElect](#)

INSTrument[:SElect]

Parameter

ADEMod (Analog Demodulation option, R&S FSL-K7)

For further details refer to the INSTrument subsystem of the base unit.

INSTrument:NSElect

Parameter

3 (Analog Demodulation option, R&S FSL-K7)

For further details refer to the INSTrument subsystem of the base unit.

SENSe Subsystem (Analog Demodulation, K7)

The SENSe subsystem is organized in several subsystems. The commands of these subsystems directly control device-specific settings, they do not refer to the signal characteristics of the measurement signal.

The SENSe subsystem controls the essential parameters of the analyzer. In accordance with the SCPI standard, the keyword "SENSe" is optional for this reason, which means that it is not necessary to include the SENSe node in command sequences.

The following subsystems are included:

- ["SENSe:ADEMod Subsystem"](#) on page 6.293
- ["SENSe:BANDwidth Subsystem"](#) on page 6.315
- ["SENSe:FILTer Subsystem"](#) on page 6.316
- ["SENSe:FREQuency Subsystem"](#) on page 6.319
- ["SENSe:SWEEp Subsystem"](#) on page 6.320

SENSe:ADEMod Subsystem (Analog Demodulation, K7)

The SENSe:ADEMod Subsystem contains commands to set up the instrument for the measurement of analog demodulated signals and query the result at the end of the measurement.

Commands of the SENSe:ADEMod Subsystem

- [SENSe:]ADEMod[::STATe]
- [SENSe:]ADEMod:AF:CENTer
- [SENSe:]ADEMod:AF:COUPLing
- [SENSe:]ADEMod:AF:SPAN
- [SENSe:]ADEMod:AF:SPAN:FULL
- [SENSe:]ADEMod:AF:STARt
- [SENSe:]ADEMod:AF:STOP
- [SENSe:]ADEMod:AM[::ABSolute][::TDOMain][::TYPE]
- [SENSe:]ADEMod:AM[::ABSolute][::TDOMain]:RESult?
- [SENSe:]ADEMod:AM:RELative[::TDOMain][::TYPE]
- [SENSe:]ADEMod:AM:RELative[::TDOMain]:RESult?
- [SENSe:]ADEMod:AM:RELative:AFSPectrum[::TYPE]
- [SENSe:]ADEMod:AM:RELative:AFSPectrum:RESult?
- [SENSe:]ADEMod:BANDwidth|BWIDth:DEModulation
- [SENSe:]ADEMod:FM[::TDOMain][::TYPE]
- [SENSe:]ADEMod:FM[::TDOMain]:RESult?
- [SENSe:]ADEMod:FM:AFSPectrum[::TYPE]
- [SENSe:]ADEMod:FM:AFSPectrum:RESult?
- [SENSe:]ADEMod:FM:OFFSet?
- [SENSe:]ADEMod:MTIME
- [SENSe:]ADEMod:PM[::TDOMain][::TYPE]
- [SENSe:]ADEMod:PM[::TDOMain]:RESult?
- [SENSe:]ADEMod:PM:AFSPectrum[::TYPE]
- [SENSe:]ADEMod:PM:AFSPectrum:RESult?
- [SENSe:]ADEMod:PM:RPOint[::X]
- [SENSe:]ADEMod:RELEngth?
- [SENSe:]ADEMod:SET
- [SENSe:]ADEMod:SPECTrum[::TYPE]
- [SENSe:]ADEMod:SPECTrum:BANDwidth|BWIDth[::RESolution]
- [SENSe:]ADEMod:SPECTrum:RESult?
- [SENSe:]ADEMod:SPECTrum:SPAN[::MAXimum]
- [SENSe:]ADEMod:SPECTrum:SPAN:ZOOM
- [SENSe:]ADEMod:SRATE?
- [SENSe:]ADEMod:ZOOM[::STATe]

- [SENSe:]ADEMod:ZOOM:STARt

Further information

- Trace mode result types
- Formats for returned values: ASCII format and binary format

Trace mode result types

The following result types can be set:

WRITE	The current trace results will be obtained
AVERAge	The trace results will be averaged over the given # of measurements
MAXHold	The maximum trace result values will be obtained over the given # of measurements
MINHold	The minimum trace result values will be obtained over the given # of measurements
VIEW	The trace results are frozen and displayed, i.e. they are not calculated for subsequent measurements. Traces in this mode cannot be queried.
OFF	The result type will not be used.

Note: *It is not possible to query trace data when result type VIEW is selected.
Each value besides OFF can only be assigned to one result type at a time.
If all result types are set to OFF, the AM, FM, or PM demodulator will be deactivated.*

Formats for returned values: ASCII format and binary format

- ASCII Format (FORMat ASCII):

The command reads out a list of comma separated values (CSV) of the measured values in floating point format.

- Binary Format (FORMat REAL,32):

The command reads out binary data (Definite Length Block Data according to IEEE 488.2), each measurement value being formatted in 32 Bit IEEE 754 Floating-Point-Format. The schematics of the result string will be as follows:

#41024<value1><value2>...<value n> with

#4 number of digits (= 4 in the example) of the following number of data bytes

1024 number of following data bytes (= 1024 in the example)

<value> 4-byte floating point value

[SENSe:]ADEMod[:STATe]

This command activates the analog demodulator of the instrument. The instrument will be set to zero span at the current center frequency.

Parameter

ON | OFF

Example

ADEM ON

Switches the analog demodulator on.

Characteristics

*RST value: OFF

SCPI: device-specific

Mode

ADEMOD

[SENSe:]ADEMod:AF:CENTer

This command sets the center frequency for AF spectrum result display.

Parameter

<numeric_value>

Example

ADEM ON

Switches on the analog demodulator

CALC:FEED 'XTIM:FM:AFSP'

Switches on AF spectrum result display of FM

ADEM:BAND 5 MHz

Sets the measurement bandwidth to 5 MHz

ADEM:AF:CEN 500kHz

Sets the AF center frequency to 500 kHz

ADEM:AF:SPAN 200kHz

Sets the AF span to 200 kHz

Characteristics

*RST value: 1.25 MHz

SCPI: device-specific

Mode

ADEMOD

[SENSe:]ADEMod:AF:COUPling

This command selects the coupling of the AF path of the analyzer.

Parameter

AC | DC

Example

ADEM:AF:COUP DC

Switches on DC coupling.

Characteristics

*RST value: AC (PM); DC (FM)

SCPI: device-specific

Mode

ADEMOD

[SENSe:]ADEMod:AF:SPAN

This command sets the span for AF spectrum result display.
The span is limited to half the measurement bandwidth of analog demodulation (`[SENSe:]ADEMod:BANDwidth|BWIDth:DEModulation`).

Parameter

<numeric_value>

Example

```
ADEM ON
Switches on the analog demodulator
CALC:FEED 'XTIM:FM:AFSP'
Switches on AF spectrum result display of FM
ADEM:BAND 5 MHz
Sets the measurement bandwidth to 5 MHz
ADEM:AF:CENT 500kHz
Sets the AF center frequency to 500 kHz
ADEM:AF:SPAN 200kHz
Sets the AF span to 200 kHz
```

Characteristics

*RST value: 2.5 MHz
SCPI: device-specific

Mode

ADEMOD

[SENSe:]ADEMod:AF:SPAN:FULL

This command sets the maximum span for AF spectrum result display.
The maximum span corresponds to half the measurement bandwidth of analog demodulation (`[SENSe:]ADEMod:BANDwidth|BWIDth:DEModulation`).

Example

```
ADEM ON
Switches on the analog demodulator
CALC:FEED 'XTIM:FM:AFSP'
Switches on AF spectrum result display of FM
ADEM:BAND 5 MHz
Sets the measurement bandwidth to 5 MHz
ADEM:AF:SPAN:FULL
Sets the AF span to 2.5 MHz
```

Characteristics

*RST value: -
SCPI: device-specific

Mode

ADEMOD

[SENSe:]ADEMod:AF:STARt

This command sets the start frequency for AF spectrum result display.

Parameter

<numeric_value>

Example

ADEM ON

Switches on analog demodulator

CALC:FEED 'XTIM:FM:AFSP'

Switches on AF spectrum result display of FM

ADEM:BAND 5 MHz

Sets the measurement bandwidth to 5 MHz

ADEM:AF:STAR 0kHz

Sets the AF start frequency to 0 kHz

ADEM:AF:STOP 500kHz

Sets the AF stop frequency to 500 kHz

Characteristics

*RST value: 0 MHz

SCPI: device-specific

Mode

ADEMOD

[SENSe:]ADEMod:AF:STOP

This command sets the stop frequency for AF spectrum result display.

The stop frequency is limited to half the measurement bandwidth of analog demodulation ([\[SENSe:\]ADEMod:BANDwidth|BWIDth:DEModulation](#)).

Parameter

<numeric_value>

Example

ADEM ON

Switches on the analog demodulator

CALC:FEED 'XTIM:FM:AFSP'

Switches on AF spectrum result display of FM

ADEM:BAND 5 MHz

Sets the measurement bandwidth to 5 MHz

ADEM:AF:STAR 0kHz

Sets the AF start frequency to 0 kHz

ADEM:AF:STOP 500kHz

Sets the AF stop frequency to 500 kHz

Characteristics

*RST value: 2.5 MHz

SCPI: device-specific

Mode

ADEMOD

[SENSe:]ADEMod:AM[:ABSolute][:TDOMain][:TYPE]

This command selects the result types of the RF signal to be measured simultaneously in zero span.

Parameter

<result type 1|2|3|4|5|6>: WRITe, AVERage, MAXHold, MINHold, VIEW, OFF; for details see "[Trace mode result types](#)" on page 6.294.

Example

```
ADEM:AM AVER,MAXH,MINH
```

Determines average, max hold and min hold values at a time.

```
ADEM:AM WRIT,OFF,OFF
```

Determines only the current measurement values.

```
ADEM:AM OFF,OFF,OFF
```

Switches AM demodulation off.

Characteristics

*RST value: WRITe,OFF,OFF

SCPI: device-specific

Mode

ADEM0D

[SENSe:]ADEMod:AM[:ABSolute][:TDOMain]:RESult?

This command reads the result data of the RF signal in zero span for the specified result type. The data format of the output data block is defined by the `FORMat` command.

Parameter

<result type>: WRITe, AVERage, MAXHold, MINHold; for details see "[Trace mode result types](#)" on page 6.294.

Note: *The result type indicated must be one of those configured by [SENSe:]ADEMod:AM[:ABSolute][:TDOMain][:TYPE]. Otherwise a query error will be generated.*

Return values

ASCII Format (FORMat ASCII) or Binary Format (FORMat REAL,32); for details see "[Formats for returned values: ASCII format and binary format](#)" on page 6.294. The output units are described in "[CALCulate<1|2>:MARKer<1...4>:PEXCursion](#)" on page 6.63.

Example

```
ADEM:SET 8MHz,32000,EXT,POS,-500,30
```

Sets up demodulator parameters

```
ADEM:AM AVER,MAXH,MINH
```

Sets up AM results to be measured

```
ADEM ON
```

Switches on demodulator

```
INIT;*WAI
```

Starts measurement and waits for sync

```
FORM ASC
```

Selects output format

```
ADEM:AM:RES? AVER
```

Reads AM average results

```
ADEM:AM:RES? MAXH
```

Reads AM max hold results

ADEM:AM:RES? MINH
 Reads AM min hold results

Characteristics

*RST value: -
 SCPI: device-specific

Mode

ADEMOD

[SENSE:]ADEMod:AM:RELative[:TDOMain][:TYPE]

This command selects the result types to be measured simultaneously by AM demodulation.

Parameter

<result type 1|2|3|4|5|6>: WRITe, AVERage, MAXHold, MINHold, VIEW, OFF; for details see "[Trace mode result types](#)" on page 6.294.

Example

ADEM:AM:REL AVER,MAXH,MINH
 Determines average, max hold and min hold values simultaneously.
 ADEM:AM:REL WRIT,OFF,OFF
 Determines only the current measurement values.
 ADEM:AM:REL OFF,OFF,OFF
 Switches AM demodulation off.

Characteristics

*RST value: OFF,OFF,OFF
 SCPI: device-specific

Mode

ADEMOD

[SENSE:]ADEMod:AM:RELative[:TDOMain]:RESult?

This command reads the result data obtained by AM demodulation for the specified result type. The data format of the output data block is defined by the FORMat command.

Parameter

<result type>: WRITe, AVERage, MAXHold, MINHold; for details see "[Trace mode result types](#)" on page 6.294.

Note: *The result type indicated must be one of those configured by [SENSE:]ADEMod:AM:RELative[:TDOMain][:TYPE]. Otherwise a query error will be generated.*

Return values

ASCII Format (FORMat ASCII) or Binary Format (FORMat REAL,32); for details see "[Formats for returned values: ASCII format and binary format](#)" on page 6.294. The output units are described in "[CALCulate<1|2>:MARKer<1...4>:PEXCursion](#)" on page 6.63.

Example

ADEM:SET 8MHz,32000,EXT,POS,-500,30
 Sets up demodulator parameters
 ADEM:FM AVER,MAXH,MINH
 Selects FM results to be measured

```

ADEM:AM:REL WRIT,OFF,OFF
Selects AM results to be measured
ADEM ON
Switches on demodulator
INIT;*WAI
Starts measurement and waits for sync
FORM ASC
Selects output format
ADEM:FM:RES? AVER
Reads FM average results
ADEM:FM:RES? MAXH
Reads FM max hold results
ADEM:FM:RES? MINH
Reads FM min hold results
ADEM:AM:REL:RES? WRIT
Reads current AM result data

```

Characteristics

*RST value: -
 SCPI: device-specific

Mode

ADEMOD

[SENSe:]ADEMod:AM:RELative:AFSPectrum[:TYPE]

This command selects the AF spectrum result types of the AM-demodulated signal to be measured simultaneously.

Parameter

<result type 1|2|3|4|5|6>: WRITe, AVERage, MAXHold, MINHold, VIEW, OFF; for details see "[Trace mode result types](#)" on page 6.294.

Note: *The result type "AF spectrum of AM-demodulated signal" cannot be activated at the same time as "AF spectrum of FM or PM demodulated signal".*

Example

```

ADEM:AM:REL:AFSP AVER,MAXH,MINH
Determines average, maximum and minimum value simultaneously
ADEM:AM:REL:AFSP WRIT,OFF,OFF
Determines only current measurement results
ADEM:AM:REL:AFSP OFF,OFF,OFF
Switches off calculation of the AF spectrum

```

Characteristics

*RST value: OFF,OFF,OFF
 SCPI: device-specific

Mode

ADEMOD

[SENSe:]ADEMod:AM:RELative:AFSPectrum:RESult?

This command reads out the AF spectrum result data of the AM-demodulated signal for the specified result type. The data format of the output data is determined with the `FORMat` command.

Parameter

<result type>: WRITe, AVERage, MAXHold, MINHold; for details see "[Trace mode result types](#)" on page 6.294.

Note: *The specified result type must be one of those configured with the `[SENSe:]ADEMod:AM:RELative:AFSPectrum[:TYPE]` command. Otherwise a query error will be generated.*

Return values

ASCII Format (FORMat ASCII) or Binary Format (FORMat REAL,32); for details see "[Formats for returned values: ASCII format and binary format](#)" on page 6.294. The output units are described in section "[CALCulate<1|2>:MARKer<1...4>:PEXCursion](#)" on page 6.63.

Example

```
ADEM:SET 8MHz,32000,EXT,POS,-500,30
```

Sets the demodulator

```
ADEM:FM AVER,MAXH,MINH
```

Selects the FM results to be measured

```
ADEM:AM:REL WRIT,OFF,OFF
```

Selects the AM results to be measured

```
ADEM:AM:REL:AFSP WRIT,OFF,OFF
```

Selects the AF spectrum results of the demodulated AM signal to be measured

```
ADEM ON
```

Switches on the demodulator

```
INIT;*WAI
```

Starts the measurement and waits for the termination

```
FORM ASC
```

Selects the output format

```
ADEM:FM:RES? AVER
```

Reads the FM average result data

```
ADEM:FM:RES? MAXH
```

Reads the FM Maxhold result data

```
ADEM:FM:RES? MINH
```

Reads the FM Minhold result data

```
ADEM:AM:REL:RES? WRIT
```

Reads the current AM result data

```
ADEM:AM:REL:AFSP:RES? WRIT
```

Reads the current AF spectrum result data of the demodulated AM signal

Characteristics

*RST value: -

SCPI: device-specific

Mode

ADEMOD

[SENSe:]ADEMod:BANDwidth|BWIDth:DEModulation

This command defines the demodulation bandwidth used for analog demodulation. The required sampling rate is automatically set depending on the selected demodulation bandwidth. The available demodulation bandwidths are determined by the existing sampling rates (see table below).

Parameter

<numeric_value>

For details on the correlation of bandwidth and sample rate refer to chapter "Instrument Functions", section "Analog Demodulation (Option K7)" - "Sample rate, measurement time and trigger offset".

Example

```
ADEMod: BAND: DEM 1MHz
```

Sets the demodulation bandwidth to 1 MHz.

Characteristics

*RST value: 5 MHz

SCPI: device-specific

Mode

ADEMOD

[SENSe:]ADEMod:FM[:TDOMain][:TYPE]

This command selects the result types to be measured simultaneously by FM demodulation.

Parameter

<result type 1|2|3|4>: WRITe, AVERAge, MAXHold, MINHold, VIEW, OFF; for details see "[Trace mode result types](#)" on page 6.294.

Example

```
ADEMod: FM AVER, MAXH, MINH
```

"Creates average, max hold and min hold values simultaneously"

```
DEMod: FM WRIT, OFF, OFF
```

Only creates the current measurement values

```
ADEMod: FM OFF, OFF, OFF
```

Switches analog demodulator off

Characteristics

*RST value: WRITe, OFF, OFF

SCPI: device-specific

Mode

ADEMOD

[SENSe:]ADEMod:FM[:TDOMain]:RESult?

This command reads the result data obtained by analog demodulation for the specified result type. The data format of the output data block is defined by the `FORMat` command.

Parameter

<result type>: WRITe, AVERAge, MAXHold, MINHold; for details see "[Trace mode result types](#)" on page 6.294.

Note: The result type indicated must be one of those configured by `[SENSe:]ADEMod:FM[:TDOMain][:TYPE]`. Otherwise a query error will be generated.

Return values

ASCII Format (FORMat ASCII) or Binary Format (FORMat REAL,32); for details see "[Formats for returned values: ASCII format and binary format](#)" on page 6.294. The output units are described in "[CALCulate<1|2>:MARKer<1...4>:PEXCursion](#)" on page 6.63.

Example

```
ADEM:SET 8MHz,32000,EXT,POS,-500,30
```

Sets up demodulator parameters

```
ADEM:FM AVER,MAXH,MINH
```

Selects FM results to be measured

```
ADEM:AM WRIT,OFF,OFF
```

Selects AM results to be measured

```
ADEM ON
```

Switches on demodulator

```
INIT;*WAI
```

Starts measurement and waits for sync

```
FORM ASC
```

Selects output format

```
ADEM:FM:RES? AVER
```

Reads FM average results

```
ADEM:FM:RES? MAXH
```

Reads FM max hold results

```
ADEM:FM:RES? MINH
```

Reads FM min hold results

```
ADEM:AM:RES? WRIT
```

Reads current AM results

Characteristics

*RST value: -

SCPI: device-specific

Mode

ADEMOD

[SENSe:]ADEMod:FM:AFSPectrum[:TYPE]

This command selects the AF spectrum result types of the FM demodulated signal to be measured simultaneously.

Parameter

<result type 1|2|3|4|5|6>: WRITe, AVERage, MAXHold, MINHold, VIEW, OFF; for details see "[Trace mode result types](#)" on page 6.294.

Note: The result type "AF spectrum of the FM demodulated signal" cannot be activated at the same time as "AF spectrum of AM or PM demodulated signal".

Example

```
ADEM:FM:AFSP AVER,MAXH,MINH
```

Determines average, maximum and minimum value simultaneously

```
ADEM:FM:AFSP WRIT,OFF,OFF
```

Determines only current measurement results

ADEM:FM:AFSP OFF,OFF,OFF
Switches calculation of AF spectrum off

Characteristics

*RST value: OFF,OFF,OFF
SCPI: device-specific

Mode

A

[SENSe:]ADEMod:FM:AFSPectrum:RESult?

This command reads out the AF spectrum result data of the FM demodulated signal for the specified result type. The data format of the output data is determined with the FORMat command.

Parameter

<result type>: WRITe, AVERAge, MAXHold, MINHold; for details see "[Trace mode result types](#)" on page 6.294.

Note: *The specified result type must be one of those configured with the [SENSe:]ADEMod:FM:AFSPectrum[:TYPE] command. Otherwise a query error will be generated.*

Return values

ASCII Format (FORMat ASCII) or Binary Format (FORMat REAL,32); for details see "[Formats for returned values: ASCII format and binary format](#)" on page 6.294. The output units are described in "[CALCulate<1|2>:MARKer<1...4>:PEXCursion](#)" on page 6.63.

Example

```
ADEM:SET 8MHz,32000,EXT,POS,-500,30
Sets demodulator
ADEM:FM AVER,MAXH,MINH
Selects the FM results to be measured
ADEM:AM:REL WRIT,OFF,OFF
Selects the AM results to be measured
ADEM:FM:AFSP WRIT,OFF,OFF
Selects the AF spectrum results of the demodulated FM signal to be measured
ADEM ON
Switches the demodulator on
INIT;*WAI
Starts the measurement and waits for termination
FORM ASC
Selects output format
ADEM:FM:RES? AVER
Reads FM average result data
ADEM:FM:RES? MAXH
Reads FM maxhold result data
ADEM:FM:RES? MINH
Reads FM minhold result data
ADEM:AM:RES? WRIT
Reads current AM result data
ADEM:FM:AFSP:RES? WRIT
Reads current AF spectrum result data of demodulated FM signal
```

Characteristics

*RST value: -

SCPI: device-specific

Mode

ADEMOD

[SENSe:]ADEMod:FM:OFFSet?

This command calculates the FM offset of the currently available measurement data set.

If averaging has been activated before acquiring the data set (using `[SENSe:]ADEMod:FM[:TDOMain] [:TYPE]`), the averaged FM offset over several measurements can also be obtained by setting `<result type> = AVERage`.

The offset thus determined differs from the one calculated by the `CALCulate<1|2>:MARKer:FUNCTion:ADEMod:FERRor[:RESult<1...6>?]` command since, for determination of the frequency deviation, the modulation is removed by means of lowpass filtering, producing results that are different from those obtained by averaging.

Parameter

<result type>

IMMediate The current measurement results will be used for calculating the FM offset

AVERage The measurement results that were averaged over the given # of measurements will be used for calculating the FM offset

Note: *If no average measurement was active during the last measurement sequence only the `[SENSe:]ADEMod:FM:OFFSet? IMMEDIATE` command will return a correct result (data to calculate the offset are taken from the last measured data set). `[SENSe:]ADEMod:FM:OFFSet? AVERage` will cause a query error in this case.*

Example

```
ADEM:SET 8MHz,32000,EXT,POS,-500,30
```

Sets up demodulator parameters to execute 30 measurements

```
ADEM:FM AVER,OFF,OFF
```

Selects FM results to perform averaging

```
ADEM:AM OFF,OFF,OFF
```

Switches off AM demodulation

```
ADEM ON
```

Switches on analog demodulator

```
INIT;*WAI
```

Starts measurement and waits for sync

```
ADEM:FM:OFFS? IMM
```

Reads FM offset of last measurement of the sequence of 30

```
ADEM:FM:OFFS? AVER
```

Reads FM offset averaged over 30 measurements

Characteristics

*RST values: -

SCPI: device-specific

Mode

ADEMOD

[SENSe:]ADEMod:MTIME

This command defines the measurement time for analog demodulation.

Parameter

<numeric_value>

Example

```
ADEM:MTIM 62.5us
```

Sets the measurement time to 62.5 μ s.

Characteristics

*RST value: 62.5us

SCPI: device-specific

Mode

ADEMOD

[SENSe:]ADEMod:PM[:TDOMain][:TYPE]

This command selects the result types of the PM-demodulated signal to be created simultaneously.

Parameter

<result type 1|2|3|4|5|6>: WRITe, AVERage, MAXHold, MINHold, VIEW; for details see "[Trace mode result types](#)" on page 6.294.

Example

```
ADEM:PM AVER,MAXH,MINH
```

Determines average, maximum and minimum value simultaneously

```
ADEM:PM WRIT,OFF,OFF
```

Determines only current measurement results

```
ADEM:PM OFF,OFF,OFF
```

Switches the PM demodulator off.

Characteristics

RST value: OFF,OFF,OFF

SCPI: device-specific

Mode

ADEMOD

[SENSe:]ADEMod:PM[:TDOMain]:RESult?

This command reads the result data of the PM demodulation for the specified result type. The data format of the output data is determined with the FORMat command.

Parameter

<result type>: WRITe, AVERage, MAXHold, MINHold; for details see "[Trace mode result types](#)" on page 6.294.

Note: *The specified result type must be one of those configured with the [SENSe:]ADEMod:PM[:TDOMain][:TYPE] command. Otherwise a query error will be generated.*

Return values

ASCII Format (FORMat ASCII) or Binary Format (FORMat REAL,32); for details see "[Formats for returned values: ASCII format and binary format](#)" on page 6.294. The output units are described in "[CALCulate<1|2>:MARKer<1...4>:PEXCursion](#)" on page 6.63.

Example

```
ADEM:SET 8MHz,32000,EXT,POS,-500,30
```

Sets the demodulator parameters.

```
ADEM:PM AVER,MAXH,MINH
```

Selects the PM results to be measured.

```
ADEM:AM WRIT,OFF,OFF
```

Selects the AM results to be measured.

```
ADEM ON
```

Switches on the demodulator.

```
INIT;*WAI
```

Starts the measurement and waits for termination.

```
FORM ASC
```

Selects the output format.

```
ADEM:PM:RES? AVER
```

Reads the PM average result data.

```
ADEM:PM:RES? MAXH
```

Reads the PM maxhold result data.

```
ADEM:PM:RES? MINH
```

Reads the PM minhold result data.

```
ADEM:AM:RES? WRIT
```

Reads the current AM result data.

Characteristics

RST value: -

SCPI: device-specific

Mode

ADEMOD

[SENSe:]ADEMod:PM:AFSPectrum[:TYPE]

This command selects the AF spectrum result types of the PM-demodulated signal to be measured simultaneously.

Parameter

<result type 1|2|3|4|5|6>: WRITe, AVERage, MAXHold, MINHold, VIEW; for details see "[Trace mode result types](#)" on page 6.294.

Note: The result type "AF spectrum of the PM demodulated signal" cannot be activated at the same time as "AF spectrum of AM or FM demodulated signal".

Example

```
ADEM:PM:AFSP AVER,MAXH,MINH
```

Determines average, maximum and minimum value simultaneously

```
ADEM:PM:AFSP WRIT,OFF,OFF
```

Determines only current measurement results

```
ADEM:PM:AFSP OFF,OFF,OFF
```

Switches calculation of AF spectrum off

Characteristics

RST value: OFF,OFF,OFF

SCPI: device-specific

Mode

ADEM0D

[SENSe:]ADEMod:PM:AFSPectrum:RESult?

This command reads out the AF spectrum result data of the PM-demodulated signal for the specified result type. The data format of the output data is determined with the `FORMat` command.

Parameter

<result type>: `WRITe`, `AVERage`, `MAXHold`, `MINHold`; for details see "[Trace mode result types](#)" on page 6.294.

Note: *The specified result type must be one of those configured with the `[SENSe:]ADEMod:PM:AFSPectrum[:TYPE]` command. Otherwise a query error will be generated.*

Return values

ASCII Format (`FORMat ASCII`) or Binary Format (`FORMat REAL,32`); for details see "[Formats for returned values: ASCII format and binary format](#)" on page 6.294. The output units are described in section "[CALCulate<1|2>:MARKer<1...4>:PEXCursion](#)" on page 6.63.

Example

```
ADEM:SET 8MHz,32000,EXT,POS,-500,30
Sets demodulator
ADEM:PM AVER,MAXH,MINH
Selects the PM results to be measured
ADEM:AM:REL WRIT,OFF,OFF
Selects the AM results to be measured
ADEM:PM:AFSP WRIT,OFF,OFF
Selects the AF spectrum results of the demodulated PM signal to be measured
ADEM ON
Switches the demodulator on
INIT;*WAI
Starts the measurement and waits for termination
FORM ASC
Selects output format
ADEM:PM:RES? AVER
Reads PM average result data
ADEM:PM:RES? MAXH
Reads PM maxhold result data
ADEM:PM:RES? MINH
Reads PM minhold result data
ADEM:AM:RES? WRIT
Reads current AM result data
ADEM:PM:AFSP:RES? WRIT
Reads current AF spectrum result data of demodulated PM signal
```

Characteristics

RST value: -

SCPI: device-specific

Mode

ADEM0D

[SENSe:]ADEMod:PM:RPOint[:X]

This command determines the position where the phase of the PM-demodulated signal is set to 0 rad. The maximum possible value depends on the measurement time selected in the instrument; this value is output in response to the query `ADEM:PM:RPO:X? MAX.`

Parameter

0 s to measurement time

Example

```
ADEM:PM:RPO 500us
```

Sets the position where the phase to 0 rad setting to 500 μ s.

Characteristics

RST value: 0 s

SCPI: conform

Mode

ADEMOD

[SENSe:]ADEMod:RLENgth?

This command returns the record length set up for the current analog demodulation measurement.

Example

```
ADEM:RLEN?
```

Returns the current record length.

Characteristics

*RST value: -

SCPI: device-specific

Mode

ADEMOD

[SENSe:]ADEMod:SET

This command configures the analog demodulator of the instrument.

Parameter

<sample rate> The frequency at which measurement values are taken from the A/D-converter and stored in I/Q memory.

Allowed range: refer to chapter "Instrument Functions", section "Analog Demodulation (Option K7)" - "Sample rate, measurement time and trigger offset".

<record length> Number of samples to be stored in I/Q memory.

Allowed range:
1 to 400001 with AF filter or AF trigger active
1 to 480001 with both AF filter and AF trigger deactive

<trigger source> Selection of the trigger source to use for the demodulator.

Allowed values: IMMEDIATE | EXTERNAL | IFPOWER | RFPower | AF | AM | AMRelative | FM | PM (see note below)

<trigger slope>	Used slope of the trigger signal. Allowed values: POSitive NEGative The value indicated here will be ignored for <trigger source> = IMMEDIATE.
<offset samples>	Number of samples to be used as an offset to the trigger signal. Allowed range: -65024 to 130559 (= -64 * 1024 + 512 to 128 * 1024 - 513) The value indicated here will be ignored for <trigger source> = IMMEDIATE.
<# of meas>	Number of repetitions of the measurement to be executed. The value indicated here is especially necessary for the average/maxhold/minhold function. Allowed range: 0 to 32767

Note: After selecting IFPower, the trigger threshold can be set with the `TRIGger<1|2>[:SEquence]:LEVel:IFPower` command.

Example

```
ADEM:SET 8MHz,32000,EXT,POS,-500,30
```

Performs a measurement at:

sample rate	8 MHz
record length	32000
trigger source	EXTernal
trigger slope	POSitive
offset samples	-500 (500 samples before trigger occurred)
# of meas	30

Characteristics

*RST value:

sample rate	8 MHz
record length	501
trigger source	IMMEDIATE
trigger slope	POSitive
offset samples	0
# of meas	0

SCPI: device-specific

Mode

ADEMOD

[SENSe:]ADEMod:SPECTrum[:TYPE]

This command selects the result types to be created in parallel by the RF spectrum measurement with active analog demodulation.

Parameter

<result type 1|2|3|4>: WRITe, AVERage, MAXHold, MINHold, VIEW, OFF; for details see "Trace mode result types" on page 6.294.

Example

```
ADEM:SPEC AVER,MAXH,MINH
```

Creates average, max hold and min hold values at a time

```
ADEM:SPEC WRIT,OFF,OFF
```

Only creates the current measurement values

```
ADEM:SPEC OFF,OFF,OFF
```

Switches analog demodulator off

Characteristics

*RST value: OFF,OFF,OFF

SCPI: device-specific

Mode

ADEMOD

[SENSe:]ADEMod:SPECTrum:BANDwidth|BWIDth[:RESolution]

This command sets the resolution bandwidth for spectrum representation that was determined from the analog demodulation data.

The recording time required is calculated from the sampling rate indirectly set via

[\[SENSe:\]ADEMod:SPECTrum:SPAN\[:MAXimum\]](#) or

[\[SENSe:\]ADEMod:BANDwidth|BWIDth:DEModulation](#). If the available recording time is not sufficient for the given bandwidth, the recording time is set to its maximum and the resolution bandwidth is enlarged to the resulting bandwidth.

Parameter

refer to data sheet

Example

```
ADEM ON
```

Switches on the analog demodulator

```
CALC:FEED 'XTIM:SPEC'
```

Switches on the RF spectrum result display

or

```
CALC:FEED 'XTIM:FM:AFSP'
```

Switches on the AF spectrum result display of FM signal

```
ADEM:SPEC:BAND 61.2kHz
```

Sets the resolution bandwidth to 61.2 kHz.

Characteristics

*RST value: 61.2 kHz

SCPI: device-specific

Mode

ADEMOD

[SENSe:]ADEMod:SPECTrum:RESult?

This command reads out the RF spectrum result data for the specified result type. The data format of the output data block is defined by the `FORMat` command.

Parameter

<result type>: WRITe, AVERage, MAXHold, MINHold; for details see "[Trace mode result types](#)" on page 6.294.

Note: *The result type indicated must be one of those configured by `[SENSe:]ADEMod:SPECTrum[:TYPE]`. Otherwise a query error will be generated.*

Return values

ASCII Format (`FORMat ASCII`) or Binary Format (`FORMat REAL,32`); for details see "[Formats for returned values: ASCII format and binary format](#)" on page 6.294. The output units are described in "[CALCulate<1|2>:MARKer<1...4>:PEXCursion](#)" on page 6.63.

Example

```
ADEM:SET 8MHz,32000,EXT,POS,-500,30
```

Sets up demodulator parameters

```
ADEM:SPEC AVER,MAXH,MINH
```

Selects RF spectrum results to be measured

```
ADEM:SPEC WRIT,OFF,OFF
```

Selects AM results to be measured

```
ADEM ON
```

Switches on demodulator

```
INIT;*WAI
```

Starts measurement and waits for sync

```
FORM ASC
```

Selects output format

```
ADEM:SPEC:RES? AVER
```

Reads RF spectrum average results

```
ADEM:SPEC:RES? MAXH
```

Reads RF spectrum max hold results

```
ADEM:SPEC:RES? MINH
```

Reads RF spectrum min hold results

```
ADEM:SPEC:RES? WRIT
```

Reads spectrum current results

Characteristics

*RST value: -

SCPI: device-specific

Mode

ADEMOD

[SENSe:]ADEMod:SPECTrum:SPAN[:MAXimum]

This command sets the maximum frequency range for displaying the RF spectrum that was determined from the analog demodulation data. The maximum span corresponds to the measurement bandwidth of analog demodulation (for details refer to [\[SENSe:\]ADEMod:BANDwidth|BWIDth:DEModulation](#)). For details refer on the relation of bandwidth and sample rate refer to chapter "Instrument Functions", section "Analog Demodulation (Option K7)" - "Sample rate, measurement time and trigger offset".

Parameter

<numeric_value>

Example

ADEM ON

Switches on the analog demodulator

CALC:FEED 'XTIM:SPEC'

Switches on RF spectrum result display.

ADEM:SPEC:SPAN:MAX 5 MHz

Sets the max. span to 5 MHz

ADEM:SPEC:SPAN:ZOOM 1 MHz

Sets the displayed span to 1 MHz

Characteristics

*RST value: 5 MHz

SCPI: device-specific

Mode

ADEMOD

[SENSe:]ADEMod:SPECTrum:SPAN:ZOOM

This command sets the frequency range for the RF spectrum result display determined from analog demodulation data. The frequency range for result display is limited to the maximum span (`[SENSe:]ADEMod:SPECTrum:SPAN[:MAXimum]`) or to the measurement bandwidth of analog demodulation (`[SENSe:]ADEMod:BANDwidth|BWIDth:DEModulation`).

Parameter

<numeric_value>

Example

ADEM ON

Switches on the analog demodulator

CALC:FEED 'XTIM:SPEC'

Switches on RF spectrum result display"

ADEM:SPEC:SPAN:MAX 5 MHz

Sets the maximum span to 5 MHz

ADEM:SPEC:SPAN:ZOOM 1 MHz

Sets displayed span to 1 MHz

Characteristics

*RST value: 5 MHz

SCPI: device-specific

Mode

ADEMOD

[SENSe:]ADEMod:SRATe?

This command returns the sample rate set up for the current analog demodulation measurement.

Example

ADEM:SRAT?

Returns the current sample rate.

Characteristics

*RST value: -

SCPI: device-specific

Mode

ADEMOD

[SENSe:]ADEMod:ZOOM[:STATe]

The command enables or disables the zoom function for the analog-demodulated measurement data. Depending on the selected measurement time and the demodulation bandwidth, the number of recorded test points may be greater than that shown on the display.

If the zoom function is enabled, 501 test points of the result memory are displayed from the specified start time with `[SENSe:]ADEMod:ZOOM:START`.

If the zoom function is disabled, data reduction is used to adapt the test points to the number of points available on the display.

Parameter

ON | OFF

Example

```
ADEM:ZOOM ON
```

Switches on the zoom function

Characteristics

*RST value: OFF

SCPI: device-specific

Mode

ADEMOD

[SENSe:]ADEMod:ZOOM:START

The command selects the start time for the display of individual measured values of the analog demodulation. The maximum possible value depends on the measurement time, which is set in the instrument and can be queried with the `[SENSe:]ADEMod:MTIME` command.

If the zoom function is enabled, 501 test points of the result memory are displayed from the specified start time with `[SENSe:]ADEMod:ZOOM:START`.

Parameter

0 s to measurement time - $(500 * 1/\text{sample rate})$

Example

```
ADEM:ZOOM ON
```

Switches on the zoom function

```
ADEM:ZOOM:STAR 500us
```

Sets the starting point of the display to 500 μs .

Characteristics

*RST value: 0 s

SCPI: device-specific

Mode

ADEMOD

SENSE:BANDwidth Subsystem (Analog Demodulation, K7)

This subsystem controls the setting of the instruments filter bandwidths. Both groups of commands (BANDwidth and BWIDth) perform the same functions.

Commands of the SENSE:BANDwidth Subsystem

– [SENSe<1|2>:]BANDwidth|BWIDth:DEMod

[SENSe<1|2>:]BANDwidth|BWIDth:DEMod

This command sets the bandwidth for analog demodulation. Depending on the selected demodulation bandwidth, the instrument selects the required sampling rate.

The available values of the demodulation bandwidths are determined by the sampling rates. For details on the correlation between demodulation bandwidth and sampling rate refer to chapter "Instrument Functions", sections "Analog Demodulation (Option K7)" - "Sample rate, measurement time and trigger offset".

Parameter

<numeric_value>

Example:

```
BAND:DEM 1MHz
```

Sets test bandwidth to 1 MHz

Characteristics:

*RST value: 5 MHz

SCPI: device-specific

Mode

A-F, ADEM0D

SENSe:FILTer Subsystem (Analog Demodulation, K7)

The SENSe:FILTer subsystem selects the filters to reduce the bandwidth of the demodulated signal. The selected filters are used for AM, FM and PM demodulation in common.

Commands of the SENSe:FILTer subsystem

- [SENSe<1|2>:]FILTer:DEMPHasis[:STATe]
- [SENSe<1|2>:]FILTer:DEMPHasis:TCONstant
- [SENSe<1|2>:]FILTer:HPASs[:STATe]
- [SENSe<1|2>:]FILTer:HPASs:FREQuency
- [SENSe<1|2>:]FILTer:LPASs[:STATe]
- [SENSe<1|2>:]FILTer:LPASs:FREQuency[:ABSolute]
- [SENSe<1|2>:]FILTer:LPASs:FREQuency:RELative

[SENSe<1|2>:]FILTer:DEMPHasis[:STATe]

This command activates/deactivates the selected deemphasis. The numeric suffixes <1|2> are irrelevant.

Parameter

ON | OFF

Example

```
FILT:DEMP ON
```

Activates the selected deemphasis.

Characteristics

RST value: OFF

SCPI: device-specific

Mode

ADEMODO

[SENSe<1|2>:]FILTer:DEMPHasis:TCONstant

This command selects the deemphasis. For details on deemphasis refer to chapter "Instrument Functions", section "Analog Demodulation (Option K7)", **Deemphasis** softkey.

The numeric suffixes <1|2> are irrelevant.

Parameter

25 us | 50 us | 75 us | 750 us

Example

```
FILT:DEMP:TCON 750us
```

Selects the deemphasis for the demodulation bandwidth range from 800 Hz to 4 MHz with a time constant of 750 μ s.

Characteristics

RST value: 50 us

SCPI: device-specific

Mode

ADEMODO

[SENSe<1|2>:FILTeR:HPASs[:STATE]

This command activates/deactivates the selected high pass filter.
The numeric suffixes <1|2> are irrelevant.

Parameter

ON | OFF

Example

```
FILT:HPAS ON
```

Activates the selected high pass filter.

Characteristics

RST value: OFF

SCPI: device-specific

Mode

ADEMODO

[SENSe<1|2>:FILTeR:HPASs:FREQuency

This command selects the high pass filter type. For details on filters refer to chapter "Instrument Functions", section "Analog Demodulation (Option K7)", **High Pass AF Filter** softkey.

The numeric suffixes <1|2> are irrelevant.

Parameter

50Hz | 300Hz

Example

```
FILT:HPAS:FREQ 300Hz
```

Selects the high pass filter for the demodulation bandwidth range from 800 Hz to 16 MHz.

Characteristics

RST value: 300Hz

SCPI: device-specific

Mode

ADEMODO

[SENSe<1|2>:FILTeR:LPASs[:STATE]

This command activates/deactivates the selected low pass filter.
The numeric suffixes <1|2> are irrelevant.

Parameter

ON | OFF

Example

```
FILT:LPAS ON
```

Activates the selected low pass filter.

Characteristics

RST value: OFF

SCPI: device-specific

Mode

ADEMODO

[SENSe<1|2>:]FILTer:LPASs:FREQuency[:ABSolute]

This command selects the absolute low pass filter type. For details on filters refer to chapter "Instrument Functions", section "Analog Demodulation (Option K7)", **Low Pass AF Filter** softkey.

The numeric suffixes <1|2> are irrelevant.

Parameter

3kHz | 15kHz | 150kHz

Example

```
FILT:LPAS:FREQ 150kHz
```

Selects the low pass filter for the demodulation bandwidth range from 400 kHz to 16 MHz.

Characteristics

RST value: 15kHz

SCPI: device-specific

Mode

ADEMODO

[SENSe<1|2>:]FILTer:LPASs:FREQuency:RELAtive

This command selects the relative low pass filter type. For details on filters refer to chapter "Instrument Functions", section "Analog Demodulation (Option K7)", **Low Pass AF Filter** softkey.

The numeric suffixes <1|2> are irrelevant.

Parameter

5PCT | 10PCT | 25PCT

Example

```
FILT:LPAS:FREQ 25PCT
```

Selects the low pass filter as 25% of the demodulation bandwidth.

Characteristics

RST value: 25PCT

SCPI: device-specific

Mode

ADEMODO

SENSE:FREQUENCY Subsystem (Analog Demodulation, K7)

The SENSE:FREQUENCY subsystem defines the frequency axis of the active display. The frequency axis can either be defined via the start/stop frequency or via the center frequency and span.

Commands of the SENSE:FREQUENCY Subsystem

– [\[SENSE<1|2>:\]FREQUENCY:CENTER:STEP:LINK](#)

[\[SENSE<1|2>:\]FREQUENCY:CENTER:STEP:LINK](#)

Parameter

SPAN coupling to frequency display range (for RF spectrum result display)
RBW coupling to demodulation bandwidth (for all result displays except RF spectrum)
OFF manual input, no coupling

For further details refer to "[\[SENSE<1|2>:\]FREQUENCY:CENTER:STEP:LINK](#)" on page 6.195.

SENSe:SWEEp Subsystem (Analog Demodulation, K7)

The SENSe:SWEEp subsystem controls the sweep parameters.

Commands of the SENSe:SWEEp Subsystem

– [\[SENSe<1|2>:\]SWEEp:TIME](#)

[SENSe<1|2>:]SWEEp:TIME

Parameter

Refer to chapter "Instrument Functions", section "Analog Demodulation (Option K7)" - "Sample rate, measurement time and trigger offset".

For further details refer to "[\[SENSe<1|2>:\]SWEEp:TIME](#)" on page 6.227.

TRACe Subsystem (Analog Demodulation, K7)

The TRACe subsystem controls access to the instruments internal trace memory.

Commands of the TRACe Subsystem

– [TRACe<1|2>\[:DATA\]](#)

TRACe<1|2>[:DATA]

If the analog demodulator (option Analog Demodulation, R&S FSL-K7) is active, only the displayed trace data is read out and recalled. A portion of the measurement data that can be called by means of a marker, however, is calculated from the raw measurement data. These results are no longer available after recalling a trace; the associated queries generate a query error.

For further information refer to "[TRACe<1|2>\[:DATA\]](#)" on page 6.256.

TRIGger Subsystem (Analog Demodulation, K7)

The TRIGger subsystem is used to synchronize instrument actions with events. It is thus possible to control and synchronize the start of a sweep.

Commands of the TRIGger Subsystem

- TRIGger<1|2>[:SEQuence]:LEVel:AM[:ABSolute]
- TRIGger<1|2>[:SEQuence]:LEVel:AM:RELative
- TRIGger<1|2>[:SEQuence]:LEVel:FM
- TRIGger<1|2>[:SEQuence]:LEVel:PM
- TRIGger<1|2>[:SEQuence]:SOURce

TRIGger<1|2>[:SEQuence]:LEVel:AM[:ABSolute]

The command sets the level when RF power signals are used as trigger source.

Note: For triggering with AF, AM, AMRelative, FM, and PM trigger sources to be successful, the measurement time must cover at least 5 periods of the audio signal.

Parameter

-100 to +30 dBm

Example

```
TRIG:LEV:AM -30 dBm
```

Sets the RF power signal trigger threshold to -30 dBm

Characteristics

*RST value: -20 dBm

SCPI: device-specific

Mode

ADEMOD

TRIGger<1|2>[:SEQuence]:LEVel:AM:RELative

The command sets the level when AM-modulated signals are used as trigger source.

Note: For triggering with AF, AM, AMRelative, FM, and PM trigger sources to be successful, the measurement time must cover at least 5 periods of the audio signal.

Parameter

-100 to +100 %

Example

```
TRIG:LEV:AM:REL -20 %
```

Sets the AM trigger threshold to -20 %

Characteristics

*RST value: 0 %

SCPI: device-specific

Mode

ADEMOD

TRIGger<1|2>[:SEQuence]:LEVel:FM

The command sets the level when FM-modulated signals are used as trigger source.

Note: For triggering with AF, AM, AMRelative, FM, and PM trigger sources to be successful, the measurement time must cover at least 5 periods of the audio signal.

Parameter

-10 to +10 MHz

Example

```
TRIG:LEV:FM 10 kHz
```

Sets the FM trigger threshold to 10 kHz

Characteristics

*RST value: 0 Hz

SCPI: device-specific

Mode

ADEMOD

TRIGger<1|2>[:SEQuence]:LEVel:PM

The command sets the level when PM-modulated signals are used as trigger source.

Note: For triggering with AF, AM, AMRelative, FM, and PM trigger sources to be successful, the measurement time must cover at least 5 periods of the audio signal.

Parameter

-1000 to +1000 RAD | DEG

Example

```
TRIG:LEV:PM 1.2 RAD
```

Sets the PM trigger threshold to 1.2 rad

Characteristics

*RST value: 0 RAD

SCPI: device-specific

Mode

ADEMOD

TRIGger<1|2>[:SEQuence]:SOURce**Parameter**

IMMediate (Free Run) | EXTern | IFPower | AF | FM | AM | AMRelative | PM

The parameter AM corresponds to the RF power signal, the parameter AMRelative corresponds to the AM signal.

For details on trigger modes refer to chapter "Instrument Functions", section "Analog Demodulation (Option K7)".

Note: For triggering with AF, AM, AMRelative, FM, and PM trigger sources to be successful, the measurement time must cover at least 5 periods of the audio signal.

For further details refer to "[TRIGger<1|2>\[:SEQuence\]:SOURce](#)" on page 6.272.

UNIT Subsystem (Analog Demodulation, K7)

The UNIT subsystem sets the basic unit of the setting parameters.

Commands of the UNIT Subsystem

- [UNIT:ANGLE](#)

UNIT:ANGLE

This command selects the unit for angles.

Parameter

DEG | RAD

Example

UNIT:ANGL DEG

Characteristics

RST value: RAD

SCPI: conform

Mode

ADEMODO

Remote Commands of the Bluetooth Measurements Option (K8)

In this section all remote control commands for the Bluetooth Measurements option are described in detail. The abbreviation BT stands for the Bluetooth operating mode. For details on conventions used in this chapter refer to section "Notation" on page 6.2 at the beginning of this chapter.

For further information on analyzer or basic settings commands, refer to the corresponding subsystem in "Remote Commands of the Base Unit" on page 6.5.

This option is available from firmware version 1.30.

Subsystems of the Bluetooth Measurements option (K9)

- "CALCulate:BT00th Subsystem (BLUETOOTH, K8)" on page 6.326
- "CALCulate:DELTamarker Subsystem (BLUETOOTH, K8)" on page 6.345
- "CALCulate:MARKer Subsystem (BLUETOOTH, K8)" on page 6.346
- "CONFigure:BT00th Subsystem (BLUETOOTH, K8)" on page 6.347
- "DISPlay Subsystem (BLUETOOTH, K8)" on page 6.361
- "INSTrument Subsystem (BLUETOOTH, K8)" on page 6.362
- "SENSE Subsystem (BLUETOOTH, K8)" on page 6.363

CALCulate:BT0oth Subsystem (BLUETOOTH, K8)

The following commands are used to configure the BLUETOOTH analyzer operating mode. This operating mode requires option R&S FSL-K8.

Commands of the CALCulate:BT0oth Subsystem

- CALCulate<1|2>:BT0oth:ACLR[:LIST]?
- CALCulate<1|2>:BT0oth:ACLR:EXceptions?
- CALCulate<1|2>:BT0oth:CFDRift[:MAXimum]?
- CALCulate<1|2>:BT0oth:CFDRift:RATE?
- CALCulate<1|2>:BT0oth:CFSTability:COUNT?
- CALCulate<1|2>:BT0oth:CFSTability:DEVM:[RMS]?
- CALCulate<1|2>:BT0oth:CFSTability:DEVM:D99Pct?
- CALCulate<1|2>:BT0oth:CFSTability:DEVM:DPCT?
- CALCulate<1|2>:BT0oth:CFSTability:DEVM:PEAK?
- CALCulate<1|2>:BT0oth:CFSTability:FERRor:[TOTal]?
- CALCulate<1|2>:BT0oth:CFSTability:FERRor:BLOCK?
- CALCulate<1|2>:BT0oth:CFSTability:FERRor:INITial?
- CALCulate<1|2>:BT0oth:DPENcoding:[TOTal]?
- CALCulate<1|2>:BT0oth:DPENcoding:BER?
- CALCulate<1|2>:BT0oth:DPENcoding:NERRor?
- CALCulate<1|2>:BT0oth:IBSemiissions:[List]?
- CALCulate<1|2>:BT0oth:IBSemiissions:EXceptions?
- CALCulate<1|2>:BT0oth:IBSemiissions:HADJacent?
- CALCulate<1|2>:BT0oth:IBSemiissions:TXReference?
- CALCulate<1|2>:BT0oth:ICFTolerance?
- CALCulate<1|2>:BT0oth:MCHar:DF<1|2>:AVERAge?
- CALCulate<1|2>:BT0oth:MCHar:DF<1|2>:MAXimum?
- CALCulate<1|2>:BT0oth:MCHar:DF2:PERCent?
- CALCulate<1|2>:BT0oth:MCHar:RATio?
- CALCulate<1|2>:BT0oth:OPOWER[:PEAK]?
- CALCulate<1|2>:BT0oth:OPOWER:AVERAge?
- CALCulate<1|2>:BT0oth:PLENght?
- CALCulate<1|2>:BT0oth:PTYPE?
- CALCulate<1|2>:BT0oth:RTPower:[DPSK]?
- CALCulate<1|2>:BT0oth:RTPower:GFSK?
- CALCulate<1|2>:BT0oth:RTPower:RATio?
- CALCulate<1|2>:BT0oth:STATus?

Further information

- [Example: Adapting the settings to the characteristics of the DUT](#)

Example: Adapting the settings to the characteristics of the DUT

```

INST:SEL BTO
Activates the Bluetooth Measurements option
INIT:CONT OFF
Selects single sweep operation
CONF:BTO:CHAN 10
Selects channel 10
CONF:BTO:PCL 1
Selects power class 1
CONF:BTO:PRAT 4
Selects 4 points per symbol
CONF:BTO:PTYP DH1
Selects 1 slot packet
DDEM:SEAR:SYNC ON
Activates the FIND SYNC function
DDEM:SEAR:SYNC:OFFS 0
Sets the sync offset = 0
DDEM:SEAR:SYNC:LAP #H0
Sets the lower address part = 0
DDEM:SEAR:TIME:AUTO ON
Selects automatic search length

```

CALCulate<1|2>:BT0oth:ACLR[:LIST]?

This command determines the power of the selected adjacent channels. The number of adjacent channel pairs is defined with the [CONFigure:BT0oth:ACLR:ACPairs](#) command.

The results are returned as a list of power values. The structure of the list is as follows:

<TX channel - n>...<TX channel - 1> <TX channel> <TX channel + 1>...<TX channel + n>

The number of adjacent channels is limited at the Bluetooth band limits.

The numeric suffixes <1|2> are irrelevant for this command.

Note: *This command is only available with active Adjacent Channel Power measurement (see [CONFigure:BT0oth:MEASurement](#) command). With all other measurements this command will lead to a query error.*

Example

```

INST:SEL BTO
Activates the Bluetooth Measurements option.
INIT:CONT OFF
Selects single sweep operation.
CONF:BTO:MEAS ACLR
Activates the Adjacent Channel Power measurement.
INIT;*WAI
Starts the measurement with synchronization.
CALC:BTO:ACLR?
Queries the power list.

```

Characteristics

RST value: -

SCPI: device-specific

Mode

BT

CALCulate<1|2>:BT0oth:ACLR:EXCptions?

This command determines the number of exceptions which occurred during the adjacent channel power measurement according to the Bluetooth specification.

The numeric suffixes <1|2> are irrelevant for this command.

Note: *This command is only available with active Adjacent Channel Power measurement (see [CONFigure:BT0oth:MEASurement](#) command). With all other measurements this command will lead to a query error.*

Example

```
INST:SEL BTO
```

Activates the Bluetooth Measurements option.

```
INIT:CONT OFF
```

Selects single sweep operation.

```
CONF:BTO:MEAS ACLR
```

Activates the Adjacent Channel Power measurement.

```
INIT;*WAI
```

Starts the measurement with synchronization.

```
CALC:BTO:ACLR?
```

Queries the power list.

```
CALC:BTO:ACLR:EXC?
```

Queries the number of exceptions.

Characteristics

RST value: -

SCPI: device-specific

Mode

BT

CALCulate<1|2>:BT0oth:CFDRift[:MAXimum]?

This command determines the maximum Carrier Frequency Drift.

The numeric suffixes <1|2> are irrelevant for this command.

Note: *This command is only available with active Carrier Frequency Drift measurement (see [CONFigure:BT0oth:MEASurement](#) command). With all other measurements this command will lead to a query error.*

Example

For the first steps refer to "[Example: Adapting the settings to the characteristics of the DUT](#)" on page 6.327.

```
CONF:BTO:MEAS CFDR
```

Activates the Carrier Frequency Drift measurement.

```
INIT;*WAI
```

Starts the measurement with synchronization.

```
CALC:BTO:CFDR?
```

Queries the result.

Characteristics

RST value: -

SCPI: device-specific

ModeBT

CALCulate<1|2>:BT0oth:CFDRift:RATE?

This command determines the maximum Carrier Frequency Drift per 50 μ s.

The numeric suffixes <1|2> are irrelevant for this command.

Note: This command is only available with active Carrier Frequency Drift measurement (see [CONFigure:BT0oth:MEASurement](#) command). With all other measurements this command will lead to a query error.

Example

For the first steps refer to "[Example: Adapting the settings to the characteristics of the DUT](#)" on page 6.327.

```
CONF: BTO: MEAS CFDR
```

Activates the Carrier Frequency Drift measurement.

```
INIT; *WAI
```

Starts the measurement with synchronization.

```
CALC: BTO: CFDR: RATE?
```

Queries the result.

Characteristics

RST value: -

SCPI: device-specific

ModeBT

CALCulate<1|2>:BT0oth:CFSTability:COUNT?

This command reads the number of measured blocks during or after a measurement.

The numeric suffixes <1|2> are irrelevant for this command.

Note: This command is only available with active Carrier Frequency Stability and Modulation Accuracy measurement (see [CONFigure:BT0oth:MEASurement](#) command). With all other measurements this command will lead to a query error.

Example

For the first steps refer to "[Example: Adapting the settings to the characteristics of the DUT](#)" on page 6.327.

```
CONF: BTO: MEAS CFST
```

Activates the Carrier Frequency Stability and Modulation Accuracy measurement.

```
INIT; *WAI
```

Starts the measurement with synchronization.

```
CALC: BTO: CFST: COUNT?
```

Reads the number of measured blocks.

Characteristics

RST value: -

SCPI: device-specific

Mode

BT

CALCulate<1|2>:BT0oth:CFSTability:DEVM:[RMS]?

This command reads the root mean square (RMS) of the differential error vector magnitude (DEVM) in the Carrier Frequency Stability and Modulation Accuracy measurement.

The numeric suffixes <1|2> are irrelevant for this command.

Note: This command is only available with active Carrier Frequency Stability and Modulation Accuracy measurement (see [CONFigure:BT0oth:MEASurement](#) command). With all other measurements this command will lead to a query error.

Parameter

MINimum | MAXimum | AVERage

Example

For the first steps refer to "[Example: Adapting the settings to the characteristics of the DUT](#)" on page 6.327.

```
CONF: BTO: MEAS CFST
```

Activates the Carrier Frequency Stability and Modulation Accuracy measurement.

```
INIT; *WAI
```

Starts the measurement with synchronization.

```
CALC: BTO: CFST: DEVM? AVER
```

Reads the root mean square of the average differential error vector magnitude.

Characteristics

RST value: -

SCPI: device-specific

Mode

BT

CALCulate<1|2>:BT0oth:CFSTability:DEVM:D99Pct?

This command reads 99% of the differential error vector magnitude (DEVM) in the Carrier Frequency Stability and Modulation Accuracy measurement.

The numeric suffixes <1|2> are irrelevant for this command.

Note: This command is only available with active Carrier Frequency Stability and Modulation Accuracy measurement (see [CONFigure:BT0oth:MEASurement](#) command). With all other measurements this command will lead to a query error.

Example

For the first steps refer to "[Example: Adapting the settings to the characteristics of the DUT](#)" on page 6.327.

```
CONF: BTO: MEAS CFST
```

Activates the Carrier Frequency Stability and Modulation Accuracy measurement.

```
INIT; *WAI
```

Starts the measurement with synchronization.

```
CALC: BTO: CFST: DEVM: D99Pct?
```

Reads 99% of the differential error vector magnitude.

Characteristics

RST value: -

SCPI: device-specific

Mode

BT

CALCulate<1|2>:BT0oth:CFSTability:DEVM:DPCT?

This command is synonym to [CALCulate<1|2>:BT0oth:CFSTability:DEVM:D99Pct?](#).

This command is available from firmware version 1.60.

Characteristics

RST value: -

SCPI: conform

Mode

BT

CALCulate<1|2>:BT0oth:CFSTability:DEVM:PEAK?

This command reads the peak of the differential error vector magnitude (DEVM) in the Carrier Frequency Stability and Modulation Accuracy measurement.

The numeric suffixes <1|2> are irrelevant for this command.

Note: *This command is only available with active Carrier Frequency Stability and Modulation Accuracy measurement (see [CONFigure:BT0oth:MEASurement](#) command). With all other measurements this command will lead to a query error.*

Example

For the first steps refer to "[Example: Adapting the settings to the characteristics of the DUT](#)" on page 6.327.

```
CONF: BTO: MEAS CFST
```

Activates the Carrier Frequency Stability and Modulation Accuracy measurement.

```
INIT; *WAI
```

Starts the measurement with synchronization.

```
CALC: BTO: CFST: DEVM: PEAK?
```

Reads the peak of the differential error vector magnitude.

Characteristics

RST value: -

SCPI: device-specific

Mode

BT

CALCulate<1|2>:BT0oth:CFSTability:FERRor:[TOTal]?

This command reads the carrier frequency deviation of all packets in the Carrier Frequency Stability and Modulation Accuracy measurement.

The numeric suffixes <1|2> are irrelevant for this command.

Note: This command is only available with active Carrier Frequency Stability and Modulation Accuracy measurement (see [CONFigure:BT0oth:MEASurement](#) command). With all other measurements this command will lead to a query error.

Parameter

MINimum | MAXimum | AVERage

Example

For the first steps refer to "[Example: Adapting the settings to the characteristics of the DUT](#)" on page 6.327.

```
CONF:BT0:MEAS CFST
```

Activates the Carrier Frequency Stability and Modulation Accuracy measurement.

```
INIT; *WAI
```

Starts the measurement with synchronization.

```
CALC:BT0:CFST:FERR? MIN
```

Reads the minimum carrier frequency deviation of all packets.

Characteristics

RST value: -

SCPI: device-specific

Mode

BT

CALCulate<1|2>:BT0oth:CFSTability:FERRor:BLOCK?

This command reads the maximum frequency deviation of all blocks in the Carrier Frequency Stability and Modulation Accuracy measurement.

The numeric suffixes <1|2> are irrelevant for this command.

Note: This command is only available with active Carrier Frequency Stability and Modulation Accuracy measurement (see [CONFigure:BT0oth:MEASurement](#) command). With all other measurements this command will lead to a query error.

Parameter

MINimum | MAXimum | AVERage

Example

For the first steps refer to "[Example: Adapting the settings to the characteristics of the DUT](#)" on page 6.327.

```
CONF:BT0:MEAS CFST
```

Activates the Carrier Frequency Stability and Modulation Accuracy measurement.

```
INIT; *WAI
```

Starts the measurement with synchronization.

```
CALC:BT0:CFST:FERR:BLOCK? AVER
```

Reads the maximum average frequency deviation of all blocks.

Characteristics

RST value: -

SCPI: device-specific

Mode

BT

CALCulate<1|2>:BT0oth:CFSTability:FERRor:INITial?

This command reads the combined frequency deviation of all packets and all blocks in the Carrier Frequency Stability and Modulation Accuracy measurement.

The numeric suffixes <1|2> are irrelevant for this command.

Note: *This command is only available with active Carrier Frequency Stability and Modulation Accuracy measurement (see [CONFigure:BT0oth:MEASurement](#) command). With all other measurements this command will lead to a query error.*

Parameter

MINimum | MAXimum | AVERage

Example

For the first steps refer to "[Example: Adapting the settings to the characteristics of the DUT](#)" on page 6.327.

```
CONF:BT0:MEAS CFST
```

Activates the Carrier Frequency Stability and Modulation Accuracy measurement.

```
INIT;*WAI
```

Starts the measurement with synchronization.

```
CALC:BT0:CFST:FERR:INIT? MAX
```

Reads the combined maximum frequency deviation of all packets and all blocks.

Characteristics

RST value: -

SCPI: device-specific

Mode

BT

CALCulate<1|2>:BT0oth:DPENcoding:[TOTAl]?

This command reads the number of tested packets in the Differential Phase Encoding measurement.

The numeric suffixes <1|2> are irrelevant for this command.

Note: *This command is only available with active Differential Phase Encoding measurement (see [CONFigure:BT0oth:MEASurement](#) command). With all other measurements this command will lead to a query error.*

Example

For the first steps refer to "[Example: Adapting the settings to the characteristics of the DUT](#)" on page 6.327.

```
CONF:BT0:MEAS DPEN
```

Activates the Differential Phase Encoding measurement.

```
INIT;*WAI
```

Starts the measurement with synchronization.

```
CALC:BT0:DPEN?
```

Reads the number of tested packets.

Characteristics

RST value: -

SCPI: device-specific

Mode

BT

CALCulate<1|2>:BT0oth:DPENcoding:BER?

This command reads the bit error rate (BER) in the Differential Phase Encoding measurement. The numeric suffixes <1|2> are irrelevant for this command.

Note: This command is only available with active Differential Phase Encoding measurement (see [CONFigure:BT0oth:MEASurement](#) command). With all other measurements this command will lead to a query error.

Example

For the first steps refer to "[Example: Adapting the settings to the characteristics of the DUT](#)" on page 6.327.

```
CONF: BTO: MEAS DPEN
```

Activates the Differential Phase Encoding measurement.

```
INIT; *WAI
```

Starts the measurement with synchronization.

```
CALC: BTO: DPEN: BER?
```

Reads the bit error rate.

Characteristics

RST value: -

SCPI: device-specific

Mode

BT

CALCulate<1|2>:BT0oth:DPENcoding:NERRor?

This command reads the number of passed packets in the Differential Phase Encoding measurement.

The numeric suffixes <1|2> are irrelevant for this command.

Note: This command is only available with active Differential Phase Encoding measurement (see [CONFigure:BT0oth:MEASurement](#) command). With all other measurements this command will lead to a query error.

Example

For the first steps refer to "[Example: Adapting the settings to the characteristics of the DUT](#)" on page 6.327.

```
CONF: BTO: MEAS DPEN
```

Activates the Differential Phase Encoding measurement.

```
INIT; *WAI
```

Starts the measurement with synchronization.

```
CALC: BTO: DPEN: NERR?
```

Reads the number of passed packets.

Characteristics

RST value: -

SCPI: device-specific

Mode

BT

CALCulate<1|2>:BT0oth:IBSEmissions:[List]?

This command reads the power of all adjacent channels in the In-band Spurious Emissions measurement.

The numeric suffixes <1|2> are irrelevant for this command.

Note: *This command is only available with active In-band Spurious Emissions measurement (see [CONFigure:BT0oth:MEASurement](#) command). With all other measurements this command will lead to a query error.*

Example

For the first steps refer to "[Example: Adapting the settings to the characteristics of the DUT](#)" on page 6.327.

```
CONF: BTO: MEAS IBS
```

Activates the In-band Spurious Emissions measurement.

```
CONF: BTO: CHAN 7
```

Adjust the TX channel number.

```
INIT; *WAI
```

Starts the measurement with synchronization.

```
CALC: BTO: IBS?
```

Reads the results of the In-band Spurious Emissions measurement.

Characteristics

RST value: -

SCPI: device-specific

Mode

BT

CALCulate<1|2>:BT0oth:IBSEmissions:EXCEPTIONS?

This command reads the number of results that exceeded the specified limits in the In-band Spurious Emissions measurement.

The numeric suffixes <1|2> are irrelevant for this command.

Note: *This command is only available with active In-band Spurious Emissions measurement (see [CONFigure:BT0oth:MEASurement](#) command). With all other measurements this command will lead to a query error.*

Example

For the first steps refer to "[Example: Adapting the settings to the characteristics of the DUT](#)" on page 6.327.

```
CONF: BTO: MEAS IBS
```

Activates the In-band Spurious Emissions measurement.

```
CONF: BTO: CHAN 7
```

Adjust the TX channel number.

```
INIT; *WAI
```

Starts the measurement with synchronization.

```
CALC: BTO: IBS: EXC?
```

Reads the number of results that exceeded the specified limits.

Characteristics

RST value: -

SCPI: device-specific

Mode

BT

CALCulate<1|2>:BT0oth:IBSemiissions:HADJacent?

This command reads the maximum power of the upper or lower frequency band (500 kHz) of the TX channel in the In-band Spurious Emissions measurement.

The numeric suffixes <1|2> are irrelevant for this command.

Note: *This command is only available with active In-band Spurious Emissions measurement (see [CONFigure:BT0oth:MEASurement](#) command). With all other measurements this command will lead to a query error.*

Parameter

UPPer | LOWer

Example

For the first steps refer to "[Example: Adapting the settings to the characteristics of the DUT](#)" on page 6.327.

```
CONF: BTO: MEAS IBS
```

Activates the In-band Spurious Emissions measurement.

```
CONF: BTO: CHAN 7
```

Adjust the TX channel number.

```
INIT; *WAI
```

Starts the measurement with synchronization.

```
CALC: BTO: IBS: HADJ? LOW
```

Reads the maximum power of the lower frequency band.

Characteristics

RST value: -

SCPI: device-specific

Mode

BT

CALCulate<1|2>:BT0oth:IBSemiissions:TXReference?

This command reads the TX channel reference power.

The numeric suffixes <1|2> are irrelevant for this command.

Note: *This command is only available with active In-band Spurious Emissions measurement (see [CONFigure:BT0oth:MEASurement](#) command). With all other measurements this command will lead to a query error.*

Example

For the first steps refer to "[Example: Adapting the settings to the characteristics of the DUT](#)" on page 6.327.

```
CONF: BTO: MEAS IBS
```

Activates the In-band Spurious Emissions measurement.

```
CONF: BTO: CHAN 7
```

Adjust the TX channel number.

```
INIT; *WAI
```

Starts the measurement with synchronization.

```
CALC: BTO: IBS: TXR?
```

Reads the TX channel reference power.

Characteristics

RST value: -

SCPI: device-specific

Mode

BT

CALCulate<1|2>:BT0oth:ICFTolerance?

This command determines the Initial Carrier Frequency Tolerance.

The numeric suffixes <1|2> are irrelevant for this command.

Note: This command is only available with active Modulation Characteristics measurement (see [CONFigure:BT0oth:MEASurement](#) command). With all other measurements this command will lead to a query error.

Parameter

MINimum | MAXimum | AVERage

Example

For the first steps refer to "[Example: Adapting the settings to the characteristics of the DUT](#)" on page 6.327.

```
CONF:BT0:MEAS ICFT
```

Activates the Initial Carrier Frequency Tolerance measurement.

```
CONF:BT0:SWE:COUN 20
```

Initiates the sweep counter with 20.

```
INIT;*WAI
```

Starts the measurement with synchronization.

```
CALC:BT0:ICFT? AVER
```

Queries the average value.

Characteristics

RST value: -

SCPI: device-specific

Mode

BT

CALCulate<1|2>:BT0oth:MCHar:DF<1|2>:AVERage?

This command determines the average frequency deviation for varying bit patterns of the payload. The suffixes of DF<1|2> assign the frequency deviation and the bit pattern as follows:

Frequency deviation	$\Delta f_{1\text{avg}}$	$\Delta f_{2\text{avg}}$
Bit pattern	"11110000"	"10101010"

The numeric suffixes <1|2> of CALCulate are irrelevant for this command.

Note: This command is only available with active Modulation Characteristics measurement (see [CONFigure:BT0oth:MEASurement](#) command). With all other measurements this command will lead to a query error.

Parameter

MINimum | MAXimum

Example

For the first steps refer to ["Example: Adapting the settings to the characteristics of the DUT"](#) on page 6.327.

```
CONF:BTO:MEAS MCH
```

Activates the Modulation Characteristics measurement.

```
CONF:BTO:SWE:COUN 20
```

Initiates the sweep counter with 20.

... EUT emits bit pattern 1111000

```
INIT:IMM;*WAI
```

Starts the measurement with synchronization and erase previous measurement results.

```
CALC:BTO:MCH:DF1:AVER? MIN
```

Queries minimum value "11110000".

Characteristics

RST value: -

SCPI: device-specific

Mode

BT

CALCulate<1|2>:BT0oth:MCHar:DF<1|2>:MAXimum?

This command determines the maximum frequency deviation for different bit patterns of the payload. The suffixes of DF<1|2> assign the frequency deviation and the bit pattern as follows:

Frequency deviation	Δf_{1max}	Δf_{2max}
Bit pattern	"11110000"	"10101010"

The numeric suffixes <1|2> of CALCulate are irrelevant for this command.

Note: This command is only available with active Modulation Characteristics measurement (see [CONFigure:BT0oth:MEASurement](#) command). With all other measurements this command will lead to a query error.

Parameter

MINimum | MAXimum | AVERage

Example

For the first steps refer to ["Example: Adapting the settings to the characteristics of the DUT"](#) on page 6.327.

```
CONF:BTO:MEAS MCH
```

Activates the Modulation Characteristics measurement.

```
CONF:BTO:SWE:COUN 20
```

Initiates the sweep counter with 20.

... EUT emits bit pattern 1111000

```
INIT:IMM;*WAI
```

Starts the measurement with synchronization and erase previous measurement results.

```
CALC:BTO:MCH:DF1:MAX? MIN
```

Queries minimum value "11110000".

Characteristics

RST value: -

SCPI: device-specific

Mode

BT

CALCulate<1|2>:BT0oth:MCHar:DF2:PERCent?

This command determines the percentage of measurements of the frequency deviation, for which the value of $\Delta f_{2_{\max}}$ is within the allowed range. Therefore only the numeric suffix 2 is allowed for DF.

The numeric suffixes <1|2> of CALCulate are irrelevant for this command.

Note: This command is only available with active Modulation Characteristics measurement (see [CONFigure:BT0oth:MEASurement](#) command). With all other measurements this command will lead to a query error.

Example

For the first steps refer to "[Example: Adapting the settings to the characteristics of the DUT](#)" on page 6.327.

```
CONF: BTO: MEAS MCH
```

Activates the Modulation Characteristics measurement.

```
CONF: BTO: SWE: COUN 20
```

Initiates the sweep counter with 20.

... EUT emits bit pattern 10101010

```
INIT; *WAI
```

Starts the measurement with synchronization.

```
CALC: BTO: MCH: DF2: PERC?
```

Queries the percentage of "in range" measurements.

Characteristics

RST value: -

SCPI: device-specific

Mode

BT

CALCulate<1|2>:BT0oth:MCHar:RATio?

This command determines the ratio of the average frequency deviations for varying bit patterns of the payload.

The numeric suffixes <1|2> are irrelevant for this command.

Note: This command is only available with active Modulation Characteristics measurement (see [CONFigure:BT0oth:MEASurement](#) command). With all other measurements this command will lead to a query error.

Parameter

MINimum | MAXimum | AVERage

Example

For the first steps refer to "[Example: Adapting the settings to the characteristics of the DUT](#)" on page 6.327.

```
CONF: BTO: MEAS MCH
```

Activates the Modulation Characteristics measurement.

```
CONF: BTO: SWE: COUN 20
```

Initiates the sweep counter with 20.

... EUT emits bit pattern 1111000

INIT:IMM;*WAI

Starts the measurement with synchronization and erase previous measurement results.

... EUT emits bit pattern 10101010

INIT:CONM;*WAI

Starts additional measurement with synchronization.

CALC:BT0:MCH:RAT? MIN

Queries the minimum value.

Characteristics

RST value: -

SCPI: device-specific

Mode

BT

CALCulate<1|2>:BT0oth:OPOWER[:PEAK]?

This command reads the peak value of the Output Power measurement according to the BLUETOOTH standard.

The numeric suffixes <1|2> are irrelevant for this command.

Note: This command is only available with active Output Power measurement (see [CONFigure:BT0oth:MEASurement](#) command). With all other measurements it will lead to a query error.

Example

For the first steps refer to "[Example: Adapting the settings to the characteristics of the DUT](#)" on page 6.327.

CONF:BT0:MEAS OPOW

Activates the Output Power measurement.

INIT;*WAI

Starts the measurement with synchronization.

CALC:BT0:OPOW?

Queries the output power result.

Characteristics

RST value: -

SCPI: device-specific

Mode

BT

CALCulate<1|2>:BT0oth:OPOWER:AVERage?

This command reads the average value of the Output Power measurement according to the Bluetooth standard.

With a sweep count value of ≥ 1 ([CONFigure:BT0oth:SWEep:COUNT](#)) and trace mode clear/write ([DISPlay\[:WINDow<1|2>\]:TRACe<1...6>:MODE](#)) the selected number of measurements is performed when a single sweep is started ([INITiate<1|2>\[:IMMediate\]](#)). During these measurements the minimum and maximum values are determined. If only a single measurement is performed, the minimum and maximum value will be identical.

The numeric suffixes <1|2> are irrelevant for this command.

Note: This command is only available with active Output Power measurement (see [CONFigure:BT0oth:MEASurement](#) command). With all other measurements it will lead to a query error.

Parameter

MINimum | MAXimum | AVERage

Example

For the first steps refer to "[Example: Adapting the settings to the characteristics of the DUT](#)" on page 6.327.

```
CONF: BTO: MEAS OPOW
```

Activates the Output Power measurement.

```
CONF: BTO: SWE: COUN 20
```

Activates measurement over 20 sweeps.

```
INIT; *WAI
```

Activates measurement over 20 sweeps.

```
CALC: BTO: OPOW: AVER? MAX
```

Queries the maximum average value of the Output Power measurement.

Characteristics

RST value: -

SCPI: device-specific

Mode

BT

CALCulate<1|2>:BT0oth:PLENght?

This command reads the length of the packet analyzed by the preceding measurement.

The numeric suffixes <1|2> are irrelevant for this command.

Note: This command is only available, if a measurement was started via [INITiate<1|2>\[:IMMEDIATE\]](#) before and if this measurement is completed. With a missing or incomplete measurement the command will cause a query error. This command is only available with the measurements Output Power, Modulation Characteristics, Initial Carrier Frequency Tolerance, and Carrier Frequency Drift (see [CONFigure:BT0oth:MEASurement](#) command).

Example

```
INST: SEL BTO
```

Activates the Bluetooth Measurements option

```
INIT: CONT OFF
```

Selects single sweep operation

```
CONF: BTO: MEAS OPOW
```

Activates the Output Power measurement

```
INIT; *WAI
```

Starts the measurement with synchronization

```
CALC: BTO: PLEN?
```

Queries the packet length

Characteristics

RST value: -

SCPI: device-specific

Mode

BT

CALCulate<1|2>:BT0oth:PTYPe?

This command determines the type of the packet analyzed by a preceding measurement. The numeric suffixes <1|2> are irrelevant for this command.

Note: This command is only available, if a measurement was started via [INITiate<1|2>\[:IMMediate\]](#) before and if this measurement is completed. With a missing or incomplete measurement the command will cause a query error. This command is only available with the measurements Output Power, Modulation Characteristics, Initial Carrier Frequency Tolerance, and Carrier Frequency Drift (see [CONFigure:BT0oth:MEASurement](#) command).

Response

The following packet types are recognized and returns as character data: AUX1, DH1, DH3, DH5, DM1, DM3, DM5, FHS, HV1, HV2, HV3, DV, NULL, POLL, UNDEF

Example

```
INST:SEL BTO
Activates the Bluetooth Measurements option
INIT:CONT OFF
Selects single sweep operation
CONF: BTO:MEAS OPOW
Activates the Output Power measurement
INIT;*WAI
Starts the measurement with synchronization
CALC: BTO: PTYP?
Queries the packet type
```

Characteristics

RST value: -
SCPI: device-specific

Mode

BT

CALCulate<1|2>:BT0oth:RTPower:[DPSK]?

This command reads the average transmission power for the DPSK sections of the packet in the Relative Transmission Power measurement. With a sweep count ≤ 1 , the command returns the current value, irrespective of the parameter.

The numeric suffixes <1|2> are irrelevant for this command.

Note: This command is only available with active Relative Transmit Power measurement (see [CONFigure:BT0oth:MEASurement](#) command). With all other measurements this command will lead to a query error.

Parameter

MINimum | MAXimum | AVERage

Example

For the first steps refer to "[Example: Adapting the settings to the characteristics of the DUT](#)" on page 6.327.

```
CONF: BTO:MEAS RTP
Activates the Relative Transmit Power measurement.
CONF: BTO:SWE:COUN 10
Initiates the sweep counter with 10.
```



```
INIT; *WAI
```

Starts the measurement with synchronization.

```
CALC: BTO: RTP? MIN
```

Reads the lowest recorded average power of the DPSK section of all packets.

Characteristics

RST value: -

SCPI: device-specific

Mode

BT

CALCulate<1|2>:BT0oth:RTPower:GFSK?

This command reads the transmission power for the GFSK sections of the packet in the Relative Transmission Power measurement. With a sweep count ≤ 1 , the command returns the current value, irrespective of the parameter.

The numeric suffixes <1|2> are irrelevant for this command.

Note: This command is only available with active Relative Transmit Power measurement (see [CONFigure:BT0oth:MEASurement](#) command). With all other measurements this command will lead to a query error.

Parameter

MINimum | MAXimum | AVERage

Example

For the first steps refer to "[Example: Adapting the settings to the characteristics of the DUT](#)" on page 6.327.

```
CONF: BTO: MEAS RTP
```

Activates the Relative Transmit Power measurement.

```
CONF: BTO: SWE: COUN 10
```

Initiates the sweep counter with 10.

```
INIT; *WAI
```

Starts the measurement with synchronization.

```
CALC: BTO: RTP: GFSK? MIN
```

Reads the highest recorded average power of the GFSK section of all packets.

Characteristics

RST value: -

SCPI: device-specific

Mode

BT

CALCulate<1|2>:BT0oth:RTPower:RATio?

This command reads the ratio of the transmission power for the GFSK and DPSK modulation in the Relative Transmission Power measurement ($P_{\text{DPSK}}/P_{\text{GFSK}}$). With a sweep count ≤ 1 , the command returns the current value, irrespective of the parameter.

The numeric suffixes <1|2> are irrelevant for this command.

Note: This command is only available with active Relative Transmit Power measurement (see [CONFigure:BT0oth:MEASurement](#) command). With all other measurements this command will lead to a query error.

Parameter

MINimum | MAXimum | AVERage

Example

For the first steps refer to "[Example: Adapting the settings to the characteristics of the DUT](#)" on page 6.327.

```
CONF:BTO:MEAS RTP
```

Activates the Relative Transmit Power measurement.

```
CONF:BTO:SWE:COUN 10
```

Initiates the sweep counter with 10.

```
INIT;*WAI
```

Starts the measurement with synchronization.

```
CALC:BTO:RTP:RAT? MIN
```

Queries the minimum value.

Characteristics

RST value: -

SCPI: device-specific

Mode

BT

CALCulate<1|2>:BT0oth:STATus?

This command queries the status of a preceding measurement.

Results: 0: PASS, 1: FAIL

The numeric suffixes <1|2> are irrelevant for this command.

Note: *This command is only available, if a measurement was started via `INITiate<1|2>[:IMMediate]` before and if this measurement is completed. With a missing or incomplete measurement the command will cause a query error.*

Example

```
INST:SEL BTO
```

Activates the Bluetooth Measurements option

```
INIT:CONT OFF
```

Selects single sweep operation

```
CONF:BTO:MEAS OPOW
```

Activates Output Power measurement

```
INIT;*WAI
```

Starts the measurement with synchronization

```
CALC:BTO:STAT?
```

Queries the status

Characteristics

RST value: -

SCPI: device-specific

Mode

BT

CALCulate:DELTamarker Subsystem (BLUETOOTH, K8)

The CALCulate:DELTamarker subsystem controls the delta marker functions of the instrument.

Commands of the CALCulate:DELTamarker Subsystem

- [CALCulate<1|2>:DELTamarker<1...4>:Y?](#)

CALCulate<1|2>:DELTamarker<1...4>:Y?

Depending on the unit defined with [CALCulate<1|2>:UNIT:POWer](#) or on the activated measuring functions, the query result is output in the units below:

Result display	Output unit
OUTPUT POWER result display	dB
TX SPECTRUM ACP result display	dB
MODULATION CHARACTERISTICS result display	Hz
INITIAL CARR FREQ TOL result display	Hz
CARRIER FREQ DRIFT result display	Hz
RELATIVE TX POWER	dB
IN-BAND SPURIOUS EMISSIONS	dB
CARRIER FREQUENCY STABILITY	-
DIFF PHASE ENCODING	-

For further details refer to "[CALCulate<1|2>:DELTamarker<1...4>:Y?](#)" on page 6.21.

CALCulate:MARKer Subsystem (BLUETOOTH, K8)

The CALCulate:MARKer subsystem checks the marker functions of the instrument.

Commands of the CALCulate:MARKer Subsystem

- [CALCulate<1|2>:MARKer<1...4>:PEXCursion](#)
- [CALCulate<1|2>:MARKer<1...4>:Y?](#)

CALCulate<1|2>:MARKer<1...4>:PEXCursion

The unit depends on the selected operating mode.

Example

```
CALC:MARK:PEXC 100 HZ
Defines peak excursion 100 Hz
```

Characteristics

RST value: 6dB

For further details refer to "[CALCulate<1|2>:MARKer<1...4>:PEXCursion](#)" on page 6.63.

CALCulate<1|2>:MARKer<1...4>:Y?

If the analog demodulator (option Analog Demodulation, R&S FSL-K7) is activated, the query result is output in the following units:

Result display	Output unit
AM	%
FM	Hz
PM	rad/deg (defined with UNIT:ANGLE)
RF	output unit defined with CALCulate<1 2>:UNIT:POWer

For further details refer to "[CALCulate<1|2>:MARKer<1...4>:Y?](#)" on page 6.66.

CONFigure:BT0oth Subsystem (BLUETOOTH, K8)

The following commands are used for configuration of the BLUETOOTH analyzer operating mode.

Commands of the CONFigure:BT0oth Subsystem

- CONFigure:BT0oth:ACLR:ACPairs
- CONFigure:BT0oth:BANDwidth|BWIDth[:RESolution]
- CONFigure:BT0oth:BANDwidth|BWIDth[:RESolution]:AUTO
- CONFigure:BT0oth:BANDwidth|BWIDth:VIDeo
- CONFigure:BT0oth:BANDwidth|BWIDth:VIDeo:AUTO
- CONFigure:BT0oth:CFSTability:BCOunt
- CONFigure:BT0oth:CHANnel
- CONFigure:BT0oth:DETEctor<1...6>[:FUNCTion]
- CONFigure:BT0oth:IBSemiissions:ACPairs
- CONFigure:BT0oth:IBSemiissions:GATE:AUTO
- CONFigure:BT0oth:MEASurement
- CONFigure:BT0oth:PBSCo
- CONFigure:BT0oth:PCLass
- CONFigure:BT0oth:POWER:AVERage:STARt
- CONFigure:BT0oth:POWER:AVERage:STOP
- CONFigure:BT0oth:PRATe
- CONFigure:BT0oth:PTYPE
- CONFigure:BT0oth:RTPower:DAVerage:STARt
- CONFigure:BT0oth:RTPower:DAVerage:STOP
- CONFigure:BT0oth:RTPower:GAVerage:STARt
- CONFigure:BT0oth:RTPower:GAVerage:STOP
- CONFigure:BT0oth:SWEep:COUNT
- CONFigure:BT0oth:SWEep:TIME
- CONFigure:BT0oth:SWEep:TIME:AUTO
- CONFigure:BT0oth:TRACe<1...6>:MODE
- CONFigure:BT0oth:TRACe<1...6>:SELEct

CONFigure:BT0oth:ACLR:ACPairs

This command selects the number of adjacent channel pairs during the Adjacent Channel Power measurement. The number of adjacent channels will be limited as soon as the border of the Bluetooth frequency band is reached.

Note: *This command is only available with active Adjacent Channel Power measurement (see [CONFigure:BT0oth:MEASurement](#) command).*

Parameter

1 to 78

Example

```
CONF:BT0:ACLR:ACP 10
```

Selects 10 adjacent channel pairs.

Characteristics

*RST value: 78
 SCPI: device-specific

Mode

BT

CONFigure:BT0oth:BANDwidth|BWIDth[:RESolution]

This command sets the resolution bandwidth of the analyzer for the currently selected Bluetooth measurement (see [\[SENSE<1|2>:\]BANDwidth|BWIDth\[:RESolution\]](#) command).

For the measurements of modulation characteristics, initial carrier frequency tolerance, and carrier frequency drift ([CONFigure:BT0oth:MEASurement](#)), the resolution bandwidth corresponds to the IF bandwidth of the signal. If the resolution bandwidth is changed, its coupling to the settings according to the RF Test Specification is cancelled.

Note: *The settings for the measurements are valid for all three measurements. For all other Bluetooth measurements the setting is only valid for the currently active measurement (see [CONFigure:BT0oth:MEASurement](#) command). This command is not available with active Adjacent Channel Power measurement.*

Parameter

300kHz to 10MHz

Example

```
INST:SEL BTO
```

Activates the Bluetooth Measurements option.

```
CONF:BT0:MEAS OPOW
```

Activates the Output Power measurement.

```
CONF:BT0:BAND 1KHZ
```

Sets the resolution bandwidth to 1kHz.

Characteristics

*RST value: - (AUTO is set to ON)
 SCPI: device-specific

Mode

BT

CONFigure:BT0oth:BANDwidth|BWIDth[:RESolution]:AUTO

This command couples the resolution bandwidth to the settings according to the RF Test Specification.

Note: *The settings for the measurements of Modulation Characteristics, Initial Carrier Frequency Tolerance, and Carrier Frequency Drift are common to all three measurements.
For all other Bluetooth measurements the setting is only valid for the currently active measurement (see [CONFigure:BT0oth:MEASurement](#) command).*

Parameter

ON | OFF

Example

```
INST:SEL BTO
```

Activates the Bluetooth Measurements option.

```
CONF: BTO: MEAS MCH
```

Activates the Modulation Characteristics measurement.

```
CONF: BTO: BAND: AUTO ON
```

Activates the RBW coupling.

Characteristics

*RST value: ON

SCPI: device-specific

Mode

BT

CONFigure:BT0oth:BANDwidth|BWIDth:VIDeo

This command sets the video bandwidth for the Adjacent Channel Power measurement (see [CONFigure:BT0oth:MEASurement](#) command).

The available filters have a bandwidth range of 1 Hz to 10 MHz. On a change in video bandwidth its link according to the RF Test Specification is switched off.

Note: *This setting is only available for Output Power measurements.*

Parameter

1 Hz to 10 MHz

Example

```
INST:SEL BTO
```

Activates the Bluetooth Measurements option.

```
CONF: BTO: MEAS ACLR
```

Activates the Adjacent Channel Power measurement.

```
CONF: BTO: BAND: VID 100HZ
```

Sets the video bandwidth to 100 Hz.

Characteristics

*RST value: - (AUTO is set to ON)

SCPI: device-specific

Mode

BT

CONFigure:BT0oth:BANDwidth|BWIDth:VIDeo:AUTO

This command links the video bandwidth to the settings according to the RF Test Specification. It is only available for the Adjacent Channel Power measurement (see [CONFigure:BT0oth:MEASurement](#) command).

Note: *This setting is only valid for the currently active measurement (see [CONFigure:BT0oth:MEASurement](#) command) and it is independent of the other Bluetooth measurements.*

Parameter

ON | OFF

Example

INST:SEL BTO

Activates the Bluetooth Measurements option.

CONF:BTO:MEAS ACLR

Activates the Adjacent Channel Power measurement.

CONF:BTO:BAND:VID:AUTO ON

Switches the VBW coupling on.

Characteristics

*RST value: ON

SCPI: device-specific

Mode

BT

CONFigure:BT0oth:CFSTability:BCOunt

This command sets the number of blocks to be measured.

Note: *This command is only available with active Carrier Frequency Stability and Modulation Accuracy measurement (see [CONFigure:BT0oth:MEASurement](#) command).*

Parameter

0 to 1,000,000

Example

CONF:BTO:CFST:BCO 1000

Selects 1000 blocks to be measured.

Characteristics

RST value: 200

SCPI: device-specific

Mode

BT

CONFigure:BT0oth:CHANnel

This command selects the frequency channel for the measurements according to the Bluetooth standard.

Parameter

0 to 78

Example

CONF: BTO: CHAN 20
 Selects channel 20

Characteristics

*RST value: 0
 SCPI: device-specific

Mode

BT

CONFigure:BT0oth:DETECTOR<1...6>[:FUNCTION]

This command selects the detector for the currently selected Bluetooth measurement. The numeric suffix assigns the detector to a trace (1 to 6).

Note: *The RMS detector is not available for the measurements Modulation Characteristics, Initial Carrier Frequency Tolerance, and Carrier Frequency Drift (see [CONFigure:BT0oth:MEASUREMENT](#) command). The setting is valid for the currently selected measurement (see [CONFigure:BT0oth:MEASUREMENT](#) command) and independent of other Bluetooth measurements.*

Parameter

APEak | NEGative | POSitive | SAMPlE | RMS | AVERAge

Example

INST: SEL BTO
 Activates the Bluetooth Measurements option.
 CONF: BTO: MEAS OPOW
 Activates the Output Power measurement.
 CONF: BTO: DET2 RMS
 Sets the detector for trace 2 to RMS.

Characteristics

*RST value:

PEAK	Output Power
AVER	Adjacent Channel Power EDR Rel TX Power EDR In-band Spurious Emissions
APEAK	Modulation Characteristics Initial Carrier Frequency Tolerance Carrier Frequency Drift EDR Differential Phase Encoding EDR Carrier Frequency Stability and Modulation Accuracy

SCPI: device-specific

Mode

BT

CONFigure:BT0oth:IBSemiissions:ACPairs

This command selects the number of adjacent channel pairs during the In-band Spurious Emissions measurement. The number of adjacent channels will be limited as soon as the border of the Bluetooth frequency band is reached.

Note: *This command is only available with active In-band Spurious Emissions measurement (see CONFigure:BT0oth:MEASurement command).*

Parameter

1 to 78

Example

CONF: BTO: IBS: ACP 20
 Selects 20 adjacent channel pairs.

Characteristics

*RST value: 78
 SCPI: device-specific

Mode

BT

CONFigure:BT0oth:IBSemiissions:GATE:AUTO

This command adjusts the gate settings for the In-band Spurious Emissions automatically.

Note: *This command is only available with active In-band Spurious Emissions measurement (see CONFigure:BT0oth:MEASurement command).*

Parameter

ONCE

Example

CONF: BTO: IBS: GATE: AUTO ONCE
 Adjusts the gate automatically once.

Characteristics

RST value: ONCE
 SCPI: device-specific

Mode

BT

CONFigure:BT0oth:MEASurement

This command selects the current measurement according to the Bluetooth standard.

Parameter

OPOWer	Output Power measurement
ACLR	Adjacent Channel Power measurement
MCHar	Modulation Characteristics measurement
ICFTolerance	Initial Carrier Frequency Tolerance measurement
CFDRift	Carrier Frequency Drift measurement
RTPower	Relative Transmit Power (EDR) measurement

IBSEmissions	Spurious Emissions (EDR) measurement
DPENcoding	Differential Phase Encoding (EDR) measurement
CFSTability	Carrier Frequency Stability and Modulation Accuracy (EDR) measurement

Example

```
CONF: BTO: MEAS ACLR
```

Selects the measurement of the adjacent channel power.

Characteristics

*RST value: OPOWer

SCPI: device-specific

Mode

BT

CONFigure:BT0oth:PBSCo

This command selects the number of payload bytes that are transmitted in a packet.

Parameter

1 - 1000

Example

```
CONF: BTO: PBSC 50
```

Selects the number of payload bytes.

Characteristics

RST value: 1

SCPI: device-specific

Mode

BT

CONFigure:BT0oth:PCLass

This command selects the power class for the Output Power measurement. The power class defines the limits for the output power measurement.

Parameter

1 to 3

Example

```
CONF: BTO: PCL 3
```

Selects power class 3

Characteristics

*RST value: 1

SCPI: device-specific

Mode

BT

CONFigure:BT0oth:POWer:AVERage:STARt

This command defines the start position for the calculation of the average power of a burst.

Note: Depending on the setting FIND SYNC ON or OFF ([SENSE<1|2>:]DDEMod:SEARCH:SYNC[:STATe] command) the burst is either defined by the p0 bit and the packet length or the 3 dB points according to the RF Test Specification. As a result there are different areas within the burst for calculating the average power:

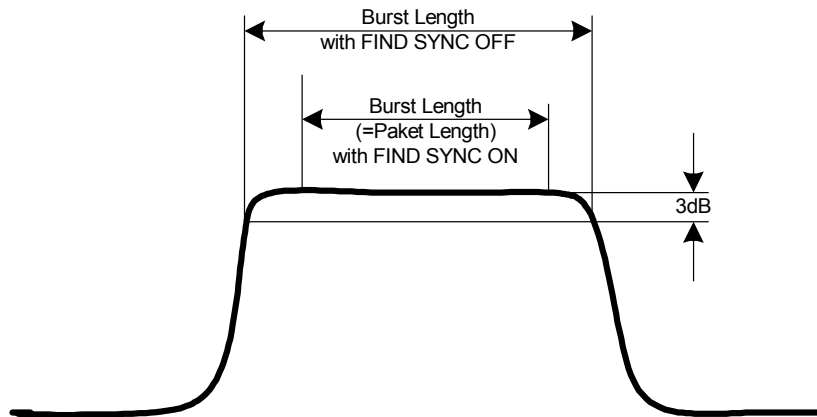

Parameter
0 to 100PCT

Example
CONF:BT0:POW:AVER:STAR 10PCT
Sets the starting point for the calculation to 10% of the burst length.

Characteristics
*RST value: 20%
SCPI: device-specific

Mode
BT

CONFigure:BT0oth:POWer:AVERage:STOP

This command defines the end position for the calculation of the average power of a burst.

Note: Depending on the setting FIND SYNC ON or OFF ([SENSE<1|2>:]DDEMod:SEARCH:SYNC[:STATe] command) the burst is either defined by the p0 bit and the packet length or the 3 dB points according to the RF Test Specification. As a result there are different areas within the burst for calculating the average power (see CONFigure:BT0oth:POWer:AVERage:STARt command).

Parameter
0 to 100PCT

Example
CONF:BT0:POW:AVER:STAR 90PCT
Sets the end point for the calculation to 90% of the burst length.

Characteristics
*RST value: 80%
SCPI: device-specific

ModeBT

CONFigure:BT0oth:PRATe

This command selects the number of measurement samples (points) per symbol for the measurement. This command is not available for EDR measurements. For EDR measurements, this parameter is set to 4 points/symbol and cannot be changed.

Note: *The RF Test Specification specifies an oversampling factor of at least 4.*

Parameter

2 | 4 | 8 | 16 | 32

Example

```
CONF:BT0:PRAT 16
```

Selects 16 points/symbol.

Characteristics

*RST value: 4

SCPI: device-specific

ModeBT

CONFigure:BT0oth:PTYPe

This command selects the packet type to be measured.

Parameter

DH1 1 slot packet

DH3 3 slot packet

DH5 5 slot packet

AUTO automatic selection of the packet type

Example

```
CONF:BT0:PTYP DH5
```

Selects type "5 slot packet".

Characteristics

*RST value: DH1

SCPI: device-specific

ModeBT

CONFigure:BT0oth:RTPower:DAverage:START

This command sets the start time for the power measurement of the DPSK sections of the packet.

Note: *This command is only available with active Relative Transmit Power measurement (see [CONFigure:BT0oth:MEASurement](#) command).*

Parameter

0 to 100%

Example`CONF: BTO: RTP: DAV: STAR 20`

Sets the start time for the power measurement of the DPSK sections of the packet.

Characteristics

RST value: 10%

SCPI: device-specific

ModeBT

CONFigure:BT0oth:RTPower:DAverage:STOP

This command sets the stop time for the power measurement of the DPSK sections of the packet.

Note: *This command is only available with active Relative Transmit Power measurement (see [CONFigure:BT0oth:MEASurement](#) command).*

Parameter

0 to 100%

Example`CONF: BTO: RTP: DAV: STOP 80`

Sets the stop time for the power measurement of the DPSK sections of the packet.

Characteristics

RST value: 90%

SCPI: device-specific

ModeBT

CONFigure:BT0oth:RTPower:GAverage:START

This command sets the start time for the power measurement of the GFSK sections of the packet.

Note: *This command is only available with active Relative Transmit Power measurement (see [CONFigure:BT0oth:MEASurement](#) command).*

Parameter

0 to 100%

Example`CONF: BTO: RTP: GAV: STAR 20`

Sets the start time for the power measurement of the GFSK sections of the packet.

Characteristics

RST value: 10%

SCPI: device-specific

ModeBT

CONFigure:BT0oth:RTPower:GAverage:STOP

This command sets the stop time for the power measurement of the GFSK sections of the packet.

Note: This command is only available with active Relative Transmit Power measurement (see [CONFigure:BT0oth:MEASurement](#) command).

Parameter

0 to 100%

Example

```
CONF: BTO: RTP: GAV: STOP 80
```

Sets the stop time for the power measurement of the GFSK sections of the packet.

Characteristics

RST value: 90%

SCPI: device-specific

Mode

BT

CONFigure:BT0oth:SWEep:COUNT

This command defines the number of sweeps for the currently selected Bluetooth measurement. This number will be started as a "single sweep". With trace mode setting clear/write ([CONFigure:BT0oth:TRACe<1..6>:MODE](#)) the measurement results will be calculated for each sweep and taken into account for the calculation of minimum, maximum and average values. For the remaining trace settings (AVER, MAXH, MINH) the measurement results will be calculated from the resulting trace. In average mode the value 0 defines the sliding average of the measurement data over 10 sweeps.

Note: The setting is valid only for the currently active measurement (see [CONFigure:BT0oth:MEASurement](#) command) and independent of the other Bluetooth measurements.

Parameter

0 to 32767

Example

```
INST: SEL BTO
```

Activates the Bluetooth Measurements option.

```
CONF: BTO: MEAS OPOW
```

Activates the Output Power measurement.

```
INIT: CONT OFF
```

Selects single sweep operation.

```
CONF: BTO: SWE: COUN 20
```

Sets the number of sweeps to 20.

```
INIT; *OPC
```

Starts a sweep with synchronization.

Characteristics

*RST value:

- | | |
|----|---|
| 0 | Output Power |
| 10 | Adjacent Channel Power
Modulation Characteristics
Initial Carrier Frequency Tolerance |

Carrier Frequency Drift
 EDR Relative TX Power
 EDR In-band Spurious Emissions
 100 Differential Phase Encoding

Mode
 BT

CONFigure:BT0oth:SWEep:TIME

This command defines the duration of a sweep sequence for the active Bluetooth measurement.

Parameter

<numeric_value>

(1us to 130560us) / (points per symbol)	Output Power Modulation Characteristics Initial Carrier Frequency Tolerance Carrier Frequency Drift EDR Relative TX Power EDR Differential Phase Encoding EDR Carrier Frequency Stability and Modulation Accuracy
10µs ... 16000s	Adjacent Channel Power

Direct programming using the `[SENSe<1|2>:]SWEep:TIME` command will cancel the coupling to the settings according to the RF Test Specification.

Note: *The setting is valid only for the currently active measurement (see [CONFigure:BT0oth:MEASurement](#) command) and independent of the other Bluetooth measurements.*

Example

```
INST:SEL BTO
Activates the Bluetooth Measurements option.
CONF:BTO:MEAS OPOW
Activates the Output Power measurement.
CONF:BTO:SWE:TIME 10MS
Sets a sweep time of 10 ms.
```

Characteristics

*RST value: - (AUTO is set to ON)
 SCPI: device-specific

Mode
 BT

CONFigure:BT0oth:SWEep:TIME:AUTO

This command couples the sweep time to the settings according to the RF Test Specification.

Note: *The setting is valid only for the currently active measurement (see [CONFigure:BT0oth:MEASurement](#) command) and independent of the other Bluetooth measurements.*

Parameter

ON | OFF

Example

INST:SEL BTO

Activates the Bluetooth Measurements option.

CONF:BTO:MEAS OPOW

Activates the Output Power measurement.

CONF:BTO:SWE:TIME:AUTO ON

Switches the sweep time coupling on.

Characteristics

*RST value: ON

SCPI: device-specific

Mode

BT

CONFigure:BT0oth:TRACe<1...6>:MODE

This command defines the way of displaying and evaluating the measurement curves for the selected Bluetooth measurement. WRITE corresponds to manual operating mode Clr/Write.

The numeric suffix selects the trace related to this setting.

The number of measurement to be executed for AVERage, MAXHold and MINHold is defined with the [CONFigure:BT0oth:SWEep:COUNT](#) command. Please note that a synchronization to the end of the indicated number of measurements is only possible during single sweep operation.

Note: *The setting is valid only for the currently active measurement (see [CONFigure:BT0oth:MEASurement](#) command) and independent of the other Bluetooth measurements.*

Parameter

WRITE | VIEW | AVERage | MAXHold | MINHold | BLANK

Example

INST:SEL BTO

Activates the Bluetooth Measurements option.

CONF:BTO:MEAS OPOW

Activates the Output Power measurement.

INIT:CONT OFF

Selects single sweep operation.

CONF:BTO:SWE:COUN 10

Sets the sweep count to 10.

CONF:BTO:TRAC2:MODE AVER

Switches averaging for trace 2 on.

INIT;*OPC

Starts a measurement with synchronization.

Characteristics

*RST value: WRITE

SCPI: device-specific

Mode

BT

CONFigure:BT0oth:TRACe<1...6>:SElect

This command selects the measurement curve for evaluation of the modulation characteristics.

Example

INST:SEL BTO

Activates the Bluetooth Measurements option.

CONF:BTO:MEAS ACLR

Activates the Adjacent Channel Power measurement.

INIT:CONT OFF

Selects single sweep operation.

CONF:BTO:TRAC2:SEL

Selects trace 2 for measurement result queries.

Characteristics

*RST value: -

SCPI: device-specific

Mode

BT

DISPlay Subsystem (BLUETOOTH, K8)

The DISPlay subsystem controls the selection and presentation of textual and graphic information as well as of measurement data on the display.

Commands of the DISPlay Subsystem

- [DISPlay\[:WINDow<1|2>\]:TRACe<1...6>:Y\[:SCALe\]:PDIVision](#)
- [DISPlay\[:WINDow<1|2>\]:TRACe<1...6>:Y\[:SCALe\]:RPOSition](#)
- [DISPlay\[:WINDow<1|2>\]:TRACe<1...6>:Y\[:SCALe\]:RVALue](#)

DISPlay[:WINDow<1|2>]:TRACe<1...6>:Y[:SCALe]:PDIVision

This command defines the scaling of the y-axis in the currently selected unit. The numeric suffix in TRACe<1...6> is irrelevant.

Parameter

<numeric_value>

Example

```
DISP:TRAC:Y:PDIV 10kHz
Sets the Y scale to 10 kHz/div.
```

Characteristics

*RST value: -
SCPI: conform

Mode

BT

DISPlay[:WINDow<1|2>]:TRACe<1...6>:Y[:SCALe]:RPOSition

This command defines the position of the reference value. In **Bluetooth** mode, the selected reference position is valid for all measurements.

Characteristics

*RST value: 50 PCT

For further details refer to "[DISPlay\[:WINDow<1|2>\]:TRACe<1...6>:Y\[:SCALe\]:RPOSition \(models with tracking generator\)](#)" on page 6.133.

DISPlay[:WINDow<1|2>]:TRACe<1...6>:Y[:SCALe]:RVALue

This command defines the result value assigned to the reference position on the graticule.

Example

```
DISP:TRAC:Y:RVAL 0
Sets the value assigned to the reference position to 0 Hz
```

Characteristics

*RST value: 0 Hz

For further details refer to "[DISPlay\[:WINDow<1|2>\]:TRACe<1...6>:Y\[:SCALe\]:RPOSition \(models with tracking generator\)](#)" on page 6.133.

INSTRument Subsystem (BLUETOOTH, K8)

The INSTRument subsystem selects the operating mode of the unit either via text parameters or fixed numbers.

Commands of the INSTRument Subsystem

- [INSTRument\[:SElect\]](#)
- [INSTRument:NSElect](#)

INSTRument[:SElect]

Parameter

BT00h Bluetooth mode (option Bluetooth Measurements, R&S FSL-K8)

For details refer to the INSTRument subsystem of the base unit.

INSTRument:NSElect

Parameter

<numeric value>

12 Bluetooth mode (option Bluetooth Measurements, R&S FSL-K8)

For details refer to the INSTRument subsystem of the base unit .

SENSe Subsystem (BLUETOOTH, K8)

The SENSe subsystem controls the essential parameters of the Bluetooth Measurements option. In accordance with the SCPI standard, the keyword "SENSe" is optional for this reason, which means that it is not necessary to include the SENSe node in command sequences.

The following subsystem is included:

- "SENSe:ADEMod Subsystem (BLUETOOTH, K8)" on page 6.364
- "SENSe:DDEMod Subsystem (BLUETOOTH, K8)" on page 6.366

[SENSe<1|2>:]CORRection:EGAIN:INPut[:MAGNitude]

This command makes an external gain known to the analyzer, which will take it into account during the display of measurement results. With this function the gain of an antenna or of an external preamplifier can be taken into account for the measurement values.

The numeric suffixes <1|2> are irrelevant for this command.

Parameter

-200 to +200 dB

Example

```
CORR:EGA:INP 10DB
```

Takes 10 dB external gain into account

Characteristics

*RST value: 0 dB

SCPI: device-specific

Mode

BT

SENSe:ADEMod Subsystem (BLUETOOTH, K8)

The SENSe:ADEMod Subsystem contains commands to set up the instrument for the measurement of analog demodulated signals.

Commands of the SENSe:ADEMod Subsystem

- [SENSe:]ADEMod:ZOOM[:STATe]
- [SENSe:]ADEMod:ZOOM:STARt

[SENSe:]ADEMod:ZOOM[:STATe]

The command enables or disables the zoom function. Depending on the selected measurement time and the demodulation bandwidth, the number of recorded measurement points may be greater than that shown on the display.

If the zoom function is enabled, 501 test points of the result memory are displayed from the start time specified by the [SENSe:]ADEMod:ZOOM:STARt command.

If the zoom function is disabled, data reduction is used to adapt the measurement points to the number of points available on the display.

Note: The zoom function is only available for the Output Power, Modulation Characteristics, Initial Carrier Frequency Tolerance, and Carrier Frequency Drift measurements.

Parameter

ON | OFF

Example

ADEM:ZOOM ON

Switches on the zoom function

Characteristics

*RST value: OFF

SCPI: device-specific

Mode

BT

[SENSe:]ADEMod:ZOOM:STARt

The command sets the start time for the display of individual measured values.

The zoom function is enabled or disabled by the [SENSe:]ADEMod:ZOOM[:STATe] command.

Note: The zoom function is only available for the Output Power, Modulation Characteristics, Initial Carrier Frequency Tolerance, and Carrier Frequency Drift measurements.

Parameter

0 s to (meas time - 500 / sampling rate)

Example

ADEM:ZOOM ON

Switches on the zoom function

ADEM:ZOOM:STAR 500us

Sets the starting point of the display to 500 μs.

Characteristics

*RST value: 0 s

SCPI: device-specific

Mode

BT

SENSe:DDEMod Subsystem (BLUETOOTH, K8)

This subsystem controls the parameters for digital demodulators.

Commands of the SENSe:DDEMod Subsystem

- [SENSe<1|2>:]DDEMod:FILTer:MEASurement
- [SENSe<1|2>:]DDEMod:SEARch:PULSe[:STATe]
- [SENSe<1|2>:]DDEMod:SEARch:PULSe:OFFSet
- [SENSe<1|2>:]DDEMod:SEARch:SYNC[:STATe]
- [SENSe<1|2>:]DDEMod:SEARch:SYNC:LAP
- [SENSe<1|2>:]DDEMod:SEARch:SYNC:OFFSet
- [SENSe<1|2>:]DDEMod:SEARch:TIME
- [SENSe<1|2>:]DDEMod:SEARch:TIME:AUTO

[SENSe<1|2>:]DDEMod:FILTer:MEASurement

This command selects the receive filter for the signal to measure.

The numeric suffixes <1|2> are irrelevant for this command.

Note: This command is only available with active Modulation Characteristics, Initial Carrier Frequency Tolerance, and Carrier Frequency Drift measurement (see [CONFigure:BT0oth:MEASurement](#) command). With all other measurements it will lead to a query error.

Parameter

OFF | BT0oth

Example

```
DDEM:FILT:MEAS BTO
```

Activates the Bluetooth measurement filter.

Characteristics

*RST value: ON

SCPI: device-specific

Mode

BT

[SENSe<1|2>:]DDEMod:SEARch:PULSe[:STATe]

This command switches the search for a signal burst on or off.

The numeric suffixes <1|2> are irrelevant for this command.

Parameter

ON | OFF

Example

```
DDEM:SEAR:PULS OFF
```

Characteristics

*RST value: ON

SCPI: device-specific

Mode

BT

[SENSe<1|2>:]DDEMod:SEARch:PULSe:OFFSet

This command defines the time to be recorded before a signal burst is recognized. The valid value range is 0 to ± 10 ms.

The numeric suffixes <1|2> are irrelevant for this command.

Parameter

0 to 10 ms

Example

```
DDEM:SEAR:PULS:OFFS 1MS
```

Sets the burst offset to 1ms before the start of the burst.

Characteristics

*RST value: 0

SCPI: device-specific

Mode

BT

[SENSe<1|2>:]DDEMod:SEARch:SYNC[:STATe]

This command switches the search for a sync pattern on or off.

The numeric suffixes <1|2> are irrelevant for this command.

Parameter

ON | OFF

Example

```
DDEM:SEAR:SYNC ON
```

Switches the sync pattern search on.

Characteristics

*RST value: OFF

SCPI: device-specific

Mode

BT

[SENSe<1|2>:]DDEMod:SEARch:SYNC:LAP

This command determines the 24 least significant bits (LAP) of the DUT 'Bluetooth device address'. They are used to define the synchronization pattern to determine the start of a packet. The value range is 0 to FFFFFFF hex.

The numeric suffixes <1|2> are irrelevant for this command.

Parameter

<hex>

Example

```
DDEM:SEAR:SYNC:LAP #HA3F45B
```

Sets on LAP A3F45B Hex

Characteristics

*RST value: #H0

SCPI: device-specific

Mode

BT

[SENSe<1|2>:]DDEMod:SEARch:SYNC:OFFSet

This command defines the number of bits to be recorded before the first preamble bit is detected. The valid value range is 0 to ± 10000 .

The numeric suffixes <1|2> are irrelevant for this command.

Parameter

0 to 10,000

Example

DDEM:SEAR:SYNC:OFFS 10

Sets the sync offset to 10 bits before the preamble bits.

Characteristics

*RST value: 0

SCPI: device-specific

Mode

BT

[SENSe<1|2>:]DDEMod:SEARch:TIME

This command selects manual setting of the record length and defines the record length to be used for the search of sync word and burst. The input of the record length is expected in seconds.

The numeric suffixes <1|2> are irrelevant for this command.

Note: For information on the correlation of trigger and record length refer to the [\[SENSe<1|2>:\]DDEMod:SEARch:TIME:AUTO](#) command.

Parameter100 μ s to 130560 μ s / (points per symbol)

Points per Symbol	Maximum record length
2	104.4 slots
4	52.2 slots
8	26.1 slots
16	13.1 slots
32	6.5 slots

Example

DDEM:SEAR:TIME 100US

Sets the record length for sync word and burst search to 100 μ s.**Characteristics***RST value: 1875 μ s

SCPI: device-specific

ModeBT

[SENSe<1|2>:]DDEMod:SEARch:TIME:AUTO

This command activates the automatic setting of the record length for the sync word and burst search, depending on the selected packet type.

The automatic record length is determined as follows:

Trigger free run:

$$\text{search length} = 3 * \text{packet length} + | \text{sync offset or burst offset} |$$

All other trigger modes:

$$\text{search length} = 1 * \text{packet length} + 1 \text{ Slot} + | \text{sync offset or burst offset} |$$

If the selected measurement time is higher than the packet length, the following difference is added to the search length:

$$\text{measurement time} - \text{packet length}$$

The numeric suffixes <1|2> are irrelevant for this command.

Parameter

ON | OFF

Example

```
DDEMod:SEAR:TIME:AUTO OFF
```

Selects manual input for the record length

Characteristics

*RST value: ON

SCPI: device-specific

ModeBT

Remote Commands of the Power Meter Option (K9)

In this section all remote control commands for Power Meter option are described in detail. The abbreviation For details on conventions used in this chapter refer to section "[Notation](#)" on page 6.2 at the beginning of this chapter.

For further information on analyzer or basic settings commands, refer to the corresponding subsystem in "[Remote Commands of the Base Unit](#)" on page 6.5.

Subsystems of the Power Meter option (K9)

- "[CALCulate Subsystem \(Power Meter, K9\)](#)" on page 6.371
- "[CALibration Subsystem \(Power Meter, K9\)](#)" on page 6.374
- "[FETCh Subsystem \(Power Meter, K9\)](#)" on page 6.376
- "[READ Subsystem \(Power Meter, K9\)](#)" on page 6.377
- "[SENSe Subsystem \(Power Meter, K9\)](#)" on page 6.378
- "[UNIT Subsystem \(Power Meter, K9\)](#)" on page 6.383

CALCulate Subsystem (Power Meter, K9)

The CALCulate subsystem contains commands for converting instrument data, transforming and carrying out corrections. These functions are carried out subsequent to data acquisition, i.e. following the SENSE subsystem.

The following subsystems are included:

- ["CALCulate:PMETER Subsystem"](#) on page 6.372

CALCulate:PMETer Subsystem (Power Meter, K9)

This subsystem controls the instrument settings for power sensor measurements.

Commands of the CALCulate:PMETer Subsystem

- CALCulate<1|2>:PMETer:RELative[:MAGNitude]
- CALCulate<1|2>:PMETer:RELative[:MAGNitude]:AUTO
- CALCulate<1|2>:PMETer:RELative:STATe

CALCulate<1|2>:PMETer:RELative[:MAGNitude]

This command sets the reference value for relative measurements.
The numeric suffixes <1|2> are irrelevant.

Parameter

-200 to 200

Example

```
CALC:PMET:REL -30
```

Sets the reference value for relative measurements to -30 dBm.

Characteristics

*RST value: 0

SCPI: device-specific

Mode

PSM

CALCulate<1|2>:PMETer:RELative[:MAGNitude]:AUTO

This command takes the current measurement value as reference value for relative measurements.

The numeric suffixes <1|2> are irrelevant.

Parameter

ONCE

Example

```
CALC:PMET:REL:AUTO ONCE
```

Takes the current measurement value as reference value for relative measurements.

Characteristics

*RST value: -

SCPI: device-specific

Mode

PSM

CALCulate<1|2>:PMETer:RELative:STATe

This command switches between relative and absolute display of the measured power.
The numeric suffixes <1|2> are irrelevant.

Parameter

ON | OFF

Example

```
CALC:PMET:REL:STAT ON
```

Activates the relative display of the measured value.

Characteristics

*RST value: OFF

SCPI: device-specific

Mode

PSM

CALibration Subsystem (Power Meter, K9)

The CALibration subsystem determines the data for system error correction in the instrument.

The following subsystem is included:

- ["CALibration:PMETer Subsystem \(Power Meter, K9\)"](#) on page 6.374

CALibration:PMETer Subsystem (Power Meter, K9)

The CALibration:PMETer Subsystem determines the error correction data for measurements in the power meter mode.

Commands of the CALibration:PMETer Subsystem

- [CALibration:PMETer:ZERO:AUTO](#)

CALibration:PMETer:ZERO:AUTO

This command starts zeroing of the power sensor.

Parameter

ONCE

Example

```
:CAL:PMET:ZERO:AUTO ONCE;*WAI
```

Starts zeroing and delays the execution of further commands until zeroing is concluded.

Characteristics

*RST value: -

SCPI: device-specific

Mode

PSM

FETCh Subsystem (Power Meter, K9)

The FETCh subsystem contains commands for reading out results of complex measurement tasks.

The following subsystem is included:

- ["FETCh:PMETer Subsystem"](#) on page 6.376

FETCh:PMETer Subsystem (Power Meter, K9)

The FETCh:PMETer subsystem contains commands to read measurement results of power sensor measurements without starting the measurement itself.

Commands of the FETCh:PMETer Subsystem

- [FETCh<1|2>:PMETer?](#)

FETCh<1|2>:PMETer?

This command reads the result of the power sensor measurement.

If no measurement has been performed, this command will lead to a query error. This command is a query and therefore has no *RST value.

Example

```
FETC : PMET?
```

Reads the result of the power sensor measurement.

Characteristics

*RST value: -

SCPI: device-specific

Mode

PSM

READ Subsystem (Power Meter, K9)

The READ subsystem contains commands for starting complex measurement tasks, and for querying the results subsequently.

The following subsystem is included:

- ["READ:PMETer Subsystem"](#) on page 6.377

READ:PMETer Subsystem

This subsystem contains commands to start power sensor measurements and to read the results after the measurement is concluded.

Commands of the READ:PMETer Subsystem

- [READ<1|2>:PMETer?](#)

READ<1|2>:PMETer?

This command starts a power sensor measurement and reads the result after the measurement is concluded.

This command is a query and therefore has no *RST value.

Example

```
READ:PMET?
```

Starts a measurement and read the result.

Characteristics

*RST value: -

SCPI: device-specific

Mode

PSM

SENSe Subsystem (Power Meter, K9)

The SENSe subsystem is organized in several subsystems. The commands of these subsystems directly control device-specific settings, they do not refer to the signal characteristics of the measurement signal.

The SENSe subsystem controls the essential parameters of the analyzer. In accordance with the SCPI standard, the keyword "SENSe" is optional for this reason, which means that it is not necessary to include the SENSe node in command sequences.

The following subsystems are included:

- "[SENSe:PMETer Subsystem](#)" on page 6.378

SENSe:PMETer Subsystem (Power Meter, K9)

This subsystem controls the device settings for power sensor measurements.

Commands of the SENSe:PMETer Subsystem

- [\[SENSe<1|2>:\]PMETer\[:STATe\]](#)
- [\[SENSe<1|2>:\]PMETer:FREQuency](#)
- [\[SENSe<1|2>:\]PMETer:FREQuency:LINK](#)
- [\[SENSe<1|2>:\]PMETer:MTIME](#)
- [\[SENSe<1|2>:\]PMETer:MTIME:AVERAge\[:STATe\]](#)
- [\[SENSe<1|2>:\]PMETer:MTIME:AVERAge:COUNT](#)
- [\[SENSe<1|2>:\]PMETer:ROFFset\[:STATe\]](#)
- [\[SENSe<1|2>:\]PMETer:TRIGger\[:STATe\]](#)
- [\[SENSe<1|2>:\]PMETer:TRIGger:LEVel](#)

[\[SENSe<1|2>:\]PMETer\[:STATe\]](#)

This command switches the power sensor measurements on or off.

The numeric suffixes <1|2> are irrelevant.

Parameter

ON | OFF

Example

```
PMET ON
```

Switches the power sensor measurements on.

Characteristics

*RST value: OFF

SCPI: device-specific

Mode

PSM

[SENSe<1|2>:]PMETer:FREQuency

This command sets the frequency of the power sensor. The limits f_{\min} and f_{\max} are defined by the power sensor.

The numeric suffixes <1|2> are irrelevant.

Parameter

f_{\min} ... f_{\max}

Example

```
PMET:FREQ 1GHZ
```

Sets the frequency of the power sensor to 1 GHz.

Characteristics

*RST value: 50 MHz

SCPI: device-specific

Mode

PSM

[SENSe<1|2>:]PMETer:FREQuency:LINK

This command sets the frequency coupling of the power sensor.

The numeric suffixes <1|2> are irrelevant.

Parameter

CENTER	couples the frequency to the center frequency of the analyzer
MARKer1	couples the frequency to the position of marker 1
OFF	switches the frequency coupling off

Example

```
PMET:FREQ:LINK CENT
```

Couples the frequency to the center frequency of the analyzer

Characteristics

*RST value: CENT

SCPI: device-specific

Mode

PSM

[SENSe<1|2>:]PMETer:MTIME

This command sets the measurement duration of the power sensor.

The numeric suffixes <1|2> are irrelevant.

Parameter

SHORT | NORMAl | LONG

Example

```
PMET:MTIM SHOR
```

Sets a short measurement duration for measurements of stationary high power signals.

Characteristics

*RST value: NORM
 SCPI: device-specific

Mode

PSM

[SENSe<1|2>:]PMETer:MTIMe:AVERage[:STATe]

This command activates or deactivates manual averaging. The average count is set with the [\[SENSe<1|2>:\]PMETer:MTIMe:AVERage:COUNT](#) command.

This command is available from firmware version 1.70.

Parameter

ON | OFF

Example

```
PMET:MTIM:AVER ON
Activates manual averaging.
```

Characteristics

RST value: OFF
 SCPI: device-specific

Mode

PSM

[SENSe<1|2>:]PMETer:MTIMe:AVERage:COUNT

This command defines the number of readings (averagings) to be performed after a single sweep has been started. This command is only available if the

[\[SENSe<1|2>:\]PMETer:MTIMe:AVERage\[:STATe\]](#) command is set to ON.

Results become more stable with extended average, particularly if signals with low power are measured. This setting can be used to minimize the influence of noise in the power meter measurement.

This command is available from firmware version 1.70.

Parameter

0 to 256 in binary steps (1, 2, 4, 8,...)
 For average count = 0 or 1, one reading is performed.

Example

```
PMET:MTIM:AVER ON
Activates manual averaging.
PMET:MTIM:AVER:COUN 8
Sets the number of readings to 8.
```

Characteristics

RST value:
 SCPI: device-specific

Mode

PSM

[SENSe<1|2>:PMETer:ROFFset[:STATe]

This command defines whether the reference level offset set for the analyzer is taken into account for the measured power or not.

The numeric suffixes <1|2> are irrelevant.

This command is available from firmware version 1.50.

Parameter

- ON Adds the offset defined by the `DISPlay[:WINDow<1|2>]:TRACe<1...6>:Y[:SCALE]:RLEVEL:OFFSet` command to the measured level.
- OFF Takes no offset into account.

Example

```
PMET:ROFF OFF
```

Takes no offset into account for the measured power.

Characteristics

*RST value: ON

SCPI: device-specific

Mode

PSM

[SENSe<1|2>:PMETer:TRIGger[:STATe]

This command switches the external power trigger on or off.

The numeric suffixes <1|2> are irrelevant.

This command is only available in conjunction with a NRP-Z81 power sensor.

This command is available from firmware version 1.90.

Parameter

ON | OFF

Example

```
PMET:TRIG ON
```

Switches the external power trigger on.

Characteristics

*RST value: OFF

SCPI: device-specific

Mode

PSM

[SENSe<1|2>:PMETer:TRIGger:LEVEL

This command sets the power level of the external power trigger.

The numeric suffixes <1|2> are irrelevant.

This command is only available in conjunction with a NRP-Z81 power sensor.

This command is available from firmware version 1.90.

Parameter

-20 bis + 20 dBm

Example

PMET:TRIG:LEV -10 dBm
Sets the level of the trigger.

Characteristics

*RST value: -20dBm
SCPI: device-specific

Mode

PSM

UNIT Subsystem (Power Meter, K9)

The UNIT subsystem sets the basic unit of the setting parameters.

The following subsystems are included:

- ["UNIT:PMETer Subsystem \(Power Meter, K9\)"](#) on page 6.383

UNIT:PMETer Subsystem (Power Meter, K9)

The UNIT:PMETer subsystem sets the basic unit for power sensor measurement.

Commands of the UNIT:PMETer Subsystem

- [UNIT<1|2>:PMETer:POWer](#)
- [UNIT<1|2>:PMETer:POWer:RATio](#)

UNIT<1|2>:PMETer:POWer

This command selects the unit for absolute power sensor measurement.

Parameter

DBM | WATT | W

Example

```
UNIT:PMET:POW DBM
```

Characteristics

*RST value: DBM

SCPI: conform

Mode

PSM

UNIT<1|2>:PMETer:POWer:RATio

This command selects the unit for relative power sensor measurement.

Parameter

DB | PCT

Example

```
UNIT:PMET:POW DB
```

Characteristics

*RST value: DB

SCPI: conform

Mode

PSM

Remote Commands of the Spectrogram Measurement Option (K14)

This section describes the remote commands for the Spectrogram Measurement option (K14). The abbreviation SPECM stands for the Spectrogram measurement mode. For details on conventions used in this chapter refer to section ["Notation"](#) on page 6.2 at the beginning of this chapter.

For further information on analyzer or basic settings commands, refer to the corresponding subsystem in ["Remote Commands of the Base Unit"](#) on page 6.5.

This option is available from firmware version 1.60.

Subsystems of the Spectrogram Measurement option (K14)

- ["CALCulate Subsystem \(SPECM, K14\)"](#) on page 6.385
- ["INITiate Subsystem \(SPECM, K14\)"](#) on page 6.403
- ["MMEMory Subsystem \(SPECM, K14\)"](#) on page 6.404
- ["TRACe Subsystem \(SPECM, K14\)"](#) on page 6.405

CALCulate Subsystem (SPECM, K14)

The CALCulate subsystem contains commands for converting instrument data, transforming and carrying out corrections. These functions are carried out subsequent to data acquisition, i.e. following the SENSE subsystem.

The following subsystems are included:

- ["CALCulate:DELTamarker:SPECTrogram Subsystem \(SPECM, K14\)"](#) on page 6.386
- ["CALCulate:MARKer:SPECTrogram Subsystem \(SPECM, K14\)"](#) on page 6.392
- ["CALCulate:SPECTrogram Subsystem \(SPECM, K14\)"](#) on page 6.398



For the search commands in x direction refer to the base unit, section ["CALCulate:MARKer Subsystem"](#) on page 6.55.

CALCulate:DELTamarker:SPECTrogram Subsystem (SPECM, K14)

The CALCulate:DELTamarker:SPECTrogram subsystem controls the delta marker functions of the Spectrogram Measurement option.

Commands of the CALCulate:DELTamarker:SPECTrogram Subsystem

- CALCulate<1|2>:DELTamarker<1...4>:SPECTrogram:FRAME
- CALCulate<1|2>:DELTamarker<1...4>:SPECTrogram:SARea
- CALCulate<1|2>:DELTamarker<1...4>:SPECTrogram:XY:MAXimum[:PEAK]
- CALCulate<1|2>:DELTamarker<1...4>:SPECTrogram:XY:MINimum[:PEAK]
- CALCulate<1|2>:DELTamarker<1...4>:SPECTrogram:Y:MAXimum[:PEAK]
- CALCulate<1|2>:DELTamarker<1...4>:SPECTrogram:Y:MAXimum:ABOVE
- CALCulate<1|2>:DELTamarker<1...4>:SPECTrogram:Y:MAXimum:BELOW
- CALCulate<1|2>:DELTamarker<1...4>:SPECTrogram:Y:MAXimum:NEXT
- CALCulate<1|2>:DELTamarker<1...4>:SPECTrogram:Y:MINimum[:PEAK]
- CALCulate<1|2>:DELTamarker<1...4>:SPECTrogram:Y:MINimum:ABOVE
- CALCulate<1|2>:DELTamarker<1...4>:SPECTrogram:Y:MINimum:BELOW
- CALCulate<1|2>:DELTamarker<1...4>:SPECTrogram:Y:MINimum:NEXT

CALCulate<1|2>:DELTamarker<1...4>:SPECTrogram:FRAME

This command defines the frame number of the specified delta marker.
The numeric suffixes <1|2> are irrelevant for this command.

Parameter

0 to <number of recorded frames>

If the maximum number of frames is recorded, the max. value depends on the history depth (for details refer to [CALCulate<1|2>:SPECTrogram:HDEPTH](#) command)

Example

```
CALC:DELT3 ON
```

Switches on delta marker 3 or switches to delta marker mode.

```
CALC:DELT3:SPEC:FRAM -50
```

Positions delta marker 3 on frame number -50.

Characteristics

RST value: 0

SCPI: device-specific

Mode

SPECM

CALCulate<1|2>:DELTamarker<1...4>:SPECTrogram:SARea

This command defines the search area of the specified delta marker.
The numeric suffixes <1|2> are irrelevant for this command.

Parameter

VISible | MEMory

Example

```
CALC:DELT2 ON
```

Switches on delta marker 2 or switches to delta marker mode.

```
CALC:DELT2:SPEC:SAR MEM
```

Searches the whole data range stored in the history buffer.

Characteristics

RST value: VIS

SCPI: device-specific

Mode

SPECM

CALCulate<1|2>:DELTamarker<1...4>:SPECtrogram:XY:MAXimum[:PEAK]

This command positions the specified delta marker on the current maximum of the search area.

The search area is defined via the

[CALCulate<1|2>:DELTamarker<1...4>:SPECtrogram:SARea](#) command.

This command is an event and therefore has no *RST value and no query.

The numeric suffixes <1|2> are irrelevant for this command.

Example

```
CALC:DELT2 ON
```

Switches on delta marker 2 or switches to delta marker mode.

```
CALC:DELT2:SPEC:XY:MAX
```

Positions delta marker 2 on the current maximum.

Characteristics

RST value: -

SCPI: device-specific

Mode

SPECM

CALCulate<1|2>:DELTamarker<1...4>:SPECtrogram:XY:MINimum[:PEAK]

This command positions the specified delta marker on the current minimum of the search area.

The search area is defined via the

[CALCulate<1|2>:DELTamarker<1...4>:SPECtrogram:SARea](#) command. .

This command is an event and therefore has no *RST value and no query.

The numeric suffixes <1|2> are irrelevant for this command.

Example

```
CALC:DELT3 ON
```

Switches on delta marker 3 or switches to delta marker mode.

```
CALC:DELT3:SPEC:XY:MIN
```

Positions delta marker 3 on the current minimum.

Characteristics

RST value: -

SCPI: device-specific

Mode

SPECM

CALCulate<1|2>:DELTamarker<1...4>:SPECtrogram:Y:MAXimum[:PEAK]

This command positions the specified delta marker on the current maximum in y-axis direction (constant x-axis value). The corresponding search in x direction is performed via the [CALCulate<1|2>:DELTamarker<1...4>:MAXimum\[:PEAK\]](#) command.

This command is an event and therefore has no *RST value and no query.

The numeric suffixes <1|2> are irrelevant for this command.

Example

```
CALC:DELT4 ON
```

Switches on delta marker 4 or switches to delta marker mode.

```
CALC:DELT4:SPEC:Y:MAX
```

Positions delta marker 4 on the current maximum in y-axis direction.

Characteristics

RST value: -

SCPI: device-specific

Mode

SPECM

CALCulate<1|2>:DELTamarker<1...4>:SPECtrogram:Y:MAXimum:ABOVE

This command positions the specified delta marker on the next maximum above its current position (constant x-axis value). The corresponding search in x direction is performed via the [CALCulate<1|2>:DELTamarker<1...4>:MAXimum:LEFT](#) and [CALCulate<1|2>:DELTamarker<1...4>:MAXimum:RIGHT](#) commands.

This command is an event and therefore has no *RST value and no query.

The numeric suffixes <1|2> are irrelevant for this command.

Example

```
CALC:DELT2 ON
```

Switches on delta marker 2 or switches to delta marker mode.

```
CALC:DELT2:SPEC:Y:MAX:ABOV
```

Positions delta marker 2 on the next maximum above its current position.

Characteristics

RST value: -

SCPI: device-specific

Mode

SPECM

CALCulate<1|2>:DELTamarker<1...4>:SPECtrogram:Y:MAXimum:BELOW

This command positions the specified delta marker on the next maximum below its current position (constant x-axis value). The corresponding search in x direction is performed via the [CALCulate<1|2>:DELTamarker<1...4>:MAXimum:LEFT](#) and [CALCulate<1|2>:DELTamarker<1...4>:MAXimum:RIGHT](#) commands.

This command is an event and therefore has no *RST value and no query.

The numeric suffixes <1|2> are irrelevant for this command.

Example

```
CALC:DELT3 ON
```

Switches on delta marker 3 or switches to delta marker mode.

CALC:DELT3:SPEC:Y:MAX:BEL

Positions delta marker 3 on the next maximum below its current position.

Characteristics

RST value: -

SCPI: device-specific

Mode

SPECM

CALCulate<1|2>:DELTamarker<1...4>:SPECtrogram:Y:MAXimum:NEXT

This command positions the specified delta marker on the next maximum below or above its current position (constant x-axis value). The corresponding search in x direction is performed via the [CALCulate<1|2>:DELTamarker<1...4>:MAXimum:NEXT](#) command.

This command is an event and therefore has no *RST value and no query.

The numeric suffixes <1|2> are irrelevant for this command.

Example

CALC:DELT4 ON

Switches on delta marker 4 or switches to delta marker mode.

CALC:DELT4:SPEC:Y:MAX:NEXT

Positions delta marker 4 on the next maximum below or above its current position.

Characteristics

RST value: -

SCPI: device-specific

Mode

SPECM

CALCulate<1|2>:DELTamarker<1...4>:SPECtrogram:Y:MINimum[:PEAK]

This command positions the specified delta marker on the current minimum in y-axis direction (constant x-axis value). The corresponding search in x direction is performed via the [CALCulate<1|2>:DELTamarker<1...4>:MINimum\[:PEAK\]](#) command.

This command is an event and therefore has no *RST value and no query.

The numeric suffixes <1|2> are irrelevant for this command.

Example

CALC:DELT4 ON

Switches on delta marker 4 or switches to delta marker mode.

CALC:DELT4:SPEC:Y:MIN

Positions delta marker 4 on the current minimum in y-axis direction.

Characteristics

RST value: -

SCPI: device-specific

Mode

SPECM

CALCulate<1|2>:DELTamarker<1...4>:SPECtrogram:Y:MINimum:ABOVE

This command positions the specified delta marker on the next minimum above its current position (constant x-axis value). The corresponding search in x direction is performed via the [CALCulate<1|2>:DELTamarker<1...4>:MINimum:LEFT](#) and [CALCulate<1|2>:DELTamarker<1...4>:MINimum:RIGHT](#) commands.

This command is an event and therefore has no *RST value and no query.
The numeric suffixes <1|2> are irrelevant for this command.

Example

```
CALC:DELT2 ON
```

Switches on delta marker 2 or switches to delta marker mode.

```
CALC:DELT2:SPEC:Y:MIN:ABOV
```

Positions delta marker 2 on the next minimum above its current position.

Characteristics

RST value: -

SCPI: device-specific

Mode

SPECM

CALCulate<1|2>:DELTamarker<1...4>:SPECtrogram:Y:MINimum:BELOW

This command positions the specified delta marker on the next minimum below its current position (constant x-axis value). The corresponding search in x direction is performed via the [CALCulate<1|2>:DELTamarker<1...4>:MINimum:LEFT](#) and [CALCulate<1|2>:DELTamarker<1...4>:MINimum:RIGHT](#) commands.

This command is an event and therefore has no *RST value and no query.
The numeric suffixes <1|2> are irrelevant for this command.

Example

```
CALC:DELT3 ON
```

Switches on delta marker 3 or switches to delta marker mode.

```
CALC:DELT3:SPEC:Y:MIN:BEL
```

Positions delta marker 3 on the next minimum below its current position.

Characteristics

RST value: -

SCPI: device-specific

Mode

SPECM

CALCulate<1|2>:DELTamarker<1...4>:SPECtrogram:Y:MINimum:NEXT

This command positions the specified delta marker on the next minimum below or above its current position (constant x-axis value). The corresponding search in x direction is performed via the [CALCulate<1|2>:DELTamarker<1...4>:MINimum:NEXT](#) command.

This command is an event and therefore has no *RST value and no query.
The numeric suffixes <1|2> are irrelevant for this command.

Example

```
CALC:DELT4 ON
```

Switches on delta marker 4 or switches to delta marker mode.

CALC:DELTA4:SPEC:Y:MIN:NEXT

Positions delta marker 4 on the next minimum below or above its current position.

Characteristics

RST value: -

SCPI: device-specific

Mode

SPECM

CALCulate:MARKer:SPECTrogram Subsystem (SPECM, K14)

The CALCulate:MARKer:SPECTrogram subsystem controls the marker functions of the Spectrogram Measurement option.

Commands of the CALCulate:MARKer:SPECTrogram Subsystem

- CALCulate<1|2>:MARKer<1...4>:SPECTrogram:FRAMe
- CALCulate<1|2>:MARKer<1...4>:SPECTrogram:SARea
- CALCulate<1|2>:MARKer<1...4>:SPECTrogram:XY:MAXimum[:PEAK]
- CALCulate<1|2>:MARKer<1...4>:SPECTrogram:XY:MINimum[:PEAK]
- CALCulate<1|2>:MARKer<1...4>:SPECTrogram:Y:MAXimum[:PEAK]
- CALCulate<1|2>:MARKer<1...4>:SPECTrogram:Y:MAXimum:ABOVe
- CALCulate<1|2>:MARKer<1...4>:SPECTrogram:Y:MAXimum:BELow
- CALCulate<1|2>:MARKer<1...4>:SPECTrogram:Y:MAXimum:NEXT
- CALCulate<1|2>:MARKer<1...4>:SPECTrogram:Y:MINimum[:PEAK]
- CALCulate<1|2>:MARKer<1...4>:SPECTrogram:Y:MINimum:ABOVe
- CALCulate<1|2>:MARKer<1...4>:SPECTrogram:Y:MINimum:BELow
- CALCulate<1|2>:MARKer<1...4>:SPECTrogram:Y:MINimum:NEXT

CALCulate<1|2>:MARKer<1...4>:SPECTrogram:FRAMe

This command defines the frame number of the specified marker.
The numeric suffixes <1|2> are irrelevant for this command.

Parameter

0 to <number of recorded frames>

If the maximum number of frames is recorded, the max. value depends on the history depth (for details refer to [CALCulate<1|2>:SPECTrogram:HDEPTH](#) command)

Example

```
CALC:MARK3:SPEC:FRAM -20
```

Positions marker 3 on frame number -20.

Characteristics

RST value: 0

SCPI: device-specific

Mode

SPECM

CALCulate<1|2>:MARKer<1...4>:SPECTrogram:SARea

This command defines the search area of the specified marker.
The numeric suffixes <1|2> are irrelevant for this command.

Parameter

VISible | MEMory

Example

```
CALC:MARK2:SPEC:SAR MEM
```

Searches the whole data range stored in the history buffer.

Characteristics

RST value: VIS

SCPI: device-specific

Mode

SPECM

CALCulate<1|2>:MARKer<1...4>:SPECtrogram:XY:MAXimum[:PEAK]

This command positions the specified marker on the current maximum of the search area. The search area is defined via the [CALCulate<1|2>:MARKer<1...4>:SPECtrogram:SARea](#) command.

This command is an event and therefore has no *RST value and no query.

The numeric suffixes <1|2> are irrelevant for this command.

Example

```
CALC:MARK2:SPEC:XY:MAX
```

Positions marker 2 on the current maximum.

Characteristics

RST value: -

SCPI: device-specific

Mode

SPECM

CALCulate<1|2>:MARKer<1...4>:SPECtrogram:XY:MINimum[:PEAK]

This command positions the specified marker on the current minimum of the search area. The search area is defined via the [CALCulate<1|2>:MARKer<1...4>:SPECtrogram:SARea](#) command.

This command is an event and therefore has no *RST value and no query.

The numeric suffixes <1|2> are irrelevant for this command.

Example

```
CALC:MARK3:SPEC:XY:MIN
```

Positions marker 3 on the current minimum.

Characteristics

RST value: -

SCPI: device-specific

Mode

SPECM

CALCulate<1|2>:MARKer<1...4>:SPECtrogram:Y:MAXimum[:PEAK]

This command positions the specified marker on the current maximum in y-axis direction (constant x-axis value). The corresponding search in x direction is performed via the [CALCulate<1|2>:MARKer<1...4>:MAXimum\[:PEAK\]](#) command.

This command is an event and therefore has no *RST value and no query.

The numeric suffixes <1|2> are irrelevant for this command.

Note: *If no maximum value is found (level spacing to adjacent values < peak excursion), an execution error (error code: -200) is produced.*

Example

```
CALC:MARK:SPEC:Y:MAX
```

Positions marker 1 on the current maximum in y-axis direction.

Characteristics

RST value: -

SCPI: device-specific

Mode

SPECM

CALCulate<1|2>:MARKer<1...4>:SPECtrogram:Y:MAXimum:ABOVe

This command positions the specified marker on the next maximum above its current position (constant x-axis value). The corresponding search in x direction is performed via the

[CALCulate<1|2>:MARKer<1...4>:MAXimum:LEFT](#) and

[CALCulate<1|2>:MARKer<1...4>:MAXimum:RIGHT](#) commands.

This command is an event and therefore has no *RST value and no query.

The numeric suffixes <1|2> are irrelevant for this command.

Note: *If no next smaller maximum value is found (level spacing to adjacent values < peak excursion), an execution error (error code: -200) is produced.*

Example

```
CALC:MARK2:SPEC:Y:MAX
```

Positions marker 2 on the current maximum in y-axis direction.

```
CALC:MARK2:SPEC:Y:MAX:ABOV
```

Positions marker 2 on the next maximum above its current position.

Characteristics

RST value: -

SCPI: device-specific

Mode

SPECM

CALCulate<1|2>:MARKer<1...4>:SPECtrogram:Y:MAXimum:BELow

This command positions the specified marker on the next maximum below its current position (constant x-axis value). The corresponding search in x direction is performed via the

[CALCulate<1|2>:MARKer<1...4>:MAXimum:LEFT](#) and

[CALCulate<1|2>:MARKer<1...4>:MAXimum:RIGHT](#) commands.

This command is an event and therefore has no *RST value and no query.

The numeric suffixes <1|2> are irrelevant for this command.

Note: *If no next smaller maximum value is found (level spacing to adjacent values < peak excursion), an execution error (error code: -200) is produced.*

Example

```
CALC:MARK3:SPEC:Y:MAX
```

Positions marker 3 on the current maximum in y-axis direction.

CALC:MARK3:SPEC:Y:MAX:BEL

Positions marker 3 on the next maximum below its current position.

Characteristics

RST value: -

SCPI: device-specific

Mode

SPECM

CALCulate<1|2>:MARKer<1...4>:SPECTrogram:Y:MAXimum:NEXT

This command positions the specified marker on the next maximum below or above its current position (constant x-axis value). The corresponding search in x direction is performed via the [CALCulate<1|2>:MARKer<1...4>:MAXimum:NEXT](#) command.

This command is an event and therefore has no *RST value and no query.

The numeric suffixes <1|2> are irrelevant for this command.

Note: *If no next smaller maximum value is found (level spacing to adjacent values < peak excursion), an execution error (error code: -200) is produced.*

Example

CALC:MARK:SPEC:Y:MAX

Positions marker 1 on the current maximum in y-axis direction.

CALC:MARK:SPEC:Y:MAX:NEXT

Positions marker 1 on the next maximum below or above its current position.

Characteristics

RST value: -

SCPI: device-specific

Mode

SPECM

CALCulate<1|2>:MARKer<1...4>:SPECTrogram:Y:MINimum[:PEAK]

This command positions the specified marker on the current minimum in y-axis direction (constant x-axis value). The corresponding search in x direction is performed via the [CALCulate<1|2>:MARKer<1...4>:MINimum\[:PEAK\]](#) command.

This command is an event and therefore has no *RST value and no query.

The numeric suffixes <1|2> are irrelevant for this command.

Note: *If no minimum value is found (level spacing to adjacent values < peak excursion), an execution error (error code: -200) is produced.*

Example

CALC:MARK:SPEC:Y:MIN

Positions marker 1 on the current minimum in y-axis direction.

Characteristics

RST value: -

SCPI: device-specific

Mode

SPECM

CALCulate<1|2>:MARKer<1...4>:SPECtrogram:Y:MINimum:ABOVe

This command positions the specified marker on the next minimum above its current position (constant x-axis value). The corresponding search in x direction is performed via the

[CALCulate<1|2>:MARKer<1...4>:MINimum:LEFT](#) and [CALCulate<1|2>:MARKer<1...4>:MINimum:RIGHT](#) commands.

This command is an event and therefore has no *RST value and no query.

The numeric suffixes <1|2> are irrelevant for this command.

Note: *If no next higher minimum value is found (level spacing to adjacent values < peak excursion), an execution error (error code: -200) is produced.*

Example

```
CALC:MARK2:SPEC:Y:MIN
```

Positions marker 2 on the current minimum in y-axis direction.

```
CALC:MARK2:SPEC:Y:MIN:ABOV
```

Positions marker 2 on the next minimum above its current position.

Characteristics

RST value: -

SCPI: device-specific

Mode

SPECM

CALCulate<1|2>:MARKer<1...4>:SPECtrogram:Y:MINimum:BELow

This command positions the specified marker on the next minimum below its current position (constant x-axis value). The corresponding search in x direction is performed via the

[CALCulate<1|2>:MARKer<1...4>:MINimum:LEFT](#) and [CALCulate<1|2>:MARKer<1...4>:MINimum:RIGHT](#) commands.

This command is an event and therefore has no *RST value and no query.

The numeric suffixes <1|2> are irrelevant for this command.

Note: *If no next higher minimum value is found (level spacing to adjacent values < peak excursion), an execution error (error code: -200) is produced.*

Example

```
CALC:MARK3:SPEC:Y:MIN
```

Positions marker 3 on the current minimum in y-axis direction.

```
CALC:MARK3:SPEC:Y:MIN:BEL
```

Positions marker 3 on the next minimum below its current position.

Characteristics

RST value: -

SCPI: device-specific

Mode

SPECM

CALCulate<1|2>:MARKer<1...4>:SPECtrogram:Y:MINimum:NEXT

This command positions the specified marker on the next minimum below or above its current position (constant x-axis value). The corresponding search in x direction is performed via the [CALCulate<1|2>:MARKer<1...4>:MINimum:NEXT](#) command.

This command is an event and therefore has no *RST value and no query.

The numeric suffixes <1|2> are irrelevant for this command.

Note: *If no next higher minimum value is found (level spacing to adjacent values < peak excursion), an execution error (error code: -200) is produced.*

Example

```
CALC:MARK:SPEC:Y:MIN
```

Positions marker 1 on the current minimum in y-axis direction.

```
CALC:MARK:SPEC:Y:MIN:NEXT
```

Positions marker 1 on the next minimum below or above its current position.

Characteristics

RST value: -

SCPI: device-specific

Mode

SPECM

CALCulate:SPECTrogram Subsystem (SPECM, K14)

The CALCulate:SPECTrogram subsystem configures the Spectrogram Measurement option.

Commands of the CALCulate:SPECTrogram Subsystem

- CALCulate<1|2>:SPECTrogram[:STATe]
- CALCulate<1|2>:SPECTrogram:CLEar[:IMMEdiate]
- CALCulate<1|2>:SPECTrogram:COLor
- CALCulate<1|2>:SPECTrogram:CONTInuous
- CALCulate<1|2>:SPECTrogram:FRAME:COUNT
- CALCulate<1|2>:SPECTrogram:FRAME:SElect
- CALCulate<1|2>:SPECTrogram:HDEPth
- CALCulate<1|2>:SPECTrogram:SIZE
- CALCulate<1|2>:SPECTrogram:TSTamp[:STATe]
- CALCulate<1|2>:SPECTrogram:TSTamp:DATA

CALCulate<1|2>:SPECTrogram[:STATe]

This command activates or deactivates the Spectrogram Measurement option.
The numeric suffixes <1|2> are irrelevant for this command.

Parameter

ON | OFF

Example

```
CALC:SPEC ON
```

Activates the Spectrogram Measurement option.

Characteristics

RST value: OFF

SCPI: device-specific

Mode

SPECM

CALCulate<1|2>:SPECTrogram:CLEar[:IMMEdiate]

This command deletes the spectrogram result display and the history buffer.
The numeric suffixes <1|2> are irrelevant for this command.
This command is an event and therefore has no *RST value and no query.

Example

```
CALC:SPEC ON
```

Activates the Spectrogram Measurement option.

```
CALC:SPEC:CLE
```

Deletes the spectrogram result display and the history buffer.

Characteristics

RST value: -

SCPI: device-specific

Mode
SPECM

CALCulate<1|2>:SPECtrogram:COLor

This command defines the frame color setting.
The numeric suffixes <1|2> are irrelevant for this command.

Parameter

COLor	RGB colors
RADar	black - green - white
GRAYscale	black and white

Example

CALC:SPEC ON
Activates the Spectrogram Measurement option.
CALC:SPEC:COL RAD
Sets the black-green-white color scheme for the frame coloring.

Characteristics

RST value: COL
SCPI: device-specific

Mode
SPECM

CALCulate<1|2>:SPECtrogram:CONTinuous

This command determines whether the results of the last measurement are deleted before starting a new measurement in single sweep mode.
The numeric suffixes <1|2> are irrelevant for this command.

Parameter

ON | OFF

Example

CALC:SPEC ON
Activates the Spectrogram Measurement option.
INIT:CONT OFF
Sets the single sweep mode.
INIT;*WAI
Starts the measurement and waits for the end of the single sweep measurement.
CALC:SPEC:CONT ON
Repeats the single sweep measurement without deleting the spectrogram results of the last measurement.

Characteristics

RST value: OFF
SCPI: device-specific

Mode
SPECM

CALCulate<1|2>:SPECtrogram:FRAMe:COUNT

This command sets the number of frames recorded in a single sweep measurement. The numeric suffixes <1|2> are irrelevant for this command.

Parameter

1 to <max value, depending on history depth (for details refer to [CALCulate<1|2>:SPECtrogram:HDEPth](#) command)>

Example

```
CALC:SPEC ON
```

Activates the Spectrogram Measurement option.

```
INIT:CONT OFF
```

Sets the single sweep mode

```
CALC:SPEC:FRAM:COUN 200
```

Sets the number of frames to 200.

Characteristics

RST value: 1

SCPI: device-specific

Mode

SPECM

CALCulate<1|2>:SPECtrogram:FRAMe:SELEct

This command selects the frame if no measurement is running. During a measurement, the value is fixed to 0 and this command is not available.

The numeric suffixes <1|2> are irrelevant for this command.

Parameter

0 to <number of recorded frames>

If the maximum number of frames is recorded, the max. value depends on the history depth (for details refer to [CALCulate<1|2>:SPECtrogram:HDEPth](#) command)

Example

```
CALC:SPEC ON
```

Activates the Spectrogram Measurement option.

```
INIT:CONT OFF
```

Stops the measurement in continuous sweep mode.

```
CALC:SPEC:FRAM:SEL -10
```

Selects the frame number -10.

Characteristics

RST value: 0

SCPI: device-specific

Mode

SPECM

CALCulate<1|2>:SPECtrogram:HDEPth

This command sets the number of frames to be stored in the history buffer.
The numeric suffixes <1|2> are irrelevant for this command.

Parameter

282 to 20000

The maximum number of frames depends on the number of sweep points ([SENSe<1|2>:]SWEep:POINts command) and is determined as described in chapter 2, section Spectrogram Measurement (Option K14), Maximum number of frames.

Example

```
CALC:SPEC ON
```

Activates the Spectrogram Measurement option.

```
CALC:SPEC:HDEP 1000
```

Sets 1000 as number of frames to be stored in the history buffer.

Characteristics

RST value: 3000

SCPI: device-specific

Mode

SPECM

CALCulate<1|2>:SPECtrogram:SIZE

This command changes the screen layout.
The numeric suffixes <1|2> are irrelevant for this command.

Parameter

LARGE Enlarges the spectrogram result display and scales down the spectrum analyzer result display.

SMALI Divides the screen in two equally sized panes.

Example

```
CALC:SPEC ON
```

Activates the Spectrogram Measurement option.

```
CALC:SPEC:SIZE LARG
```

Enlarges the spectrogram result display.

Characteristics

RST value: SMAL

SCPI: device-specific

Mode

SPECM

CALCulate<1|2>:SPECtrogram:TSTamp[:STATe]

This command activates or deactivates the time stamp.
The numeric suffixes <1|2> are irrelevant for this command.

Parameter

ON | OFF

Example

CALC:SPEC ON

Activates the Spectrogram Measurement option.

CALC:SPEC:TST ON

Activates the time stamp.

Characteristics

RST value: OFF

SCPI: device-specific

Mode

SPECM

CALCulate<1|2>:SPECtrogram:TSTamp:DATA?

This command queries the time stamp of the frames. All available frame results are returned via the [TRACe<1|2>\[:DATA\]?](#) command).

The numeric suffixes <1|2> are irrelevant for this command.

This command is only a query and therefore has no *RST value.

Parameter

CURRent Returns the time stamp of the current frame.

ALL Returns the time stamp of all frames sorted in a descending order, starting with the current frame.

The return values consist of four values for each frame.

The first value is the date of the measurement in seconds that have passed since 01.01.1970 in seconds. For a better resolution the second value shows the additional milliseconds. This value is also displayed on screen.

These numbers are appropriate for relative uses, but you can also calculate the absolute date and time as displayed on the screen.

The third and fourth value are reserved for future uses.

Example

CALC:SPEC ON

Activates the Spectrogram Measurement option.

CALC:SPEC:TST ON

Activates the time stamp.

CALC:SPEC:TST:DATA? ALL

Returns the time stamp of all frames sorted in a descending order.

Characteristics

RST value: -

SCPI: device-specific

Mode

SPECM

INITiate Subsystem (SPECM, K14)

The INITiate subsystem is used to control the init-measurement function.

INITiate<1|2>:CONTinuous

This command starts a continuous sweep measurement or stops it and switches to single sweep mode.

The numeric suffixes <1|2> are irrelevant for this command.

Parameter

- ON Starts a continuous sweep measurement.
- OFF Stops the continuous sweep measurement and switches to single sweep mode.

Example

```
INIT:CONT OFF
```

Stops the continuous sweep measurement and switches to single sweep mode.

Characteristics

*RST value: ON

SCPI: conform

Mode

SPECM

MMEMory Subsystem (SPECM, K14)

The MMEMory (mass memory) subsystem provides commands which allow for access to the storage media of the instrument and for storing and loading various instrument settings.

The commands of the base unit are described in the chapter MMEMory Subsystem.

Commands of the MMEMory Subsystem

- [MMEMory:SELEct\[:ITEM\]:SPECtrogram](#)

MMEMory:SELEct[:ITEM]:SPECtrogram

This command adds the spectrogram data to the list of data subsets of a save/recall device setting.

Parameter

ON | OFF

Example

```
MMEM:SEL:SPEC ON
```

Adds the spectrogram data to the list of data subsets.

Characteristics

RST value: OFF

SCPI: device-specific

Mode

SPECM

TRACe Subsystem (SPECM, K14)

The TRACe subsystem controls access to the instruments internal trace memory.

Commands of the TRACe Subsystem

- [TRACe<1|2>\[:DATA\]?](#)

TRACe<1|2>[:DATA]?

Parameter

SPECTrogram

Additional to the parameters of the base unit, the SPECTrogram parameter queries all available frame results.

Return values

All available frame results are returned. The frames are sorted according to their time stamp in descending order (starting with the current frame). The time stamp of the frames is returned via the [CALCulate<1|2>:SPECTrogram:TSTamp:DATA](#) command.

The returned values are scaled in the current level unit.

FORMat REAL, 32 is used as format for binary transmission, and FORMat ASCii for ASCII transmission. For details on formats refer to "[Formats for returned values: ASCII format and binary format](#)" on page 6.294.

For further details refer to "[TRACe<1|2>\[:DATA\]](#)" on page 6.256.

Remote Commands of the Cable TV Measurements Option (K20)

This section describes the remote commands for the Cable TV Measurement option (K20). The abbreviation CATV stands for the Cable TV operating mode. For details on conventions used in this chapter refer to section "Notation" on page 6.2 at the beginning of this chapter.

For further information on analyzer or basic settings commands, refer to the corresponding subsystem in "Remote Commands of the Base Unit" on page 6.5.

This option is available from firmware version 1.30.

Subsystems of the Cable TV Analyzer option (K20)

- "ABORt Subsystem (CATV, K20)" on page 6.407
- "CALCulate Subsystem (CATV, K20)" on page 6.408
- "CONFigure Subsystem (CATV, K20)" on page 6.465
- "DISPlay Subsystem (CATV, K20)" on page 6.470
- "FORMat Subsystem (CATV, K20)" on page 6.475
- "INITiate Subsystem (CATV, K20)" on page 6.476
- "INPut Subsystem (CATV, K20)" on page 6.477
- "INSTrument Subsystem (CATV, K20)" on page 6.478
- "MMEMory Subsystem (CATV, K20)" on page 6.479
- "SENSe Subsystem (CATV, K20)" on page 6.480
- "SETup:TV Subsystem (CATV, K20)" on page 6.505
- "SOURce Subsystem (CATV, K20)" on page 6.507
- "STATus Subsystem (CATV, K20)" on page 6.508
- "TRACe Subsystem (CATV, K20)" on page 6.512
- "TRIGger Subsystem (CATV, K20)" on page 6.513
- "UNIT Subsystem (CATV, K20)" on page 6.516

ABORt Subsystem (CATV, K20)

The ABORt subsystem contains the commands for aborting triggered actions.

Commands of the ABORt Subsystem

- [ABORt](#)

ABORt

For details refer to "[ABORt](#)" on page 6.10.

CALCulate Subsystem (CATV, K20)

The CALCulate subsystem contains commands for converting instrument data, transforming and carrying out corrections. These functions are carried out subsequent to data acquisition, i.e. following the SENSE subsystem.

The following subsystems are included:

- ["CALCulate:ATV Subsystem \(CATV, K20\)"](#) on page 6.409
- ["CALCulate:DELTamarker Subsystem \(CATV, K20\)"](#) on page 6.434
- ["CALCulate:DTV Subsystem \(CATV, K20\)"](#) on page 6.436
- ["CALCulate:MARKer Subsystem \(CATV, K20\)"](#) on page 6.459
- ["CALCulate:STATistics Subsystem \(CATV, K20\)"](#) on page 6.463
- ["CALCulate:UNIT Subsystem \(CATV, K20\)"](#) on page 6.464

CALCulate:ATV Subsystem (CATV, K20)

The CALCulate:ATV subsystem contains commands to analyze the analog TV measurement data.

The following subsystems are included:

- ["CALCulate:ATV:LIMit Subsystem \(CATV, K20\)"](#) on page 6.409
- ["CALCulate:ATV:RESult Subsystem \(CATV, K20\)"](#) on page 6.429
- ["CALCulate:ATV:UNIT:POWer Subsystem \(CATV, K20\)"](#) on page 6.433

CALCulate:ATV:LIMit Subsystem (CATV, K20)

The CALCulate:ATV:LIMit subsystem sets and checks the measurement limits for analog TV measurements.

The following subsystem is included:

- ["CALCulate:ATV:LIMit:RESult Subsystem \(CATV, K20\)"](#) on page 6.418

Commands of the CALCulate:ATV:LIMit Subsystem

- [CALCulate<1|2>:ATV:LIMit:CARRiers:S1IFOffset:LOWer](#)
- [CALCulate<1|2>:ATV:LIMit:CARRiers:S1IFOffset:UPPer](#)
- [CALCulate<1|2>:ATV:LIMit:CARRiers:S1PRelative:LOWer](#)
- [CALCulate<1|2>:ATV:LIMit:CARRiers:S1PRelative:UPPer](#)
- [CALCulate<1|2>:ATV:LIMit:CARRiers:S2IFOffset:LOWer](#)
- [CALCulate<1|2>:ATV:LIMit:CARRiers:S2IFOffset:UPPer](#)
- [CALCulate<1|2>:ATV:LIMit:CARRiers:S2PRelative:LOWer](#)
- [CALCulate<1|2>:ATV:LIMit:CARRiers:S2PRelative:UPPer](#)
- [CALCulate<1|2>:ATV:LIMit:CARRiers:VCFOffset:LOWer](#)
- [CALCulate<1|2>:ATV:LIMit:CARRiers:VCFOffset:UPPer](#)
- [CALCulate<1|2>:ATV:LIMit:CARRiers:VCPabsolute:LOWer](#)
- [CALCulate<1|2>:ATV:LIMit:CARRiers:VCPabsolute:UPPer](#)
- [CALCulate<1|2>:ATV:LIMit:CN:CN\[:LOWer\]](#)
- [CALCulate<1|2>:ATV:LIMit:CSO:CSO\[:LOWer\]](#)
- [CALCulate<1|2>:ATV:LIMit:CTB:CTB\[:LOWer\]](#)
- [CALCulate<1|2>:ATV:LIMit:HUM:HUM:LOWer](#)
- [CALCulate<1|2>:ATV:LIMit:HUM:HUM:UPPer](#)
- [CALCulate<1|2>:ATV:LIMit:VMODulation:MDEPth:LOWer](#)
- [CALCulate<1|2>:ATV:LIMit:VMODulation:MDEPth:UPPer](#)
- [CALCulate<1|2>:ATV:LIMit:VMODulation:RPC:LOWer](#)
- [CALCulate<1|2>:ATV:LIMit:VMODulation:RPC:UPPer](#)
- [CALCulate<1|2>:ATV:LIMit:VMODulation:VCPower:LOWer](#)
- [CALCulate<1|2>:ATV:LIMit:VMODulation:VCPower:UPPer](#)

CALCulate<1|2>:ATV:LIMit:CARRiers:S1IFffset:LOWer

This command defines the lower frequency offset limit of the sound carrier 1.
The numeric suffixes <1|2> are irrelevant.

Parameter

-999,999 to 999,999 Hz

Example

```
CALC:ATV:LIM:CARR:S1IF:LOW 1KHZ
```

Sets the lower frequency offset limit for sound carrier 1 to 1 kHz.

Characteristics

RST value: -10 kHz

SCPI: device-specific

Mode

CATV

CALCulate<1|2>:ATV:LIMit:CARRiers:S1IFffset:UPPer

This command defines the upper frequency offset limit of the sound carrier 1.
The numeric suffixes <1|2> are irrelevant.

Parameter

-999,999 to 999,999 Hz

Example

```
CALC:ATV:LIM:CARR:S1IF:UPP 10KHZ
```

Sets the upper frequency offset limit for sound carrier 1 to 10 kHz.

Characteristics

RST value: 10 kHz

SCPI: device-specific

Mode

CATV

CALCulate<1|2>:ATV:LIMit:CARRiers:S1PRelative:LOWer

This command defines the relative lower power limit of the sound carrier 1.
The numeric suffixes <1|2> are irrelevant.

Parameter

-200 to 200 dB

Example

```
CALC:ATV:LIM:CARR:S1PR:LOW -10
```

Sets the relative lower power limit for sound carrier 1 to -10 dB.

Characteristics

RST value: -20 dB

SCPI: device-specific

Mode

CATV

CALCulate<1|2>:ATV:LIMit:CARRiers:S1PRelative:UPPer

This command defines the relative upper power limit of the sound carrier 1.
The numeric suffixes <1|2> are irrelevant.

Parameter

-200 to 200 dB

Example

```
CALC:ATV:LIM:CARR:S1PR:UPP 20
```

Sets the relative lower power limit for sound carrier 1 to 20 dB.

Characteristics

RST value: -6 dB

SCPI: device-specific

Mode

CATV

CALCulate<1|2>:ATV:LIMit:CARRiers:S2IFoffset:LOWer

This command defines the lower frequency offset limit of the sound carrier 2.
The numeric suffixes <1|2> are irrelevant.

Parameter

-999,999 to 999,999 Hz

Example

```
CALC:ATV:LIM:CARR:S2IF:LOW 1KHZ
```

Sets the lower frequency offset limit for sound carrier 2 to 1 kHz.

Characteristics

RST value: -10 kHz

SCPI: device-specific

Mode

CATV

CALCulate<1|2>:ATV:LIMit:CARRiers:S2IFoffset:UPPer

This command defines the upper frequency offset limit of the sound carrier 2.
The numeric suffixes <1|2> are irrelevant.

Parameter

-999,999 to 999,999 Hz

Example

```
CALC:ATV:LIM:CARR:S2IF:UPP 500000HZ
```

Sets the upper frequency offset limit for sound carrier 2 to 500 kHz.

Characteristics

RST value: 10 kHz

SCPI: device-specific

Mode

CATV

CALCulate<1|2>:ATV:LIMit:CARRiers:S2PRelative:LOWer

This command defines the relative lower power limit of the sound carrier 2.
The numeric suffixes <1|2> are irrelevant.

Parameter

-200 to 200 dB

Example

```
CALC:ATV:LIM:CARR:S2PR:LOW -20
```

Sets the relative lower power limit for sound carrier 2 to -20 dB.

Characteristics

RST value: -27 dB

SCPI: device-specific

Mode

CATV

CALCulate<1|2>:ATV:LIMit:CARRiers:S2PRelative:UPPer

This command defines the relative upper power limit of the sound carrier 2.
The numeric suffixes <1|2> are irrelevant.

Parameter

-200 to 200 dB

Example

```
CALC:ATV:LIM:CARR:S2PR:UPP -14
```

Sets the relative lower power limit for sound carrier 2 to -14 dB.

Characteristics

RST value: -13 dB

SCPI: device-specific

Mode

CATV

CALCulate<1|2>:ATV:LIMit:CARRiers:VCFoffset:LOWer

This command defines the lower frequency offset limit of the vision carrier.
The numeric suffixes <1|2> are irrelevant.

Parameter

-999,999 to 999,999 Hz

Example

```
CALC:ATV:LIM:CARR:VCF:LOW -1KHZ
```

Sets the lower frequency offset limit of the vision carrier to -1 kHz.

Characteristics

RST value: -10 kHz

SCPI: device-specific

Mode

CATV

CALCulate<1|2>:ATV:LIMit:CARRiers:VCFoffset:UPPer

This command defines the upper frequency offset limit of the vision carrier.
The numeric suffixes <1|2> are irrelevant.

Parameter

-999,999 to 999,999 Hz

Example

```
CALC:ATV:LIM:CARR:VCF:UPP 1KHZ
```

Sets the upper frequency offset limit of the vision carrier to 1 kHz.

Characteristics

RST value: 10 kHz

SCPI: device-specific

Mode

CATV

CALCulate<1|2>:ATV:LIMit:CARRiers:VCPabsolute:LOWer

This command defines the absolute lower limit for the vision carrier.
The numeric suffixes <1|2> are irrelevant.

Parameter

-200 to 200 dB

Example

```
CALC:ATV:LIM:CARR:VCP:LOW -40
```

Sets the absolute lower limit of the vision carrier to -40 dBm.

Characteristics

RST value: -60 dBm

SCPI: device-specific

Mode

CATV

CALCulate<1|2>:ATV:LIMit:CARRiers:VCPabsolute:UPPer

This command defines the absolute upper limit for the vision carrier.
The numeric suffixes <1|2> are irrelevant.

Parameter

-200 to 200 dB

Example

```
CALC:ATV:LIM:CARR:VCP:UPP -20
```

Sets the absolute lower limit of the vision carrier to -20 dBm.

Characteristics

RST value: -30 dBm

SCPI: device-specific

Mode

CATV

CALCulate<1|2>:ATV:LIMit:CN:CN[:LOWer]

This command defines the lower limit for the carrier-to-noise ratio.
The numeric suffixes <1|2> are irrelevant.

Parameter

-200 to 200 dB

Example

```
CALC:ATV:LIM:CN:CN 10
```

Sets the lower limit of the carrier-to-noise ratio to 10 dB.

Characteristics

RST value: 40 dB

SCPI: device-specific

Mode

CATV

CALCulate<1|2>:ATV:LIMit:CSO:CSO[:LOWer]

This command defines the lower limit for the carrier-to-second order beat ratio.
The numeric suffixes <1|2> are irrelevant.

Parameter

-200 to 200 dB

Example

```
CALC:ATV:LIM:CSO:CSO 10
```

Sets the lower limit of the carrier-to-second order beat ratio to 10 dB.

Characteristics

RST value: 0 dB

SCPI: device-specific

Mode

CATV

CALCulate<1|2>:ATV:LIMit:CTB:CTB[:LOWer]

This command defines the lower limit for the carrier-to-composite triple beat ratio.
The numeric suffixes <1|2> are irrelevant.

Parameter

-200 to 200 dB

Example

```
CALC:ATV:LIM:CTB:CTB 10
```

Sets the lower limit of the carrier-to-second order beat ratio to 10 dB.

Characteristics

RST value: 0 dB

SCPI: device-specific

Mode

CATV

CALCulate<1|2>:ATV:LIMit:HUM:HUM:LOWer

This command defines the lower limit for the hum values in dB. If the wrong unit is set, the command produces an execution error. The unit is set via the [CALCulate<1|2>:ATV:UNIT:POWer:HUM](#) command.

The numeric suffixes <1|2> are irrelevant.

Parameter

-60 to 60 dB

Example

```
CALC:ATV:UNIT:POW:HUM DB
```

Sets the unit for the Hum measurement values to dB.

```
CALC:ATV:LIM:HUM:HUM:LOW 10
```

Sets the lower limit for the hum values to 10 dB.

Characteristics

RST value: 40 dB

SCPI: device-specific

Mode

CATV

CALCulate<1|2>:ATV:LIMit:HUM:HUM:UPPer

This command defines the upper limit for the hum values in %. If the wrong unit is set, the command produces an execution error. The unit is set via the [CALCulate<1|2>:ATV:UNIT:POWer:HUM](#) command.

The numeric suffixes <1|2> are irrelevant.

Parameter

0.1 to 100.000%

Example

```
CALC:ATV:UNIT:POW:HUM PCT
```

Sets the unit for the Hum measurement values to percent.

```
CALC:ATV:LIM:HUM:HUM:UPP 6
```

Sets the upper limit of the hum values to 6%.

Characteristics

RST value: 1%

SCPI: device-specific

Mode

CATV

CALCulate<1|2>:ATV:LIMit:VMODulation:MDEPth:LOWer

This command defines the lower modulation depth limit for the vision modulation.

The numeric suffixes <1|2> are irrelevant.

Parameter

0 to 100%

Example

```
CALC:ATV:LIM:VMOD:MDEP:LOW 0.5
```

Sets the lower modulation depth limit of the vision modulation to 0.5%.

Characteristics

RST value: 0%

SCPI: device-specific

Mode

CATV

CALCulate<1|2>:ATV:LIMit:VMODulation:MDEPth:UPPer

This command defines the upper modulation depth limit for the vision modulation.

The numeric suffixes <1|2> are irrelevant.

Parameter

0 to 100%

Example

```
CALC:ATV:LIM:VMOD:MDEP:UPP 30
```

Sets the upper modulation depth limit of the vision modulation to 30%.

Characteristics

RST value: 100%

SCPI: device-specific

Mode

CATV

CALCulate<1|2>:ATV:LIMit:VMODulation:RPC:LOWer

This command defines the lower limit for the residual picture in the Vision Modulation measurement.

The numeric suffixes <1|2> are irrelevant.

Parameter

0 to 100%

Example

```
CALC:ATV:LIM:VMOD:RPC:LOW 0.5
```

Sets the lower limit for the residual picture to 0.5%.

Characteristics

RST value: 0%

SCPI: device-specific

Mode

CATV

CALCulate<1|2>:ATV:LIMit:VMODulation:RPC:UPPer

This command defines the upper limit for the residual picture in the Vision Modulation measurement.

The numeric suffixes <1|2> are irrelevant.

Parameter

0 to 100%

Example`CALC:ATV:LIM:VMOD:RPC:UPP 80`

Sets the upper limit for the residual picture to 80%.

Characteristics

RST value: 100%

SCPI: device-specific

ModeCATV

CALCulate<1|2>:ATV:LIMit:VMODulation:VCPower:LOWer

This command defines the lower vision carrier power limit in the Vision Modulation measurement.

The numeric suffixes <1|2> are irrelevant.

Parameter

-200 to 200 dBm

Example`CALC:ATV:LIM:VMOD:VCP:LOW -50`

Sets the lower vision carrier power limit to -50 dBm.

Characteristics

RST value: -60 dBm

SCPI: device-specific

ModeCATV

CALCulate<1|2>:ATV:LIMit:VMODulation:VCPower:UPPer

This command defines the upper vision carrier power limit in the Vision Modulation measurement.

The numeric suffixes <1|2> are irrelevant.

Parameter

-200 to 200 dBm

Example`CALC:ATV:LIM:VMOD:VCP:UPP 20`

Sets the upper vision carrier power limit to 20 dBm.

Characteristics

RST value: 30 dBm

SCPI: device-specific

ModeCATV

CALCulate:ATV:LIMit:RESult Subsystem (CATV, K20)

The CALCulate:ATV:LIMit:RESult subsystem checks the measurement limits for analog TV measurements.

Commands of the CALCulate:ATV:LIMit:RESult Subsystem

- CALCulate<1|2>:ATV:LIMit:RESult:CARRiers:S1IFoffset:LOWer?
- CALCulate<1|2>:ATV:LIMit:RESult:CARRiers:S1IFoffset:UPPer?
- CALCulate<1|2>:ATV:LIMit:RESult:CARRiers:S1PRelative:LOWer?
- CALCulate<1|2>:ATV:LIMit:RESult:CARRiers:S1PRelative:UPPer?
- CALCulate<1|2>:ATV:LIMit:RESult:CARRiers:S2IFoffset:LOWer?
- CALCulate<1|2>:ATV:LIMit:RESult:CARRiers:S2IFoffset:UPPer?
- CALCulate<1|2>:ATV:LIMit:RESult:CARRiers:S2PRelative:LOWer?
- CALCulate<1|2>:ATV:LIMit:RESult:CARRiers:S2PRelative:UPPer?
- CALCulate<1|2>:ATV:LIMit:RESult:CARRiers:VCOffset:LOWer?
- CALCulate<1|2>:ATV:LIMit:RESult:CARRiers:VCOffset:UPPer?
- CALCulate<1|2>:ATV:LIMit:RESult:CARRiers:VCPabsolute:LOWer?
- CALCulate<1|2>:ATV:LIMit:RESult:CARRiers:VCPabsolute:UPPer?
- CALCulate<1|2>:ATV:LIMit:RESult:CN:CN[:LOWer]?
- CALCulate<1|2>:ATV:LIMit:RESult:CSO:CSO[:LOWer]?
- CALCulate<1|2>:ATV:LIMit:RESult:CTB:CTB[:LOWer]?
- CALCulate<1|2>:ATV:LIMit:RESult:HUM:HUM:LOWer?
- CALCulate<1|2>:ATV:LIMit:RESult:HUM:HUM:UPPer?
- CALCulate<1|2>:ATV:LIMit:RESult:VMODulation:MDEPth:LOWer?
- CALCulate<1|2>:ATV:LIMit:RESult:VMODulation:MDEPth:UPPer?
- CALCulate<1|2>:ATV:LIMit:RESult:VMODulation:RPC:LOWer?
- CALCulate<1|2>:ATV:LIMit:RESult:VMODulation:RPC:UPPer?
- CALCulate<1|2>:ATV:LIMit:RESult:VMODulation:VCPower:LOWer?
- CALCulate<1|2>:ATV:LIMit:RESult:VMODulation:VCPower:UPPer?

CALCulate<1|2>:ATV:LIMit:RESult:CARRiers:S1IFoffset:LOWer?

This command performs a lower limit check for the frequency offset of the sound carrier 1.

The numeric suffixes <1|2> are irrelevant.

This command is a query and therefore has no *RST value.

Example

```
CALC:ATV:LIM:CARR:S1IF:LOW 1KHZ
```

Sets the lower frequency offset limit for sound carrier 1 to 1 kHz.

```
INIT;*WAI
```

Starts a new measurement and waits for the sweep end.

```
CALC:ATV:LIM:RES:CARR:S1IF:LOW?
```

Performs a lower limit check for the frequency offset of the sound carrier 1.

Characteristics

RST value: -

SCPI: device-specific

ModeCATV

CALCulate<1|2>:ATV:LIMit:RESult:CARRiers:S1IFoffset:UPPer?

This command performs an upper limit check for the frequency offset of the sound carrier 1.

The numeric suffixes <1|2> are irrelevant.

This command is a query and therefore has no *RST value.

Example

```
CALC:ATV:LIM:CARR:S1IF:UPP 10KHZ
```

Sets the upper frequency offset limit for sound carrier 1 to 10 kHz.

```
INIT;*WAI
```

Starts a new measurement and waits for the sweep end.

```
CALC:ATV:LIM:RES:CARR:S1IF:UPP?
```

Performs an upper limit check for the frequency offset of the sound carrier 1.

Characteristics

RST value: -

SCPI: device-specific

ModeCATV

CALCulate<1|2>:ATV:LIMit:RESult:CARRiers:S1PRelative:LOWer?

This command performs a lower limit check for the relative power of the sound carrier 1.

The numeric suffixes <1|2> are irrelevant.

This command is a query and therefore has no *RST value.

Example

```
CALC:ATV:LIM:CARR:S1PR:LOW -10
```

Sets the relative lower power limit for sound carrier 1 to -10 dB.

```
INIT;*WAI
```

Starts a new measurement and waits for the sweep end.

```
CALC:ATV:LIM:RES:CARR:S1PR:LOW?
```

Performs a lower limit check for the relative power of the sound carrier 1.

Characteristics

RST value: -

SCPI: device-specific

ModeCATV

CALCulate<1|2>:ATV:LIMit:RESult:CARRiers:S1PRelative:UPPer?

This command performs an upper limit check for the relative power of the sound carrier 1.

The numeric suffixes <1|2> are irrelevant.

This command is a query and therefore has no *RST value.

Example

```
CALC:ATV:LIM:CARR:S1PR:UPP 20
```

Sets the relative lower power limit for sound carrier 1 to 20 dB.

```
INIT;*WAI
```

Starts a new measurement and waits for the sweep end.

```
CALC:ATV:LIM:RES:CARR:S1PR:UPP?
```

Performs an upper limit check for the relative power of the sound carrier 1.

Characteristics

RST value: -

SCPI: device-specific

Mode

CATV

CALCulate<1|2>:ATV:LIMit:RESult:CARRiers:S2IFoffset:LOWer?

This command performs a lower limit check for the frequency offset of the sound carrier 2.

The numeric suffixes <1|2> are irrelevant.

This command is a query and therefore has no *RST value.

Example

```
CALC:ATV:LIM:CARR:S2IF:LOW 1KHZ
```

Sets the lower frequency offset limit for sound carrier 2 to 1 kHz.

```
INIT;*WAI
```

Starts a new measurement and waits for the sweep end.

```
CALC:ATV:LIM:RES:CARR:S2IF:LOW?
```

Performs a lower limit check for the frequency offset of the sound carrier 2.

Characteristics

RST value: -

SCPI: device-specific

Mode

CATV

CALCulate<1|2>:ATV:LIMit:RESult:CARRiers:S2IFoffset:UPPer?

This command performs an upper limit check for the frequency offset limit of the sound carrier 2.

The numeric suffixes <1|2> are irrelevant.

This command is a query and therefore has no *RST value.

Example

```
CALC:ATV:LIM:CARR:S2IF:UPP 500000HZ
```

Sets the upper frequency offset limit for sound carrier 2 to 500 kHz.

```
INIT;*WAI
```

Starts a new measurement and waits for the sweep end.

CALC:ATV:LIM:RES:CARR:S2IF:UPP?

Performs an upper limit check for the frequency offset limit of the sound carrier 2.

Characteristics

RST value: -

SCPI: device-specific

Mode

CATV

CALCulate<1|2>:ATV:LIMit:RESult:CARRiers:S2PRelative:LOWer?

This command performs a lower limit check for the relative power of the sound carrier 2.

The numeric suffixes <1|2> are irrelevant.

This command is a query and therefore has no *RST value.

Example

CALC:ATV:LIM:CARR:S2PR:LOW -20

Sets the relative lower power limit for sound carrier 2 to -20 dB.

INIT;*WAI

Starts a new measurement and waits for the sweep end.

CALC:ATV:LIM:RES:CARR:S2PR:LOW?

Performs a lower limit check for the relative power of the sound carrier 2.

Characteristics

RST value: -

SCPI: device-specific

Mode

CATV

CALCulate<1|2>:ATV:LIMit:RESult:CARRiers:S2PRelative:UPPer?

This command performs an upper limit check for the relative power of the sound carrier 2.

The numeric suffixes <1|2> are irrelevant.

This command is a query and therefore has no *RST value.

Example

CALC:ATV:LIM:CARR:S2PR:UPP -14

Sets the relative lower power limit for sound carrier 2 to -14 dB.

INIT;*WAI

Starts a new measurement and waits for the sweep end.

CALC:ATV:LIM:RES:CARR:S2PR:UPP?

Performs an upper limit check for the relative power of the sound carrier 2.

Characteristics

RST value: -

SCPI: device-specific

Mode

CATV

CALCulate<1|2>:ATV:LIMit:RESult:CARRiers:VCFoffset:LOWer?

This command performs a lower limit check for the frequency offset of the vision carrier.

The numeric suffixes <1|2> are irrelevant.

This command is a query and therefore has no *RST value.

Example

```
CALC:ATV:LIM:CARR:VCF:LOW -1KHZ
```

Sets the lower frequency offset limit of the vision carrier to -1 kHz.

```
INIT;*WAI
```

Starts a new measurement and waits for the sweep end.

```
CALC:ATV:LIM:RES:CARR:VCF:LOW?
```

Performs a lower limit check for the frequency offset of the vision carrier.

Characteristics

RST value: -

SCPI: device-specific

Mode

CATV

CALCulate<1|2>:ATV:LIMit:RESult:CARRiers:VCFoffset:UPPer?

This command performs an upper limit check for the frequency offset of the vision carrier.

The numeric suffixes <1|2> are irrelevant.

This command is a query and therefore has no *RST value.

Example

```
CALC:ATV:LIM:CARR:VCF:UPP 1KHZ
```

Sets the upper frequency offset limit of the vision carrier to 1 kHz.

```
INIT;*WAI
```

Starts a new measurement and waits for the sweep end.

```
CALC:ATV:LIM:RES:CARR:VCF:UPP?
```

Performs an upper limit check for the frequency offset of the vision carrier.

Characteristics

RST value: -

SCPI: device-specific

Mode

CATV

CALCulate<1|2>:ATV:LIMit:RESult:CARRiers:VCPabsolute:LOWer?

This command performs a lower limit check for the absolute vision carrier power.

The numeric suffixes <1|2> are irrelevant.

This command is a query and therefore has no *RST value.

Example

```
CALC:ATV:LIM:CARR:VCP:LOW -40
```

Sets the absolute lower limit of the vision carrier to -40 dBm.

```
INIT;*WAI
```

Starts a new measurement and waits for the sweep end.

```
CALC:ATV:LIM:RES:CARR:VCP:LOW?
```

Performs a lower limit check for the absolute vision carrier power.

Characteristics

RST value: -

SCPI: device-specific

Mode

CATV

CALCulate<1|2>:ATV:LIMit:RESult:CARRiers:VCPabsolute:UPPer?

This command performs an upper limit check for the absolute vision carrier power.

The numeric suffixes <1|2> are irrelevant.

This command is a query and therefore has no *RST value.

Example

```
CALC:ATV:LIM:CARR:VCP:UPP -20
```

Sets the absolute lower limit of the vision carrier to -20 dBm.

```
INIT;*WAI
```

Starts a new measurement and waits for the sweep end.

```
CALC:ATV:LIM:RES:CARR:VCP:UPP?
```

Performs an upper limit check for the absolute vision carrier power.

Characteristics

RST value: -

SCPI: device-specific

Mode

CATV

CALCulate<1|2>:ATV:LIMit:RESult:CN:CN[:LOWer]?

This command performs a lower limit check for the carrier-to-noise ratio.

The numeric suffixes <1|2> are irrelevant.

This command is a query and therefore has no *RST value.

Example

```
CALC:ATV:LIM:CN:CN 10
```

Sets the lower limit of the carrier-to-noise ratio to 10 dB.

```
INIT;*WAI
```

Starts a new measurement and waits for the sweep end.

```
CALC:ATV:LIM:RES:CN:CN?
```

Performs a lower limit check for the carrier-to-noise ratio.

Characteristics

RST value: -

SCPI: device-specific

Mode

CATV

CALCulate<1|2>:ATV:LIMit:RESult:CSO:CSO[:LOWer]?

This command performs a lower limit check for the carrier-to-second order beat ratio.

The numeric suffixes <1|2> are irrelevant.

This command is a query and therefore has no *RST value.

Example

```
CALC:ATV:LIM:CSO:CSO 10
```

Sets the lower limit of the carrier-to-second order beat ratio to 10 dB.

```
INIT;*WAI
```

Starts a new measurement and waits for the sweep end.

```
CALC:ATV:LIM:RES:CSO:CSO?
```

Performs a lower limit check for the carrier-to-second order beat ratio.

Characteristics

RST value: -

SCPI: device-specific

Mode

CATV

CALCulate<1|2>:ATV:LIMit:RESult:CTB:CTB[:LOWer]?

This command performs a lower limit check for the carrier-to-composite triple beat ratio.

The numeric suffixes <1|2> are irrelevant.

This command is a query and therefore has no *RST value.

Example

```
CALC:ATV:LIM:CTB:CTB 10
```

Sets the lower limit of the carrier-to-second order beat ratio to 10 dB.

```
INIT;*WAI
```

Starts a new measurement and waits for the sweep end.

```
CALC:ATV:LIM:RES:CTB:CTB?
```

Performs a lower limit check for the carrier-to-composite triple beat ratio.

Characteristics

RST value: -

SCPI: device-specific

Mode

CATV

CALCulate<1|2>:ATV:LIMit:RESult:HUM:HUM:LOWer?

This command performs a lower limit check for the Hum measurement.

The numeric suffixes <1|2> are irrelevant.

This command is a query and therefore has no *RST value.

Example

```
CALC:ATV:LIM:HUM:HUM:LOW 10
```

Sets the lower limit for the hum values to 10 dB.

```
INIT;*WAI
```

Starts a new measurement and waits for the sweep end.

CALC:ATV:LIM:RES:HUM:HUM:LOW?
 Performs a lower limit check for the hum values.

Characteristics

RST value: -
 SCPI: device-specific

Mode

CATV

CALCulate<1|2>:ATV:LIMit:RESult:HUM:HUM:UPPer?

This command performs an upper limit check for the Hum measurement.
 The numeric suffixes <1|2> are irrelevant.
 This command is a query and therefore has no *RST value.

Example

CALC:ATV:LIM:HUM:HUM:UPP 6
 Sets the upper limit of the hum values to 6%.
 INIT;*WAI
 Starts a new measurement and waits for the sweep end.
 CALC:ATV:LIM:RES:HUM:HUM:UPP?
 Performs an upper limit check for the hum values.

Characteristics

RST value: -
 SCPI: device-specific

Mode

CATV

CALCulate<1|2>:ATV:LIMit:RESult:VMODulation:MDEPth:LOWer?

This command performs a lower limit check for the modulation depth of the Vision Modulation measurement.
 The numeric suffixes <1|2> are irrelevant.
 This command is a query and therefore has no *RST value.

Example

CALC:ATV:LIM:VMOD:MDEP:LOW 0.5
 Sets the lower modulation depth limit of the vision modulation to 0.5%.
 INIT;*WAI
 Starts a new measurement and waits for the sweep end.
 CALC:ATV:LIM:RES:VMOD:MDEP:LOW?
 Performs a lower limit check for the modulation depth of the Vision Modulation measurement.

Characteristics

RST value: -
 SCPI: device-specific

Mode

CATV

CALCulate<1|2>:ATV:LIMit:RESult:VMODulation:MDEPth:UPPer?

This command performs an upper limit check for the modulation depth of the Vision Modulation measurement.

The numeric suffixes <1|2> are irrelevant.

This command is a query and therefore has no *RST value.

Example

```
CALC:ATV:LIM:VMOD:MDEP:UPP 30
```

Sets the upper modulation depth limit of the vision modulation to 30%.

```
INIT;*WAI
```

Starts a new measurement and waits for the sweep end.

```
CALC:ATV:LIM:RES:VMOD:MDEP:UPP?
```

Performs an upper limit check for the modulation depth of the Vision Modulation measurement.

Characteristics

RST value: -

SCPI: device-specific

Mode

CATV

CALCulate<1|2>:ATV:LIMit:RESult:VMODulation:RPC:LOWer?

This command performs a lower limit check for the residual picture in the Vision Modulation measurement.

The numeric suffixes <1|2> are irrelevant.

This command is a query and therefore has no *RST value.

Example

```
CALC:ATV:LIM:VMOD:RPC:LOW 0.5
```

Sets the lower limit for the residual picture to 75%.

```
INIT;*WAI
```

Starts a new measurement and waits for the sweep end.

```
CALC:ATV:LIM:RES:VMOD:RPC:LOW?
```

Performs a lower limit check for the residual picture in the Vision Modulation measurement.

Characteristics

RST value: -

SCPI: device-specific

Mode

CATV

CALCulate<1|2>:ATV:LIMit:RESult:VMODulation:RPC:UPPer?

This command performs an upper limit check for the residual picture in the Vision Modulation measurement.

The numeric suffixes <1|2> are irrelevant.

This command is a query and therefore has no *RST value.

Example

```
CALC:ATV:LIM:VMOD:RPC:UPP 80
```

Sets the upper limit for the residual picture to 80%.

```
INIT;*WAI
```

Starts a new measurement and waits for the sweep end.

```
CALC:ATV:LIM:RES:VMOD:RPC:UPP?
```

Performs an upper limit check for the residual picture in the Vision Modulation measurement.

Characteristics

RST value: -

SCPI: device-specific

Mode

CATV

CALCulate<1|2>:ATV:LIMit:RESult:VMODulation:VCPower:LOWer?

This command performs a lower limit check for the vision carrier power in the Vision Modulation measurement.

The numeric suffixes <1|2> are irrelevant.

This command is a query and therefore has no *RST value.

Example

```
CALC:ATV:LIM:VMOD:VCP:LOW -50
```

Sets the lower vision carrier power limit to 10 dBm.

```
INIT;*WAI
```

Starts a new measurement and waits for the sweep end.

```
CALC:ATV:LIM:RES:VMOD:VCP:LOW?
```

Performs a lower limit check for the vision carrier power in the Vision Modulation measurement.

Characteristics

RST value: -

SCPI: device-specific

Mode

CATV

CALCulate<1|2>:ATV:LIMit:RESult:VMODulation:VCPower:UPPer?

This command performs an upper limit check for the vision carrier power in the Vision Modulation measurement.

The numeric suffixes <1|2> are irrelevant.

This command is a query and therefore has no *RST value.

Example

```
CALC:ATV:LIM:VMOD:VCP:UPP 20
```

Sets the upper vision carrier power limit to 20 dBm.

```
INIT;*WAI
```

Starts a new measurement and waits for the sweep end.

```
CALC:ATV:LIM:RES:VMOD:VCP:UPP?
```

Performs an upper limit check for the vision carrier power in the Vision Modulation measurement.

Characteristics

RST value: -

SCPI: device-specific

Mode

CATV

CALCulate:ATV:RESult Subsystem (CATV, K20)

The CALCulate:ATV:RESult subsystem displays the measurement results for analog TV measurements.

Commands of the CALCulate:ATV:RESult Subsystem

- CALCulate<1|2>:ATV:RESult:CARRiers?
- CALCulate<1|2>:ATV:RESult:CN?
- CALCulate<1|2>:ATV:RESult:CSO?
- CALCulate<1|2>:ATV:RESult:CTB?
- CALCulate<1|2>:ATV:RESult:HUM?
- CALCulate<1|2>:ATV:RESult:VMODulation?

CALCulate<1|2>:ATV:RESult:CARRiers?

This command reads the measurement values (power, frequency) of the Carrier Power measurements.

The numeric suffixes <1|2> are irrelevant.

This command is a query only and thus has no *RST value.

Parameter

VCPabsolute	vision carrier power absolute
VCOffset	vision carrier frequency offset
S1PRelative	sound carrier 1 power relative
S1FOffset	sound carrier 1 intercarrier frequency offset
S2PRelative	sound carrier 2 power relative
S2FOffset	sound carrier 2 intercarrier frequency offset
ALL	Results of all measurements above, separated by commas. If a measurement result is not valid, a comma will be output only.

Example

```
CONF:ATV:MEAS CARR
```

Configures the analog TV Carrier Power measurement.

```
INIT;*WAI
```

Starts a new measurement and waits for the sweep end.

```
CALC:ATV:RES:CARR? VCF
```

Reads the result of the vision carrier frequency offset parameter.

or

```
CALC:ATV:RES:CARR? ALL
```

Reads all measured values.

Characteristics

RST value: -

SCPI: device-specific

Mode

CATV

CALCulate<1|2>:ATV:RESult:CN?

This command reads the measurement values of the Carrier-to-Noise Ratio measurements.

The numeric suffixes <1|2> are irrelevant.

This command is a query only and thus has no *RST value.

Parameter

RPOWer	reference power
NRBW	noise reference bandwidth
NFCorrection	noise floor correction
MFRelative	measurement frequency (relative)
CN	carrier-to-noise ratio
ALL	Results of all measurements above, separated by commas. If a measurement result is not valid, a comma will be output only.

Example

```
CONF:ATV:MEAS CN
```

Configures the analog TV Carrier-to-Noise Ratio measurement.

```
INIT;*WAI
```

Starts a new measurement and waits for the sweep end.

```
CALC:ATV:RES:CN? NFC
```

Reads the result of the noise floor correction measurement.

or

```
CALC:ATV:RES:CN? ALL
```

Reads all measured values.

Characteristics

RST value: -

SCPI: device-specific

Mode

CATV

CALCulate<1|2>:ATV:RESult:CSO?

This command reads the measurement values of the Carrier-to-Second Order Beat Ratio measurements.

The numeric suffixes <1|2> are irrelevant.

This command is a query only and thus has no *RST value.

Parameter

RPOWer	reference power
NFCorrection	noise reference bandwidth
MFRelative	measurement frequency relative
CSO	carrier-to-second order beat ratio
ALL	Results of all measurements above, separated by commas. If a measurement result is not valid, a comma will be output only.

Example

```
CONF:ATV:MEAS CSO
```

Configures the analog TV Carrier-to-Second Order Beat Ratio measurement.

```
INIT;*WAI
```

Starts a new measurement and waits for the sweep end.

```
CALC:ATV:RES:CSO? RPOW
```

Reads the result of the reference power parameter.

or

```
CALC:ATV:RES:CSO? ALL
```

Reads all measured values.

Characteristics

RST value: -

SCPI: device-specific

Mode

CATV

CALCulate<1|2>:ATV:RESult:CTB?

This command reads the measurement values of the Carrier-to-Composite Triple Beat Ratio measurements.

The numeric suffixes <1|2> are irrelevant.

This command is a query only and thus has no *RST value.

Parameter

RPOWer reference power

NFCorrection noise reference bandwidth

MFRelative measurement frequency relative

CTB carrier-to-composite triple beat ratio

ALL Results of all measurements above, separated by commas.
If a measurement result is not valid, a comma will be output only.

Example

```
CONF:ATV:MEAS CTB
```

Configures the analog TV Carrier-to-Composite Triple Beat Ratio measurement.

```
INIT;*WAI
```

Starts a new measurement and waits for the sweep end.

```
CALC:ATV:RES:CTB? MFR
```

Reads the result of the relative measurement frequency parameter.

or

```
CALC:ATV:RES:CTB? ALL
```

Reads all measured values.

Characteristics

RST value: -

SCPI: device-specific

Mode

CATV

CALCulate<1|2>:ATV:RESult:HUM?

This command reads the measurement values of the Hum measurement.

The numeric suffixes <1|2> are irrelevant.

This command is a query only and thus has no *RST value.

Example

```
CONF:ATV:MEAS HUM
```

Configures the analog TV Hum measurement.

```
INIT;*WAI
```

Starts a new measurement and waits for the sweep end.

```
CALC:ATV:RES:HUM?
```

Reads the measured value.

Characteristics

RST value: -

SCPI: device-specific

Mode

CATV

CALCulate<1|2>:ATV:RESult:VMODulation?

This command reads the measurement values of the Vision Modulation measurements.

The numeric suffixes <1|2> are irrelevant.

This command is a query only and thus has no *RST value.

Parameter

VCPower vision carrier power

RPC residual picture carrier

MDEPth modulation depth

ALL Results of all measurements above, separated by commas.
If a measurement result is not valid, a comma will be output only.

Example

```
CONF:ATV:MEAS VMOD
```

Configures the analog TV Vision Modulation measurement.

```
INIT;*WAI
```

Starts a new measurement and waits for the sweep end.

```
CALC:ATV:RES:VMOD? MDEP
```

Reads the result of the modulation depth parameter.

or

```
CALC:ATV:RES:VMOD? ALL
```

Reads all measured values.

Characteristics

RST value: -

SCPI: device-specific

Mode

CATV

CALCulate:ATV:UNIT:POWer Subsystem (CATV, K20)

The CALCulate:ATV:UNIT:POWer subsystem sets the unit for the measurements for analog TV measurements.

Commands of the CALCulate:ATV:UNIT:POWer Subsystem

- [CALCulate<1|2>:ATV:UNIT:POWer:HUM](#)
- [CALCulate<1|2>:ATV:UNIT:POWer:VCPabsolute](#)

CALCulate<1|2>:ATV:UNIT:POWer:HUM

This command defines the unit of the Hum measurement values.
The numeric suffixes <1|2> are irrelevant.

Parameter

DB | PCT

Example

```
CALC:ATV:UNIT:POW:HUM PCT
```

Sets the unit for the Hum measurement values to percent.

Characteristics

RST value: dB

SCPI: device-specific

Mode

CATV

CALCulate<1|2>:ATV:UNIT:POWer:VCPabsolute

This command defines the unit of the absolute vision carrier power.
The numeric suffixes <1|2> are irrelevant.

Parameter

DB | PCT

Example

```
CALC:ATV:UNIT:POW:VCP DB
```

Sets the unit for the absolute vision carrier power to dB.

Characteristics

RST value: dBm

SCPI: device-specific

Mode

CATV

CALCulate:DELTamarker Subsystem (CATV, K20)

The CALCulate:DELTamarker subsystem controls the delta marker functions of the instrument.

Commands of the CALCulate:DELTamarker Subsystem

- CALCulate<1|2>:DELTamarker<1...4>[:STATe]
- CALCulate<1|2>:DELTamarker<1...4>:AOFF
- CALCulate<1|2>:DELTamarker<1...4>:MAXimum[:PEAK]
- CALCulate<1|2>:DELTamarker<1...4>:MAXimum:LEFT
- CALCulate<1|2>:DELTamarker<1...4>:MAXimum:NEXT
- CALCulate<1|2>:DELTamarker<1...4>:MAXimum:RIGHT
- CALCulate<1|2>:DELTamarker<1...4>:MINimum[:PEAK]
- CALCulate<1|2>:DELTamarker<1...4>:MINimum:LEFT
- CALCulate<1|2>:DELTamarker<1...4>:MINimum:NEXT
- CALCulate<1|2>:DELTamarker<1...4>:MINimum:RIGHT
- CALCulate<1|2>:DELTamarker<1...4>:MODE
- CALCulate<1|2>:DELTamarker<1...4>:TRACe
- CALCulate<1|2>:DELTamarker<1...4>:X
- CALCulate<1|2>:DELTamarker<1...4>:X:RELative?
- CALCulate<1|2>:DELTamarker<1...4>:Y?

CALCulate<1|2>:DELTamarker<1...4>[:STATe]

For details refer to "CALCulate<1|2>:DELTamarker<1...4>[:STATe]" on page 6.12.

CALCulate<1|2>:DELTamarker<1...4>:AOFF

For details refer to "CALCulate<1|2>:DELTamarker<1...4>:AOFF" on page 6.13.

CALCulate<1|2>:DELTamarker<1...4>:MAXimum[:PEAK]

For details refer to "CALCulate<1|2>:DELTamarker<1...4>:MAXimum[:PEAK]" on page 6.16.

CALCulate<1|2>:DELTamarker<1...4>:MAXimum:LEFT

For details refer to "CALCulate<1|2>:DELTamarker<1...4>:MAXimum:LEFT" on page 6.17.

CALCulate<1|2>:DELTamarker<1...4>:MAXimum:NEXT

For details refer to "CALCulate<1|2>:DELTamarker<1...4>:MAXimum:NEXT" on page 6.17.

CALCulate<1|2>:DELTamarker<1...4>:MAXimum:RIGHT

For details refer to "CALCulate<1|2>:DELTamarker<1...4>:MAXimum:RIGHT" on page 6.17.

CALCulate<1|2>:DELTamarker<1...4>:MINimum[:PEAK]

For details refer to "[CALCulate<1|2>:DELTamarker<1...4>:MINimum\[:PEAK\]](#)" on page 6.18.

CALCulate<1|2>:DELTamarker<1...4>:MINimum:LEFT

For details refer to "[CALCulate<1|2>:DELTamarker<1...4>:MINimum:LEFT](#)" on page 6.18.

CALCulate<1|2>:DELTamarker<1...4>:MINimum:NEXT

For details refer to "[CALCulate<1|2>:DELTamarker<1...4>:MINimum:NEXT](#)" on page 6.19.

CALCulate<1|2>:DELTamarker<1...4>:MINimum:RIGHT

For details refer to "[CALCulate<1|2>:DELTamarker<1...4>:MINimum:RIGHT](#)" on page 6.19.

CALCulate<1|2>:DELTamarker<1...4>:MODE

For details refer to "[CALCulate<1|2>:DELTamarker<1...4>:MODE](#)" on page 6.19.

CALCulate<1|2>:DELTamarker<1...4>:TRACe

Parameter

1 to 4

For further details refer to "[CALCulate<1|2>:DELTamarker<1...4>:TRACe](#)" on page 6.20.

CALCulate<1|2>:DELTamarker<1...4>:X

For details refer to "[CALCulate<1|2>:DELTamarker<1...4>:X](#)" on page 6.20.

CALCulate<1|2>:DELTamarker<1...4>:X:RELative?

For details refer to "[CALCulate<1|2>:DELTamarker<1...4>:X:RELative?](#)" on page 6.21.

CALCulate<1|2>:DELTamarker<1...4>:Y?

Parameter

<numeric_value> in DBM

For further details refer to "[CALCulate<1|2>:DELTamarker<1...4>:Y?](#)" on page 6.21.

CALCulate:DTV Subsystem (CATV, K20)

The CALCulate:DTV subsystem contains commands to analyze the digital TV measurement data.

The following subsystems are included:

- ["CALCulate:DTV:LIMit Subsystem \(CATV, K20\)"](#) on page 6.436
- ["CALCulate:DTV:RESult Subsystem \(CATV, K20\)"](#) on page 6.454
- ["CALCulate:DTV:UNIT:POWer Subsystem \(CATV, K20\)"](#) on page 6.456

CALCulate:DTV:LIMit Subsystem (CATV, K20)

The CALCulate:DTV:LIMit subsystem sets and checks the measurement limits for digital TV measurements.

The following subsystem is included:

- ["CALCulate:DTV:LIMit:RESult Subsystem \(CATV, K20\)"](#) on page 6.445

Commands of the CALCulate:DTV:LIMit Subsystem

- [CALCulate:DTV:LIMit:CFOffset:LOWer](#)
- [CALCulate:DTV:LIMit:CFOffset:UPPer](#)
- [CALCulate:DTV:LIMit:CHPower:UPPer](#)
- [CALCulate:DTV:LIMit:CHPower:LOWer](#)
- [CALCulate:DTV:LIMit:CSUPpression\[:LOWer\]](#)
- [CALCulate:DTV:LIMit:EVMPeak:LOWer](#)
- [CALCulate:DTV:LIMit:EVMPeak:UPPer](#)
- [CALCulate:DTV:LIMit:EVMRms:LOWer](#)
- [CALCulate:DTV:LIMit:EVMRms:UPPer](#)
- [CALCulate:DTV:LIMit:IMBalance:LOWer](#)
- [CALCulate:DTV:LIMit:IMBalance:UPPer](#)
- [CALCulate:DTV:LIMit:MERPeak:LOWer](#)
- [CALCulate:DTV:LIMit:MERPeak:UPPer](#)
- [CALCulate:DTV:LIMit:MERRms:LOWer](#)
- [CALCulate:DTV:LIMit:MERRms:UPPer](#)
- [CALCulate:DTV:LIMit:PJITter\[:UPPer\]](#)
- [CALCulate:DTV:LIMit:QERRor:LOWer](#)
- [CALCulate:DTV:LIMit:QERRor:UPPer](#)
- [CALCulate:DTV:LIMit:SROffset:LOWer](#)
- [CALCulate:DTV:LIMit:SROffset:UPPer](#)

CALCulate:DTV:LIMit:CFOffset:LOWer

This command defines the lower limit of the carrier frequency offset in the Overview measurement.

Parameter

-99,999 to 99,999 Hz

Example

```
CALC:DTV:LIM:CFOF:LOW -10KHZ
```

Sets the lower limit for the carrier frequency offset to -10 kHz.

Characteristics

RST value: -30 kHz

SCPI: device-specific

Mode

CATV

CALCulate:DTV:LIMit:CFOffset:UPPer

This command defines the upper limit of the carrier frequency offset in the Overview measurement.

Parameter

-99,999 to 99,999 Hz

Example

```
CALC:DTV:LIM:CFOF:UPP 20KHZ
```

Sets the upper limit for the carrier frequency offset to 20 kHz.

Characteristics

RST value: 30 kHz

SCPI: device-specific

Mode

CATV

CALCulate:DTV:LIMit:CHPower:UPPer

This command defines the upper limit for the Channel Power measurement.

Parameter

-200 to 200 dBm

Example

```
CALC:DTV:LIM:CHP:UPP -18 DBM
```

Sets the upper limit for the Channel Power measurement to -18 dBm.

Characteristics

RST value: 30 dBm

SCPI: device-specific

Mode

CATV

CALCulate:DTV:LIMit:CHPower:LOWer

This command defines the lower limit for the Channel Power measurement.

Parameter

-200 to 200 dBm

Example

```
CALC:DTV:LIM:CHP:LOW -22 DBM
```

Sets the lower limit for the Channel Power measurement to -22 dBm.

Characteristics

RST value: -60 dBm

SCPI: device-specific

Mode

CATV

CALCulate:DTV:LIMit:CSUPpression[:LOWer]

This command defines the lower limit of the carrier suppression in the Modulation Errors measurement.

Parameter

0 to 200 dB

Example

```
CALC:DTV:LIM:CSUP 30
```

Sets the lower limit for the carrier suppression to 30 dB.

Characteristics

RST value: 35 dB

SCPI: device-specific

Mode

CATV

CALCulate:DTV:LIMit:EVMPeak:LOWer

This command defines the lower limit of the error vector magnitude peak in dB for the Overview / Modulation Errors measurement. If the wrong unit is set, the command produces an execution error. The unit is set via the `CALCulate<1|2>:DTV:UNIT:POWer:EVMPeak` command.

Parameter

0 to 80 dB

Example

```
CALC:DTV:UNIT:POW:EVMP DB
```

Sets the unit for the error vector magnitude peak to dB.

```
CALC:DTV:LIM:EVMP:LOW 5
```

Sets the lower limit for the error vector magnitude peak to 5 dB.

Characteristics

RST value: 20.7 dB

SCPI: device-specific

Mode

CATV

CALCulate:DTV:LIMit:EVMPeak:UPPer

This command defines the upper limit of the error vector magnitude peak in % for the Overview / Modulation Errors measurement. If the wrong unit is set, the command produces an execution error. The unit is set via the `CALCulate<1|2>:DTV:UNIT:POWer:EVMPeak` command.

Parameter

0.01 to 100%

Example

```
CALC:DTV:UNIT:POW:EVMP PCT
```

Sets the unit for the error vector magnitude peak to %.

```
CALC:DTV:LIM:EVMP:UPP 1
```

Sets the upper limit for the error vector magnitude peak to 1%.

Characteristics

RST value: 22%

SCPI: device-specific

Mode

CATV

CALCulate:DTV:LIMit:EVMRms:LOWer

This command defines the lower limit of the root mean square value of the error vector magnitude in dB for the Overview / Modulation Errors measurement. If the wrong unit is set, the command produces an execution error. The unit is set via the `CALCulate<1|2>:DTV:UNIT:POWer:EVMRms` command.

Parameter

0 to 80 dB

Example

```
CALC:DTV:UNIT:POW:EVMR dB
```

Sets the unit for the root mean square value of the error vector magnitude to dB.

```
CALC:DTV:LIM:EVMR:LOW 5
```

Sets the lower limit for the root mean square value of the error vector magnitude to 5 dB.

Characteristics

RST value: 27.1 dB

SCPI: device-specific

Mode

CATV

CALCulate:DTV:LIMit:EVMRms:UPPer

This command defines the upper limit of the root mean square value of the error vector magnitude in % for the Overview / Modulation Errors measurement. If the wrong unit is set, the command produces an execution error. The unit is set via the `CALCulate<1|2>:DTV:UNIT:POWer:EVMRms` command.

Parameter

0.01 to 100%

Example

```
CALC:DTV:UNIT:POW:EVMR PCT
```

Sets the unit for the root mean square value of the error vector magnitude to percent.

```
CALC:DTV:LIM:EVMR:UPP 2
```

Sets the upper limit for the root mean square value of the error vector magnitude to 2%.

Characteristics

RST value: 4.4%

SCPI: device-specific

Mode

CATV

CALCulate:DTV:LIMit:IMBalance:LOWer

This command defines the lower limit of the I/Q amplitude imbalance value in the Modulation Errors measurement.

Parameter

-100 to 100%

Example

```
CALC:DTV:LIM:IMB:LOW 7
```

Sets the lower limit for the I/Q amplitude imbalance value to 7%.

Characteristics

RST value: -2%

SCPI: device-specific

Mode

CATV

CALCulate:DTV:LIMit:IMBalance:UPPer

This command defines the upper limit of the I/Q amplitude imbalance value in the Modulation Errors measurement.

Parameter

-100 to 100%

Example

```
CALC:DTV:LIM:IMB:UPP 10
```

Sets the upper limit for the I/Q amplitude imbalance value to 10%.

Characteristics

RST value: 2%

SCPI: device-specific

Mode

CATV

CALCulate:DTV:LIMit:MERPeak:LOWer

This command defines the lower limit of the modulation error rate peak in dB for the Overview / Modulation Errors measurement. If the wrong unit is set, the command produces an execution error. The unit is set via the `CALCulate<1|2>:DTV:UNIT:POWer:MERPeak` command.

Parameter

0 to 80 dB

Example

```
CALC:DTV:UNIT:POW:MERP DB
```

Sets the unit for the unit of the modulation error rate peak to dB.

```
CALC:DTV:LIM:MERP:LOW 15
```

Sets the lower limit for the modulation error rate peak to 15 dB.

Characteristics

RST value: 10 dB

SCPI: device-specific

Mode

CATV

CALCulate:DTV:LIMit:MERPeak:UPPer

This command defines the upper limit of the modulation error rate peak in % for the Overview / Modulation Errors measurement. If the wrong unit is set, the command produces an execution error. The unit is set via the `CALCulate<1|2>:DTV:UNIT:POWer:MERPeak` command.

Parameter

0.01 to 100%

Example

```
CALC:DTV:UNIT:POW:MERP PCT
```

Sets the unit for the unit of the modulation error rate peak to percent.

```
CALC:DTV:LIM:MERP:UPP 20
```

Sets the upper limit for the modulation error rate peak to 20%.

Characteristics

RST value: 3.2%

SCPI: device-specific

Mode

CATV

CALCulate:DTV:LIMit:MERRms:LOWer

This command defines the lower limit of the root mean square value of the modulation error rate in dB for the Overview / Modulation Errors measurement. If the wrong unit is set, the command produces an execution error. The unit is set via the `CALCulate<1|2>:DTV:UNIT:POWer:MERRms` command.

Parameter

0 to 80 dB

Example

```
CALC:DTV:UNIT:POW:MERR DB
```

Sets the unit for the root mean square value of the modulation error rate to dB.

```
CALC:DTV:LIM:MERR:LOW 20
```

Sets the lower limit for the root mean square value of the modulation error rate to 20 dB.

Characteristics

RST value: 24 dB

SCPI: device-specific

Mode

CATV

CALCulate:DTV:LIMit:MERRms:UPPer

This command defines the upper limit of the root mean square value of the modulation error rate in % for the Overview / Modulation Errors measurement. If the wrong unit is set, the command produces an execution error. The unit is set via the [CALCulate<1|2>:DTV:UNIT:POWer:MERRms](#) command.

Parameter

0.01 to 100%

Example

```
CALC:DTV:UNIT:POW:MERR PCT
```

Sets the unit for the root mean square value of the modulation error rate to %.

```
CALC:DTV:LIM:MERR:UPP 30
```

Sets the upper limit for the root mean square value of the modulation error rate to 30%.

Characteristics

RST value: 6.3%

SCPI: device-specific

Mode

CATV

CALCulate:DTV:LIMit:PJITter[:UPPer]

This command defines the upper limit of the phase jitter (root mean square value of the phase error) in the Modulation Errors measurement.

Parameter

0° to 180°

Example

```
CALC:DTV:LIM:PJIT 1
```

Sets the upper limit for the phase jitter to 1 deg.

Characteristics

RST value: 2 deg

SCPI: device-specific

Mode

CATV

CALCulate:DTV:LIMit:QERRor:LOWer

This command defines the lower limit of the quadrature error in the Modulation Errors measurement.

Parameter

-180° to 180°

Example

```
CALC:DTV:LIM:QERR:LOW 10
```

Sets the lower limit for the quadrature error to 10 deg.

Characteristics

RST value: -2 deg

SCPI: device-specific

Mode

CATV

CALCulate:DTV:LIMit:QERRor:UPPer

This command defines the upper limit of the quadrature error in the Modulation Errors measurement.

Parameter

-180° to 180°

Example

```
CALC:DTV:LIM:QERR:UPP 20
```

Sets the upper limit for the quadrature error to 20 deg.

Characteristics

RST value: +2 deg

SCPI: device-specific

Mode

CATV

CALCulate:DTV:LIMit:SROffset:LOWer

This command defines the lower limit of the symbol rate offset in the Overview measurement.

Parameter

-99,999 to 99,999 symb/s

Example

```
CALC:DTV:LIM:SROF:LOW -5000
```

Sets the lower limit for the symbol rate offset to -5000 symb/s.

Characteristics

RST value: -10000 symb/s

SCPI: device-specific

Mode

CATV

CALCulate:DTV:LIMit:SROffset:UPPer

This command defines the upper limit of the symbol rate offset in the Overview measurement.

Parameter

-99,999 to 99,999 symb/s

Example

```
CALC:DTV:LIM:SROF:UPP 1000
```

Sets the upper limit for the symbol rate offset to 1000 symb/s.

Characteristics

RST value: 10000 symb/s

SCPI: device-specific

Mode

CATV

CALCulate:DTV:LIMit:RESult Subsystem (CATV, K20)

The CALCulate:DTV:LIMit:RESult subsystem checks the measurement limits for digital TV measurements.

Commands of the CALCulate:DTV:LIMit:RESult Subsystem

- CALCulate:DTV:LIMit:RESult:CFOffset:LOWer?
- CALCulate:DTV:LIMit:RESult:CFOffset:UPPer?
- CALCulate:DTV:LIMit:RESult:CHPower?
- CALCulate:DTV:LIMit:RESult:CSUPpression[:LOWer]?
- CALCulate:DTV:LIMit:RESult:EVMPeak:LOWer?
- CALCulate:DTV:LIMit:RESult:EVMPeak:UPPer?
- CALCulate:DTV:LIMit:RESult:EVMRms:LOWer?
- CALCulate:DTV:LIMit:RESult:EVMRms:UPPer?
- CALCulate:DTV:LIMit:RESult:IMBalance:LOWer?
- CALCulate:DTV:LIMit:RESult:IMBalance:UPPer?
- CALCulate:DTV:LIMit:RESult:MERPeak:LOWer?
- CALCulate:DTV:LIMit:RESult:MERPeak:UPPer?
- CALCulate:DTV:LIMit:RESult:MERRms:LOWer?
- CALCulate:DTV:LIMit:RESult:MERRms:UPPer?
- CALCulate:DTV:LIMit:RESult:PJITter[:UPPer]?
- CALCulate:DTV:LIMit:RESult:QERRor:LOWer?
- CALCulate:DTV:LIMit:RESult:QERRor:UPPer?
- CALCulate:DTV:LIMit:RESult:SROffset:LOWer?
- CALCulate:DTV:LIMit:RESult:SROffset:UPPer?

CALCulate:DTV:LIMit:RESult:CFOffset:LOWer?

This command performs a lower limit check for the carrier frequency offset in the Overview measurement.

This command is a query and therefore has no *RST value.

Example

```
CALC:DTV:LIM:CFOF:LOW -10KHZ
```

Sets the lower limit for the carrier frequency offset to -10 kHz.

```
INIT;*WAI
```

Starts a new measurement and waits for the sweep end.

```
CALC:DTV:LIM:RES:CFOF:LOW?
```

Performs a lower limit check for the carrier frequency offset.

Characteristics

RST value: -

SCPI: device-specific

Mode

CATV

CALCulate:DTV:LIMit:RESult:CFOffset:UPPer?

This command performs an upper limit check for the carrier frequency offset in the Overview measurement.

This command is a query and therefore has no *RST value.

Example

```
CALC:DTV:LIM:CFOF:UPP 20KHZ
```

Sets the upper limit for the carrier frequency offset to 20 kHz.

```
INIT;*WAI
```

Starts a new measurement and waits for the sweep end.

```
CALC:DTV:LIM:RES:CFOF:UPP?
```

Performs an upper limit check for the carrier frequency offset.

Characteristics

RST value: -

SCPI: device-specific

Mode

CATV

CALCulate:DTV:LIMit:RESult:CHPower?

This command queries the result of the Channel Power measurement. Upper and lower limit check can not be handled separately.

Example

```
CALC:DTV:LIM:CHP:UPP -18
```

Sets the upper limit for the Channel Power measurement to -18 dBm.

```
CALC:DTV:LIM:CHP:LOW -22
```

Sets the lower limit for the Channel Power measurement to -22 dBm.

```
INIT;*WAI
```

Starts a new measurement and waits for the sweep end.

```
CALC:DTV:LIM:RES:CHP?
```

Performs a limit check for the Channel Power measurement.

Characteristics

RST value: -

SCPI: device-specific

Mode

CATV

CALCulate:DTV:LIMit:RESult:CSUPpression[:LOWer]?

This command performs a lower limit check for the lower limit of the carrier suppression in the Modulation Errors measurement.

This command is a query and therefore has no *RST value.

Example

```
CALC:DTV:LIM:CSUP 30
```

Sets the lower limit for the carrier suppression to 30 dB.

```
INIT;*WAI
```

Starts a new measurement and waits for the sweep end.

```
CALC:DTV:LIM:RES:CSUP?
```

Performs a lower limit check for the lower limit of the carrier suppression.

Characteristics

RST value: -

SCPI: device-specific

Mode

CATV

CALCulate:DTV:LIMit:RESult:EVMPeak:LOWer?

This command performs an lower limit check for the error vector magnitude peak in the Overview measurement.

This command is a query and therefore has no *RST value.

Example

```
CALC:DTV:LIM:EVMP:LOW 5DB
```

Sets the lower limit for the error vector magnitude peak to 5 dB.

```
INIT;*WAI
```

Starts a new measurement and waits for the sweep end.

```
CALC:DTV:LIM:RES:EVMP:LOW?
```

Performs an lower limit check for the error vector magnitude peak.

Characteristics

RST value: -

SCPI: device-specific

Mode

CATV

CALCulate:DTV:LIMit:RESult:EVMPeak:UPPer?

This command performs an upper limit check for the error vector magnitude peak in the Overview measurement.

This command is a query and therefore has no *RST value.

Example

```
CALC:DTV:LIM:EVMP:UPP 1PCT
```

Sets the upper limit for the error vector magnitude peak to 1%.

```
INIT;*WAI
```

Starts a new measurement and waits for the sweep end.

```
CALC:DTV:LIM:RES:EVMP:UPP?
```

Performs an upper limit check for the error vector magnitude peak.

Characteristics

RST value: -

SCPI: device-specific

Mode

CATV

CALCulate:DTV:LIMit:RESult:EVMRms:LOWer?

This command performs a lower limit check for the root mean square value of the error vector magnitude in the Overview measurement.

This command is a query and therefore has no *RST value.

Example

```
CALC:DTV:LIM:EVMR:LOW 5DB
```

Sets the lower limit for the root mean square value of the error vector magnitude to 5 dB.

```
INIT;*WAI
```

Starts a new measurement and waits for the sweep end.

```
CALC:DTV:LIM:RES:EVMR:LOW?
```

Performs an lower limit check for the root mean square value of the error vector magnitude.

Characteristics

RST value: -

SCPI: device-specific

Mode

CATV

CALCulate:DTV:LIMit:RESult:EVMRms:UPPer?

This command performs an upper limit check for the root mean square value of the error vector magnitude in the Overview measurement.

This command is a query and therefore has no *RST value.

Example

```
CALC:DTV:LIM:EVMR:UPP 2PCT
```

Sets the upper limit for the root mean square value of the error vector magnitude to 2%.

```
INIT;*WAI
```

Starts a new measurement and waits for the sweep end.

```
CALC:DTV:LIM:RES:EVMR:UPP?
```

Performs an upper limit check for the root mean square value of the error vector magnitude.

Characteristics

RST value: -

SCPI: device-specific

Mode

CATV

CALCulate:DTV:LIMit:RESult:IMBalance:LOWer?

This command performs a lower limit check for the I/Q amplitude imbalance value in the Modulation Errors measurement.

This command is a query and therefore has no *RST value.

Example

```
CALC:DTV:LIM:IMB:LOW 7
```

Sets the lower limit for the I/Q amplitude imbalance value to 7%.

```
INIT;*WAI
```

Starts a new measurement and waits for the sweep end.

```
CALC:DTV:LIM:RES:IMB:LOW?
```

Performs a lower limit check for the I/Q amplitude imbalance value.

Characteristics

RST value: -

SCPI: device-specific

ModeCATV

CALCulate:DTV:LIMit:RESult:IMBalance:UPPer?

This command performs an upper limit check for the I/Q amplitude imbalance value in the Modulation Errors measurement.

This command is a query and therefore has no *RST value.

Example

```
CALC:DTV:LIM:IMB:UPP 10
```

Sets the upper limit for the I/Q amplitude imbalance value to 10%.

```
INIT;*WAI
```

Starts a new measurement and waits for the sweep end.

```
CALC:DTV:LIM:RES:IMB:UPP?
```

Performs an upper limit check for the I/Q amplitude imbalance value.

Characteristics

RST value: -

SCPI: device-specific

ModeCATV

CALCulate:DTV:LIMit:RESult:MERPeak:LOWer?

This command performs a lower limit check for the modulation error rate peak in the Overview measurement.

This command is a query and therefore has no *RST value.

Example

```
CALC:DTV:LIM:MERP:LOW 20
```

Sets the lower limit for the modulation error rate peak to 20 dB.

```
INIT;*WAI
```

Starts a new measurement and waits for the sweep end.

```
CALC:DTV:LIM:RES:MERP:LOW?
```

Performs a lower limit check for the modulation error rate peak.

Characteristics

RST value: -

SCPI: device-specific

ModeCATV

CALCulate:DTV:LIMit:RESult:MERPeak:UPPer?

This command performs an upper limit check for the modulation error rate peak in the Overview measurement.

This command is a query and therefore has no *RST value.

Example

```
CALC:DTV:LIM:MERP:UPP 20
```

Sets the upper limit for the modulation error rate peak to 20%.

```
INIT;*WAI
```

Starts a new measurement and waits for the sweep end.

```
CALC:DTV:LIM:RES:MERP:UPP?
```

Performs an upper limit check for the modulation error rate peak.

Characteristics

RST value: -

SCPI: device-specific

Mode

CATV

CALCulate:DTV:LIMit:RESult:MERRms:LOWer?

This command performs a lower limit check for the root mean square value of the modulation error rate in the Overview measurement.

This command is a query and therefore has no *RST value.

Example

```
CALC:DTV:LIM:MERR:LOW 30
```

Sets the lower limit for the root mean square value of the modulation error rate to 30 dB.

```
INIT;*WAI
```

Starts a new measurement and waits for the sweep end.

```
CALC:DTV:LIM:RES:MERR:LOW?
```

Performs a lower limit check for the root mean square value of the modulation error rate.

Characteristics

RST value: -

SCPI: device-specific

Mode

CATV

CALCulate:DTV:LIMit:RESult:MERRms:UPPer?

This command performs an upper limit check for the root mean square value of the modulation error rate in the Overview measurement.

This command is a query and therefore has no *RST value.

Example

```
CALC:DTV:LIM:MERR:UPP 30
```

Sets the upper limit for the root mean square value of the modulation error rate to 30%.

```
INIT;*WAI
```

Starts a new measurement and waits for the sweep end.

```
CALC:DTV:LIM:RES:MERR:UPP?
```

Performs an upper limit check for the root mean square value of the modulation error rate.

Characteristics

RST value: -

SCPI: device-specific

Mode

CATV

CALCulate:DTV:LIMit:RESult:PJITter[:UPPer]?

This command performs an upper limit check for the phase jitter in the Modulation Errors measurement.

This command is a query and therefore has no *RST value.

Example

```
CALC:DTV:LIM:PJIT 1
```

Sets the upper limit for the phase jitter to 1 deg.

```
INIT;*WAI
```

Starts a new measurement and waits for the sweep end.

```
CALC:DTV:LIM:RES:PJIT?
```

Performs an upper limit check for the phase jitter.

Characteristics

RST value: -

SCPI: device-specific

Mode

CATV

CALCulate:DTV:LIMit:RESult:QERRor:LOWer?

This command performs a lower limit check for the quadrature error in the Modulation Errors measurement.

This command is a query and therefore has no *RST value.

Example

```
CALC:DTV:LIM:QERR:LOW 10
```

Sets the lower limit for the quadrature error to 10 deg.

```
INIT;*WAI
```

Starts a new measurement and waits for the sweep end.

```
CALC:DTV:LIM:RES:QERR:LOW?
```

Performs a lower limit check for the quadrature error.

Characteristics

RST value: -

SCPI: device-specific

Mode

CATV

CALCulate:DTV:LIMit:RESult:QERRor:UPPer?

This command performs an upper limit check for the quadrature error in the Modulation Errors measurement.

This command is a query and therefore has no *RST value.

Example

```
CALC:DTV:LIM:QERR:UPP 20
```

Sets the upper limit for the quadrature error to 20 deg.

```
INIT;*WAI
```

Starts a new measurement and waits for the sweep end.

```
CALC:DTV:LIM:RES:QERR:UPP?
```

Performs an upper limit check for the quadrature error.

Characteristics

RST value: -

SCPI: device-specific

Mode

CATV

CALCulate:DTV:LIMit:RESult:SROffset:LOWer?

This command performs a lower limit check for the symbol rate offset in the Overview measurement.

This command is a query and therefore has no *RST value.

Example

```
CALC:DTV:LIM:SROF:LOW -5000
```

Sets the lower limit for the symbol rate offset to -5000 symb/s.

```
INIT;*WAI
```

Starts a new measurement and waits for the sweep end.

```
CALC:DTV:LIM:RES:SROF:LOW?
```

Performs a lower limit check for the symbol rate offset.

Characteristics

RST value: -10000

SCPI: device-specific

Mode

CATV

CALCulate:DTV:LIMit:RESult:SROffset:UPPer?

This command performs an upper limit check for the symbol rate offset in the Overview measurement.

This command is a query and therefore has no *RST value.

Example

```
CALC:DTV:LIM:SROF:UPP 1000
```

Sets the upper limit for the symbol rate offset to 1000 symb/s.

```
INIT;*WAI
```

Starts a new measurement and waits for the sweep end.

```
CALC:DTV:LIM:RES:SROF:UPP?
```

Performs an upper limit check for the symbol rate offset.

Characteristics

RST value: 10000

SCPI: device-specific

Mode

CATV

CALCulate:DTV:RESult Subsystem (CATV, K20)

The CALCulate:DTV:RESult subsystem displays the measurement results for digital TV measurements.

Commands of the CALCulate:DTV:RESult Subsystem

- [CALCulate<1|2>:DTV:RESult?](#)

CALCulate<1|2>:DTV:RESult?

This command reads the measurement values for the digital TV measurements.

The numeric suffixes <1|2> are irrelevant.

This command is a query only and thus has no *RST value.

Parameter

Spectrum	SALower	lower shoulder attenuation
	SAUPper	upper shoulder attenuation
Overview	MERRms	root mean square of the modulation error rate
	MERPeak	peak of the modulation error rate
	EVMRms	root mean square of the error vector magnitude
	EVMPeak	peak of the error vector magnitude
	CFOffset	carrier frequency offset
	SROffset	symbol rate offset
	ALL	Results of all measurements above, separated by commas. If a measurement result is not valid, a comma will be output only.
Modulation Errors	IMBalance	amplitude imbalance
	QERRor	quadrature error
	CSUPpression	carrier suppression
	PJITter	phase jitter
	ALL	Results of all measurements above, separated by commas. If a measurement result is not valid, a comma will be output only.

Example

```
CONF:DTV:MEAS MERR
```

Configures the digital TV Modulation Errors measurement.

```
INIT;*WAI
```

Starts a new measurement and waits for the sweep end.

```
CALC:DTV:RES? QERR
```

Reads the result (quadrature error) of the Modulation Errors measurement.

or

```
CALC:DTV:RES? ALL
```

Reads all measured values.

Characteristics

RST value: -

SCPI: device-specific

Mode

CATV

CALCulate:DTV:UNIT:POWer Subsystem (CATV, K20)

The CALCulate:DTV:UNIT:POWer subsystem sets the unit for the measurements for digital TV measurements.

Commands of the CALCulate:DTV:UNIT:POWer Subsystem

- CALCulate<1|2>:DTV:UNIT:POWer:EPATtern
- CALCulate<1|2>:DTV:UNIT:POWer:EVMPeak
- CALCulate<1|2>:DTV:UNIT:POWer:EVMRms
- CALCulate<1|2>:DTV:UNIT:POWer:MERPeak
- CALCulate<1|2>:DTV:UNIT:POWer:MERRms

CALCulate<1|2>:DTV:UNIT:POWer:EPATtern

This command defines the unit of the Echo Pattern measurement.

The numeric suffixes <1|2> are irrelevant.

Parameter

s | m

Example

```
CALC:DTV:UNIT:POW:EPAT M
```

Sets the unit for the Echo Pattern measurement to meters.

Characteristics

RST value: s (seconds)

SCPI: device-specific

Mode

CATV

CALCulate<1|2>:DTV:UNIT:POWer:EVMPeak

This command defines the unit of the error vector magnitude peak in the Overview / Modulation Errors measurement.

The numeric suffixes <1|2> are irrelevant.

Parameter

DB | PCT

Example

```
CALC:DTV:UNIT:POW:EVMP DB
```

Sets the unit for the error vector magnitude peak to dB.

Characteristics

RST value: % (PCT)

SCPI: device-specific

Mode

CATV

CALCulate<1|2>:DTV:UNIT:POWer:EVMRms

This command defines the unit of the root mean square value of the error vector magnitude in the Overview / Modulation Errors measurement.

The numeric suffixes <1|2> are irrelevant.

Parameter

DB | PCT

Example

```
CALC:DTV:UNIT:POW:EVMR PCT
```

Sets the unit for the root mean square value of the error vector magnitude to percent.

Characteristics

RST value: dB

SCPI: device-specific

Mode

CATV

CALCulate<1|2>:DTV:UNIT:POWer:MERPeak

This command defines the unit of the modulation error rate peak in the Overview / Modulation Errors measurement.

The numeric suffixes <1|2> are irrelevant.

Parameter

DB | PCT

Example

```
CALC:DTV:UNIT:POW:MERP PCT
```

Sets the unit for the unit of the modulation error rate peak to percent.

Characteristics

RST value: dB

SCPI: device-specific

Mode

CATV

CALCulate<1|2>:DTV:UNIT:POWer:MERRms

This command defines the unit of the root mean square value of the modulation error rate in the Overview / Modulation Errors measurement.

The numeric suffixes <1|2> are irrelevant.

Parameter

DB | PCT

Example

```
CALC:DTV:UNIT:POW:MERR DB
```

Sets the unit for the root mean square value of the modulation error rate to dB.

Characteristics

RST value: % (PCT)

SCPI: device-specific

Mode

CATV

CALCulate:MARKer Subsystem (CATV, K20)

The CALCulate:MARKer subsystem checks the marker functions of the instrument.

The following subsystem is included:

- "CALCulate:MARKer:FUNCTION Subsystem (CATV, K20)" on page 6.462

Commands of the CALCulate:MARKer Subsystem

- CALCulate<1|2>:MARKer<1...4>[:STATe]
- CALCulate<1|2>:MARKer<1...4>:AOFF
- CALCulate<1|2>:MARKer<1...4>:LOEXclude
- CALCulate<1|2>:MARKer<1...4>:MAXimum[:PEAK]
- CALCulate<1|2>:MARKer<1...4>:MAXimum:LEFT
- CALCulate<1|2>:MARKer<1...4>:MAXimum:NEXT
- CALCulate<1|2>:MARKer<1...4>:MAXimum:RIGHT
- CALCulate<1|2>:MARKer<1...4>:MINimum[:PEAK]
- CALCulate<1|2>:MARKer<1...4>:MINimum:LEFT
- CALCulate<1|2>:MARKer<1...4>:MINimum:NEXT
- CALCulate<1|2>:MARKer<1...4>:MINimum:RIGHT
- CALCulate<1|2>:MARKer<1...4>:PEXCursion
- CALCulate<1|2>:MARKer<1...4>:TRACe
- CALCulate<1|2>:MARKer<1...4>:X
- CALCulate<1|2>:MARKer<1...4>:X:SLIMits:LEFT
- CALCulate<1|2>:MARKer<1...4>:X:SLIMits:RIGHT
- CALCulate<1|2>:MARKer<1...4>:X:SLIMits[:STATe]
- CALCulate<1|2>:MARKer<1...4>:Y?
- CALCulate<1|2>:MARKer<1...4>:Y:PERCent

CALCulate<1|2>:MARKer<1...4>[:STATe]

For details refer to "CALCulate<1|2>:MARKer<1...4>[:STATe]" on page 6.55.

CALCulate<1|2>:MARKer<1...4>:AOFF

For details refer to "CALCulate<1|2>:MARKer<1...4>:AOFF" on page 6.56.

CALCulate<1|2>:MARKer<1...4>:LOEXclude

For details refer to "CALCulate<1|2>:MARKer<1...4>:LOEXclude" on page 6.58.

CALCulate<1|2>:MARKer<1...4>:MAXimum[:PEAK]

For details refer to "CALCulate<1|2>:MARKer<1...4>:MAXimum[:PEAK]" on page 6.58.

CALCulate<1|2>:MARKer<1...4>:MAXimum:LEFT

For details refer to "[CALCulate<1|2>:MARKer<1...4>:MAXimum:LEFT](#)" on page 6.59.

CALCulate<1|2>:MARKer<1...4>:MAXimum:NEXT

For details refer to "[CALCulate<1|2>:MARKer<1...4>:MAXimum:NEXT](#)" on page 6.59.

CALCulate<1|2>:MARKer<1...4>:MAXimum:RIGHT

For details refer to "[CALCulate<1|2>:MARKer<1...4>:MAXimum:RIGHT](#)" on page 6.60.

CALCulate<1|2>:MARKer<1...4>:MINimum[:PEAK]

For details refer to "[CALCulate<1|2>:MARKer<1...4>:MINimum\[:PEAK\]](#)" on page 6.60.

CALCulate<1|2>:MARKer<1...4>:MINimum:LEFT

For details refer to "[CALCulate<1|2>:MARKer<1...4>:MINimum:LEFT](#)" on page 6.61.

CALCulate<1|2>:MARKer<1...4>:MINimum:NEXT

For details refer to "[CALCulate<1|2>:MARKer<1...4>:MINimum:NEXT](#)" on page 6.62.

CALCulate<1|2>:MARKer<1...4>:MINimum:RIGHT

For details refer to "[CALCulate<1|2>:MARKer<1...4>:MINimum:RIGHT](#)" on page 6.62.

CALCulate<1|2>:MARKer<1...4>:PEXCursion

For details refer to "[CALCulate<1|2>:MARKer<1...4>:PEXCursion](#)" on page 6.63.

CALCulate<1|2>:MARKer<1...4>:TRACe

Parameter

1 to 4

For further details refer to "[CALCulate<1|2>:MARKer<1...4>:TRACe](#)" on page 6.63.

CALCulate<1|2>:MARKer<1...4>:X

For details refer to "[CALCulate<1|2>:MARKer<1...4>:X](#)" on page 6.63.

CALCulate<1|2>:MARKer<1...4>:X:SLIMits:LEFT

For details refer to "[CALCulate<1|2>:MARKer<1...4>:X:SLIMits:LEFT](#)" on page 6.64.

CALCulate<1|2>:MARKer<1...4>:X:SLIMits:RIGHT

For details refer to "[CALCulate<1|2>:MARKer<1...4>:X:SLIMits:RIGHT](#)" on page 6.65.

CALCulate<1|2>:MARKer<1...4>:X:SLIMits[:STATe]

For details refer to "[CALCulate<1|2>:MARKer<1...4>:X:SLIMits\[:STATe\]](#)" on page 6.64.

CALCulate<1|2>:MARKer<1...4>:Y?

For details refer to "[CALCulate<1|2>:MARKer<1...4>:Y?](#)" on page 6.66.

CALCulate<1|2>:MARKer<1...4>:Y:PERCent

For details refer to "[CALCulate<1|2>:MARKer<1...4>:Y:PERCent](#)" on page 6.66.

CALCulate:MARKer:FUNCTion Subsystem (CATV, K20)

The CALCulate:MARKer:FUNCTion subsystem checks the marker functions in the instrument.

Commands of the CALCulate:MARKer:FUNCTion Subsystem

- [CALCulate<1|2>:MARKer<1...4>:FUNCTion:CENTer](#)
- [CALCulate<1|2>:MARKer<1...4>:FUNCTion:REFerence](#)

CALCulate<1|2>:MARKer<1...4>:FUNCTion:CENTer

For details refer to "[CALCulate<1|2>:MARKer<1...4>:FUNCTion:CENTer](#)" on page 6.69.

CALCulate<1|2>:MARKer<1...4>:FUNCTion:REFerence

For details refer to "[CALCulate<1|2>:MARKer<1...4>:FUNCTion:REFerence](#)" on page 6.78.

CALCulate:STATistics Subsystem (CATV, K20)

The CALCulate: STATistics subsystem defines the scaling for the APD and CCDF measurements.

Commands of the CALCulate: STATistics Subsystem

- [CALCulate: STATistics:NSAMples](#)
- [CALCulate:STATistics:PRESet](#)
- [CALCulate:STATistics:RESult<1...4>?](#)
- [CALCulate:STATistics:SCALE:AUTO](#)
- [CALCulate:STATistics:SCALE:X:RANGe](#)
- [CALCulate:STATistics:SCALE:X:RLEVel](#)
- [CALCulate:STATistics:SCALE:Y:LOWer](#)
- [CALCulate:STATistics:SCALE:Y:UPPer](#)

CALCulate: STATistics:NSAMples

For details refer to "[CALCulate:STATistics:NSAMples](#)" on page 6.111.

CALCulate:STATistics:PRESet

For details refer to "[CALCulate:STATistics:PRESet](#)" on page 6.111.

CALCulate:STATistics:RESult<1...4>?

For details refer to "[CALCulate:STATistics:RESult<1...6>?](#)" on page 6.111.

CALCulate:STATistics:SCALE:AUTO

For details refer to "[CALCulate:STATistics:SCALE:AUTO](#)" on page 6.112.

CALCulate:STATistics:SCALE:X:RANGe

For details refer to "[CALCulate:STATistics:SCALE:X:RANGe](#)" on page 6.112.

CALCulate:STATistics:SCALE:X:RLEVel

For details refer to "[CALCulate:STATistics:SCALE:X:RLEVel](#)" on page 6.113.

CALCulate:STATistics:SCALE:Y:LOWer

For details refer to "[CALCulate:STATistics:SCALE:Y:LOWer](#)" on page 6.113.

CALCulate:STATistics:SCALE:Y:UPPer

For details refer to "[CALCulate:STATistics:SCALE:Y:UPPer](#)" on page 6.114.

CALCulate:UNIT Subsystem (CATV, K20)

The CALCulate:UNIT subsystem defines the units for the parameters that can be set and the measurement results.

Commands of the CALCulate:UNIT Subsystem

- [CALCulate<1|2>:UNIT:POWER](#)

CALCulate<1|2>:UNIT:POWER

This command selects the unit for power.
The numeric suffixes <1|2> are irrelevant.

Parameter

DBM | DBUV | DBMV | DBPW | VOLT | V | W | WATT | A | AMPere

Example

```
CALC:UNIT:POW V  
Sets the unit to Volt.
```

Characteristics

RST value: dBm

SCPI: device-specific

Mode

CATV

CONFigure Subsystem (CATV, K20)

The CONFigure subsystem contains commands for configuring complex measurement tasks.

The following subsystems are included:

- ["CONFigure:ATV Subsystem \(CATV, K20\)"](#) on page 6.465
- ["CONFigure:DTV Subsystem \(CATV, K20\)"](#) on page 6.468
- ["CONFigure:TV Subsystem \(CATV, K20\)"](#) on page 6.469

CONFigure:ATV Subsystem (CATV, K20)

The CONFigure:ATV subsystem contains commands to configure analog TV measurements.

Commands of the CONFigure:ATV Subsystem

- [CONFigure:ATV:CN:MEASurement](#)
- [CONFigure:ATV:CSO:MEASurement](#)
- [CONFigure:ATV:CTB:MEASurement](#)
- [CONFigure:ATV:MEASurement](#)

CONFigure:ATV:CN:MEASurement

This command configures a new carrier or noise measurement with the next sweep for the Carrier-to-Noise Ratio measurement.

Parameter

CARRier | NOISe

Example

```
CONF:ATV:MEAS CN
```

Configures the analog TV Carrier-to-Noise Ratio measurement.

```
ATV:CN:MEAS:MODE OSER
```

Sets the Off-Service measurement method.

```
CONF:ATV:CN:MEAS CARR
```

Configures a new carrier measurement with the next sweep.

```
INIT;*OPC
```

Starts the new noise measurement.

Characteristics

RST value: CARRier

SCPI: device-specific

Mode

CATV

CONFigure:ATV:CSO:MEASurement

This command configures a new carrier or noise measurement with the next sweep for the Carrier-to-Second Order Beat Ratio measurement.

Parameter

CARRier | NOISe

Example

```
CONF:ATV:MEAS CSO
```

Configures the analog TV Carrier-to-Second Order Beat Ratio measurement.

```
ATV:CSO:MEAS:MODE OSER
```

Sets the Off-Service measurement method.

```
CONF:ATV:CSO:MEAS CARR
```

Configures a new carrier measurement with the next sweep.

```
INIT;*OPC
```

Starts the new noise measurement.

Characteristics

RST value: CARRier

SCPI: device-specific

Mode

CATV

CONFigure:ATV:CTB:MEASurement

This command configures a new carrier or noise measurement with the next sweep for the Carrier-to-Composite Triple Beat Ratio measurement.

Parameter

CARRier | NOISe

Example

```
CONF:ATV:MEAS CTB
```

Configures the analog TV Carrier-to-Composite Triple Beat Ratio measurement.

```
ATV:CTB:MEAS:MODE OSER
```

Sets the Off-Service measurement method.

```
CONF:ATV:CTB:MEAS CARR
```

Configures a new carrier measurement with the next sweep.

```
INIT;*OPC
```

Starts the new noise measurement.

Characteristics

RST value: CARRier

SCPI: device-specific

Mode

CATV

CONFigure:ATV:MEASurement

This command defines the analog measurement type.

Parameter

ASpectrum	Spectrum measurement
CARRiers	Carrier Power measurement
CN	Carrier-to-Noise Ratio measurement
HUM	Hum measurement
VMODulation	Vision Modulation measurement
CTB	Carrier-to-Composite Triple Beat Ratio measurement
CSO	Carrier-to-Second Order Beat Ratio measurement
VSCOpe	Video Scope measurement

Example

```
CONF:ATV:MEAS CARR
```

Configures the R&S FSL to measure the carrier power.

Characteristics

RST value: ASpectrum

SCPI: device-specific

Mode

CATV

CONFigure:DTV Subsystem (CATV, K20)

The CONFigure:DTV subsystem contains commands to configure digital TV measurements.

Commands of the CONFigure:DTV:MEASurement Subsystem

- [CONFigure:DTV:MEASurement](#)
- [CONFigure:DTV:MEASurement:SATTenuation](#)

CONFigure:DTV:MEASurement

This command defines the digital measurement type.

Parameter

DSPectrum	Spectrum measurement
CHPower	Channel Power measurement
CONS	Constellation Diagram measurement
MERRors	Modulation Errors measurement
EPATtern	Echo Pattern measurement
APD	Amplitude Probability Density Function measurement
CCDF	Complementary Cumulative Distribution Function measurement
OVERview	Overview measurement

Example

```
CONF:DTV:MEAS APD
```

Configures the R&S FSL to measure the amplitude probability density function.

Characteristics

RST value: DSP

SCPI: device-specific

Mode

CATV

CONFigure:DTV:MEASurement:SATTenuation

This command activates or deactivates the shoulder measurement in accordance to ETSI TR 101290 standard.

Parameter

ON | OFF

Example

```
CONF:DTV:MEAS:SATT OFF
```

Configures the R&S FSL to measure the upper and lower shoulder attenuation.

Characteristics

RST value: ON

SCPI: device-specific

Mode

CATV

CONFigure:TV Subsystem (CATV, K20)

The CONFigure:TV subsystem contains commands to configure TV Analyzer measurements.

Commands of the CONFigure:TV Subsystem

- [CONFigure:TV:CTABLE:SElect](#)
- [CONFigure:TV:MEASurement](#)

CONFigure:TV:CTABLE:SElect

This command activates the selected channel table.

Parameter

<file_name>, max. 45 characters

Example

```
CONF:TV:CTAB:SEL 'TV-ITALY'
```

Activates the channel table TV-ITALY.

Characteristics

RST value: <none>

SCPI: device-specific

Mode

CATV

CONFigure:TV:MEASurement

This command defines the TV Analyzer measurement type.

Parameter

TILT (Tilt measurement)

Example

```
CONF:TV:MEAS TILT
```

Configures the R&S FSL to measure the channel power of every channel.

Characteristics

RST value: -

SCPI: device-specific

Mode

CATV

DISPlay Subsystem (CATV, K20)

The DISPlay subsystem controls the selection and presentation of textual and graphic information as well as of measurement data on the display.

Commands of the DISPlay Subsystem

- DISPlay[:WINDow<1|2>]:TRACe<1...4>[:STATe]
- DISPlay[:WINDow<1|2>]:TRACe<1...4>:MODE
- DISPlay[:WINDow<1|2>]:TRACe<1...4>:MODE:FREeze[:STATe]
- DISPlay[:WINDow<1|2>]:TRACe<1...4>:MODE:HCONtinuous
- DISPlay[:WINDow<1|2>]:TRACe<1...4>:Y[:SCALe]
- DISPlay[:WINDow<1|2>]:TRACe<1...4>:Y[:SCALe]:AUTO
- DISPlay[:WINDow<1|2>]:TRACe<1...4>:Y[:SCALe]:MODE
- DISPlay[:WINDow<1|2>]:TRACe<1...4>:Y[:SCALe]:RLEVel
- DISPlay[:WINDow<1|2>]:TRACe<1...4>:Y[:SCALe]:RLEVel:OFFSet
- DISPlay[:WINDow<1|2>]:TRACe<1...4>:Y[:SCALe]:RPOSition
- DISPlay[:WINDow<1|2>]:TRACe<1...4>:Y:SPACing
- DISPlay[:WINDow<1|2>]:ZOOM:EPATtern
- DISPlay[:WINDow<1|2>]:ZOOM:EPATtern:STATe
- DISPlay[:WINDow<1|2>]:ZOOM:MERRors
- DISPlay[:WINDow<1|2>]:ZOOM:OVERview
- DISPlay[:WINDow<1|2>]:ZOOM:QUADrant

DISPlay[:WINDow<1|2>]:TRACe<1...4>[:STATe]

The numeric suffixes <1...4> select the trace.

For further details refer to "DISPlay[:WINDow<1|2>]:TRACe<1...6>[:STATe]" on page 6.130.

DISPlay[:WINDow<1|2>]:TRACe<1...4>:MODE

The numeric suffixes <1...4> select the trace.

For further details refer to "DISPlay[:WINDow<1|2>]:TRACe<1...6>:MODE" on page 6.130.

DISPlay[:WINDow<1|2>]:TRACe<1...4>:MODE:FREeze[:STATe]

This command sets the display mode of the constellation diagram.

The numeric suffixes <1|2> are irrelevant.

Parameter

- ON The constellation diagram is displayed unchanged, while the I/Q samples are collected in the background.
- OFF The constellation diagram is displayed on basis of the current I/Q samples and, in continuous sweep mode, is updated with every measurement.

Example

```
CONF:DTV:MEAS CONS
```

Configures the R&S FSL for the Constellation Diagram measurement.

```
DISP:TRAC1:MODE:FRE ON
```

Sets the display mode of the constellation diagram to on.

Characteristics

RST value: OFF

SCPI: device-specific

Mode

CATV

DISPlay[:WINDow<1|2>]:TRACe<1...4>:MODE:HCONtinuous

The numeric suffixes <1...4> select the trace.

For further details refer to "[DISPlay\[:WINDow<1|2>\]:TRACe<1...6>:MODE:HCONtinuous](#)" on page 6.131..

DISPlay[:WINDow<1|2>]:TRACe<1...4>:Y[:SCALe]

The numeric suffixes <1...4> select the trace.

For details refer to "[DISPlay\[:WINDow<1|2>\]:TRACe<1...6>:Y\[:SCALe\]](#)" on page 6.132.

DISPlay[:WINDow<1|2>]:TRACe<1...4>:Y[:SCALe]:AUTO

This command activates the automatic scaling for the Hum and Tilt measurement. If activated, the scaling is automatically optimized to the best display of data. This rescaling may affect the values of any of the parameters under the SCALe node.

The numeric suffixes <1|2> and <1...4> are irrelevant.

This command is an event and therefore has no *RST value and no query.

Example

```
DISP:TRAC:Y:AUTO
```

Activates the automatic scaling for the Hum measurement.

Characteristics

RST value: -

SCPI: conform

Mode

CATV

DISPlay[:WINDow<1|2>]:TRACe<1...4>:Y[:SCALe]:MODE

The numeric suffixes <1...4> select the trace.

For further details refer to "[DISPlay\[:WINDow<1|2>\]:TRACe<1...6>:Y\[:SCALe\]:MODE](#)" on page 6.132.

DISPlay[:WINDow<1|2>]:TRACe<1...4>:Y[:SCALe]:RLEVel

The numeric suffixes <1...4> select the trace.

For further details refer to "[DISPlay\[:WINDow<1|2>\]:TRACe<1...6>:Y\[:SCALe\]:RLEVel](#)" on page 6.133.

DISPlay[:WINDow<1|2>]:TRACe<1...4>:Y[:SCALe]:RLEVel:OFFSet

The numeric suffixes <1...4> select the trace.

For further details refer to "[DISPlay\[:WINDow<1|2>\]:TRACe<1...6>:Y\[:SCALe\]:RLEVel:OFFSet](#)" on page 6.133.

DISPlay[:WINDow<1|2>]:TRACe<1...4>:Y[:SCALe]:RPOStion

The numeric suffixes <1...4> select the trace.

For further details refer to "[DISPlay\[:WINDow<1|2>\]:TRACe<1...6>:Y\[:SCALe\]:RPOStion \(models with tracking generator\)](#)" on page 6.133.

DISPlay[:WINDow<1|2>]:TRACe<1...4>:Y:SPACing

The numeric suffixes <1...4> select the trace.

Parameter

LINear | LOGarithmic

For further details refer to "[DISPlay\[:WINDow<1|2>\]:TRACe<1...6>:Y:SPACing](#)" on page 6.132.

DISPlay[:WINDow<1|2>]:ZOOM:EPATtern

This command sets the zoom factor for the Echo Pattern measurement.

The numeric suffixes <1|2> are irrelevant.

Parameter

1 to 20

Example

```
CONF:DTV:MEAS EPAT
```

Configures the R&S FSL for the Echo Pattern measurement.

```
DISP:ZOOM:EPAT 2
```

Sets the zoom factor for the Echo Pattern measurement.

Characteristics

RST value: 1

SCPI: device-specific

Mode

CATV

DISPlay[:WINDow<1|2>]:ZOOM:EPATtern:STATe

This command activates or deactivates the zoom on around 0 μs for the Echo Pattern measurement.

The numeric suffixes <1|2> are irrelevant.

Parameter

ON | OFF

Example

CONF:DTV:MEAS EPAT

Configures the R&S FSL for the Echo Pattern measurement.

DISP:ZOOM:EPAT:STAT ON

Switches on the zoom for the Echo Pattern measurement.

Characteristics

RST value: OFF

SCPI: device-specific

Mode

CATV

DISPlay[:WINDow<1|2>]:ZOOM:MERRors

This command sets the zoom for the Modulation Errors measurement.

The numeric suffixes <1|2> are irrelevant.

Parameter

NONE The whole result table is displayed.

<parameter> The result table of the selected parameter is displayed.
 with parameter = IMBalance | QERRor | SUPpression | PJITter | MERRms
 | MERPeak | EVMRms | EVMPeak

Example

CONF:DTV:MEAS MERR

Configures the R&S FSL for the Modulation Errors measurement.

DISP:ZOOM:MERR MERP

Displays the measurement results of the peak of the modulation error rate.

Characteristics

RST value: NONE

SCPI: device-specific

Mode

CATV

DISPlay[:WINDow<1|2>]:ZOOM:OVERview

This command sets the zoom for the Overview measurement.

The numeric suffixes <1|2> are irrelevant.

Parameter

NONE The whole result table is displayed.

<parameter> The result table of the selected parameter is displayed.
 with parameter = MERRms | MERPeak | EVMRms | EVMPeak | CFOffset
 | SROffset

Example

```
CONF:DTV:MEAS MERR
```

Configures the R&S FSL for the Modulation Errors measurement.

```
DISP:ZOOM:OVER MERP
```

Displays the measurement results of the peak of the modulation error rate.

Characteristics

RST value: NONE

SCPI: device-specific

Mode

CATV

DISPlay[:WINDow<1|2>]:ZOOM:QUADrant

This command sets the zoom for the constellation diagram.

The numeric suffixes <1|2> are irrelevant.

Parameter

NONE The whole constellation diagram is displayed.

1 | 2 | 3 | 4 The selected quadrant is displayed.

Example

```
CONF:DTV:MEAS CONS
```

Configures the R&S FSL for the Constellation Diagram measurement.

```
DISP:ZOOM:QUAD 1
```

Display the first quadrant of the constellation diagram.

Characteristics

RST value: NONE

SCPI: device-specific

Mode

CATV

FORMat Subsystem (CATV, K20)

The FORMat subsystem specifies the data format of the data transmitted from and to the instrument.

Commands of the FORMat Subsystem

- [FORMat\[:DATA\]](#)
- [FORMat:DEXPort:DSEPARATOR](#)

FORMat[:DATA]

For details refer to the [FORMat \[:DATA\]](#) command description of the base unit on page 6.135.

FORMat:DEXPort:DSEPARATOR

For details refer to "[FORMat:DEXPort:DSEPARATOR](#)" on page 6.135.

INITiate Subsystem (CATV, K20)

The INITiate subsystem is used to control the init-measurement function.

Commands of the INITiate Subsystem

- [INITiate<1|2>\[:IMMediate\]](#)
- [INITiate<1|2>:CONMeas](#)
- [INITiate<1|2>:CONTInuous](#)

INITiate<1|2>[:IMMediate]

For details refer to "[INITiate<1|2>\[:IMMediate\]](#)" on page 6.143.

INITiate<1|2>:CONMeas

For details refer to "[INITiate<1|2>:CONMeas](#)" on page 6.143.

INITiate<1|2>:CONTInuous

For details refer to "[INITiate<1|2>:CONTInuous](#)" on page 6.144.

INPut Subsystem (CATV, K20)

The INPut subsystem controls the input characteristics of the RF inputs of the instrument.

Commands of the INPut Subsystem

- [INPut:ATTenuation](#)
- [INPut:ATTenuation:AUTO](#)
- [INPut:GAIN:STATe](#)
- [INPut:IMPedance](#)

INPut:ATTenuation

For details refer to "[INPut<1|2>:ATTenuation](#)" on page 6.146.

INPut:ATTenuation:AUTO

For details refer to "[INPut<1|2>:ATTenuation:AUTO](#)" on page 6.146.

INPut:GAIN:STATe

For details refer to "[Error! Reference source not found.](#)" on page **Error! Bookmark not defined.**

INPut:IMPedance

For details refer to "[INPut<1|2>:IMPedance](#)" on page 6.147.

INSTrument Subsystem (CATV, K20)

The INSTrument subsystem selects the operating mode of the unit either via text parameters or fixed numbers.

Commands of the INSTrument Subsystem

- [INSTrument\[:SElect\]](#)
- [INSTrument:NSElect](#)

INSTrument[:SElect]

Parameter

CATV (Cable TV Measurements option, R&S FSL-K20)

For further details refer to the INSTrument subsystem of the base unit.

INSTrument:NSElect

Parameter

30 (Cable TV Measurements option, R&S FSL-K20)

For further details refer to the INSTrument subsystem of the base unit.

MMEMory Subsystem (CATV, K20)

The MMEMory (mass memory) subsystem provides commands which allow for access to the storage media of the instrument and for storing and loading various instrument settings.

Commands of the MMEMory Subsystem

- [MMEMory:STORe<1|2>:TRACe](#)

MMEMory:STORe<1|2>:TRACe

For details refer to the [MMEMory:STORe<1|2>:TRACe](#) command description of the base unit on page 6.163.

SENSe Subsystem (CATV, K20)

The SENSe subsystem is organized in several subsystems. The commands of these subsystems directly control device-specific settings, they do not refer to the signal characteristics of the measurement signal.

The SENSe subsystem controls the essential parameters of the analyzer. In accordance with the SCPI standard, the keyword "SENSe" is optional for this reason, which means that it is not necessary to include the SENSe node in command sequences.

The following subsystems are included:

- ["SENSe:ATV Subsystem \(CATV, K20\)"](#) on page 6.481
- ["SENSe:BANDwidth Subsystem \(CATV, K20\)"](#) on page 6.492
- ["SENSe:CORREction Subsystem \(CATV, K20\)"](#) on page 6.492
- ["SENSe:DETEctor Subsystem \(CATV, K20\)"](#) on page 6.494
- ["SENSe:DDEMod Subsystem \(CATV, K20\)"](#) on page 6.495
- ["SENSe:FREQuency Subsystem \(CATV, K20\)"](#) on page 6.498
- ["SENSe:POWEr Subsystem \(CATV, K20\)"](#) on page 6.500
- ["SENSe:SWEep Subsystem \(CATV, K20\)"](#) on page 6.501
- ["SENSe:TV Subsystem \(CATV, K20\)"](#) on page 6.502

SENSe:ATV Subsystem (CATV, K20)

The SENSe:ATV subsystem contains commands to control the analog TV measurement settings.

The following subsystems are included:

- "SENSe:ATV:CN Subsystem (CATV, K20)" on page 6.481
- "SENSe:ATV:CSO Subsystem (CATV, K20)" on page 6.485
- "SENSe:ATV:CTB Subsystem (CATV, K20)" on page 6.489

SENSe:ATV:CN Subsystem (CATV, K20)

The SENSe:ATV:CN subsystem contains commands for the Carrier-to-Noise Ratio (C/N) measurement setup.

Commands of the SENSe:ATV:CN Subsystem

- [SENSe<1|2>:]ATV:CN:BWIDth
- [SENSe<1|2>:]ATV:CN:CFRelative:NEXT
- [SENSe<1|2>:]ATV:CN:MEASurement:MODE
- [SENSe<1|2>:]ATV:CN:POWER:NCORrection
- [SENSe<1|2>:]ATV:CN:POWER:REFERENCE:CHANnel:MANual
- [SENSe<1|2>:]ATV:CN:POWER:REFERENCE:MANual
- [SENSe<1|2>:]ATV:CN:POWER:REFERENCE:MODE
- [SENSe<1|2>:]ATV:CN:TABLE<1...10>:MFRequencies

[SENSe<1|2>:]ATV:CN:BWIDth

This command defines the noise reference bandwidth in the C/N measurement.
The numeric suffixes <1|2> are irrelevant.

Parameter

100 to 20 MHz

Example

```
ATV:CN:BWID 7MHZ
```

Sets the noise reference bandwidth to 7 MHz.

Characteristics

RST value: 5 MHz

SCPI: device-specific

Mode

CATV

[SENSe<1|2>:]ATV:CN:CFRelative:NEXT

This command switches from one frequency range to the next according to the measurement frequencies defined by the [SENSe<1|2>:]ATV:CN:TABLE<1...10>:MFRequencies command.

The numeric suffixes <1|2> are irrelevant.

This command is an event and therefore has no *RST value and no query.

Parameter

(RF-10 MHz) to (RF+10 MHz)

Example

ATV:CN:TABL1:MFR 1,1000,1000

Activates the first row entries for the measurement and sets the center frequency to 1 kHz and the span to 1 kHz.

ATV:CN:TABL2:MFR 1,2000,2000

Activates the second row entries for the measurement and sets the center frequency to 2 kHz and the span to 2 kHz.

ATV:CN:CFR:NEXT

Switches from the frequency range defined in table row 1 to 2.

Characteristics

RST value: -

SCPI: device-specific

Mode

CATV

[SENSe<1|2>:]ATV:CN:MEASurement:MODE

This command defines the measurement method for the Carrier-to-Noise Ratio measurement. The numeric suffixes <1|2> are irrelevant.

Parameter

ISERvice (In-Service) While an analog TV signal is present, a gap between two consecutive channels, where only noise exists, is used to determine the noise power. A noise marker is placed there, and the noise power is determined.

OSERvice (Off-Service) The current measurement channel is switched off by the provider. In this channel, a noise marker is placed, and the noise power is determined.

QLINE (Quiet Line) While an analog TV signal is present, the carrier-to-noise ratio is measured using the so-called "Quiet Line". The measurement is fully automated.

Example

ATV:CN:MEAS:MODE OSER

Sets the Off-Service measurement method.

Characteristics

RST value: ISER

SCPI: device-specific

Mode

CATV

[SENSe<1|2>:]ATV:CN:POWER:NCORrection

This command activates or deactivates the noise floor correction. The numeric suffixes <1|2> are irrelevant.

Parameter

ON | OFF

Example

```
ATV:CN:POW:NCOR ON
```

Activates the noise floor correction.

Characteristics

RST value: OFF

SCPI: device-specific

Mode

CATV

[SENSe<1|2>:]ATV:CN:POWer:REFerence:CHANnel:MANual

This command defines the reference channel.

The numeric suffixes <1|2> are irrelevant.

Parameter

<numeric_value>, corresponding to active channel

Example

```
ATV:CN:POW:REF:CHAN:MAN 5
```

Sets channel 5 in the active channel table as reference channel.

Characteristics

RST value: active measurement channel

SCPI: device-specific

Mode

CATV

[SENSe<1|2>:]ATV:CN:POWer:REFerence:MANual

This command defines the manual reference power. The unit is set via the [CALCulate<1|2>:UNIT:POWer](#) command.

The numeric suffixes <1|2> are irrelevant.

Parameter

-200 to 200 dB

Example

```
ATV:CN:POW:REF:MAN 10
```

Sets the reference power to 10.

Characteristics

RST value: 0

SCPI: device-specific

Mode

CATV

[SENSe<1|2>:]ATV:CN:POWer:REFEreNce:MODE

This command defines the reference power method.
The numeric suffixes <1|2> are irrelevant.

Parameter

RCHannel	reference channel ([SENSe<1 2>:]ATV:CN:POWer:REFEreNce:CHANnel:MANual command)
MCHannel	same as measurement channel
MANual	manual reference power ([SENSe<1 2>:]ATV:CN:POWer:REFEreNce:MANual command)

Example

```
ATV:CN:POW:REF:MODE RCH
```

Sets the reference channel method.

Characteristics

RST value: MCH
SCPI: device-specific

Mode

CATV

[SENSe<1|2>:]ATV:CN:TABLE<1...10>:MFRequencies

This command defines the measurement frequencies (center frequencies and span values), and activates or deactivates them for the C/N measurement.

The numeric suffix <1...10> defines the table row. The numeric suffixes <1|2> are irrelevant.

Parameter

0 1,<numeric_value>,<numeric_value>	
0	deactivated
1	activated
first numeric value	center frequency in Hz
second numeric value	span in Hz

Example

```
ATV:CN:TABLE1:MFR 1,1000,1000
```

Activates the entries of the first table row for the measurement and sets the center frequency to 1 kHz and the span to 1 kHz.

```
ATV:CN:TABLE2:MFR 1,2000,2000
```

Activates the second row entries for the measurement and sets the center frequency to 2 kHz and the span to 2 kHz.

Characteristics

RST value: 1,1.25 KHz,1 MHz (row 1); 0,1.25 kHz,1 MHz (row 2-10)
SCPI: device-specific

Mode

CATV

SENSe:ATV:CSO Subsystem (CATV, K20)

The SENSe:ATV:CSO subsystem contains commands for the Carrier-to-Second Order Beat Ratio (CSO) measurement setup.

Commands of the SENSe:ATV:CSO Subsystem

- [SENSe<1|2>:]ATV:CSO:CFRelative:NEXT
- [SENSe<1|2>:]ATV:CSO:MEASurement:MODE
- [SENSe<1|2>:]ATV:CSO:POWer:NCORrection
- [SENSe<1|2>:]ATV:CSO:POWer:REFerence:CHANnel:MANual
- [SENSe<1|2>:]ATV:CSO:POWer:REFerence:MANual
- [SENSe<1|2>:]ATV:CSO:POWer:REFerence:MODE
- [SENSe<1|2>:]ATV:CSO:TABLE<1...10>:MFRequencies

[SENSe<1|2>:]ATV:CSO:CFRelative:NEXT

This command switches from one frequency range to the next according to the measurement frequencies defined by the [SENSe<1|2>:]ATV:CSO:TABLE<1...10>:MFRequencies command.

The numeric suffixes <1|2> are irrelevant.

This command is an event and therefore has no *RST value and no query.

Example

```
ATV:CSO:TABL1:MFR 1,-1000,1000
```

Activates the entries of the first table row for the measurement and sets the center frequency to -1 kHz and the span to 1 kHz.

```
ATV:CSO:TABL2:MFR 1,-2000,2000
```

Activates the second row entries for the measurement and sets the center frequency to -2 kHz and the span to 2 kHz.

```
ATV:CSO:CFR:NEXT
```

Switches from the frequency range defined in table row 1 to 2.

Characteristics

RST value: -

SCPI: device-specific

Mode

CATV

[SENSe<1|2>:]ATV:CSO:MEASurement:MODE

This command defines the measurement method for the Carrier-to-Second Order Beat Ratio measurement.

The numeric suffixes <1|2> are irrelevant.

Parameter

OSERvice (Off-Service) The current measurement channel is switched off by the provider. In this channel, a noise marker is placed, and the noise power is determined.

QLINe (Quiet Line) While an analog TV signal is present, the carrier-to-noise ratio is measured using the so-called "Quiet Line". The measurement is fully automated.

Example

```
ATV:CSO:MEAS:MODE QLIN
```

Sets the Quiet Line measurement method.

Characteristics

RST value: OSER

SCPI: device-specific

Mode

CATV

[SENSe<1|2>:]ATV:CSO:POWer:NCORrection

This command activates or deactivates the noise floor correction.

The numeric suffixes <1|2> are irrelevant.

Parameter

ON | OFF

Example

```
ATV:CSO:POW:NCOR ON
```

Activates the noise floor correction.

Characteristics

RST value: OFF

SCPI: device-specific

Mode

CATV

[SENSe<1|2>:]ATV:CSO:POWer:REFerence:CHANnel:MANual

This command defines the reference channel.

The numeric suffixes <1|2> are irrelevant.

Parameter

<numeric_value>, corresponding to active channel

Example

```
ATV:CSO:POW:REF:CHAN:MAN 6
```

Sets channel 6 in the active channel table as reference channel.

Characteristics

RST value: active measurement channel

SCPI: device-specific

Mode

CATV

[SENSe<1|2>:]ATV:CSO:POWer:REFerence:MANual

This command defines the manual reference power. The unit is set via the [CALCulate<1|2>:UNIT:POWer](#) command.

The numeric suffixes <1|2> are irrelevant.

Parameter

-200 to 200 dB

Example

ATV:CSO:POW:REF:MAN 20
Sets the reference power to 20.

Characteristics

RST value: 10
SCPI: device-specific

Mode

CATV

[SENSe<1|2>:]ATV:CSO:POWer:REFerence:MODE

This command defines the reference power method.
The numeric suffixes <1|2> are irrelevant.

Parameter

RCHannel	reference channel ([SENSe<1 2>:]ATV:CSO:POWer:REFerence:CHANnel:MANual command)
MCHannel	same as measurement channel
MANual	manual reference power ([SENSe<1 2>:]ATV:CSO:POWer:REFerence:MANual command)

Example

ATV:CSO:POW:REF:MODE RCH
Sets the reference channel method.

Characteristics

RST value: MCH
SCPI: device-specific

Mode

CATV

[SENSe<1|2>:]ATV:CSO:TABLE<1...10>:MFRequencies

This command defines the measurement frequencies (center frequencies and span values), and activates or deactivates them for the CSO measurement.

The numeric suffixes <1|2> are irrelevant.
The numeric suffix <1...10> defines the table row.

Parameter

0 1,<numeric_value>,<numeric_value>	
0	deactivated
1	activated
first numeric value	center frequency in Hz
second numeric value	span in Hz

Example

ATV:CSO:TABL1:MFR 1, -1000, 1000

Activates the entries of the first table row for the measurement and sets the center frequency to -1 kHz and the span to 1 kHz.

ATV:CSO:TABL2:MFR 1, -2000, 2000

Activates the second row entries for the measurement and sets the center frequency to -2 kHz and the span to 2 kHz.

Characteristics

RST value:

Row	State	Center frequency	Span
1	ON	-1.25 MHz	200 kHz
2	ON	-750 kHz	200 kHz
3	ON	-250 kHz	200 kHz
4	ON	250 kHz	200 kHz
5	ON	750 kHz	200 kHz
6	ON	1.25 MHz	200 kHz
7	ON	2.25 MHz	200 kHz
8	OFF	3.25 MHz	200 kHz
9	OFF	4.25 MHz	200 kHz
10	OFF	5.25 MHz	200 kHz

SCPI: device-specific

Mode

CATV

SENSe:ATV:CTB Subsystem (CATV, K20)

The SENSe:ATV:CTB subsystem contains commands for the Carrier-to-Composite Triple Beat Ratio (CTB) measurement setup.

Commands of the SENSe:ATV:CTB Subsystem

- [SENSe<1|2>:]ATV:CTB:CFRelative:NEXT
- [SENSe<1|2>:]ATV:CTB:POWer:NCORrection
- [SENSe<1|2>:]ATV:CTB:POWer:REFerence:CHANnel:MANual
- [SENSe<1|2>:]ATV:CTB:POWer:REFerence:MANual
- [SENSe<1|2>:]ATV:CTB:POWer:REFerence:MODE
- [SENSe<1|2>:]ATV:CTB:TABLE<1...10>:MFRequencies

[SENSe<1|2>:]ATV:CTB:CFRelative:NEXT

This command switches from one frequency range to the next according to the measurement frequencies defined by the [SENSe<1|2>:]ATV:CTB:TABLE<1...10>:MFRequencies command.

The numeric suffixes <1|2> are irrelevant.

This command is an event and therefore has no *RST value and no query.

Example

```
ATV:CTB:TABLE1:MFR 1,100,10000
```

Activates the entries of the first table row for the measurement and sets the center frequency to 100 Hz and the span to 10 kHz.

```
ATV:CTB:TABLE2:MFR 1,200,20000
```

Activates the second row entries for the measurement and sets the center frequency to 200 Hz and the span to 20 kHz.

```
ATV:CTB:CFR:NEXT
```

Switches from the frequency range defined in table row 1 to 2.

Characteristics

RST value: -

SCPI: device-specific

Mode

CATV

[SENSe<1|2>:]ATV:CTB:POWer:NCORrection

This command activates or deactivates the noise floor correction.

The numeric suffixes <1|2> are irrelevant.

Parameter

ON | OFF

Example

```
ATV:CTB:POW:NCOR ON
```

Activates the noise floor correction.

Characteristics

RST value: OFF

SCPI: device-specific

Mode

CATV

[SENSe<1|2>:]ATV:CTB:POWer:REFerence:CHANnel:MANual

This command defines the reference channel.

The numeric suffixes <1|2> are irrelevant.

Parameter

<numeric_value>, corresponding to active channel

Example

```
ATV:CTB:POW:REF:CHAN:MAN 5
```

Sets channel 5 in the active channel table as reference channel.

Characteristics

RST value: active measurement channel

SCPI: device-specific

Mode

CATV

[SENSe<1|2>:]ATV:CTB:POWer:REFerence:MANual

This command defines the manual reference power. The unit is set via the [CALCulate<1|2>:UNIT:POWer](#) command.

The numeric suffixes <1|2> are irrelevant.

Parameter

-200 to 200 dB

Example

```
ATV:CTB:POW:REF:MAN 10
```

Sets the reference power to 10.

Characteristics

RST value: 0

SCPI: device-specific

Mode

CATV

[SENSe<1|2>:]ATV:CTB:POWer:REFerence:MODE

This command defines the reference power method.

The numeric suffixes <1|2> are irrelevant.

Parameter

RCHannel	reference channel ([SENSe<1 2>:]ATV:CTB:POWer:REFerence:CHANnel:MANual command)
MCHannel	same as measurement channel
MANual	manual reference power ([SENSe<1 2>:]ATV:CTB:POWer:REFerence:MANual command)

Example

```
ATV:CTB:POW:REF:MODE MAN
```

Sets the reference channel method.

Characteristics

RST value: RCH

SCPI: device-specific

Mode

CATV

[SENSe<1|2>:]ATV:CTB:TABLE<1...10>:MFRrequencies

This command defines the measurement frequencies (center frequencies and span values), and activates or deactivates them for the CTB measurement.

The numeric suffix <1...10> defines the table row. The numeric suffixes <1|2> are irrelevant.

Parameter

```
0 | 1,<numeric_value>,<numeric_value>
```

0 deactivated

1 activated

first numeric value center frequency in Hz

second numeric value span in Hz

Example

```
ATV:CTB:TABLE1:MFR 1,100,10000
```

Activates the entries of the first table row for the measurement and sets the center frequency to 100 Hz and the span to 10 kHz.

```
ATV:CTB:TABLE2:MFR 1,200,20000
```

Activates the second row entries for the measurement and sets the center frequency to 200 Hz and the span to 20 kHz.

Characteristics

RST value: 1,0 Hz, 200 kHz (row 1); 0,0,200 kHz (row 2-10)

SCPI: device-specific

Mode

CATV

SENSe:BANDwidth Subsystem (CATV, K20)

This subsystem controls the setting of the instruments filter bandwidths. Both groups of commands (BANDwidth and BWIDth) perform the same functions.

Commands of the SENSe:BANDwidth Subsystem

- [SENSe<1|2>:]BANDwidth|BWIDth[:RESolution]
- [SENSe<1|2>:]BANDwidth|BWIDth[:RESolution]:AUTO
- [SENSe<1|2>:]BANDwidth|BWIDth:VIDeo
- [SENSe<1|2>:]BANDwidth|BWIDth:VIDeo:AUTO

[SENSe<1|2>:]BANDwidth|BWIDth[:RESolution]

For details refer to "[SENSe<1|2>:]BANDwidth|BWIDth[:RESolution]" on page 6.170.

[SENSe<1|2>:]BANDwidth|BWIDth[:RESolution]:AUTO

For details refer to "[SENSe<1|2>:]BANDwidth|BWIDth[:RESolution]:AUTO" on page 6.170.

[SENSe<1|2>:]BANDwidth|BWIDth:VIDeo

For details refer to "[SENSe<1|2>:]BANDwidth|BWIDth:VIDeo" on page 6.172.

[SENSe<1|2>:]BANDwidth|BWIDth:VIDeo:AUTO

For details refer to "[SENSe<1|2>:]BANDwidth|BWIDth:VIDeo:AUTO" on page 6.172.

SENSe:CORRection Subsystem (CATV, K20)

The SENSe:CORRection subsystem controls correction factors.

Commands of the SENSe:CORRection Subsystem

- [SENSe<1|2>:]CORRection:RVELocity

[SENSe<1|2>:]CORRection:RVELocity

This command defines the velocity of propagation of the signal in the transmission channel (e.g. cable), relative to speed of light.

The numeric suffixes <1|2> are irrelevant.

Parameter

0.0001 to 1.0

Example

```
CONF:DTV:MEAS EPAT
```

Configures the R&S FSL for the Echo Pattern measurement.

```
CORR:RVEL 0.2
```

Sets the velocity of propagation to 0.2.

Characteristics

RST value: 1

SCPI: device-specific

Mode

CATV

SENSe:DETECTOR Subsystem (CATV, K20)

The SENSe:DETECTOR subsystem controls the acquisition of measurement data via the selection of the detector for the corresponding trace.

Commands of the SENSe:DETECTOR Subsystem

- [SENSe<1|2>:]DETECTOR<1...4>[:FUNCTION]
- [SENSe<1|2>:]DETECTOR<1...4>[:FUNCTION]:AUTO

[SENSe<1|2>:]DETECTOR<1...4>[:FUNCTION]

For details refer to "[SENSe<1|2>:]DETECTOR<1...6>[:FUNCTION]" on page 6.180.

[SENSe<1|2>:]DETECTOR<1...4>[:FUNCTION]:AUTO

For details refer to "[SENSe<1|2>:]DETECTOR<1...6>[:FUNCTION]:AUTO" on page 6.180.

SENSe:DDEMod Subsystem (CATV, K20)

The SENSe:DDEMod subsystem controls the digital TV settings.

Commands of the SENSe:DDEMod Subsystem

- [SENSe<1|2>:]DDEMod:EQUalizer[:STATe]
- [SENSe<1|2>:]DDEMod:EQUalizer:FREeze[:STATe]
- [SENSe<1|2>:]DDEMod:EQUalizer:RESet
- [SENSe<1|2>:]DDEMod:FILTer:ALPHa
- [SENSe<1|2>:]DDEMod:SBANd
- [SENSe<1|2>:]DDEMod:SRATe

[SENSe<1|2>:]DDEMod:EQUalizer[:STATe]

This command activates or deactivates the equalizer.
The numeric suffixes <1|2> are irrelevant.

Parameter

ON | OFF

Example

DDEM:EQU OFF

Switches the equalizer off.

Characteristics

RST value: ON

SCPI: device-specific

Mode

CATV

[SENSe<1|2>:]DDEMod:EQUalizer:FREeze[:STATe]

This command defines the change of the equalizer coefficients.
The numeric suffixes <1|2> are irrelevant.

Parameter

ON The equalizer coefficients remain unchanged.

OFF The equalizer taps are changed with every measurement.

Example

DDEM:EQU:FRE ON

Activates the change of the equalizer coefficients.

Characteristics

RST value: OFF

SCPI: device-specific

Mode

CATV

[SENSe<1|2>:]DDEMod:EQUalizer:RESet

This command resets the equalizer and all equalizer parameters are set to their default values.
The numeric suffixes <1|2> are irrelevant.

Example

```
DDEM: EQU: RES
```

Resets the equalizer.

Characteristics

RST value: -
SCPI: device-specific

Mode

CATV

[SENSe<1|2>:]DDEMod:FILTer:ALPHa

This command defines the roll-off.
The numeric suffixes <1|2> are irrelevant.

Parameter

R012 | R013 | R015 | R018

Example

```
DDEM: FILT: ALPH R018
```

Sets the roll-off to 0.180.

Characteristics

RST value: R015
SCPI: device-specific

Mode

CATV

[SENSe<1|2>:]DDEMod:SBANd

This command defines the sideband position.
The numeric suffixes <1|2> are irrelevant.

Parameter

AUTO | NORMal | INVerse

Example

```
DDEM: SBAN NORM
```

Sets the sideband position to normal.

Characteristics

RST value: AUTO
SCPI: device-specific

Mode

CATV

[SENSe<1|2>:]DDEMod:SRATe

This command defines the symbol rate.
The numeric suffixes <1|2> are irrelevant.

Parameter

<numeric_value>

Example

```
DDEMod:SRAT 1000000
```

Sets the symbol rate to 1.0 MSymb/s

Characteristics

RST value: 6.9 MSYMB/S

SCPI: device-specific

Mode

CATV

SENSe:FREQUENCY Subsystem (CATV, K20)

The SENSe:FREQUENCY subsystem defines the frequency axis of the active display. The frequency axis can either be defined via the start/stop frequency or via the center frequency and span.

Commands of the SENSe:FREQUENCY Subsystem

- [SENSe<1|2>:]FREQUENCY:CHANnel
- [SENSe<1|2>:]FREQUENCY:RF
- [SENSe<1|2>:]FREQUENCY:SPAN:FULL
- [SENSe<1|2>:]FREQUENCY:START
- [SENSe<1|2>:]FREQUENCY:STEP
- [SENSe<1|2>:]FREQUENCY:STOP

[SENSe<1|2>:]FREQUENCY:CHANnel

This command defines the active measurement channel. To display the available channel tables and channels refer to the "[CONFigure:TV Subsystem \(CATV, K20\)](#)" on page 6.469.

The numeric suffixes <1|2> are irrelevant.

Parameter

<numeric_value>

Example

```
CONF:TV:CTAB:SEL 'TV-EUROPE'
```

Selects and activates the channel table TV-EUROPE.

```
FREQ:CHAN 3
```

Sets channel 3 as active measurement channel.

Characteristics

RST value: active measurement channel

SCPI: device-specific

Mode

CATV

[SENSe<1|2>:]FREQUENCY:RF

This command defines the RF frequency. The interpretation of the RF frequency depends on the signal type. For details refer to chapter "Instrument Functions", section "Cable TV Measurement Option (K20)", **RF** softkey.

The numeric suffixes <1|2> are irrelevant.

Parameter

5 MHz to 1.5 GHz

Example

```
FREQ:RF 10MHZ
```

Sets the RF frequency to 10 MHz.

Characteristics

RST value: 1.5 GHz for R&S FSL3, 48.25 MHz for R&S FSL6/18 (the `FREQ:RF DEF` command sets 48.25 MHz for all models)

SCPI: device-specific

Mode

CATV

[SENSe<1|2>:]FREQuency:SPAN:FULL

For details refer to "[SENSe<1|2>:]FREQuency:SPAN:FULL" on page 6.197.

[SENSe<1|2>:]FREQuency:STARt

For details refer to "[SENSe<1|2>:]FREQuency:STARt" on page 6.197.

[SENSe<1|2>:]FREQuency:STEP

For details refer to "[SENSe<1|2>:]FREQuency:CENTer:STEP" on page 6.194.

[SENSe<1|2>:]FREQuency:STOP

For details refer to "[SENSe<1|2>:]FREQuency:STOP" on page 6.198.

SENSe:POWer Subsystem (CATV, K20)

The SENSe:POWer subsystem adjusts the input attenuator.

Commands of the SENSe:POWer Subsystem

– [\[SENSe<1|2>:\]POWer:ACHannel:PRESet:RLEVel](#)

[\[SENSe<1|2>:\]POWer:ACHannel:PRESet:RLEVel](#)

For details refer to "[\[SENSe<1|2>:\]POWer:ACHannel:PRESet:RLEVel](#)" on page 6.217.

SENSe:SWEEp Subsystem (CATV, K20)

The SENSe:SWEEp subsystem controls the sweep parameters.

Commands of the SENSe:SWEEp Subsystem

- [SENSe<1|2>:]SWEEp:COUNT
- [SENSe<1|2>:]SWEEp:POINTs
- [SENSe<1|2>:]SWEEp:SPACing
- [SENSe<1|2>:]SWEEp:TIME
- [SENSe<1|2>:]SWEEp:TIME:AUTO

[SENSe<1|2>:]SWEEp:COUNT

For details refer to "[SENSe<1|2>:]SWEEp:COUNT" on page 6.223.

[SENSe<1|2>:]SWEEp:POINTs

For details refer to "[SENSe<1|2>:]SWEEp:POINTs" on page 6.227.

[SENSe<1|2>:]SWEEp:SPACing

This command defines the labeling of the frequency axis. For details refer to chapter "Instrument Functions", section "Cable TV Measurement Option (K20)", **Frequency Abs/Rel** softkey.

The numeric suffixes <1|2> are irrelevant.

Parameter

ABSolute | RELative

Example

```
SWE:SPAC ABS
```

Sets absolute labeling of the frequency axis.

Characteristics

RST value: REL

SCPI: device-specific

Mode

CATV

[SENSe<1|2>:]SWEEp:TIME

For details refer to "[SENSe<1|2>:]SWEEp:TIME" on page 6.227.

[SENSe<1|2>:]SWEEp:TIME:AUTO

For details refer to "[SENSe<1|2>:]SWEEp:TIME:AUTO" on page 6.228.

SENSe:TV Subsystem (CATV, K20)

The SENSe:DDEMod subsystem controls the TV settings.

Commands of the SENSe:TV Subsystem

- [SENSe<1|2>:]TV:MSTandard:FILTer:GDELay
- [SENSe<1|2>:]TV:MSTandard:NAME
- [SENSe<1|2>:]TV:MSTandard:STYPe
- [SENSe<1|2>:]TV:TILT:MSTandard:CDISable
- [SENSe<1|2>:]TV:TILT:MSTandard:CENable

[SENSe<1|2>:]TV:MSTandard:FILTer:GDELay

This command defines the group delay for a modulation standard.
The numeric suffixes <1|2> are irrelevant.

Parameter

GENeral | GHAlf | AUSTRalia | DANMark | NEWZealand | NORWay | SWEDenfull | FLAT | OIRT | CHINa | CCIR | TDF | FFC

Example

```
TV:MST:FILT:GDEL FLAT
Sets the group delay FLAT.
```

Characteristics

RST value: GENERAL
SCPI: device-specific

Mode

CATV

[SENSe<1|2>:]TV:MSTandard:NAME

This command defines the name for a modulation standard.
The numeric suffixes <1|2> are irrelevant.

Parameter

<string>: 1 to 15 characters

Example

```
TV:MST:NAME 'TEST'
Gives the modulation standard the name 'TEST'.
```

Characteristics

RST value: Analog TV
SCPI: device-specific

Mode

CATV

[SENSe<1|2>:]TV:MSTandard:STYPe

This command defines the signal type of a modulation standard.
The numeric suffixes <1|2> are irrelevant.

Parameter

ATV | DTV

Example

```
TV:MST:STYP DTV
```

Sets the signal type DTV.

Characteristics

RST value: ATV

SCPI: device-specific

Mode

CATV

[SENSe<1|2>:]TV:TILT:MSTandard:CDISable

This command deactivates a modulation standard for the Tilt measurement.
The numeric suffixes <1|2> are irrelevant.

Parameter

<string>: modulation standard name

Example

```
CONF:TV:CTAB:SEL 'TV-ITALY'
```

Activates the channel table TV-ITALY.

```
CONF:TV:MEAS TILT
```

Configures the R&S FSL to measure the channel power of every channel.

```
TV:TILT:MST:CDIS 'PAL BG ITALY'
```

Deactivates the modulation standard PAL BG ITALY.

Characteristics

RST value: -

SCPI: device-specific

Mode

CATV

[SENSe<1|2>:]TV:TILT:MSTandard:CENable

This command activates a modulation standard for the Tilt measurement.
The numeric suffixes <1|2> are irrelevant.

Parameter

<string>: modulation standard name

Example

```
CONF:TV:CTAB:SEL 'TV-ITALY'
```

Activates the channel table TV-ITALY.

```
CONF:TV:MEAS TILT
```

Configures the R&S FSL to measure the channel power of every channel.

TV:TILT:MST:CEN 'PAL BG ITALY'

Activates the modulation standard PAL BG ITALY.

Characteristics

RST value: -

SCPI: device-specific

Mode

CATV

SETup:TV Subsystem (CATV, K20)

The SETup:TV subsystem controls the modulation standard settings.

Commands of the SETup:TV Subsystem

- SETup:TV:STANdard
- SETup:TV:STANdard:AUDio
- SETup:TV:STANdard:COLor

SETup:TV:STANdard

This command sets the TV standard.

Parameter

BG | DK | I | K1 | L | M | N (analog TV)

J83A | J83B | J83C (digital TV)

Note: *In the Video Scope measurement, the y-axis of the diagram is scaled in Volt for all TV standards except M. If M is the selected TV standard, the y-axis of the diagram is scaled in IRE.*

Example

```
SET:TV:STAN DK
```

Sets the TV standard DK.

Characteristics

RST value: BG

SCPI: device-specific

Mode

CATV

SETup:TV:STANdard:AUDio

This command sets the sound system for analog TV measurements.

Parameter

FM55NICAM585 | FM55FM5742 | FM55MONO | FM65NICAM585 | FM65FM6258 |
FM65FM6742 | FM65MONO | FM60NICAM6552 | FM60MONO | AM65NICAM585 |
AM60MONO | FM45BTSC | FM45EIA_J | FM45FM4742 | FM45MONO

Example

```
SET:TV:STAN:AUD FM65MONO
```

Sets the sound system FM65MONO.

Characteristics

RST value: FM65FM6742

SCPI: device-specific

Mode

CATV

SETup:TV:STANdard:COLor

This command sets the color system for analog TV measurements.

Parameter

PAL | NTSC | SECam

Example

```
SET:TV:STAN:COL SEC  
Sets the color system SECam.
```

Characteristics

RST value: PAL

SCPI: device-specific

Mode

CATV

SOURce Subsystem (CATV, K20)

The SOURce subsystem controls the digital TV settings.

Commands of the SOURce Subsystem

- [SOURce:DM:FORMat](#)

SOURce:DM:FORMat

This command sets the constellation parameter for digital TV measurements.

Parameter

QAM4 | QAM16 | QAM32 | QAM64 | QAM128 | QAM256 | QAM512 | QAM1024

Example

```
SOURce:DM:FORM QAM128  
Sets the constellation parameter
```

Characteristics

RST value: QAM64
SCPI: device-specific

Mode

CATV

STATus Subsystem (CATV, K20)

The STATus subsystem contains the commands for the status reporting system (for details refer to chapter 5 "Remote Control - Basics". *RST does not influence the status registers.

Commands of the STATus Subsystem

- STATus:QUEStionable:ACPLimit[:EVENT?]
- STATus:QUEStionable:ACPLimit:CONDition?
- STATus:QUEStionable:ACPLimit:ENABle
- STATus:QUEStionable:ACPLimit:NTRansition
- STATus:QUEStionable:ACPLimit:PTRansition
- STATus:QUEStionable:FREQuency[:EVENT?]
- STATus:QUEStionable:FREQuency:CONDition?
- STATus:QUEStionable:FREQuency:ENABle
- STATus:QUEStionable:FREQuency:NTRansition
- STATus:QUEStionable:FREQuency:PTRansition
- STATus:QUEStionable:LIMit<1|2>[:EVENT?]
- STATus:QUEStionable:LIMit<1|2>:CONDition?
- STATus:QUEStionable:LIMit<1|2>:ENABle
- STATus:QUEStionable:LIMit<1|2>:NTRansition
- STATus:QUEStionable:LIMit<1|2>:PTRansition
- STATus:QUEStionable:LMARgin<1|2>[:EVENT?]
- STATus:QUEStionable:LMARgin<1|2>:CONDition?
- STATus:QUEStionable:LMARgin<1|2>:ENABle
- STATus:QUEStionable:LMARgin<1|2>:NTRansition
- STATus:QUEStionable:LMARgin<1|2>:PTRansition
- STATus:QUEStionable:POWer[:EVENT?]
- STATus:QUEStionable:POWer:CONDition?
- STATus:QUEStionable:POWer:ENABle
- STATus:QUEStionable:POWer:NTRansition
- STATus:QUEStionable:POWer:PTRansition
- STATus:QUEStionable:SYNC[:EVENT?]
- STATus:QUEStionable:SYNC:CONDition?
- STATus:QUEStionable:SYNC:ENABle
- STATus:QUEStionable:SYNC:NTRansition
- STATus:QUEStionable:SYNC:PTRansition

STATus:QUEStionable:ACPLimit[:EVENT?]

For details refer to "STATus:QUEStionable:ACPLimit[:EVENT?]" on page 6.236.

STATus:QUESTionable:ACPLimit:CONDition?

For details refer to "[STATus:QUESTionable:ACPLimit:CONDition?](#)" on page 6.236.

STATus:QUESTionable:ACPLimit:ENABLE

For details refer to "[STATus:QUESTionable:ACPLimit:ENABLE](#)" on page 6.236.

STATus:QUESTionable:ACPLimit:NTRansition

For details refer to "[STATus:QUESTionable:ACPLimit:NTRansition](#)" on page 6.237.

STATus:QUESTionable:ACPLimit:PTRansition

For details refer to "[STATus:QUESTionable:ACPLimit:PTRansition](#)" on page 6.237.

STATus:QUESTionable:FREQuency[:EVENT?]

For details refer to "[STATus:QUESTionable:FREQuency\[:EVENT?\]](#)" on page 6.237.

STATus:QUESTionable:FREQuency:CONDition?

For details refer to "[STATus:QUESTionable:FREQuency:CONDition?](#)" on page 6.238.

STATus:QUESTionable:FREQuency:ENABLE

For details refer to "[STATus:QUESTionable:FREQuency:ENABLE](#)" on page 6.238.

STATus:QUESTionable:FREQuency:NTRansition

For details refer to "[STATus:QUESTionable:FREQuency:NTRansition](#)" on page 6.238.

STATus:QUESTionable:FREQuency:PTRansition

For details refer to "[STATus:QUESTionable:FREQuency:PTRansition](#)" on page 6.239.

STATus:QUESTionable:LIMit<1|2>[:EVENT?]

For details refer to "[STATus:QUESTionable:LIMit<1|2>\[:EVENT?\]](#)" on page 6.239.

STATus:QUESTionable:LIMit<1|2>:CONDition?

For details refer to "[STATus:QUESTionable:LIMit<1|2>:CONDition?](#)" on page 6.239.

STATus:QUESTionable:LIMit<1|2>:ENABLE

For details refer to "[STATus:QUESTionable:LIMit<1|2>:ENABLE](#)" on page 6.240.

STATus:QUESTionable:LIMit<1|2>:NTRansition

For details refer to "[STATus:QUESTionable:LIMit<1|2>:NTRansition](#)" on page 6.240.

STATus:QUESTionable:LIMit<1|2>:PTRansition

For details refer to "[STATus:QUESTionable:LIMit<1|2>:PTRansition](#)" on page 6.240.

STATus:QUESTionable:LMARgin<1|2>[:EVENT?]

For details refer to "[STATus:QUESTionable:LMARgin<1|2>\[:EVENT?\]](#)" on page 6.241.

STATus:QUESTionable:LMARgin<1|2>:CONDition?

For details refer to "[STATus:QUESTionable:LMARgin<1|2>:CONDition?](#)" on page 6.241.

STATus:QUESTionable:LMARgin<1|2>:ENABLE

For details refer to "[STATus:QUESTionable:LMARgin<1|2>:ENABLE](#)" on page 6.241.

STATus:QUESTionable:LMARgin<1|2>:NTRansition

For details refer to "[STATus:QUESTionable:LMARgin<1|2>:NTRansition](#)" on page 6.241.

STATus:QUESTionable:LMARgin<1|2>:PTRansition

For details refer to "[STATus:QUESTionable:LMARgin<1|2>:PTRansition](#)" on page 6.242.

STATus:QUESTionable:POWER[:EVENT?]

For details refer to "[STATus:QUESTionable:POWER\[:EVENT?\]](#)" on page 6.242.

STATus:QUESTionable:POWER:CONDition?

For details refer to "[STATus:QUESTionable:POWER:CONDition?](#)" on page 6.242.

STATus:QUESTionable:POWER:ENABLE

For details refer to "[STATus:QUESTionable:POWER:ENABLE](#)" on page 6.243.

STATus:QUEStionable:POWer:NTRansition

For details refer to "[STATus:QUEStionable:POWer:NTRansition](#)" on page 6.243.

STATus:QUEStionable:POWer:PTRansition

For details refer to "[STATus:QUEStionable:POWer:PTRansition](#)" on page 6.243.

STATus:QUEStionable:SYNC[:EVENT?]

For details refer to "[STATus:QUEStionable:SYNC\[:EVENT?\]](#)" on page 6.244.

STATus:QUEStionable:SYNC:CONDition?

For details refer to "[STATus:QUEStionable:SYNC:CONDition?](#)" on page 6.244.

STATus:QUEStionable:SYNC:ENABle

For details refer to "[STATus:QUEStionable:SYNC:ENABle](#)" on page 6.244.

STATus:QUEStionable:SYNC:NTRansition

For details refer to "[STATus:QUEStionable:SYNC:NTRansition](#)" on page 6.245.

STATus:QUEStionable:SYNC:PTRansition

For details refer to "[STATus:QUEStionable:SYNC:PTRansition](#)" on page 6.245.

TRACe Subsystem (CATV, K20)

The TRACe subsystem controls access to the instruments internal trace memory.

Commands of the TRACe Subsystem

- [TRACe<1|2>\[:DATA\]](#)
- [TRACe:COPY](#)

TRACe<1|2>[:DATA]

Parameter

TRACE1 | TRACE2 | TRACE3 | TRACE4,<block> | <numeric_value>

TRACE1 to TRACE4 trace memory to be read out

<block> or <numeric_value> data to be transferred

For further details refer to "[TRACe<1|2>\[:DATA\]](#)" on page 6.256.

TRACe:COPY

Parameter

TRACE1 | TRACE2 | TRACE3 | TRACE4,TRACE1 | TRACE2 | TRACE3 | TRACE4

The first operand the destination of the data to be copied, the second operand describes the source.

For further details refer to "[TRACe:COPY](#)" on page 6.257.

TRIGger Subsystem (CATV, K20)

The TRIGger subsystem is used to synchronize instrument actions with events. It is thus possible to control and synchronize the start of a sweep.

Commands of the TRIGger Subsystem

- TRIGger<1|2>[:SEQuence]:HOLDOff[:TIME]
- TRIGger<1|2>[:SEQuence]:VIDeo:BFieLd[:NUMBer]
- TRIGger<1|2>[:SEQuence]:VIDeo:BLINe[:NUMBer]
- TRIGger<1|2>[:SEQuence]:VIDeo:BLINe:TYPE
- TRIGger<1|2>[:SEQuence]:VIDeo:FIELd[:NUMBer]
- TRIGger<1|2>[:SEQuence]:VIDeo:LINE[:NUMBer]
- TRIGger<1|2>[:SEQuence]:VIDeo:QFieLd[:NUMBer]
- TRIGger<1|2>[:SEQuence]:VIDeo:QLINe[:NUMBer]

TRIGger<1|2>[:SEQuence]:HOLDOff[:TIME]

For details refer to "TRIGger<1|2>[:SEQuence]:HOLDOff[:TIME]" on page 6.270.

TRIGger<1|2>[:SEQuence]:VIDeo:BFieLd[:NUMBer]

This command sets the bar field parameter for analog TV measurements.

Parameter

1 | 2

Example

```
TRIG:VID:BFI 2
```

Sets the bar field parameter to 2.

Characteristics

RST value: 1

SCPI: device-specific

Mode

CATV

TRIGger<1|2>[:SEQuence]:VIDeo:BLINe[:NUMBer]

This command sets the bar line parameter for analog TV measurements.

Parameter

<numeric_value>

Example

```
TRIG:VID:BLIN 16
```

Sets the bar line parameter to 16.

Characteristics

RST value: 18

SCPI: device-specific

Mode

CATV

TRIGger<1|2>[:SEQuence]:VIDeo:BLINe:TYPE

This command sets the bar line type for analog TV measurements.

Parameter

CCIR17 | FCC | NTC7

Example

TRIG:VID:BLIN:TYPE CCIR17

Sets the bar line type to CCIR17.

Characteristics

RST value: CCIR17

SCPI: device-specific

Mode

CATV

TRIGger<1|2>[:SEQuence]:VIDeo:FIELd:[NUMBer]

This command defines the active field in the Video Scope measurement.

Parameter

1 | 2

Example

TRIG:VID:FIEL 2

Sets the active field 2.

Characteristics

RST value: 1

SCPI: conform

Mode

CATV

TRIGger<1|2>[:SEQuence]:VIDeo:LINE:[NUMBer]

This command activates triggering at the horizontal sync signal of the indicated line number in the Video Scope measurement.

Parameter

<numeric_value>, depending on the numbering conventions of the TV standard and the color system

Example

TRIG:VID:LINE 17

Characteristics

*RST value: 1

SCPI: conform

Mode

CATV

TRIGger<1|2>[:SEQuence]:VIDeo:QFIeld[:NUMBer]

This command sets the quiet line field for analog TV measurements.

Parameter

1 | 2

Example

```
TRIG:VID:QFI 2
```

Sets the quiet line field to 2.

Characteristics

RST value: 1

SCPI: device-specific

Mode

CATV

TRIGger<1|2>[:SEQuence]:VIDeo:QLINe[:NUMBer]

This command sets the quiet line parameter for analog TV measurements.

Parameter

<numeric_value>

Example

```
TRIG:VID:QLIN 20
```

Sets the quiet line parameter to 20.

Characteristics

RST value: 22

SCPI: device-specific

Mode

CATV

UNIT Subsystem (CATV, K20)

The UNIT subsystem sets the basic unit of the setting parameters.

Commands of the UNIT Subsystem

- UNIT<1|2>:POWer

UNIT<1|2>:POWer

This command selects the default unit.

Parameter

DBM | DBUV | DBMV | DBPW | VOLT | V | W | WATT | A | AMPere

Example

```
UNIT:POW DBUV
```

Sets the power unit to dBm.

Characteristics

*RST value: DBM

SCPI: conform

Mode

CATV

Remote Commands of the Noise Figure Measurements Option (K30)

This section describes the remote commands for the Noise Figure Measurements option (K30). The abbreviation NF stands for the operating mode of noise figure measurements. For details on conventions used in this chapter refer to section "Notation" on page 6.2 at the beginning of this chapter.

For further information on analyzer or basic settings commands, refer to the corresponding subsystem in section "Remote Commands of the Base Unit" on page 6.5.

This option is available from firmware version 1.50.

Subsystems of the Noise Figure Measurements option (K30)

- "ABORt Subsystem (Noise Figure, K30)" on page 6.518
- "CALCulate Subsystem (Noise Figure, K30)" on page 6.519
- "CONFigure Subsystem (Noise Figure, K30)" on page 6.528
- "DISPlay Subsystem (Noise Figure, K30)" on page 6.530
- "FETCh Subsystem (Noise Figure, K30)" on page 6.536
- "INITiate Subsystem (Noise Figure, K30)" on page 6.540
- "INPut Subsystem (Noise Figure, K30)" on page 6.541
- "INSTrument Subsystem (Noise Figure, K30)" on page 6.542
- "SENSe Subsystem (Noise Figure, K30)" on page 6.543
- "STATus Subsystem (Noise Figure, K30)" on page 6.553
- "SYSTem Subsystem (Noise Figure, K30)" on page 6.558

ABORt Subsystem (Noise Figure, K30)

The ABORt subsystem contains the commands for aborting triggered actions.

Commands of the ABORt Subsystem

- [ABORt](#)

ABORt

For details refer to "[ABORt](#)" on page 6.10.

CALCulate Subsystem (Noise Figure, K30)

The CALCulate subsystem checks the marker functions and contains commands for limit lines and their limit checks.

The following subsystems are included:

- "CALCulate:LIMit Subsystem (Noise Figure, K30)" on page 6.519
- "CALCulate:MARKer Subsystem (Noise Figure, K30)" on page 6.525

CALCulate:LIMit Subsystem (Noise Figure, K30)

The CALCulate:LIMit subsystem contains commands for the limit lines and the corresponding limit checks. Limit lines can be defined as upper or lower limit lines. The individual y values of the limit lines correspond to the values of the x-axis (CONTRol). The number of x and y values must be identical. For details on limit lines refer to chapter "Instrument Functions", section "Using Limit Lines and Display Lines - LINES Key".

Different to the base unit, only 6 limit lines can be active at the same time (indicated by LIMIT1 to LIMIT6).

The following subsystems are included:

- "CALCulate:LIMit:CONTRol Subsystem" on page 6.522
- "CALCulate:LIMit:LOWer Subsystem" on page 6.523
- "CALCulate:LIMit:UPPer Subsystem" on page 6.524

Commands of the CALCulate:LIMit Subsystem

- CALCulate<1|2>:LIMit<1...6>:CLEar[:IMMediate]
- CALCulate<1|2>:LIMit<1...6>:COMMeNt
- CALCulate<1|2>:LIMit<1...6>:COpy
- CALCulate<1|2>:LIMit<1...6>:DELeTe
- CALCulate<1|2>:LIMit<1...6>:FAIL?
- CALCulate<1|2>:LIMit<1...6>:NAME
- CALCulate<1|2>:LIMit<1...6>:STATe
- CALCulate<1|2>:LIMit<1...6>:TRACe

CALCulate<1|2>:LIMit<1...6>:CLEar[:IMMediate]

Different to the base unit, only 6 limit lines can be active at the same time (indicated by LIMIT1 to LIMIT6).

For further details refer to "CALCulate<1|2>:LIMit<1...8>:CLEar[:IMMediate]" on page 6.29.

CALCulate<1|2>:LIMit<1...6>:COMMeNt

Different to the base unit, only 6 limit lines can be active at the same time (indicated by LIMIT1 to LIMIT6).

For further details refer to "CALCulate<1|2>:LIMit<1...8>:COMMeNt" on page 6.29.

CALCulate<1|2>:LIMit<1...6>:COPY

Parameter

1 to 6 number of the new limit line
 <name> name of the new limit line given as a string (max. 8 alphanumeric characters)

For further details refer to "[CALCulate<1|2>:LIMit<1...8>:COPY](#)" on page 6.30.

CALCulate<1|2>:LIMit<1...6>:DELEte

Different to the base unit, only 6 limit lines can be active at the same time (indicated by LIMIT1 to LIMIT6).

For further details refer to "[CALCulate<1|2>:LIMit<1...8>:DELEte](#)" on page 6.30.

CALCulate<1|2>:LIMit<1...6>:FAIL?

Different to the base unit, only 6 limit lines can be active at the same time (indicated by LIMIT1 to LIMIT6).

For further details refer to "[CALCulate<1|2>:LIMit<1...8>:FAIL?](#)" on page 6.30.

CALCulate<1|2>:LIMit<1...6>:NAME

This command assigns a name to a limit line. If it does not exist already, a limit line with this name is created.

The numeric suffixes <1...6> indicate the limit line.

Parameter

<name of limit line>, max. 8 alphanumeric characters

Example

```
CALC:LIM1:NAME FM1
```

Assigns the name FM1 to limit line 1.

Characteristics

*RST value: REM1 to REM6 for lines 1 to 6

SCPI: device-specific

Mode

NF

CALCulate<1|2>:LIMit<1...6>:STATe

Different to the base unit, only 6 limit lines can be active at the same time (indicated by LIMIT1 to LIMIT6).

For further details refer to "[CALCulate<1|2>:LIMit<1...8>:STATe](#)" on page 6.31.

CALCulate<1|2>:LIMit<1...6>:TRACe

This command assigns a limit line to a particular measurement type.
The numeric suffixes <1...6> indicate the limit line.

Parameter

NFIGure	noise figure
TEFFective	noise temperature
GAIN	gain

Example

```
CALC:LIM2:TRAC NFIG
```

Assigns limit line 2 to the noise figure measurement.

```
CALC:LIM3:TRAC GAIN
```

Assigns limit line 3 to the gain measurement.

Characteristics

*RST value: -

SCPI: device-specific

Mode

NF

CALCulate:LIMit:CONTRol Subsystem (Noise Figure, K30)

The CALCulate:LIMit:CONTRol subsystem defines the x-axis (CONTRol axis).

Commands of the CALCulate:LIMit:CONTRol Subsystem

- [CALCulate<1|2>:LIMit<1...6>:CONTRol\[:DATA\]](#)
- [CALCulate<1|2>:LIMit<1...6>:CONTRol:SHIFt](#)

CALCulate<1|2>:LIMit<1...6>:CONTRol[:DATA]

Different to the base unit, only 6 limit lines can be active at the same time (indicated by LIMIT1 to LIMIT6).

For further details refer to "[CALCulate<1|2>:LIMit<1...8>:CONTRol\[:DATA\]](#)" on page 6.41.

CALCulate<1|2>:LIMit<1...6>:CONTRol:SHIFt

Different to the base unit, only 6 limit lines can be active at the same time (indicated by LIMIT1 to LIMIT6).

For further details refer to "[CALCulate<1|2>:LIMit<1...8>:CONTRol:SHIFt](#)" on page 6.43.

CALCulate:LIMit:LOWer Subsystem (Noise Figure, K30)

The CALCulate:LIMit:LOWer subsystem defines the lower limit line. If a set command is issued in this subsystem the limit line effected is automatically converted to a lower limit line.

Commands of the CALCulate:LIMit:LOWer Subsystem

- [CALCulate<1|2>:LIMit<1...6>:LOWer\[:DATA\]](#)
- [CALCulate<1|2>:LIMit<1...6>:LOWer:SHIFt](#)
- [CALCulate<1|2>:LIMit<1...6>:LOWer:STATe](#)

CALCulate<1|2>:LIMit<1...6>:LOWer[:DATA]

Different to the base unit, only 6 limit lines can be active at the same time (indicated by LIMIT1 to LIMIT6).

For further details refer to "[CALCulate<1|2>:LIMit<1...8>:LOWer\[:DATA\]](#)" on page 6.47.

CALCulate<1|2>:LIMit<1...6>:LOWer:SHIFt

Different to the base unit, only 6 limit lines can be active at the same time (indicated by LIMIT1 to LIMIT6).

For further details refer to "[CALCulate<1|2>:LIMit<1...8>:LOWer:SHIFt](#)" on page 6.49.

CALCulate<1|2>:LIMit<1...6>:LOWer:STATe

Different to the base unit, only 6 limit lines can be active at the same time (indicated by LIMIT1 to LIMIT6).

For further details refer to "[CALCulate<1|2>:LIMit<1...8>:LOWer:STATe](#)" on page 6.48.

CALCulate:LIMit:UPPer Subsystem (Noise Figure, K30)

The CALCulate:LIMit:UPPer subsystem defines the upper limit line. If a set command is issued in this subsystem the limit line effected is automatically converted to an upper limit line.

Commands of the CALCulate:LIMit:UPPer Subsystem

- [CALCulate<1|2>:LIMit<1...6>:UPPer\[:DATA\]](#)
- [CALCulate<1|2>:LIMit<1...6>:UPPer:SHIFt](#)
- [CALCulate<1|2>:LIMit<1...6>:UPPer:STATe](#)

CALCulate<1|2>:LIMit<1...6>:UPPer[:DATA]

Different to the basic unit, only 6 limit lines can be active at the same time (indicated by LIMIT1 to LIMIT6).

For further details refer to "[CALCulate<1|2>:LIMit<1...8>:UPPer\[:DATA\]](#)" on page 6.51.

CALCulate<1|2>:LIMit<1...6>:UPPer:SHIFt

Different to the base unit, only 6 limit lines can be active at the same time (indicated by LIMIT1 to LIMIT6).

For further details refer to "[CALCulate<1|2>:LIMit<1...8>:UPPer:SHIFt](#)" on page 6.53.

CALCulate<1|2>:LIMit<1...6>:UPPer:STATe

Different to the base unit, only 6 limit lines can be active at the same time (indicated by LIMIT1 to LIMIT6).

For further details refer to "[CALCulate<1|2>:LIMit<1...8>:UPPer:STATe](#)" on page 6.54.

CALCulate:MARKer Subsystem (Noise Figure, K30)

The CALCulate:MARKer subsystem checks the marker functions of the instrument.

Commands of the CALCulate:MARKer Subsystem

- CALCulate:MARKer[:STATe]
- CALCulate:MARKer:AOff
- CALCulate:MARKer:TRACe
- CALCulate:MARKer:X
- CALCulate:MARKer:Y?
- CALCulate:MARKer:MAXimum[:PEAK]
- CALCulate:MARKer:MiNimum[:PEAK]

CALCulate:MARKer[:STATe]

This command switches on or off the marker 1 for the selected trace. It is only available if measurement results are displayed.

If the selected trace is switched off (`DISPlay[:WINDow<1>]:TRACe<1|2>[:STATe]`), the marker is also switched off. If the marker is switched on again, the marker is set to the active trace. If both noise and gain traces are switched off, the marker can not be switched on again.

This command is available from firmware version 1.60.

Parameter

ON | OFF

Example

```
CALC:MARK ON
```

Marker 1 is switched on.

Characteristics

RST value: OFF

SCPI: device-specific

Mode

NF

CALCulate:MARKer:AOff

This command switches off the marker 1.

This command is an event and therefore has no *RST value and no query.

This command is available from firmware version 1.60.

Example

```
CALC:MARK:AOff
```

Marker 1 is switched off.

Characteristics

RST value: -

SCPI: device-specific

Mode

NF

CALCulate:MARKer:TRACe

This command assigns the marker1 to the indicated trace.
This command is available from firmware version 1.60.

Parameter

NOISe | GAIN

Example

```
CALC:MARK:TRAC GAIN
```

Assigns marker 1 to the gain trace.

Characteristics

RST value: NOIS
SCPI: device-specific

Mode

NF

CALCulate:MARKer:X

This command positions the marker1 to the indicated frequency measurement point. If the marker is off, it is switched on first.
This command is available from firmware version 1.60.

Parameter

0 to MAX (frequency | sweep time)

Example

```
CALC:MARK:X 550 MHZ
```

Positions marker 1 to frequency 550 MHz.

Characteristics

RST value: -
SCPI: device-specific

Mode

NF

CALCulate:MARKer:Y?

This command queries the measured value of the marker 1. If the marker is off, it is switched on first. To obtain a valid query result, a complete sweep with synchronization to the sweep end must be performed before the query of the y value. The query result is output in the unit determined with the selected trace (see also `DISPlay:DATA:TRACe<1>` command).

This command is only a query and therefore has no *RST value.

This command is available from firmware version 1.60.

Example

```
CALC:MARK:Y?
```

Outputs the measured value of marker 1.

Characteristics

RST value: -
SCPI: device-specific

ModeNF

CALCulate:MARKer:MAXimum[:PEAK]

This command positions the marker to the current maximum value of the selected trace (`CALCulate:MARKer:TRACe` command). If the marker is off, it is switched on first.

This command is an event and therefore has no *RST value and no query.

This command is available from firmware version 1.60.

Example

```
CALC:MARK:MAX
```

Positions marker 1 to the maximum of the selected trace.

Characteristics

RST value: -

SCPI: device-specific

ModeNF

CALCulate:MARKer:MiNimum[:PEAK]

This command positions the marker to the current minimum value of the selected trace (`CALCulate:MARKer:TRACe` command). If the marker is off, it is switched on first.

This command is an event and therefore has no *RST value and no query.

This command is available from firmware version 1.60.

Example

```
CALC:MARK:MIN
```

Positions marker 1 to the minimum of the selected trace.

Characteristics

RST value: -

SCPI: device-specific

ModeNF

CONFigure Subsystem (Noise Figure, K30)

The CONFigure subsystem contains commands for configuring complex measurement tasks.

Commands of the CONFigure Subsystem

- CONFigure:ARRay:MEMory<1...3>
- CONFigure:CORRection
- CONFigure:LIST:CONTInuous
- CONFigure:LIST:SINGle
- CONFigure:SINGle

CONFigure:ARRay:MEMory<1...3>

This command saves the current trace results (noise figure, noise temperature and noise gain traces) to trace memory <n>.

This command is an event and therefore has no *RST value and no query.

This command is available from firmware version 1.60.

Parameter

ONCE

Example

INIT

Starts a new measurement, if no measurement sequence is already in progress.

CONF:ARR:MEM2 ONCE

Copies the last recorded measurement result into the memory 2.

Characteristics

RST value: -

SCPI: device-specific

Mode

NF

CONFigure:CORRection

This command configures for a second stage correction measurement.

This command is an event and therefore has no *RST value and no query.

Example

CONF:CORR

Configures to run second stage correction measure measurements.

INIT

Starts a new measurement, if no measurement sequence is already in progress.

Characteristics

*RST value: -

SCPI: device-specific

Mode

NF

CONFigure:LIST:CONTInuous

This command configures for a frequency list measurement in continuous sweep mode.
This command is an event and therefore has no *RST value and no query.

Example

```
CONF:LIST:CONT
```

Configures to run a frequency list measurement in continuous sweep mode.

```
INIT
```

Starts a new measurement, if no measurement sequence is already in progress.

Characteristics

*RST value: -

SCPI: device-specific

Mode

NF

CONFigure:LIST:SINGle

This command configures for a frequency list measurement in single sweep mode.
This command is an event and therefore has no *RST value and no query.

Example

```
CONF:LIST:SING
```

Configures to run frequency list measurement in single sweep modes.

```
INIT
```

Starts a new measurement, if no measurement sequence is already in progress.

Characteristics

*RST value: -

SCPI: device-specific

Mode

NF

CONFigure:SINGle

This command configures for a fixed frequency measurement.
This command is an event and therefore has no *RST value and no query.

Example

```
CONF:SING
```

Configures to run fixed frequency measurements.

```
INIT
```

Starts a new measurement, if no measurement sequence is already in progress.

Characteristics

*RST value: -

SCPI: device-specific

Mode

NF

DISPlay Subsystem (Noise Figure, K30)

The DISPlay subsystem controls the selection and presentation of textual and graphic information as well as of measurement data on the display.

Commands of the DISPlay Subsystem

- DISPlay:ARRay:MEMory<1...3>[:STATe]
- DISPlay:CURRent:DATA[:STATe]
- DISPlay:DATA:TRACe<1>
- DISPlay:FORMat
- DISPlay[:WINDow<1>]:TABLe
- DISPlay[:WINDow<1>]:TRACe<1|2>[:STATe]
- DISPlay[:WINDow<1>]:TRACe<1|2>:SYMBols
- DISPlay[:WINDow<1>]:TRACe<1|2>:X[:SCALe]
- DISPlay[:WINDow<1>]:TRACe<1|2>:Y[:SCALe]:AUTO
- DISPlay[:WINDow<1>]:TRACe<1|2>:Y[:SCALe]:BOTTOm
- DISPlay[:WINDow<1>]:TRACe<1|2>:Y[:SCALe]:RLEVel
- DISPlay[:WINDow<1>]:TRACe<1|2>:Y[:SCALe]:RLEVel:AUTO
- DISPlay[:WINDow<1>]:TRACe<1|2>:Y[:SCALe]:TOP

DISPlay:ARRay:MEMory<1...3>[:STATe]

This command switches the display of trace memory <n> on or off.

This command is available from firmware version 1.60.

Parameter

ON | OFF

Example

```
DISP:ARR:MEM2 ON
```

Switches on the display of memory 2.

Characteristics

RST value: OFF

SCPI: device-specific

Mode

NF

DISPlay:CURRent:DATA[:STATe]

This command switches the display of the current measurement results on or off.

This command is available from firmware version 1.60.

Parameter

ON | OFF

Example

```
DISP:CURR:DATA OFF
```

Removes the current result traces from display.

Characteristics

RST value: ON

SCPI: device-specific

Mode

NF

DISPlay:DATA:TRACe<1>

This command specifies the type of noise results to be displayed in trace 1.

Only the numeric suffix <1> for noise results is valid.

Parameter

NFIGure noise figure results in dB

TEFFective noise temperature in K

Example

```
DISP:DATA:TRAC1 NFIG
```

Displays the noise figure results in trace 1.

Characteristics

*RST value: NFIGure

SCPI: device-specific

Mode

NF

DISPlay:FORMat

This command activates or deactivates the combined trace display of noise and gain results.

Parameter

SPLit | SINGle

Example

```
DISP:FORM SPL
```

Displays noise and gain results in separate graphs.

Characteristics

*RST value: SING

SCPI: device-specific

Mode

NF

DISPlay[:WINDow<1>]:TABLe

This command activates or deactivates the tabular result display.

Parameter

ON | OFF

Example

```
DISP:TABL ON
```

Displays the table of results.

Characteristics

*RST value: OFF

SCPI: device-specific

Mode

NF

DISPlay[:WINDow<1>]:TRACe<1|2>[:STATe]

This command activates or deactivates the display of the corresponding trace and related information.

The numeric suffixes <1|2> indicate the measurement results: Trace 1 is always used for noise results, and trace 2 is always used for gain results.

Parameter

ON | OFF

Example

```
DISP:TRAC OFF
```

Switches off the display of trace 1 (noise results).

```
DISP:TRAC2 OFF
```

Switches off the display of trace 2 (gain results).

Characteristics

*RST value: ON for both traces

SCPI: conform

Mode

NF

DISPlay[:WINDow<1>]:TRACe<1|2>:SYMBols

This command activates or deactivates the display of the symbols to mark the measurement points for the specified trace.

The numeric suffixes <1|2> indicate the measurement results: Trace 1 is always used for noise results, and trace 2 is always used for gain results.

Parameter

ON | OFF

Example

```
DISP:TRAC ON
```

Switches on the display of trace 1 (noise results).

```
DISP:TRAC:SYMB ON
```

Switches on the display of symbols for trace 1 (noise results)

Characteristics

*RST value: OFF for both traces

SCPI: device-specific

Mode

NF

DISPlay[:WINDow<1>]:TRACe<1|2>:X[:SCALE]

This command selects the frequency to be displayed on the x-axis if the DUT is not an amplifier, i.e. in a frequency-converting measurement mode.

The numeric suffixes <1|2> indicate the measurement results: Trace 1 is always used for noise results, and trace 2 is always used for gain results.

Parameter

IF | RF

Example

```
CONF:MODE:DUT DOWN
```

The DUT converts the input frequency to a lower output frequency.

```
DISP:TRAC:X IF
```

The IF frequency is displayed on x-axis.

Characteristics

*RST value: RF

SCPI: device-specific

Mode

NF

DISPlay[:WINDow<1>]:TRACe<1|2>:Y[:SCALE]:AUTO

This command activates or deactivates the automatic scaling of the Y-axis for the specified trace display. Automatic scaling provides best fit of the Y-axis to the measurement results.

The numeric suffixes <1|2> indicate the measurement results: Trace 1 is always used for noise results, and trace 2 is always used for gain results.

Parameter

ON | OFF

Example

```
DISP:TRAC2 ON
```

Switches on the display of trace 2 (gain results).

```
DISP:TRAC2:Y:AUTO ON
```

Switches on automatic scaling of the Y-axis for trace 2.

Characteristics

*RST value: ON for both traces

SCPI: conform

Mode

NF

DISPlay[:WINDow<1>]:TRACe<1|2>:Y[:SCALE]:BOTTom

This command sets the minimum (bottom) Y-axis display value for the specified trace display. It has no affect if automatic scaling of the Y-axis is enabled

([DISPlay\[:WINDow<1>\]:TRACe<1|2>:Y\[:SCALE\]:AUTO](#) command).

The numeric suffixes <1|2> indicate the measurement results: Trace 1 is always used for noise results, and trace 2 is always used for gain results.

Parameter

noise figure: -75 dB to 75 dB
 noise temperature: -999990000 K to 999990000 K
 gain: -75 dB to 75 dB

Example 1

DISP:DATA:TRAC1 NFIG
 Sets the noise figure to trace1.
 DISP:TRAC ON
 Switches on the display of trace 1 (noise results).
 DISP:TRAC:Y:BOTT -30
 Sets the minimum Y-axis display to -30 dB for trace 1.

Example 2

DISP:DATA:TRAC1 TEFF
 Sets the noise temperature to trace1.
 DISP:TRAC ON
 Switches on the display of trace 1 (noise results).
 DISP:TRAC:Y:BOTT 100
 Sets the minimum Y-axis display to 100 K for trace 1.

Example 3

DISP:TRAC2 ON
 Switches on the display of trace 2 (gain results).
 DISP:TRAC2:Y:BOTT 1
 Sets the minimum Y-axis display to 1 dB for trace 2.

Characteristics

*RST value: 0 dB
 SCPI: conform

Mode

NF

DISPlay[:WINDow<1>]:TRACe<1|2>:Y[:SCALe]:RLEVel

This command sets the reference level for the Y-axis display value for all trace displays. This command has no affect if automatic reference level detection is enabled (DISPlay[:WINDow<1>]:TRACe<1|2>:Y[:SCALe]:RLEVel:AUTO command).
 The numeric suffixes <1|2> are irrelevant for this command.

Parameter

<numeric_value> in dBm, range specified in data sheet

Example

DISP:TRAC:Y:RLEV 0
 Sets the reference level 0 dBm

Characteristics

*RST value: -30 dBm
 SCPI: conform

Mode

NF

DISPlay[:WINDow<1>]:TRACe<1|2>:Y[:SCALe]:RLEV:AUtO

This command enables or disables the automatic reference level detection.
The numeric suffixes <1|2> are irrelevant for this command.

Parameter

ON | OFF

Example

```
DISP:TRAC:Y:RLEV:AUTO ON
```

Turns on automatic reference level detection.

Characteristics

*RST value: ON

SCPI: conform

Mode

NF

DISPlay[:WINDow<1>]:TRACe<1|2>:Y[:SCALe]:TOP

This command sets the maximum (top) Y-axis display value for the specified trace display. It has no affect if automatic scaling of the Y-axis is enabled or the specified trace is not currently active.

The numeric suffixes <1|2> indicate the measurement results: Trace 1 is always used for noise results, and trace 2 is always used for gain results.

Parameter

noise figure: -75 dB to 75 dB
noise temperature: -999990000 K to 999990000 K
gain: -75 dB to 75 dB

Example 1

```
DISP:DATA:TRAC1 NFIG
```

Sets the noise figure to trace1.

```
DISP:TRAC:Y:TOP 30
```

Sets the maximum Y-axis display to 30 dB for trace 1.

Example 2

```
DISP:DATA:TRAC1 TEFf
```

Sets the noise temperature to trace1.

```
DISP:TRAC:Y:TOP 100
```

Sets the maximum Y-axis display to 100 K for trace 1.

Example 3

```
DISP:TRAC2:Y:TOP 10
```

Sets the maximum Y-axis display to 10 dB for trace 2.

Characteristics

*RST value: 20 dB for noise and gain figure, 10000K for noise temperature

SCPI: conform

Mode

NF

FETCh Subsystem (Noise Figure, K30)

The FETCh subsystem retrieves results for the most recently completed fixed frequency or frequency list measurements. Frequency list results are returned as a list of results where the result is that requested in the specific fetch command. Single frequency results are single numbers in the described units.



Corrected measurements are only accessible after a calibration has been performed.

Commands of the FETCh Subsystem

- FETCh:ARRay:MEMory<1...3>:NOISe:FIGure?
- FETCh:ARRay:MEMory<1...3>:NOISe:GAIN?
- FETCh:ARRay:MEMory<1...3>:NOISe:TEMPerature?
- FETCh:ARRay:NOISe:FIGure?
- FETCh:ARRay:NOISe:GAIN?
- FETCh:ARRay:NOISe:TEMPerature?
- FETCh:SCALar:NOISe:FIGure?
- FETCh:SCALar:NOISe:GAIN?
- FETCh:SCALar:NOISe:TEMPerature?

FETCh:ARRay:MEMory<1...3>:NOISe:FIGure?

This command queries the noise measurement results of the selected memory. The results are returned as an array of up to 100 elements of noise figure results. This command produces an error if no data is held in the selected trace memory.

This command is only a query and therefore has no *RST value.

This command is available from firmware version 1.60.

Example

INIT

Starts a new measurement, if no measurement sequence is already in progress.

CONF:ARR:MEM2 ONCE

Copies the last recorded measurement result into the memory 2.

FETC:ARR:MEM2:NOIS:FIG?

Returns an array of 100 noise figure results from the selected memory 2.

Characteristics

RST value: -

SCPI: device-specific

Mode

NF

FETCh:ARRay:MEMory<1...3>:NOISe:GAIN?

This command queries the noise measurement results of the selected memory. The results are returned as an array of up to 100 elements of noise gain results. This command produces an error if no data is held in the selected trace memory.

This command is only a query and therefore has no *RST value.

This command is available from firmware version 1.60.

Example

INIT

Starts a new measurement, if no measurement sequence is already in progress.

CONF:ARR:MEM2 ONCE

Copies the last recorded measurement result into the memory 2.

FETC:ARR:MEM2:NOIS:GAIN?

Returns an array of 100 noise gain results from the selected memory 2.

Characteristics

RST value: -

SCPI: device-specific

Mode

NF

FETCh:ARRay:MEMory<1...3>:NOISe:TEMPerature?

This command queries the noise measurement results of the selected memory. The results are returned as an array of up to 100 elements of noise temperature results. This command produces an error if no data is held in the selected trace memory.

This command is only a query and therefore has no *RST value.

This command is available from firmware version 1.60.

Example

INIT

Starts a new measurement, if no measurement sequence is already in progress.

CONF:ARR:MEM2 ONCE

Copies the last recorded measurement result into the memory 2.

FETC:ARR:MEM2:NOIS:TEMP?

Returns an array of 100 noise temperature results from the selected memory 2.

Characteristics

RST value: -

SCPI: device-specific

Mode

NF

FETCh:ARRay:NOISe:FIGure?

This command queries the last recorded noise figure measurement results. The results are returned as an array of up to 100 elements of noise figure results.

This command is only a query and therefore has no *RST value.

Example

FETCh:ARRay:NOISe:FIGure?

Returns an array of 100 measured elements associated with the last noise figure measurement.

Characteristics

*RST value: -

SCPI: device-specific

Mode

NF

FETCh:ARRay:NOISE:GAIN?

This command queries the last recorded noise gain measurement results. The results are returned as an array of up to 100 elements of noise gain results.

This command is only a query and therefore has no *RST value.

Example

```
FETCh:ARRay:NOISE:GAIN?
```

Returns an array of 100 measured elements associated with the last noise gain measurement.

Characteristics

*RST value: -

SCPI: device-specific

Mode

NF

FETCh:ARRay:NOISE:TEMPerature?

This command queries the last recorded noise temperature measurement results. The results are returned as an array of up to 100 elements of noise temperature results.

This command is only a query and therefore has no *RST value.

Example

```
FETCh:ARRay:NOISE:TEMPerature?
```

Returns an array of 100 measured elements associated with the last noise temperature measurement.

Characteristics

*RST value: -

SCPI: device-specific

Mode

NF

FETCh:SCALar:NOISE:FIGure?

This command queries the last recorded noise figure measurement result for a fixed frequency measurement.

This command is only a query and therefore has no *RST value.

Example

```
FETCh:SCAL:NOISE:FIGure?
```

Returns the last noise figure measurement obtained from a fixed frequency measurement.

Characteristics

*RST value: -

SCPI: device-specific

ModeNF

FETCh:SCALar:NOISE:GAIN?

This command queries the last recorded noise gain measurement result for a fixed frequency measurement.

This command is only a query and therefore has no *RST value.

Example

```
FETCh:SCAL:NOISE:GAIN?
```

Returns the last noise gain measurement obtained from a fixed frequency measurement.

Characteristics

*RST value: -

SCPI: device-specific

ModeNF

FETCh:SCALar:NOISE:TEMPerature?

This command queries the last recorded noise temperature measurement result for a fixed frequency measurement.

This command is only a query and therefore has no *RST value.

Example

```
FETCh:SCAL:NOISE:TEMPerature?
```

Returns the last noise temperature measurement obtained from a fixed frequency measurement.

Characteristics

*RST value: -

SCPI: device-specific

ModeNF

INITiate Subsystem (Noise Figure, K30)

The INITiate subsystem configures the instrument prior to a measurement being carried out. It is basically used to tell the instrument which measurement is to be performed and takes any necessary step to set up the instrument for the measurement.

Commands of the INPut Subsystem

- [INITiate\[:IMMediate\]](#)

INITiate[:IMMediate]

This command initiates the start of a new measurement sequence. If a measurement sequence is already in progress, the command is ignored.

This command is an event and therefore has no *RST value and no query.

Example

```
INIT
```

Starts a new measurement, if no measurement sequence is already in progress.

Characteristics

*RST value: -

SCPI: conform

Mode

NF

INPut Subsystem (Noise Figure, K30)

The INPut subsystem controls the input characteristics of the RF inputs of the instrument.

Commands of the INPut Subsystem

- [INPut<1|2>:ATTenuation](#)
- [INPut<1|2>:GAIN:STATe](#) (option RF Preamplifier, B22)

INPut<1|2>:ATTenuation

For details refer to "[INPut<1|2>:ATTenuation](#)" on page 6.146.

INPut<1|2>:GAIN:STATe (option RF Preamplifier, B22)

For details refer to "[INPut<1|2>:GAIN:STATe](#)" on page 6.147.

INSTRument Subsystem (Noise Figure, K30)

Commands of the INSTRument Subsystem

- [INSTRument\[:SElect\]](#)
- [INSTRument:NSElect](#)

INSTRument[:SElect]

Parameter

NOISe (Noise Figure Measurements option, R&S FSL-K30)
For further details refer to section "INSTRument Subsystem".

INSTRument:NSElect

Parameter

19 (Noise Figure Measurements option, R&S FSL-K30)
For further details refer to section "INSTRument Subsystem".

SENSe Subsystem (Noise Figure, K30)

The SENSe subsystem is used to set and query the values of parameters in the remote instrument.

- :DEFault** If a parameter has a default a value, the command parameter can be substituted with :DEFault which loads the default (reset) value of the parameter.
- :UP/DOWN** In addition, all numeric values are able to take :UP or :DOWN in place of the parameter. This will increment or decrement the numeric value.
- :MIN/MAX** In addition, all numeric values are able to take either :MINimum or :MAXimum as arguments to determine the minimum or maximum range available for the command.

The SENSe subsystem is divided into equipment settings and measurement settings:

- ["Equipment Settings"](#) on page 6.543
- ["Measurement Settings"](#) on page 6.549

Equipment Settings

Commands of the equipment settings

- [\[SENSe:\]CORRection\[:STATe\]](#)
- [\[SENSe:\]CORRection:ENR:MODE](#)
- [\[SENSe:\]CORRection:ENR:SPOT](#)
- [\[SENSe:\]CORRection:ENR\[:MEASurement\]:TABLE:DATA](#)
- [\[SENSe:\]CORRection:IREJection](#)
- [\[SENSe:\]CORRection:LOSS:INPut:MODE](#)
- [\[SENSe:\]CORRection:LOSS:INPut:SPOT](#)
- [\[SENSe:\]CORRection:LOSS:INPut:TABLE](#)
- [\[SENSe:\]CORRection:LOSS:OUTPut:MODE](#)
- [\[SENSe:\]CORRection:LOSS:OUTPut:SPOT](#)
- [\[SENSe:\]CORRection:LOSS:OUTPut:TABLE](#)
- [\[SENSe:\]CORRection:TEMPerature](#)

[SENSe:]CORRection[:STATe]

This command activates or deactivates the second stage correction.

Parameter

ON | OFF

Example

CORR ON

Activates the second stage correction.

Characteristics

*RST value: OFF

SCPI: device-specific

Mode

NF

[SENSe:]CORRection:ENR:MODE

This command specifies whether a constant ENR value applies for all measured frequencies or an ENR table (ENR values specified at specific input frequencies). The constant ENR value is specified by the [SENSe:]CORRection:ENR:SPOT command.

Parameter

TABLE ENR table is used.
 SPOT Constant ENR value is used.

Example

```
CORR:ENR:MODE SPOT
```

Uses the configured constant ENR value for all measured frequencies.

Characteristics

*RST value: SPOT
 SCPI: device-specific

Mode

NF

[SENSe:]CORRection:ENR:SPOT

This command sets the constant ENR value of the noise source that is used throughout the entire frequency range.

Parameter

-999.99 to 999.99 dB

Example

```
CORR:ENR:MODE SPOT
```

Uses the configured constant ENR value for all measured frequencies.

```
CORR:ENR:SPOT 30
```

Sets the constant ENR value to 30 dB for all input frequencies to be measured.

Characteristics

*RST value: 15 dB
 SCPI: device-specific

Mode

NF

[SENSe:]CORRection:ENR[:MEASurement]:TABLE:DATA

This command specifies a new ENR table to determine the correct ENR (excess noise ratio) figure to be used for the input frequencies. This new list completely overwrites all current ENR frequency list entries regardless of how many entries are present and how many entries are being supplied for the new list.

Parameter

<numeric_value>, <numeric_value>, ... (maximum of 100 argument pairs)

numeric value = a frequency ENR pair of arguments

frequency: 0 Hz to 999.99 GHz.

ENR figure: -999.99 to 999.99 (value in dB, accurate to two decimal places)

Example

```
CORR:ENR:MODE TABL
```

Uses the ENR table.

```
CORR:ENR:MEAS:TABL:DATA 1MHZ,10,2MHZ,12
```

Specifies a new ENR table and overwrites the current ENR table with the two entry pairs specified.

Characteristics

*RST value: -

SCPI: device-specific

Mode

NF

[SENSe:]CORRection:IREJection

This command specifies an image rejection value for the selected DUT (`[SENSe:]CONFigure:MODE:DUT` command) which will be effective throughout the entire frequency range.

Parameter

0 dB to 999.99 dB

Example

```
CONF:MODE:DUT DOWN
```

The DUT converts the input frequency to a lower output frequency.

```
CORR:IREJ 100
```

Sets an image rejection value of 100 dB.

Characteristics

*RST value: 999.99 dB

SCPI: device-specific

Mode

NF

[SENSe:]CORRection:LOSS:INPut:MODE

This command specifies whether a constant input loss value applies for all measured frequencies or an input loss list (loss input values specified at specific input frequencies). The constant loss input value is specified by the `[SENSe:]CORRection:LOSS:INPut:SPOT` command.

Parameter

SPOT The constant loss input value for all measurement frequencies is used.

TABLE The loss input table is used.

Example

```
CORR:LOSS:INP:MODE SPOT
```

Uses the configured constant loss input value for all input frequencies to be measured.

Characteristics

*RST value: SPOT

SCPI: device-specific

Mode

NF

[SENSe:]CORRection:LOSS:INPut:SPOT

This command specifies the loss input constant for all input frequencies to be measured.

Parameter

-999.99 to 999.99 dB, accurate to two decimal places

Example

```
CORR:LOSS:INP:MODE SPOT
```

Uses the configured constant spot loss input value for all input frequencies to be measured.

```
CORR:LOSS:INP:SPOT 10
```

Sets the internal input loss constant value to 10 dB for all input frequencies to be measured.

Characteristics

*RST value: 0 dB

SCPI: device-specific

Mode

NF

[SENSe:]CORRection:LOSS:INPut:TABLE

This command specifies a new input loss table to determine the correct input loss to be used for the input frequencies. This new list completely overwrites all current input loss list entries regardless of how many entries are present and how many entries are being supplied for the new list.

Parameter

<numeric_value>,<numeric_value>,... (maximum of 100 argument pairs)

<numeric_value>,<numeric_value> = a frequency loss pair of arguments

frequency: 0 Hz to 999.99 GHz (max. two decimal places)

loss figure: -999.99 to 999.99 (value in dB, accurate to two decimal places)

Example

```
CORR:LOSS:INP:MODE TABL
```

Uses the loss input table.

```
CORR:LOSS:INP:TABL 1MHz,10,2MHz,12
```

Specifies a new input loss table and overwrites the current input loss table with the two entry pairs specified.

Characteristics

*RST value: -

SCPI: device-specific

Mode

NF

[SENSe:]CORRection:LOSS:OUTPut:MODE

This command specifies whether a constant output loss value applies for all measured frequencies or an output loss list (loss output values specified at specific input frequencies). The constant loss output value is specified by the `[SENSe:]CORRection:LOSS:OUTPut:SPOT` command.

Parameter

SPOT The constant loss input value for all measurement frequencies is used.
TABLE The loss input table is used.

Example

```
CORR:LOSS:OUTP:MODE SPOT
```

Uses the configured constant loss output value for all input frequencies to be measured.

Characteristics

*RST value: SPOT
 SCPI: device-specific

Mode

NF

[SENSe:]CORRection:LOSS:OUTPut:SPOT

This command specifies the loss output constant for all input frequencies to be measured.

Parameter

-999.99 to 999.99 dB, accurate to two decimal places

Example

```
CORR:LOSS:OUTP:MODE SPOT
```

Uses the configured constant loss output value for all input frequencies to be measured.

```
CORR:LOSS:OUTP:SPOT 10
```

Sets the internal output loss constant value to 10 dB for all input frequencies to be measured.

Characteristics

*RST value: 0 dB
 SCPI: device-specific

Mode

NF

[SENSe:]CORRection:LOSS:OUTPut:TABLE

This command specifies a new output loss table to determine the correct output loss to be used for the input frequencies. This new list completely overwrites all current output loss list entries regardless of how many entries are present and how many entries are being supplied for the new list.

Parameter

<numeric_value>,<numeric_value>,... (maximum of 100 argument pairs)

<numeric_value>,<numeric_value> = a frequency loss pair of arguments

frequency: 0 Hz to 999.99 GHz (max. two decimal places)

loss figure: -999.99 to 999.99 (value in dB, accurate to two decimal places)

Example

```
CORR:LOSS:OUTP:MODE TABL
```

Uses the loss output table.

```
CORR:LOSS:OUTP:TABL 1MHz,10,2MHz,12
```

Specifies a new output loss table and overwrites the current output loss table with the two entry pairs specified.

Characteristics

*RST value: -

SCPI: device-specific

Mode

NF

[SENSe:]CORRection:TEMPerature

This command specifies the room temperature of the operating environment. This value is taken into account when calculating noise results.

Parameter

278.15 to 318.15 K; up to 2 decimal places can be specified.

Example

```
CORR:TEMP 291.50
```

Specifies the room temperature to 291.50 Kelvin (18.5 C).

Characteristics

*RST value: 293 K

SCPI: device-specific

Mode

NF

Measurement Settings

Commands of the measurement settings

- [SENSe:]BANDwidth|BWIDth[:RESolution]
- [SENSe:]CONFigure:MODE:DUT
- [SENSe:]CONFigure:MODE:SYSTem:LOSCillator:FREQuency
- [SENSe:]FREQuency[:CW]:FIXed]
- [SENSe:]FREQuency:LIST:DATA
- [SENSe:]FREQuency:START
- [SENSe:]FREQuency:STEP
- [SENSe:]FREQuency:STOP
- [SENSe:]SWEep:COUNT
- [SENSe:]SWEep:TIME

[SENSe:]BANDwidth|BWIDth[:RESolution]

For details refer to "[SENSe<1|2>:]BANDwidth|BWIDth[:RESolution]" on page 6.170.

[SENSe:]CONFigure:MODE:DUT

This command defines the type of DUT. This setting determines the method that is used to create the frequency measurement list. Fixed local oscillator frequencies are taken from the settings supplied by [SENSe:]CONFigure:MODE:SYSTem:LOSCillator:FREQuency.

Parameter

AMPLifier	The DUT is an amplifier and not a frequency converting device.
DOWNconv	The DUT converts the input frequency to a lower output frequency: Fixed LO, $IF=RF+LO$
UPConv	The DUT converts the input frequency to a higher output frequency: Fixed LO, $IF=abs(RF-LO)$.

Example

```
SENS:CONF:MODE:DUT DOWN
```

The DUT converts the input frequency to a lower output frequency.

Characteristics

*RST value: AMPLifier

SCPI: device-specific

Mode

NF

[SENSe:]CONFigure:MODE:SYSTem:LOSCillator:FREQuency

This command specifies a fixed local oscillator frequency for a new frequency measurement list in frequency-converting measurement mode. If this value is altered, a new frequency list is generated.

Parameter

0 Hz to 999.99 GHz

Example

```
SENS:CONF:MODE:DUT DOWN
```

The DUT converts the input frequency to a lower output frequency.

```
SENS:CONF:MODE:SYST:LOSC:FREQ 1MHZ
```

Specifies the fixed local oscillator frequency for a new list to a value of 1 MHz.

Characteristics

*RST value: - 0 Hz

SCPI: device-specific

Mode

NF

[SENSe:]FREQuency[:CW]:FIXed]

This command specifies a fixed frequency to measure noise and gain continuously (fixed frequency measurement).

Parameter

<numeric value>

Example

```
CONF:SING
```

Configures to run fixed frequency measurements.

```
FREQ 10MHz
```

Sets a fixed frequency of 10 MHz.

Characteristics

*RST value: 550 MHz

SCPI: conform

Mode

NF

[SENSe:]FREQuency:LIST:DATA

This command specifies a new frequency list (for frequency list measurement). Each list entry consists of three separate frequency entities: a receive frequency (RF), a local oscillator frequency (LO), and an intermediate frequency (IF). The new list completely overwrites all the current frequency list entries regardless of how many entries are present and how many entries are being supplied for the new list. The new list is the active list until a new list is automatically created.

The values specified in this command are not used for a fixed frequency measurement ([CONFigure:SINGle](#) command).

Parameter

<numeric_value>,<numeric_value>, ... (max. of 100 argument)

numeric value = set of three frequency measurements in the following order: fixed frequency, local oscillator frequency, and intermediate frequency. The frequency range depends on the selected measurement mode:

direct measurement	RF: 0 Hz to f_{\max}
frequency-converting measurement	RF, LO: 0 Hz to 999.99 GHz IF: 0 Hz to f_{\max}

Example

```
FREQ:LIST:DATA 550MHz,300MHz,900MHz
```

Specifies one entry frequency list with a receive frequency of 550 MHz, a local oscillator frequency of 300 MHz, and an intermediate frequency of 900 MHz.

Characteristics

*RST value: 550 MHz | 0 Hz | 550 MHz

SCPI: device-specific

Mode

NF

[SENSe:]FREQuency:START

This command specifies the start frequency for a new frequency measurement list. If this value is altered, a new frequency list is generated.

Parameter

<numeric value>

Example

```
FREQ:STAR 500MHZ
```

Sets the start frequency for a new list to a value of 500 MHz.

Characteristics

*RST value: 550 MHz

SCPI: conform

Mode

NF

[SENSe:]FREQuency:STEP

This command specifies the step frequency for a new frequency measurement list. If this value is altered, a new frequency list is generated.

Parameter

<numeric value>

Example

```
FREQ:STEP 10MHZ
```

Sets the step frequency for a new list to a value of 10 MHz.

Characteristics

*RST value: 2 MHz

SCPI: device-specific

Mode

NF

[SENSe:]FREQuency:STOP

This command specifies the stop frequency for a new frequency measurement list. If this value is altered, a new frequency list is generated.

Parameter

<numeric value>

Example

```
FREQ:STOP 700MHZ
```

Sets the stop frequency for a new list to a value of 700 MHz.

Characteristics

*RST value: 560 MHz

SCPI: conform

Mode

NF

[SENSe:]SWEep:COUNT

This command specifies the number of sweeps over which the measurement results are averaged. The higher the number of sweeps, the more accurate the results. However, a high number of sweeps requires a longer measurement time.

Parameter

1 to 32767

Example

```
SWE:COUN 10
```

Sets the number of sweeps for averaging to 10.

Characteristics

*RST value: 1

SCPI: conform

Mode

NF

[SENSe:]SWEep:TIME

For details refer to "[SENSe<1|2>:]SWEep:TIME" on page 6.227.

STATus Subsystem (Noise Figure, K30)

The STATus subsystem contains the commands for the status reporting system (See Section ""). *RST does not influence the status registers.

Commands of the STATus subsystem

- STATus:QUEStionable:CORRection[:EVENT]?
- STATus:QUEStionable:CORRection:CONDition?
- STATus:QUEStionable:CORRection:ENABle
- STATus:QUEStionable:CORRection:NTRansition
- STATus:QUEStionable:CORRection:PTRansition
- STATus:QUEStionable:FREQuency[:EVENT]?
- STATus:QUEStionable:FREQuency:CONDition?
- STATus:QUEStionable:FREQuency:ENABle
- STATus:QUEStionable:FREQuency:NTRansition
- STATus:QUEStionable:FREQuency:PTRansition
- STATus:QUEStionable:LIMit<1|2> [:EVENT]?
- STATus:QUEStionable:LIMit<1|2>:CONDition?
- STATus:QUEStionable:LIMit<1|2>:ENABle
- STATus:QUEStionable:LIMit<1|2>:NTRansition
- STATus:QUEStionable:LIMit<1|2>:PTRansition

STATus:QUEStionable:CORRection[:EVENT]?

This command queries the contents of the EVENT section of the STATus:QUEStionable:CORRection register. Readout deletes the contents of the EVENT section.

Example

```
STAT:QUES:CORR?
```

Characteristics

*RST value: -

SCPI: conform

Mode

NF

STATus:QUEStionable:CORRection:CONDition?

This command queries the contents of the CONDition section of the STATus:QUEStionable:CORRection register. Readout does not delete the contents of the CONDition section.

Example

```
STAT:QUES:CORR:COND?
```

Characteristics

*RST value: -

SCPI: conform

Mode

NF

STATus:QUEStionable:CORRection:ENABle

This command sets the bits of the ENABle section of the STATus:QUEStionable:CORRection register. The ENABle register selectively enables the individual events of the associated EVENT section for the summary bit.

Parameter

0 to 65535

Example

```
STAT:QUES:CORR:ENAB 65535
```

All events bits are represented in the CORRection summary bit.

Characteristics

*RST value: -

SCPI: conform

Mode

NF

STATus:QUEStionable:CORRection:NTRansition

This command determines what bits in the STATus:QUEStionable:CORRection Condition register set the corresponding bit in the STATus:QUEStionable:CORRection Event register if that bit has a negative transition (1 to 0). The variable <number> is the sum of the decimal values of the bits that are to be enabled.

Parameter

0 to 65535

Example

```
STAT:QUES:CORR:NTR 65535
```

All condition bits are summarized in the Event register if a positive transition occurs.

Characteristics

*RST value: -

SCPI: conform

Mode

NF

STATus:QUEStionable:CORRection:PTRansition

This command determines what bits in the STATus:QUESionable:CORRection Condition register set the corresponding bit in the STATus:QUESionable:CORRection Event register if that bit has a positive transition (0 to 1). The variable <number> is the sum of the decimal values of the bits that are to be enabled.

Parameter

0 to 65535

Example

```
STAT:QUES:CORR:PTR 65535
```

All condition bits are summarized in the Event register if a positive transition occurs.

Characteristics

*RST value: -

SCPI: conform

Mode

NF

STATus:QUEStionable:FREQuency:EVENT]?

For details refer to "[STATus:QUEStionable:FREQuency:EVENT\]?](#)" on page 6.237.

STATus:QUEStionable:FREQuency:CONDition?

For details refer to "[STATus:QUEStionable:FREQuency:CONDition?](#)" on page 6.238.

STATus:QUEStionable:FREQuency:ENABLE

For details refer to "[STATus:QUEStionable:FREQuency:ENABLE](#)" on page 6.238.

STATus:QUEStionable:FREQuency:NTRansition

This command determines what bits in the STATus:QUESionable:FREQuency Condition register set the corresponding bit in the STATus:QUESionable:FREQuency Event register if that bit has a negative transition (1 to 0). The variable <number> is the sum of the decimal values of the bits that are to be enabled.

Parameter

0 to 65535

Example

```
STAT:QUES:FREQ:NTR 65535
```

All condition bits are summarized in the Event register if a positive transition occurs.

Characteristics

*RST value: -

SCPI: conform

Mode

NF

STATus:QUEStionable:FREQuency:PTRansition

This command determines what bits in the STATus:QUESionable:FREQuency Condition register set the corresponding bit in the STATus:QUESionable:FREQuency Event register if that bit has a positive transition (0 to 1). The variable <number> is the sum of the decimal values of the bits that are to be enabled.

Parameter

0 to 65535

Example

STAT:QUES:FREQ:PTR 65535

All condition bits are summarized in the Event register if a positive transition occurs.

Characteristics

*RST value: -
 SCPI: conform

Mode

NF

STATus:QUEStionable:LIMit<1|2> [:EVENT]?

For details refer to "[STATus:QUEStionable:LIMit<1|2>\[:EVENT\]?](#)" on page 6.239.

STATus:QUEStionable:LIMit<1|2>:CONDition?

For details refer to "[STATus:QUEStionable:LIMit<1|2>:CONDition?](#)" on page 6.239.

STATus:QUEStionable:LIMit<1|2>:ENABle

For details refer to "[STATus:QUEStionable:LIMit<1|2>:ENABle](#)" on page 6.240.

STATus:QUEStionable:LIMit<1|2>:NTRansition

This command determines what bits in the STATus:QUESionable:LIMit Condition register set the corresponding bit in the STATus:QUESionable:LIMit Event register if that bit has a negative transition (1 to 0). The variable <number> is the sum of the decimal values of the bits that are to be enabled.

Parameter

0 to 65535

Example

STAT:QUES:NTR 65535

All condition bits are summarized in the Event register if a positive transition occurs.

Characteristics

*RST value: -
 SCPI: device-specific

Mode

NF

STATus:QUEStionable:LIMit<1|2>:PTRansition

This command determines what bits in the STATus:QUESionable:LIMit Condition register set the corresponding bit in the STATus:QUESionable:LIMit Event register if that bit has a positive transition (0 to 1). The variable <number> is the sum of the decimal values of the bits that are to be enabled.

Parameter

0 to 65535

Example

```
STAT:QUES:PTR 65535
```

All condition bits are summarized in the Event register if a positive transition occurs.

Characteristics

*RST value: -

SCPI: device-specific

Mode

NF

SYSTEM Subsystem (Noise Figure, K30)

This subsystem contains a series of commands for general functions.

Commands of the SYSTEM subsystem

- [SYSTem:CONFigure:DUT:GAIN](#)
- [SYSTem:CONFigure:DUT:STIME](#)

SYSTem:CONFigure:DUT:GAIN

This command specifies the maximum gain of the DUT.

Parameter

10 dB to 999.99 dB

Example

`SYST:CONF:DUT:GAIN 10`

Specifies the gain of the DUT to be 10 dB.

Characteristics

*RST value: 30 dB

SCPI: device-specific

Mode

NF

SYSTem:CONFigure:DUT:STIME

This command specifies the DUT settling time. It represents the time to wait for the DUT to settle after a noise source has been turned on or off.

Parameter

0 to 20 s

Example

`SYST:CONF:DUT:STIM 1000MS`

Specifies a period of one second for the DUT to settle down after exposure to the noise source has been removed.

Characteristics

*RST value: 50 milliseconds

SCPI: device-specific

Mode

NF

Remote Commands of the 3GPP Base Station Measurements Option (K72)

This section describes the remote commands for the 3GPP Base Station Measurements option (K72). The abbreviation WCDMA stands for the operating mode of this option. For details on conventions used in this chapter refer to section "Notation" on page 6.2 at the beginning of this chapter.

For further information on analyzer or basic settings commands, refer to the corresponding subsystem in section "Remote Commands of the Base Unit" on page 6.5.

This option is available from firmware version 1.60.

Subsystems of the 3GPP Base Station Measurements option (K72)

- "ABORt Subsystem (WCDMA, K72)" on page 6.560
- "CALCulate Subsystem (WCDMA, K72)" on page 6.561
- "CONFigure:WCDPower Subsystem (WCDMA, K72)" on page 6.572
- "DISPlay Subsystem (WCDMA, K72)" on page 6.573
- "INITiate Subsystem (WCDMA, K72)" on page 6.575
- "INPut Subsystem (WCDMA, K72)" on page 6.576
- "INSTrument Subsystem (WCDMA, K72)" on page 6.577
- "SENSe Subsystem (WCDMA, K72)" on page 6.578
- "STATus:QUEStionable Subsystem (WCDMA, K72)" on page 6.589
- "TRACe Subsystem (WCDMA, K72)" on page 6.590
- "TRIGger Subsystem (WCDMA, K72)" on page 6.593

ABORt Subsystem (WCDMA, K72)

The ABORt subsystem contains the commands for aborting triggered actions.

Commands of the ABORt Subsystem

- [ABORt](#)

ABORt

For details refer to "[ABORt](#)" on page 6.10.

CALCulate Subsystem (WCDMA, K72)

The CALCulate subsystem contains commands for converting instrument data, transforming and carrying out corrections. These functions are carried out subsequent to data acquisition, i.e. following the SENSE subsystem.

The following subsystems are included:

- ["CALCulate:DELTAmarker Subsystem \(WCDMA, K72\)"](#) on page 6.562
- ["CALCulate:FEED Subsystem \(WCDMA, K72\)"](#) on page 6.565
- ["CALCulate:LIMIT:ESpectrum \(WCDMA, K72\)"](#) on page 6.566
- ["CALCulate:MARKer Subsystem \(WCDMA, K72\)"](#) on page 6.569

CALCulate:DELTamarker Subsystem (WCDMA, K72)

The CALCulate:DELTamarker subsystem controls the delta marker functions of the instrument.

Commands of the CALCulate:DELTamarker Subsystem

- CALCulate<1|2>:DELTamarker<1...4>[:STATe]
- CALCulate<1|2>:DELTamarker<1...4>:AOFF
- CALCulate<1|2>:DELTamarker<1...4>:FUNcTION:CPICh
- CALCulate<1|2>:DELTamarker<1...4>:FUNcTION:PCCPch
- CALCulate<1|2>:DELTamarker<1...4>:MAXimum[:PEAK]
- CALCulate<1|2>:DELTamarker<1...4>:MAXimum:LEFT
- CALCulate<1|2>:DELTamarker<1...4>:MAXimum:NEXT
- CALCulate<1|2>:DELTamarker<1...4>:MAXimum:RIGHT
- CALCulate<1|2>:DELTamarker<1...4>:MINimum[:PEAK]
- CALCulate<1|2>:DELTamarker<1...4>:MINimum:LEFT
- CALCulate<1|2>:DELTamarker<1...4>:MINimum:NEXT
- CALCulate<1|2>:DELTamarker<1...4>:MINimum:RIGHT
- CALCulate<1|2>:DELTamarker<1...4>:X
- CALCulate<1|2>:DELTamarker<1...4>:X:RELative?
- CALCulate<1|2>:DELTamarker<1...4>:Y?

CALCulate<1|2>:DELTamarker<1...4>[:STATe]

For details refer to "CALCulate<1|2>:DELTamarker<1...4>[:STATe]" on page 6.12.

CALCulate<1|2>:DELTamarker<1...4>:AOFF

For details refer to "CALCulate<1|2>:DELTamarker<1...4>:AOFF" on page 6.13.

CALCulate<1|2>:DELTamarker<1...4>:FUNcTION:CPICh

This command sets the active delta marker on the common pilot channel.
 This command is an event and therefore has no *RST value and no query.
 The numeric suffixes <1|2> are irrelevant for this command.

Example

```
CALC:DELT1:FUNC:CPIC
```

Sets the active delta marker on the common pilot channel.

Characteristics

RST value: -

SCPI: device-specific

Mode

WCDMA

CALCulate<1|2>:DELTamarker<1...4>:FUNCTio:n:PCCPch

This command sets the active delta marker on the primary common control physical channel.

This command is an event and therefore has no *RST value and no query.

The numeric suffixes <1|2> are irrelevant for this command.

Example

```
CALC : DELT1 : FUNC : PCCP
```

Sets the active delta marker on the primary common control physical channel.

Characteristics

RST value: -

SCPI: device-specific

Mode

WCDMA

CALCulate<1|2>:DELTamarker<1...4>:MAXimum[:PEAK]

For details refer to "[CALCulate<1|2>:DELTamarker<1...4>:MAXimum\[:PEAK\]](#)" on page 6.16.

CALCulate<1|2>:DELTamarker<1...4>:MAXimum:LEFT

For details refer to "[CALCulate<1|2>:DELTamarker<1...4>:MAXimum:LEFT](#)" on page 6.17.

CALCulate<1|2>:DELTamarker<1...4>:MAXimum:NEXT

For details refer to "[CALCulate<1|2>:DELTamarker<1...4>:MAXimum:NEXT](#)" on page 6.17.

CALCulate<1|2>:DELTamarker<1...4>:MAXimum:RIGHT

For details refer to "[CALCulate<1|2>:DELTamarker<1...4>:MAXimum:RIGHT](#)" on page 6.17.

CALCulate<1|2>:DELTamarker<1...4>:MINimum[:PEAK]

For details refer to "[CALCulate<1|2>:DELTamarker<1...4>:MINimum\[:PEAK\]](#)" on page 6.18.

CALCulate<1|2>:DELTamarker<1...4>:MINimum:LEFT

For details refer to "[CALCulate<1|2>:DELTamarker<1...4>:MINimum:LEFT](#)" on page 6.18.

CALCulate<1|2>:DELTamarker<1...4>:MINimum:NEXT

For details refer to "[CALCulate<1|2>:DELTamarker<1...4>:MINimum:NEXT](#)" on page 6.19.

CALCulate<1|2>:DELTamarker<1...4>:MINimum:RIGHT

For details refer to "[CALCulate<1|2>:DELTamarker<1...4>:MINimum:RIGHT](#)" on page 6.19.

CALCulate<1|2>:DELTamarker<1...4>:X

For details refer to "[CALCulate<1|2>:DELTamarker<1...4>:X](#)" on page 6.20.

CALCulate<1|2>:DELTamarker<1...4>:X:RELative?

For details refer to "[CALCulate<1|2>:DELTamarker<1...4>:X:RELative?](#)" on page 6.21.

CALCulate<1|2>:DELTamarker<1...4>:Y?

For details refer to "[CALCulate<1|2>:DELTamarker<1...4>:Y?](#)" on page 6.21.

CALCulate:FEED Subsystem (WCDMA, K72)

The CALCulate:FEED subsystem selects the evaluation method of the measured code domain power data. This corresponds to the selection of the result display in manual mode.

Commands of the CALCulate:FEED Subsystem

– CALCulate<1|2>:FEED

CALCulate<1|2>:FEED

This command selects the result display for the Code Domain Power Diagram measurement. The numeric suffixes <1|2> are irrelevant for this command.

Parameter

	Result display	Display format
XPOWer:CDP	Code Domain Power Diagram in relative scaling	bar graph
XPOWer:CDP:ABSolute	Code Domain Power Diagram in absolute scaling	bar graph
XTIME:CDPower:ERRor:CTABLE	Code Domain Channel Table	channel assignment table
XTIME:CDPower:ERRor:SUMMARY	Code Domain Result Summary (default setting)	results in table format

Example

```
CALC:FEED 'XPOW:CDP'
```

Selects the Code Domain Power Diagram result display in absolute scaling.

Characteristics

RST value: -

SCPI: conform

Mode

WCDMA

CALCulate:LIMit:ESpectrum (WCDMA, K72)

The CALCulate:LIMit:ESpectrum subsystem defines limit checking for RF measurements.

Commands of the CALCulate:LIMit:ESpectrum Subsystem

- CALCulate<1|2>:LIMit<1...8>:ESpectrum:MODE
- CALCulate<1|2>:LIMit<1...8>:ESpectrum:RESTore
- CALCulate<1|2>:LIMit<1...8>:ESpectrum:TRANSition
- CALCulate<1|2>:LIMit<1...8>:ESpectrum:VALue

CALCulate<1|2>:LIMit<1...8>:ESpectrum:MODE

This command activates or deactivates automatic selection of the limit line in the spectrum emission mask measurement.

The numeric suffixes <1|2> and <1...8> are irrelevant for this command.

Parameter

AUTO	Sets the limit line automatically according to the power determined in the useful channel.
MANual	Activates the selected predefined limit lines. The selection is made with the CALCulate<1 2>:LIMit<1...8>:ESpectrum:VALue command.
USER	Activates the user-defined limit lines. (for details refer to "Using Limit Lines and Display Lines - LINES Key").

Example

```
CONF:WCDP:MEAS ESP
Selects the spectrum emission mask measurement.
CALC:LIM:ESP:MODE MAN
Activates the selected predefined limit lines.
```

Characteristics

RST value: AUTO
SCPI: device-specific

Mode

WCDMA

CALCulate<1|2>:LIMit<1...8>:ESpectrum:RESTore

This command restores the predefined limit lines for the spectrum emission mask measurement. All modifications made to the predefined limit lines are lost and the factory-set values are restored.

The numeric suffixes <1|2> and <1...8> are irrelevant for this command.

This command is an event and therefore has no *RST value and no query.

Example

```
CONF:WCDP:MEAS ESP
Selects the spectrum emission mask measurement.
CALC:LIM:ESP:REST
Sets the spectrum emission mask limit lines back to the factory-set values.
```

Characteristics

RST value: -

SCPI: device-specific

Mode

WCDMA

CALCulate<1|2>:LIMit<1...8>:ESPectrum:TRANsition

This command defines the offset frequency at which the resolution bandwidth is changed.

The numeric suffixes <1|2> and <1...8> are irrelevant for this command.

Parameter

30 kHz to 1 MHz

Example

```
CONF:WCDP:MEAS ESP
```

Selects the spectrum emission mask measurement.

```
CALC:LIM:ESP:TRAN 5MHZ
```

Defines the offset frequency at which the resolution bandwidth is changed.

Characteristics

RST value: 4.0 MHz

SCPI: device-specific

Mode

WCDMA

CALCulate<1|2>:LIMit<1...8>:ESPectrum:VALue

This command selects one of the following predefined limit lines. As a prerequisite, the predefined limit lines must be activated using the

[CALCulate<1|2>:LIMit<1...8>:ESPectrum:MODE](#) command.

The numeric suffixes <1|2> and <1...8> are irrelevant for this command.

Parameter43 $P \geq 43$ dBm39 39 dBm $\leq P < 43$ dBm31 31 dBm $\leq P < 39$ dBm0 $P < 31$ dBm

P stands for the expected power value.

Example

```
CONF:WCDP:MEAS ESP
```

Selects the spectrum emission mask measurement.

```
CALC:LIM:ESP:MODE MAN
```

Activates the selected predefined limit lines.

```
CALC:LIM:ESP:VAL 39
```

Selects the predefined limit line **39 dBm $\leq P < 43$ dBm**.

Characteristics

RST value: 0

SCPI: device-specific

Mode

WCDMA

CALCulate:MARKer Subsystem (WCDMA, K72)

The CALCulate:MARKer subsystem checks the marker functions of the instrument.

Commands of the CALCulate:MARKer Subsystem

- CALCulate<1|2>:MARKer<1...4>[:STATe]
- CALCulate<1|2>:MARKer<1...4>:AOFF
- CALCulate<1|2>:MARKer<1...4>:FUNcTION:CPICh
- CALCulate<1|2>:MARKer<1...4>:FUNcTION:PCCPch
- CALCulate<1|2>:MARKer<1...4>:FUNcTION:WCDPower[:BTS]:RESult?
- CALCulate<1|2>:MARKer<1...4>:MAXimum[:PEAK]
- CALCulate<1|2>:MARKer<1...4>:MAXimum:LEFT
- CALCulate<1|2>:MARKer<1...4>:MAXimum:NEXT
- CALCulate<1|2>:MARKer<1...4>:MAXimum:RIGHT
- CALCulate<1|2>:MARKer<1...4>:MINimum[:PEAK]
- CALCulate<1|2>:MARKer<1...4>:MINimum:LEFT
- CALCulate<1|2>:MARKer<1...4>:MINimum:NEXT
- CALCulate<1|2>:MARKer<1...4>:MINimum:RIGHT
- CALCulate<1|2>:MARKer<1...4>:X
- CALCulate<1|2>:MARKer<1...4>:Y?

CALCulate<1|2>:MARKer<1...4>[:STATe]

For details refer to "CALCulate<1|2>:MARKer<1...4>[:STATe]" on page 6.55.

CALCulate<1|2>:MARKer<1...4>:AOFF

For details refer to "CALCulate<1|2>:MARKer<1...4>:AOFF" on page 6.56.

CALCulate<1|2>:MARKer<1...4>:FUNcTION:CPICh

This command sets the active marker on the common pilot channel.

This command is an event and therefore has no *RST value and no query.

The numeric suffixes <1|2> are irrelevant for this command.

Example

```
CALC:MARK1:FUNC:CPIC
```

Sets the active marker on the common pilot channel.

Characteristics

RST value: -

SCPI: device-specific

Mode

WCDMA

CALCulate<1|2>:MARKer<1...4>:FUNction:PCCPch

This command sets the active marker on the primary common control physical channel.
 This command is an event and therefore has no *RST value and no query.
 The numeric suffixes <1|2> are irrelevant for this command.

Example

```
CALC:MARK1:FUNC:PCCP
```

Sets the active marker on the primary common control physical channel.

Characteristics

RST value: -

SCPI: device-specific

Mode

WCDMA

CALCulate<1|2>:MARKer<1...4>:FUNction:WCDPower[:BTS]:RESult?

This command queries the measured and calculated results of the code domain power measurement. The results are calculated from the recorded IQ data set.
 This command is only a query and therefore has no *RST value.
 The numeric suffixes <1|2> and <1...4> are irrelevant for this command.

Parameter

CDPabsolute	channel power absolute
CDPRelative	channel power relative
CERRor	chip rate error
CHANnel	channel number
CSLot	channel slot number
EVMRms	error vector magnitude RMS
FERRor	frequency error in Hz
IQIMbalance	I/Q imbalance
IQOFFset	I/Q offset
MACCuracy	composite EVM
MType	modulation type
PCDerror	peak code domain error
PTOTal	total power
RHO	rho value for every slot
SRATe	symbol rate
TFRame	trigger to frame
TOFFset	timing offset

Example

```
CALC:MARK:FUNC:WCDP:RES? CDP
```

Queries the absolute channel power.

Characteristics

RST value: -

SCPI: device-specific

Mode

WCDMA

CALCulate<1|2>:MARKer<1...4>:MAXimum[:PEAK]

For details refer to "[CALCulate<1|2>:MARKer<1...4>:MAXimum\[:PEAK\]](#)" on page 6.58.

CALCulate<1|2>:MARKer<1...4>:MAXimum:LEFT

For details refer to "[CALCulate<1|2>:MARKer<1...4>:MAXimum:LEFT](#)" on page 6.59.

CALCulate<1|2>:MARKer<1...4>:MAXimum:NEXT

For details refer to "[CALCulate<1|2>:MARKer<1...4>:MAXimum:NEXT](#)" on page 6.59.

CALCulate<1|2>:MARKer<1...4>:MAXimum:RIGHT

For details refer to "[CALCulate<1|2>:MARKer<1...4>:MAXimum:RIGHT](#)" on page 6.60.

CALCulate<1|2>:MARKer<1...4>:MINimum[:PEAK]

For details refer to "[CALCulate<1|2>:MARKer<1...4>:MINimum\[:PEAK\]](#)" on page 6.60.

CALCulate<1|2>:MARKer<1...4>:MINimum:LEFT

For details refer to "[CALCulate<1|2>:MARKer<1...4>:MINimum:LEFT](#)" on page 6.61.

CALCulate<1|2>:MARKer<1...4>:MINimum:NEXT

For details refer to "[CALCulate<1|2>:MARKer<1...4>:MINimum:NEXT](#)" on page 6.62.

CALCulate<1|2>:MARKer<1...4>:MINimum:RIGHT

For details refer to "[CALCulate<1|2>:MARKer<1...4>:MINimum:RIGHT](#)" on page 6.62.

CALCulate<1|2>:MARKer<1...4>:X

For details refer to "[CALCulate<1|2>:MARKer<1...4>:X](#)" on page 6.63.

CALCulate<1|2>:MARKer<1...4>:Y?

For details refer to "[CALCulate<1|2>:MARKer<1...4>:Y?](#)" on page 6.66.

CONFigure:WCDPower Subsystem (WCDMA, K72)

The CONFigure subsystem contains commands for configuring the measurements.

Commands of the CONFigure:WCDPower Subsystem

- [CONFigure:WCDPower:\[BTS\]:MEASurement](#)

CONFigure:WCDPower:[BTS]:MEASurement

This command selects the measurements with their predefined settings according to the 3GPP standard.

Parameter

ACLR	adjacent-channel power measurement
ESPectrum	measurement of spectrum emission mask
POWer	channel power measurement
WCDPower	code domain power measurement

Example

```
CONF:WCDP:MEAS POW
```

Selects the channel power measurement.

Characteristics

RST value: WCDP

SCPI: device-specific

Mode

WCDMA

DISPlay Subsystem (WCDMA, K72)

The DISPLay subsystem controls the selection and presentation of textual and graphic information as well as of measurement data on the display.

Commands of the DISPlay Subsystem

- [DISPlay\[:WINDow<1|2>\]:TRACe<1...6>\[:STATe\]](#)
- [DISPlay\[:WINDow<1|2>\]:TRACe<1...6>:MODE](#)
- [DISPlay\[:WINDow<1|2>\]:TRACe<1...6>:Y\[:SCALe\]:PDIVision](#)
- [DISPlay\[:WINDow<1|2>\]:TRACe<1...6>:Y\[:SCALe\]:RLEVel](#)
- [DISPlay\[:WINDow<1|2>\]:TRACe<1...6>:Y\[:SCALe\]:RLEVel:OFFSet](#)
- [DISPlay\[:WINDow<1|2>\]:TRACe<1...6>:Y\[:SCALe\]:RPOSition](#)

[DISPlay\[:WINDow<1|2>\]:TRACe<1...6>\[:STATe\]](#)

For details refer to "[DISPlay\[:WINDow<1|2>\]:TRACe<1...6>\[:STATe\]](#)" on page 6.130.

[DISPlay\[:WINDow<1|2>\]:TRACe<1...6>:MODE](#)

Parameter

WRITe | VIEW | AVERAge | MAXHold | MINHold

For details on trace modes refer to chapter "Instrument Functions", section "Trace mode overview".

For further details refer to "[DISPlay\[:WINDow<1|2>\]:TRACe<1...6>:MODE](#)" on page 6.130.

[DISPlay\[:WINDow<1|2>\]:TRACe<1...6>:Y\[:SCALe\]:PDIVision](#)

This command defines the scaling of the y-axis in dB.
The numeric suffixes <1|2> and <1...6> are irrelevant.

Parameter

0.01 to 100 dB

Example

```
DISP:TRAC:Y:PDIV +10DB
Sets the Y scale to 10 dB/div.
```

Characteristics

*RST value: 7
SCPI: conform

Mode

WCDMA

[DISPlay\[:WINDow<1|2>\]:TRACe<1...6>:Y\[:SCALe\]:RLEVel](#)

For details refer to "[DISPlay\[:WINDow<1|2>\]:TRACe<1...6>:Y\[:SCALe\]:RLEVel](#)" on page 6.133.

DISPlay[:WINDow<1|2>]:TRACe<1...6>:Y[:SCALe]:RLEVel:OFFSet

For details refer to "[DISPlay\[:WINDow<1|2>\]:TRACe<1...6>:Y\[:SCALe\]:RLEVel:OFFSet](#)" on page 6.133.

DISPlay[:WINDow<1|2>]:TRACe<1...6>:Y[:SCALe]:RPOSition

For details refer to "[DISPlay\[:WINDow<1|2>\]:TRACe<1...6>:Y\[:SCALe\]:RPOSition \(models with tracking generator\)](#)" on page 6.133.

INITiate Subsystem (WCDMA, K72)

The INITiate subsystem is used to control the init-measurement function.

Commands of the INITiate Subsystem

- [INITiate<1|2>\[:IMMediate\]](#)
- [INITiate<1|2>:CONTInuous](#)

INITiate<1|2>[:IMMediate]

For details refer to "[INITiate<1|2>\[:IMMediate\]](#)" on page 6.143.

INITiate<1|2>:CONTInuous

For details refer to "[INITiate<1|2>:CONTInuous](#)" on page 6.144.

INPut Subsystem (WCDMA, K72)

The INPut subsystem controls the input characteristics of the RF inputs of the instrument.

Commands of the INPut Subsystem

- [INPut:ATTenuation](#)
- [INPut:ATTenuation:AUTO](#)
- [INPut:GAIN:STATe](#)

INPut:ATTenuation

For details refer to "[INPut<1|2>:ATTenuation](#)" on page 6.146.

INPut:ATTenuation:AUTO

For details refer to "[INPut<1|2>:ATTenuation:AUTO](#)" on page 6.146.

INPut:GAIN:STATe

For details refer to "[INPut<1|2>:GAIN:STATe](#)" on page 6.147.

INSTrument Subsystem (WCDMA, K72)

The INSTrument subsystem selects the operating mode of the unit either via text parameters or fixed numbers.

Commands of the INSTrument Subsystem

- [INSTrument\[:SElect\]](#)
- [INSTrument:NSElect](#)

INSTrument[:SElect]

Parameter

BWCD (3GPP Base Station Measurements option, R&S FSL-K72)

For further details refer to the INSTrument subsystem of the base unit.

INSTrument:NSElect

Parameter

8 (3GPP Base Station Measurements option, R&S FSL-K72)

For further details refer to the INSTrument subsystem of the base unit.

SENSe Subsystem (WCDMA, K72)

The SENSe subsystem is organized in several subsystems. The commands of these subsystems directly control device-specific settings, they do not refer to the signal characteristics of the measurement signal.

The SENSe subsystem controls the essential parameters of the analyzer. In accordance with the SCPI standard, the keyword "SENSe" is optional for this reason, which means that it is not necessary to include the SENSe node in command sequences.

The following subsystems are included:

- ["SENSe:AVERage Subsystem \(WCDMA, K72\)"](#) on page 6.579
- ["SENSe:CDPower Subsystem \(WCDMA, K72\)"](#) on page 6.580
- ["SENSe:FREQuency Subsystem \(WCDMA, K72\)"](#) on page 6.588
- ["SENSe:SWEEP Subsystem \(WCDMA, K72\)"](#) on page 6.588

SENSe:AVERage Subsystem (WCDMA, K72)

The SENSe:AVERage subsystem calculates the average of the acquired data. A new test result is obtained from several successive measurements.

Commands of the SENSe:AVERage Subsystem

– [\[SENSe<1|2>:\]AVERage:COUNT](#)

[SENSe<1|2>:]AVERage:COUNT

For details refer to "[\[SENSe<1|2>:\]AVERage:COUNT](#)" on page 6.168.

SENSe:CDPower Subsystem (WCDMA, K72)

The SENSe:CDPower subsystem controls the parameters for the code domain mode. The numeric suffix in SENSe<1|2> is not significant in this subsystem.

Commands of the SENSe:CDPower Subsystem

- [SENSe<1|2>:]CDPower:ANTenna
- [SENSe<1|2>:]CDPower:ASEquence
- [SENSe<1|2>:]CDPower:CODE
- [SENSe<1|2>:]CDPower:HSDPamode
- [SENSe<1|2>:]CDPower:ICTReshold
- [SENSe<1|2>:]CDPower:LCODE[:VALue]
- [SENSe<1|2>:]CDPower:LCODE:DVALue
- [SENSe<1|2>:]CDPower:LCODE:SEARch[:IMMediate]
- [SENSe<1|2>:]CDPower:LCODE:SEARch:LIST?
- [SENSe<1|2>:]CDPower:LEVel:ADJust
- [SENSe<1|2>:]CDPower:NORMalize
- [SENSe<1|2>:]CDPower:PREFerece
- [SENSe<1|2>:]CDPower:QINVert
- [SENSe<1|2>:]CDPower:RSUMmary
- [SENSe<1|2>:]CDPower:SLOT
- [SENSe<1|2>:]CDPower:STYPe

[SENSe<1|2>:]CDPower:ANTenna

This command activates or deactivates the antenna diversity mode and selects the antenna to be used.

The numeric suffixes <1|2> are irrelevant for this command.

Parameter

- OFF The antenna diversity mode is switched off.
- 1 | 2 The antenna diversity mode is switched on, and the signal from antenna 1 or antenna 2 is used for code domain power analysis.

Example

CDP:ANT 1

The signal from antenna 1 is used for code domain power analysis.

Characteristics

RST value: OFF

SCPI: device-specific

Mode

WCDMA

[SENSe<1|2>:]CDPower:ASEquence

This command starts the following sequence:

- Adjusts the reference level.
- Searches automatically the scrambling code that leads to the highest signal power and stores it as new scrambling code.
- Changes into the Result Summary result display.

The numeric suffixes <1|2> are irrelevant for this command.

This command is an event and therefore has no *RST value and no query.

Example

CDP:ASEQ

Characteristics

RST value: -

SCPI: device-specific

Mode

WCDMA

[SENSe<1|2>:]CDPower:CODE

This command sets the code number. The code number refers to code class 9 (spreading factor 512).

The numeric suffixes <1|2> are irrelevant for this command.

Parameter

0 to 511

Example

CDP:CODE 30

Sets code number 30.

Characteristics

RST value: 0

SCPI: device-specific

Mode

WCDMA

[SENSe<1|2>:]CDPower:HSDPamode

This command activates or deactivates the HSUPA/DPA channel detection.

The numeric suffixes <1|2> are irrelevant for this command.

Parameter

- ON The high speed channels can be detected.
 The modulation type (QPSK /16QAM) is detected.
- OFF The high speed channel can not be detected.
 Pilot symbols are detected.

Example

```
CDP:HSDP OFF
```

Deactivates the HSUPA/DPA channel detection.

Characteristics

RST value: ON

SCPI: device-specific

Mode

WCDMA

[SENSe<1|2>:]CDPower:ICTReshold

This command sets the minimum power threshold for a single channel (channel power compared to total signal power). Only channels with a signal power above this value are recognized as active channels.

The numeric suffixes <1|2> are irrelevant for this command.

Parameter

-100 dB to 10 dB

Example

```
CDP:ICTR -10
```

Sets the minimum power threshold to -10 dB.

Characteristics

RST value: -60 dB

SCPI: device-specific

Mode

WCDMA

[SENSe<1|2>:]CDPower:LCODE[:VALue]

This command defines the scrambling code in hexadecimal format.

The numeric suffixes <1|2> are irrelevant for this command.

Parameter

0x0 ... 0x5FFF

Example

```
CDP:LCOD #H2
```

Defines the scrambling code in hexadecimal format.

Characteristics

RST value: 0

SCPI: device-specific

Mode

WCDMA

[SENSe<1|2>:]CDPower:LCODe:DVALue

This command defines the scrambling code in decimal format.
The numeric suffixes <1|2> are irrelevant for this command.

Parameter

0 to 24575

Example

```
CDP:LCOD:DVAL 3
```

Defines the scrambling code in decimal format.

Characteristics

RST value: 0

SCPI: device-specific

Mode

WCDMA

[SENSe<1|2>:]CDPower:LCODe:SEARch[:IMMediate]

This command searches automatically the scrambling code that leads to the highest signal power and stores it as new scrambling code for further measurements.

The numeric suffixes <1|2> are irrelevant for this command.

This command is an event and therefore has no *RST value and no query.

Example

```
CDP:LCOD:SEAR
```

Characteristics

RST value: -

SCPI: device-specific

Mode

WCDMA

[SENSe<1|2>:]CDPower:LCODe:SEARch:LIST?

This command returns a comma separated result table of the automatic search sequence containing the highest power values calculated and the corresponding scrambling codes.

The numeric suffixes <1|2> are irrelevant for this command.

This command is only a query and therefore has no *RST value.

Returned value

Each found scrambling code consists of the following line:

<decimal scrambling code value>, <hexadecimal scrambling code value>, <power in dBm>

Example:

16,0x10,-18.04,32,0x20,-22.87,48,0x30,-27.62,64,0x40,-29.46

in table format:

code (dec)	code (hex)	CPICH power (dBm)
16	0x10	-18.04
32	0x20	-22.87
48	0x30	-27.62
64	0x40	-29.46

Example

CDP:LCOD:SEAR

Starts the automatic scrambling code search.

CDP:LCOD:SEAR:LIST?

Lists the result table of the automatic search sequence.

Characteristics

RST value: -

SCPI: device-specific

Mode

WCDMA

[SENSe<1|2>:]CDPower:LEVel:ADJust

This command adjusts the reference level to the measured channel power. This ensures that the settings of the RF attenuation and the reference level are optimally adjusted to the signal level without overloading the R&S FSL or limiting the dynamic range by an S/N ratio that is too small.

The numeric suffixes <1|2> are irrelevant for this command.

This command is an event and therefore has no *RST value and no query.

Example

CDP:LEV:ADJ

Adjusts the reference level to the measured channel power.

Characteristics

RST value: -

SCPI: device-specific

Mode

WCDMA

[SENSe<1|2>:]CDPower:NORMalize

This command activates and deactivates the elimination of the I/Q offset.

The numeric suffixes <1|2> are irrelevant for this command.

Parameter

ON | OFF

Example

CDPower:NORMalize ON

Activates the elimination of the I/Q offset.

Characteristics

RST value: OFF

SCPI: device-specific

ModeWCDMA

[SENSe<1|2>:]CDPower:PREference

This command sets the power reference for the relative power displays.

The numeric suffixes <1|2> are irrelevant for this command.

Parameter

TOT total power

CPICH power of the common pilot channel

Example

CDP:PREF TOT

Sets the total power as power reference.

Characteristics

RST value: CPICH

SCPI: device-specific

ModeWCDMA

[SENSe<1|2>:]CDPower:QINVert

This command activates or deactivates the Q inversion.

The numeric suffixes <1|2> are irrelevant for this command.

Parameter

ON The sign of the Q-component of the signal is inverted.

OFF The sign of the Q-component of the signal remains unchanged.

Example

CDP:QINV ON

Activates the Q inversion.

Characteristics

RST value: OFF

SCPI: device-specific

ModeWCDMA

[SENSe<1|2>:]CDPower:RSUMmary

This command sets the view of the Code Domain Result Summary.
The numeric suffixes <1|2> are irrelevant for this command.

Parameter

- NORmal Some of the most important results are shown in the table on the R&S FSL display.
- EXTended All available result are shown in the table on the R&S FSL display.

Example

CDP:RSUM EXT

Sets the extended view of the Code Domain Result Summary.

Characteristics

RST value: NOR

SCPI: device-specific

Mode

WCDMA

[SENSe<1|2>:]CDPower:SLOT

This command selects the slot that is evaluated in the Code Domain Power Diagram and is used for slot-based evaluations in the Code Domain Result Summary.

The numeric suffixes <1|2> are irrelevant for this command.

Parameter

0 to 14

Example

```
CDP:SLOT 3  
Selects slot 3.
```

Characteristics

RST value: 0

SCPI: device-specific

Mode

WCDMA

[SENSe<1|2>:]CDPower:STYPe

This command defines the synchronization..

The numeric suffixes <1|2> are irrelevant for this command.

Parameter

CPICH A synchronization to the CPICH control channel is performed. As a prerequisite, the CPICH control channel must be present in the signal.

SCHannel A synchronization without assuming the presence of a CPICH channel is performed.

While this setting can also be used with other channel configurations, but the probability of synchronization failure increases with the number of data channels.

Example

```
CDP:STYP SCH  
A synchronization without assuming the presence of a CPICH channel is performed.
```

Characteristics

RST value: CPICH

SCPI: device-specific

Mode

WCDMA

SENSe:FREQuency Subsystem (WCDMA, K72)

The SENSe:FREQuency subsystem defines the frequency axis of the active display. The frequency axis can either be defined via the start/stop frequency or via the center frequency and span.

Commands of the SENSe:FREQuency Subsystem

- [\[SENSe<1|2>:\]FREQuency:CENTer](#)
- [\[SENSe<1|2>:\]FREQuency:CENTer:STEP](#)
- [\[SENSe<1|2>:\]FREQuency:OFFSet](#)

[\[SENSe<1|2>:\]FREQuency:CENTer](#)

For details refer to "[\[SENSe<1|2>:\]FREQuency:CENTer](#)" on page 6.194.

[\[SENSe<1|2>:\]FREQuency:CENTer:STEP](#)

For details refer to "[\[SENSe<1|2>:\]FREQuency:CENTer:STEP](#)" on page 6.194.

[\[SENSe<1|2>:\]FREQuency:OFFSet](#)

For details refer to "[\[SENSe<1|2>:\]FREQuency:OFFSet](#)" on page 6.196.

SENSe:SWEep Subsystem (WCDMA, K72)

The SENSe:SWEep subsystem controls the sweep parameters.

Commands of the SENSe:SWEep Subsystem

- [\[SENSe<1|2>:\]SWEep:COUNT](#)

[\[SENSe<1|2>:\]SWEep:COUNT](#)

For details refer to "[\[SENSe<1|2>:\]SWEep:COUNT](#)" on page 6.223.

STATus:QUEStionable Subsystem (WCDMA, K72)

The STATus:QUEStionable subsystem contains information about the error situation in the code domain power analysis.

Commands of the STATus:QUEStionable Subsystem

- [STATus:QUEStionable:SYNC\[:EVENT?\]](#)
- [STATus:QUEStionable:SYNC:CONDition?](#)

STATus:QUEStionable:SYNC[:EVENT?]

For details refer to "[STATus:QUEStionable:SYNC\[:EVENT?\]](#)" on page 6.244.

STATus:QUEStionable:SYNC:CONDition?

For details refer to "[STATus:QUEStionable:SYNC:CONDition?](#)" on page 6.244.

TRACe Subsystem (WCDMA, K72)

The TRACe subsystem controls access to the instruments internal trace memory.

Commands of the TRACe Subsystem

- TRACe<1|2>[:DATA]
- TRACe1:DATA? LIST

TRACe<1|2>[:DATA]

Parameter for code domain power measurements

TRACE1 | PWCDp | CWCDp | CTABLE

Transmitted values for code domain power measurements

The transmitted values depend on the parameter selection.

Value	Description	Range	Unit
<code class>	code class of the channel -1 indicates that the channel does not have a code class (e.g. for PSCH)	{-1, 2 ... 9}	
<class>	spreading factor of the channel code class 9 corresponds to the highest spreading factor (512, symbol rate 7.5 ksp/s), code class 2 to the lowest admissible spreading factor (4, symbol rate 960 ksp/s) -1 indicates that the channel does not have a valid spreading factor (e.g. for PSCH)		
<channel number>	code number of the channel -1 indicates that the channel does not have a regular channel number (e.g. for PSCH)		
<absolute level>	absolute level of the code channel at the selected channel slot	{-∞ ... ∞}	dBm
<relative level>	relative level of the code channel at the selected channel slot referenced to CPICH or total power	{-∞ ... ∞}	dB
<timing offset>	timing offset of the code channel to the frame start step width is 256 chips for code class 2 to 8, 512 chips for code class 9	{0 ... 38400}	chips
<pilot length>	pilot length of the code channel According to the 3GPP standard, the pilot length range depends on the code class.	{0,2,4,8,16}	symbols
<active flag>	Flag to indicate whether a channel is active (1) or not active (0)	{0,1}	
<channel type>	channel type indication 0 = DPCH, 1 = PICH, 2 = CPICH, 3 = PSCH, 4 = SSCH, 5 = PCCPCH, 6 = SCCPCH, 7 = HS_SCCH, 8 = HS_PDSCH, 9 = CHAN, 10 = CPRSD, 11 = CPR-TPC, 12 = CPR-SF/2, 13 = CPR-SF/2-TPC, 14 = EHICH-ERGCH, 15 = EAGCH, 16 = SCPICH For details on channels refer to chapter 4, section "3GPP Base Station Measurements (Option K72)", "Channels of the Code Domain Channel Table and their usage"	{0 ... 16}	
<modulation type>	modulation type of the code channel at the selected channel slot 2 = QPSK, 4 = 16QAM, 15 = NONE	{2,4,15}	
<reserved>	reserved for future functionality	{0}	

TRACE1

5 values are transmitted for each channel:

<class>, <channel number>, <absolute level>, <relative level>, <timing offset>, ...

For the Code Dom Power Diagram result display, the channels are output in ascending order sorted by code number, i.e. in the same sequence they are displayed on screen.

For the Code Dom Channel Table result display, the channels are sorted by code class, i.e. the unassigned channels are transmitted last.

PWCDp

6 values are transmitted for each channel:

< class>, <channel number>, <absolute level>, <relative level>, <timing offset> or <I/Q-mapping>, <pilot length>, ...

CWCDp

10 values are transmitted for each channel:

<code class>, <channel number>, <absolute level>, <relative level>, <timing offset>, <pilot length>, <active flag>, <channel type>, <modulation type>, <reserved>, ...

The channels are output in ascending order sorted by code number, i.e. in the same sequence they are displayed on screen.

CTABLE

7 values are transmitted for each channel:

< class>, <channel number>, <absolute level>, <relative level>, <timing offset>, <pilot length>, <active|inactive>...

Parameter for RF measurements

TRACE1 | TRACE2 | TRACE3 | TRACE4 | LIST, <block> | <numeric_value>

TRACE1 to TRACE4 trace memory to be read out

LIST peak list data

<block> or <numeric_value> data to be transferred

(For further details refer to "[TRACe<1|2>\[:DATA\]](#)" on page 6.256.

TRACe1:DATA? LIST

This command queries the list evaluation results. All results are float values.

This command is only a query and therefore has no *RST value.

Returned values

<no>, <start>, <stop>, <rbw>, <freq>, <power abs>, <power rel>, <delta>, <limit check>, <unused1>, <unused2>

Value	Description
<no>	range number
<start>	start frequency
<stop>	stop frequency
<rbw>	resolution bandwidth of range
<freq>	frequency of peak
<power abs>	absolut power in dBm of peak
<power rel>	relative power in dBc (related to the channel power) of peak
<delta>	distance to the limit line in dB (positive indicates value above the limit, fail)
<limit check>	limit fail (pass = 0, fail =1)
<unused1>	reserved (0.0)

Value	Description
<unused2>	reserved (0.0)

Example

CONF:WCDP:MEAS ESP
Selects the spectrum emission mask measurement.
TRACe1:DATA? LIST
Queries the list evaluation results.

Characteristics

RST value: -
SCPI: device-specific

Mode

WCDMA

TRIGger Subsystem (WCDMA, K72)

The TRIGger subsystem is used to synchronize instrument actions with events. It is thus possible to control and synchronize the start of a sweep.

Commands of the TRIGger Subsystem

– [TRIGger<1|2>\[:SEQuence\]:SOURce](#)

[TRIGger<1|2>\[:SEQuence\]:SOURce](#)

Parameter

IMMediate (Free Run) | EXTernal | IFPower

For further details refer to "[TRIGger<1|2>\[:SEQuence\]:SOURce](#)" on page 6.272.

Remote Commands of the CDMA2000 BTS Analyzer Option (K82)

This chapter describes the remote commands for the CDMA2000 BTS Analyzer option (K82). The abbreviation CDMA stands for the operating mode of this option. For details on conventions used in this chapter refer to section "Notation" on page 6.2 at the beginning of this chapter.

For further information on analyzer or basic settings commands, refer to the corresponding subsystem in "Remote Commands of the Base Unit" on page 6.5.

This option is available from firmware version 1.90.

Subsystems of the CDMA2000 BTS Analyzer option (K82)

- "CALCulate Subsystem (CDMA, K82)" on page 6.595
- "CONFigure Subsystem (CDMA, K82)" on page 6.602
- "DISPlay Subsystem (CDMA, K82)" on page 6.608
- "INSTrument Subsystem (CDMA, K82)" on page 6.610
- "SENSe Subsystem (CDMA, K82)" on page 6.611
- "TRACe Subsystem (CDMA, K82)" on page 6.618

CALCulate Subsystem (CDMA, K82)

The CALCulate subsystem contains commands for converting instrument data, transforming and carrying out corrections. These functions are carried out subsequent to data acquisition, i.e. following the SENSE subsystem.

The following subsystems are included:

- "CALCulate:FEED Subsystem (CDMA, K82)" on page 6.595
- "CALCulate:LIMit:ESPECTrum Subsystem (CDMA, K82)" on page 6.597
- "CALCulate:MARKer<1...4>:FUNCTion Subsystem (CDMA, K82)" on page 6.599
- "CALCulate:STATistics Subsystem (CDMA, K82)" on page 6.601

CALCulate:FEED Subsystem (CDMA, K82)

The CALCulate:FEED subsystem selects the type of evaluation for the measurement data. This corresponds to the result display selection in manual operation.

Commands of the CALCulate:FEED Subsystem

– CALCulate<1|2>:FEED

CALCulate<1|2>:FEED

This command selects the result display for the measured data. The numeric suffix at CALCulate<1|2> specifies the measurement window.

Parameter

XPOW:CDP	Code Domain Power (CDP) result display (absolute)
XPOW:CDP:RAT	Code Domain Power (CDP) result display (relative)
XPOW:CDEP	Code Domain Error Power (CDEP) result display
XTIM:CDP:ERR:CTable	Channel Table result display
XTIM:CDP:PVSLOT	Power versus Power Control Group (PCG) result display
XTIM:CDP:ERR:SUMM	Result Summary result display
XTIM:CDP:MACCuracy	Composite EVM result display
XTIM:CDP:ERR:PCDomain	Peak Code Domain Error result display
XTIM:CDP:SYMB:CONST	Channel Constellation result display
XTIM:CDP:SYMB:EVM	Symbol Error Vector Magnitude result display
XTIM:CDP:BSTReam	Channel Bitstream result display
XTIM:CDP:COMP:CONST	Composite Constellation result display
XTIM:CDP:PVSYMBOL	Power versus Symbol result display

Example

```
CALC2:FEED 'XTIM:CDP:MACC'
```

Selects the Composite EVM result display.

Characteristics

RST value: 'XPOW:CDP:RAT'

SCPI: conform

Mode

CDMA

CALCulate:LIMit:ESpectrum Subsystem (CDMA, K82)

The CALCulate:LIMit:ESpectrum subsystem defines the limit check for the Spectrum Emission Mask.

Commands of the CALCulate:LIMit:ESpectrum Subsystem

- CALCulate<1|2>:LIMit<1...8>:ESpectrum:MODE
- CALCulate<1|2>:LIMit<1...8>:ESpectrum:RESTore
- CALCulate<1|2>:LIMit<1...8>:ESpectrum:VALue

CALCulate<1|2>:LIMit<1...8>:ESpectrum:MODE

This command activates or deactivates the automatic selection of the limit line in the Spectrum Emission Mask measurement. The numeric suffix at CALCulate<1|2> specifies the measurement window. The numeric suffix at LIMit<1...8> is irrelevant for this command.

Parameter

- AUTO The limit line depends on the measured channel power.
- MANUAL One of the three specified limit lines is set. The selection is made with the
CALCulate<1|2>:LIMit<1...8>:ESpectrum:VALue command.

Example

```
CALC:LIM:ESP:MODE AUTO
```

Activates automatic selection of the limit line.

Characteristics

- RST value: AUTO
- SCPI: device-specific

Mode

CDMA

CALCulate<1|2>:LIMit<1...8>:ESpectrum:RESTore

This command restores the predefined limit lines for the Spectrum Emission Mask measurement. All modifications made to the predefined limit lines are lost and the factory-set values are restored.

The numeric suffix at CALCulate<1|2> specifies the measurement window. The numeric suffix at LIMit<1...8> is irrelevant for this command.

This command is an event and therefore has no *RST value and no query.

Example

```
CALC:LIM:ESP:REST
```

Resets the limit lines for the Spectrum Emission Mask to the default setting.

Characteristics

- RST value: -
- SCPI: device-specific

Mode

CDMA

CALCulate<1|2>:LIMit<1...8>:ESPectrum:VALue

This command activates the manual limit line selection and specifies the expected power as a value. Depending on the entered value, one of the predefined limit lines is selected.

The numeric suffix at CALCulate<1|2> specifies the measurement window. The numeric suffix at LIMit<1...8> is irrelevant for this command.

Parameter

33 $P \geq 33$

28 $28 \leq P < 33$

0 $P < 28$

Example

CALC:LIM:ESP:VAL 33

Activates manual selection of the limit line and selects the limit line for $P \geq 33$.

Characteristics

RST value: 0

SCPI: device-specific

Mode

CDMA

CALCulate:MARKer<1...4>:FUNction Subsystem (CDMA, K82)

The CALCulate:MARKer:FUNction subsystem checks the marker functions in the instrument.

Commands of the CALCulate:MARKer<1...4>:FUNction Subsystem

- CALCulate<1|2>:MARKer<1...4>:FUNction:CDPower[:BTS]:RESult?
- CALCulate<1|2>:MARKer<1...4>:FUNction:PICH
- CALCulate<1|2>:MARKer<1...4>:FUNction:TDPIch

CALCulate<1|2>:MARKer<1...4>:FUNction:CDPower[:BTS]:RESult?

This command queries the results of the code domain measurement for the selected channel. The channel is selected via the [SENSe<1|2>:]CDPower:CODE command.

The numeric suffix at CALCulate<1|2> specifies the measurement window. The numeric suffix at MARKer<1...4> is irrelevant for this command.

Parameter

SLOT | PTOTal | PPICH | RHO | MACCuracy | PCDError | ACTive | FERRor | FERPPm | CERRor | TFRame | IQOFFset | IQIMbalance | SRATe | CHANnel | SFACtor | TOFFset | POFFset | CDPabsolute | CDPRelative | EVMRms | EVMPeak | DMType

For a description of the parameter refer to "Result Summary" on page 6.623.

Example

```
CALC:MARK:FUNC:CDP:RES? PTOT
```

Reads out total power.

```
CDP:SLOT 2
```

Selects power control group 2.

```
CDP:CODE 11
```

Selects code number 11.

```
CALC:MARK:FUNC:CDP:RES? EVMR
```

Reads out EVM rms of the code with number 11 in PCG 2.

Characteristics

RST value: -

SCPI: device-specific

Mode

CDMA

CALCulate<1|2>:MARKer<1...4>:FUNction:PICH

This command sets the marker to channel 0.64.

The numeric suffix at CALCulate<1|2> specifies the measurement window. The numeric suffix at MARKer<1...4> specifies the marker to be set to the pilot channel.

This command is an event and therefore has no *RST value and no query.

Example

```
CALC:MARK:FUNC:PICH
```

Activates marker and positions it at pilot 0.64.

```
CALC:MARK:Y?
```

Queries value of the relative Code Domain Power of the pilot channel.

Characteristics

RST value: -

SCPI: device-specific

ModeCDMA

CALCulate<1|2>:MARKer<1...4>:FUNCTion:TDPIch

This command sets the marker 1 to channel 16.128.

The numeric suffix at CALCulate<1|2> specifies the measurement window. The numeric suffix at MARKer<1...4> specifies the marker to be set to the pilot channel.

This command is an event and therefore has no *RST value and no query.

Example

```
CALC:MARK:FUNC:TDPI
```

Activates marker and positions it at TDPICH 16.128.

```
CALC:MARK:Y?
```

Queries value of the relative Code Domain Power of the transmit diversity pilot channel.

Characteristics

RST value: -

SCPI: device-specific

ModeCDMA

CALCulate:STATistics Subsystem (CDMA, K82)

The CALCulate:STATistics subsystem controls the statistical measurement functions. The measurement window cannot be selected for these measurement functions. No numeric suffix at CALCulate is available.

Commands of the CALCulate:STATistics Subsystem

- [CALCulate:STATistics:CCDF\[:STATe\]](#)
- [CALCulate:STATistics:NSAMples](#)
- [CALCulate:STATistics:RESult<1...4>?](#)
- [CALCulate:STATistics:SCALE:Y:LOWer](#)
- [CALCulate:STATistics:SCALE:Y:UPPer](#)

CALCulate:STATistics:CCDF[:STATe]

For details refer to the "[CALCulate:STATistics:CCDF\[:STATe\]](#)" command of the base unit on page 6.110.

CALCulate:STATistics:NSAMples

For details refer to the "[CALCulate:STATistics:NSAMples](#)" command of the base unit on page 6.111.

CALCulate:STATistics:RESult<1...4>?

For details refer to the "[CALCulate:STATistics:RESult<1...6>?](#)" command of the base unit on page 6.111.

CALCulate:STATistics:SCALE:Y:LOWer

For details refer to the "[CALCulate:STATistics:SCALE:Y:LOWer](#)" command of the base unit on page 6.113.

CALCulate:STATistics:SCALE:Y:UPPer

For details refer to the "[CALCulate:STATistics:SCALE:Y:UPPer](#)" command of the base unit on page 6.114.

CONFigure Subsystem (CDMA, K82)

The CONFigure subsystem contains commands for configuring the measurements.

The following subsystem is included:

- ["CONFigure:CDPower Subsystem \(CDMA, K82\)"](#) on page 6.602

CONFigure:CDPower Subsystem (CDMA, K82)

This subsystem contains the commands for measurement selection and configuration of the CDMA2000 BTS Analyzer option.

Further setting commands for the spectrum emission mask measurement are in the ["CALCulate:LIMit:ESpectrum Subsystem \(CDMA, K82\)"](#) on page 6.597.

Commands of the CONFigure:CDPower Subsystem

- [CONFigure:CDPower\[:BTS\]:CTABLE\[:STATE\]](#)
- [CONFigure:CDPower\[:BTS\]:CTABLE:CATalog?](#)
- [CONFigure:CDPower\[:BTS\]:CTABLE:COMMent](#)
- [CONFigure:CDPower\[:BTS\]:CTABLE:COpy](#)
- [CONFigure:CDPower\[:BTS\]:CTABLE:DATA](#)
- [CONFigure:CDPower\[:BTS\]:CTABLE:DELeTe](#)
- [CONFigure:CDPower\[:BTS\]:CTABLE:NAME](#)
- [CONFigure:CDPower\[:BTS\]:CTABLE:SELeCt](#)
- [CONFigure:CDPower\[:BTS\]:BCLass](#)
- [CONFigure:CDPower\[:BTS\]:MCARier\[:STATE\]](#)
- [CONFigure:CDPower\[:BTS\]:MEASurement](#)
- [CONFigure:CDPower:CTABLE:RESTore](#)

CONFigure:CDPower[:BTS]:CTABLE[:STATE]

This command activates or deactivates the 'RECENT' channel table. To select another channel table, use the [CONFigure:CDPower\[:BTS\]:CTABLE:SELeCt](#) command.

Parameter

ON | OFF

Example

```
CONF:CDP:CTAB ON
```

Activates predefined channel table.

```
CONF:CDP:CTAB:SEL 'CTAB_1'
```

Selects channel table.

Characteristics

RST value: OFF

SCPI: device-specific

Mode

CDMA

CONFigure:CDPower[:BTS]:CTABLE:CATalog?

This command queries the names of all the channel tables stored on the flash disk for CDMA2000.

Return values

<sum of file sizes of all subsequent files>, <spare storage space on hard disk>, <1st file name>, <1st file size>, <2nd file name>, <2nd file size>, ..., <nth file name>, <nth file size>, ...

Example

```
CONF:CDP:CTAB:CAT?
Queries catalog.
```

Characteristics

RST value: -

SCPI: device-specific

Mode

CDMA

CONFigure:CDPower[:BTS]:CTABLE:COMment

This command defines a comment on the selected channel table.

Parameter

<'string'> = comment on the channel table

Example

```
CONF:CDP:CTAB:NAME 'NEW_TAB'
```

Selects channel table for editing. If a channel table with this name does not exist, a new channel table is created.

```
CONF:CDP:CTAB:DATA 0,6,0,0,0,0,1,0.0,10,5,3,4,0,0,1,0.0
```

Defines a table with the following channels: PICH 0.64 and data channel with RC4/Walsh code 3.32.

```
CONF:CDP:CTAB:COMM 'Comment for NEW_TAB'
```

Specifies 'Comment for NEW_TAB' as comment.

Characteristics

RST value: -

SCPI: device-specific

Mode

CDMA

CONFigure:CDPower[:BTS]:CTABLE:COpy

This command copies one channel table to another. Select the channel table you want to copy using the [CONFigure:CDPower\[:BTS\]:CTABLE:NAME](#) command.

This command is an event and therefore has no *RST value and no query.

Parameter

<'string'> = name of the new channel table.

Example

```
CONF:CDP:CTAB:NAME 'CTAB_1'
```

Selects channel table *CTAB_1* for copying.

CONF:CDP:CTAB:COPY 'CTAB_2'
Copies CTAB_1 to C_TAB2.

Characteristics

RST value: -
SCPI: device-specific

Mode

CDMA

CONFigure:CDPower[:BTS]:CTABLE:DATA

This command defines a channel table.

Parameter

For one table line, eight values are specified .

<channel type>, <code class>, <code number>, <radio configuration>, <reserved1>, <reserved2>, <status>, <CDP relative>,

channel type	For details on the values refer to Channel Table on page 6.621.
code class	
code number	
radio configuration	
reserved1	always 0 (reserved)
reserved2	
status	0: inactive 1: active
CDP relative	any value in dB

The inactive channels (INACTIVE) do not have to be defined.

Example

CONF:CDP:CTAB:NAME 'NEW_TAB'

Selects channel table for editing. If a channel table with this name does not exist, a new channel table is created.

CONF:CDP:CTAB:DATA 0,6,0,0,0,0,1,0.0,10,5,3,4,0,0,1,0.0

Defines a table with the following channels: PICH 0.64 and data channel with RC4/Walsh code 3.32.

Characteristics

RST value: -
SCPI: device-specific

Mode

CDMA

CONFigure:CDPower[:BTS]:CTABLE:DELeTe

This command deletes the selected channel table. Select the channel table you want to delete using the [CONFigure:CDPower\[:BTS\]:CTABLE:NAME](#) command.

This command is an event and therefore has no *RST value and no query.

Example

CONF:CDP:CTAB:NAME 'CTAB_1'

Selects channel table CTAB_2 for deleting.

CONF:CDP:CTAB:DEL
 Deletes channel table *CTAB_2*.

Characteristics

RST value: -
 SCPI: device-specific

Mode

CDMA

CONFigure:CDPower[:BTS]:CTABLE:NAME

This command selects a channel table for editing or creating. To select a command for analysis, use the [CONFigure:CDPower\[:BTS\]:CTABLE:SElect](#) command.

Parameter

<'string'> = name of the channel table

Example

CONF:CDP:CTAB:NAME 'NEW_TAB'

Selects channel table for editing. If a channel table with this name does not exist, a new channel table is created.

Characteristics

RST value: -
 SCPI: device-specific

Mode

CDMA

CONFigure:CDPower[:BTS]:CTABLE:SElect

This command selects a predefined channel table.

Parameter

<'string'> = name of the channel table

Example

Refer to the example of the [CONFigure:CDPower\[:BTS\]:CTABLE\[:STATE\]](#) command.

Characteristics

RST value: "RECENT"
 SCPI: device-specific

Mode

CDMA

CONFigure:CDPower[:BTS]:BClass

This command selects the band class to be used.

Parameter

0 to 15

Example

CONF:CDP:BCL 1

Selects band class 1, 1900 MHz

Characteristics

RST value: 0

SCPI: device specific

Mode

CDMA

CONFigure:CDPower[:BTS]:MCARier[:STATe]

This command activates or deactivates the settings that improve the processing of multi-carrier signals.

Parameter

ON | OFF

Example

CONF:CDP:MCAR ON

Activates the multi-carrier settings.

Characteristics

RST value: OFF

SCPI: device-specific

Mode

CDMA

CONFigure:CDPower[:BTS]:MEASurement

This command selects the measurements of the CDMA2000 BTS Analyzer option. The predefined settings of the different measurements are described in chapter 4, section "Softkeys of the measurement menu (CDMA2000 BTS Analyzer mode)". **Parameter**

ACL R	Adjacent-Channel Power measurement with predefined settings according to the CDMA2000 standard
CCDF	measurement of the complementary cumulative distribution function (signal statistics)
CDPower	Code Domain Analyzer measurement.
ESpectrum	check of signal power (Spectrum Emission Mask)
OBWidth	measurement of the occupied bandwidth
POWER	Signal Channel Power measurement with predefined settings according to the CDMA2000 standard

Example

CONF:CDP:MEAS POW

Selects Signal Channel Power measurement .

Characteristics

RST value: CDPower

SCPI: device-specific

Mode

CDMA

CONFigure:CDPower:CTABLE:RESTore

This command restores the predefined channel tables to their factory-set values. In this way, you can undo unintentional overwriting.

This command is an event and therefore has no *RST value and no query.

Example

```
CONF:CDP:CTAB:REST
Restores the channel table.
```

Characteristics

RST value: -

SCPI: device-specific

Mode

CDMA

DISPlay Subsystem (CDMA, K82)

The DISPlay subsystem controls the selection and presentation of textual and graphic information as well as of measurement data on the display.

Commands of the DISPlay Subsystem

- DISPlay:FORMat
- DISPlay[:WINDow<1|2>]:SSElect
- DISPlay[:WINDow<1|2>]:TRACe<1...6>:Y[:SCALe]:AUTO
- DISPlay[:WINDow<1|2>]:TRACe<1...6>:Y[:SCALe]:MAXimum
- DISPlay[:WINDow<1|2>]:TRACe<1...6>:Y[:SCALe]:MINimum

DISPlay:FORMat

This command sets the visible screen display type to full or split screen.

Parameter

SPLit | SINGle

Example

```
DISP:FORM SINGLE
```

Sets the display to full screen.

Characteristics

*RST value: SPL

SCPI: device-specific

Mode

CDMA

DISPlay[:WINDow<1|2>]:SSElect

This command selects whether screen A or screen B is active. SSElect means Screen SElect.

Example

```
DISP:WIND1:SSEL
```

Sets the screen A active.

Characteristics

*RST value: 1

SCPI: device-specific

Mode

CDMA

DISPlay[:WINDow<1|2>]:TRACe<1...6>:Y[:SCALe]:AUTO

This command switches on or off automatic scaling of the Y-axis for the specified trace display. Automatic scaling sets the Y-axis to automatically scale to best fit the measurement results.

The numeric suffix at WINDow<1|2> selects the measurement window. The numeric suffix at TRACe<1...6> must be 1.

Parameter

ONCE

Example

```
DISP:WIND2:TRAC:Y:SCAL:AUTO ONCE
```

activates automatic scaling of the Y-axis for the active trace

Characteristics

*RST value: OFF

ModeCDMA

DISPlay[:WINDow<1|2>]:TRACe<1...6>:Y[:SCALe]:MAXimum

This command defines the maximum value of the y-axis for the selected result display.

Parameter

<numeric value>

The unit and range depend on the result display.

Example

```
DISP:TRAC:Y:MIN -60
```

```
DISP:TRAC:Y:MAX 0
```

Defines the y-axis with a minimum value of -60 and maximum value of 0.

Characteristics

*RST value: depends on the result display

SCPI: device-specific

ModeCDMA

DISPlay[:WINDow<1|2>]:TRACe<1...6>:Y[:SCALe]:MINimum

This command defines the minimum value of the y-axis for the selected result display.

Parameter

<numeric value>

The unit and range depend on the result display.

Example

```
DISP:TRAC:Y:MIN -60
```

```
DISP:TRAC:Y:MAX 0
```

Defines the y-axis with a minimum value of -60 and maximum value of 0.

Characteristics

*RST value: depends on the result display

SCPI: device-specific

ModeCDMA

INSTrument Subsystem (CDMA, K82)

The INSTrument subsystem selects the operating mode of the unit either via text parameters or fixed numbers.

Commands of the INSTrument Subsystem

- [INSTrument\[:SElect\]](#)
- [INSTrument:NSElect](#)

INSTrument[:SElect]

Parameter

BC2K (CDMA2000 BTS Analyzer option, R&S FSL-K82)

For further details refer to the INSTrument subsystem of the base unit.

INSTrument:NSElect

Parameter

10 (CDMA2000 BTS Analyzer option, R&S FSL-K82)

For further details refer to the INSTrument subsystem of the base unit.

SENSe Subsystem (CDMA, K82)

The SENSe subsystem controls the essential parameters of the analyzer. In accordance with the SCPI standard, the keyword "SENSe" is optional for this reason, which means that it is not necessary to include the SENSe node in command sequences.

The following subsystems is included:

- "SENSe:CDPower Subsystem (CDMA, K82)" on page 6.611
- "SENSe:ESpectrum Subsystem (CDMA, K82)" on page 6.617

SENSe:CDPower Subsystem (CDMA, K82)

This subsystem sets the parameters for the code domain measurements mode.

Commands of the SENSe:CDPower Subsystem

- [SENSe<1|2>:]CDPower:ANTenna
- [SENSe<1|2>:]CDPower:CODE
- [SENSe<1|2>:]CDPower:ICTReshold
- [SENSe<1|2>:]CDPower:IQLength
- [SENSe<1|2>:]CDPower:LEVel:ADJust
- [SENSe<1|2>:]CDPower:NORMalize
- [SENSe<1|2>:]CDPower:ORDer
- [SENSe<1|2>:]CDPower:PNOFfset
- [SENSe<1|2>:]CDPower:PREFerence
- [SENSe<1|2>:]CDPower:QINVert
- [SENSe<1|2>:]CDPower:SFACTOR
- [SENSe<1|2>:]CDPower:SLOT
- [SENSe<1|2>:]CDPower:TPMeas

[SENSe<1|2>:]CDPower:ANTenna

This command deactivates the orthogonal transmit diversity (two-antenna system) or defines the antenna for which the result display evaluated.

The numeric suffix at SENSe<1|2> is irrelevant for this command.

Parameter

- | | |
|-----|--|
| OFF | The aggregate signal from both antennas is fed in. |
| 1 | The signal of antenna 1 is fed in. |
| 2 | The signal of antenna 2 is fed in. |

For further details refer to chapter 4, "Antenna Diversity".

Example

```
CDP:ANT 2
Selects antenna 2.
```

Characteristics

RST value: OFF

SCPI: device-specific

Mode

CDMA

[SENSe<1|2>:]CDPower:CODE

This command selects the code number.

The numeric suffix at SENSe<1|2> is irrelevant for this command.

Parameter

0 to 127; the maximum value depends on the base spreading factor;

For further details refer to chapter 4, "Channel (Code) Number".

Example

```
CDP:SFAC 128
```

Selects base spreading factor 128.

```
CDP:CODE 11
```

Selects code number 11.

Characteristics

RST value: 0

SCPI: device-specific

Mode

CDMA

[SENSe<1|2>:]CDPower:ICTReshold

This command defines the minimum power which a single channel must have compared to the total signal in order to be regarded as an active channel. Channels below the specified threshold are regarded as "inactive".

The numeric suffix at SENSe<1|2> is irrelevant for this command.

Parameter

-100 dB to 0 dB

Example

```
CDP:ICTR -10DB
```

Sets threshold value to -10 dB.

Characteristics

RST value: -60 dB

SCPI: device-specific

Mode

CDMA

[SENSe<1|2>:]CDPower:IQLength

This command sets the capture length in multiples of the power control group.
The numeric suffix at SENSe<1|2> is irrelevant for this command.

Parameter

2 to 12

Example

CDP:IQL 8

Sets 8 PCGs as capture length.

Characteristics

RST value: 3

SCPI: device-specific

Mode

CDMA

[SENSe<1|2>:]CDPower:LEVel:ADJust

This command adjusts the reference level of the R&S FSL to the measured channel power. This ensures that the settings of the RF attenuation and the reference level are optimally adjusted to the signal level without overloading the R&S FSL or limiting the dynamic response by a too low signal-to-noise ratio. The numeric suffix at SENSe<1|2> is irrelevant for this command.

This command is an event and therefore has no *RST value and no query.

Example

CDP:LEV:ADJ

Starts automatic level setting.

Characteristics

RST value: -

SCPI: device-specific

Mode

CDMA

[SENSe<1|2>:]CDPower:NORMalize

This command activates or deactivates the elimination of the IQ offset from the signal.
The numeric suffix at SENSe<1|2> is irrelevant for this command.

Parameter

ON | OFF

Example

CDP:NORM ON

Eliminates the DC offset from the signal.

Characteristics

RST value: OFF

SCPI: device-specific

Mode

CDMA

[SENSe<1|2>:]CDPower:ORDER

This command sets the channel sorting for the Code Domain Power and Code Domain Error result displays.

The numeric suffix at SENSe<1|2> is irrelevant for this command.

Parameter

HADamard | BITReverse

For further details refer to chapter 4, "Code Order".

Example

```
CDP:ORD HAD
```

Sets Hadamard order.

```
TRAC? TRACE2
```

Reads out the results in Hadamard order.

```
CDP:ORD BITR
```

Sets BitReverse order.

```
TRAC? TRACE2
```

Reads out the results in BitReverse order.

Characteristics

RST value: HADamard

SCPI: device-specific

Mode

CDMA

[SENSe<1|2>:]CDPower:PNOFfset

This command sets the PN offset of the base station in multiples of 64 chips.

The numeric suffix at SENSe<1|2> is irrelevant for this command.

Parameter

0 to 511

Example

```
CDP:PNOF 45
```

Sets PN offset.

Characteristics

RST value: 0

SCPI: device-specific

Mode

CDMA

[SENSe<1|2>:]CDPower:PREFference

This command specifies the reference power for the relative power result displays (Code Domain Power, Power vs PCG).

The numeric suffix at SENSe<1|2> is irrelevant for this command.

Parameter

PICH The reference power is the power of the pilot channel. Which pilot channel is used as reference depends on the antenna diversity (for details see

[SENSe<1|2>:]CDPower:ANTenna command).

TOTal The reference power is the total power of the signal referred per power control group (PCG) to the corresponding PCG.

For further information refer to chapter 4, "Power Reference"

Example

```
CDP:PREF TOT
```

Sets total power as reference power.

Characteristics

RST value: PICH

SCPI: device-specific

Mode

CDMA

[SENSe<1|2>:]CDPower:QINVert

This command inverts the sign of the Q-component of the signal.
The numeric suffix at SENSe<1|2> is irrelevant for this command.

Parameter

ON | OFF

Example

```
CDP:QINV ON
```

Activates the inversion of the Q-component sign.

Characteristics

RST value: OFF

SCPI: device-specific

Mode

CDMA

[SENSe<1|2>:]CDPower:SFACTOR

This command defines the base spreading factor. If the base spreading factor of 64 is used for channels of spreading factor 128 (code class 7), an alias power is displayed in the Code Domain Power and Code Domain Error Power diagrams.

The numeric suffix at SENSe<1|2> is irrelevant for this command.

Parameter

64 | 128

Example

```
CDP:SFAC 128
```

Selects base spreading factor 128.

Characteristics

RST value: 64

SCPI: device-specific

Mode

CDMA

[SENSe<1|2>:]CDPower:SLOT

This command selects the power control group (PCG).
The numeric suffix at SENSe<1|2> is irrelevant for this command.

Parameter

0 to (capture length-1)

The capture length is defined via the [\[SENSe<1|2>:\]CDPower:IQLength](#) command.

Example

```
CDP:SLOT 2
```

Selects power control group 2.

Characteristics

RST value: 0

SCPI: device-specific

Mode

CDMA

[SENSe<1|2>:]CDPower:TPMeas

This command activates or deactivates the timing and phase offset evaluation of the channels to the pilot.

The numeric suffix at SENSe<1|2> is irrelevant for this command.

The results are queried using the [TRACE<1|2>\[:DATA\]](#) command, [Channel Table](#) return values, and the [CALCulate<1|2>:MARKer<1...4>:FUNCTION:CDPower\[:BTS\]:RESULT?](#) command.

Parameter

ON | OFF

Example

```
CDP:TPM ON
```

Activates timing and phase offset.

Characteristics

RST value: OFF

SCPI: device-specific

Mode

CDMA

SENSe:ESpectrum Subsystem (CDMA, K82)

This subsystem sets the parameters for the code domain measurements mode. The numeric suffix at SENSe<1|2> is irrelevant.

Commands of the SENSe:ESpectrum Subsystem

- [SENSe<1|2>:]ESpectrum:PRESet[:STANdard]
 - [SENSe<1|2>:]ESpectrum:PRESet:RESTore
 - [SENSe<1|2>:]ESpectrum:STORE
-

[SENSe<1|2>:]ESpectrum:PRESet[:STANdard]

For details refer to the [SENSe<1|2>:]ESpectrum:PRESet[:STANdard] command of the base unit on page 6.183.

[SENSe<1|2>:]ESpectrum:PRESet:RESTore

For details refer to the [SENSe<1|2>:]ESpectrum:PRESet:RESTore command of the base unit on page 6.183.

[SENSe<1|2>:]ESpectrum:STORE

This command saves the specified XML file under *C:\r_sl\instr\sem_std*. To save the file in subdirectory, include the relative path.

The numeric suffixes <1|2> are not relevant.

This command is an event and therefore has no *RST value and no query.

Example

```
ESP:STOR 'CDMA2000\DL\BandClass_20.xml'
```

Saves the *BandClass_20.xml* XML file in the *C:\R_S\instr\sem_std\CDMA2000\DL* directory.

Characteristics

RST value: -

SCPI: device-specific

Mode

CDMA

TRACe Subsystem (CDMA, K82)

The TRACe subsystem controls access to the instruments internal trace memory.

Commands of the TRACe Subsystem

- [TRACe<1|2>\[:DATA\]](#)

TRACe<1|2>[:DATA]

This command transfers trace data from the controller to the R&S FSL, the query command reads trace data from the R&S FSL. The numeric suffix at TRACe<1|2> is irrelevant.

For details on reading trace data for other than code domain measurements refer to [TRACe<1|2>\[:DATA\]](#).

Parameter

TRACE1 TRACE2	Reads out the trace data of measurement window 1 or 2.
CTABLE	For the Channel Table result display, reads out the maximum values of the timing/phase offset between every assigned channel and the pilot channel (see also [SENSe<1 2>:]CDPower:TPMeas command).

Return values

The measurement results are explained separately for each measurement and illustrated by a short example:

- [Code Domain Power](#) on page 6.619
- [Code Domain Error Power](#) on page 6.620
- [Channel Table](#) on page 6.621
- [Result Summary](#) on page 6.623
- [Power vs PCG](#) on page 6.624
- [Peak Code Domain Error](#) on page 6.624
- [Composite EVM](#) on page 6.624
- [EVM vs Symbol](#) on page 6.625
- [Power vs Symbol](#) on page 6.625
- [Channel Constellation](#) on page 6.625
- [Composite Constellation](#) on page 6.625
- [Channel Bitstream](#) on page 6.626

Characteristics

RST value: -

SCPI: conform

Mode

CDMA

Code Domain Power

The following values are transferred for each channel: <code class>, <code number>, <signal level>, <power ID>, ...

Parameter	Description	Output value
code class	code class of the channel, depending on the order setting via the <code>[SENSe<1 2>:]CDPower:ORDer</code> command	Hadamard order: corresponds to the class that belongs to the base spreading factor BitReverse order: 2 to 7
code number	code number of the channel	0 to 127
signal level	absolute or relative power, depending on the reference setting via the <code>[SENSe<1 2>:]CDPower:PREFerence</code> command	Hadamard order: power values of the different codes BitReverse order: consolidated channel power (see <code>[SENSe<1 2>:]CDPower:ORDer</code> command)
power ID	power detection To avoid alias power set the base spreading factor correctly (see <code>[SENSe<1 2>:]CDPower:SFACTOR</code> command).	0 - inactive channel 1 - power of own antenna 2 - alias power of own antenna 3 - alias power of other antenna 4 - alias power of own and other antenna

For sorting the channels and consolidation, the order is important (refer to the `[SENSe<1|2>:]CDPower:ORDer` command):

- In Hadamard order, the different codes are output in ascending order together with their code power. The number of output codes corresponds to the base spreading factor.
- In BitReverse order, codes belonging to a channel are next to one another and are therefore output in the class of the channel together with the consolidated channel power. The maximum number of output codes or channels cannot be higher than the base spreading factor, but decreases with every concentrated channel.

Example

The example shows the results of the query for five channels having the following configuration:

channel type	channel spreading code	code class	signal level
PICH	0.64	6	-7.0 dB
PCH	1.64	6	-7.3 dB
CHAN	8.32	5	-8.0 dB
<i>CHAN</i>	<i>24.128</i>	<i>7</i>	<i>-9.0 dB (alias with 24.64)</i>
SYNC	32.64	6	-13.3 dB

```
INST:SEL BC2K
```

Activates the CDMA2000 BTS Analyzer option.

```
INIT:CONT OFF
```

Selects single sweep.

```
CDP:ORD HAD
```

Sets order to Hadamard.

```
INIT;*WAI
```

Starts measurement with synchronization.

```
TRAC? TRACE1
```

Reads out the result.

Channel 8.32 is distributed to 8.64 and 40.64, in each case with half power -8 dB -3 dB = -11.0 dB

```

6   0   -7.0  1       6  1   -7.3  1  6
6   2  -54.6  0       6  3  -55.3  0  6
...
6   8  -11.0  1       6  9  -53.4  0  6
...
...       6 24  -9.0  2  6
...       6 32 -13.3  1  6
...       6 40 -11.0  1  6
...       6 63 -54.7  0  6
    
```

CDP:ORD BITR

Sets order to BitReverse.

TRAC? TRACE1

Reads out the result.

Channel 8.32 can be directly read out with its total power. The order is changed in accordance with BitReverse.

```

6   0   -7.0  1       6 32  -13.3  1  6
6  16  -56.3  0       6 48  -52.8  0  6
5   8   -8.0  1       6 24  -9.0  2  6
...
...       6  1   -7.3  1  6
...       6 63  -54.7  0  6
    
```

Code Domain Error Power

The following values are transferred for each channel: <code class>, <code number>, <error power>, <power ID>, ...

Parameter	Description	Output value
code class	code class of the channel; corresponds to the class that belongs to the base spreading factor	
code number	code number of the channel	0 to 127
error power	error power in dB, no difference of power between the Hadamard and BitReverse orders	
power ID	power detection To avoid alias power set the base spreading factor correctly (see [SENSe<1 2>:]CDPower:SFACTOR command).	0 - inactive channel 1 - power of own antenna 2 - alias power of own antenna 3 - alias power of other antenna 4 - alias power of own and other antenna

For sorting the channels and consolidation, the order is important (refer to the [SENSe<1|2>:]CDPower:ORDER command):

- In Hadamard order, the different codes are output in ascending order.
- In BitReverse order, codes belonging to a channel are next to one another. Because an error power is output with the code domain error power, a consolidation of the power values is not sensible.

The number of output codes therefore generally corresponds to the base spreading factor.

Example

The example shows the results of the query for five channels having the following configuration:

channel type	channel spreading code	code class	signal level
PICH	0.64	6	-7.0 dB
PCH	1.64	6	-7.3 dB
CHAN	8.32	5	-8.0 dB
CHAN	24.128	7	-9.0 dB (alias with 24.64)
SYNC	32.64	6	-13.3 dB

INST:SEL BC2K

Activates the CDMA2000 BTS Analyzer option.

INIT:CONT OFF

Selects single sweep.

CALC2:FEED 'XPOW:CDEP'

Selects the Code Domain Error Power result display.

INIT;*WAI

Starts measurement with synchronization.

TRAC? TRACE1

Reads out the result in Hadamard order.

6	0	-52.6	1	6	1	-60.1	1	6
6	2	-54.6	0	6	3	-55.3	0	6
	...			6	7	-58.2	0	6
6	8	-51.9	1	6	9	-53.4	0	6
	...			6	24	-55.7	2	6
	...			6	32	-58.6	1	6
	...			6	40	-60.5	1	6
	...			6	63	-54.7	0	6

Channel Table

With the TRACE1 | TRACE2 parameter, the following values are transferred for each channel: <channel type>, <code class>, <code number>, <radio configuration>, <absolute level>, <relative level>, <timing offset>, <phase offset>, ...

Parameter	Description	Output value
channel type	channel type , coded with numbers	0 - PICH 1 - SYNC 2 - PCH 3 - TDPICH 4 - APICH 5 - ATDPICH 6 - BCH 7 - CPCCH 8 - CACH 9 - CCCH 10 - CHAN 11 - INACTIVE 12 - PDCCH 13 - PDCH
code class	code class of the channel, specifies the spreading factor	2 to 7 2 corresponds to the lowest allowed spreading factor (4, symbol rate 307.2 ksps) 7 corresponds to the highest spreading factor (128, symbol rate 9.6 ksps)
code number	code number of the channel	0 to 127

radio configuration	radio configuration, coded with numbers	0 - special channels 1 to 5 - data channels (CHAN) 10 - QPSK 20 - 8PSK 30 - 16QAM (If the auto search function is activated via the <code>CONFigure:CDPower[:BTS]:CTABLE[:STATE]</code> command, '1' is returned for RCs 1&2, '3' for RCs 3 to 5 and 10 for PDCH)
absolute level	in dBm	
relative level	in dB, referred to the total or pilot power via the <code>[SENSe<1 2>:]CDPower:PREference</code> command	
timing offset	referred to the pilot in seconds	
phase offset	referred to the pilot in rad	9 - evaluation of the timing and phase offset is not active (refer to <code>[SENSe<1 2>:]CDPower:TPMeas</code>) or more than 50 active channels or channel is inactive

Sorting of the channels:

1. all detected special channels
2. data channels, in ascending order by code class and within the code class in ascending order by code number.
3. unassigned codes, with the code class of the base spreading factor

With the `CTABLE` parameter, the following values are output: <max. time offset in s>, <code number for max. time>, <code class for max. time>, <max. phase offset in rad>, <code number for max. phase>, <code class for max. phase>, <reserved 1>, ..., <reserved 6>

Example

The example shows the results of the query for five channels having the following configuration:

channel type	channel spreading code	code class	signal level
PICH	0.64	6	-7.0 dB
PCH	1.64	6	-7.3 dB
CHAN	8.32	5	-8.0 dB
CHAN	24.128	7	-9.0 dB (alias with 24.64)
SYNC	32.64	6	-13.3 dB

```
INST:SEL BC2K
```

Activates the CDMA2000 BTS Analyzer option.

```
INIT:CONT OFF
```

Selects single sweep.

```
CALC1:FEED 'XTIM:CDP:ERR:CTAB'
```

Selects the Channel Table result display.

```
INIT;*WAI
```

Starts measurement with synchronization.

```
TRAC? TRACE1
```

Reads out the result in Hadamard order.

```
0 6 0 0 0.0 -7.0 9 9
1 6 32 0 -6.3 -13.3 9 9
2 6 1 0 -0.3 -7.3 9 9
10 5 8 3 -1.0 -8.0 9 9
```



```

10  7  24  3  -2.0  -9.0  9  9
11  6   2  3 -47.6 -54.6  9  9
    ...
11  6  63  3 -47.7 -54.7  9  9
    
```

CDP:TPM ON

Activates timing and phase offset measurement.

INIT;*WAI

Starts measurement with synchronization.

TRAC? CTAB

Reads out maximum timing and phase offsets.

1.20E-009,2,2,-3.01E-003,15,4,0,0,0,0,0,0

Max. time offset with code number and code class of associated channel, Max. phase offset with code number and code class of associated channel, 6 reserved values

Result Summary

The results are output in the following order: <SLOT>, <PTOTal>, <PPICH>, <RHO>, <MACCuracy>, <PCDerror>, <ACTive>, <FERRor>, <FERPpm>, <TFRame>, <CERRor>, <IQOFFset>, <IQIMbalance>, <SRATe>, <CHANnel>, <SFACtor>, <TOFFset>, <POFFset>, <CDPRelative>, <CDPabsolute>, <EVMRms>, <EVMPeak>

Global results of the selected PCG

Parameter	Description
SLOT	PCG number
PTOTal	total power in dBm
PPICH	pilot power in dBm
RHO	RHO
MACCuracy	composite EVM in %
PCDerror	peak code domain error in dB
IQOFFset	IQ offset in %
IQIMbalance	IQ imbalance in %

Global results of all PCGs

Parameter	Description
ACTive	number of active channels
FERRor	frequency error in Hz
FERPpm	frequency error in ppm
TFRame	trigger to frame; returns a '9' if the trigger is set to Free Run .
CERRor	chip rate error in ppm

Channel results

Parameter	Description
SRATe	symbol rate in kbps
CHANnel	channel number
SFACtor	spreading factor of the channel

Parameter	Description
TOFFset POFFset	timing offset in s; phase offset in rad; returns a '9' if the timing/phase offset measurement is switched off (see [SENSe<1 2>:]CDPower:TPMeas command) or the number of active channel exceeds 50.
CDPRelative	channel power relative in dB
CDPabsolute	channel power abs. in dBm (relative to total or PICH power, refer to CDP:PREF command)
EVMRms	error vector magnitude rms in %
EVMPeak	error vector mag. peak in %



The result of the modulation type can be read out with the command
[CALCulate<1|2>:MARKer<1...4>:FUNCTION:CDPower\[:BTS\]:RESult?](#)

Power vs PCG

The number of returned value pairs corresponds to the Capture length (see [\[SENSe<1|2>:\]CDPower:IQLength](#) command).

The results are output in the following order: <slot number>, <level value in dB>, <slot number>, <level value in dB>, ...

Peak Code Domain Error

The number of returned value pairs corresponds to the Capture length (see [\[SENSe<1|2>:\]CDPower:IQLength](#) command).

The results are output in the following order: <slot number>, <level value in dB>, ...

Composite EVM

The number of returned value pairs corresponds to the Capture length (see [\[SENSe<1|2>:\]CDPower:IQLength](#) command).

The results are output in the following order: <slot number>, <value in %>, ...

EVM vs Symbol

The results are output in the following order: <value in % symbol 0>, <value in % symbol 1>,...

The number of values depends on the spreading factor. With transmit diversity activated (see [\[SENSE<1|2>:\]CDPower:ANTenna](#) command), the number of values is reduced to the half.

Spreading factor	Number of values
128	12
64	24
32	48
16	96
8	192
4	384

Power vs Symbol

The results are output in the following order: <value in dBm symbol 0>, <value in dBm symbol 1>,...

The number of values depends on the spreading factor. With transmit diversity activated (see [\[SENSE<1|2>:\]CDPower:ANTenna](#) command), the number of values is reduced to the half.

Spreading factor	Number of values
128	12
64	24
32	48
16	96
8	192
4	384

Channel Constellation

Real and imaginary parts are transferred as value pairs: <re 0>,<im 0>,<re 1>,<im 1>,...,<re n>, <im n>

The number of value pairs depends on the spreading factor. With transmit diversity activated (see [\[SENSE<1|2>:\]CDPower:ANTenna](#) command), the number of pairs is reduced to the half.

Spreading factor	Number of value pairs
128	12
64	24
32	48
16	96
8	192
4	384

Composite Constellation

The number of value pairs corresponds to the chip number of 1536 chips in a power control group. Real and imaginary parts are transferred as value pairs: <re chip 0>,<im chip 0>,<re chip 1>,<im chip 1>,...

Channel Bitstream

Depending on the spreading factor (symbol rate) of the channel, a minimum of 12 and a maximum of 384 symbols can be contained in a power control group. Depending on the modulation type, a symbol consists of the following bits:

- BPSK: 1 bit (only the I-component is assigned)
- QPSK: 2 bits (I-component followed by the Q-component)
- 8PSK: 3 bits
- 16QAM: 4 bits

For each bit, a value is output (range 0,1).

BPSK modulation type

Spreading factor	Number of values
128	12
64	24
32	48
16	96
8	192
4	384

QPSK modulation type

Spreading factor	Number of values
128	24
64	48
32	96
16	192
8	384
4	768

8PSK modulation type

Spreading factor	Number of values
32	144

16QAM modulation type

Spreading factor	Number of values
32	192

With transmit diversity activated (see [\[SENSe<1|2>:\]CDPower:ANTenna](#) command), the values reduce to the half.

Example

0, 0, 1, 0, 1, 1, 0 ...

Remote Commands of the 1xEV-DO BTS Analyzer Option (K84)

This chapter describes the remote commands for the 1xEV-DO BTS Analyzer option (K84). The abbreviation EVDO stands for the operating mode of this option. For details on conventions used in this chapter refer to section "Notation" on page 6.2 at the beginning of this chapter.

For further information on analyzer or basic settings commands, refer to the corresponding subsystem in "Remote Commands of the Base Unit" on page 6.5.

This option is available from firmware version 1.91.

Subsystems of the 1xEV-DO BTS Analyzer option (K84)

- "CALCulate Subsystem (EVDO, K84)" on page 6.628
- "CONFigure Subsystem (EVDO, K84)" on page 6.637
- "DISPlay Subsystem (EVDO, K84)" on page 6.646
- "INSTrument Subsystem (EVDO, K84)" on page 6.648
- "SENSe Subsystem (EVDO, K84)" on page 6.649
- "TRACe Subsystem (1xEV-DO, K84)" on page 6.658

CALCulate Subsystem (EVDO, K84)

The CALCulate subsystem contains commands for converting instrument data, transforming and carrying out corrections. These functions are carried out subsequent to data acquisition, i.e. following the SENSE subsystem.

The following subsystems are included:

- ["CALCulate:FEED Subsystem \(EVDO, K84\)"](#) on page 6.629
- ["CALCulate:LIMit:ESpectrum Subsystem \(EVDO, K84\)"](#) on page 6.630
- ["CALCulate:LIMit:PVTime Subsystem \(EVDO, K84\)"](#) on page 6.632
- ["CALCulate:MARKer<1...4>:FUNction Subsystem \(EVDO, K84\)"](#) on page 6.634
- ["CALCulate:STATistics Subsystem \(EVDO, K84\)"](#) on page 6.636

CALCulate:FEED Subsystem (EVDO, K84)

The CALCulate:FEED subsystem selects the type of evaluation for the measurement data. This corresponds to the result display selection in manual operation.

Commands of the CALCulate:FEED Subsystem

– [CALCulate<1|2>:FEED](#)

CALCulate<1|2>:FEED

This command selects the result display for the measured data. The numeric suffix at CALCulate<1|2> specifies the measurement window.

Parameter

XPOW:CDP	Code Domain Power (CDP) result display (absolute)
XPOW:CDP:RAT	Code Domain Power (CDP) result display (relative)
XPOW:CDEP	Code Domain Error Power (CDEP) result display
XTIM:CDP:ERR:CTABLE	Channel Table result display
XTIM:CDP:PVChip	Power vs Chip result display
XTIM:CDP:ERR:SUMM	Result Summary result display
XTIM:CDP:MACCuracy	Composite EVM result display
XTIM:CDP:ERR:PCDomain	Peak Code Domain Error result display
XTIM:CDP:SYMB:CONST	Channel Constellation result display
XTIM:CDP:SYMB:EVM	Symbol Error Vector Magnitude result display
XTIM:CDP:BSTReam	Channel Bitstream result display
XTIM:CDP:COMP:CONST	Composite Constellation result display
XTIM:CDP:PVSymbol	Power versus Symbol result display

Example

```
CALC:FEED 'XTIM:CDP:MACC'
```

Selects the Composite EVM result display.

Characteristics

RST value: 'XPOW:CDP:RAT'

SCPI: device-specific

Mode

EVDO

CALCulate:LIMit:ESpectrum Subsystem (EVDO, K84)

The CALCulate:LIMit:ESpectrum subsystem defines the limit check for the Spectrum Emission Mask.

Commands of the CALCulate:LIMit:ESpectrum Subsystem

- CALCulate<1|2>:LIMit<1...8>:ESpectrum:MODE
- CALCulate<1|2>:LIMit<1...8>:ESpectrum:RESTore
- CALCulate<1|2>:LIMit<1...8>:ESpectrum:VALue

CALCulate<1|2>:LIMit<1...8>:ESpectrum:MODE

This command activates or deactivates the automatic selection of the limit line in the Spectrum Emission Mask measurement. The numeric suffix at CALCulate<1|2> specifies the measurement window. The numeric suffix at LIMit<1...8> is irrelevant for this command.

Parameter

- AUTO The limit line depends on the measured channel power.
- MANUAL One of the three specified limit lines is set. The selection is made with the
CALCulate<1|2>:LIMit<1...8>:ESpectrum:VALue command.

Example

```
CONF:CDP:MEAS ESP
Selects Spectrum Emission Mask measurement.
CALC:LIM:ESP:MODE AUTO
Activates automatic selection of the limit line.
```

Characteristics

RST value: AUTO
SCPI: device-specific

Mode

EVDO

CALCulate<1|2>:LIMit<1...8>:ESpectrum:RESTore

This command restores the predefined limit lines for the Spectrum Emission Mask measurement. All modifications made to the predefined limit lines are lost and the factory-set values are restored.

The numeric suffix at CALCulate<1|2> specifies the measurement window. The numeric suffix at LIMit<1...8> is irrelevant for this command.

This command is an event and therefore has no *RST value and no query.

Example

```
CALC:LIM:ESP:REST
Resets the limit lines for the Spectrum Emission Mask to the default setting.
```

Characteristics

RST value: -
SCPI: device-specific

Mode

EVDO

CALCulate<1|2>:LIMit<1...8>:ESPectrum:VALue

.This command selects one of the following predefined limit lines. As a prerequisite, the predefined limit lines must be activated using the CALCulate<1|2>:LIMit<1...8>:ESPectrum:MODE command. This commands supported for compatibility with the old FSL-K72. It is obsolete and only the CALCulate<1|2>:LIMit<1...8>:ESPectrum:MODE command should be used. The user can specify the exclusively used power class by using a value larger or equal to PMIN and smaller than the PMAX of that Power Class.

The numeric suffixes <1|2> and <1...8> are irrelevant for this command.

Parameter

-200dBm to 200dBm

Example

Power Class 1 -200 dBm P < 28 dBm

Power Class 2 28 dBm P < 33 dBm

Power Class 3 33 dBm P < 200 dBm

P stands for the expected power value.

```
CONF:CDP:MEAS ESP
```

Selects the spectrum emission mask measurement.

```
CALC:LIM:ESP:MODE MAN
```

Activates the selected predefined limit lines.

```
CALC:LIM:ESP:VAL 33
```

Selects the predefined limit line 33 dBm P < 200 dBm.(PowerClass3)

Characteristics

RST value: 0

SCPI: device-specific

Mode

EVDO

CALCulate:LIMit:PVTime Subsystem (EVDO, K84)

The CALCulate:LIMit:PVTime subsystem defines the limit check for power vs time measurement.

Commands of the CALCulate:LIMit:PVTime Subsystem

- CALCulate<1|2>:LIMit<1...8>:PVTime:REFerence
- CALCulate<1|2>:LIMit<1...8>:PVTime:RVALue
- CALCulate<1|2>:LIMit<1...8>:PVTime:RESTore

CALCulate<1|2>:LIMit<1...8>:PVTime:REFerence

This command sets the reference value. The standard asks for the sequence to first measure the FULL slot with the limit line relative to the mean power of the averaged time response. Therefore the parameter AUTO in a FULL slot measurement should be selected. In this mode the mean power is calculated and the limit lines are relative to that mean power value. This value should be used also as the reference for the IDLE slot measurement. With the parameter ONCE the current mean power value of the averaged time response is used to set as the fixedreference value for the limit lines. The mode is switched from AUTO to MANUAL. Now the IDLE slot can be selected and the measurement sequence can be finished.

The numeric suffixes <1|2> are irrelevant for this command.

Parameter

AUTO | ONCE | MANual

Example

```
CALC:LIM:PVT:REF AUTO
```

Automatic reference value for limit lines. The value should be set to mean power

```
CALC:LIM:PVT:REF MAN
```

Manual reference value for limit lines

```
CALC:LIM:PVT:RVA -33.5
```

Set manual reference value to -33.5

```
CALC:LIM:PVT:REF ONCE
```

Set reference value to mean power

```
CALC:LIM:PVT:RVA?
```

Query reference value for limit lines. The value should be set to mean power value

Characteristics

RST value: AUTO

SCPI: device-specific

Mode

EVDO

CALCulate<1|2>:LIMit<1...8>:PVTime:RVALue

This command sets the reference level in dBm for calculating the limit lines. Precondition is that the automatic mode of power calculation is switched off via the commands

CALCulate<1|2>:LIMit<1...8>:PVTime:REFerence ONCE or .

CALCulate<1|2>:LIMit<1...8>:PVTime:REFerence MAN.

The numeric suffixes <1|2> are irrelevant for this command.

Parameter

-200dBm to 200dBm

Example

```
CALC:LIM:PVT:REF MAN
```

Manual reference value for limit lines

```
CALC:LIM:PVTime:RVA -33.5
```

Set manual reference value to -33.5

Characteristics

RST value: -20dBm

SCPI: device-specific

Mode

EVDO

CALCulate<1|2>:LIMit<1...8>:PVTime:RESTore

This command restores the standard limit lines for the power versus time measurement. All changes made to the standard limit lines are lost and the state of these limit lines as they left the factory is restored.

The numeric suffixes <1|2> are irrelevant for this command.

Example

```
CALC:LIM:PVT:REST
```

Reset the PVT limit lines to their default setting

Characteristics

RST value: --

SCPI: device-specific

Mode

EVDO

CALCulate:MARKer<1...4>:FUNction Subsystem (EVDO, K84)

The CALCulate:MARKer:FUNction subsystem checks the marker functions in the instrument.

Commands of the CALCulate:MARKer<1...4>:FUNction Subsystem

– CALCulate<1|2>:MARKer<1...4>:FUNction:CDPower[:BTS]:RESult?

CALCulate<1|2>:MARKer<1...4>:FUNction:CDPower[:BTS]:RESult?

This command queries the measured and calculated values of the Code Domain Power analysis. The channel type can be set by means of the [SENSe<1|2>:]CDPower:CTYPE command, the slot number by means of the [SENSe<1|2>:]CDPower:SLOT command and the code number by means of the [SENSe<1|2>:]CDPower:CODE command.

The numeric suffix at CALCulate<1|2> specifies the measurement window. The numeric suffix at MARKer<1...4> is irrelevant for this command.

Parameter

CDPabsolute	channel power absolute in dBm
CDPRelative	channel power relative in dB
CERRor	chip rate error in ppm
CHANnel	channel number
DActive	number of active DATA channels
DMTYPe	modulation type of the DATA channel type (2=QPSK, 3=8-PSK, 4=16QAM)
EVMPeak	error vector magnitude peak in %
EVMRms	error vector magnitude rms in %
FERRor	frequency error in Hz
FERPpm	frequency error in ppm
IQIMbalance	I/Q imbalance in %
IQOFFset	I/Q offset in %
MACCuracy	composite EVM in %
MActive	Number of active MAC channels
MTYPE	modulation type of the channel type (0=BPSK-I, 1=BPSK-Q, 2=QPSK, 3=8-PSK, 4=16QAM, 5=2BPSK)
PCDerror	peak code domain error in dB
PDATa	absolute power in the DATA channel type
PLENGth	Length of preamble in chips
PMAC	absolute power in the MAC channel type
POFFset	phase offset in rad
PPILot	absolute power in the PILOT channel type
PPReamble	absolute power in the PREAMBLE channel type
PTOTal	total power

RHO	RHO value for the selected channel type/slot
RHOData	RHO over all slots for the DATA area
RHOMac	RHO over all slots for the MAC area
RHOPilot	RHO over all slots for the pilot area
RHO1	RHOoverall-1 over all slots over all chips with start of averaging at the half-slot limit
RHO2	RHOoverall-2 over all slots over all chips with start of averaging at the quarter-slot limit
SFACTOR	spreading factor of the channel
SRATE	symbol rate in ksps
TFRAME	trigger to frame in sec
TOFFSET	timing offset in s



The Trigger to Frame value (TFRAME) supplies a '9' if the trigger is at Free Run.
The Timing/Phase Offset values (TOFFSET/POFFSET) supply a '9' if timing and phase measurement is disabled (refer to CDP:TPM) or the number of active channels is higher than 50.

Example

CALC:MARK:FUNC:CDP:RES? CDP
Reads out total power.

Characteristics

RST value: -
SCPI: device-specific

Mode

EVDO

CALCulate:STATistics Subsystem (EVDO, K84)

The CALCulate:STATistics subsystem controls the statistical measurement functions. The measurement window cannot be selected for these measurement functions. No numeric suffix at CALCulate is available.

Commands of the CALCulate:STATistics Subsystem

- [CALCulate:STATistics:CCDF\[:STATe\]](#)
- [CALCulate:STATistics:NSAMples](#)
- [CALCulate:STATistics:RESult<1...4>?](#)
- [CALCulate:STATistics:SCALE:Y:LOWer](#)
- [CALCulate:STATistics:SCALE:Y:UPPer](#)

CALCulate:STATistics:CCDF[:STATe]

For details refer to the "[CALCulate:STATistics:CCDF\[:STATe\]](#)" command of the base unit on page 6.110.

CALCulate:STATistics:NSAMples

For details refer to the "[CALCulate:STATistics:NSAMples](#)" command of the base unit on page 6.111.

CALCulate:STATistics:RESult<1...4>?

For details refer to the "[CALCulate:STATistics:RESult<1...6>?](#)" command of the base unit on page 6.111.

CALCulate:STATistics:SCALE:Y:LOWer

For details refer to the "[CALCulate:STATistics:SCALE:Y:LOWer](#)" command of the base unit on page 6.113.

CALCulate:STATistics:SCALE:Y:UPPer

For details refer to the "[CALCulate:STATistics:SCALE:Y:UPPer](#)" command of the base unit on page 6.114.

CONFigure Subsystem (EVDO, K84)

The CONFigure subsystem contains commands for configuring the measurements.

The following subsystem is included:

- ["CONFigure:CDPower Subsystem \(EVDO, K84\)"](#) on page 6.637

CONFigure:CDPower Subsystem (EVDO, K84)

This subsystem contains the commands for measurement selection and configuration of the 1XEV-DO BTS Analyzer option.

Further setting commands for the spectrum emission mask measurement are in the ["CALCulate:LIMit:ESpectrum Subsystem \(EVDO, K84\)"](#) on page 6.630.

Commands of the CONFigure:CDPower Subsystem

- [CONFigure:CDPower\[:BTS\]:CTABLE\[:STATe\]](#)
- [CONFigure:CDPower\[:BTS\]:CTABLE:CATalog?](#)
- [CONFigure:CDPower\[:BTS\]:CTABLE:COMMent](#)
- [CONFigure:CDPower\[:BTS\]:CTABLE:COpy](#)
- [CONFigure:CDPower\[:BTS\]:CTABLE:DATA](#)
- [CONFigure:CDPower\[:BTS\]:CTABLE:DELeTe](#)
- [CONFigure:CDPower\[:BTS\]:CTABLE:NAME](#)
- [CONFigure:CDPower\[:BTS\]:CTABLE:REStore](#)
- [CONFigure:CDPower\[:BTS\]:CTABLE:SELeCt](#)
- [CONFigure:CDPower\[:BTS\]:BCLass](#)
- [CONFigure:CDPower\[:BTS\]:MCARier\[:STATe\]](#)
- [CONFigure:CDPower\[:BTS\]:MEASurement](#)
- [CONFigure:CDPower\[:BTS\]:PVTime:BURSt](#)
- [CONFigure:CDPower\[:BTS\]:PVTime:FREStart](#)
- [CONFigure:CDPower\[:BTS\]:PVTime:LIST\[:STATe\]](#)
- [CONFigure:CDPower\[:BTS\]:PVTime:LIST:RESult?](#)
- [CONFigure:CDPower\[:BTS\]:REVision](#)
- [CONFigure:CDPower\[:BTS\]:RFSLot](#)

CONFigure:CDPower[:BTS]:CTABLE[:STATe]

This command activates or deactivates the 'RECENT' channel table. To select another channel table, use the [CONFigure:CDPower\[:BTS\]:CTABLE:SELeCt](#) command.

Parameter

ON | OFF

Example

```
CONF:CDP:CTAB ON
```

Activates predefined channel table.

Characteristics

RST value: OFF

SCPI: device-specific

Mode

EVDO

CONFigure:CDPower[:BTS]:CTABLE:CATalog?

This command queries the names of all the channel tables stored on the flash disk for 1xEV-DO.

Return values

<sum of file sizes of all subsequent files>, <spare storage space on hard disk>, <1st file name>, <1st file size>, <2nd file name>, <2nd file size>, ..., <nth file name>, <nth file size>, ...

Example

CONF:CDP:CTAB:CAT?

Queries catalog.

Characteristics

RST value: -

SCPI: device-specific

Mode

EVDO

CONFigure:CDPower[:BTS]:CTABLE:COMMent

This command defines a comment on the selected channel table.

Parameter

<'string'> = comment on the channel table

Example

CONF:CDP:CTAB:NAME 'NEW_TAB'

Selects channel table for editing. If a channel table with this name does not exist, a new channel table is created.

CONF:CDP:CTAB:COMM 'Comment for NEW_TAB'

Specifies 'Comment for NEW_TAB' as comment.

Characteristics

RST value: -

SCPI: device-specific

Mode

EVDO

CONFigure:CDPower[:BTS]:CTABLE:COPIY

This command copies one channel table to another. Select the channel table you want to copy using the [CONFigure:CDPower\[:BTS\]:CTABLE:NAME](#) command.

This command is an event and therefore has no *RST value and no query.

Parameter

<'string'> = name of the new channel table.

Example

```
CONF:CDP:CTAB:NAME 'CTAB_1'
Selects channel table CTAB_1 for copying.
CONF:CDP:CTAB:COPY 'CTAB_2'
Copies CTAB_1 to C_TAB2.
```

Characteristics

RST value: -

SCPI: device-specific

Mode

EVDO

CONFigure:CDPower[:BTS]:CTABLE:DATA

This command defines a channel table.

Parameter

For one table line, eight values are specified .

<channel type>, <code class>, <code number>, <radio configuration>, <reserved1>, <reserved2>, <status>, <CDP relative>,

Channel Type	The channel type is numerically coded as follows: 0 = PILOT 1 = MAC 2 = PREAMBLE with 64 chip length 3 = PREAMBLE with 128 chip length 4 = PREAMBLE with 256 chip length 5 = PREAMBLE with 512 chip length 6 = PREAMBLE with 1024 chip length 7 = DATA
Code Class	Depending on channel type, fixed: PILOT: 5, MAC: 6, PREAMBLE: 5 and DATA: 4 (spreading factor = 2 ^{code class})
Code number	0...spreading factor-1
Modulation	Modulation type including mapping: 0 = BPSK-I 1 = BPSK-Q 2 = QPSK 3 = 8-PSK 4 = 16-QAM Modulation types QPSK/8-PSK/16-QAM have complex values.
Reserved 1	Always 0 (reserved)
Reserved 2	Always 0 (reserved)
Status	0: inactive, 1:active Can be used in a setting command to disable a channel temporarily
CDP relative	Power value in dB.

Before using this command, you must set the name of the channel table using the `CONFigure:CDPower[:BTS]:CTable:NAME` command.

Example

`INST:SEL BC2K`

Activates the 1XEV-DO BTS Analyzer option.

`CONF:CDP:CTAB:NAME 'NEW_TAB'`

Selects channel table for editing. If a channel table with this name does not exist, a new channel table is created.

`CONF:CDP:CTAB:DATA 0,6,0,0,0,0,1,0.0,10,5,3,4,0,0,1,0.0`

Defines a table with the following channels: PICH 0.64 and data channel with RC4/Walsh code 3.32.

Characteristics

RST value: -

SCPI: device-specific

Mode

EVDO

CONFigure:CDPower[:BTS]:CTable:DELeTe

This command deletes the selected channel table. Select the channel table you want to delete using the `CONFigure:CDPower[:BTS]:CTable:NAME` command.

This command is an event and therefore has no *RST value and no query.

Example

`CONF:CDP:CTAB:NAME 'CTAB_2'`

Selects channel table `CTAB_2` for deleting.

`CONF:CDP:CTAB:DEL`

Deletes channel table `CTAB_2`.

Characteristics

RST value: -

SCPI: device-specific

Mode

EVDO

CONFigure:CDPower[:BTS]:CTable:NAME

This command selects a channel table for editing or creating. To select a command for analysis, use the `CONFigure:CDPower[:BTS]:CTable:SELeCt` command.

Parameter

<'string'> = name of the channel table

Example

`CONF:CDP:CTAB:NAME 'NEW_TAB'`

Selects channel table for editing. If a channel table with this name does not exist, a new channel table is created.

Characteristics

RST value: -

SCPI: device-specific

Mode
EVDO

CONFigure:CDPower[:BTS]:CTABLE:RESTore

This command restores the predefined channel tables to their factory-set values. In this way, you can undo unintentional overwriting.

This command is an event and therefore has no *RST value and no query.

Example

```
INST:SEL BC2K
```

Activates the 1XEV-DO BTS Analyzer option.

```
CONF:CDP:CTAB:REST
```

Restores the channel table.

Characteristics

RST value: -

SCPI: device-specific

Mode
EVDO

CONFigure:CDPower[:BTS]:CTABLE:SElect

This command selects a predefined channel table.

Parameter

<'string'> = name of the channel table

Example

Refer to the example of the [CONFigure:CDPower\[:BTS\]:MCArier\[:STATe\]](#) command.

Characteristics

RST value: "RECENT"

SCPI: device-specific

Mode
EVDO

CONFigure:CDPower[:BTS]:BClass

This command selects the band class to be used.

Parameter

0	800 MHz band
1	1900 MHz band
2	TACS band
3	JTACS band
4	Korean PCS band
5	450 MHz band
6	2 GHz band

- 7 700 MHz band
- 8 1800 MHz band
- 9 900 MHz band
- 10 Secondary 800 MHz band
- 11 400 MHz European PAMR band
- 12 800 MHz PAMR band
- 14 US PCS 1.9GHz Band
- 15 AWS Band

Example

CONF:CDP:BCL 1
 Selects band class 1, 1900 MHz

Characteristics

RST value: 0
 SCPI: device specific

Mode

EVDO

CONFigure:CDPower[:BTS]:MCARier[:STATE]

This command activates or deactivates the settings that improve the processing of multi-carrier signals.

Parameter

ON | OFF

Example

CONF:CDP:MCAR ON
 Activates the multi-carrier settings.

Characteristics

RST value: OFF
 SCPI: device-specific

Mode

EVDO

CONFigure:CDPower[:BTS]:MEASurement

This command selects the measurements of the 1XEV-DO BTS Analyzer option. The predefined settings of the different measurements are described in chapter 4, section "Softkeys of the measurement menu (1XEV-DO BTS Analyzer mode)".

Parameter

- ACLR adjacent-channel power measurement
- CCDF measurement of complementary cumulative distribution
- CDPower code domain power measurement
- ESpectrum measurement of spectrum emission mask

OBWidth	measurement of the occupied bandwidth
POWER	channel power measurement
PVTime	Measurement of power versus time

Example

```
CONF:CDP:MEAS POW
Selects Signal Channel Power measurement .
```

Characteristics

RST value: CDPower
 SCPI: device-specific

Mode

EVDO

CONFigure:CDPower[:BTS]:PVTime:BURSt

This command activates an automatic burst alignment to the center of the diagram.

Parameter

ON | OFF

Example

```
CONF:CDP:PVT:BURS ON
Activates the automatic alignment
```

Characteristics

RST value: OFF
 SCPI: device-specific

Mode

EVDO

CONFigure:CDPower[:BTS]:PVTime:FREStart

If switched on, this command evaluates the limit line over all results at the end of a single sweep. The sweep is restarted if this result is FAILED.

Parameter

ON | OFF

Example

```
CONF:CDP:PVT:FRES ON
Restarts a single sweep if the result evaluation is failed.
```

Characteristics

RST value: OFF
 SCPI: device-specific

Mode

EVDO

CONFigure:CDPower[:BTS]:PVTime:LIST[:STATe]

With this command the list evaluation which is off by default for backwards compatibility reasons can be turned on.

Parameter

ON | OFF

Example

CONF:CDP:PVT:LIST[:STATe] ON

Characteristics

RST value: OFF

SCPI: device-specific

Mode

EVDO

CONFigure:CDPower[:BTS]:PVTime:LIST:RESult?

With this command the list evaluation results are queried in a defined order.

Example

CONF:CDP:PVT:LIST:RES

Characteristics

RST value: -

SCPI: device-specific

Mode

EVDO

CONFigure:CDPower[:BTS]:REVision

With this command whether a revision 0 (subtype 0/1) signal or a revision A (subtype 2) signal is analyzed.

Parameter

0 | A

Example

CONF:CDP:REV 0

Revision 0 signal is analyzed

Characteristics

RST value: 0

SCPI: device-specific

Mode

EVDO

CONFigure:CDPower[:BTS]:RFSLot

This command defines the expected signal: FULL slot or IDLE slot. Accordingly the limit lines and the borders for calculating the mean power are set. The lower and upper limit line are called `DOPVTFL/DOPVTFU` for FULL and `DOPVTIL/DOPVTIU` for IDLE mode. It is possible to change these lines with the standard limit line editor.

Parameter

FULL | IDLE

Example

```
CONF:CDP:RFSL FULL
```

Use limit line for FILL slot and connect FILL slot signal

Characteristics

RST value: FULL

SCPI: device-specific

ModeEVDO

DISPlay Subsystem (EVDO, K84)

The DISPlay subsystem controls the selection and presentation of textual and graphic information as well as of measurement data on the display.

Commands of the DISPlay Subsystem

- DISPlay:FORMat
- DISPlay[:WINDow<1|2>]:SSElect
- DISPlay[:WINDow<1|2>]:TRACe<1...6>:Y[:SCALe]:AUTO
- DISPlay[:WINDow<1|2>]:TRACe<1...6>:Y[:SCALe]:MAXimum
- DISPlay[:WINDow<1|2>]:TRACe<1...6>:Y[:SCALe]:MINimum

DISPlay:FORMat

This command sets the visible screen display type to full or split screen.

Parameter

SPLit | SINGle

Example

```
DISP:FORM SINGle
Sets the display to full screen.
```

Characteristics

*RST value: SPL
SCPI: device-specific

Mode

EVDO

DISPlay[:WINDow<1|2>]:SSElect

This command selects whether screen A or screen B is active. SSElect means Screen SElect.

Example

```
DISP:WIND1:SSEL
Sets the screen A active.
```

Characteristics

*RST value: 1
SCPI: device-specific

Mode

EVDO

DISPlay[:WINDow<1|2>]:TRACe<1...6>:Y[:SCALe]:AUTO

This command switches on or off automatic scaling of the Y-axis for the specified trace display. Automatic scaling sets the Y-axis to automatically scale to best fit the measurement results.

The numeric suffix at WINDow<1|2> selects the measurement window. The numeric suffix at TRACe<1...6> must be 1.

Parameter

ONCE

Example

DISP:WIND2:TRAC1:Y:SCAL:AUTO ONCE

activates automatic scaling of the Y-axis for the active trace

Characteristics

*RST value: OFF

ModeEVDO

DISPlay[:WINDow<1|2>]:TRACe<1...6>:Y[:SCALe]:MAXimum

This command defines the maximum value of the y-axis for the selected result display.

Parameter

<numeric value>

The unit and range depend on the result display.

Example

DISP:TRAC:Y:MIN -60

DISP:TRAC:Y:MAX 0

Defines the y-axis with a minimum value of -60 and maximum value of 0.

Characteristics

*RST value: depends on the result display

SCPI: device-specific

ModeEVDO

DISPlay[:WINDow<1|2>]:TRACe<1...6>:Y[:SCALe]:MINimum

This command defines the minimum value of the y-axis for the selected result display.

Parameter

<numeric value>

The unit and range depend on the result display.

Example

DISP:TRAC:Y:MIN -60

DISP:TRAC:Y:MAX 0

Defines the y-axis with a minimum value of -60 and maximum value of 0.

Characteristics

*RST value: depends on the result display

SCPI: device-specific

ModeEVDO

INSTrument Subsystem (EVDO, K84)

The INSTrument subsystem selects the operating mode of the unit either via text parameters or fixed numbers.

Commands of the INSTrument Subsystem

- [INSTrument\[:SElect\]](#)
- [INSTrument:NSElect](#)

INSTrument[:SElect]

Parameter

BC2K (1XEVD-DO BTS Analyzer option, R&S FSL-K84)

For further details refer to the INSTrument subsystem of the base unit.

INSTrument:NSElect

Parameter

10 (1XEVD-DO BTS Analyzer option, R&S FSL-K84)

For further details refer to the INSTrument subsystem of the base unit.

SENSe Subsystem (EVDO, K84)

The SENSe subsystem controls the essential parameters of the analyzer. In accordance with the SCPI standard, the keyword "SENSe" is optional for this reason, which means that it is not necessary to include the SENSe node in command sequences.

The following subsystems are included:

- "SENSe:CDPower Subsystem (EVDO, K84)" on page 6.649
- "SENSe:SWEep Subsystem (EVDO, K84)" on page 6.657

SENSe:CDPower Subsystem (EVDO, K84)

This subsystem sets the parameters for the code domain measurements mode.

Commands of the SENSe:CDPower Subsystem

- [SENSe<1|2>:]CDPower:AVERage
- [SENSe<1|2>:]CDPower:CODE
- [SENSe<1|2>:]CDPower:ICTReshold
- [SENSe<1|2>:]CDPower:IQLength
- [SENSe<1|2>:]CDPower:CTYPe
- [SENSe<1|2>:]CDPower:ICTReshold
- [SENSe<1|2>:]CDPower:IQLength
- [SENSe<1|2>:]CDPower:LEVel:ADJust
- [SENSe<1|2>:]CDPower:MAPPing
- [SENSe<1|2>:]CDPower:MMODE
- [SENSe<1|2>:]CDPower:NORMalize
- [SENSe<1|2>:]CDPower:OVERview
- [SENSe<1|2>:]CDPower:PNOFset
- [SENSe<1|2>:]CDPower:QINVert
- [SENSe<1|2>:]CDPower:SBANd
- [SENSe<1|2>:]CDPower:SLOT
- [SENSe<1|2>:]CDPower:TPMeas

[SENSe<1|2>:]CDPower:AVERage

This command can be precisely enabled by means of ON when the Code Domain Power analysis is active (refer to CALCulate<1|2>:FEED). If averaging is active, the CDP is calculated over all slots and displayed as called for by the 1xEV-DO Standard.

Parameter

ON | OFF

Example

CDP:AVER ON

Activate averaging CDP relative over all slots and display on screen A.

Characteristics

RST value: 0

SCPI: device-specific

Mode

EVDO

[SENSe<1|2>:]CDPower:CODE

This command selects the code number. The maximum number depends on the channel type

The numeric suffix at SENSe<1|2> is irrelevant for this command.

Parameter

Channel Type	Spreading factor	Code number
PILOT	32	0...31
MAC	REV 0 64	0...63
	REV A 128	0...127
PREAMBLE	REV 0 32	0...31
	REV A 64	0...63
DATA	64	0...31

Example

CDP:CODE 11

Selects code number 11.

Characteristics

RST value: 0

SCPI: device-specific

Mode

EVDO

[SENSe<1|2>:]CDPower:ICTReshold

This command defines the minimum power which a single channel must have compared to the total signal in order to be regarded as an active channel. Channels below the specified threshold are regarded as "inactive".

The numeric suffix at SENSe<1|2> is irrelevant for this command.

Parameter

-100 dB to 0 dB

Example

CDP:ICTR -10DB

Sets threshold value to -10 dB.

Characteristics

RST value: -40 dB

SCPI: device-specific

Mode

EVDO

[SENSe<1|2>:]CDPower:IQLength

This command sets the capture length in multiples of the power control group.
The numeric suffix at SENSe<1|2> is irrelevant for this command.

Parameter

2 to 12

Example

CDP:IQL 8
Sets 8 PCGs as capture length.

Characteristics

RST value: 3
SCPI: device-specific

Mode

EVDO

[SENSe<1|2>:]CDPower:CTYPe

This command is used to select the channel type. The number of results then changes in most analyses, such as code domain power, symbol EVM, and bit stream, because either a different spreading factor or a different number of symbols is available for the analysis.

Parameter

PILOT | MAC | PREamble | DATA

Example

CDP:CTYP MAC
Select MAC channel type.

Characteristics

RST value: PILOT
SCPI: device-specific

Mode

EVDO

[SENSe<1|2>:]CDPower:ICTReshold

This command defines the minimum power which a single channel must have compared to the total signal in order to be regarded as an active channel. Channels below the specified threshold are regarded as "inactive".

The numeric suffix at SENSe<1|2> is irrelevant for this command.

Parameter

-100 dB to 10 dB

Example

CDP:ICTR -10
Sets the minimum power threshold to -10 dB.

Characteristics

RST value: -40 dB

SCPI: device-specific

ModeEVDO

[SENSe<1|2>:]CDPower:IQLength

This command sets the capture length in multiples of the slot.

The numeric suffix at SENSe<1|2> is irrelevant for this command.

Parameter

2 to 12

Example

CDP:IQL 10

Sets the capture length to 10.

Characteristics

RST value: 3

SCPI: device-specific

ModeEVDO

[SENSe<1|2>:]CDPower:LEVel:ADJust

This command adjusts the reference level of the R&S FSL to the measured channel power. This ensures that the settings of the RF attenuation and the reference level are optimally adjusted to the signal level without overloading the R&S FSL or limiting the dynamic response by a too low signal-to-noise ratio. The numeric suffix at SENSe<1|2> is irrelevant for this command.

This command is an event and therefore has no *RST value and no query.

Example

CDP:LEV:ADJ

Adjusts the reference level to the measured channel power.

Characteristics

RST value: -

SCPI: device-specific

ModeEVDO

[SENSe<1|2>:]CDPower:MAPPING

This command selects, when the mapping mode is not Complex, whether the I or Q branch should be analyzed.

Parameter

I | Q

Example

```
CDP:MAPP Q
```

Selects the Q branch.

Characteristics

RST value: I

SCPI: device-specific

Mode

EVDO

[SENSe<1|2>]:CDPower:MMODE

This command defines the mapping mode. With AUTO, internal working takes place in "Complex" mapping mode for the DATA channel type and "I or Q" for the PILOT, MAC and PREAMBLE channel types. With this command, each mapping mode can be determined personally for all channel types, or it is possible to return to AUTO.

Parameter

AUTO | IOQ | COMPLEX

Example

```
CDP:MMODE COMP
```

The pilot channel type is analyzed complex

Characteristics

RST value: AUTO

SCPI: device-specific

Mode

EVDO

[SENSe<1|2>]:CDPower:NORMALize

This command activates or deactivates the elimination of the IQ offset from the signal. The numeric suffix at SENSe<1|2> is irrelevant for this command.

Parameter

ON | OFF

Example

```
CDPower:NORMALize ON
```

Activates the elimination of the I/Q offset.

Characteristics

RST value: OFF

SCPI: device-specific

Mode

EVDO

[SENSe<1|2>:]CDPower:OVERview

This command can be enabled can be precisely enabled by means of ON when either the Code Domain Power or the Code Domain Error Power analysis is active (refer to CALCulate<1|2>:FEED). In Overview mode, the I branch of the signal is normally displayed on screen A and the Q branch of the signal on screen B with the CDP/CDEP. The branches can be read out separately by means of TRAC:DATA? TRACE1 and TRAC:DATA? TRACE2. The previous analyses become active again when you exit Overview mode.

If an analysis other than Code Domain Power or Code Domain Error Power is selected when Overview mode is active, you exit Overview mode and the previous analysis is reset on the other screen.

Parameter

ON | OFF

Example

```
CDP:OVER ON
```

Activate Overview mode.

CDP Relative on screen A I branch.CDP Relative on screen B Q branch

Characteristics

RST value: OFF

SCPI: device-specific

Mode

EVDO

[SENSe<1|2>:]CDPower:PNOffset

This command sets the PN offset of the base station in multiples of 64 chips.

The numeric suffix at SENSe<1|2> is irrelevant for this command.

Parameter

0 to 511

Example

```
INST:SEL BC2K
```

Activates the 1XEV-DO BTS Analyzer option.

```
INIT:CONT OFF
```

Selects single sweep.

```
CDP:PNOF 45
```

Sets PN offset.

```
INIT;*WAI
```

Starts measurement with synchronization.

Characteristics

RST value: 0

SCPI: device-specific

Mode

EVDO

[SENSe<1|2>:]CDPower:QINVert

This command inverts the sign of the Q-component of the signal.
The numeric suffix at SENSe<1|2> is irrelevant for this command.

Parameter

ON | OFF

Example

```
INST:SEL BC2K
```

Activates the 1XEV-DO BTS Analyzer option.

```
INIT:CONT OFF
```

Selects single sweep.

```
CDP:QINV ON
```

Activates the inversion of the Q-component sign.

```
INIT;*WAI
```

Starts measurement with synchronization.

Characteristics

RST value: OFF

SCPI: device-specific

Mode

EVDO

[SENSe<1|2>:]CDPower:SBANd

This command is used to swap the left and right sideband.

Parameter

NORMal | INVers

Example

```
CDP:SBAN INV
```

Swap sidebands.

Characteristics

RST value: NORMAL

SCPI: device-specific

Mode

EVDO

[SENSe<1|2>:]CDPower:SLOT

This command selects the slot that is evaluated in the Code Domain Power Diagram and is used for slot-based evaluations in the Code Domain Result Summary.

The numeric suffix at SENSe<1|2> is irrelevant for this command.

Parameter

0 to (capture length-1)

The capture length is defined via the [\[SENSe<1|2>:\]CDPower:IQLength](#) command.

Example

```
CDP:SLOT 2
```

Selects power control group 2.

Characteristics

RST value: 0

SCPI: device-specific

Mode

EVDO

[SENSe<1|2>]:CDPower:TPMeas

This command activates or deactivates the timing and phase offset evaluation of the channels to the pilot. If the value is OFF or if more than 50 channels are active, the command `TRACe?` and `CALCulate<1|2>:MARKer<1...4>:FUNCTION:CDPower[:BTS]:RESult?` returns a value of '9' for the timing and phase offset as the result. If the value is ON, the timing and phase offsets are calculated and returned.

The numeric suffix at `SENSe<1|2>` is irrelevant for this command.

The results are queried using the `TRACe<1|2>[:DATA]` command and the `CALCulate<1|2>:MARKer<1...4>:FUNCTION:CDPower[:BTS]:RESult?` command.

Parameter

ON | OFF

Example

```
CDP:TPM ON
```

Activate timing and phase offset.

Characteristics

RST value: OFF

SCPI: device-specific

Mode

EVDO

SENSe:SWEep Subsystem (EVDO, K84)

The SENSe:SWEep subsystem controls the sweep parameters. For further commands of this subsystem refer to the SENSe:SWEep subsystem of the base unit.

Commands of the SENSe:SWEep subsystem

– [SENSe<1...4>:]SWEep:COUNT

[SENSe<1...4>:]SWEep:COUNT

This command defines the number of sweeps started with single sweep, which are used for calculating the average or maximum value. If the values 0 or 1 are set, one sweep is performed. For Power vs Time measurements, the command sets the number of half slots to be analyzed.

The suffix <1...4> is irrelevant.

Parameters

0 to 32767

Example

```
SWE:COUN 64
```

Sets the number of half slots to be measured to 64.

Characteristics

*RST value: 100

SCPI: conform

Mode

EVDO

TRACe Subsystem (1xEV-DO, K84)

The TRACe subsystem controls access to the instruments internal trace memory.

Commands of the TRACe Subsystem

- TRACe<1|2>[:DATA]? LIST
- TRACe<1|2>[:DATA]

Further information

- Characteristics of the 1xEV-DO channel types

Characteristics of the 1xEV-DO channel types

The following table shows the characteristics of the channel types in the 1xEV-DO standard.

Channel Type	Spreading Factor		Symbol Rate	Modulation Type	Chips per Slot	Symbols per Slot and Code	Bits per Slot and Code		
							Mapping I or Q	Mapping Complex	
PILOT	32		38.4 ksps	BPSK-I or BPSK-Q	96*2=192	6	6	12	
MAC	Rev. 0	64	19.2 ksps	BPSK-I or BPSK-Q	64*4=256	4	4	8	
	Rev. A	128	9.6 ksps				2	4	
PREAMBLE	Rev. 0	32	38.4 ksps	BPSK-I or BPSK-Q	Preamble length	2	2	4	
							4	8	
					256:	8	8	16	
					512:	16	16	32	
					1024:	32	32	64	
	Rev. A	64	19.2 ksps	BPSK-I or BPSK-Q	64:	1	1	2	
							2	4	
					128:	2	4	8	
					256:	4	4	8	
					512:	8	8	16	
					1024:	16	16	32	
DATA	16		76.8 ksps	QPSK, 8-PSK, 16QAM	400*4 -PreambleChips =DataNettoChips		Mapping always Complex Modulation Type		
							QPSK	8-PSK	16QAM
					1600-0 = 1600	100	200	300	400
					1600-64 = 1536	96	192	288	384
					1600-128 = 1472	92	184	276	368
					1600-256 = 1344	84	168	252	336
					1600-512 = 1088	68	136	204	272
					1600-1024=576	36	72	104	144

TRACe<1|2>[:DATA]? LIST

This command returns the peak list. For each peak the following entries are given:

<freq1>, <level1>, <delta level 1>, <freq2>, <level2>, <delta level 2>, ... <freq n>, <level n>, <delta level n>

Parameter

LIST

Example

```
TRAC1:DATA? LIST
```

Peak list consist of Frequency of the peak, absolute level of the peak and distance to the limit line

Characteristics

RST value: -

SCPI: device-specific

Mode

EVDO

TRACe<1|2>[:DATA]

The numeric suffixes <1|2> are irrelevant for this command except TRAC2? TRACe1 command in this case the numeric suffix <2> is screen B.

Parameter for code domain power measurements

TRACE1 | TRACE2 Reads out the trace data of measurement window 1 or 2.

CTABLE For the Channel Table result display, reads out the maximum values of the timing/phase offset between every assigned channel and the pilot channel (see also [[SENSe<1|2>: \]CDPower:TPMeas](#) command).

Return values

The return values for each measurement are listed below:

- [Code Domain Power](#)
- [General Results / Channel Results](#)
- [Power vs Chip](#)
- [Power vs Symbol](#)
- [Composite EVM](#)
- [Channel Table](#)
- [Bitstream](#)
- [Peak Code Domain Error](#)
- [Code Domain Error](#)
- [Symbol Constellation](#)
- [EVM vs Symbol](#)
- [Composite Constellation](#)
- [Return values for parameter CTABLE](#)

Characteristics

RST value: -

SCPI: device-specific

Mode

EVDO

Code Domain Power

The command returns three values for every code in a channel in the following order:

<code number>, <absolute level | relative level >, < power ID>, ...

Return values

Value	Description	Range	Unit
<code number>	code number of the channel	{0...spreading factor-1}	
<absolute level>	Absolute level of the code channel at the selected channel slot	{-∞ ... ∞ }	dBm
<relative level>	relative level of the channel referenced to total power in the channel type	{-∞ ... ∞ }	dB
<power ID>	Power indication 0 - inactive channel, 1 - active channel	{0,1}	

The number of codes that are displayed corresponds to the spreading factor. The spreading factor in turn depends on the selected channel types. Therefore, 32 value triplets are returned for PILOT and PREAMBLE channels, 16 value triplets for DATA channels and 64 value triplets for MAC channels (see [Characteristics of the 1xEV-DO channel types](#) on page 6.658).

In addition, the output depends on the mapping settings. The output is either the I branch, the Q branch or the complex signal. If Code Domain Overview is activated, trace 1 shows the I branch and trace 2 shows the Q branch by default.

General Results / Channel Results

The command returns 30 values selected channel in the following order::

<FERRor>, <FERPpm>, <CERRor>, <TFRame>, <RHOPilot>, <RHO1>, <RHO2>, <PPILot>, <PMAC>, <PDATa>, <PPReamble>, <MACCuracy>, <DMTYpe>, <MACTive>, <DACTive>, <PLENGth>, <RHO>, <PCDerror>, <IQIMbalance>, <IQOOffset>, <SRATE>, <CHANnel>, <SFACtor>, <TOFFset>, <POFFset>, <CDPRelative>, <CDPabsolute>, <EVMRms>, <EVMPeak>, <MTYPE>

Return values

Value	Description	Range	Unit
<FERRor>	Frequency error in Hz		Hz
<FERPpm>	Frequency error in ppm		ppm
<CERRor>	Chip rate error in ppm		ppm
<TFRame>	Trigger to frame Note: The Trigger to Frame value (TFRame) supplies a '9' if the trigger is at FREE RUN. The Timing/Phase Offset values (TOFFset/POFFset) supply a '9' if timing and phase measurement is disabled (refer to CDP:TPM) or the number of active channels is higher than 50		
<RHOPilot>	RHO over all slots for the pilot area		
<RHO1>	RHOoverall-1 over all slots over all chips with start of averaging at the half-slot limit		
<RHO2>	RHOoverall-2 over all slots over all chips with start of averaging at the quarter-slot limit		
<PPILot>	Absolute power in the PILOT channel type		dBm
<PMAC>	Absolute power in the MAC channel type		dBm
<PDATa>	Absolute power in the DATA channel type		dBm

Value	Description	Range	Unit
<PPReamble>	Absolute power in the PREAMBLE channel type		dBm
<MACCuracy>	Composit EVM in %		%
<DMTYpe>	Modulation type in the DATA channel type: 2 = QPSK, 3 = 8-PSK, 4 = 16-QAM MACTive Number of active		
<MACTive>	Number of active MAC channels		
<DACTive>	Number of active DATA channels		
<PLENGth>	Length of preamble in chips		
<RHO>	RHO value for the selected channel type/slot		
<PCDerror>	Peak Code Domain error in dB		dB
<IQIMbalance>	IQ imbalance in %		%
<IQOffset>	IQ offset in %		%
<SRATE>	Symbol rate in ksps		ksps
<CHANnel>	Channel number		
<SFACtor>	Spreading factor of the channel		
<TOFFset>	If the evaluation of the timing and phase offset is not active(refer to CDPower:TPMeas) or more than 50 active channels are in the signal, the value 9 is returned. For inactive channels, the value 9 is returned.		s
<POFFset>	If the evaluation of the timing and phase offset is not active (refer to CDPower:TPMeas) or more than 50 active channels are in the signal, the value 9 is returned. For inactive channels, the value 9 is returned.		
<CDPRelative>	relative level of the channel referenced to total power in the channel type	{-∞ ... ∞ }	dB
<CDPAbsolute>	absolute level of the code channel at the selected channel slot	{-∞ ... ∞ }	dBm
<EVMRms>	Error vector magnitude rms in %		%
<EVMPeak>	Error vector magnitude peak in %		%
<MTYPE>	Modulation type: 0 = BPSK-I, 1 = BPSK-Q, 2 = QPSK, 3 = 8-PSK, 4 = 16-QAM, 5 = 2BPSK (if complex analysis selected for PILOT, PREAMBLE or MAC)		

Power vs Chip

The command returns one value for every chip in the following order:

<level value in dBm>, <level value in dBm>, ...

The number of results that are displayed is always 2048, one power level for every chip.

Power vs Symbol

The command returns one value for every symbol in the following order:

<value in dBm symbol 0>, <value in dBm symbol 1>, ...

The number of results that are displayed depends on the number of symbols and is between 2 and 100.

Composite EVM

The command returns two values for every slot in the following order:

<Slot number>, <value in %>, <Slot number>, <value in %>, ...

The number of pairs of variates that is displayed corresponds to the IQ capture length. Therefore the number of results is between 2 and 12.

Channel Table

The command returns 8 values for all active channels in the following order:

<channel type>, <code class>, <code number>, <modulation>, <absolute level>, <relative level>, <timing offset>, <phase offset>, ...

The channels are listed in the following channel type order: PILOT, MAC, PREAMBLE, DATA. Within the channel types, the channels are sorted in ascending code number order.

Return values

Value	Description	Range	Unit
<channel type>	channel type indication The channel type is coded with numbers as follows: 0 = PILOT, 1 = MAC, 2 = PREAMBLE with 64chip, 3 = PREAMBLE with 128chip, 4 = PREAMBLE with 256chip, 5 = PREAMBLE with 512chip, 6 = PREAMBLE with 1024chip, 7 = DATA	{0 ... 7}	<channel type>
<code class>	code class of the channel The code class depends on channel type: PILOT:5, MAC:6, PREAMBLE:5 and DATA:4 (spreading factor = $2^{\text{code class}}$)	{2 ... 7}	
<code number>	code number of the channel	{0...spreading factor-1}	
<Modulation>	Modulation type including mapping: 0 = BPSK-I, 1 = BPSK-Q, 2 = QPSK, 3 = 8-PSK, 4 = 16-QAM		
<absolute level>	absolute level of the code channel at the selected channel slot	{-∞ ... ∞}	dBm
<relative level>	relative level of the channel referenced to total power in the channel type	{-∞ ... ∞}	dB
<timing offset>	Timing offset of the channel to the frame start. Referred to the first active channel in seconds If the evaluation of the timing and phase offset is not active (refer to CDPower:TPMeas) or more than 50 active channels are in the signal, the value 9 is returned. For inactive channels, the value 9 is returned.		s
<phase offset>	Phase offset Referred to the first active channel in rad. If the evaluation of the timing and phase offset is not active (refer to CDPower:TPMeas) or more than 50 active channels are in the signal, the value 9 is returned. For inactive channels, the value 9 is returned.		

Bitstream

The command returns the bitstream of one slot, i.e. it returns one value for every bit (either 0 or 1) in a symbol in the following order:

<bit 1>, <bit 2>, ..., <bit n>, ...

The number of returned bits depends on the modulation type. For BPSK modulated signals there is one bit per symbol, for 2BPSK and QPSK signals there are 2 bits per symbol, for 8-PSK modulated signals there are 3 bits per symbol and for 16QAM modulated signal there are 4 bits per symbol. Accordingly, the bitstream per slot is of different lengths. The number of results is between 2 and 400.

Peak Code Domain Error

The command returns two values for every slot in the following order:

<slot number>, <level value in dB>, <slot number>, <level value in dB>, ...

The number of results corresponds to the IQ capture length. The number of results is between 2 and 12.

Code Domain Error

The command returns three values for every code in a channel in the following order:

<code number>,<error power >,< power ID>, ...

Return values

Value	Description	Range	Unit
<code number>	number of the code		
<error power>	value of the composite EVM		%
<power ID>	Power indication 0 - inactive channel, 1 - active channel	{0,1}	

The number of results corresponds to the spreading factor. The spreading factor in turn depends on the selected channel types. Therefore, 32 value triplets are returned for PILOT and PREAMBLE channels, 16 value triplets for DATA channels and 64 value triplets for MAC channels (see [Characteristics of the 1xEV-DO channel types](#) on page 6.658).

In addition, the output depends on the mapping settings. The output is either the I branch, the Q branch or the complex signal. If Code Domain Overview is activated, trace 1 shows the I branch and trace 2 shows the Q branch by default.

Symbol Constellation

The command returns two values, the real and imaginary parts, for every symbol in the following order:

<re 0>, <im 0>, <re 1>, <im 1>, ..., <re n>, <im n>, ...

The number of results depends on the number of symbols and is between 2 and 100 (see [Characteristics of the 1xEV-DO channel types](#), column 'Number of symbols per slot and code' on page 6.658).

EVM vs Symbol

The command returns one value for every symbol in the following order:

<value in % symbol 0>, <value in % symbol 1>, ...

The number of results depends on the number of symbols and is between 2 and 100.

Composite Constellation

The command returns two values, the real and imaginary parts, for every chip in the following order:

<re chip 0>, <im chip 0>, <re chip 1>, <im chip 1>, ..., <re chip n>, <im chip n>, ...

The number of results corresponds to the number of chips of the selected channel type. Therefore the number of results is between 64 and 1600 chips per slot (see [Characteristics of the 1xEV-DO channel types](#), column 'Chips per slot' on page 6.658).

Return values for parameter CTABLE

The command returns 12 values (including 4 reserved values) for maximum timing and phase offsets in the following order:

<max. time offset in s>, <channel type>, <code number for max. time>, <code class for max. time>, <max. phase offset in rad>, <channel type>, <code number for max. phase>, <code class for max. phase>, <reserved 1>, ..., <reserved 4>.

Return values

Value	Description	Range	Unit
<max. time offset in s>	Max timing offset value of all channels		s
<channel type>	channel type indication The channel type is coded with numbers as follows: 0 = PILOT, 1 = MAC, 2 = PREAMBLE with 64chip, 3 = PREAMBLE with 128chip, 4 = PREAMBLE with 256chip, 5 = PREAMBLE with 512chip, 6 = PREAMBLE with 1024chip, 7 = DATA	{0 ... 7}	
<code number for max. time>	The code number which has max timing offset value		
<code class for max. time>	The code class which has max timing offset value		
<max. phase offset in rad>	Max phase offset value of all channels		rad
<channel type>			
<code number for max. phase>	The code number which has max phase offset value		
<code class for max. phase>	The code class which has max phase offset value		
<reserved>	reserved for future functionality	{0}	

Remote Commands of the WLAN TX Measurements Option (K91 / K91n)

This section describes the remote commands for the WLAN TX Measurements option (K91/K91n). The abbreviation WLAN stands for the Wireless LAN operating mode. For details on conventions used in this chapter refer to section "Notation" on page 6.2 at the beginning of this chapter.

For further information on analyzer or basic settings commands, refer to the corresponding subsystem in section "Remote Commands of the Base Unit" on page 6.5.

This option is available from firmware version 1.20. The option R&S FSL-K91n is available from firmware version 1.90.

Subsystems of the WLAN TX Measurements option (K91 / K91n)

- "ABORt Subsystem (WLAN, K91 / K91n)" on page 6.666
- "CALCulate:BURSt Subsystem (WLAN, K91 / K91n)" on page 6.667
- "CALCulate:LIMit Subsystem (WLAN, K91 / K91n)" on page 6.668
- "CALCulate:MARKer Subsystem (WLAN, K91 / K91n)" on page 6.685
- "CONFIgure Subsystem (WLAN, K91 / K91n)" on page 6.692
- "DISPlay Subsystem (WLAN, K91 / K91n)" on page 6.702
- "FETCh Subsystem (WLAN, K91 / K91n)" on page 6.705
- "FORMat Subsystem (WLAN, K91 / K91n)" on page 6.714
- "INITiate Subsystem (WLAN, K91 / K91n)" on page 6.715
- "INPut Subsystem (WLAN, K91 / K91n)" on page 6.716
- "INSTrument Subsystem (WLAN, K91 / K91n)" on page 6.717
- "MMEMory Subsystem (WLAN, K91 / K91n)" on page 6.718
- "SENSE Subsystem (WLAN, K91 / K91)" on page 6.719
- "STATus Subsystem (WLAN, K91 / K91n)" on page 6.734
- "TRACe Subsystem (WLAN, K91 / K91n)" on page 6.738
- "TRIGger Subsystem (WLAN, K91 / K91n)" on page 6.744
- "UNIT Subsystem (WLAN, K91 / K91n)" on page 6.746

ABORt Subsystem (WLAN, K91 / K91n)

The ABORt subsystem contains the commands for aborting triggered actions.

Commands of the ABORt Subsystem

- [ABORt](#)

ABORt

For details refer to "[ABORt](#)" on page 6.10.

CALCulate:BURSt Subsystem (WLAN, K91 / K91n)

The CALCulate:BURSt subsystem checks the IQ measurement results.

Commands of the CALCulate:BURSt Subsystem

- [CALCulate<1|2>:BURSt\[:IMMEDIATE\]](#)

CALCulate<1|2>:BURSt[:IMMEDIATE]

This command forces the IQ measurement results to be recalculated according to the current settings.

This command is an event and therefore has no *RST value and no query.

Example

```
CALC1: BURS
```

Starts the recalculation of the IQ measurement results.

Characteristics

RST value: -

SCPI: device-specific

Mode

WLAN

CALCulate:LIMit Subsystem (WLAN, K91 / K91n)

The CALCulate:LIMit subsystem contains commands for the limit lines and the corresponding limit checks.

Commands of the CALCulate:LIMit Subsystem

- CALCulate<1|2>:LIMit<1...8>:FAIL?
- CALCulate<1|2>:LIMit<1>:ACPower:ACHannel?
- CALCulate<1|2>:LIMit<1>:ACPower:ACHannel:RESult?
- CALCulate<1|2>:LIMit<1>:ACPower:ALternate?
- CALCulate<1|2>:LIMit<1>:ACPower:ALternate:RESult?
- CALCulate<1|2>:LIMit<1>:BURSt:ALL
- CALCulate<1|2>:LIMit<1>:BURSt:ALL:RESult?
- CALCulate<1|2>:LIMit<1>:BURSt:EVM[:AVERage]
- CALCulate<1|2>:LIMit<1>:BURSt:EVM[:AVERage]:RESult?
- CALCulate<1|2>:LIMit<1>:BURSt:EVM:ALL[:AVERage]
- CALCulate<1|2>:LIMit<1>:BURSt:EVM:ALL[:AVERage]:RESult?
- CALCulate<1|2>:LIMit<1>:BURSt:EVM:ALL:MAXimum
- CALCulate<1|2>:LIMit<1>:BURSt:EVM:ALL:MAXimum:RESult?
- CALCulate<1|2>:LIMit<1>:BURSt:EVM:DATA[:AVERage]
- CALCulate<1|2>:LIMit<1>:BURSt:EVM:DATA[:AVERage]:RESult?
- CALCulate<1|2>:LIMit<1>:BURSt:EVM:DATA:MAXimum
- CALCulate<1|2>:LIMit<1>:BURSt:EVM:DATA:MAXimum:RESult?
- CALCulate<1|2>:LIMit<1>:BURSt:EVM:MAXimum
- CALCulate<1|2>:LIMit<1>:BURSt:EVM:MAXimum:RESult?
- CALCulate<1|2>:LIMit<1>:BURSt:EVM:PILot[:AVERage]
- CALCulate<1|2>:LIMit<1>:BURSt:EVM:PILot[:AVERage]:RESult?
- CALCulate<1|2>:LIMit<1>:BURSt:EVM:PILot:MAXimum
- CALCulate<1|2>:LIMit<1>:BURSt:EVM:PILot:MAXimum:RESult?
- CALCulate<1|2>:LIMit<1>:BURSt:FERRor[:AVERage]
- CALCulate<1|2>:LIMit<1>:BURSt:FERRor[:AVERage]:RESult?
- CALCulate<1|2>:LIMit<1>:BURSt:FERRor:MAXimum
- CALCulate<1|2>:LIMit<1>:BURSt:FERRor:MAXimum:RESult?
- CALCulate<1|2>:LIMit<1>:BURSt:IQOffset[:AVERage]
- CALCulate<1|2>:LIMit<1>:BURSt:IQOffset[:AVERage]:RESult?
- CALCulate<1|2>:LIMit<1>:BURSt:IQOffset:MAXimum
- CALCulate<1|2>:LIMit<1>:BURSt:IQOffset:MAXimum:RESult?
- CALCulate<1|2>:LIMit<1>:BURSt:SYMBOLerror[:AVERage]
- CALCulate<1|2>:LIMit<1>:BURSt:SYMBOLerror[:AVERage]:RESult?

- CALCulate<1|2>:LIMit<1>:BURSt:SYMBolerror:MAXimum
- CALCulate<1|2>:LIMit<1>:BURSt:SYMBolerror:MAXimum:RESult?
- CALCulate<1|2>:LIMit<1>:BURSt:TFALI[:AVERAge]
- CALCulate<1|2>:LIMit<1>:BURSt:TFALI[:AVERAge]:RESult?
- CALCulate<1|2>:LIMit<1>:BURSt:TFALI:MAXimum
- CALCulate<1|2>:LIMit<1>:BURSt:TFALI:MAXimum:RESult?
- CALCulate<1|2>:LIMit<1>:BURSt:TRISe[:AVERAge]
- CALCulate<1|2>:LIMit<1>:BURSt:TRISe[:AVERAge]:RESult?
- CALCulate<1|2>:LIMit<1>:BURSt:TRISe:MAXimum
- CALCulate<1|2>:LIMit<1>:BURSt:TRISe:MAXimum:RESult?
- CALCulate<1|2>:LIMit<1>:SPECTrum:MASK:CHECK:X?
- CALCulate<1|2>:LIMit<1>:SPECTrum:MASK:CHECK:Y?

CALCulate<1|2>:LIMit<1...8>:FAIL?

For option WLAN TX Measurements, K91 / K91n, the numeric suffixes <1...8> specify the limit lines as follows:

Suffix	Limit
1 to 2	These indexes are not used
3	ETSI Spectrum Mask limit line
4	Spectrum Flatness (Upper) limit line
5	Spectrum Flatness (Lower) limit line
6	IEEE Spectrum Mask limit line
7	PVT Rising Edge max limit
8	PVT Rising Edge mean limit
9	PVT Falling Edge max limit
10	PVT Falling Edge mean limit

For further details refer to "CALCulate<1|2>:LIMit<1...8>:FAIL?" on page 6.30.

CALCulate<1|2>:LIMit<1>:ACPpower:ACHannel?

This command returns the ACP adjacent channel limit for IEEE 802.11j if defined. This command is a query only and thus has no *RST value.

Parameter

numeric value in dB

Example

```
CALC:LIM:ACP:ACH?
```

Returns the IEEE 802.11j ACP adjacent channel limit.

Characteristics

*RST value: -

SCPI: device-specific

Mode

WLAN

CALCulate<1|2>:LIMit<1>:ACPoweR:ACHannel:RESult?

For details refer to "[CALCulate<1|2>:LIMit<1...8>:ACPoweR:ACHannel:RESult?](#)" on page 6.36.

CALCulate<1|2>:LIMit<1>:ACPoweR:ALTernate?

This command returns the ACP alternate channel limit for IEEE 802.11j if defined.

Parameter

numeric value in dB

Example

```
CALC:LIM:ACP:ALT?
```

Returns the IEEE 802.11j ACP alternate channel limit.

Characteristics

*RST value: -

SCPI: device-specific

Mode

WLAN

CALCulate<1|2>:LIMit<1>:ACPoweR:ALTernate:RESult?

For details refer to "[CALCulate<1|2>:LIMit<1...8>:ACPoweR:ALTernate<1...11>:RESult?](#)" on page 6.39.

CALCulate<1|2>:LIMit<1>:BURSt:ALL

This command sets or returns all the limit values.

Parameter

The results are input or output as a list of values separated by ',' in the following (ASCII) format:

```
<average frequency error>, <max frequency error>,
<average symbol error>, <max symbol error>,
<average IQ offset>, <maximum IQ offset>,
<average EVM all bursts>, <max EVM all bursts>,
<average EVM data carriers >, <max EVM data carriers >
<average EVM pilots >, <max EVM pilots >
```

Note: The units for the EVM results are specified with the [UNIT:EVM](#) command.

Example

```
CALC:LIM:BURS:ALL?
```

All limit values are returned

Characteristics

*RST value: -

SCPI: device-specific

Mode

WLAN

CALCulate<1|2>:LIMit<1>:BURSt:ALL:RESUlt?

This command returns all the limit results.

This command is a query only and thus has no *RST value.

Parameter

For details on formats refer to "CALCulate<1|2>:LIMit<1>:BURSt:ALL" on page 6.670.

Example

```
CALC:LIM:BURS:ALL:RES?
All limit values are returned
```

Characteristics

*RST value: -

SCPI: device-specific

Mode

WLAN

CALCulate<1|2>:LIMit<1>:BURSt:EVM[:AVERAge]

This command sets the average Error Vector Magnitude Limit for the IEEE 802.11b standard.

Parameter

numeric value in dB

Example

```
CALC:LIM:BURS:EVM -25.0
Average EVM limit is set to -25 dB
```

Characteristics

*RST value: -

SCPI: device-specific

Mode

WLAN

CALCulate<1|2>:LIMit<1>:BURSt:EVM[:AVERAge]:RESUlt?

This command returns the average Error Vector Magnitude Limit result for the IEEE 802.11b standard.

This command is a query only and thus has no *RST value.

Return values

0 PASSED

1 FAILED

Example

```
CALC:LIM:BURS:EVM:RES?
Average EVM limit result is returned
```

Characteristics

*RST value: -

SCPI: device-specific

Mode
WLAN

CALCulate<1|2>:LIMit<1>:BURSt:EVM:ALL[:AVERAge]

This command sets the average Error Vector Magnitude Limit. This is a combined figure that represents the pilot, data and the free carrier.

Parameter
numeric value in dB

Example
CALC:LIM:BURS:EVM:ALL -25.0
Average EVM for all carrier limit is set to -25.0 dB

Characteristics
*RST value: -
SCPI: device-specific

Mode
WLAN

CALCulate<1|2>:LIMit<1>:BURSt:EVM:ALL[:AVERAge]:RESult?

This command returns the average Error Vector Magnitude Limit result. This is a combined figure that represents the pilot, data and the free carrier.

This command is a query only and thus has no *RST value.

Return values
0 PASSED
1 FAILED

Example
CALC:LIM:BURS:EVM:ALL:RES?
Average EVM for all carrier limit result is returned

Characteristics
*RST value: -
SCPI: device-specific

Mode
WLAN

CALCulate<1|2>:LIMit<1>:BURSt:EVM:ALL:MAXimum

This command sets the maximum Error Vector Magnitude Limit. This is a combined figure that represents the pilot, data and the free carrier.

Parameter
numeric value in dB

Example
CALC:LIM:BURS:EVM:ALL:MAX?
Maximum EVM for all carrier limit is returned

Characteristics

*RST value: -

SCPI: device-specific

Mode

WLAN

CALCulate<1|2>:LIMit<1>:BURSt:EVM:ALL:MAXimum:RESult?

This command returns the maximum Error Vector Magnitude Limit result. This is a combined figure that represents the pilot, data and the free carrier.

This command is a query only and thus has no *RST value.

Return values

0 PASSED

1 FAILED

Example

```
CALC:LIM:BURS:EVM:ALL:MAX:RES?
```

Maximum EVM for all carrier limit result is returned

Characteristics

*RST value: -

SCPI: device-specific

Mode

WLAN

CALCulate<1|2>:LIMit<1>:BURSt:EVM:DATA[:AVERAge]

This command sets the average Error Vector Magnitude limit summary for the data carrier.

Parameter

numeric value in dB

Example

```
CALC:LIM:BURS:EVM:DATA -30.0
```

Average EVM for data carrier limit is set to -30.0 dB

Characteristics

*RST value: -

SCPI: device-specific

Mode

WLAN

CALCulate<1|2>:LIMit<1>:BURSt:EVM:DATA[:AVERAge]:RESult?

This command returns the average Error Vector Magnitude limit result summary for the data carrier.? (K91 / K91n)"

This command is a query only and thus has no *RST value.

Return values

0 PASSED
1 FAILED

Example

CALC:LIM:BURS:EVM:DATA:RES?
Average EVM for data carrier limit result is returned

Characteristics

*RST value: -
SCPI: device-specific

Mode

WLAN

CALCulate<1|2>:LIMit<1>:BURSt:EVM:DATA:MAXimum

This command sets the maximum Error Vector Magnitude limit summary for the data carrier.

Parameter

numeric value in dB

Example

CALC:LIM:BURS:EVM:DATA:MAX?
Maximum EVM for data burst limit is returned

Characteristics

*RST value: -
SCPI: device-specific

Mode

WLAN

CALCulate<1|2>:LIMit<1>:BURSt:EVM:DATA:MAXimum:RESult?

This command returns the maximum Error Vector Magnitude limit result summary for the data carrier.

This command is a query only and thus has no *RST value.

Return values

0 PASSED
1 FAILED

Example

CALC:LIM:BURS:EVM:DATA:MAX:RES?
Maximum EVM for data carrier limit result is returned Characteristics.

*RST value: -
SCPI: device-specific

Mode

WLAN

CALCulate<1|2>:LIMit<1>:BURSt:EVM:MAXimum

This command sets the maximum Error Vector Magnitude Limit for the IEEE 802.11b standard.

Parameter

numeric value in dB

Example

```
CALC:LIM:BURS:EVM:MAX?
Maximum EVM limit is returned
```

Characteristics

*RST value: -

SCPI: device-specific

Mode

WLAN

CALCulate<1|2>:LIMit<1>:BURSt:EVM:MAXimum:RESult?

This command returns the maximum Error Vector Magnitude Limit result for the IEEE 802.11b standard.

This command is a query only and thus has no *RST value.

Return values

0 PASSED

1 FAILED

Example

```
CALC:LIM:BURS:EVM:MAX:RES?
Maximum EVM limit result is returned
```

Characteristics

*RST value: -

SCPI: device-specific

Mode

WLAN

CALCulate<1|2>:LIMit<1>:BURSt:EVM:PILot[:AVERage]

This command sets the average Error Vector Magnitude limit summary for the pilot carriers.

Parameter

numeric value in dB

Example

```
CALC:LIM:BURS:EVM:PIL -8.0
Average EVM for pilot carrier limit is set to -8.0 dB
```

Characteristics

*RST value: -

SCPI: device-specific

Mode

WLAN

CALCulate<1|2>:LIMit<1>:BURSt:EVM:PILot[:AVERAge]:RESult?

This command returns the average Error Vector Magnitude limit result summary for the pilot carriers.

This command is a query only and thus has no *RST value.

Return values

0 PASSED
1 FAILED

Example

```
CALC:LIM:BURS:EVM:PIL:RES?
```

Average EVM for pilot carrier limit result is returned

Characteristics

*RST value: -

SCPI: device-specific

Mode

WLAN

CALCulate<1|2>:LIMit<1>:BURSt:EVM:PILot:MAXimum

This command sets the maximum Error Vector Magnitude limit summary for the pilot carriers.

Parameter

numeric value in dB

Example

```
CALC:LIM:BURS:EVM:PIL:MAX?
```

Maximum EVM for pilot carrier limit is returned

Characteristics

*RST value: -

SCPI: device-specific

Mode

WLAN

CALCulate<1|2>:LIMit<1>:BURSt:EVM:PILot:MAXimum:RESult?

This command returns the maximum Error Vector Magnitude limit result summary for the pilot carriers.

This command is a query only and thus has no *RST value.

Return values

0 PASSED
1 FAILED

Example

```
CALC:LIM:BURS:EVM:PIL:MAX:RES?
```

Maximum EVM for pilot carrier limit result is returned

Characteristics

*RST value: -

SCPI: device-specific

Mode

WLAN

CALCulate<1|2>:LIMit<1>:BURSt:FERRor[:AVERAge]

This command sets the average frequency error limit.

Parameter

numeric value in Hertz

Example

```
CALC:LIM:BURS:FERR 10000
```

The average frequency error limit is set to 10 kHz

Characteristics

*RST value: -

SCPI: device-specific

Mode

WLAN

CALCulate<1|2>:LIMit<1>:BURSt:FERRor[:AVERAge]:RESult?

This command returns the average frequency error limit result.

This command is a query only and thus has no *RST value.

Example

```
CALC:LIM:BURS:FERR:RES?
```

Average frequency error limit result is returned

Characteristics

*RST value: -

SCPI: device-specific

Mode

WLAN

CALCulate<1|2>:LIMit<1>:BURSt:FERRor:MAXimum

This command sets the maximum frequency error limit.

Parameter

numeric value in Hertz

Example

```
CALC:LIM:BURS:FERR:MAX?
```

Maximum frequency error limit is returned

Characteristics

*RST value: -

SCPI: device-specific

ModeWLAN

CALCulate<1|2>:LIMit<1>:BURSt:FERRor:MAXimum:RESult?

This command returns the maximum frequency error limit result.
This command is a query only and thus has no *RST value.

Example

```
CALC:LIM:BURS:FERR:MAX:RES?
```

Maximum frequency error limit result is returned

Characteristics

*RST value: -

SCPI: device-specific

ModeWLAN

CALCulate<1|2>:LIMit<1>:BURSt:IQOffset[:AVERage]

This command sets the average IQ Offset error limit.

Parameter

numeric value in dB: -1000000 to 1000000

Example

```
CALC:LIM:BURS:IQOF -10.0
```

Average IQ Offset error limit is set to -10.0 dB

Characteristics

*RST value: -

SCPI: device-specific

ModeWLAN

CALCulate<1|2>:LIMit<1>:BURSt:IQOffset[:AVERage]:RESult?

This command returns the average IQ Offset error limit result.

Example

```
CALC:LIM:BURS:IQOF:RES?
```

Average IQ Offset error limit result is returned

Characteristics

*RST value: -

SCPI: device-specific

ModeWLAN

CALCulate<1|2>:LIMit<1>:BURSt:IQOFset:MAXimum

This command sets the maximum IQ Offset error limit.

Parameter

numeric value in dB: -1000000 to 1000000

Example

```
CALC:LIM:BURS:IQOF:MAX 15.0  
Maximum IQ Offset error limit is set to -15.0 dB
```

Characteristics

*RST value: -
SCPI: device-specific

Mode

WLAN

CALCulate<1|2>:LIMit<1>:BURSt:IQOFset:MAXimum:RESult?

This command returns the maximum IQ Offset error limit result.

Example

```
CALC:LIM:BURS:IQOF:MAX:RES?  
Maximum IQ Offset error limit result is returned
```

Characteristics

*RST value: -
SCPI: device-specific

Mode

WLAN

CALCulate<1|2>:LIMit<1>:BURSt:SYMBolerror[:AVERage]

This command sets the average symbol error limit.

Parameter

numeric value in Hertz

Example

```
CALC:LIM:BURS:SYMB 10000  
The average symbol error limit is set to 10kHz
```

Characteristics

*RST value: -
SCPI: device-specific

Mode

WLAN

CALCulate<1|2>:LIMit<1>:BURSt:SYMBolerror[:AVERage]:RESult?

This command returns the average symbol error limit result.
This command is a query only and thus has no *RST value.

Example

```
CALC:LIM:BURS:SYMB:RES?
Average symbol error limit result is returned
```

Characteristics

*RST value: -
SCPI: device-specific

Mode

WLAN

CALCulate<1|2>:LIMit<1>:BURSt:SYMBolerror:MAXimum

This command sets the maximum symbol error limit.

Parameter

numeric value in Hertz

Example

```
CALC:LIM:BURS:SYMB:MAX?
Maximum symbol error limit is returned
```

Characteristics

*RST value: -
SCPI: device-specific

Mode

WLAN

CALCulate<1|2>:LIMit<1>:BURSt:SYMBolerror:MAXimum:RESult?

This command returns the maximum symbol error limit result.
This command is a query only and thus has no *RST value.

Example

```
CALC:LIM:BURS:SYMB:MAX:RES?
Maximum symbol error limit result is returned.
```

Characteristics

*RST value: -
SCPI: device-specific

Mode

WLAN

CALCulate<1|2>:LIMit<1>:BURSt:TFALI[:AVERAge]

This command sets the average fall time limit.

Parameter

numeric value in seconds

Example

```
CALC:LIM:BURS:TFAL 0.000001
```

The average fall time limit is set to 1 μ s

Characteristics

*RST value: -

SCPI: device-specific

Mode

WLAN

CALCulate<1|2>:LIMit<1>:BURSt:TFALI[:AVERAge]:RESult?

This command returns the average fall time limit result.

This command is a query only and thus has no *RST value.

Example

```
CALC:LIM:BURS:TFAL1:RES?
```

Average fall time limit result is returned

Characteristics

*RST value: -

SCPI: device-specific

Mode

WLAN

CALCulate<1|2>:LIMit<1>:BURSt:TFALI:MAXimum

This command sets the maximum fall time limit.

Parameter

numeric value in seconds

Example

```
CALC:LIM:BURS:TFAL1:MAX 0.000001
```

The maximum fall time limit set to 1 μ s.

Characteristics

*RST value: -

SCPI: device-specific

Mode

WLAN

CALCulate<1|2>:LIMit<1>:BURSt:TFALI:MAXimum:RESult?

This command returns the maximum fall time limit result.
This command is a query only and thus has no *RST value.

Example

```
CALC:LIM:BURS:TRIS:MAX:RES?
```

Maximum fall time limit result is returned

Characteristics

*RST value: -
SCPI: device-specific

Mode

WLAN

CALCulate<1|2>:LIMit<1>:BURSt:TRISe[:AVERAge]

This command sets the average rise time limit.

Parameter

numeric value in seconds

Example

```
CALC:LIM:BURS:TRIS 0.000001
```

The average rise time limit is set to 1 μ s

Characteristics

*RST value: -
SCPI: device-specific

Mode

WLAN

CALCulate<1|2>:LIMit<1>:BURSt:TRISe[:AVERAge]:RESult?

This command returns the average rise time limit result.
This command is a query only and thus has no *RST value.

Example

```
CALC:LIM:BURS:TRIS:RES?
```

The average rise time limit result is returned

Characteristics

*RST value: -
SCPI: device-specific

Mode

WLAN

CALCulate<1|2>:LIMit<1>:BURSt:TRISe:MAXimum

This command sets the maximum rise time limit.

Parameter

numeric value in seconds

Example

```
CALC:LIM:BURS:TRIS:MAX 0.000001
```

Maximum rise time limit is set to 1 μ s

Characteristics

*RST value: -

SCPI: device-specific

Mode

WLAN

CALCulate<1|2>:LIMit<1>:BURSt:TRISe:MAXimum:RESult?

This command returns the maximum rise time limit result.

This command is a query only and thus has no *RST value.

Example

```
CALC:LIM:BURS:TRIS:MAX:RES?
```

Maximum rise time limit result is returned

Characteristics

*RST value: -

SCPI: device-specific

Mode

WLAN

CALCulate<1|2>:LIMit<1>:SPECTrum:MASK:CHECK:X?

This command returns the X-value at the maximum overstepping of the spectrum mask limits.

This command is a query only and thus has no *RST value.

Example

```
CALC:LIM:SPEC:MASK:CHEC:X?
```

Returns the frequency at the maximum overstepping.

Characteristics

*RST value: -

SCPI: device-specific

Mode

WLAN

CALCulate<1|2>:LIMit<1>:SPECtrum:MASK:CHECK:Y?

This command returns the Y-value at the maximum overstepping of the spectrum mask limits.
This command is a query only and thus has no *RST value.

Example

CALC:LIM:SPEC:MASK:CHECK:Y?

Returns the power at the maximum overstepping.

Characteristics

*RST value: -

SCPI: device-specific

Mode

WLAN

CALCulate:MARKer Subsystem (WLAN, K91 / K91n)

The CALCulate:MARKer subsystem checks the marker functions of the instrument.

The following subsystem is included:

- ["CALCulate:MARKer:FUNCTION Subsystem \(WLAN, K91 / K91n\)"](#) on page 6.690

Commands of the CALCulate:MARKer Subsystem

- `CALCulate<1|2>:MARKer<1>[:STATe]`
- `CALCulate<1|2>:MARKer<1>:AOFF`
- `CALCulate<1|2>:MARKer<1>:BSYMBOL`
- `CALCulate<1|2>:MARKer<1>:CARRIER`
- `CALCulate<1|2>:MARKer<1>:MAXimum`
- `CALCulate<1|2>:MARKer<1>:MINimum`
- `CALCulate<1|2>:MARKer<1>:SYMBOL`
- `CALCulate<1|2>:MARKer<1>:TRACE`
- `CALCulate<1|2>:MARKer<1>:X`
- `CALCulate<1|2>:MARKer<1>:Y`

CALCulate<1|2>:MARKer<1>[:STATe]

This command switches the markers on or off.

Parameter

ON | OFF

Example

```
CALC1:MARK1:STATE ON
```

Switches the screen A marker ON.

```
CALC2:MARK1:STATE OFF
```

Switches the screen B marker OFF.

Characteristics

RST value: ON

SCPI: device-specific

Mode

WLAN

CALCulate<1|2>:MARKer<1>:AOFF

This command switches off all active markers in the specified measurement window. The window is set by the numeric suffix of `CALCulate<1|2>`.

Example

```
CALC1:MARK:AOFF
```

Switches off all markers in the screen A window.

```
CALC2:MARK:AOFF
```

Switches off all markers in the screen B window.

Characteristics

RST value: -

SCPI: device-specific

Mode

WLAN

CALCulate<1|2>:MARKer<1>:BSYMBOL

This command positions the selected marker to the indicated symbol in the indicated burst. The first numeric value is the burst number and the second numeric value is the symbol number.

This command only applies to 802.11b standard for the following result displays:

- Constellation vs Symbol
- EVM vs Symbol

This command is a query only and thus has no *RST value.

Parameter

<numeric_value>,<numeric_value>

Example

```
CALC:MARK1:BSYM 2,10
```

Positions marker 1 to symbol 10 of burst 2.

```
CALC:MARK1:BSYM?
```

Outputs the burst and symbol values of marker 1.

Characteristics

*RST value: -

SCPI: device-specific

Mode

WLAN

CALCulate<1|2>:MARKer<1>:CARRIER

This command positions the selected marker to the indicated carrier.

This command is query only for the following result displays:

- Constellation vs Symbol
- Constellation vs Carrier

Parameter

<numeric_value>

Example

```
CALC:MARK:CARR -7
```

Positions marker 1 to carrier -7.

```
CALC:MARK:CARR?
```

Outputs the carrier value of marker 1.

Characteristics

*RST value: -

SCPI: device-specific

ModeWLAN

CALCulate<1|2>:MARKer<1>:MAXimum

This command sets the selected marker to the maximum peak value in the current trace. This command is only available for the Spectrum Flatness result display.

This command is an event and therefore has no *RST value and no query.

Example

```
CALC2:MARK:MAX
```

Set marker 1 in screen B to maximum value in trace.

Characteristics

RST value: -

SCPI: device-specific

ModeWLAN

CALCulate<1|2>:MARKer<1>:MINimum

This command sets the selected marker to the minimum peak value in the current trace. This command is only available for the Spectrum Flatness result display.

This command is an event and therefore has no *RST value and no query.

Example

```
CALC2:MARK:MIN
```

Set marker 1 in screen B to minimum value in trace.

Characteristics

RST value: -

SCPI: device-specific

ModeWLAN

CALCulate<1|2>:MARKer<1>:SYMBOL

This command positions the selected marker to the indicated symbol.

This command is query only for the following result displays:

- Constellation vs Symbol
- Constellation vs Carrier

Parameter

<numeric_value>

Example

```
CALC:MARK:SYMB 2
```

Positions marker 1 to symbol 2.

```
CALC:MARK:SYMB?
```

Outputs the symbol value of marker 1.

Characteristics

*RST value: -

SCPI: device-specific

Mode

WLAN

CALCulate<1|2>:MARKer<1>:TRACe

This command assigns the selected marker to the indicated measurement curve in the selected measurement window.

This command is only available for the following result displays:

- Constellation versus Carrier
- EVM vs Symbol
- Frequency Error vs Preamble
- Phase Error vs Preamble
- PVT Full Burst
- PVT Rising / Falling
- Spectrum Flatness
- Spectrum Mask, if Max Hold trace is displayed
- Spectrum ACP/ACPR, if Max Hold trace is displayed

Example

```
"CALC2:MARK:TRAC 2
```

Assigns marker 1 in screen B to trace 2.

Characteristics

*RST value: 1

SCPI: device-specific

Mode

WLAN

CALCulate<1|2>:MARKer<1>:X

This command positions the selected marker to the indicated inphase (Constellation vs Symbol), frequency (Spectrum FFT, Spectrum Mask, Spectrum APCR), time (Magnitude Capture Buffer, Auto level, PVT Full Burst, PVT Rising / Falling), power (CCDF), sub-carrier (Constellation vs Carrier, EVM vs Carrier, Spectrum Flatness) or symbol (EVM vs Symbol) in the selected measurement window.

This command is query only for the following result displays:

- Constellation vs Symbol
- Constellation vs Carrier

Parameter

<numeric_value> in Hz, s, dB

Example

```
CALC:MARK:X 2ms
```

Positions marker 1 to time 2ms.

Characteristics

*RST value: -

SCPI: device-specific

Mode

WLAN

CALCulate<1|2>:MARKer<1>:Y

This command positions the selected marker to the indicated quadrature (Constellation vs Symbol), magnitude of I or Q (Constellation vs Carrier), EVM (EVM vs Carrier) or abs (Spectrum Flatness) in the selected measurement window.

This command is query only for the following result displays:

- Auto Level
- Constellation vs Symbol
- Constellation vs Carrier
- EVM vs Symbol
- PVT Full
- PVT Rising / Falling
- Magnitude Capture Buffer
- Spectrum Mask
- Spectrum ACP/ACPR
- Spectrum FFT
- CCDF

Parameter

<numeric_value> in percent or dB

Example

```
CALC2:MARK:Y -2
```

Positions marker 1 in screen B to -2.

```
CALC:MARK:Y?
```

Outputs the measured value of marker 1.

Characteristics

*RST value: -

SCPI: device-specific

Mode

WLAN

CALCulate:MARKer:FUNCTion Subsystem (WLAN, K91 / K91n)

The measurement window is selected by CALCulate 1 (screen A) or 2 (screen B).

Commands of the CALCulate:MARKer:FUNCTion Subsystem

- [CALCulate<1|2>:MARKer<1>:FUNCTion:POWER:RESult\[:CURRent\]?](#)
- [CALCulate<1|2>:MARKer<1>:FUNCTion:POWER:RESult:MAXHold?](#)
- [CALCulate<1|2>:MARKer<1>:FUNCTion:ZOOM](#)

CALCulate<1|2>:MARKer<1>:FUNCTion:POWER:RESult[:CURRent]?

This command queries the current result values of the adjacent channel power measurement. An ACPR (Adjacent channel power relative) measurement must have previously been run, for there to be summary data available.

Results are output separated by commas in the following order:

- Power of main channel
- Power of lower adjacent channel
- Power of upper adjacent channel
- Power of lower alternate adjacent channel 1
- Power of upper alternate adjacent channel 1
- Power of lower alternate adjacent channel 2
- Power of upper alternate adjacent channel 2

Adjacent channel power values are output in dB.

This command is a query only and thus has no *RST value.

Example

```
CALC:MARK:FUNC:POW:RES?
```

Characteristics

*RST value: -

SCPI: device-specific

Mode

WLAN

CALCulate<1|2>:MARKer<1>:FUNCTion:POWER:RESult:MAXHold?

This command queries the maximum result values of the adjacent channel power measurement. An ACPR (Adjacent channel power relative) measurement must have previously been run with more than one sweep, for there to be maximum summary data available.

For details on the output refer to

["CALCulate<1|2>:MARKer<1>:FUNCTion:POWER:RESult\[:CURRent\]?"](#) on page 6.690.

This command is a query only and thus has no *RST value.

Example

```
CALC:MARK:FUNC:POW:RES:MAXH?
```

Characteristics

*RST value: -

SCPI: device-specific

ModeWLAN

CALCulate<1|2>:MARKer<1>:FUNCTion:ZOOM

This command sets the magnification factor for the zoom. It is only available for the following result displays:

- Constellation vs Carrier
- Constellation vs Symbol
- PVT
- Magnitude Capture Buffer

Parameter

<numeric_value>

Example

INIT:CONT OFF

Switches to single sweep mode

CALC:MARK:FUNC:ZOOM 3;*WAI

Activates zooming and waits for its end.

Characteristics

*RST value: -

SCPI: device-specific

ModeWLAN

CONFigure Subsystem (WLAN, K91 / K91n)

The CONFigure subsystem contains commands for configuring complex measurement tasks. The CONFigure subsystem is closely linked to the functions of the FETCH subsystem, where the measurement results are queried.

Commands of the CONFigure Subsystem

- CONFigure:BURSt:CONSt:CARRier:SElect
- CONFigure:BURSt:CONSt:CCARRier[:IMMediate]
- CONFigure:BURSt:CONSt:CSYMBOL[:IMMediate]
- CONFigure:BURSt:EVM:ECARRier[:IMMediate]
- CONFigure:BURSt:EVM:ESYMBOL[:IMMediate]
- CONFigure:BURSt:PREamble[:IMMediate]
- CONFigure:BURSt:PREamble:SElect
- CONFigure:BURSt:PVT[:IMMediate]
- CONFigure:BURSt:PVT:AVERage
- CONFigure:BURSt:PVT:RPOWer
- CONFigure:BURSt:PVT:SElect
- CONFigure:BURSt:SPECtrum:ACPR[:IMMediate]
- CONFigure:BURSt:SPECtrum:FFT[:IMMediate]
- CONFigure:BURSt:SPECtrum:FLATness[:IMMediate]
- CONFigure:BURSt:SPECtrum:MASK[:IMMediate]
- CONFigure:BURSt:SPECtrum:MASK:SElect
- CONFigure:BURSt:STATistics:BSTReam[:IMMediate]
- CONFigure:BURSt:STATistics:CCDF[:IMMediate]
- CONFigure:BURSt:STATistics:SField[:IMMediate]
- CONFigure:CHANnel
- CONFigure:POWer:AUTO
- CONFigure:POWer:AUTO:SWEEp:TIME
- CONFigure:POWer:EXPEcted:RF
- CONFigure:STANdard

CONFigure:BURSt:CONSt:CARRier:SElect

This remote control command is only available when Constellation vs Symbol measurement is selected. When the Constellation versus Symbol measurement is initiated, it will calculate the results of the selected carrier.

Parameter

-26 to 26 | ALL | PILOTS

Example

```
CONF:BURS:CONS:CARR:SEL -26  
Carrier -26 is selected.
```

```
CONF:BURS:CONS:CARR:SEL 10
```

Carrier 10 is selected.

```
CONF:BURS:CONS:CARR:SEL ALL
```

All carriers are selected.

```
CONF:BURS:CONS:CARR:SEL P1L
```

Pilots only.

Characteristics

*RST value: ALL

SCPI: device-specific

Mode

WLAN

CONFigure:BURSt:CONSt:CCARrier[:IMMediate]

This remote control command configures the measurement type to be Constellation vs Carrier. After this command has been executed, the specified measurement will only be started when the user issues the [INITiate\[:IMMediate\]](#) command.

Example

```
CONF:BURS:CONS:CCAR
```

Configures the Constellation versus Carrier measurement type.

Characteristics

*RST value: -

SCPI: device-specific

Mode

WLAN

CONFigure:BURSt:CONSt:CSYMBOL[:IMMediate]

This remote control command configures the measurement type to be Constellation vs Symbol. After this command has been executed, the specified measurement will only be started when the user issues the [INITiate\[:IMMediate\]](#) command.

Example

```
CONF:BURS:CONS:CSYM
```

Configures the Constellation versus Symbol measurement type.

Characteristics

*RST value: -

SCPI: device-specific

Mode

WLAN

CONFigure:BURSt:EVM:ECARrier[:IMMediate]

This remote control command configures the measurement type to be EVM vs Carrier. After this command has been executed, the specified measurement will only be started when the user issues the [INITiate\[:IMMediate\]](#) command.

Example

```
CONF: BURS: EVM: ECAR
```

Configures the EVM vs Carrier measurement type.

Characteristics

*RST value: -

SCPI: device-specific

Mode

WLAN

CONFigure: BURSt: EVM: ESYMbol[: IMMEDIATE]

This remote control command configures the measurement type to be EVM vs Symbol. After this command has been executed, the specified measurement will only be started when the user issues the [INITiate\[: IMMEDIATE\]](#) command.

Example

```
CONF: BURS: EVM: ESYM
```

Configures the EVM vs Symbol measurement type.

Characteristics

*RST value: -

SCPI: device-specific

Mode

WLAN

CONFigure: BURSt: PREamble[: IMMEDIATE]

This remote control command configures the measurement type to be Phase or Frequency vs Preamble. After this command has been executed, the specified measurement will only be started when the user issues the [INITiate\[: IMMEDIATE\]](#) command.

Example

```
CONF: BURS: PRE
```

Configures the preamble measurement type.

Characteristics

*RST value: -

SCPI: device-specific

Mode

WLAN

CONFigure: BURSt: PREamble: SElect

This remote control command configures the interpretation of the preamble measurement results.

Parameter

PHASe | FREQuency

Example

```
CONF: BURS: PRE: SEL PHAS
```

Configures the Phase vs Preamble measurement type.

Characteristics

*RST value: -

SCPI: device-specific

Mode

WLAN

CONFigure:BURSt:PVT[:IMMEDIATE]

This remote control command configures the measurement type to be Power vs Time. After this command has been executed, the specified measurement will only be started when the user issues the `INITiate[:IMMEDIATE]` command.

Example

```
CONF: BURS: PVT
```

Configures the Power vs Time measurement type.

Characteristics

*RST value: -

SCPI: device-specific

Mode

WLAN

CONFigure:BURSt:PVT:AVERAge

This remote control command configures the measurement type to set the burst power averaging length to the desired value. This command is only valid when the selected standard is IEEE 802.11b.

Parameter

<numeric_value>

Example

```
CONF: BURS: PVT: AVER 31
```

Configures the burst power average length of 31.

Characteristics

*RST value: -

SCPI: device-specific

Mode

WLAN

CONFigure:BURSt:PVT:RPOWer

This remote control command configures the use of either mean or maximum burst power as a reference power for the 802.11b PVT measurement.

Parameter

MEAN | MAXimum

Example

```
CONF: BURS: PVT: RPOW MEAN
```

Configures to use mean burst power as a reference power.

Characteristics

*RST value: -
 SCPI: device-specific

Mode

WLAN

CONFigure:BURSt:PVT:SElect

This remote control configures how to interpret the Power vs Time measurement results.

Parameter	Description	Wireless LAN standard
EDGE	configures the measurement to be rising and falling edge	all
FALL	configures the measurement to be falling edge only	IEEE 802.11b & g (CCK)
FULL	configures the measurement to be full burst	IEEE 802.11a, j & g, n (OFDM), IEEE 802.11 Turbo Mode
RISE	configures the measurement to be rising edge only	IEEE 802.11b & g (CCK)

Example

CONF: BURS: PVT: SEL FULL
 Interprets the measurement results as full burst

Characteristics

*RST value: -
 SCPI: device-specific

Mode

WLAN

CONFigure:BURSt:SPECtrum:ACPR[:IMMediate]

This remote control command configures the measurement type to be ACPR (adjacent channel power relative) After this command has been executed, the specified measurement will only be started when the user issues the [INITiate\[:IMMediate\]](#) command.

Example

CONF: BURS: SPEC: ACPR
 Configures the ACPR measurement type.

Characteristics

*RST value: -
 SCPI: device-specific

Mode

WLAN

CONFigure:BURSt:SPECtrum:FFT[:IMMediate]

This remote control command configures the measurement type to be FFT (Fast Fourier Transform). After this command has been executed, the specified measurement will only be started when the user issues the [INITiate\[:IMMediate\]](#) command.

Example

```
CONF: BURS: SPEC: FFT
```

Configures the FFT measurement type.

Characteristics

*RST value: -

SCPI: device-specific

Mode

WLAN

CONFigure: BURSt: SPECtrum: FLATness[: IMMEDIATE]

This remote control command configures the measurement type to be Spectrum Flatness. After this command has been executed, the specified measurement will only be started when the user issues the [INITiate\[: IMMEDIATE\]](#) command.

Example

```
CONF: BURS: SPEC: FLAT
```

Configures the Spectrum Flatness measurement type.

Characteristics

*RST value: -

SCPI: device-specific

Mode

WLAN

CONFigure: BURSt: SPECtrum: MASK[: IMMEDIATE]

This remote control command configures the measurement type to be Spectrum Mask. After this command has been executed, the specified measurement will only be started when the user issues the [INITiate\[: IMMEDIATE\]](#) command

Example

```
CONF: BURS: SPEC: MASK
```

Configures the Spectrum Mask measurement type.

Characteristics

*RST value: -

SCPI: device-specific

Mode

WLAN

CONFigure: BURSt: SPECtrum: MASK: SELect

This remote control configures the interpretation of the Spectrum Mask measurement results. This command is only available for IEEE 802.11a.

Parameter

IEEE | ETSI

Example

```
CONF: BURS: SPEC: MASK: SEL ETSI
```

Interprets the measurement results using the ETSI standard.

Characteristics

*RST value: -
 SCPI: device-specific

Mode

WLAN

CONFigure:BURSt:STATistics:BSTReam[:IMMediate]

This remote control command configures the measurement type to be Bitstream. After this command has been executed, the specified measurement will only be started when the user issues the `INITiate[:IMMediate]` command.

Example

`CONF: BURS: STAT: BSTR`
 Configures the Bitstream measurement type.

Characteristics

*RST value: -
 SCPI: device-specific

Mode

WLAN

CONFigure:BURSt:STATistics:CCDF[:IMMediate]

This remote control command configures the measurement type to be CCDF (conditional cumulative distribution functions.). After this command has been executed, the specified measurement will only be started when the user issues the `INITiate[:IMMediate]` command.

Example

`CONF: BURS: STAT: CCDF`
 Configures the CCDF measurement type.

Characteristics

*RST value: -
 SCPI: device-specific

Mode

WLAN

CONFigure:BURSt:STATistics:SFIeld[:IMMediate]

This remote control command configures the measurement type to be Signal Field. After this command has been executed, the specified measurement will only be started when the user issues the `INITiate[:IMMediate]` command.

Example

`CONF: BURS: STAT: SFIeld`
 Configures the Signal Field measurement type.

Characteristics

*RST value: -
 SCPI: device-specific

Mode
WLAN

CONFigure:CHANnel

This remote control command is used to specify the input channel for which measurements are to be performed. This command will automatically cause the internal measurement frequency to be re-calculated.

Parameter
<numeric_value>

Example
CONF:CHAN 9
Specifies channel 9 as frequency measurement.

Characteristics
*RST value: 0
SCPI: device-specific

Mode
WLAN

CONFigure:POWer:AUTO

This remote control command is used to switch on or off automatic power level detection. When switched on, power level detection is performed at the start of each measurement sweep.

Parameter
ONCE | ON | OFF

If this command is issued with the ONCE parameter then the auto level routine is performed immediately one time.

Example
CONF:POW:AUTO ON
Configures the automatic detection of the input power level.

Characteristics
*RST value: -
SCPI: device-specific

Mode
WLAN

CONFigure:POWer:AUTO:SWEep:TIME

This remote control command is used to specify the sweep time for the automatic power level detection.

Parameter
numeric value in seconds

Example
CONF:POW:AUTO:SWE:TIME 200MS
Configures a 200 ms sweep time for the auto-level detection.

Characteristics

*RST value: 100ms

SCPI: device-specific

Mode

WLAN

CONFigure:POWer:EXPEcted:RF

This remote control command is used to specify the mean power level of the source signal as supplied to the Analyzer RF input. This value will be overwritten if Auto Level is turned on.

Parameter

<numeric_value> in dBm

Example

```
CONF:POW:EXP:RF 9
```

Assumes an input signal strength of 9 dBm.

Characteristics

*RST value: -

SCPI: device-specific

Mode

WLAN

CONFigure:STANdard

This remote control command specifies which Wireless LAN standard the option is configured to measure.

Parameter

- 0 IEEE 802.11a
- 1 IEEE 802.11b
- 2 IEEE 802.11j (10 MHz)
- 3 IEEE 802.11j (20 MHz)
- 4 IEEE 802.11g
- 5 Turbo
- 6 IEEE 802.11n

Example

```
CONF:STAN 0
```

Selects the IEEE 802.11a standard for the measurement.

Characteristics

*RST value: 0

SCPI: device-specific

Mode

WLAN

CONFigure:WLAN:GTIMe:AUTO

This remote control command specifies whether the guard time of the IEEE 802.11n input signal is automatically detected or specified manually.

Example

```
CCONF:WLAN:GTIM:AUTO ON
```

Sets automatic detection of the guard time of the input signal

Characteristics

*RST value: --

SCPI: device-specific

Mode

WLAN

CONFigure:WLAN:GTIMe:SElect

This remote control command specifies the guard time of the IEEE 802.11n input signal. If the guard time is specified to be detected from the input signal using the CONFigure:WLAN:GTIMe:AUTO command then this command is query only and allows the detected guard time to be obtained.

Example

```
CCONF:WLAN:GTIM:SEL SHOR
```

Configures signal measurements with short guard times

Characteristics

*RST value: --

SCPI: device-specific

Mode

WLAN

DISPlay Subsystem (WLAN, K91 / K91n)

The DISPlay subsystem controls the selection and presentation of textual and graphic information as well as of measurement data on the display. In contrast to the base unit, the WLAN TX Measurements option supports the split screen modus.

Commands of the DISPlay Subsystem

- DISPlay:FORMat
- DISPlay[:WINDow<1|2>]:SSElect
- DISPlay[:WINDow<1|2>]:TABLe
- DISPlay[:WINDow<1|2>]:TRACe<1...3>:Y[:SCALe]:AUTO
- DISPlay[:WINDow<1|2>]:TRACe<1...3>:Y[:SCALe]:PDIVision
- DISPlay[:WINDow<1|2>]:TRACe<1...3>:Y[:SCALe]:RLEVel
- DISPlay[:WINDow<1|2>]:TRACe<1...3>:Y[:SCALe]:RLEVel:OFFSet

DISPlay:FORMat

This command sets the visible screen display type to full or split screen.

Parameter

SPLit | SINGle

Example

```
DISP:FORM SINGLE
Sets the display to full screen.
```

Characteristics

*RST value: SPL
SCPI: device-specific

Mode

WLAN

DISPlay[:WINDow<1|2>]:SSElect

This command selects whether screen A or screen B is active. SSElect means Screen SElect.

Example

```
DISP:WIND1:SSEL
Sets the screen A active.
```

Characteristics

*RST value: 1
SCPI: device-specific

Mode

WLAN

DISPlay[:WINDow<1|2>]:TABLe

This command selects whether the results table is displayed.

Parameter

ON | OFF

Example

DISP:WIND1:TABL ON
Hides the results table

Characteristics

*RST value: ON
SCPI: device-specific

Mode

WLAN

DISPlay[:WINDow<1|2>]:TRACe<1...3>:Y[:SCALe]:AUTO

This command switches on or off automatic scaling of the Y-axis for the specified trace display. Automatic scaling sets the Y-axis to automatically scale to best fit the measurement results. This command is only available for the following result displays:

- EVM vs Carrier
- EVM vs Symbol.
- Frequency error vs Preamble
- Phase error vs Preamble

The numeric suffix at WINDow<1|2> must be 2 as the relevant results are always displayed in screen B. The numeric suffix at TRACe<1...3> must be 1.

Parameter

ON | OFF

Example

DISP:WIND2:TRAC:Y:SCAL:AUTO ON
switches on automatic scaling of the Y-axis for the active trace

Characteristics

*RST value: ON

Mode

WLAN

DISPlay[:WINDow<1|2>]:TRACe<1...3>:Y[:SCALe]:PDIVision

This command sets the size of each Y scale division for the specified trace display. Note that this command has no affect if automatic scaling of the Y-axis is enabled. This command is only available for the following result displays:

- EVM vs Carrier
- EVM vs Symbol.
- Frequency error vs Preamble
- Phase error vs Preamble

The numeric suffix at WINDow<1|2> must be 2 as the relevant results are always displayed in screen B. The numeric suffix at TRACe<1...3> must be 1.

Parameter

<numeric_value>

Example

DISP:WIND2:TRAC:Y:SCAL:DPIV 2
Sets the Y scale division to size to 2.

Characteristics

*RST value: 3

Mode

WLAN

DISPlay[:WINDow<1|2>]:TRACe<1...3>:Y[:SCALe]:RLEVel

This remote control command can be used to set the current internal instrument reference level used when performing measurements. The numeric suffix at WINDow<1|2> and TRACe<1...3> are irrelevant.

Parameter

numeric value in dB

Example

DISP:TRAC:Y:RLEV?
returns the current reference level in use

Characteristics

*RST value: -

Mode

WLAN

DISPlay[:WINDow<1|2>]:TRACe<1...3>:Y[:SCALe]:RLEVel:OFFSet

For details refer to "[DISPlay\[:WINDow<1|2>\]:TRACe<1...6>:Y\[:SCALe\]:RLEVel:OFFSet](#)" on page 6.133.

FETCh Subsystem (WLAN, K91 / K91n)

The FETCh subsystem contains commands for reading out results of complex measurement tasks. This subsystem is closely linked to the CONFigure and SENSE subsystems.

Commands of the DISPLAY Subsystem

- FETCh:BURSt:ALL?
- FETCh:BURSt:COUNt?
- FETCh:BURSt:CRESt[:AVERAge?]
- FETCh:BURSt:CRESt:MAXimum?
- FETCh:BURSt:CRESt:MINimum?
- FETCh:BURSt:EVM:[IEEE]:AVERAge?
- FETCh:BURSt:EVM:[IEEE]:MAXimum?
- FETCh:BURSt:EVM:[IEEE]:MINimum?
- FETCh:BURSt:EVM:ALL:AVERAge?
- FETCh:BURSt:EVM:ALL:MAXimum?
- FETCh:BURSt:EVM:ALL:MINimum?
- FETCh:BURSt:EVM:DATA:AVERAge?
- FETCh:BURSt:EVM:DATA:MAXimum?
- FETCh:BURSt:EVM:DATA:MINimum?
- FETCh:BURSt:EVM:DIRect:AVERAge?
- FETCh:BURSt:EVM:DIRect:MAXimum?
- FETCh:BURSt:EVM:DIRect:MINimum?
- FETCh:BURSt:EVM:PILOt:AVERAge?
- FETCh:BURSt:EVM:PILOt:MAXimum?
- FETCh:BURSt:EVM:PILOt:MINimum?
- FETCh:BURSt:FERRor:AVERAge?
- FETCh:BURSt:FERRor:MAXimum?
- FETCh:BURSt:FERRor:MINimum?
- FETCh:BURSt:GIMBalance:AVERAge?
- FETCh:BURSt:GIMBalance:MAXimum?
- FETCh:BURSt:GIMBalance:MINimum?
- FETCh:BURSt:IQOFfset:AVERAge?
- FETCh:BURSt:IQOFfset:MAXimum?
- FETCh:BURSt:IQOFfset:MINimum?
- FETCh:BURSt:PAYLoad?
- FETCh:BURSt:PEAK?
- FETCh:BURSt:PREamble?
- FETCh:BURSt:QUADOffset:AVERAge?

- FETCh:BURSt:QUADOffset:MAXimum?
- FETCh:BURSt:QUADOffset:MINimum?
- FETCh:BURSt:RMS[:AVERage?]
- FETCh:BURSt:RMS:MAXimum?
- FETCh:BURSt:RMS:MINimum?
- FETCh:BURSt:SYMBolerror:AVERage?
- FETCh:BURSt:SYMBolerror:MAXimum?
- FETCh:BURSt:SYMBolerror:MINimum?
- FETCh:BURSt:TFALI:AVERage?
- FETCh:BURSt:TFALI:MAXimum?
- FETCh:BURSt:TFALI:MINimum?
- FETCh:BURSt:TRISe:AVERage?
- FETCh:BURSt:TRISe:MAXimum?
- FETCh:BURSt:TRISe:MINimum?
- FETCh:SYMBol:COUNt?

Further information

- [ASCII formats for returned values](#)

ASCII formats for returned values

The results are output as a list of result strings separated by commas.

Returned values for IEEE 802.11a, j, g(OFDM), n & Turbo Mode

<preamble power>,
 <payload power>,
 <min rms power>,<average rms power>,<max rms power>,<>,
 <peak power>,
 <min crest factor>,<average crest factor>,<max crest factor>,
 <min frequency error>,<average frequency error> , <max frequency error>,
 <min symbol error> , <average symbol error> , <max symbol error>,
 <min IQ offset> , <average IQ offset> , <maximum IQ offset> ,
 <min gain imbalance> , <average gain imbalance> , <max gain imbalance> ,
 <min quadrature offset> , <average quadrature offset> , <max quadrature offset> ,
 <min EVM all bursts> , <average EVM all bursts> , <max EVM all bursts> ,
 <min EVM data carriers> , <average EVM data carriers > , <max EVM data carriers >
 <min EVM pilots> , <average EVM pilots > , <max EVM pilots >

Returned values for IEEE 802.11b & g (CCK)

<min rise time>,<average rise time>,<max rise time>,
 <min fall time>,<average fall time>,<max fall time>,
 <min rms power>,<average rms power>,<max rms power>,<>

<min peak power>, <average peak power>, <max peak power>,
 <min crest factor>, <average crest factor>, <max crest factor>,
 <min frequency error>, <average frequency error>, <max frequency error>,
 <min chip clock error>, <average chip clock error>, <max chip clock error>,
 <min phase error>, <average phase error>, <max phase error>,
 <min IQ offset>, <average IQ offset>, <maximum IQ offset>,
 <min gain imbalance>, <average gain imbalance>, <max gain imbalance>,
 <min quadrature offset>, <average quadrature offset>, <max quadrature offset>,
 <min EVM IIEEE>, <average EVM IIEEE>, <max EVM IIEEE>,
 <min EVM Direct>, <average EVM Direct >, <max EVM Direct >

FETCh:BURSt:ALL?

This command returns all the results. The results are output as a list of result strings separated by commas in ASCII format. For details on the format refer to "[ASCII formats for returned values](#)" on page 6.706. The units for the EVM results are specified with the `UNIT:EVM` command.

Example

```
FETC:BURSt:ALL?
```

All calculated results are returned

Characteristics

*RST value: -

SCPI: device-specific

Mode

WLAN

FETCh:BURSt:COUNT?

This command returns the number of analyzed bursts.

This command is a query only and thus has no *RST value.

Example

```
FETC:BURSt:COUN?
```

The analyzed number of bursts are returned

Characteristics

*RST value: -

SCPI: device-specific

Mode

WLAN

FETCh:BURSt:CRESt[:AVERAge?] / FETCh:BURSt:CRESt:MAXimum? / FETCh:BURSt:CRESt:MINimum?

This command returns the average, minimum or maximum determined CREST factor (= ratio of peak power to average power) in dB.]

This command is a query only and thus has no *RST value.

Example

FETC: BURS: CRES: MAX?

The maximum calculated crest factor from the most recent measurement is returned.

Characteristics

*RST value: -

SCPI: device-specific

Mode

WLAN

FETCh:BURSt:EVM:[IEEE]:AVERAge? / FETCh:BURSt:EVM:[IEEE]:MAXimum? / FETCh:BURSt:EVM:[IEEE]:MINimum?

This command returns the Error Vector Magnitude measurement results summary (average, minimum or maximum value) in dB for the IEEE 802.11b standard. This result is the value before filtering.???

This command is a query only and thus has no *RST value.

Example

FETC: BURS: EVM: MAX?

The maximum EVM recorded before filtering.

Characteristics

*RST value: -

SCPI: device-specific

Mode

WLAN

FETCh:BURSt:EVM:ALL:AVERAge? / FETCh:BURSt:EVM:ALL:MAXimum? / FETCh:BURSt:EVM:ALL:MINimum?

This command returns the Error Vector Magnitude measurement results summary (average, minimum or maximum value) in dB. This is a combined figure that represents the pilot, data and the free carrier.

This command is a query only and thus has no *RST value.

Example

FETC: BURS: EVM: ALL: MAX?

The maximum EVM recorded for all measurement carrier is returned.

Characteristics

*RST value: -

SCPI: device-specific

Mode

WLAN

FETCh:BURSt:EVM:DATA:AVERAge? / FETCh:BURSt:EVM:DATA:MAXimum? / FETCh:BURSt:EVM:DATA:MINimum?

This command returns the Error Vector Magnitude measurement results summary for the data carrier (average, minimum or maximum value) in dB.

This command is a query only and thus has no *RST value.

Example

```
FETC: BURS: EVM: DATA: MAX?
```

The maximum EVM recorded for the data carrier is returned.

Characteristics

*RST value: -

SCPI: device-specific

Mode

WLAN

FETCh:BURSt:EVM:DIRect:AVERAge? / FETCh:BURSt:EVM:DIRect:MAXimum? / FETCh:BURSt:EVM:DIRect:MINimum?

This command returns the Error Vector Magnitude measurement results summary (average, minimum or maximum value) in dB for the IEEE 802.11b standard. This result is the value after filtering.???

This command is a query only and thus has no *RST value.

Example

```
FETC: BURS: EVM: DIR: MAX?
```

The maximum EVM recorded after filtering.

Characteristics

*RST value: -

SCPI: device-specific

Mode

WLAN

FETCh:BURSt:EVM:PILot:AVERAge? / FETCh:BURSt:EVM:PILot:MAXimum? / FETCh:BURSt:EVM:PILot:MINimum?

This command returns the Error Vector Magnitude measurement results summary for the EVM pilot carrier (average, minimum or maximum value) in dB.???

This command is a query only and thus has no *RST value.

Example

```
FETC: BURS: EVM: PIL: MAX?
```

The maximum EVM recorded for the EVM pilot carrier is returned.

Characteristics

*RST value: -

SCPI: device-specific

Mode

WLAN

FETCh:BURSt:FERRor:AVERage? / FETCh:BURSt:FERRor:MAXimum? / FETCh:BURSt:FERRor:MINimum?

This command returns the measured average, minimum or maximum frequency errors in Hertz.???

This command is a query only and thus has no *RST value.

Example

```
FETC: BURS: FERR: MAX?
```

The maximum frequency error from the most recent measurement is returned.

Characteristics

*RST value: -

SCPI: device-specific

Mode

WLAN

FETCh:BURSt:GIMBalance:AVERage? / FETCh:BURSt:GIMBalance:MAXimum? / FETCh:BURSt:GIMBalance:MINimum?

This command returns the measured average, minimum or maximum IQ Imbalance errors in dB.???

This command is a query only and thus has no *RST value.

Example

```
FETC: BURS: GIMB: MAX?
```

The maximum IQ Imbalance error from the most recent measurement is returned.

Characteristics

*RST value: -

SCPI: device-specific

Mode

WLAN

FETCh:BURSt:IQOFfset:AVERage? / FETCh:BURSt:IQOFfset:MAXimum? / FETCh:BURSt:IQOFfset:MINimum?

This command returns the measured average, minimum or maximum IQ Offset errors in dB.???

This command is a query only and thus has no *RST value.

Example

```
FETC: BURS: IQOF: MAX?
```

The maximum IQ Offset error from the most recent measurement is returned.

Characteristics

*RST value: -

SCPI: device-specific

Mode

WLAN

FETCh:BURSt:PAYLoad?

This command returns the measured power in the payload of the burst.
This command is a query only and thus has no *RST value.

Example

```
FETC: BURS: PAYL?
```

The burst payload power is returned

Characteristics

*RST value: -

SCPI: device-specific

Mode

WLAN

FETCh:BURSt:PEAK?

This command returns the Peak power in dBm measured during the measurement time.

Example

```
FETC: BURS: PEAK?
```

The calculated peak power from the most recent measurement is returned.

Characteristics

*RST value: -

SCPI: device-specific

Mode

WLAN

FETCh:BURSt:PREAmble?

This command returns the measured power in the burst preamble.
This command is a query only and thus has no *RST value.

Example

```
FETC: BURS: PRE?
```

The burst preamble power is returned

Characteristics

*RST value: -

SCPI: device-specific

Mode

WLAN

FETCh:BURSt:QUADoffset:AVERAge? / FETCh:BURSt:QUADoffset:MAXimum? / FETCh:BURSt:QUADoffset:MINimum?

This command returns the accuracy in terms of the phase error of symbols within a burst.???

This command is a query only and thus has no *RST value.

Example

```
FETC: BURS: QUAD: MAX?
```

The maximum angle error recorded for a symbol during the measurement.

Characteristics

*RST value: -
 SCPI: device-specific

Mode

WLAN

FETCh:BURSt:RMS[:AVERAge?] / FETCh:BURSt:RMS:MAXimum? / FETCh:BURSt:RMS:MINimum?

This command returns the average, minimum or maximum RMS burst power in dBm measured during the measurement.]

This command is a query only and thus has no *RST value.

Example

FETC : BURSt : RMS : MAX?
 The maximum calculated RSM burst power from the most recent measurement is returned.

Characteristics

*RST value: -
 SCPI: device-specific

Mode

WLAN

FETCh:BURSt:SYMBolerror:AVERAge? / FETCh:BURSt:SYMBolerror:MAXimum? / FETCh:BURSt:SYMBolerror:MINimum?

This command returns the percentage of symbols that were outside permissible de-modulation range within a burst.???

Example

FETC : BURSt : SYMB : MAX?
 The maximum number of symbols that were out of range per burst.

Characteristics

*RST value: -
 SCPI: device-specific

Mode

WLAN

FETCh:BURSt:TFALI:AVERAge? / FETCh:BURSt:TFALI:MAXimum? / FETCh:BURSt:TFALI:MINimum?

This command returns the average, minimum or maximum burst fall time in seconds.

This command is a query only and thus has no *RST value.

Example

FETC : BURSt : TFAL : MAX?
 The maximum calculated fall time from the most recent measurement is returned.

Characteristics

*RST value: -
 SCPI: device-specific

ModeWLAN

FETCh:BURSt:TRISe:AVERAge? / FETCh:BURSt:TRISe:MAXimum? / FETCh:BURSt:TRISe:MINimum?

This command returns the average, minimum or maximum burst rise time in seconds.

This command is a query only and thus has no *RST value.

Example

```
FETC:BURS:TRIS:MAX?
```

The maximum calculated rise time from the most recent measurement is returned.

Characteristics

*RST value: -

SCPI: device-specific

ModeWLAN

FETCh:SYMBol:COUNT?

This command returns the number of symbols for each analyzed burst as a comma separated list.

This command is a query only and thus has no *RST value.

Example

```
FETC:SYMB:COUN?
```

The analyzed number of symbols for each burst are returned

Characteristics

*RST value: -

SCPI: device-specific

ModeWLAN

FORMat Subsystem (WLAN, K91 / K91n)

The FORMat subsystem specifies the data format of the data transmitted from and to the instrument.

Commands of the FORMat Subsystem

- [FORMat\[:DATA\]](#)

FORMat[:DATA]

For details refer to the [FORMat \[: DATA\]](#) command description of the base unit on page 6.135.

INITiate Subsystem (WLAN, K91 / K91n)

The INITiate subsystem configures the instrument prior to a measurement being carried out. It is basically used to tell the instrument which measurement is to be performed and takes any necessary step to set up the instrument for the measurement.

Commands of the INITiate Subsystem

- [INITiate\[:IMMediate\]](#)
- [INITiate:CONTinuous](#)

INITiate[:IMMediate]

For details refer to "[INITiate<1|2>\[:IMMediate\]](#)" on page 6.143.

INITiate:CONTinuous

For details refer to "[INITiate<1|2>:CONTinuous](#)" on page 6.144.

INPut Subsystem (WLAN, K91 / K91n)

The INPut subsystem controls the input characteristics of the RF inputs of the instrument.

Commands of the INPut Subsystem

- [INPut<1|2>:ATTenuation](#)

INPut:ATTenuation

For details refer to "[INPut<1|2>:ATTenuation](#)" on page 6.146.

INSTrument Subsystem (WLAN, K91 / K91n)

The INSTrument subsystem selects the operating mode of the unit either via text parameters or fixed numbers.

Commands of the INSTrument Subsystem

- [INSTrument\[:SElect\]](#)
- [INSTrument:NSElect](#)

INSTrument[:SElect]

Parameter

WLAN (WLAN TX Measurements option, R&S FSL-K91 / K91n)

For further details refer to the INSTrument subsystem of the base unit.

INSTrument:NSElect

Parameter

16 (WLAN TX Measurements option, R&S FSL-K91 / K91n)

For further details refer to the INSTrument subsystem of the base unit.

MMEMory Subsystem (WLAN, K91 / K91n)

The MMEMory (mass memory) subsystem provides commands to store and load IQ data.

Commands of the MMEMory Subsystem

- MMEMory:LOAD:IQ:STATe
- MMEMory:STORE:IQ:STATe

MMEMory:LOAD:IQ:STATe

This command loads the IQ data from the specified .iqw file.

Parameter

1,<file_name>

Example

```
MMEM:LOAD:IQ:STAT 1, 'C:\R_S\Instr\user\data.iqw'
```

Loads IQ data from the specified file.

Characteristics

*RST value: -

SCPI: device-specific

Mode

WLAN

MMEMory:STORE:IQ:STATe

This command stores the IQ data to the specified .iqw file.

Parameter

1,<file_name>

Example

```
MMEM:STOR:IQ:STAT 1, 'C:\R_S\Instr\user\data.iqw'
```

Stores IQ data to the specified file.

Characteristics

*RST value: -

SCPI: device-specific

Mode

WLAN

SENSe Subsystem (WLAN, K91 / K91)

The SENSe command is used to set and get the values of parameters in the remote instrument. The get variant of the SENSe command differs from set in that it takes no parameter values (unless otherwise stated) but is followed by the character '?' and will return the parameter's value in the same format as it is set.

Commands of the SENSe Subsystem

- [SENSe:]BURSt:COUNT
- [SENSe:]BURSt:COUNT:STATe
- [SENSe:]DEMod:BANalyze:DURation:EQUal
- [SENSe:]DEMod:BANalyze:DURation:MAX
- [SENSe:]DEMod:BANalyze:DURation:MIN
- [SENSe:]DEMod:CESTimation
- [SENSe:]DEMod:FILTer:CATalog?
- [SENSe:]DEMod:FILTer:MODulation
- [SENSe:]DEMod:FORMat[:BContent]:AUTo
- [SENSe:]DEMod:FORMat:BANalyze
- [SENSe:]DEMod:FORMat:BANalyze:BTYPe
- [SENSe:]DEMod:FORMat:BANalyze:DBYTes:EQUal
- [SENSe:]DEMod:FORMat:BANalyze:DBYTes:MAX
- [SENSe:]DEMod:FORMat:BANalyze:DBYTes:MIN
- [SENSe:]DEMod:FORMat:BANalyze:SYMBols:EQUal
- [SENSe:]DEMod:FORMat:BANalyze:SYMBols:MAX
- [SENSe:]DEMod:FORMat:BANalyze:SYMBols:MIN
- [SENSe:]DEMod:FORMat:BTRate
- [SENSe:]DEMod:FORMat:SIGSymbol
- [SENSe:]FREQuency:CENTer
- [SENSe:]POWer:ACHannel:MODE
- [SENSe:]SWAPiq
- [SENSe:]SWEep:COUNT
- [SENSe:]SWEep:EGATe
- [SENSe:]SWEep:EGATe:HOLDoff[:TIME]
- [SENSe:]SWEep:EGATe:HOLDoff:SAMPle
- [SENSe:]SWEep:EGATe:LENGth[:TIME]
- [SENSe:]SWEep:EGATe:LENGth:SAMPle
- [SENSe:]SWEep:EGATe:LINK
- [SENSe:]SWEep:TIME
- [SENSe:]TRACKing:LEVel
- [SENSe:]TRACKing:PHASe

– [SENSe:]TRACking:TIME

Further information

– Analysis modulation format

Analysis modulation format

Parameter	Standard	Description
BPSK	Alias for BI	Phase shift keying at higher data rate for selected standard
BPSK3	IEEE 802.11j (10 MHz)	BI Phase shift keying at 3 Mbps
BPSK6	IEEE 802.11a, g (OFDM), j (20 MHz) & Turbo	BI Phase shift keying at 6 Mbps
BPSK9	IEEE 802.11a, g (OFDM), j (20 MHz) & Turbo	BI Phase shift keying at 9 Mbps
BPSK45	IEEE 802.11j (10 MHz)	BI Phase shift keying at 6 Mbps
BPSK65	IEEE 802.11n	BI Phase shift keying at 6.5 Mbps
BPSK72	IEEE 802.11n	BI Phase shift keying at 7.2 Mbps
CCK11	IEEE 802.11b & g (Single Carrier)	Complimentary Code Keying at 11 Mbps
CCK55	IEEE 802.11b & g (Single Carrier)	Complimentary Code Keying at 5.5 Mbps
DBPSK	IEEE 802.11b & g (Single Carrier)	Differential BI Phase shift keying
DQPSK	IEEE 802.11b & g (Single Carrier)	Differential Quadrature phase shift keying
PBCC11	IEEE 802.11b & g (Single Carrier)	PBCC at 11 Mbps
PBCC22	IEEE 802.11g (Single Carrier)	PBCC at 11 Mbps
PBCC55	IEEE 802.11b & g (Single Carrier)	PBCC at 5.5 Mbps
QAM16	Alias for Quadrature Amplitude Modulation at higher data rate for selected standard	
QAM64	Alias for Quadrature Amplitude Modulation at higher data rate for selected standard	
QAM1612	IEEE 802.11j (10 MHz)	Quadrature Amplitude Modulation at 12 Mbps
QAM1618	IEEE 802.11j (10 MHz)	Quadrature Amplitude Modulation at 18 Mbps
QAM1624	IEEE 802.11a, g (OFDM), j (20 MHz) & Turbo	Quadrature Amplitude Modulation at 24 Mbps
QAM1626	IEEE 802.11n	Quadrature Amplitude Modulation at 26 Mbps
QAM1636	IEEE 802.11a, g (OFDM), j (20 MHz) & Turbo	Quadrature Amplitude Modulation at 36 Mbps
QAM1639	IEEE 802.11n	Quadrature Amplitude Modulation at 39 Mbps
QAM6424	IEEE 802.11j (10 MHz)	Quadrature Amplitude Modulation at 24 Mbps
QAM6427	IEEE 802.11j (10 MHz)	Quadrature Amplitude Modulation at 27 Mbps
QAM6448	IEEE 802.11a, g (OFDM), j (20 MHz) & Turbo	Quadrature Amplitude Modulation at 48 Mbps
QAM6452	IEEE 802.11n	Quadrature Amplitude Modulation at 52 Mbps
QAM6454	IEEE 802.11a, g (OFDM), j (20 MHz) & Turbo	Quadrature Amplitude Modulation at 54 Mbps
QAM6465	IEEE 802.11n	Quadrature Amplitude Modulation at 65 Mbps
QAM16289	IEEE 802.11n	Quadrature Amplitude Modulation at 28.9 Mbps
QAM16433	IEEE 802.11n	Quadrature Amplitude Modulation at 43.3 Mbps
QAM64578	IEEE 802.11n	Quadrature Amplitude Modulation at 57.8 Mbps
QAM64585	IEEE 802.11n	Quadrature Amplitude Modulation at 58.5 Mbps
QAM64722	IEEE 802.11n	Quadrature Amplitude Modulation at 72.2 Mbps
QPSK	Alias for Quadrature phase shift keying at higher data rate for selected standard	

Parameter	Standard	Description
QPSK12	IEEE 802.11a, g (OFDM), j (20 MHz) & Turbo	Quadrature phase shift keying at 12 Mbps
QPSK13	IEEE 802.11n	Quadrature phase shift keying at 13 Mbps
QPSK18	IEEE 802.11a, g (OFDM), j (20 MHz) & Turbo	Quadrature phase shift keying at 18 Mbps
QPSK6	IEEE 802.11j (10 MHz)	Quadrature phase shift keying at 6 Mbps
QPSK9	IEEE 802.11j (10 MHz)	Quadrature phase shift keying at 9 Mbps
QPSK144	IEEE 802.11n	Quadrature phase shift keying at 14.4 Mbps
QPSK195	IEEE 802.11n	Quadrature phase shift keying at 19.5 Mbps
QPSK217	IEEE 802.11n	Quadrature phase shift keying at 21.7 Mbps

[SENSe:]BURSt:COUNT

This command defines the number of bursts that will be analyzed by the measurement. This parameter is ignored if the setting for the [\[SENSe:\]BURSt:COUNT:STATe](#) parameter is off.

Parameter

<numeric_value>

Example

```
BURSt:COUN 16
```

Sets the number of bursts to 16.

Characteristics

*RST value: 1

SCPI: device-specific

Mode

WLAN

[SENSe:]BURSt:COUNT:STATe

When this command is set to on, the burst count parameter will be used by the measurement, otherwise the burst count parameter will be ignored.

Parameter

ON | OFF

Example

```
BURSt:COUN:STAT ON
```

Sets the burst count state to ON

Characteristics

*RST value: OFF

SCPI: device-specific

Mode

WLAN

[SENSe:]DEMod:BANalyze:DURation:EQUal

When this command is set to ON then only bursts of equal length will take part in the PVT analysis. When this command is set to true the value specified by the [\[SENSe:\]DEMod:BANalyze:DURation:MIN](#) command specifies the duration that a burst must last in order to take part in measurement analysis.

Parameter

ON | OFF

Example

DEM: BAN: DUR: EQU ON

Only bursts of equal length will take part in the measurement analysis.

Characteristics

*RST value: OFF

SCPI: device-specific

Mode

WLAN

[SENSe:]DEMod:BANalyze:DURation:MAX

This command specifies the maximum duration in microseconds required for bursts to qualify for measurement analysis. Only bursts with the specified duration will be used in the measurement analysis.

This value will not have any immediate effect if the

[\[SENSe:\]DEMod:BANalyze:DURation:EQUal](#) command has been set to true as in this case no range of durations is allowed and only bursts with exactly the duration specified by the [\[SENSe:\]DEMod:BANalyze:DURation:MIN](#) command shall take part in measurement analysis

Parameter

<numeric_value>

Example

DEM: BAN: DUR: MAX 1300

Only bursts which have a maximum duration of 1300 microseconds are analyzed.

Characteristics

*RST value: 5464

SCPI: device-specific

Mode

WLAN

[SENSe:]DEMod:BANalyze:DURation:MIN

This command specifies the duration in microseconds required for bursts to qualify for measurement analysis. Only bursts with the specified duration will be used in the measurement analysis. When the [\[SENSe:\]DEMod:BANalyze:DURation:EQUal](#) command has been set to true then this command specifies the exact duration required for a burst to take part in measurement analysis. When the [\[SENSe:\]DEMod:FORMat:BANalyze:DBYTes:EQUal](#) command is set to false this command specifies the minimum duration required for a burst to take part in measurement analysis.

Parameter

<numeric_value>

Example

DEM: BAN: DUR: MIN 45

Only bursts which last 48 microseconds are analyzed.

Characteristics

*RST value: 1

SCPI: device-specific

Mode

WLAN

[SENSe:]DEMod:CESTimation

This command defines whether channel estimation will be done in preamble and payload (if set to 1) or only in preamble (if set to 0). The effect of this is most noticeable for the EVM measurement results, where the results will be improved when this feature is enabled.

However, this functionality is not supported by the IEEE 802.11 standard and must be disabled if the results are to be strictly measured against the standard.

Parameter

ON | OFF

Example

```
DEMod:CEST ON
```

Specifies that the IQ measurement results will use channel estimation in preamble & payload.

Characteristics

*RST value: OFF

SCPI: device-specific

Mode

WLAN

[SENSe:]DEMod:FILTer:CATalog?

This command reads the names of all available filters. The file names are output without file extension. Syntax of output format: filter_1,filter_2, ... ,filter_n.

This command is a query only and thus has no *RST value.

Example

```
DEMod:FILT:CAT?
```

Reads all filter names

Characteristics

*RST value: 0

SCPI: device-specific

Mode

WLAN

[SENSe:]DEMod:FILTer:MODulation

This command selects the TX and RX filters. The names of the filters correspond to the file names; a query of all available filters is possible by means of the

[\[SENSe:\]DEMod:FILTer:CATalog?](#) command.

Parameter

<string>,<string>

DEF_TX: default transmit filter, DEF_RX: default receive filter

Example

```
DEM:FILT:MOD 'DEF_TX','DEF_RX'
```

DEF_TX is selected for the TX filter and DEF_RX for the RX filter

Characteristics

*RST value: AUTO,AUTO

SCPI: device-specific

Mode

WLAN

[SENSe:]DEMod:FORMat[:BContent]:AUTO

When this command is set to ON then the signal symbol field of the burst is analyzed to determine the modulation scheme of the first burst. When this field is set to ON only bursts which match the modulation scheme are considered in results analysis.

Parameter

ON | OFF

Example

```
DEM:FORM:AUT ON
```

Specifies that the signal symbol field should be decoded.

Characteristics

*RST value: -

SCPI: device-specific

Mode

WLAN

[SENSe:]DEMod:FORMat:BANalyze

The remote control command sets the analysis modulation format that will be assumed when the measurement is performed. If the [SENSe:]DEMod:FORMat:SIGSymbol parameter has been set to ON, this command can be used to measure only certain burst types within a measurement sequence.

Parameter

For details refer to "[Analysis modulation format](#)" on page 6.720.

Example

```
DEM:FORM:BAN 'QAM16'
```

Only bursts that are of the QAM16 modulation format are analyzed.

Characteristics

*RST value: QAM64

SCPI: device-specific

Mode

WLAN

[SENSe:]DEMod:FORMat:BANalyze:BTYPe

This remote control command specifies the type of burst to be analyzed. Only bursts of the specified type take part in measurement analysis.

Parameter

DIRECT	IEEE 802.11a, IEEE 802.11j (10MHz), IEEE 802.11j (20MHz), IEEE 802.11g, 802.11 OFDM Turbo - Direct Link Burst
LONG-OFDM	IEEE 802.11g - Long DSSS OFDM
SHORT-OFDM	IEEE 802.11g - Short DSSS OFDM
LONG	IEEE 802.11b, IEEE 802.11g - Long PLCP Burst
SHORT	IEEE 802.11b, IEEE 802.11g - Short PLCP Burst
MM20	IEEE 802.11n Mixed Mode 20 MHz sampling rate
GFM20	IEEE 802.11n Greenfield Mode 20 MHz sampling rate

Example

```
DEM:FORM:BAN:BTYPe 'DIRECT'
```

Only DIRECT bursts are analyzed.

Characteristics

*RST value: DIRECT
SCPI: device-specific

Mode

WLAN

[SENSe:]DEMod:FORMat:BANalyze:DBYTes:EQUal

When this command is set to ON then only bursts of equal length will take part in the measurement analysis. The number of data bytes that a burst must have in order to take part in measurement analysis is specified by the [\[SENSe:\]DEMod:FORMat:BANalyze:DBYTes:MIN](#) command.

Parameter

ON | OFF

Example

```
DEM:FORM:BAN:DBYTes:EQU ON
```

Only bursts of equal length will take part in the measurement analysis.

Characteristics

*RST value: OFF
SCPI: device-specific

Mode

WLAN

[SENSe:]DEMod:FORMat:BANalyze:DBYTes:MAX

This command specifies the maximum number of data bytes required for bursts to qualify for measurement analysis. Only bursts with the specified number of data bytes will be used in the measurement analysis.

This value will not have any immediate effect if the

[SENSe:]DEMod:FORMat:BANalyze:DBYTes:EQUal command has been set to ON. In this case, no range of symbols is allowed and only bursts with exactly the number of data bytes specified by the [SENSe:]DEMod:FORMat:BANalyze:DBYTes:MIN command shall take part in measurement analysis.

Parameter

<numeric_value>

Example

```
DEM:FORM:BAN:DBYTes:MAX 1300
```

Only bursts which contain a maximum of 1300 data bytes are analyzed.

Characteristics

*RST value: 64

SCPI: device-specific

Mode

WLAN

[SENSe:]DEMod:FORMat:BANalyze:DBYTes:MIN

This command specifies the number of data bytes required for bursts to qualify for measurement analysis. Only bursts with the specified number of data bytes will be used in the measurement analysis.

If the [SENSe:]DEMod:FORMat:BANalyze:DBYTes:EQUal command has been set to ON, this command specifies the exact number of data bytes required for a burst to take part in measurement analysis. If the [SENSe:]DEMod:FORMat:BANalyze:DBYTes:EQUal command is set to OFF, this command specifies the minimum number of data bytes required for a burst to take part in measurement analysis.

Parameter

<numeric_value>

Example

```
DEM:FORM:BAN:DBYTes:MIN 16
```

Only bursts which contain 16 data bytes are analyzed.

Characteristics

*RST value: 1

SCPI: device-specific

Mode

WLAN

[SENSe:]DEMod:FORMat:BANalyze:SYMBols:EQUal

When this command is activated then only bursts of equal length will take part in the measurement analysis. When this command is set to true the value specified by the [SENSe:]DEMod:FORMat:BANalyze:SYMBols:MIN command specifies the number of symbols that a burst must have in order to take part in analysis.

Parameter

ON | OFF

Example

DEM:FORM:BAN:SYM:EQU ON

Only bursts of equal length will take part in analysis.

Characteristics

*RST value: OFF

SCPI: device-specific

Mode

WLAN

[SENSe:]DEMod:FORMat:BANalyze:SYMBOLs:MAX

This command specifies the maximum number of data symbols required for bursts to qualify for measurement analysis. Only bursts with the specified number of symbols will be used in the measurement analysis. The number of data symbols is defined as the uncoded bits including service and tail bits.

This value will not have any immediate effect if the

[\[SENSe:\]DEMod:FORMat:BANalyze:SYMBOLs:EQUal](#) command has been set to true as in this case no range of symbols is allowed and only bursts with exactly the number of symbols specified by the [\[SENSe:\]DEMod:FORMat:BANalyze:SYMBOLs:MIN](#) command shall take place in measurement analysis.

Parameter

<numeric_value>

Example

DEM:FORM:BAN:SYM:MAX 1300

Only bursts which contain a maximum symbol count of 1300 are analyzed.

Characteristics

*RST value: 64

SCPI: device-specific

Mode

WLAN

[SENSe:]DEMod:FORMat:BANalyze:SYMBOLs:MIN

This command specifies the number of data symbols required for bursts to qualify for measurement analysis. Only bursts with the specified number of symbols will be used in the measurement analysis. The number of data symbols is defined as the uncoded bits including service and tail bits.

When the [\[SENSe:\]DEMod:FORMat:BANalyze:SYMBOLs:EQUal](#) command has been set to true then this command specifies the exact number of symbols required for a burst to take part in measurement analysis. When the [\[SENSe:\]DEMod:FORMat:BANalyze:SYMBOLs:EQUal](#) command is set to false this command specifies the minimum number of symbols required for a burst to take part in measurement analysis.

Parameter

<numeric_value>

Example

```
DEM:FORM:BAN:SYM:MIN 16
```

Only bursts which contain a symbol count of 16 are analyzed.

Characteristics

*RST value: 1

SCPI: device-specific

Mode

WLAN

[SENSe:]DEMod:FORMat:BTRate

The remote control command is used to specify the bit rate for IEEE 802.11b signals. This command can be used as an alternative to [\[SENSe:\]DEMod:FORMat:BANalyze](#). The bit rate can be set as follows:

Parameter

10	1 Mbit/s
20	2 Mbit/s
55	5.5 Mbit/s
110	11 Mbit/s

Example

```
DEM:FORM:BTR 20
```

Configures to demodulate 2 Mbit/s signals

Characteristics

*RST value: 10 (= 1mbit)

SCPI: device-specific

Mode

WLAN

[SENSe:]DEMod:FORMat:SIGSymbol

If this command is set to ON, the signal symbol field of the burst is analyzed to determine the details of the burst. Only burst which match the supplied burst type and modulation are considered in results analysis. For IEEE 802.11b this command can only be queried as the decoding of the signal field is always performed for the IEEE 802.11b standard.

Parameter

ON | OFF

Example

```
DEM:FORM:SIGS ON
```

Specifies that the signal symbol field should be decoded.

Characteristics

*RST value: -

SCPI: device-specific

Mode

WLAN

[SENSe:]FREQuency:CENTer

For details refer to "[SENSe<1|2>:]FREQuency:CENTer" on page 6.194.

[SENSe:]POWer:ACHannel:MODE

This command sets the ACP measurement mode for the IEEE 802.11j standard to either absolute or relative.

Parameter

ABS Absolute measurement
REL Relative measurement

Example

```
POW:ACH:MODE ABS
```

Sets the ACP measurement to absolute mode

Characteristics

*RST value: REL
SCPI: device-specific

Mode

WLAN

[SENSe:]SWAPiq

This command defines whether or not the recorded IQ pairs should be swapped (I<->Q) before being processed.

Parameter

ON | OFF

Example

```
SWAP ON
```

Specifies that IQ values should be swapped.

Characteristics

*RST value: OFF
SCPI: device-specific

Mode

WLAN

[SENSe:]SWEep:COUNT

This command specifies the number of sweeps for Spectrum Mask and Spectrum ACPR measurements.

Parameter

<numeric_value>

Example

```
SWEep:COUNT 64
```

Sets the number of sweeps to 64.

Characteristics

*RST value: 1

SCPI: conform

Mode

WLAN

[SENSe:]SWEep:EGATe

For details refer to "[SENSe<1|2>:]SWEep:EGATe" on page 6.224.

[SENSe:]SWEep:EGATe:HOLDoff[:TIME]

This command defines the gate delay in the capture buffer in time units. The range of this value is dependent on the last run measurement.

Parameter

<numeric_value>

Example

```
SWE:EGAT:HOLD 125us
```

Sets a delay of 125µs in the capture buffer.

Characteristics

*RST value: 100µs

SCPI: device-specific

Mode

WLAN

[SENSe:]SWEep:EGATe:HOLDoff:SAMPle

This command defines the gate delay in the capture buffer as a number of samples. The range of this value is dependent on the last run measurement.

Parameter

<numeric_value>

Example

```
SWE:EGAT:HOLD:SAMP 2500
```

Sets a delay of 2500 samples in the capture buffer.

Characteristics

*RST value: 2000

SCPI: device-specific

Mode

WLAN

[SENSe:]SWEep:EGATe:LENGth[:TIME]

This command defines the gate time in the capture buffer in time units. The range of this value is dependent on the last run measurement.

Parameter

<numeric_value>

Example

```
SWE:EGAT:LENG 20ms
```

Sets a gate length of 20 milliseconds between sweeps.

Characteristics

*RST value: 400µs

SCPI: device-specific

Mode

WLAN

[SENSe:]SWEep:EGATe:LENGth:SAMPle

This command defines the gate time in the capture buffer as a number of samples. The range of this value is dependent on the last run measurement.

Parameter

<numeric_value>

Example

```
SWE:EGAT:LENG:SAMP 200000
```

Sets a gate length of 200000 samples in the capture buffer.

Characteristics

*RST value: 8000

SCPI: device-specific

Mode

WLAN

[SENSe:]SWEep:EGATe:LINK

This command links together the movement of the gating lines and the capture buffer marker.

Parameter

ON | OFF

Example

```
SWE:EGAT:LINK ON
```

Links the gating lines as marker with the gating line delay and length are changed gate position.

Characteristics

*RST value: 0

SCPI: device-specific

Mode

WLAN

[SENSe:]SWEep:TIME

The RST value for the WLAN TX Measurements option (K91 / K91n) is 1 ms.
For further details refer to "[SENSe<1|2>:]SWEep:TIME" on page 6.227.

[SENSe:]TRACking:LEVel

This command defines whether or not the measurement results should be compensated for level.

Parameter

ON | OFF

Example

TRAC:LEV ON

Specifies that the measurement results should be compensated for level.

Characteristics

*RST value: OFF

SCPI: device-specific

Mode

WLAN

[SENSe:]TRACking:PHASe

This command defines whether or not the measurement results should be compensated for phase.

Parameter

ON | OFF

Example

TRAC:PHAS ON

Specifies that the measurement results should be compensated for phase.

Characteristics

*RST value: ON

SCPI: device-specific

Mode

WLAN

[SENSe:]TRACking:TIME

This command defines whether or not the measurement results should be compensated for time.

Parameter

ON | OFF

Example

TRAC:TIME ON

Specifies that the measurement results should be compensated for time.

Characteristics

*RST value: OFF

SCPI: device-specific

Mode

WLAN

STATus Subsystem (WLAN, K91 / K91n)

The STATus subsystem contains the commands for the status reporting system (for details refer to chapter 5 "Remote Control - Basics"). For the STATus:QUESTionable:LIMit register, the measurement window is selected by LIMit 1 (screen A) or 2 (screen B). *RST does not influence the status registers.

Commands of the STATus Subsystem

- STATus:QUESTionable:ACPLimit[:EVENT]?
- STATus:QUESTionable:ACPLimit:CONDition?
- STATus:QUESTionable:ACPLimit:ENABle
- STATus:QUESTionable:ACPLimit:PTRansition
- STATus:QUESTionable:ACPLimit:NTRansition
- STATus:QUESTionable:LIMit<1|2> [:EVENT]?
- STATus:QUESTionable:LIMit<1|2>:CONDition?
- STATus:QUESTionable:LIMit<1|2>:ENABle
- STATus:QUESTionable:LIMit<1|2>:PTRansition
- STATus:QUESTionable:LIMit<1|2>:NTRansition
- STATus:QUESTionable:POWer[:EVENT]?
- STATus:QUESTionable:POWer:CONDition?
- STATus:QUESTionable:POWer:ENABle
- STATus:QUESTionable:POWer:PTRansition
- STATus:QUESTionable:POWer:NTRansition
- STATus:QUESTionable:SYNC[:EVENT]?
- STATus:QUESTionable:SYNC:CONDition?
- STATus:QUESTionable:SYNC:ENABle
- STATus:QUESTionable:SYNC:PTRansition
- STATus:QUESTionable:SYNC:NTRansition

STATus:QUESTionable:ACPLimit[:EVENT]?

For details refer to "[STATus:QUESTionable:ACPLimit\[:EVENT\]?](#)" on page 6.236.

STATus:QUESTionable:ACPLimit:CONDition?

For details refer to "[STATus:QUESTionable:ACPLimit:CONDition?](#)" on page 6.236.

STATus:QUESTionable:ACPLimit:ENABle

For details refer to "[STATus:QUESTionable:ACPLimit:ENABle](#)" on page 6.236.

STATus:QUEStionable:ACPLimit:PTRansition

For details refer to "[STATus:QUEStionable:LIMit<1|2>:PTRansition](#)" on page 6.240.

STATus:QUEStionable:ACPLimit:NTRansition

For details refer to "[STATus:QUEStionable:ACPLimit:NTRansition](#)" on page 6.237.

STATus:QUEStionable:LIMit<1|2> [:EVENT]?

For details refer to "[STATus:QUEStionable:LIMit<1|2>\[:EVENT\]?](#)" on page 6.239.

STATus:QUEStionable:LIMit<1|2>:CONDition?

For details refer to "[STATus:QUEStionable:LIMit<1|2>:CONDition?](#)" on page 6.239.

STATus:QUEStionable:LIMit<1|2>:ENABLE

For details refer to "[STATus:QUEStionable:LIMit<1|2>:ENABLE](#)" on page 6.240.

STATus:QUEStionable:LIMit<1|2>:PTRansition

For details refer to "[STATus:QUEStionable:LIMit<1|2>:PTRansition](#)" on page 6.240.

STATus:QUEStionable:LIMit<1|2>:NTRansition

For details refer to "[STATus:QUEStionable:LIMit<1|2>:NTRansition](#)" on page 6.240.

STATus:QUEStionable:POWER[:EVENT]?

For details refer to "[STATus:QUEStionable:POWER\[:EVENT\]?](#)" on page 6.242.

STATus:QUEStionable:POWER:CONDition?

For details refer to "[STATus:QUEStionable:POWER:CONDition?](#)" on page 6.242.

STATus:QUEStionable:POWER:ENABLE

For details refer to "[STATus:QUEStionable:POWER:ENABLE](#)" on page 6.243.

STATus:QUEStionable:POWER:PTRansition

For details refer to "[STATus:QUEStionable:POWER:PTRansition](#)" on page 6.243.

STATus:QUEStionable:POWer:NTRansition

For details refer to "[STATus:QUEStionable:POWer:NTRansition](#)" on page 6.243.

STATus:QUEStionable:SYNC[:EVENT]?

This command queries the contents of the EVENT section of the STATus:QUEStionable:SYNC register. Readout does not delete the contents of the EVENT section.

Example

```
STAT:QUES:SYNC?
```

Characteristics

*RST value: -

SCPI: device-specific

Mode

WLAN

STATus:QUEStionable:SYNC:CONDition?

This command queries the contents of the CONDition section of the STATus:QUEStionable:SYNC register. Readout does not delete the contents of the CONDition section.

Example

```
STAT:QUES:SYNC:COND?
```

Characteristics

*RST value: -

SCPI: conform

Mode

WLAN

STATus:QUEStionable:SYNC:ENABle

This command sets the bits of the ENABle section of the STATus:QUEStionable:SYNC register. The ENABle register selectively enables the individual events of the associated EVENT section for the summary bit.

Parameter

0 to 65535

Example

```
STAT:QUES:SYNC:ENAB 65535
```

All events bits will be represented in the SYNC summary bit.

Characteristics

*RST value: -

SCPI: device-specific

Mode

WLAN

STATus:QUEStionable:SYNC:PTRansition

This command determines what bits in the STATus:QUEStionable:SYNC Condition register will set the corresponding bit in the STATus:QUEStionable:SYNC Event register when that bit has a positive transition (0 to 1). The variable <number> is the sum of the decimal values of the bits that are to be enabled.

Parameter

0 to 65535

Example

```
STAT:QUES:SYNC:PTR 65535
```

All condition bits will be summarized in the Event register when a positive transition occurs.

Characteristics

*RST value: -

SCPI: device-specific

Mode

WLAN

STATus:QUEStionable:SYNC:NTRansition

This command determines what bits in the STATus:QUEStionable:SYNC Condition will set the corresponding bit in the STATus:QUEStionable:SYNC Event register when that bit has a negative transition (1 to 0). The variable <number> is the sum of the decimal values of the bits that are to be enabled.

Parameter

0 to 65535

Example

```
STAT:QUES:SYNC:NTR 65535 -
```

All condition bits will be summarized in the Event register when a positive transition occurs.

Characteristics

*RST value: -

SCPI: device-specific

Mode

WLAN

TRACe Subsystem (WLAN, K91 / K91n)

The TRACe subsystem controls access to the instrument's internal trace memory.

Commands of the TRACe Subsystem

- TRACe[:DATA]
- TRACe:IQ:DATA:MEMory?
- TRACe:IQ:SRATe

Further information

- IQ Measurements
- Constellation vs Symbol
- Constellation vs Carrier
- Power vs Time - Full Burst and Rising /Falling Data
- Spectrum Flatness
- Spectrum FFT
- Statistics Bitstream data
- Statistics CCDF - Complementary cumulative distribution function
- Statistics Signal Field data
- EVM vs Carrier
- EVM vs Symbol
- Error vs Preamble
- Frequency Sweep Measurements
- Spectrum Mask
- Spectrum ACPR

IQ Measurements

There are a number of measurements that can be performed in IQ mode. No data will be returned for any of the following measurements, should it be requested, until such time as a measurement belonging to the IQ group has been previously run.

Running a frequency sweep measurement for example, Spectrum Mask, will not generate results for this measurement group.

Constellation vs Symbol

This measurement represents I and Q data. For IEEE 802.11a, j and n the data will be returned as a repeating array of interleaved I and Q data in groups of selected carriers, until all the data is exhausted. For IEEE 802.11b the data will be returned as a repeating array of interleaved I and Q data in symbol order until all the data is exhausted.

Each I and Q point will be returned in floating point format. TRACE1 is used for this measurement results.

IEEE 802.11a, j and n only

- If "All Carriers" is selected, it will return 52 per of I and Q data per symbol.
- If "Pilots Only" is selected, it will return 4 per of I and Q per symbol in the following order: Carrier - 21, Carrier -7, Carrier 7, Carrier 21.
- If a single carrier is selected, it will return 1 per of I and Q data per symbol.

Constellation vs Carrier

This measurement represents I and Q data. Data will be returned as a repeating array of interleaved I and Q data in groups of 53 channels including the channel 0, until all the data is exhausted.

Each I and Q point will be returned in floating point format. TRACE1 is used for this measurement results.

Power vs Time - Full Burst and Rising /Falling Data

Both measurement results are once again simply slightly different views of the same results data.

All fully complete bursts within the capture time are analyzed into three master bursts. The three master bursts relate to the minimum, maximum and average values across all complete bursts. This data is returned in dBm values to the user on a per sample basis. Each sample will in some way relate to an analysis of each corresponding sample within each processed burst.

The type of PVT data returned will be determined by the TRACE number passed as an argument to the SCPI command, in addition to the graphic type that is selected.

If the graphic type selected is full burst, then the return data is as follows.

TRACE1	full burst, minimum burst data values
TRACE2	full burst, mean burst data values
TRACE3	full burst, maximum burst data values

If the graphic type selected is EDGe, then the return data is as follows.

TRACE1	rising edge, minimum burst data values
TRACE2	rising edge, mean burst data values
TRACE3	rising edge, maximum burst data values
TRACE4	falling edge, minimum burst data values
TRACE5	falling edge, mean burst data values
TRACE6	falling edge, maximum burst data values

For IEEE 802.11b only

- If the graphic type selected is RISing or FALLing then only 3 traces are available (1 to 3) and represent the minimum, mean and maximum bursts data for the respective graph selection.
- The number of samples returned during full burst analysis will depend on the modulation type and will typically be 5000.
- The number of samples returned when the rising and falling graphic type is selected will be less than what is returned for full burst and will be approximately 400 samples.
- The samples will be returned in floating point format as a single sequence of comma delimited values.

Spectrum Flatness

There are four separate traces that are available with this measurement. Trace data for a particular trace will only be returnable by querying the appropriate trace

Spectrum flatness provides two basic graph types. These are an absolute power value graph (ABS) and a relative group delay graph, which are both plotted on a per carrier basis. All 52 carriers are drawn, in addition to the unused 0 carrier. Both the absolute power and group delay graph groups will allow all the data points to be returned as one trace and an average of all the channels as the other trace.

E.g. the return data will either be one single group of 53 carriers if the average trace is selected or a repeating group of 53 carriers if all the data is requested.

TRACE1	ABS	(all analyzed trains)
TRACE2	Group Delay	(all analyzed trains)
TRACE3	ABS	(average trace)
TRACE4	Group Delay	(average trace)

Absolute power results are returned in dB and group delay results are returned in ns.

Spectrum FFT

All FFT points will be returned if the data for this measurement is requested. This will be an exhaustive call, due to the fact that there are nearly always more FFT points than IQ samples. The number of FFT points is the number presented by a power of 2 that is higher than the total number of samples.

E.g. if there were 20000 samples, then 32768 FFT points would be returned.

Data will be returned in floating point format in dBm. TRACE1 is used for this measurement results.

Statistics Bitstream data

IEEE 802.11a & j only

Data will be returned in repeating groups of 52 data channels where each symbol value will be represented by an integer value within one byte. Channel 0 is unused and will therefore not have any data associated with it, with no return data being provided.

The number of repeating groups that are returned will be equal to the number of measured symbols.

Currently, 64QAM has the highest data rate and it contains symbol values up to 63, making the proposal of one byte sufficient in size to represent all symbol data values, regardless of the modulation type in use.

Data will be returned in ASCII printable hexadecimal character format. TRACE1 is used for this measurement results.

IEEE 802.11b only

Data will be returned in burst order. Each burst will be represented as a series of bytes. For each burst the first 9 or 18 bytes represents the PLCP Preamble for Short and Long burst types respectively. The next 6 bytes represents the PLCP Header. The remaining bytes represent the PSDU.

Data will be returned in ASCII printable hexadecimal character format. TRACE1 is used for this measurement results.

Statistics CCDF - Complementary cumulative distribution function

Up to a maximum of 201 data points will be returned in addition to a data count value. The first value in the return data will represent the quantity of probability values that follow. Each of the potential 201 data points will be returned as probability value and will represent the total number of samples that are equal to or exceed the corresponding power level. Probability data will be returned up to the power level that contains at least one sample. It is highly unlikely that the full 201 data values will ever be returned.

Each probability value will be returned as a floating point number, with a value less than 1.

Statistics Signal Field data

IEEE 802.11a, j and n only

Data will be returned as an array of hexadecimal values, with each hexadecimal value representing the 24 bit long signal field for a single burst.

IEEE 802.11b only

Data will be returned as an array of hexadecimal values, with each hexadecimal value representing the 48 bit long signal field for a single burst

EVM vs Carrier

Two trace types are provided with this measurement. There is an average EVM value for each of the 53 channels or a repeating group of EVM values for each channel. The number of repeating groups will correspond to the number of fully analyzed trains.

Each EVM value will be returned as a floating point number, expressed in units of dBm.

TRACE1 Average EVM values per channel

TRACE2 All EVM values per channel for each full train of the capture period

EVM vs Symbol

Three traces types are available with this measurement. The basic trace types show either the minimum, mean or maximum EVM value, as measured over the complete capture period.

The number of repeating groups that are returned will be equal to the number of measured symbols.

Each EVM value will be returned as a floating point number, expressed in units of dBm.

IEEE 802.11a, j and n only

TRACE1 Minimum EVM values

TRACE2 Mean EVM values

TRACE3 Maximum EVM values

IEEE 802.11b only

TRACE1 EVM IEEE values

TRACE2 EVM Direct values

Error vs Preamble

Three traces types are available with this measurement. The basic trace types show either the minimum, mean or maximum frequency or phase value as measured over the preamble part of the burst.

Frequency Sweep Measurements

No data will be returned for this type of measurement, should it be requested, until such time as a measurement has been previously run.

Running an IQ measurement will not generate results for this type of measurement.

Spectrum Mask

Result data will be returned as 501 measurement points in floating point format. These trace points are obtained directly from the base system via the measurement API and the quantity is therefore a fixed value. Only an array of Y data will be returned. TRACE1 is used for this measurement results.

Spectrum ACPR

Result data will be returned as 501 measurement points in floating point format. These trace points are obtained directly from the base system via the measurement API and the quantity is therefore a fixed value. Only an array of Y data will be returned. TRACE1 is used for this measurement results.

TRACe[:DATA]

This command returns all the measured data that relates to the currently selected measurement type. All results are returned in ASCII format. The returned data depends on the currently selected measurement type. `DISPlay:FORMat` is not supported with this command.

The following measurement types are available:

- "IQ Measurements" on page 6.738
- "Constellation vs Symbol" on page 6.738
- "Constellation vs Carrier" on page 6.739
- "Power vs Time - Full Burst and Rising /Falling Data" on page 6.739
- "Spectrum Flatness" on page 6.740
- "Spectrum FFT" on page 6.740
- "Statistics Bitstream data" on page 6.740
- "Statistics CCDF - Complementary cumulative distribution function" on page 6.740
- "Statistics Signal Field data" on page 6.741
- "EVM vs Carrier" on page 6.741
- "EVM vs Symbol" on page 6.741
- "Error vs Preamble" on page 6.741
- "Frequency Sweep Measurements" on page 6.741
- "Spectrum Mask" on page 6.742
- "Spectrum ACPR" on page 6.742

This command is a query only and thus has no *RST value.

Parameter

TRACE1 | TRACE2 | TRACE3 | TRACE4 | TRACE5 | TRACE6

Example

```
TRAC? TRACE2
```

The measurement data for the selected graph is returned.

Characteristics

*RST value: -

SCPI: conform

Mode

WLAN

TRACe:IQ:DATA:MEMory?

For details refer to "[TRACe<1|2>:IQ:DATA:MEMory?](#)" on page 6.266.

TRACe:IQ:SRATe

This command allows the sample rate for IQ measurements to be specified.

Example

```
TRACe:IQ:SRAT 20000
```

Specifies a sample rate of 20 MHz.

Characteristics

*RST value: -

SCPI: device-specific

Mode

WLAN

TRIGger Subsystem (WLAN, K91 / K91n)

The trigger subsystem is used to synchronize device action(s) with events.

Commands of the TRIGger Subsystem

- TRIGger[:SEquence]:HOLDoff
- TRIGger[:SEquence]:MODE
- TRIGger[:SEquence]:LEVel:POWer
- TRIGger[:SEquence]:LEVel:POWer:AUTO

TRIGger[:SEquence]:HOLDoff

This command defines the length of the trigger delay. A negative delay time (pretrigger) can be set.

Parameter

<numeric_value>

Example

```
TRIG:HOLD 500us
```

Configures to use a holdoff period of 500 μ s after the trigger condition has been met.

Characteristics

*RST value: -10 μ s

SCPI: Conform

Mode

WLAN

TRIGger[:SEquence]:MODE

This command configures how triggering is to be performed.

Parameter

IMMediate	automatically triggers the next measurement at the end of the previous measurement. This corresponds to the FREE RUN setting.
EXTernal	the next measurement is triggered by the signal at the external trigger input e.g. a gated trigger
POWer	triggering of the measurement via signals which are the measurement channel.

Example

```
TRIG:MODE IMM
```

AUTO triggering will occur for the next measurement at the specified video percentage value.

Characteristics

*RST value: IMMediate

SCPI: device-specific

Mode

WLAN

TRIGger[:SEQuence]:LEVel:POWer

This command accepts the level of the input signal for which triggering will occur.

Parameter

<numeric_value>

Example

```
TRIG:LEV:POW 10 DBM
```

Set to 10 dBm for RF measurement.

Characteristics

*RST value: 0 DBM

SCPI: device-specific

Mode

WLAN

TRIGger[:SEQuence]:LEVel:POWer:AUTO

This command specifies whether or not an automatic power trigger level calculation is performed before each main measurement. The setting of this command is ignored if the setting for the `TRIGger[:SEQuence]:MODE` command is not POWER.

Parameter

ON | OFF

Example

```
TRIG:LEV:POW:AUTO ON
```

Specifies that an automatic power trigger level calculation should be performed before the start of each main measurement.

Characteristics

*RST value: OFF

SCPI: device-specific

Mode

WLAN

UNIT Subsystem (WLAN, K91 / K91n)

The unit subsystem specifies the units for specific result types.

Commands of the UNIT Subsystem

- UNIT:EVM
- UNIT:GIMBalance
- UNIT:PREamble

UNIT:EVM

This command specifies the units for EVM results.

Parameter

DB EVM results returned in dB
PCT EVM results returned in %

Example

```
UNIT:EVM PCT  
EVM results to be returned in %.
```

Characteristics

*RST value: DB
SCPI: device-specific

Mode

WLAN

UNIT:GIMBalance

This command specifies the units for Gain Imbalance results.

Parameter

DB Gain Imbalance results returned in dB
PCT Gain Imbalance results returned in %

Example

```
UNIT:GIMB PCT  
Gain Imbalance results to be returned in %.
```

Characteristics

*RST value: DB
SCPI: device-specific

Mode

WLAN

UNIT:PREamble

This command specifies the units for Preamble error results.

Parameter

HZ Preamble error results returned in Hz

PCT Preamble error results returned in %

Example

UNIT:PRE PCT

Preamble error results to be returned in %.

Characteristics

*RST value: DB

SCPI: device-specific

Mode

WLAN

Remote Commands of the WiMAX, WiBro Measurements Option (K92/K93)

This section describes the remote commands for the WiMAX IEEE 802.16 OFDM, OFDMA Measurements option (R&S FSL-K93). This option includes the functionality of the WiMAX 802.16 OFDM Measurements option (R&S FSL-K92). Accordingly both options are described together in this section, differentiated by the corresponding standards:

- WiMAX 802.16 OFDM Measurements (R&S FSL-K92/K93)
 - IEEE 802.16-2004/Cor 1-2005 OFDM physical layer mode
The corresponding remote control mode is *OFDM*. In chapter "Instrument Functions", the short form *IEEE 802.16-2004 OFDM* is used to reference this standard.
- WiMAX IEEE 802.16 OFDM, OFDMA Measurements option (R&S FSL-K93)
 - IEEE 802.16-2004/Cor 1-2005, IEEE 802.16e-2005 OFDMA physical layer mode
The corresponding remote control mode is *OFDMA*. In chapter "Instrument Functions", the short form *IEEE 802.16e-2005 OFDMA* is used to reference this standard.
 - IEEE 802.16-2004/Cor 1-2005, IEEE 802.16e-2005 based WiBro
The corresponding remote control mode is *WiBro*. In chapter "Instrument Functions", the short form *IEEE 802.16e-2005 WiBro* is used to reference this standard.

For details on conventions used in this chapter refer to section "Notation" on page 6.2 at the beginning of this chapter.

For further information on analyzer or basic settings commands, refer to the corresponding subsystem in section "Remote Commands of the Base Unit" on page 6.5.

The options are available from firmware version 1.40 (R&S FSL-K92) and 1.50 (R&S FSL-K93).

Subsystems of the WiMAX, WiBro Measurements options (K92/K93)

- "ABORt Subsystem (WiMAX, K92/K93)" on page 6.750
- "CALCulate:BURSt Subsystem (WiMAX, K92/K93)" on page 6.751
- "CALCulate:LIMit Subsystem (WiMAX, K92/K93)" on page 6.752
- "CALCulate:MARKer Subsystem (WiMAX, K92/K93)" on page 6.767
- "CONFigure Subsystem (WiMAX, K92/K93)" on page 6.775
- "DISPlay Subsystem (WiMAX, K92/K93)" on page 6.802
- "FETCh Subsystem (WiMAX, K92/K93)" on page 6.807
- "FORMat Subsystem (WiMAX, K92/K93)" on page 6.819
- "INITiate Subsystem (WiMAX, K92/K93)" on page 6.820
- "INPut Subsystem (WiMAX, K92/K93)" on page 6.821
- "INSTrument Subsystem (WiMAX, K92/K93)" on page 6.822
- "MMEMory Subsystem (WiMAX, K92/K93)" on page 6.823
- "SENSe Subsystem (WiMAX, K92/K93)" on page 6.825
- "STATus Subsystem (WiMAX, K92/K93)" on page 6.842
- "SYSTEM Subsystem (WiMAX, K92/K93)" on page 6.846
- "TRACe Subsystem (WiMAX, K92/K93)" on page 6.847

- ["TRIGger Subsystem \(WiMAX, K92/K93\)"](#) on page 6.856
- ["UNIT Subsystem \(WiMAX, K92/K93\)"](#) on page 6.859

ABORt Subsystem (WiMAX, K92/K93)

Commands of the ABORt Subsystem

- [ABORt](#)

ABORt

For details refer to "[ABORt](#)" on page 6.10.

CALCulate:BURSt Subsystem (WiMAX, K92/K93)

The CALCulate:BURSt subsystem checks the IQ measurement results.

Commands of the CALCulate:BURSt Subsystem

- [CALCulate<1|2>:BURSt\[:IMMediate\]](#)

CALCulate<1|2>:BURSt[:IMMediate]

This command forces the IQ measurement results of to be recalculated according to the current settings.

The numeric suffixes <1|2> sets the measurement window for the calculation.

This command is an event and therefore has no *RST value and no query.

Example

```
CALC1: BURS
```

Starts the recalculation of the IQ measurement results.

Characteristics

RST value: -

SCPI: device-specific

Mode

OFDM, OFDMA/WiBro

CALCulate:LIMit Subsystem (WiMAX, K92/K93)

The CALCulate:LIMit subsystem contains commands for the limit lines and the corresponding limit checks.

Commands of the CALCulate:LIMit Subsystem

- CALCulate<1|2>:LIMit<1...8>:FAIL?
- CALCulate<1|2>:LIMit<1...8>:BURSt:ALL
- CALCulate<1|2>:LIMit<1...8>:BURSt:ALL:RESult?
- CALCulate<1|2>:LIMit<1...8>:BURSt:BERPilot[:AVERage]
- CALCulate<1|2>:LIMit<1...8>:BURSt:BERPilot[:AVERage]:RESult?
- CALCulate<1|2>:LIMit<1...8>:BURSt:BERPilot:MAXimum
- CALCulate<1|2>:LIMit<1...8>:BURSt:BERPilot:MAXimum:RESult?
- CALCulate<1|2>:LIMit<1...8>:BURSt:EVM:ALL[:AVERage]
- CALCulate<1|2>:LIMit<1...8>:BURSt:EVM:ALL[:AVERage]:RESult?
- CALCulate<1|2>:LIMit<1...8>:BURSt:EVM:ALL:MAXimum
- CALCulate<1|2>:LIMit<1...8>:BURSt:EVM:ALL:MAXimum:RESult?
- CALCulate<1|2>:LIMit<1...8>:BURSt:EVM:DATA[:AVERage]
- CALCulate<1|2>:LIMit<1...8>:BURSt:EVM:DATA[:AVERage]:RESult?
- CALCulate<1|2>:LIMit<1...8>:BURSt:EVM:DATA:MAXimum
- CALCulate<1|2>:LIMit<1...8>:BURSt:EVM:DATA:MAXimum:RESult?
- CALCulate<1|2>:LIMit<1...8>:BURSt:FERRor[:AVERage]
- CALCulate<1|2>:LIMit<1...8>:BURSt:FERRor[:AVERage]:RESult?
- CALCulate<1|2>:LIMit<1...8>:BURSt:FERRor:MAXimum
- CALCulate<1|2>:LIMit<1...8>:BURSt:FERRor:MAXimum:RESult?
- CALCulate<1|2>:LIMit<1...8>:BURSt:IQOFset[:AVERage]
- CALCulate<1|2>:LIMit<1...8>:BURSt:IQOFset[:AVERage]:RESult?
- CALCulate<1|2>:LIMit<1...8>:BURSt:IQOFset:MAXimum
- CALCulate<1|2>:LIMit<1...8>:BURSt:IQOFset:MAXimum:RESult?
- CALCulate<1|2>:LIMit<1...8>:BURSt:SSTiming[:AVERage]
- CALCulate<1|2>:LIMit<1...8>:BURSt:SSTiming[:AVERage]:RESult?
- CALCulate<1|2>:LIMit<1...8>:BURSt:SSTiming:MAXimum
- CALCulate<1|2>:LIMit<1...8>:BURSt:SSTiming:MAXimum:RESult?
- CALCulate<1|2>:LIMit<1...8>:BURSt:SYMBOLerror[:AVERage]
- CALCulate<1|2>:LIMit<1...8>:BURSt:SYMBOLerror[:AVERage]:RESult?
- CALCulate<1|2>:LIMit<1...8>:BURSt:SYMBOLerror:MAXimum
- CALCulate<1|2>:LIMit<1...8>:BURSt:SYMBOLerror:MAXimum:RESult?
- CALCulate<1|2>:LIMit<1...8>:SPECTrum:MASK:CHECK:X?
- CALCulate<1|2>:LIMit<1...8>:SPECTrum:MASK:CHECK:Y?

CALCulate<1|2>:LIMit<1...8>:FAIL?

This command queries the limit check result of the limit line indicated in the selected measurement window. To obtain a valid result, a complete sweep must be performed. A synchronization with *OFC, *OFC? or *WAI is therefore recommended.

The numeric suffixes <1|2> sets the measurement window for the calculation. The numeric suffixes <1...8> specify the limit lines as follows:

- 1 to 2 not used
- 3 ETSI Spectrum Mask limit line
- 4 IEEE Spectrum Mask limit line
- 5 Spectrum Flatness (Upper) limit line
- 6 Spectrum Flatness (Lower) limit line
- 7 Spectrum Flatness Difference (Upper) limit line
- 8 Spectrum Flatness Difference (Lower) limit line

Note: No limit lines are displayed in screen A. Therefore all commands with the suffix 1 for CALCulate will return 0.

This command is only a query and therefore has no *RST value.

Return values

- 0 PASSED
- 1 FAILED

Example

```
INIT; *WAI
```

Starts a new sweep and waits for its end.

```
CALC2:LIM1:FAIL?
```

Queries the result of the check for limit line 1 in screen B.

Characteristics

RST value: -

SCPI: device-specific

Mode

OFDM, OFDMA/WiBro

CALCulate<1|2>:LIMit<1...8>:BURSt:ALL

This command sets or returns all the limit values.

The numeric suffixes <1|2> sets the measurement window for the calculation and the suffixes <1...8> specify the limit lines (see CALCulate<1|2>:LIMit<1...8>:FAIL? command).

Parameter

The results are input or output as a list of values separated by commas in the following (ASCII) format:

Result input/output in ASCII format	Description
<average EVM all bursts>, <max EVM all bursts>	dB or % depending on selected units (UNIT:TABLE)
<average EVM data carriers >, <max EVM data carriers >	dB or % depending on selected units (UNIT:TABLE)
<average Frequency Error>, <max Frequency Error>	Down Link Mode: Hz; .Up Link Mode: %

Result input/output in ASCII format	Description
<average Symbol Error>, <max Symbol Error>	Down Link Mode: ppm; Up Link Mode: %
<average SS Timing>, <maximum SS Timing >	only returned in Up Link mode
<average IQ Offset>, <max IQ Offset>	dB or % depending on selected units (UNIT:TABLE)

Example

CALC:LIM:BURS:ALL?
All limit values are returned.

Characteristics

RST value: -
SCPI: device-specific

Mode

OFDM, OFDMA/WiBro

CALCulate<1|2>:LIMit<1...8>:BURSt:ALL:RESult?

This command returns all the limit results.
The numeric suffixes <1|2> sets the measurement window for the calculation and the suffixes <1...8> specify the limit lines (see [CALCulate<1|2>:LIMit<1...8>:FAIL?](#) command).
This command is only a query and therefore has no *RST value.

Return values

0 PASSED
1 FAILED

The results are output as a list of result strings separated by commas. For the output order see [CALCulate<1|2>:LIMit<1...8>:BURSt:ALL](#) command.

Example

CALC:LIM:BURS:ALL:RES?
All limit values are returned.

Characteristics

RST value: -
SCPI: device-specific

Mode

OFDM, OFDMA/WiBro

CALCulate<1|2>:LIMit<1..8>:BURSt:BERPilot[:AVERAge]

This command sets the average Bit Error Rate for pilot carriers limit.

Parameter

-1000000 to 1000000 %

Example

CALC:LIM:BURS:BERP -25.0
Average Bit Error Rate for pilot carriers limit is set to -25.0 dB.

Characteristics

RST value: -

SCPI: device-specific

Mode

OFDMA/WiBro

CALCulate<1|2>:LIMit<1...8>:BURSt:BERPilot[:AVERAge]:RESult?

This command returns the Bit Error Rate for pilot carriers limit result.

This command is only a query and therefore has no *RST value.

Return values

0 PASSED

1 FAILED

Example

```
CALC:LIM:BURS:BERP:RES?
```

Average EVM for all carrier limit result is returned.

Characteristics

RST value: -

SCPI: device-specific

Mode

OFDMA/WiBro

CALCulate<1|2>:LIMit<1...8>:BURSt:BERPilot:MAXimum

This command sets the maximum Bit Error Rate Limit.

Parameter

-1000000 to 1000000 %

Example

```
CALC:LIM:BURS:EVM:ALL:MAX?
```

Maximum EVM for all carrier limit is returned.

Characteristics

RST value: -

SCPI: device-specific

Mode

OFDMA/WiBro

CALCulate<1|2>:LIMit<1...8>:BURSt:BERPilot:MAXimum:RESult?

This command returns the maximum Error Vector Magnitude Limit result. This is a combined figure that represents the pilot, data and the free carrier.

This command is only a query and therefore has no *RST value.

Return values

0 PASSED

1 FAILED

Example

CALC:LIM:BURS:EVM:ALL:MAX:RES?
 Maximum EVM for all carrier limit result is returned.

Characteristics

RST value: -
 SCPI: device-specific

Mode

OFDMA/WiBro

CALCulate<1|2>:LIMit<1...8>:BURSt:EVM:ALL[:AVERAge]

This command sets the average Error Vector Magnitude Limit. This is a combined figure that represents the pilot, data and the free carrier.

The numeric suffixes <1|2> sets the measurement window for the calculation and the suffixes <1...8> specify the limit lines (see CALCulate<1|2>:LIMit<1...8>:FAIL? command).

Parameter

-1000000 to 1000000 dB or %

If no unit is specified the unit specified by the UNIT:TABLE command is used.

Example

CALC:LIM:BURS:EVM:ALL -25.0
 Average EVM for all carrier limit is set to -25.0 dB.

Characteristics

RST value: -
 SCPI: device-specific

Mode

OFDM, OFDMA/WiBro

CALCulate<1|2>:LIMit<1...8>:BURSt:EVM:ALL[:AVERAge]:RESult?

This command returns the average Error Vector Magnitude Limit result. This is a combined figure that represents the pilot, data and the free carrier.

The numeric suffixes <1|2> sets the measurement window for the calculation and the suffixes <1...8> specify the limit lines (see CALCulate<1|2>:LIMit<1...8>:FAIL? command).

This command is only a query and therefore has no *RST value.

Return values

0 PASSED
 1 FAILED

Example

CALC:LIM:BURS:EVM:ALL:RES?
 Average EVM for all carrier limit result is returned.

Characteristics

RST value: -
 SCPI: device-specific

Mode

OFDM, OFDMA/WiBro

CALCulate<1|2>:LIMit<1...8>:BURSt:EVM:ALL:MAXimum

This command sets the maximum Error Vector Magnitude Limit. This is a combined figure that represents the pilot, data and the free carrier.

The numeric suffixes <1|2> sets the measurement window for the calculation and the suffixes <1...8> specify the limit lines (see [CALCulate<1|2>:LIMit<1...8>:FAIL?](#) command).

Parameter

-1000000 to 1000000 dB or %

If no unit is specified the unit specified by the [UNIT:TABLE](#) command is used.

Example

```
CALC:LIM:BURS:EVM:ALL:MAX?
Maximum EVM for all carrier limit is returned.
```

Characteristics

RST value: -

SCPI: device-specific

Mode

OFDM, OFDMA/WiBro

CALCulate<1|2>:LIMit<1...8>:BURSt:EVM:ALL:MAXimum:RESult?

This command returns the maximum Error Vector Magnitude Limit result. This is a combined figure that represents the pilot, data and the free carrier.

The numeric suffixes <1|2> sets the measurement window for the calculation and the suffixes <1...8> specify the limit lines (see [CALCulate<1|2>:LIMit<1...8>:FAIL?](#) command).

This command is only a query and therefore has no *RST value.

Return values

0 PASSED

1 FAILED

Example

```
CALC:LIM:BURS:EVM:ALL:MAX:RES?
Maximum EVM for all carrier limit result is returned.
```

Characteristics

RST value: -

SCPI: device-specific

Mode

OFDM, OFDMA/WiBro

CALCulate<1|2>:LIMit<1...8>:BURSt:EVM:DATA[:AVERage]

This command sets the average Error Vector Magnitude Limit for the data carrier.

The numeric suffixes <1|2> sets the measurement window for the calculation and the suffixes <1...8> specify the limit lines (see [CALCulate<1|2>:LIMit<1...8>:FAIL?](#) command).

Parameter

-1000000 to 1000000 dB or %

If no unit is specified the unit specified by the [UNIT:TABLE](#) command is used.

Example

CALC:LIM:BURS:EVM:DATA -30.0
Average EVM for data carrier limit is set to -30.0 dB.

Characteristics

RST value: -
SCPI: device-specific

Mode

OFDM, OFDMAWiBro

CALCulate<1|2>:LIMit<1...8>:BURSt:EVM:DATA[:AVERAge]:RESult?

This command returns the average Error Vector Magnitude limit result summary for the data carrier in dB.
The numeric suffixes <1|2> sets the measurement window for the calculation and the suffixes <1...8> specify the limit lines (see [CALCulate<1|2>:LIMit<1...8>:FAIL?](#) command).
This command is only a query and therefore has no *RST value.

Return values

0 PASSED
1 FAILED

Example

CALC:LIM:BURS:EVM:DATA:RES?
Average EVM for data carrier limit result is returned.

Characteristics

RST value: -
SCPI: device-specific

Mode

OFDM, OFDMAWiBro

CALCulate<1|2>:LIMit<1...8>:BURSt:EVM:DATA:MAXimum

This command sets the maximum Error Vector Magnitude Limit for the data carrier.
The numeric suffixes <1|2> sets the measurement window for the calculation and the suffixes <1...8> specify the limit lines (see [CALCulate<1|2>:LIMit<1...8>:FAIL?](#) command).

Parameter

-1000000 to 1000000 dB or %
If no unit is specified the unit specified by the [UNIT:TABLE](#) command is used.

Example

CALC:LIM:BURS:EVM:DATA:MAX?
Maximum EVM for data burst limit is returned.

Characteristics

RST value: -
SCPI: device-specific

Mode

OFDM, OFDMAWiBro

CALCulate<1|2>:LIMit<1...8>:BURSt:EVM:DATA:MAXimum:RESult?

This command returns the maximum Error Vector Magnitude limit result summary for the data carrier in dB.

The numeric suffixes <1|2> sets the measurement window for the calculation and the suffixes <1...8> specify the limit lines (see [CALCulate<1|2>:LIMit<1...8>:FAIL?](#) command).

This command is only a query and therefore has no *RST value.

Return values

0 PASSED
1 FAILED

Example

```
CALC:LIM:BURS:EVM:DATA:MAX:RES?
```

Maximum EVM for data carrier limit result is returned.

Characteristics

RST value: -

SCPI: device-specific

Mode

OFDM, OFDMA/WiBro

CALCulate<1|2>:LIMit<1...8>:BURSt:FERRor[:AVERage]

This command sets the average frequency error limit.

The numeric suffixes <1|2> sets the measurement window for the calculation and the suffixes <1...8> specify the limit lines (see [CALCulate<1|2>:LIMit<1...8>:FAIL?](#) command).

Parameter

-1000000 to 1000000 Hz or %

If no unit is specified the unit depends on the current Up/Down Link Mode: Hz in Down Link mode, % in Up Link mode.

Note: *There is no relationship between the Down Link and Up Link values. Setting a Down Link value in Up Link mode does not change the displayed limit value.*

Example

```
CALC:LIM:BURS:FERR 10000
```

The average frequency error limit is set to 10000 Hz.

Characteristics

RST value: -

SCPI: device-specific

Mode

OFDM, OFDMA/WiBro

CALCulate<1|2>:LIMit<1...8>:BURSt:FERRor[:AVERage]:RESult?

This command returns the average frequency error limit result.

The numeric suffixes <1|2> sets the measurement window for the calculation and the suffixes <1...8> specify the limit lines (see [CALCulate<1|2>:LIMit<1...8>:FAIL?](#) command).

This command is only a query and therefore has no *RST value.

Return values

0 PASSED
1 FAILED

Example

CALC:LIM:BURS:FERR:RES?

Average frequency error limit result is returned.

Characteristics

RST value: -

SCPI: device-specific

Mode

OFDM, OFDMA/WiBro

CALCulate<1|2>:LIMit<1...8>:BURSt:FERRor:MAXimum

This command sets the maximum frequency error limit.

The numeric suffixes <1|2> sets the measurement window for the calculation and the suffixes <1...8> specify the limit lines (see [CALCulate<1|2>:LIMit<1...8>:FAIL?](#) command).

Parameter

-1000000 to 1000000 Hz or %

If no unit is specified the unit depends on the current Up/Down Link Mode: Hz in Down Link mode, % in Up Link mode.

Note: *There is no relationship between the Down Link and Up Link values. Setting a Down Link value in Up Link mode does not change the displayed limit value.*

Example

CALC:LIM:BURS:FERR:MAX?

Maximum frequency error limit is returned.

Characteristics

RST value: -

SCPI: device-specific

Mode

OFDM, OFDMA/WiBro

CALCulate<1|2>:LIMit<1...8>:BURSt:FERRor:MAXimum:RESult?

This command returns the maximum frequency error limit result.

The numeric suffixes <1|2> sets the measurement window for the calculation and the suffixes <1...8> specify the limit lines (see [CALCulate<1|2>:LIMit<1...8>:FAIL?](#) command).

This command is only a query and therefore has no *RST value.

Return values

0 PASSED
1 FAILED

Example

CALC:LIM:BURS:FERR:MAX:RES?

Maximum frequency error limit result is returned

Characteristics

RST value: -

SCPI: device-specific

Mode

OFDM, OFDMA/WiBro

CALCulate<1|2>:LIMit<1...8>:BURSt:IQOFset[:AVERAge]

This command sets the average IQ offset error limit.

The numeric suffixes <1|2> sets the measurement window for the calculation and the suffixes <1...8> specify the limit lines (see [CALCulate<1|2>:LIMit<1...8>:FAIL?](#) command).

Parameter

-1000000 to 1000000 dB or %

If no unit is specified the unit specified by the [UNIT:TABLE](#) command is used.

Example

```
CALC:LIM:BURS:IQOF -10.0
```

Average IQ offset error limit is set to -10.0 dB.

Characteristics

*RST value: -

SCPI: device-specific

Mode

OFDM, OFDMA/WiBro

CALCulate<1|2>:LIMit<1...8>:BURSt:IQOFset[:AVERAge]:RESult?

This command returns the average IQ offset error limit result.

The numeric suffixes <1|2> sets the measurement window for the calculation and the suffixes <1...8> specify the limit lines (see [CALCulate<1|2>:LIMit<1...8>:FAIL?](#) command).

This command is only a query and therefore has no *RST value.

Return values

0 PASSED

1 FAILED

Example

```
CALC:LIM:BURS:IQOF:RES?
```

Average IQ offset error limit result is returned.

Characteristics

*RST value: -

SCPI: device-specific

Mode

OFDM, OFDMA/WiBro

CALCulate<1|2>:LIMit<1...8>:BURSt:IQOFset:MAXimum

This command sets the maximum IQ offset error limit.

The numeric suffixes <1|2> sets the measurement window for the calculation and the suffixes <1...8> specify the limit lines (see [CALCulate<1|2>:LIMit<1...8>:FAIL?](#) command).

Parameter

-1000000 to 1000000 dB or %

If no unit is specified the unit specified by the [UNIT:TABLE](#) command is used.

Example

```
CALC:LIM:BURS:IQOF:MAX 15.0DB
Maximum IQ offset error limit is set to 15.0 dB.
```

Characteristics

*RST value: -

SCPI: device-specific

Mode

OFDM, OFDMA/WiBro

CALCulate<1|2>:LIMit<1...8>:BURSt:IQOFset:MAXimum:RESult?

This command returns the maximum IQ offset error limit result.

The numeric suffixes <1|2> sets the measurement window for the calculation and the suffixes <1...8> specify the limit lines (see [CALCulate<1|2>:LIMit<1...8>:FAIL?](#) command).

This command is only a query and therefore has no *RST value.

Return values

```
0 PASSED
1 FAILED
```

Example

```
CALC:LIM:BURS:IQOF:MAX:RES?
Maximum IQ offset error limit result is returned.
```

Characteristics

*RST value: -

SCPI: device-specific

Mode

OFDM, OFDMA/WiBro

CALCulate<1|2>:LIMit<1...8>:BURSt:SSTiming[:AVERage]

This command is only supported for reasons of compatibility with the FSP family. It sets the average Subscriber Station Timing limit.

The numeric suffixes <1|2> sets the measurement window for the calculation and the suffixes <1...8> specify the limit lines (see [CALCulate<1|2>:LIMit<1...8>:FAIL?](#) command).

Parameter

0PCT

Example

```
CALC:LIM:BURS:SST 0
```

The average SS Timing limit is set to 0%.

Characteristics

RST value: -

SCPI: device-specific

Mode

OFDM, OFDMA/WiBro

CALCulate<1|2>:LIMit<1...8>:BURSt:SSTiming[:AVERAge]:RESult?

This command returns the average Subscriber Station Timing limit result.

The numeric suffixes <1|2> sets the measurement window for the calculation and the suffixes <1...8> specify the limit lines (see [CALCulate<1|2>:LIMit<1...8>:FAIL?](#) command).

This command is only a query and therefore has no *RST value.

Return values

0 PASSED

1 FAILED

Example

```
CALC:LIM:BURS:SST:RES?
```

Average SS Timing limit result is returned.

Characteristics

RST value: -

SCPI: device-specific

Mode

OFDM, OFDMA/WiBro

CALCulate<1|2>:LIMit<1...8>:BURSt:SSTiming:MAXimum

This command is only supported for reasons of compatibility with the FSP family. It sets the maximum Subscriber Station Timing limit.

The numeric suffixes <1|2> sets the measurement window for the calculation and the suffixes <1...8> specify the limit lines (see [CALCulate<1|2>:LIMit<1...8>:FAIL?](#) command).

Parameter

0PCT

Example

```
CALC:LIM:BURS:SST:MAX?
```

Maximum SS Timing limit is returned.

Characteristics

RST value: -

SCPI: device-specific

Mode

OFDM, OFDMA/WiBro

CALCulate<1|2>:LIMit<1...8>:BURSt:SSTiming:MAXimum:RESult?

This command returns the maximum Subscriber Station Timing limit.

The numeric suffixes <1|2> sets the measurement window for the calculation and the suffixes <1...8> specify the limit lines (see [CALCulate<1|2>:LIMit<1...8>:FAIL?](#) command).

This command is only a query and therefore has no *RST value.

Return values

0 PASSED
1 FAILED

Example

```
CALC:LIM:BURS:SST:MAX:RES?
```

Maximum SS Timing limit result is returned.

Characteristics

RST value: -

SCPI: device-specific

Mode

OFDM, OFDMA/WiBro

CALCulate<1|2>:LIMit<1...8>:BURSt:SYMBOLerror[:AVERage]

This command sets the average symbol error limit.

The numeric suffixes <1|2> sets the measurement window for the calculation and the suffixes <1...8> specify the limit lines (see [CALCulate<1|2>:LIMit<1...8>:FAIL?](#) command).

Parameter

<numeric_value> in ppm or %: -1000000 to 1000000

If no unit is specified the unit depends on the current Up/Down Link Mode: ppm in Down Link mode, % in Up Link mode.

Note: *There is no relationship between the Down Link and Up Link values. Setting a Down Link value in Up Link mode does not change the displayed limit value.*

Example

```
CALC:LIM:BURS:SYMB 10000
```

The average symbol error limit is set to 10000 Hz.

Characteristics

RST value: -

SCPI: device-specific

Mode

OFDM, OFDMA/WiBro

CALCulate<1|2>:LIMit<1...8>:BURSt:SYMBOLerror[:AVERage]:RESult?

This command returns the average symbol error limit result.

The numeric suffixes <1|2> sets the measurement window for the calculation and the suffixes <1...8> specify the limit lines (see [CALCulate<1|2>:LIMit<1...8>:FAIL?](#) command).

This command is only a query and therefore has no *RST value.

Return values

0 PASSED
1 FAILED

Example

CALC:LIM:BURS:SYMB:RES?

Average symbol error limit result is returned.

Characteristics

RST value: -

SCPI: device-specific

Mode

OFDM, OFDMA/WiBro

CALCulate<1|2>:LIMit<1...8>:BURSt:SYMBolerror:MAXimum

This command sets the maximum symbol error limit.

The numeric suffixes <1|2> sets the measurement window for the calculation and the suffixes <1...8> specify the limit lines (see [CALCulate<1|2>:LIMit<1...8>:FAIL?](#) command).

Parameter

<numeric_value> in ppm or %: -1000000 to 1000000

If no unit is specified the unit depends on the current Up/Down Link Mode: ppm in Down Link mode, % in Up Link mode.

Note: *There is no relationship between the Down Link and Up Link values. Setting a Down Link value in Up Link mode does not change the displayed limit value.*

Example

CALC:LIM:BURS:SYMB:MAX?

Maximum symbol error limit is returned.

Characteristics

RST value: -

SCPI: device-specific

Mode

OFDM, OFDMA/WiBro

CALCulate<1|2>:LIMit<1...8>:BURSt:SYMBolerror:MAXimum:RESult?

This command returns the maximum symbol error limit result.

The numeric suffixes <1|2> sets the measurement window for the calculation and the suffixes <1...8> specify the limit lines (see [CALCulate<1|2>:LIMit<1...8>:FAIL?](#) command).

This command is only a query and therefore has no *RST value.

Return values

0 PASSED
1 FAILED

Example

CALC:LIM:BURS:SYMB:MAX:RES?

Maximum symbol error limit result is returned.

Characteristics

RST value: -

SCPI: device-specific

ModeOFDM, OFDMA/WiBro

CALCulate<1|2>:LIMit<1...8>:SPECtrum:MASK:CHECK:X?

This command returns the x-value at the maximum overstepping of the spectrum mask limits.

The numeric suffixes <1|2> sets the measurement window for the calculation and the suffixes <1...8> specify the limit lines (see [CALCulate<1|2>:LIMit<1...8>:FAIL?](#) command).

This command is only a query and therefore has no *RST value.

Example

```
CALC:LIM:SPEC:MASK:CHECK:X?
```

Returns the frequency at the maximum overstepping.

Characteristics

RST value: -

SCPI: device-specific

ModeOFDM, OFDMA/WiBro

CALCulate<1|2>:LIMit<1...8>:SPECtrum:MASK:CHECK:Y?

This command returns the y-value at the maximum overstepping of the spectrum mask limits.

The numeric suffixes <1|2> sets the measurement window for the calculation and the suffixes <1...8> specify the limit lines (see [CALCulate<1|2>:LIMit<1...8>:FAIL?](#) command).

This command is only a query and therefore has no *RST value.

Example

```
CALC:LIM:SPEC:MASK:CHECK:Y?
```

Returns the power at the maximum overstepping.

Characteristics

RST value: -

SCPI: device-specific

ModeOFDM, OFDMA/WiBro

CALCulate:MARKer Subsystem (WiMAX, K92/K93)

The CALCulate:MARKer subsystem checks the marker functions of the instrument.



Currently there is only marker 1 available and it is always on.

The following subsystem is included:

- ["CALCulate:MARKer:FUNCTION Subsystem \(WiMAX, K92/K93\)"](#) on page 6.773

Commands of the CALCulate:MARKer Subsystem

- `CALCulate<1|2>:MARKer<1>[:STATe]`
- `CALCulate<1|2>:MARKer<1>:AOFF`
- `CALCulate<1|2>:MARKer<1>:BURSt`
- `CALCulate<1|2>:MARKer<1>:CARRier`
- `CALCulate<1|2>:MARKer<1>:MAXimum[:PEAK]`
- `CALCulate<1|2>:MARKer<1>:MINimum[:PEAK]`
- `CALCulate<1|2>:MARKer<1>:SYMBol`
- `CALCulate<1|2>:MARKer<1>:TRACe`
- `CALCulate<1|2>:MARKer<1>:FUNCTION:TTCapture:TIME?`
- `CALCulate<1|2>:MARKer<1>:X`
- `CALCulate<1|2>:MARKer<1>:Y?`

CALCulate<1|2>:MARKer<1>[:STATe]

This command switches the markers in the specified measurement window on or off.

Parameter

ON | OFF

Example

```
CALC1:MARK1 ON
Switches the screen A marker ON.
```

Characteristics

RST value: ON
SCPI: device-specific

Mode

OFDM, OFDMA/WiBro

CALCulate<1|2>:MARKer<1>:AOFF

This command switches off all active markers in the specified measurement window. The window is set by the numeric suffix of CALCulate<1|2>.

Example

```
CALC1:MARK:AOFF
```

Switches off all markers in the screen A window.

```
CALC2:MARK:AOFF
```

Switches off all markers in the screen B window.

Characteristics

RST value: -

SCPI: device-specific

Mode

OFDM, OFDMA/WiBro

CALCulate<1|2>:MARKer<1>:BURSt

This command positions the selected marker in the specified measurement window to the indicated burst. This command is only available for the Constellation vs Symbol result display.

Parameter

1 to <number of captured bursts in capture buffer>

Example

```
CALC2:MARK:BURS 2
```

Positions marker 1 in screen B to burst 2.

```
CALC2:MARK:BURS?
```

Outputs the symbol value of marker 1 in screen B.

Characteristics

RST value: -

SCPI: device-specific

Mode

OFDM, OFDMA/WiBro

CALCulate<1|2>:MARKer<1>:CARRier

This command positions the selected marker in the specified measurement window to the indicated carrier.

This command is only available for the following result displays:

- Constellation vs Symbol
- Constellation vs Carrier

Parameter

-100 to 100

Example

```
CALC2:MARK:CARR -7
```

Positions marker 1 in screen B to carrier -7.

```
CALC2:MARK:CARR?
```

Outputs the carrier value of marker 1 in screen B.

Characteristics

RST value: -

SCPI: device-specific

ModeOFDM, OFDMA/WiBro

CALCulate<1|2>:MARKer<1>:MAXimum[:PEAK]

This command sets the selected marker in the specified measurement window to the maximum peak value in the current trace.

This command is only available for the following result display:

- Spectrum Flatness

This command is an event and therefore has no *RST value and no query.

Example

```
CALC2:MARK:MAX
```

Set marker 1 in screen B to maximum value in trace.

Characteristics

RST value: -

SCPI: device-specific

ModeOFDM, OFDMA/WiBro

CALCulate<1|2>:MARKer<1>:MINimum[:PEAK]

This command sets the selected marker in the specified measurement window to the minimum peak value in the current trace.

This command is only available for the following result display:

- Spectrum Flatness

This command is an event and therefore has no *RST value and no query.

Example

```
CALC2:MARK:MIN
```

Set marker 1 in screen B to minimum value in trace.

Characteristics

RST value: -

SCPI: device-specific

ModeOFDM, OFDMA/WiBro

CALCulate<1|2>:MARKer<1>:SYMBol

This command positions the selected marker in the specified measurement window to the indicated symbol.

This command is only available for the following result displays:

- Constellation vs Symbol
- Constellation vs Carrier

Parameter

1 to <number of symbols in selected burst>

Example

```
CALC2:MARK:SYMB 2
```

Positions marker 1 in screen B to symbol 2.

```
CALC2:MARK:SYMB?
```

Outputs the symbol value of marker 1 in screen B.

Characteristics

RST value: -

SCPI: device-specific

Mode

OFDM, OFDMA/WiBro

CALCulate<1|2>:MARKer<1>:TRACe

This command assigns the selected marker to the indicated measurement curve in the selected measurement window.

This command is only available for the following result displays:

- Constellation vs Carrier
- EVM vs Symbol
- EVM vs Carrier
- Frequency Error vs Preamble
- Phase Error vs Preamble
- PVT Rising / Falling
- Spectrum Flatness
- Spectrum Flatness Difference
- Spectrum Mask - if Max Hold trace mode is activated
- Spectrum ACP/ACPR - if Max Hold trace mode is activated

Parameter

1 to 3

Example

```
CALC2:MARK:TRAC 2
```

Assigns marker 1 in screen B to trace 2.

Characteristics

RST value: 1

SCPI: device-specific

ModeOFDM, OFDMA/WiBro

CALCulate<1|2>:MARKer<1>:FUNCtion:TTCapture:TIME?

This command returns the time to the start of the first frame in the capture buffer.

This command is only a query and therefore has no *RST value.

Example

```
CALC:MARK:FUNC:TTC:TIME?
```

Returns the time to the start of the first frame in the capture buffer.

Characteristics

RST value: -

SCPI: device-specific

ModeOFDMA/WiBro

CALCulate<1|2>:MARKer<1>:X

This command positions the selected marker to the indicated in phase (Constellation vs Symbol), frequency (Spectrum FFT, Spectrum Mask), time (Magnitude Capture Buffer, Auto Level, PVT Full Burst, PVT Rising / Falling), power (CCDF), sub-carrier (Constellation vs Carrier, EVM vs Carrier, Spectrum Flatness) or symbol (EVM vs Symbol) in the selected measurement window.

For the following result displays, this command is a query only:

- Constellation vs Symbol
- Constellation vs Carrier

Parameter

1 to <maximum range for selected measurement>

Example

```
CALC:MARK:X 2ms
```

Positions marker 1 in screen A to time 2 ms.

Characteristics

RST value: -

SCPI: device-specific

ModeOFDM, OFDMA/WiBro

CALCulate<1|2>:MARKer<1>:Y?

This command queries the marker value of the indicated quadrature (Constellation vs Symbol), magnitude of I or Q (Constellation vs Carrier), EVM (EVM vs Carrier) or abs (Spectrum Flatness) in the selected measurement window.

This command is only a query and therefore has no *RST value.

This command is only available for the following result displays:

- Auto Level
- Constellation vs Symbol
- Constellation vs Carrier
- EVM vs Symbol
- PVT Full
- PVT Rising / Falling
- Magnitude Capture Buffer
- Spectrum Mask
- Spectrum FFT
- CCDF

Example

```
CALC2:MARK:Y -2
```

Positions marker 1 in screen B to -2.

```
CALC:MARK:Y?
```

Outputs the measured value of marker 1 in screen A.

Characteristics

RST value: -

SCPI: device-specific

Mode

OFDM, OFDMA/WiBro

CALCulate:MARKer:FUNCTION Subsystem (WiMAX, K92/K93)

The measurement window is selected by CALCulate 1 (screen A) or 2 (screen B).

Commands of the CALCulate:MARKer:FUNCTION Subsystem

- [CALCulate<1|2>:MARKer<1>:FUNCTION:POWER:RESult\[:CURRent\]?](#)
- [CALCulate<1|2>:MARKer<1>:FUNCTION:POWER:RESult:MAXHold?](#)
- [CALCulate<1|2>:MARKer<1>:FUNCTION:ZOOM](#)

CALCulate<1|2>:MARKer<1>:FUNCTION:POWER:RESult[:CURRent]?

This command queries the current result values of the adjacent channel power measurement. An ACPR (Adjacent channel power relative) measurement must have previously been run to provide the summary data.

The numeric suffix <1|2> at CALCulate specifies the measurement window.

This command is only a query and therefore has no *RST value.

Results are output separated by commas. Adjacent channel power values are output in dB. The order is as follows:

- Power of main channel
- Power of lower adjacent channel
- Power of upper adjacent channel
- Power of lower alternate adjacent channel 1
- Power of upper alternate adjacent channel 1
- Power of lower alternate adjacent channel 2
- Power of upper alternate adjacent channel 2
- Power of lower alternate adjacent channel 3
- Power of upper alternate adjacent channel 3
- Power of lower alternate adjacent channel 4
- Power of upper alternate adjacent channel 4

Example

```
CALC2:MARK:FUNC:POW:RES?
```

Characteristics

RST value: -

SCPI: device-specific

Mode

OFDM, OFDMA/WiBro

CALCulate<1|2>:MARKer<1>:FUNCTION:POWER:RESult:MAXHold?

This command queries the maximum result values of the adjacent channel power measurement. An ACPR (Adjacent channel power relative) measurement must have previously been run with more than one sweep to provide the summary data.

For details on the result output refer to

[CALCulate<1|2>:MARKer<1>:FUNCTION:POWER:RESult\[:CURRent\]?](#)

The numeric suffix <1|2> at CALCulate specifies the measurement window.

Example

CALC2:MARK:FUNC:POW:RES:MAXH?

Characteristics

RST value: -

SCPI: device-specific

Mode

OFDM, OFDMA/WiBro

CALCulate<1|2>:MARKer<1>:FUNCtion:ZOOM

This command defines the ratio to be zoomed around the marker 1 in the selected measurement window. The default value is 1, where the full trace is shown.

This command is only available for the following result displays:

- Constellation vs Carrier
- Constellation vs Symbol
- PVT Full Burst
- PVT Rising / Falling
- Magnitude Capture Buffer

Parameter

1 to 1000000

Example

CALC:MARK:FUNC:ZOOM 2

Zooms 50% in screen A.

CALC:MARK:FUNC:ZOOM 4

Zooms 25% in screen A.

CALC:MARK:FUNC:ZOOM 1

Deactivates zooming in screen A.

Characteristics

RST value: 1

SCPI: device-specific

Mode

OFDM, OFDMA/WiBro

CONFigure Subsystem (WiMAX, K92/K93)

The CONFigure subsystem contains commands for configuring complex measurement tasks. The CONFigure subsystem is closely linked to the functions of the FETCH subsystem, where the measurement results are queried.

Commands of the CONFigure Subsystem

- CONFigure:BURSt:BSTReam:BURSt:SElect
- CONFigure:BURSt:BSTReam:FORMat:SElect
- CONFigure:BURSt:BSTReam:SYMBol:SElect
- CONFigure:BURSt:CONSt:BURSt:SElect
- CONFigure:BURSt:CONSt:CARRier:SElect
- CONFigure:BURSt:CONSt:CCARRier[:IMMediate]
- CONFigure:BURSt:CONSt:CSYMBol[:IMMediate]
- CONFigure:BURSt:CONSt:FORMat:SElect
- CONFigure:BURSt:CONSt:SYMBol:SElect
- CONFigure:BURSt:EVM:ECARRier[:IMMediate]
- CONFigure:BURSt:EVM:ESYMBol[:IMMediate]
- CONFigure:BURSt:PREamble[:IMMediate]
- CONFigure:BURSt:PREamble:SElect
- CONFigure:BURSt:PVT[:IMMediate]
- CONFigure:BURSt:PVT:BURSt
- CONFigure:BURSt:PVT:SElect
- CONFigure:BURSt:SPECtrum:ACPR[:IMMediate]
- CONFigure:BURSt:SPECtrum:ACPR:SElect
- CONFigure:BURSt:SPECtrum:FFT[:IMMediate]
- CONFigure:BURSt:SPECtrum:FLATness[:IMMediate]
- CONFigure:BURSt:SPECtrum:FLATness:SElect
- CONFigure:BURSt:SPECtrum:MASK[:IMMediate]
- CONFigure:BURSt:SPECtrum:MASK:SElect
- CONFigure:BURSt:STATistics:BSTReam[:IMMediate]
- CONFigure:BURSt:STATistics:BSUMmary[:IMMediate]
- CONFigure:BURSt:STATistics:CCDF[:IMMediate]
- CONFigure:CHANnel
- CONFigure:POWer:AUTO
- CONFigure:POWer:AUTO:SWEEp:TIME
- CONFigure:POWer:EXPEcted:RF
- CONFigure:STANdard
- CONFigure:WIMax:AVERaging

- CONFigure:WiMax:DLSFrame:IDCell
- CONFigure:WiMax:DLSFrame:PREamble:MOD
- CONFigure:WiMax:DLSFrame:PREamble:INDEX
- CONFigure:WiMax:DLSFrame:SEGMENT<1...3>
- CONFigure:WiMax:FBAND
- CONFigure:WiMax:IGRatio
- CONFigure:WiMax:LMODe
- CONFigure:WiMax:NFFT
- CONFigure:WiMax:TDDFrame:TTG
- CONFigure:WiMax:ULSFrame:FRAME
- CONFigure:WiMax:ZONE<1...26>[:ANALyze]:STATe
- CONFigure:WiMax:ZONE<1...26>:BURSt<1...32>:CONTrol[:DATA]
- CONFigure:WiMax:ZONE<1...26>:BURSt<1...32>:COUNT?
- CONFigure:WiMax:ZONE<1...26>:BURSt<1...32>:DELeTe
- CONFigure:WiMax:ZONE<1...26>:BURSt<1...32>:FORMAt
- CONFigure:WiMax:ZONE<1...26>:BURSt<1...32>:OFFSet:AUTO
- CONFigure:WiMax:ZONE<1...26>:BURSt<1...32>:POWer
- CONFigure:WiMax:ZONE<1...26>:BURSt<1...32>:SLOT:DURation
- CONFigure:WiMax:ZONE<1...26>:BURSt<1...32>:SUBChannel:COUNT
- CONFigure:WiMax:ZONE<1...26>:BURSt<1...32>:SUBChannel:OFFSet
- CONFigure:WiMax:ZONE<1...26>:BURSt<1...32>:SYMBOL:COUNT
- CONFigure:WiMax:ZONE<1...26>:BURSt<1...32>:SYMBOL:OFFSet
- CONFigure:WiMax:ZONE<1...26>:BURSt<1...32>:TYPE
- CONFigure:WiMax:ZONE<1...26>:CONTrol[:DATA]
- CONFigure:WiMax:ZONE<1...26>:COUNT?
- CONFigure:WiMax:ZONE<1...26>:DELeTe
- CONFigure:WiMax:ZONE<1...26>:IDSegment
- CONFigure:WiMax:ZONE<1...26>:PERMbase
- CONFigure:WiMax:ZONE<1...26>:PRBS
- CONFigure:WiMax:ZONE<1...26>:SYMB:COUNT
- CONFigure:WiMax:ZONE<1...26>:SYMB:OFFSet
- CONFigure:WiMax:ZONE<1...26>:TYPE

CONFigure:BURSt:BSTReam:BURSt:SElect

This command selects bursts and pilots. It is only available if the Bitstream measurement is selected (see [CONFigure:BURSt:STATistics:BSTReam\[:IMMediate\]](#) command). (K93)

Parameter

0 to 9999	burst number
ALL	all bursts
PILOTS	only pilots

Example

```
CONF: BURS: STAT: BSTR
```

Configures the Bitstream measurement type.

```
CONF: BURS: BSTR: BURS: SEL 1
```

Selects burst 1.

```
INIT
```

Starts a Bitstream measurement. The results of the selected burst (1) are calculated.

Characteristics

RST value: -

SCPI: device-specific

Mode

OFDMA/WiBro

CONFigure:BURSt:BSTReam:FORMat:SElect

This command selects the modulation format. It is only available if the Bitstream measurement is selected (see [CONFigure:BURSt:STATistics:BSTReam\[:IMMediate\]](#) command).

Parameter

ALL | QPSK | QAM16 | QAM64

Example

```
CONF: BURS: STAT: BSTR
```

Configures the Bitstream measurement type.

```
CONF: BURS: BSTR: FORM: SEL QPSK
```

Selects the QPSK modulation formats.

```
INIT
```

Starts a Bitstream measurement. The results of the selected modulation formats (QPSK) are calculated.

Characteristics

RST value: -

SCPI: device-specific

Mode

OFDMA/WiBro

CONFigure:BURSt:BSTReam:SYMBol:SElect

This command selects the symbol. It is only available if the Bitstream measurement is selected (see [CONFigure:BURSt:STATistics:BSTReam\[:IMMediate\]](#) command).

Parameter

0 to 9999	symbol number
ALL	all symbols

Example

```
CONF: BURS: STAT: BSTR
```

Configures the Bitstream measurement type.

```
CONF: BURS: BSTR: SYMB: SEL 1
```

Selects symbol 1.

```
INIT
```

Starts a Bitstream measurement. The results of the selected symbol (1) are calculated.

Characteristics

RST value: -

SCPI: device-specific

Mode

OFDMA/WiBro

CONFigure:BURSt:CONSt:BURSt:SElect

This command selects bursts and pilots. It is only available if the Constellation vs Symbol measurement is selected (see [CONFigure:BURSt:CONSt:CSYMBOL\[:IMMediate\]](#) command).

Parameter

0 to 9999	burst number
ALL	all bursts
PILOTS	only pilots

Example

```
CONF: BURS: CONS: CSYM
```

Configures the Constellation vs Symbol measurement type.

```
CONF: BURS: CONS: BURS: SEL 1
```

Selects burst 1.

```
INIT
```

Starts a Constellation vs Symbol measurement. The results of the selected burst (1) are calculated.

Characteristics

RST value: -

SCPI: device-specific

Mode

OFDMA/WiBro

CONFigure:BURSt:CONSt:CARRier:SElect

This command selects carriers and pilots. It is only available if the Constellation vs Symbol measurement is selected (see [CONFigure:BURSt:CONSt:CSYMBOL\[:IMMEDIATE\]](#) command).

Parameter

-100 to 100	carrier number
ALL	all carriers
PILOTS	only pilots

Example

```
CONF: BURS: CONS: CSYM
```

Configures the Constellation vs Symbol measurement type.

```
CONF: BURS: CONS: CARR: SEL -26
```

Carrier -26 is selected.

```
INIT
```

Starts a Constellation vs Symbol measurement. The results of the selected carrier (-26) are calculated.

Characteristics

RST value: ALL

SCPI: device-specific

Mode

OFDM, OFDMA/WiBro

CONFigure:BURSt:CONSt:CCARrier[:IMMEDIATE]

This command configures the Constellation vs Carrier measurement type.

This command is an event and therefore has no *RST value and no query.

Example

```
CONF: BURS: CONS: CCAR
```

Configures the Constellation vs Carrier measurement type.

```
INIT
```

Starts a Constellation vs Carrier measurement.

Characteristics

RST value: -

SCPI: device-specific

Mode

OFDM

CONFigure:BURSt:CONSt:CSYMBOL[:IMMEDIATE]

This command configures the Constellation vs Symbol measurement type.

This command is an event and therefore has no *RST value and no query.

Example

```
CONF: BURS: CONS: CSYM
```

Configures the Constellation vs Symbol measurement type.

INIT

Starts a Constellation vs Symbol measurement.

Characteristics

RST value: -

SCPI: device-specific

Mode

OFDM, OFDMA/WiBro

CONFigure:BURSt:CONSt:FORMat:SElect

This command selects the modulation format. It is only available if the Constellation vs Symbol measurement is selected (see [CONFigure:BURSt:CONSt:CSYMBOL\[:IMMEDIATE\]](#) command).

Parameter

ALL | QPSK | QAM16 | QAM64

Example

CONF: BURS: CONS: CSYM

Configures the Constellation vs Symbol measurement type.

CONF: BURS: CONS: FORM: SEL QPSK

Selects the QPSK modulation formats.

INIT

Starts a Constellation vs Symbol measurement. The results of the selected modulation formats (QPSK) are calculated.

Characteristics

RST value: -

SCPI: device-specific

Mode

OFDMA/WiBro

CONFigure:BURSt:CONSt:SYMBOL:SElect

This command selects the symbol. It is only available if the Constellation vs Symbol measurement is selected (see [CONFigure:BURSt:CONSt:CSYMBOL\[:IMMEDIATE\]](#) command).

Parameter

0 to 9999 symbol number

ALL all symbols

Example

CONF: BURS: CONS: CSYM

Configures the Constellation vs Symbol measurement type.

CONF: BURS: CONS: SYMB: SEL 1

Selects symbol 1.

INIT

Starts a Constellation vs Symbol measurement. The results of the selected symbol (1) are calculated.

Characteristics

RST value: -

SCPI: device-specific

ModeOFDMA/WiBro

CONFigure:BURSt:EVM:ECARrier[:IMMediate]

This command configures the EVM vs Carrier measurement type.

This command is an event and therefore has no *RST value and no query.

Example

```
CONF: BURS: EVM: ECAR
```

Configures the EVM vs Carrier measurement type.

```
INIT
```

Starts a EVM vs Carrier measurement.

Characteristics

RST value: -

SCPI: device-specific

ModeOFDM, OFDMA/WiBro

CONFigure:BURSt:EVM:ESYMBOL[:IMMediate]

This command configures the EVM vs Symbol measurement type.

This command is an event and therefore has no *RST value and no query.

Example

```
CONF: BURS: EVM: ESYM
```

Configures the EVM vs Symbol measurement type.

```
INIT
```

Starts a EVM vs Symbol measurement.

Characteristics

RST value: -

SCPI: device-specific

ModeOFDM, OFDMA/WiBro

CONFigure:BURSt:PREamble[:IMMediate]

This command configures the Phase or Frequency vs Preamble measurement type. The selection between the both measurements is made via the [CONFigure:BURSt:PREamble:SElect](#) command.

This command is an event and therefore has no *RST value and no query.

Example

```
CONF: BURS: PRE
```

Configures the Phase or Frequency vs Preamble measurement type.

CONF: BURS: PRE: SEL FREQ

The measurement results are interpreted as Frequency Error vs Preamble.

INIT

Starts a Frequency Error vs Preamble measurement.

Characteristics

RST value: -

SCPI: device-specific

Mode

OFDM, OFDMA/WiBro

CONFigure: BURSt: PREamble: SElect

This command configures the interpretation of the preamble measurement results.

Parameter

PHASe | FREQuency

Example

CONF: BURS: PRE

Configures the Phase or Frequency vs Preamble measurement type.

CONF: BURS: PRE: SEL FREQ

The measurement results are interpreted as Frequency Error vs Preamble.

Characteristics

RST value: -

SCPI: device-specific

Mode

OFDM, OFDMA/WiBro

CONFigure: BURSt: PVT[:IMMediate]

This command configures the Power vs Time (PVT) measurement type. For further settings of the Power vs Time measurement see the [CONFigure: BURSt: PVT: BURSt](#) and [CONFigure: BURSt: PVT: SElect](#) commands.

This command is an event and therefore has no *RST value and no query.

Example

CONF: BURS: PVT

Configures the Power vs Time measurement type.

INIT

Starts a Power vs Time measurement.

Characteristics

RST value: -

SCPI: device-specific

Mode

OFDM, OFDMA/WiBro

CONFigure:BURSt:PVT:BURSt

This command specifies the burst that is used for the Power vs Time measurement results.

Parameter

1 to 10922

Example

```
CONF: BURS: PVT
```

Configures the Power vs Time measurement type.

```
CONF: BURS: PVT: BURS 1
```

Uses burst 1 for the Power vs Time measurement results.

Characteristics

RST value: -

SCPI: device-specific

Mode

OFDM

CONFigure:BURSt:PVT:SELEct

This command configures the interpretation of the Power vs Time (PVT) measurement results. The available measurement types depend on the selected standard.

Parameter

FULL	PVT Start and End	OFDM
	PVT Rsing / Falling	OFDMA/WiBro
EDGE	PVT Full Burst	OFDM
	PVT Full Subframe	OFDMA/WiBro

Example

```
CONF: BURS: PVT
```

Configures the Power vs Time measurement type.

```
CONF: BURS: PVT: SEL FULL
```

The measurement results are interpreted as full burst.

Characteristics

RST value: FULL

SCPI: device-specific

Mode

OFDM, OFDMA/WiBro

CONFigure:BURSt:SPECtrum:ACPR[:IMMediate]

This command configures the ACPR (adjacent channel power relative) measurement type. This command is an event and therefore has no *RST value and no query.

Example

```
CONF: BURS: SPEC: ACPR
```

Configures the ACPR measurement type.

```
INIT
```

Starts an ACPR measurement.

Characteristics

RST value: -

SCPI: device-specific

Mode

OFDM, OFDMA/WiBro

CONFigure:BURSt:SPECTrum:ACPR:SElect

This command specifies the type of ACP measurement to be performed.

Parameter

ABSolute | RELative

Example

```
CONF: BURS: SPEC: ACPR: SEL ABS
```

Specifies the ACP measurement type absolute.

Characteristics

RST value: REL

SCPI: device-specific

Mode

OFDM, OFDMA/WiBro

CONFigure:BURSt:SPECTrum:FFT[:IMMediate]

This command configures the FFT (Fast Fourier Transform) measurement type.

This command is an event and therefore has no *RST value and no query.

Example

```
CONF: BURS: SPEC: FFT
```

Configures the FFT measurement type.

```
INIT
```

Starts an FFT measurement.

Characteristics

RST value: -

SCPI: device-specific

Mode

OFDM, OFDMA/WiBro

CONFigure:BURSt:SPECTrum:FLATness[:IMMediate]

This command configures the Spectrum Flatness measurement type. For settings for the Spectrum Flatness measurement see [CONFigure:BURSt:SPECTrum:FLATness:SElect](#) command.

This command is an event and therefore has no *RST value and no query.

Example

```
CONF: BURS: SPEC: FLAT
```

Configures the Spectrum Flatness measurement type.

```
INIT
```

Starts a Spectrum Flatness measurement.

Characteristics

RST value: -

SCPI: device-specific

Mode

OFDM, OFDMA/WiBro

CONFigure:BURSt:SPECTrum:FLATness:SElect

This command configures the interpretation of the Spectrum Flatness measurement results.

Parameter

FLATness	spectrum flatness
GRDelay	group delay
DIFFerence	flatness difference

Example

```
CONF: BURS: SPEC: FLAT
```

Configures the Spectrum Flatness measurement type.

```
CONF: BURS: SPEC: FLAT: SEL GRD
```

Configures the group delay for the Spectrum Flatness measurement.

Characteristics

RST value: FLAT

SCPI: device-specific

Mode

OFDM, OFDMA/WiBro

CONFigure:BURSt:SPECTrum:MASK[:IMMediate]

This command configures the Spectrum Mask measurement type. For settings for the Spectrum Mask measurement see [CONFigure:BURSt:SPECTrum:MASK:SElect](#) command.

This command is an event and therefore has no *RST value and no query.

Example

```
CONF: BURS: SPEC: MASK
```

Configures the Spectrum Mask measurement type.

```
INIT
```

Starts a Spectrum Mask measurement.

Characteristics

RST value: -

SCPI: device-specific

Mode

OFDM, OFDMA/WiBro

CONFigure:BURSt:SPECTrum:MASK:SElect

This command configures the interpretation of the Spectrum Mask measurement results..

Parameter

IEEE interpretation according to IEEE standard
ETSI interpretation according to ETSI standard

Example

```
CONF: BURS: SPEC: MASK
```

Configures the Spectrum Mask measurement type.

```
CONF: BURS: SPEC: MASK: SEL ETSI
```

The measurement results are interpreted using the ETSI standard.

Characteristics

RST value: -

SCPI: device-specific

Mode

OFDM, OFDMA/WiBro

CONFigure: BURSt: STATistics: BStReam[:IMMediate]

This command configures the Bitstream measurement type.

This command is an event and therefore has no *RST value and no query.

Example

```
CONF: BURS: STAT: BSTR
```

Configures the Bitstream measurement type.

```
INIT
```

Starts a Bitstream measurement.

Characteristics

RST value: -

SCPI: device-specific

Mode

OFDM, OFDMA/WiBro

CONFigure: BURSt: STATistics: BSUMmary[:IMMediate]

This command configures the Burst Summary measurement type.

This command is an event and therefore has no *RST value and no query.

Example

```
CONF: BURS: STAT: BSUM
```

Configures the Burst Summary measurement type.

```
INIT
```

Starts a the Burst Summary measurement.

Characteristics

RST value: -

SCPI: device-specific

Mode

OFDM, OFDMA/WiBro

CONFigure:BURSt:STATistics:CCDF[:IMMediate]

This command configures the CCDF (conditional cumulative distribution functions) measurement type.

This command is an event and therefore has no *RST value and no query.

Example

```
CONF: BURS: STAT: CCDF
```

Configures the CCDF measurement type.

```
INIT
```

Starts a CCDF measurement.

Characteristics

RST value: -

SCPI: device-specific

Mode

OFDM, OFDMA/WiBro

CONFigure:CHANnel

This command specifies the measurement input channel. This command will automatically cause the internal measurement frequency to be recalculated.

Parameter

0 to 3153

Example

```
CONF: CHAN 9
```

Defines the frequency of channel 9 as measurement range.

Characteristics

RST value: 0

SCPI: device-specific

Mode

OFDM

CONFigure:POWER:AUtO

This command switches on or off the automatic power level detection.

Parameter

ON | OFF | ONCE

Example

```
CONF: POW: AUtO ON
```

At the start of every measurement sweep the input power level is detected automatically.

Characteristics

RST value: -

SCPI: device-specific

Mode

OFDM, OFDMA/WiBro

CONFigure:POWer:AUTO:SWEep:TIME

This command specifies the sweep time for the automatic power level detection.

Parameter

1ms to 1s

Example

CONF:POW:AUTO ON

At the start of every measurement sweep the input power level is detected automatically.

CONF:POW:AUTO:SWE:TIME 200MS

The sweep time is set to 200 ms power level.

Characteristics

RST value: 100 ms

SCPI: device-specific

Mode

OFDM, OFDMA/WiBro

CONFigure:POWer:EXPeCted:RF

This command specifies the input power level of the source signal that will be supplied at the analyzer RF input.

Parameter

-999.99 dBm to 999.99 dBm

Example

CONF:POW:EXP:RF -20

Assumes an input signal strength of -20 dBm.

Characteristics

RST value: -30 dBm

SCPI: device-specific

Mode

OFDM, OFDMA/WiBro

CONFigure:STANdard

This command specifies the Wireless LAN standard to be measured.

Parameter

0	IEEE 802.16-2004	OFDM
1	IEEE 802.16e-2005	OFDMA
2	IEEE 802.16e-2005	WiBro

Example

CONF:STAN 0

The measurements will be performed according to IEEE 802.16-2004.

Characteristics

RST value: 1

SCPI: device-specific

ModeOFDM, OFDMA/WiBro

CONFigure:WiMax:AVERaging

This command specifies the RSSI, CINR averaging parameter.

Parameter

0.000001 to 0.999999

Example

```
CONF:WIM:AVER 0.1
```

Sets the value to 0.1

Characteristics

RST value: -

SCPI: device-specific

ModeOFDMA/WiBro

CONFigure:WiMax:DLSFrame:IDCell

This command specifies the downlink IDCell number. The downlink IDCell number is used as DL_PermBase parameter for the permutation equations to partly set the sub carrier randomizer initialization vector.

Parameter

0 to 31

Example

```
CONF:WIM:DLSF:IDC 0
```

Sets the downlink IDCell number to 0.

Characteristics

RST value: 0

SCPI: device-specific

ModeOFDMA/WiBro

CONFigure:WiMax:DLSFrame:PREamble:MODE

This command specifies how the preamble index is calculated.

Parameter

AUTO The preamble index is automatically calculated according to the parameters set by the [CONFigure:WiMax:DLSFrame:IDCell](#) and [CONFigure:WiMax:DLSFrame:SEGment<1...3>](#) commands.

USER The preamble index can be specified manually, i.e. the preamble pattern is chosen by the [CONFigure:WiMax:DLSFrame:PREamble:INDEX](#) command according to the standard.

Example

```
CONF:WIM:DLSF:PRE:MODE AUTO
```

Activates the automatic calculation of the preamble index.

Characteristics

RST value: USER

SCPI: device-specific

Mode

OFDMA/WiBro

CONFigure:WIMax:DLSFrame:PREamble:INDEX

This command specifies the preamble pattern (according to the standard) to be used.

Parameter

integer from 0 to 113

Example

```
CONF:WIM:DLSF:PMOD USER
```

Deactivates the automatic calculation of the preamble index.

```
CONF:WIM:DLSF:PRE:IND 31
```

Specifies the preamble pattern.

Characteristics

RST value: -

SCPI: device-specific

Mode

OFDMA/WiBro

CONFigure:WIMax:DLSFrame:SEGment<1...3>

This command specifies the allowable logical subchannel usage of the transmission spectrum for one of the three downlink PUSC segments.

Note that the indexes specified on the instrument are 0, whereas based under remote control they are 1 based. This means, the first segment on the instrument is labeled segment 0 and would be accessed with the command `CONF:WIM:DLSF:SEGM1`.

Parameter

0 to 63

Example

```
CONF:WIM:DLSF:SEGM1 63
```

Specifies the logical subchannel usage of the transmission spectrum for the first downlink PUSC segment to 63.

Characteristics

RST value: 0

SCPI: device-specific

Mode

OFDMA/WiBro

CONFigure:WIMax:FBANd

This command configures the Phase or Frequency vs Preamble measurement type.

Parameter

The suffix 1 can be omitted in the input (see list below) and is omitted in the output (see example).

Selection	Value	Range in GHz	Description
UNSPecified	Unspecified		
ETSI or ETSI1	ETSI	3.410-4.200	Licensed Band
ETSI2	ETSI	10.000-10.680	Licensed Band
MMDS or MMDS1	MMDS	2.150-2.162	Licensed Band
MMDS2	MMDS	2.500-2.690	Licensed Band
WCS or WCS1	WCS	2.305-2.320	Licensed Band
WCS2	WCS	2.345-2.360	Licensed Band
CEPT or CEPT1	CEPT	5.470-5.725	License Exempt Band
CEPT2	CEPT	5.725-5.875	License Exempt Band
UNII or UNII1	U-NII	5.250-5.350	License Exempt Band
UNII2	U-NII	5.725-5.825	License Exempt Band

Example

```
CONF:WIM:FBAN ETSI
```

Configures the frequency band to be ETSI 3.41GHz - 4.2GHz.

```
CONF:WIM:FBAN?
```

After frequency band is set to ETSI this will return "ETSI" as the current frequency band.

```
CONF:WIM:FBAN ETSI1
```

Configures the frequency band to be ETSI 3.41GHz - 4.2GHz.

```
CONF:WIM:FBAN?
```

After frequency band is set to ETSI1 this will return "ETSI" as the current frequency band.

```
CONF:WIM:FBAN ETSI2
```

Configures the frequency band to be ETSI 10.0GHz - 10.68GHz.

```
CONF:WIM:FBAN?
```

After frequency band is set to ETSI2 this will return "ETSI2" as the current frequency band.

```
INIT
```

Starts a Phase or Frequency vs Preamble measurement.

Characteristics

RST value: -

SCPI: device-specific

Mode

OFDM, OFDMA/WiBro

CONFigure:WIMax:IGRatio

This command specifies the number of guard samples.

Parameter

valid range: $\frac{T_g}{T_b} \in \{1/32, 1/16, 1/8, 1/4\}$

The ration can be set to one of four values - 4, 8, 16 or 32. The table below shows the relationship between these values and the number of guard samples.

Value	Guard samples (T_g/T_b)
4	1/4
8	1/8
16	1/16
32	1/32

Example

CONF:WIM:IGR 16
 Sets the number of guard samples to 1/16.

Characteristics

RST value: -
 SCPI: device-specific

Mode

OFDM, OFDMA/WiBro

CONFigure:WIMax:LMODe

This command specifies only to analyze the Down Link or Up Link bursts during a measurement.

Parameter

UL | DL

Example

CONF:WIM:LMODe UL
 Only the Up Link bursts are analyzed.

Characteristics

RST value: -
 SCPI: device-specific

Mode

OFDM, OFDMA/WiBro

CONFigure:WIMax:NFFT

This command specifies the current FFT size.

Parameter

FFT128	FFT size of 128 carriers
FFT512	FFT size of 512 carriers
FFT1024	FFT size of 1024 carriers
FFT2048	FFT size of 2048 carriers

Example

CONF:WIM:NFFT FFT2048
 Sets the FFT size to 2048 carriers.

Characteristics

RST value: FFT1024
 SCPI: device-specific

ModeOFDMA/WiBro

CONFigure:WIMax:TDDFrame:TTG

This command specifies the TDD frame TX Transition Gap (TTG).

Parameter

0 to 2 seconds

Example

```
CONF:WIM:TDDF:TTG 10us
```

Specifies the TDD frame TX Transition Gap as 10 μ s.

Characteristics

RST value: 5us

SCPI: device-specific

ModeOFDMA/WiBro

CONFigure:WIMax:ULSFrame:FRAME

This command selects the frame number of the uplink frame in which the UL map that specifies the uplink burst was transmitted.

Parameter

0 to 10

Example

```
CONF:WIM:ULSF:FRAM 0
```

Selects frame number 0.

Characteristics

RST value: 0

SCPI: device-specific

ModeOFDMA/WiBro

CONFigure:WIMax:ZONE<1...26>[:ANALyze]:STATe

This command sets a zone for analysis. This will come into effect when the next measurement is executed.

Parameter

ON | OFF

Example

```
CONF:WIM:ZONE1:ANAL ON
```

Sets zone 1 for analysis.

Characteristics

RST value: -

SCPI: device-specific

Mode

OFDMA/WiBro

CONFigure:WIMax:ZONE<1...26>:BURSt<1...32>:CONTrol[:DATA]

This command associates a burst definition with a specific zone. A zone may have up to 32 bursts defined within it.

New bursts can only be appended to the end of the existing burst list. For example if 4 bursts are already defined, then the suffix required to enter a new burst is 5.

Parameter

<Modulation>, <Subchannels>, <Symbols>, <Slot Duration>, <Subchannel Offset>, <Symbol Offset>, <Burst Power>, <Burst Type>

with:

<Modulation>	QPSK_1_2 QPSK_3_4 QAM16_1_2 QAM16_3_4 QAM64_1_2 QAM64_2_3 QAM64_3_4	modulation scheme
<Subchannels>	<numeric_value>	number of subchannels used by the burst
<Symbols>	<numeric_value>	number of symbols used by the burst
<Slot Duration>	<numeric_value>	slot duration (only applies to uplink and ignored by downlink bursts)
<Subchannel Offset>	<numeric_value>	subchannel offset of the burst
<Symbol Offset>	<numeric_value>	symbol offset of the burst
<Burst Power>	<numeric_value>	Defines the boosting power of the burst.
<Burst Type>	FCH DLMAP ULMAP DATA	burst type

For further details refer to chapter "Instrument Functions", section "WiMAX, WiBro Measurements (Options K92/K93)", **Burst List** description.

Example

CONF:WIM:ZONE1:BURS1:CONT QAM16_1_2,1D2,5,10,20,0,0,0, DATA
 Defines a 16 QAM 1/2 burst using 5 subchannels and 10 symbols.

Characteristics

RST value: -

SCPI: device-specific

Mode

OFDMA/WiBro

CONFigure:WIMax:ZONE<1...26>:BURSt<1...32>:COUNT?

This command returns the current count of user defined bursts within the specified zone.

This command is only a query and therefore has no *RST value.

Example

CONF:WIM:ZONE1:BURS1:COUN?
 Returns the user defined bursts within zone 1.

Characteristics

RST value: -

SCPI: device-specific

Mode

OFDMA/WiBro

CONFigure:WIMax:ZONE<1...26>:BURSt<1...32>:DELeTe

This command deletes a specific burst from within the specified zone.

Example

```
CONF:WIM:ZONE1:BURS1:DEL
Deletes burst 1 from zone 1.
```

Characteristics

RST value: -

SCPI: device-specific

Mode

OFDMA/WiBro

CONFigure:WIMax:ZONE<1...26>:BURSt<1...32>:FORMat

This command specifies the burst modulation format for the specified zone.

Parameter

QPSK1D2	QPSK code rate 1/2
QPSK3D4	QPSK code rate 3/4
QAM16_1D2	16 QAM code rate 1/2
QAM16_3D4	16 QAM code rate 3/4
QAM64_1D2	64 QAM code rate 1/2
QAM64_2D3	64 QAM code rate 2/3
QAM64_3D4	64 QAM code rate 3/4

Example

```
CONF:WIM:ZONE1:BURS1:FORM QAM64_3D4
Sets the burst modulation format to QAM64_3D4.
```

Characteristics

RST value: -

SCPI: device-specific

Mode

OFDMA/WiBro

CONFigure:WIMax:ZONE<1...26>:BURSt<1...32>:OFFSet:AUTO

This command allows, for the specified zone and burst, the logical subchannel and symbol offsets to be automatically calculated so that they are contiguous. The command only applies to uplink bursts.

Parameter

ON | OFF

Example

```
CONF:WIM:ZONE1:BURS1:OFFS:AUTO ON
```

Activates the automatic calculation of the logical subchannel and symbol offsets.

Characteristics

RST value: -

SCPI: device-specific

Mode

OFDMA/WiBro

CONFigure:WIMax:ZONE<1...26>:BURSt<1...32>:POWer

This command specifies, for the specified zone and burst, the boosting power associated with the burst.

Parameter

-80 to 10

Example

```
CONF:WIM:ZONE1:BURS1:POW 0
```

Sets the boosting power associated with the burst to 0.

Characteristics

RST value: -

SCPI: device-specific

Mode

OFDMA/WiBro

CONFigure:WIMax:ZONE<1...26>:BURSt<1...32>:SLOT:DURation

This command defines, for the specified zone and burst, the duration of an uplink burst in slots in seconds. The command has no effect on downlink bursts.

Parameter

1 to 3000

Example

```
CONF:WIM:ZONE1:BURS1:SLOT:DUR 10
```

Sets the duration of uplink burst 1 to 10.

Characteristics

RST value: -

SCPI: device-specific

Mode

OFDMA/WiBro

CONFigure:WIMax:ZONE<1...26>:BURSt<1...32>:SUBChannel:COUNT

This command defines, for the specified zone and burst, the number of logical subchannels used by the burst.

Parameter

1 to 60

Example

```
CONF:WIM:ZONE1:BURS1:SUBC:COUN 5
```

Sets the number of logical subchannels used by burst 1 to 5.

Characteristics

RST value: -

SCPI: device-specific

Mode

OFDMA/WiBro

CONFigure:WIMax:ZONE<1...26>:BURSt<1...32>:SUBChannel:OFFSet

This command defines, for the specified zone and burst, the logical subchannels offset for the burst. This, together with the symbol offset, can be used to specify the frequency bandwidth in use by specific bursts.

Parameter

0 to 60

Example

```
CONF:WIM:ZONE1:BURS1:SUBC:OFFS 5
```

Sets the subchannels offset for burst 1 to 5.

Characteristics

RST value: -

SCPI: device-specific

Mode

OFDMA/WiBro

CONFigure:WIMax:ZONE<1...26>:BURSt<1...32>:SYMBol:COUNT

This command defines, for the specified zone and burst, the number of symbols used by the burst.

Parameter

1 to 1000

Example

```
CONF:WIM:ZONE1:BURS1:SYMB:COUN 5
```

Sets the number of symbols used by burst 1 to 5.

Characteristics

RST value: -

SCPI: device-specific

Mode

OFDMA/WiBro

CONFigure:WIMax:ZONE<1...26>:BURSt<1...32>:SYMBol:OFFSet

This command defines, for the specified zone and burst, the symbol offset for the burst. This, together with the logical subchannel offset, can be used to specify the frequency bandwidth in use by specific bursts.

Parameter

0 to 1000

Example

CONF:WIM:ZONE1:BURS1:SYMB:OFFS 5
Sets the symbol offset for burst 1 to 5.

Characteristics

RST value: -

SCPI: device-specific

Mode

OFDMA/WiBro

CONFigure:WIMax:ZONE<1...26>:BURSt<1...32>:TYPE

For the specified zone and burst, this command specifies the type of burst from the protocol layer perspective, i.e. if the burst contains signaling information or if it is just a data burst.

Parameter

FCH frame control header
DLMAP downlink map
ULMAP uplink map
DATA data burst

Example

ONF:WIM:ZONE1:BURS1:TYPE DATA
Burst 1 is a data burst.

Characteristics

RST value: -

SCPI: device-specific

Mode

OFDMA/WiBro

CONFigure:WIMax:ZONE<1...26>:CONTrol[:DATA]

This command adds a new zone. Up to 26 user zones can be defined.

New zones can only be appended to the end of the existing defined zones. For example, if 4 zones are already defined, then the suffix required to enter a new zone is 5.

Parameter

<Analyze>,<Type>,<Segment>,<Length>,<Offset>,<Permbase>,<PRBS_ID>

with:

<Analyze>	ON OFF	Specifies whether the zone is too be marked for analysis.
<Type>	DLFUSC DLPUSC ULPUSC	zone type: downlink FUSC (Fully Used Subchannelization) zone, downlink PUSC (Partial Used Subchannelization)

		zone, or uplink PUSC zone
<Segment>	0 1 2	downlink PUSC zone segment
<Length>	<numeric_value>	zone symbol length
<Offset>	<numeric_value>	zone symbol offset
<Permbase>	<numeric_value>	permbase to be used for channel decoding
<PRBS_ID>	<numeric_value>	PRBS to be used for channel decoding

For further details refer to chapter "Instrument Functions", "WiMAX, WiBro Measurements (Options K92/K93)", **Zone/Segment List** description.

Example

```
CONF:WIM:ZONE1:CONT ON,DLFUSC,0,10,0,0,0
```

Adds a DL_PUSC zone with a length of 10 symbols.

Characteristics

RST value: -
SCPI: device-specific

Mode

OFDMA/WiBro

CONFigure:WIMax:ZONE<1...26>:COUNT?

This command returns the current count of the specified zone.
This command is only a query and therefore has no *RST value.

Example

```
CONF:WIM:ZONE1:COUN?
```

Returns the count of zone 1.

Characteristics

RST value: -
SCPI: device-specific

Mode

OFDMA/WiBro

CONFigure:WIMax:ZONE<1...26>:DELeTe

This command deletes a specific zone. If the specified zone is within a larger list of zones, then all following zones will be shuffled down to take up the space occupied by the deleted zone.
This command is an event and therefore has no *RST value and no query.

Example

```
CONF:WIM:ZONE1:DEL
```

Deletes zone 1.

Characteristics

RST value: -
SCPI: device-specific

Mode

OFDMA/WiBro

CONFigure:WIMax:ZONE<1...26>:IDSegment

This command specifies the segment number associated with the zone. This is only valid for PUSC zones and will have no effect on other zone types.

Parameter

0 | 1 | 2

Example

```
CONF:WIM:ZONE1:IDS 0
```

Sets the segment number for zone 1 to 0.

Characteristics

RST value: -

SCPI: device-specific

Mode

OFDMA/WiBro

CONFigure:WIMax:ZONE<1...26>:PERMbase

This command specifies the perm base which is used in the permutation equations for the specified zone.

Parameter

0 to 31

Example

```
CONF:WIM:ZONE1:PERM 0
```

For zone 1, perm base 0 is used in the permutation equations.

Characteristics

RST value: -

SCPI: device-specific

Mode

OFDMA/WiBro

CONFigure:WIMax:ZONE<1...26>:PRBS

This command specifies a known PRBS (pseudo random binary sequence) modulated data sequence that is in use by the DUT of the specified zone.

Parameter

0, 1, 2, 3

Example

```
CONF:WIM:ZONE1:PRBS 0
```

Sets the PRBS to 0.

Characteristics

RST value: -

SCPI: device-specific

Mode

OFDMA/WiBro

CONFigure:WIMax:ZONE<1...26>:SYMB:OFFSet

This command specifies the symbol offset associated with the specified zone. This is used to analyze signals which contain multiple zones and allows any zone in a subframe to be set up for analysis.

Parameter

1 to 1000

Example

```
CONF:WIM:ZONE1:SYMB:OFFS 0
```

Sets the symbol offset for zone 1 to 0.

Characteristics

RST value: -

SCPI: device-specific

Mode

OFDMA/WiBro

CONFigure:WIMax:ZONE<1...26>:SYMB:COUNT

This command specifies the number of symbols defined to the specified zone.

Parameter

1 to 1000

Example

```
CONF:WIM:ZONE1:SYMB:COUNT 10
```

Sets the number of symbols for zone 1 to 10.

Characteristics

RST value: -

SCPI: device-specific

Mode

OFDMA/WiBro

CONFigure:WIMax:ZONE<1...26>:TYPE

This command specifies the zone type of the specified zone.

Parameter

DLFUSC downlink FUSC zone

DLPUSC downlink PUSC zone

ULPUSC uplink PUSC zone

Example

```
CONF:WIM:ZONE1:TYPE DLPUSC
```

Specifies zone 1 as downlink PUSC zone.

Characteristics

RST value: -

SCPI: device-specific

Mode

OFDMA/WiBro

DISPlay Subsystem (WiMAX, K92/K93)

The DISPlay subsystem controls the selection and presentation of textual and graphic information as well as of measurement data on the display. In contrast to the base unit, the WiMAX IEEE 802.16 OFDM, OFDMA Measurements option supports the split screen modus.

Commands of the DISPlay Subsystem

- DISPlay:FORMat
- DISPlay[:WINDow<1|2>]:SElect
- DISPlay[:WINDow<1|2>]:SSElect
- DISPlay[:WINDow<1|2>]:TABLe
- DISPlay[:WINDow<1|2>]:TABLe:UNIT
- DISPlay[:WINDow<1|2>]:TRACe1:Y[:SCALe]:AUTO
- DISPlay[:WINDow<1|2>]:TRACe1:Y[:SCALe]:PDIVision
- DISPlay[:WINDow<1|2>]:TRACe<1...3>:Y[:SCALe]:RLEVel[:RF]
- DISPlay[:WINDow<1|2>]:TRACe<1...3>:Y[:SCALe]:RLEVel?
- DISPlay[:WINDow<1|2>]:TRACe<1...3>:Y[:SCALe]:RLEVel:OFFSet

DISPlay:FORMat

This command sets the screen display type to full or split screen.

Parameter

SPLit | SINGle

Example

```
DISP:FORM SING
```

Sets the display to full screen.

Characteristics

RST value: SPLit

SCPI: device-specific

Mode

OFDM, OFDMA/WiBro

DISPlay[:WINDow<1|2>]:SElect

This command selects whether screen A or screen B is active (see also [DISPlay\[:WINDow<1|2>\]:SSElect](#))

Example

```
DISP:WIND1 SEL
```

Sets screen A active.

Characteristics

RST value: -

SCPI: device-specific

Mode

OFDMA/WiBro

DISPlay[:WINDow<1|2>]:SSElect

This command selects whether screen A or screen B is active. The numeric suffix <1|2> defines the active window.

Example

```
DISP:WIND1:SSEL  
Sets screen A active.
```

Characteristics

RST value: -

SCPI: device-specific

Mode

OFDM, OFDMA/WiBro

DISPlay[:WINDow<1|2>]:TABLe

This command shows or hides the results table.
The numeric suffix <1|2> defines the active window.

Parameter

ON | OFF

Example

```
DISP:TABL OFF  
Hides the results table.
```

Characteristics

RST value: OFF

SCPI: device-specific

Mode

OFDM, OFDMA/WiBro

DISPlay[:WINDow<1|2>]:TABLe:UNIT

This command specifies the unit for the parameters listed in the results table.
The numeric suffix <1|2> defines the active window.

Parameter

DB results returned in dB

PCT results returned in percent

Example

```
DISP:TABL:UNIT DB  
Results are returned in dB.
```

Characteristics

RST value: DB

SCPI: device-specific

Mode

OFDM, OFDMA/WiBro

DISPlay[:WINDow<1|2>]:TRACe1:Y[:SCALe]:AUTO

This command switches on or off automatic scaling of the y-axis for trace 1. If switched on, the y-axis is scaled to best fit the measurement results automatically.

The numeric suffix <1|2> defines the active window.

This command is only available for the following result displays:

- EVM vs Carrier
- EVM vs Symbol

Parameter

ON | OFF

Example

```
DISP:WIND2:TRAC1:Y:AUTO ON
```

Switches on automatic scaling of the y-axis for the active trace.

Characteristics

RST value: ON

SCPI: conform

Mode

OFDM, OFDMA/WiBro

DISPlay[:WINDow<1|2>]:TRACe1:Y[:SCALe]:PDIVision

This command sets the size of each y scale division for trace 1. It has no affect if automatic scaling of the y-axis is enabled.

The numeric suffix <1|2> defines the active window.

This command is only available for the following result displays:

- EVM vs Carrier
- EVM vs Symbol

Parameter

1E-6 to 10E12

Example

```
DISP:WIND2:TRAC1:Y:AUTO OFF
```

Switches off automatic scaling of the y-axis for the active trace.

```
DISP:WIND2:TRAC1:Y:PDIV 2
```

Sets the y scale division to size 2.

Characteristics

RST value: 3

SCPI: conform

Mode

OFDM, OFDMA/WiBro

DISPlay[:WINDow<1|2>]:TRACe<1...3>:Y[:SCALe]:RLEVel[:RF]

This command specifies the reference level applied to an RF measurements.
The numeric suffixes of WINDow<1|2> and TRACe<1 to 3> are irrelevant.

Parameter

<numeric_value> in dBm, range specified in data sheet

Example

```
DISP:TRAC:Y:RLEV 10
```

Reference level of the analyzer is 10 dB

```
DISP:TRAC:Y:RLEV:RF -10
```

Reference level of the analyzer is -10 dB

Characteristics

RST value: 0 dB

SCPI: conform

Mode

OFDM, OFDMA/WiBro

DISPlay[:WINDow<1|2>]:TRACe<1...3>:Y[:SCALe]:RLEVel?

This command queries the current internal instrument reference level used when performing measurements.

The numeric suffixes of WINDow<1|2> and TRACe<1 to 3> are irrelevant.

This command is only a query and therefore has no *RST value.

Example

```
DISP:TRAC:Y:RLEV?
```

Returns the current reference level in use.

Characteristics

RST value: -

SCPI: conform

Mode

OFDM, OFDMA/WiBro

DISPlay[:WINDow<1|2>]:TRACe<1...3>:Y[:SCALe]:RLEVel:OFFSet

This command specifies the external attenuation/gain applied to measurements. The value corresponds to the reference level offset in spectrum analyzer mode (see [DISPlay\[:WINDow<1|2>\]:TRACe<1...6>:Y\[:SCALe\]:RLEVel:OFFSet](#) command).

The numeric suffixes of WINDow<1|2> and TRACe<1 to 3> are irrelevant.

Parameter

-200 to 200 dB

Example

```
DISP:TRAC:Y:RLEV:OFFS 10
```

External attenuation (level offset) of the analyzer is 10 dB

```
DISP:TRAC:Y:RLEV:OFFS -10
```

External attenuation of the analyzer is -10 dB. i.e. a gain of 10 dB

Characteristics

RST value: 0 dB

SCPI: conform

Mode

OFDM, OFDMA/WiBro

FETCh Subsystem (WiMAX, K92/K93)

The FETCh subsystem contains commands for reading out results of complex measurement tasks. This subsystem is closely linked to the CONFigure and SENSE subsystems.

Commands of the FETCh Subsystem

- FETCh:BURSt:ALL?
- FETCh:BURSt:CINR?
- FETCh:BURSt:CINR:AVERAge?
- FETCh:BURSt:CINR:MAXimum?
- FETCh:BURSt:CINR:MINimum?
- FETCh:BURSt:COUNt?
- FETCh:BURSt:CRESt:AVERAge?
- FETCh:BURSt:CRESt:MAXimum?
- FETCh:BURSt:CRESt:MINimum?
- FETCh:BURSt:EVM:ALL:AVERAge?
- FETCh:BURSt:EVM:ALL:MAXimum?
- FETCh:BURSt:EVM:ALL:MINimum?
- FETCh:BURSt:EVM:DATA:AVERAge?
- FETCh:BURSt:EVM:DATA:MAXimum?
- FETCh:BURSt:EVM:DATA:MINimum?
- FETCh:BURSt:EVM:PILOt:AVERAge?
- FETCh:BURSt:EVM:PILOt:MAXimum?
- FETCh:BURSt:EVM:PILOt:MINimum?
- FETCh:BURSt:FERRor:AVERAge?
- FETCh:BURSt:FERRor:MAXimum?
- FETCh:BURSt:FERRor:MINimum?
- FETCh:BURSt:GIMBalance:AVERAge?
- FETCh:BURSt:GIMBalance:MAXimum?
- FETCh:BURSt:GIMBalance:MINimum?
- FETCh:BURSt:IQOFfset:AVERAge?
- FETCh:BURSt:IQOFfset:MAXimum?
- FETCh:BURSt:IQOFfset:MINimum?
- FETCh:BURSt:QUADOffset:AVERAge?
- FETCh:BURSt:QUADOffset:MAXimum?
- FETCh:BURSt:QUADOffset:MINimum?
- FETCh:BURSt:RMS:ALL:AVERAge?
- FETCh:BURSt:RMS:ALL:MAXimum?
- FETCh:BURSt:RMS:ALL:MINimum?

- FETCh:BURSt:RMS:AVERage?
- FETCh:BURSt:RMS:DATA:AVERage?
- FETCh:BURSt:RMS:DATA:MAXimum?
- FETCh:BURSt:RMS:DATA:MINimum?
- FETCh:BURSt:RMS:DLPreamble:AVERage?
- FETCh:BURSt:RMS:DLPreamble:MAXimum?
- FETCh:BURSt:RMS:DLPreamble:MINimum?
- FETCh:BURSt:RMS:MAXimum?
- FETCh:BURSt:RMS:MINimum?
- FETCh:BURSt:RMS:PILot:AVERage?
- FETCh:BURSt:RMS:PILot:MAXimum?
- FETCh:BURSt:RMS:PILot:MINimum?
- FETCh:BURSt:RSSI?
- FETCh:BURSt:RSSi:AVERage?
- FETCh:BURSt:RSSi:MAXimum?
- FETCh:BURSt:RSSi:MINimum?
- FETCh:BURSt:SYMBOLerror:AVERage?
- FETCh:BURSt:SYMBOLerror:MAXimum?
- FETCh:BURSt:SYMBOLerror:MINimum?
- FETCh:BURSt:TDOMain:PREamble?
- FETCh:BURSt:TDOMain:SUBFrame?
- FETCh:BURSt:TDOMain:ZONE?
- FETCh:SYMBOL:COUNT?
- FETCh:ZONE:COUNT?

Further information

- "ASCII formats for returned values" on page 6.809

ASCII formats for returned values

The results are output as a list of result strings separated by commas.

OFDM results

<min EVM all bursts>,<average EVM all bursts>,<max EVM all bursts>
<min EVM data carriers>,<average EVM data carriers>,<max EVM data carriers>
<min EVM pilots>,<average EVM pilots>,<max EVM pilots>
<min IQ offset>,<average IQ offset>,<maximum IQ offset>
<min gain imbalance>,<average gain imbalance>,<max gain imbalance>
<min quadrature offset>,<average quadrature offset>,<max quadrature offset>
<min frequency error>,<average frequency error>,<max frequency error>
<min symbol error>,<average symbol error>,<max symbol error>
<min burst power>,<average burst power>,<max burst power>
<min crest factor>,<average crest factor>,<max crest factor>
<min SS timing>,<average SS timing>,<max SS timing>
<min RSSI>,<average RSSI>,<max RSSI>
<min RSSI Standard Deviation>,<average RSSI Standard Deviation>,<max RSSI Standard Deviation>
<min CINR>,<average CINR>,<max CINR>
<min CINR Standard Deviation>,<average CINR Standard Deviation>,<max CINR Standard Deviation>

OFMDA Uplink results

<min BER pilots>,<average BER pilots>,<max BER pilots>
<min EVM all bursts>,<average EVM all bursts>,<max EVM all bursts>
<min EVM data carriers>,<average EVM data carriers>,<max EVM data carriers>
<min EVM pilots>,<average EVM pilots>,<max EVM pilots>
<min IQ offset>,<average IQ offset>,<maximum IQ offset>
<min gain imbalance>,<average gain imbalance>,<max gain imbalance>
<min quadrature offset>,<average quadrature offset>,<max quadrature offset>
<min frequency error>,<average frequency error>,<max frequency error>
<min symbol error>,<average symbol error>,<max symbol error>
<min power all>,<average power all>,<max power all>
<min power data>,<average power data>,<max power data>
<min power pilots>,<average power pilots>,<max power pilots>
<min crest factor>,<average crest factor>,<max crest factor>

OFDMA Downlink results

<min BER pilots>,<average BER pilots>,<max BER pilots>
 <min EVM all bursts>,<average EVM all bursts>,<max EVM all bursts>
 <min EVM data carriers>,<average EVM data carriers>,<max EVM data carriers>
 <min EVM pilots>,<average EVM pilots>,<max EVM pilots>
 <min IQ offset>,<average IQ offset>,<maximum IQ offset>
 <min gain imbalance>,<average gain imbalance>,<max gain imbalance>
 <min quadrature offset>,<average quadrature offset>,<max quadrature offset>
 <min frequency error>,<average frequency error>,<max frequency error>
 <min symbol error>,<average symbol error>,<max symbol error>
 <min power DL preamble>,<average power DL preamble>,<max power DL preamble>
 <min power all>,<average power all>,<max power all>
 <min power data>,<average power data>,<max power data>
 <min power pilots>,<average power pilots>,<max power pilots>
 <min crest factor>,<average crest factor>,<max crest factor>
 <min RSSI>,<average RSSI>,<max RSSI>,<RSSI Standard Deviation>
 <min CINR>,<average CINR>,<max CINR>,<CINR Standard Deviation>

FETCh:BURSt:ALL?

This command returns all the results. The results are output as a list of result strings separated by commas in ASCII format. For details on the format refer to "[ASCII formats for returned values](#)" on page 6.809. The units for the EVM results are specified with the `UNIT:EVM` command.

This command is only a query and therefore has no *RST value.

Example

```
FETCh:BURSt:ALL?
```

All calculated results are returned.

Characteristics

RST value: -

SCPI: device-specific

Mode

OFDM, OFDMA/WiBro

FETCh:BURSt:CINR?

This command returns all the CINR results separated by commas. For details on the format refer to "[ASCII formats for returned values](#)" on page 6.809.

This command is only a query and therefore has no *RST value.

Example

```
FETCh:BURSt:CINR?
```

The calculated CINR results from the most recent measurement are returned.

Characteristics

RST value: -

SCPI: device-specific

ModeOFDM, OFDMA/WiBro

FETCh:BURSt:CINR:AVERAge? / FETCh:BURSt:CINR:MINimum? / FETCh:BURSt:CINR:MAXimum?

This command returns the determined CINR (carrier to interference and noise ratio) standard deviation value (average, minimum or maximum value). The result is returned in ASCII format.

This command is only a query and therefore has no *RST value.

Example

FETC: BURS: RSS: MAX?

The calculated maximum CINR value is returned.

Characteristics

RST value: -

SCPI: device-specific

ModeOFDMA/WiBro

FETCh:BURSt:COUNt?

This command returns the number of bursts analyzed in the last sweep.

This command is only a query and therefore has no *RST value.

Example

FETC: BURS: COUN?

The number of analyzed bursts in the most recent measurement is returned.

Characteristics

RST value: -

SCPI: device-specific

ModeOFDM, OFDMA/WiBro

FETCh:BURSt:CRESt:AVERAge? / FETCh:BURSt:CRESt:MAXimum? / FETCh:BURSt:CRESt:MINimum?

This command returns the determined crest factor (average, minimum or maximum value) in dBm. The crest factor is the ratio of peak power to average power.

This command is only a query and therefore has no *RST value.

Example

FETC: BURS: CRES: MAX?

The calculated maximum crest factor from the most recent measurement is returned.

Characteristics

RST value: -

SCPI: device-specific

Mode

OFDM, OFDMA/WiBro

FETCh:BURSt:EVM:ALL:AVERAge? / FETCh:BURSt:EVM:ALL:MAXimum? / FETCh:BURSt:EVM:ALL:MINimum?

This command returns the Error Vector Magnitude (EVM) measurement results summary (average, minimum or maximum value) in dB. The results summary is a combined figure that represents the pilot, data and the free carrier.

This command is only a query and therefore has no *RST value.

Example

`FETC:BURS:EVM:ALL:MIN?`

The minimum Error Vector Magnitude value is returned.

Characteristics

RST value: -

SCPI: device-specific

Mode

OFDM, OFDMA/WiBro

FETCh:BURSt:EVM:DATA:AVERAge? / FETCh:BURSt:EVM:DATA:MAXimum? / FETCh:BURSt:EVM:DATA:MINimum?

This command returns the Error Vector Management measurement results summary (average, minimum or maximum value) for the data carrier in dB.

This command is only a query and therefore has no *RST value.

Example

`FETC:BURS:EVM:DATA:MAX?`

The maximum EVM recorded for the data carrier is returned.

Characteristics

RST value: -

SCPI: device-specific

Mode

OFDM, OFDMA/WiBro

FETCh:BURSt:EVM:PILot:AVERAge? / FETCh:BURSt:EVM:PILot:MAXimum? / FETCh:BURSt:EVM:PILot:MINimum?

This command returns the Error Vector Management measurement results summary for the EVM pilot carrier in dB.

This command is only a query and therefore has no *RST value.

Example

`FETC:BURS:EVM:PIL:MAX?`

The maximum EVM recorded for the EVM pilot carrier is returned.

Characteristics

RST value: -

SCPI: device-specific

ModeOFDM, OFDMA/WiBro

FETCh:BURSt:FERRor:AVERAge? / FETCh:BURSt:FERRor:MAXimum? / FETCh:BURSt:FERRor:MINimum?

This command returns the measured average, minimum or maximum frequency errors in Hz.???

This command is only a query and therefore has no *RST value.

Example

```
FETC: BURS: FERR: MAX?
```

The maximum frequency error from the most recent measurement is returned.

Characteristics

RST value: -

SCPI: device-specific

ModeOFDM, OFDMA/WiBro

FETCh:BURSt:GIMBalance:AVERAge? / FETCh:BURSt:GIMBalance:MAXimum? / FETCh:BURSt:GIMBalance:MINimum?

This command returns the measured average, minimum or maximum IQ imbalance errors in dB.

This command is only a query and therefore has no *RST value.

Example

```
FETC: BURS: GIMB: MAX?
```

The maximum IQ Imbalance error from the most recent measurement is returned.

Characteristics

RST value: -

SCPI: device-specific

ModeOFDM, OFDMA/WiBro

FETCh:BURSt:IQOFfset:AVERAge? / FETCh:BURSt:IQOFfset:MAXimum? / FETCh:BURSt:IQOFfset:MINimum?

This command returns the measured average, minimum or maximum IQ offset errors in dB.

This command is only a query and therefore has no *RST value.

Example

```
FETC: BURS: IQOF: MAX?
```

The maximum IQ Offset error from the most recent measurement is returned.

Characteristics

RST value: -

SCPI: device-specific

ModeOFDM, OFDMA/WiBro

FETCh:BURSt:QUADoffset:AVERAge? / FETCh:BURSt:QUADoffset:MAXimum? / FETCh:BURSt:QUADoffset:MINimum?

This command returns the accuracy in terms of the phase error of symbols within a burst.
 This command is only a query and therefore has no *RST value.

Example

`FETC : BURS : QUAD : MAX?`

The maximum angle error recorded for a symbol during the measurement.

Characteristics

RST value: -

SCPI: device-specific

Mode

OFDM, OFDMA/WiBro

FETCh:BURSt:RMS:ALL:AVERAge? / FETCh:BURSt:RMS:ALL:MAXimum? / FETCh:BURSt:RMS:ALL:MINimum?

This command returns the average, minimum or maximum RMS burst power in dBm for all carriers measured during the measurement.

This command is only a query and therefore has no *RST value.

Example

`FETC : BURS : RMS : ALL : MAX?`

The maximum RMS burst power for all carriers recorded during the most recent measurement is returned.

Characteristics

RST value: -

SCPI: device-specific

Mode

OFDM

FETCh:BURSt:RMS:AVERAge? / FETCh:BURSt:RMS:MAXimum? / FETCh:BURSt:RMS:MINimum?

This command returns the average, minimum or maximum RMS burst power in dBm measured during the measurement.

This command is only a query and therefore has no *RST value.

Example

`FETC : BURS : RMS : MAX?`

The maximum burst power recorded for the most recent measurement is returned.

Characteristics

RST value: -

SCPI: device-specific

Mode

OFDM

FETCh:BURSt:RMS:DATA:AVERAge? / FETCh:BURSt:RMS:DATA:MAXimum? / FETCh:BURSt:RMS:DATA:MINimum?

This command returns the average, minimum or maximum RMS burst power in dBm for data carriers measured during the measurement.

This command is only a query and therefore has no *RST value.

Example

```
FETC : BURSt : RMS : DATA : MAX ?
```

The maximum RMS burst power for data carriers from the most recent measurement is returned.

Characteristics

RST value: -

SCPI: device-specific

Mode

OFDM

FETCh:BURSt:RMS:DLPreable:AVERAge? / FETCh:BURSt:RMS:DLPreable:MAXimum? / FETCh:BURSt:RMS:DLPreable:MINimum?

This command returns the average, minimum or maximum RMS burst power in dBm for the downlink preamble measured during the measurement.

This command is only a query and therefore has no *RST value.

Example

```
FETC : BURSt : RMS : DLPR : MAX ?
```

The maximum RMS burst power for the downlink preamble from the most recent measurement is returned.

Characteristics

RST value: -

SCPI: device-specific

Mode

OFDM

FETCh:BURSt:RMS:PILot:AVERAge? / FETCh:BURSt:RMS:PILot:MAXimum? / FETCh:BURSt:RMS:PILot:MINimum?

This command returns the average, minimum or maximum RMS burst power in dBm for pilot carriers measured during the measurement.

This command is only a query and therefore has no *RST value.

Example

```
FETC : BURSt : RMS : PIL : MAX ?
```

The maximum RMS burst power for pilot carriers from the most recent measurement is returned.

Characteristics

RST value: -

SCPI: device-specific

Mode

OFDM

FETCh:BURSt:RSSI?

This command returns all the received signal strength indicator (RSSI) results separated by commas. For details on the format refer to "[ASCII formats for returned values](#)" on page 6.809.

This command is only a query and therefore has no *RST value.

Example

```
FETC:BURS:RSSI?
```

The calculated RSSI results from the most recent measurement is returned.

Characteristics

RST value: -

SCPI: device-specific

Mode

OFDM, OFDMA/WiBro

FETCh:BURSt:RSSi:AVERAge? / FETCh:BURSt:RSSi:MAXimum? / FETCh:BURSt:RSSi:MINimum?

This command returns the average, minimum or maximum RSSI (received signal strength indicator) standard deviation value. This is an estimate of the total received power of the frame preamble of the segment of the connected BS. For details on the format refer to "[ASCII formats for returned values](#)" on page 6.809.

This command is only a query and therefore has no *RST value.

Example

```
FETC:BURS:RSS:MAX?
```

The maximum RSSI deviation value from the most recent measurement is returned.

Characteristics

RST value: -

SCPI: device-specific

Mode

OFDM, OFDMA/WiBro

FETCh:BURSt:SYMBOLerror:AVERAge? / FETCh:BURSt:SYMBOLerror:MAXimum? / FETCh:BURSt:SYMBOLerror:MINimum?

This command returns the percentage of symbols that were outside permissible demodulation range within a burst..

This command is only a query and therefore has no *RST value.

Example

```
FETC:BURS:SYMB:MAX?
```

The maximum number of symbols that were out of range per burst is returned.

Characteristics

RST value: -

SCPI: device-specific

Mode

OFDM, OFDMA/WiBro

FETCh:BURSt:TDOMain:PREamble?

This command returns the minimum, average and maximum preamble time domain values. The result is returned in (ASCII) format.

This command is only a query and therefore has no *RST value.

Example

```
FETC : BURS : TDOM : PRE ?
```

Returns the minimum, average and maximum preamble time domain values.

Characteristics

RST value: -

SCPI: device-specific

Mode

OFDMA/WiBro

FETCh:BURSt:TDOMain:SUBFrame?

This command returns the minimum, average and maximum subframe time domain values. The result is returned in (ASCII) format.

This command is only a query and therefore has no *RST value.

Example

```
FETC : BURS : TDOM : SUBF ?
```

Returns the minimum, average and maximum subframe time domain values.

Characteristics

RST value: -

SCPI: device-specific

Mode

OFDMA/WiBro

FETCh:BURSt:TDOMain:ZONE?

This command returns the minimum, average and maximum zone time domain values. The result is returned in (ASCII) format.

This command is only a query and therefore has no *RST value.

Example

```
FETC : BURS : TDOM : ZONE ?
```

Returns the minimum, average and maximum zone time domain values.

Characteristics

RST value: -

SCPI: device-specific

Mode

OFDMA/WiBro

FETCh:SYMBol:COUNT?

This command returns the number of symbol in each analyzed burst found in the last measurement sweep. The results are output as a list of result strings separated by commas in the following (ASCII) format:

<Symbols in 1st burst>,< Symbols in 2nd burst >, ..., < Symbols in last burst >

This command is only a query and therefore has no *RST value.

Example

FETC:SYMB:COUN?

The calculated symbols in the analyzed bursts for the most recent measurement are returned.

Characteristics

RST value: -

SCPI: device-specific

Mode

OFDM, OFDMA/WiBro

FETCh:ZONE:COUNT?

This command returns the current number of zones found during measurement analysis.

This command is only a query and therefore has no *RST value.

Example

FETC:ZONE:COUN?

The current number of zones found during analysis is returned.

Characteristics

RST value: -

SCPI: device-specific

Mode

OFDMA/WiBro

FORMat Subsystem (WiMAX, K92/K93)

The FORMat subsystem specifies the data format of the data transmitted from and to the instrument.

Commands of the FORMat Subsystem

- [FORMat\[:DATA\]](#)

FORMat[:DATA]

Parameter

ASCii | REAL | UINT [,8 | 32]

For details refer to the [FORMat \[:DATA\]](#) command description of the base unit on page 6.135.

INITiate Subsystem (WiMAX, K92/K93)

The INITiate subsystem configures the instrument prior to a measurement being carried out. It is basically used to tell the instrument which measurement is to be performed and takes any necessary step to set up the instrument for the measurement.

Commands of the INITiate Subsystem

- [INITiate\[:IMMediate\]](#)
- [INITiate:CONTInuous](#)
- [INITiate:REFResh](#)

INITiate[:IMMediate]

For further details refer to "[INITiate<1|2>\[:IMMediate\]](#)" on page 6.143.

INITiate:CONTInuous

For further details refer to "[INITiate<1|2>:CONTInuous](#)" on page 6.144.

INITiate:REFResh

This command updates the current IQ measurement results to reflect the current measurement settings. Note that no new IQ data is captured, i.e. the measurement settings apply to the IQ data being currently in the capture buffer. The command applies exclusively to IQ measurements. It requires available IQ data.

Example

```
INIT:REFR
```

Updates the IQ measurement results according to the current settings.

Characteristics

RST value: -

SCPI: conform

Mode

OFDM, OFDMA/WiBro

INPut Subsystem (WiMAX, K92/K93)

The INPut subsystem controls the input characteristics of the RF inputs of the instrument.

Commands of the INPut Subsystem

- [INPut:ATTenuation](#)
- [INPut:SElect](#)

INPut:ATTenuation

For details refer to "[INPut<1|2>:ATTenuation](#)" on page 6.146.

INPut:SElect

This command specifies the RF input as currently selected signal input.

Parameter

RF

Example

```
INPut:SEL RF  
Selects RF input.
```

Characteristics

RST value: RF

SCPI: conform

Mode

OFDM, OFDMA/WiBro

INSTRument Subsystem (WiMAX, K92/K93)

The INSTRument subsystem selects the operating mode of the unit either via text parameters or fixed numbers.

Commands of the INSTRument Subsystem

- [INSTRument\[:SElect\]](#)
- [INSTRument:NSElect](#)

INSTRument[:SElect]

Parameter

WiMAX (WiMAX 802.16 OFDM Measurements option and WiMAX IEEE 802.16 OFDM, OFDMA Measurements option, R&S FSL-K92/K93)

For further details refer to the INSTRument subsystem of the base unit.

INSTRument:NSElect

Parameter

23 (WiMAX 802.16 OFDM Measurements option, R&S FSL-K92)

6 (WiMAX IEEE 802.16 OFDM, OFDMA Measurements option, R&S FSL-K92/K93)

For further details refer to the INSTRument subsystem of the base unit.

MMEMory Subsystem (WiMAX, K92/K93)

The MMEMory (mass memory) subsystem provides commands to store and load IQ data.

Commands of the MMEMory Subsystem

- MMEMory:LOAD:FRAME:STATe
- MMEMory:LOAD:IQ:STATe
- MMEMory:STORe:IQ:STATe

MMEMory:LOAD:FRAME:STATe

This command loads a zone frame setup from the specified *.xml file. This file is created by a R&S SMU signal generator in accordance to the IEEE 80216e-2005 standard.

Parameter

1,<file_name>

Example

```
MMEM:STOR:FRAM:STAT 1, 'C:\R_S\Instr\user\data.xml'
```

Loads the zone frame setup from the specified file.

Characteristics

RST value: -

SCPI: device-specific

Mode

OFDMA/WiBro

MMEMory:LOAD:IQ:STATe

This command loads the IQ data from the specified *.iqw file.

Parameter

1,<file_name>

Example

```
MMEM:LOAD:IQ:STAT 1, 'C:\R_S\Instr\user\data.iqw'
```

Loads IQ data from the specified file.

Characteristics

*RST value: -

SCPI: device-specific

Mode

OFDM, OFDMA/WiBro

MMEMemory:STOR:IQ:STATe

This command stores the IQ data to the specified *.iqw file.

Parameter

1,<file_name>

Example

```
MME:STOR:IQ:STAT 1, 'C:\R_S\Instr\user\data.iqw'
```

Stores IQ data to the specified file.

Characteristics

*RST value: -

SCPI: device-specific

Mode

OFDM, OFDMA/WiBro

SENSe Subsystem (WiMAX, K92/K93)

The SENSe command is used to set and get the values of parameters in the remote instrument. The get variant of the SENSe command differs from set in that it takes no parameter values (unless otherwise stated) but is followed by the character '?' and will return the parameter's value in the same format as it is set.

Commands of the SENSe Subsystem

- [SENSe:]BANDwidth:CHANnel
- [SENSe:]BURSt:COUNT
- [SENSe:]BURSt:COUNT:STATe
- [SENSe:]DEMod:CESTimation
- [SENSe:]DEMod:FILTer:CATalog?
- [SENSe:]DEMod:FILTer:MODulation
- [SENSe:]DEMod:FORMat[:BCONtent]:AUTo
- [SENSe:]DEMod:FORMat:BANalyze
- [SENSe:]DEMod:FORMat:BANalyze:SYMBOLs:EQUal
- [SENSe:]DEMod:FORMat:BANalyze:SYMBOLs:MAX
- [SENSe:]DEMod:FORMat:BANalyze:SYMBOLs:MIN
- [SENSe:]FFT:OFFSet
- [SENSe:]FREQuency:CENTer
- [SENSe:]POWer:ACHannel:ACPairs
- [SENSe:]POWer:ACHannel:BANDwidth|BWIDth[:CHANnel]
- [SENSe:]POWer:ACHannel:BANDwidth|BWIDth:ACHannel
- [SENSe:]POWer:ACHannel:BANDwidth|BWIDth:ALternate<1|4>
- [SENSe:]POWer:ACHannel:MODE
- [SENSe:]POWer:ACHannel:SPACing[:ACHannel]
- [SENSe:]POWer:ACHannel:SPACing:ALternate<1|4>
- [SENSe:]POWer:NCORrection
- [SENSe:]POWer:SEM:CLASs
- [SENSe:]POWer:SEM:MODE
- [SENSe:]POWer:SEM:TTA
- [SENSe:]SUBChannel
- [SENSe:]SUBChannel:STATe
- [SENSe:]SUBChannel:ULPHysmod
- [SENSe:]SWAPiq
- [SENSe:]SWEep:ACPR:TIME
- [SENSe:]SWEep:ACPR:TIME:AUTO
- [SENSe:]SWEep:COUNT
- [SENSe:]SWEep:EGATe

- [SENSe:]SWEep:EGATe:HOLDoff[:TIME]
- [SENSe:]SWEep:EGATe:HOLDoff:SAMPle
- [SENSe:]SWEep:EGATe:LENGth[:TIME]
- [SENSe:]SWEep:EGATe:LENGth:SAMPle
- [SENSe:]SWEep:EGATe:LINK
- [SENSe:]SWEep:TIME
- [SENSe:]TRACking:LEVel
- [SENSe:]TRACking:PHASe
- [SENSe:]TRACking:PILot
- [SENSe:]TRACking:TIME

[SENSe:]BANDwidth:CHANnel

This command specifies the channel bandwidth for the signal to be measured. The channel is selected via the `CONFigure:CHANnel` command.

Parameter

1.25 MHz to 28 MHz

Example

```
CONF:CHAN 9
```

Defines the frequency of channel 9 as measurement range.

```
BAND:CHAN 7MHZ
```

Sets a channel bandwidth value of 7 MHz.

Characteristics

RST value: 1.75 MHz

SCPI: conform

Mode

OFDM

[SENSe:]BURSt:COUNT

This command defines the number of bursts that will be analyzed by the measurement.

Parameter

1 to 10922

Example

```
BURSt:COUNT 16
```

Sets the number of bursts to 16.

Characteristics

*RST value: 1

SCPI: device-specific

Mode

OFDM, OFDMA/WiBro

[SENSe:]BURSt:COUNt:STATe

When this command is set to on, the burst count parameter will be used by the measurement, otherwise the burst count parameter will be ignored.

Parameter

ON | OFF

Example

BURSt:COUNt:STAT ON
Sets the burst count state to ON

Characteristics

*RST value: OFF
SCPI: device-specific

Mode

OFDM, OFDMA/WiBro

[SENSe:]DEMod:CEStimation

This command defines how channel estimation is performed.

IEEE 802.16-2004 OFDM: The improved channel estimation is used for IQ measurements. The effect of this is most noticeable for the EVM measurement results, where the results will be improved if this feature is enabled. However, this functionality is not supported by the IEEE 802.16-2004 standard and must be disabled if the results are to be strictly measured against the standard.

IEEE 802.16e-2005 OFDMA/WiBro: The channel estimation is performed for downlink signals.

Parameter

Standard	Parameter	Description
IEEE 802.16-2004 OFDM	ON	Improved channel estimation is performed.
	OFF	Improved channel estimation is not performed.
IEEE 802.16e-2005 OFDMA	PAYLONLY	Channel estimation is performed in the payload only.
	PREAMONLY	Channel estimation is performed in the preamble only.
	PREAMPAYL	Channel estimation is performed in both the preamble and the payload.

Example

DEMod:CESt ON
Specifies that the IQ measurement results will use improved channel estimation.

Characteristics

*RST value:
IEEE 802.16-2004 OFDM OFF
IEEE 802.16e-2005 OFDMA PREAMPAYL

SCPI: device-specific

Mode

OFDM, OFDMA/WiBro

[SENSe:]DEMod:FILTer:CATalog?

This command reads the names of all available filters. The file names are output without file extension. Syntax of output format: filter_1,filter_2, ... ,filter_n.

This command is a query only and thus has no *RST value.

Example

```
DEM:FILT:CAT?
Reads all filter names
```

Characteristics

*RST value: 0

SCPI: device-specific

Mode

OFDM, OFDMA/WiBro

[SENSe:]DEMod:FILTer:MODulation

This command selects the TX and RX filters. The names of the filters correspond to the file names; a query of all available filters is possible by means of the [\[SENSe:\]DEMod:FILTer:CATalog?](#) command.

Parameter

<string>,<string>

DEF_TX: default transmit filter, DEF_RX: default receive filter

Example

```
DEM:FILT:MOD 'DEF_TX','DEF_RX'
DEF_TX is selected for the TX filter and DEF_RX for the RX filter
```

Characteristics

*RST value: AUTO,AUTO

SCPI: device-specific

Mode

OFDM, OFDMA/WiBro

[SENSe:]DEMod:FORMat[:BCONtent]:AUTo

This command specifies how the signal should be demodulated.

Parameter

NONE	Demodulation off (Brute force mode), the specified modulation is used for all bursts.
FIRSt	Retrieves the first valid payload modulation and analyzes all bursts with same modulation.
USER	Analyzes all bursts carrying the modulation specified.
ALL	Retrieves all bursts individual payload modulation and analyzes accordingly.

Example

```
DEM:FORM:AUTO FIRS
Specifies that the first symbol field should be decoded.
```

Characteristics

*RST value: ALL

SCPI: device-specific

Mode

OFDM

[SENSe:]DEMod:FORMat:BANalyze

The remote control command sets the analysis modulation format that will be assumed for the measurement.

If the standard is IEEE 802.16e-2005 OFDMA or WiBro, this command is query only and returns the highest detected modulation format from the last measurement sweep.

Parameter

BPSK1/2	BI-Phase shift keying (OFDM only)
QPSK1/2	Quadrature phase shift keying
QPSK3/4	Quadrature phase shift keying
16QAM1/2	Quadrature Amplitude Modulation
16QAM3/4	Quadrature Amplitude Modulation
64QAM2/3	Quadrature Amplitude Modulation
64QAM3/4	Quadrature Amplitude Modulation

Example

```
DEMod:FORM:BAN '16QAM1/2'
```

Only bursts that are of the QAM16 modulation format are analyzed.

Characteristics

*RST value: 16QAM1/2

SCPI: device-specific

Mode

OFDM, OFDMA/WiBro

[SENSe:]DEMod:FORMat:BANalyze:SYMBols:EQUal

If this command is activated only bursts of equal length will take part in the PVT analysis. The number of symbols that a burst must have in order to take part in the PVT analysis are specified by the `[SENSe:]DEMod:FORMat:BANalyze:SYMBols:MIN` command.

Parameter

ON | OFF

Example

```
DEMod:FORM:BAN:SYMB:EQU ON
```

Only bursts of equal length will take part in the PVT analysis.

Characteristics

*RST value: OFF

SCPI: device-specific

Mode

OFDM

[SENSe:]DEMod:FORMat:BANalyze:SYMBols:MAX

This command specifies the maximum number of data symbols required for bursts to qualify for measurement analysis. Only bursts with the specified number of symbols will be used in the measurement analysis. The number of data symbols is defined as the uncoded bits including service and tail bits.

This value will not have any immediate effect if the

[SENSe:]DEMod:FORMat:BANalyze:SYMBols:EQUal command has been set to ON. In this case, no range of symbols is allowed and only bursts with exactly the number of symbols specified by the [SENSe:]DEMod:FORMat:BANalyze:SYMBols:MIN command shall take place in measurement analysis.

Parameter

1 to 2425

Example

```
DEM:FORM:BAN:SYMB:MAX 1300
```

Only bursts which contain a maximum symbol count of 1300 are analyzed.

Characteristics

*RST value: 64

SCPI: device-specific

Mode

OFDM

[SENSe:]DEMod:FORMat:BANalyze:SYMBols:MIN

This command specifies the number of data symbols required for bursts to qualify for measurement analysis. Only bursts with the specified number of symbols will be used in the measurement analysis. The number of data symbols is defined as the uncoded bits including service and tail bits.

If the [SENSe:]DEMod:FORMat:BANalyze:SYMBols:EQUal command has been set to ON, this command specifies the exact number of symbols required for a burst to take part in measurement analysis. If the [SENSe:]DEMod:FORMat:BANalyze:SYMBols:EQUal command is set to OFF, this command specifies the minimum number of symbols required for a burst to take part in measurement analysis.

Parameter

1 to 2425

Example

```
DEM:FORM:BAN:SYMB:MIN 16
```

Only bursts which contain a symbol count of 16 are analyzed.

Characteristics

*RST value: 1

SCPI: device-specific

Mode

OFDM

[SENSe:]FFT:OFFSet

This command specifies the FFT start offset relative to the GP centre.

Parameter

-100 to 100

Example

```
FFT:OFF 0
```

Sets the FFT start offset to 0.

Characteristics

RST value: 0

SCPI: conform

Mode

OFDMA/WiBro

[SENSe:]FREQuency:CENTer

This command defines the center frequency of the analyzer or the measuring frequency for IQ measurements.

Characteristics

RST value: 5 GHz

For further details refer to "[\[SENSe<1|2>:\]FREQuency:CENTer](#)" on page 6.194.

[SENSe:]POWER:ACHannel:ACPairs

This command sets the number of adjacent channels pairs (upper and lower channel pairs).

Parameter

0 to 3

0 stands for pure channel power measurement

Example

```
POWER:ACH:ACP 3
```

Sets the number of adjacent channels to 3, i.e. the adjacent channel and alternate adjacent channels 1 and 2 are switched on.

Characteristics

RST value: -

SCPI: device-specific

Mode

OFDM, OFDMA/WiBro

[SENSe:]POWer:ACHannel:BANDwidth|BWIDth[:CHANnel]

This command sets the channel bandwidth of the system. The bandwidths of adjacent channels are not influenced by this modification.

Parameter

0 Hz to 100 GHz

Example

```
POW:ACH:BAND 30kHz
```

Sets the bandwidth of the TX channel to 30 kHz.

Characteristics

RST value: -

SCPI: device-specific

Mode

OFDM, OFDMA/WiBro

[SENSe:]POWer:ACHannel:BANDwidth|BWIDth:ACHannel

This command defines the channel bandwidth of the adjacent channel of the system.

Parameter

0 Hz to 100 GHz

Example

```
POW:ACH:BAND:ACH 30kHz
```

Sets the bandwidth of the adjacent channel to 30 kHz.

Characteristics

RST value: -

SCPI: device-specific

Mode

OFDM, OFDMA/WiBro

[SENSe:]POWer:ACHannel:BANDwidth|BWIDth:ALternate<1|4>

This command defines the channel bandwidth of the first to fourth alternate adjacent channel of the system.

Parameter

0 Hz to 100 GHz

Example

```
POW:ACH:BAND:ALT2 30kHz
```

Sets the bandwidth of the second alternate adjacent channel to 30 kHz.

Characteristics

RST value: -

SCPI: device-specific

Mode

OFDM, OFDMA/WiBro

[SENSe:]POWer:ACHannel:MODE

This command sets the ACP measurement mode to either absolute or relative.

Parameter

ABS Absolute measurement
REL Relative measurement

Example

```
POW:ACH:MODE ABS
```

Sets the ACP measurement to absolute mode.

Characteristics

*RST value: REL
SCPI: device-specific

Mode

OFDM, OFDMA/WiBro

[SENSe:]POWer:ACHannel:SPACing[:ACHannel]

This command defines the channel spacing of the adjacent channel to the TX channel.

Parameter

0 Hz to 100 GHz

Example

```
POW:ACH:SPAC 33kHz
```

Sets the spacing between the carrier signal and the adjacent channel to 33 kHz

Characteristics

RST value: -
SCPI: device-specific

Mode

OFDM, OFDMA/WiBro

[SENSe:]POWer:ACHannel:SPACing:ALTErnate<1|4>

This command defines the channel spacing of the first to fourth alternate adjacent channel to the TX channel..

Parameter

0 Hz to 100 GHz

Example

```
POW:ACH:SPAC:ALT1 100kHz
```

Sets the spacing between TX channel and first alternate adjacent channel to 100 kHz.

Characteristics

RST value: -
SCPI: device-specific

Mode

OFDM, OFDMA/WiBro

[SENSe:]POWer:NCORrection

This command activates or deactivates the noise correction for future spectrum ACP measurements.

Parameter

ON | OFF

Example

```
POW:NCOR ON
```

Activates the noise correction.

Characteristics

RST value: -

SCPI: device-specific

Mode

OFDM, OFDMA/WiBro

[SENSe:]POWer:SEM:CLASs

This command sets the Spectrum Emission Mask (SEM) power class.

This command is available from firmware version 1.60.

Parameter

- 0 automatic selection
- 1 (-INF, 23) dBm for uplink, (-INF, 29) dBm for downlink
- 2 (23, INF) dBm for uplink, (29, 40) dBm for downlink
- 3 (40, INF) dBm for downlink

Example

```
POW:SEM:CLAS 0
```

Sets the SEM power class to automatic.

Characteristics

RST value: 0

SCPI: device-specific

Mode

WiBro

[SENSe:]POWer:SEM:MODE

This command sets the Spectrum Emission Mask (SEM) analysis to be UL or DL (uplink or downlink). This command only available for WiBro standard.

Parameter

DL | UL

Example

```
POW:SEM:MOD UL
```

Sets the Spectrum Emission Mask analysis to be UL.

Characteristics

RST value: -

SCPI: device-specific

ModeWiBro

[SENSe:]POWER:SEM:TTA

This command sets the Spectrum Emission Mask (SEM) analysis according to TTA standard or a user defined mask.

This command is available from firmware version 1.60.

Parameter

USER | STANDARD

Example

```
POW:SEM:TTA STANDARD
```

Sets the SEM analysis according to TTA standard.

Characteristics

RST value: STANDARD

SCPI: device-specific

ModeWiBro

[SENSe:]SUBChannel

This command sets the subchannel to be used in the measurement. It is only available in Up Link mode.

Parameter

1 to 31

Example

```
SUBC 12
```

Sets the subchannel to 12.

Characteristics

RST value: -

SCPI: device-specific

ModeOFDMA/WiBro

[SENSe:]SUBChannel:STATe

This command enables or disables the use of subchannels in the measurement analysis. It is only available in Up Link mode.

Parameter

ON | OFF

Example

```
SUBC:STAT ON
```

Specifies that the measurement will be analyzed using the specified SUBChannel.

Characteristics

RST value: OFF

SCPI: conform

Mode

OFDMA/WiBro

[SENSe:]SUBChannel:ULPHysmod

This command sets the Up Link Physical Modifier to be used in the measurement. It is only available in Up Link mode.

Parameter

0 to 255

Example

```
SUBC:ULPH 1
```

Sets the UL Physical Modifier to 1.

Characteristics

RST value: -

SCPI: device-specific

Mode

OFDMA/WiBro

[SENSe:]SWAPiq

This command defines whether or not the recorded IQ pairs should be swapped (I<->Q) before being processed.

Parameter

ON | OFF

Example

```
SWAP ON
```

Specifies that IQ values should be swapped.

Characteristics

*RST value: OFF

SCPI: device-specific

Mode

OFDM, OFDMA/WiBro

[SENSe:]SWEep:ACPR:TIME

This command specifies the sweep time for the Spectrum Mask and Spectrum ACP/ACPR measurements.

Parameter

10 ms to 16000 s

Example

```
SWE:ACPR:TIME:AUTO OFF
```

Deactivates the automatic calculation of the sweep time.

```
SWE:ACPR:TIME 100S
```

Sets the sweep time to 100 s.

Characteristics

RST value: 2s

SCPI: conform

Mode

OFDM, OFDMA/WiBro

[SENSe:]SWEep:ACPR:TIME:AUTO

This command activates or deactivates the automatic calculation of the sweep time for the Spectrum Mask and Spectrum ACP/ACPR measurements.

Parameter

ON | OFF

Example

```
SWE:ACPR:TIME:AUTO OFF
```

Deactivates the automatic calculation of the sweep time.

Characteristics

RST value: ON

SCPI: conform

Mode

OFDM, OFDMA/WiBro

[SENSe:]SWEep:COUNT

This command specifies the number of sweeps for Spectrum Mask and Spectrum ACPR measurements.

Parameter

1 to 32767

Example

```
SWE:COUNT 64
```

Sets the number of sweeps to 64.

Characteristics

*RST value: 1

SCPI: conform

Mode

OFDM, OFDMA/WiBro

[SENSe:]SWEep:EGATe

For details refer to "[SENSe<1|2>:]SWEep:EGATe" on page 6.224.

[SENSe:]SWEep:EGATe:HOLDoff[:TIME]

This command defines the gate delay in the capture buffer in time units.

Parameter

0 to 262.14 ms

Example

```
SWE:EGAT:HOLD 125us
```

Sets a delay of 125 μ s in the capture buffer.

Characteristics

*RST value: 0 s

SCPI: device-specific

Mode

OFDM, OFDMA/WiBro

[SENSe:]SWEep:EGATe:HOLDoff:SAMPle

This command defines the gate delay in the capture buffer as a number of samples.

Parameter

0 to 50E6

Example

```
SWE:EGAT:HOLD:SAMP 2500
```

Sets a delay of 2500 samples in the capture buffer.

Characteristics

*RST value: 0

SCPI: device-specific

Mode

OFDM, OFDMA/WiBro

[SENSe:]SWEep:EGATe:LENGth[:TIME]

This command defines the gate time in the capture buffer in time units.

Parameter

0 to 262.14 ms

Example

```
SWE:EGAT:LENG 100ms
```

Sets a gate length of 100 milliseconds between sweeps.

Characteristics

*RST value: 0

SCPI: device-specific

Mode

OFDM, OFDMA/WiBro

[SENSe:]SWEep:EGATe:LENGth:SAMPle

This command defines the gate time in the capture buffer as a number of samples.

Parameter

0 to 50E6

Example

```
SWE:EGAT:LENG:SAMP 2000000
```

Enforces a gate length of 2000000 samples in the capture buffer.

Characteristics

*RST value: 0

SCPI: device-specific

Mode

OFDM, OFDMA/WiBro

[SENSe:]SWEep:EGATe:LINK

This command links together the movement of the gating lines and the capture buffer marker.

Parameter

ON | OFF

Example

```
SWE:EGAT:LINK ON
```

Keeps the capture buffer marker on the centre of the gating lines if the gating line delay and length are changed.

Characteristics

*RST value: 0

SCPI: device-specific

Mode

OFDM, OFDMA/WiBro

[SENSe:]SWEep:TIME

Parameter

24 μ s to 15.5 ms

Characteristics

*RST value: 24 μ s

For further details refer to "[SENSe<1|2>:]SWEep:TIME" on page 6.227.

[SENSe:]TRACking:LEVel

This command defines whether or not the measurement results should be compensated for level.

Parameter

ON | OFF

Example

```
TRAC:LEV ON
```

Specifies that the measurement results should be compensated for level.

Characteristics

*RST value: OFF

SCPI: conform

Mode

OFDM

[SENSe:]TRACking:PHASe

This command defines whether or not the measurement results should be compensated for phase.

Parameter

ON | OFF

Example

```
TRAC:PHAS ON
```

Specifies that the measurement results should be compensated for phase.

Characteristics

*RST value: ON

SCPI: conform

Mode

OFDM, OFDMA/WiBro

[SENSe:]TRACking:PILot

This command defines whether the measurement results should have predefined pilot tracking or whether the tracking should be determined when the measurement is run.

Parameter

PRED Predefined pilot tracking is used.

DET Pilot tracking is determined when
the measurement is run.

Example

```
TRAC:PIL DET
```

Pilot tracking is determined when the measurement is run.

Characteristics

RST value: PRED

SCPI: conform

Mode

OFDMA/WiBro

[SENSe:]TRACking:TIME

This command defines whether or not the measurement results should be compensated for time.

Parameter

ON | OFF

Example

TRAC:TIME ON

Specifies that the measurement results should be compensated for time.

Characteristics

*RST value: OFF

SCPI: conform

Mode

OFDM, OFDMA/WiBro

STATus Subsystem (WiMAX, K92/K93)

The STATus subsystem contains the commands for the status reporting system (for details refer to chapter 5 "Remote Control - Basics"). For the STATus:QUESTionable:LIMit register, the measurement window is selected by LIMit 1 (screen A) or 2 (screen B). *RST does not influence the status registers.

Commands of the STATus Subsystem

- STATus:QUESTionable:LIMit<1|2> [:EVENT]?
- STATus:QUESTionable:LIMit<1|2>:CONDition?
- STATus:QUESTionable:LIMit<1|2>:ENABle
- STATus:QUESTionable:LIMit<1|2>:PTRansition
- STATus:QUESTionable:LIMit<1|2>:NTRansition
- STATus:QUESTionable:POWer[:EVENT]?
- STATus:QUESTionable:POWer:CONDition?
- STATus:QUESTionable:POWer:ENABle
- STATus:QUESTionable:POWer:PTRansition
- STATus:QUESTionable:POWer:NTRansition
- STATus:QUESTionable:SYNC[:EVENT]?
- STATus:QUESTionable:SYNC:CONDition?
- STATus:QUESTionable:SYNC:ENABle
- STATus:QUESTionable:SYNC:PTRansition
- STATus:QUESTionable:SYNC:NTRansition

STATus:QUESTionable:LIMit<1|2> [:EVENT]?

For details refer to "[STATus:QUESTionable:LIMit<1|2>\[:EVENT\]?](#)" on page 6.239.

STATus:QUESTionable:LIMit<1|2>:CONDition?

For details refer to "[STATus:QUESTionable:LIMit<1|2>:CONDition?](#)" on page 6.239.

STATus:QUESTionable:LIMit<1|2>:ENABle

For details refer to "[STATus:QUESTionable:LIMit<1|2>:ENABle](#)" on page 6.240.

STATus:QUESTionable:LIMit<1|2>:PTRansition

For details refer to "[STATus:QUESTionable:LIMit<1|2>:PTRansition](#)" on page 6.240.

STATus:QUESTionable:LIMit<1|2>:NTRansition

For details refer to "[STATus:QUESTionable:LIMit<1|2>:NTRansition](#)" on page 6.240.

STATus:QUESTionable:POWer[:EVENT]?

For details refer to "[STATus:QUESTionable:POWer\[:EVENT\]?](#)" on page 6.242.

STATus:QUESTionable:POWer:CONDition?

For details refer to "[STATus:QUESTionable:POWer:CONDition?](#)" on page 6.242.

STATus:QUESTionable:POWer:ENABLE

For details refer to "[STATus:QUESTionable:POWer:ENABLE](#)" on page 6.243.

STATus:QUESTionable:POWer:PTRansition

For details refer to "[STATus:QUESTionable:POWer:PTRansition](#)" on page 6.243.

STATus:QUESTionable:POWer:NTRansition

For details refer to "[STATus:QUESTionable:POWer:NTRansition](#)" on page 6.243.

STATus:QUESTionable:SYNC[:EVENT]?

This command queries the contents of the EVENT section of the STATus:QUESTionable:SYNC register. Readout does not delete the contents of the EVENT section.

Example

```
STAT:QUES:SYNC?
```

Characteristics

*RST value: -

SCPI: device-specific

Mode

OFDM, OFDMA/WiBro

STATus:QUESTionable:SYNC:CONDition?

This command queries the contents of the CONDition section of the STATus:QUESTionable:SYNC register. Readout does not delete the contents of the CONDition section.

Example

```
STAT:QUES:SYNC:COND?
```

Characteristics

*RST value: -

SCPI: conform

Mode

OFDM, OFDMA/WiBro

STATus:QUEStionable:SYNC:ENABle

This command sets the bits of the ENABle section of the STATus:QUEStionable:SYNC register. The ENABle register selectively enables the individual events of the associated EVENt section for the summary bit.

Parameter

0 to 65535

Example

STAT:QUES:SYNC:ENAB 65535

All events bits will be represented in the SYNC summary bit.

Characteristics

*RST value: -

SCPI: device-specific

Mode

OFDM, OFDMA/WiBro

STATus:QUEStionable:SYNC:PTRansition

This command determines what bits in the STATus:QUEStionable:SYNC Condition register will set the corresponding bit in the STATus:QUEStionable:SYNC Event register when that bit has a positive transition (0 to 1). The variable <number> is the sum of the decimal values of the bits that are to be enabled.

Parameter

0 to 65535

Example

STAT:QUES:SYNC:PTR 65535

All condition bits will be summarized in the Event register when a positive transition occurs.

Characteristics

*RST value: -

SCPI: device-specific

Mode

OFDM, OFDMA/WiBro

STATus:QUEStionable:SYNC:NTRansition

This command determines what bits in the STATus:QUEStionable:SYNC Condition will set the corresponding bit in the STATus:QUEStionable:SYNC Event register when that bit has a negative transition (1 to 0). The variable <number> is the sum of the decimal values of the bits that are to be enabled.

Parameter

0 to 65535

Example

STAT:QUES:SYNC:NTR 65535

All condition bits will be summarized in the Event register when a positive transition occurs.

Characteristics

*RST value: -

SCPI: device-specific

Mode

OFDM, OFDMA/WiBro

SYSTEM Subsystem (WiMAX, K92/K93)

This subsystem contains a series of commands for general functions.

Commands of the SYSTEM Subsystem

- [SYSTem:COMMunicate:TCPIP:ADDRESS](#)

SYSTem:COMMunicate:TCPIP:ADDRESS

This command sets the lookup TCP/IP address of an external R&S SMU signal generator connected via TCP/IP. This enables the instrument to download the frame zone setup directly.

Parameter

<string>

Example

```
SYST:COMM:TCP:ADDR 192.168.1.1
```

Sets the lookup TCP/IP address of the SMU to 192.168.1.1.

Characteristics

RST value: -

SCPI: device-specific

Mode

OFDMA/WiBro

TRACe Subsystem (WiMAX, K92/K93)

The TRACe subsystem controls access to the instrument's internal trace memory.

Commands of the TRACe Subsystem

- TRACe[:DATA]
- TRACe:IQ:DATA:MEMory?
- TRACe:IQ:SRATe

Further information

- Constellation vs Symbol
- Constellation vs Carrier
- Power vs Time - Full Burst and Start / End Data
- Power vs Time - Full Subframe and Rising/Falling Subframe
- Spectrum Flatness/Group Delay/Flatness Difference
- Spectrum FFT
- Statistics Bitstream data
- Statistics Burst Summary data
- Statistics CCDF - Complementary cumulative distribution function
- EVM vs Carrier
- EVM vs Symbol
- Frequency Sweep Measurements
- Spectrum Mask
- Spectrum ACPR

Constellation vs Symbol

This measurement represents I and Q data. Data will be returned as a repeating array of interleaved I and Q data in groups of selected carriers, until all the data is exhausted.

Each I and Q point will be returned in floating point format. TRACE1 is used for this measurement results.

- If **All Carriers** is selected, it will return 52 per of I and Q data per symbol.
- If **Pilots Only** is selected, it will return 4 per of I and Q per symbol in the following order: Carrier -21, Carrier -7, Carrier 7, Carrier 21.
- If a single carrier is selected, it will return 1 per of I and Q data per symbol.

For the IEEE 802.16e-2005 OFDMA standard, the following rule applies: For all symbols, the results are returned in repeating groups of the FFT size. For example, if the FFT size was 1024 and 12 symbols were found, then 12288 I/Q pairs worth of data would be returned. Carriers that do not exist or are filtered out by the current filter settings are denoted by the keyword **NAN**.

Constellation vs Carrier

This measurement represents I and Q data. Data will be returned as a repeating array of interleaved I and Q data in groups of 53 channels including the channel 0, until all the data is exhausted.

Each I and Q point will be returned in floating point format. TRACE1 is used for this measurement results.

Power vs Time - Full Burst and Start / End Data

This description applies to measurement results from the IEEE 802.16-2004 OFDM standard.

Both measurement results are once again simply slightly different views of the same results data.

All fully complete bursts within the capture time are analyzed. This data is returned in dBm values on a per sample basis. Each sample will in some way relate to an analysis of each corresponding sample within each processed burst.

The type of PVT data returned will be determined by the TRACE number passed as an argument to the SCPI command, in addition to the graphic type that is selected.

If the graphic type selected is full burst, then the return data is as follows.

TRACE1 full burst, burst data values

If the graphic type selected is rising/falling, then the return data is as follows.

TRACE1 start, burst data values

TRACE2 end, burst data values

The number of samples returned during full burst analysis will depend on the modulation type and will typically be 5000.

The number of samples returned when the rising and falling graphic type is selected will be less than what is returned for full burst and will be approximately 400 samples. The samples will be returned in floating point format as a single sequence of comma delimited values.

Power vs Time - Full Subframe and Rising/Falling Subframe

This description applies to measurement results from the IEEE 802.16e-2005 standard.

Both measurement results are once again simply slightly different views of the same results data.

All fully complete frames within the capture time are analyzed into three master frames. The three master frames relate to the minimum, maximum and average values across all complete frames. This data is returned in dBm values on a per sample basis. Each sample will in some way relate to an analysis of each corresponding sample within each processed frame.

The type of PVT data returned will be determined by the TRACE number passed as an argument to the SCPI command, in addition to the graphic type that is selected.

If the graphic type selected is full burst, then the return data is as follows.

TRACE1 full subframe, minimum frame data values

TRACE2 full subframe, mean frame data values

TRACE3 full subframe, maximum frame data values

If the graphic type selected is rising/falling, then the return data is as follows.

TRACE1 rising edge, minimum frame data values

TRACE2 rising edge, mean frame data values

TRACE3 rising edge, maximum frame data values

TRACE4	falling edge, minimum frame data values
TRACE5	falling edge, mean frame data values
TRACE6	falling edge, maximum frame data values

The number of samples returned during full frame analysis will depend on the modulation type and will typically be 5000.

The number of samples returned when the start/end graphic type is selected will be less than what is returned for full burst and will be approximately 400 samples. The samples will be returned in floating point format as a single sequence of comma delimited values.

Spectrum Flatness/Group Delay/Flatness Difference

There are three separate traces that are available with this measurements. Trace data for a particular trace will only be returnable by querying the appropriate trace.

The graph data returned is as follows:

- Spectrum Flatness
absolute power value (ABS)
- Group Delay
relative group delay
- Spectrum Difference
adjacent carrier power difference in the preamble part of the burst

All traces are all plotted on a per carrier basis. All carriers are drawn in addition to the unused 0 carrier.

The number of carriers depends on the measured standard:

- For the IEEE 802.16-2004 ODFM standard the number of carriers is 200.
- For the IEEE 802.16e-2005 ODFMA standard the number of carriers depends on the FFT size.

Carriers that are not used are denoted by the keyword **NAN**.

For example, the return data will be a repeating group of 201 carriers for the IEEE 802.16-2004 ODFM standard.

TRACE1	Minimum absolute power value (ABS) or Minimum group delay values
TRACE2	Mean absolute power value (ABS) or Mean group delay values or
TRACE3	Maximum absolute power value (ABS) or Maximum group delay values or

Absolute power results are returned in dB or dB difference and group delay results are returned in ns.

Spectrum FFT

All FFT points will be returned if the data for this measurement is requested. This will be an exhaustive call, due to the fact that there are nearly always more FFT points than IQ samples. The number of FFT points is the number presented by a power of 2 that is higher than the total number of samples.

E.g. if there were 20000 samples, then 32768 FFT points would be returned.

Data will be returned in floating point format in dBm. TRACE1 is used for this measurement results.

Statistics Bitstream data

Data will be returned depending on the selected standard from which the measurement was executed:

- For the IEEE 802.16-2004 OFDM standard, data is returned in repeating groups of 200 data channels where each symbol value will be represented by an integer value within one byte. Channel 0 is unused and will therefore not have any data associated with it, with no return data being provided.
- For the IEEE 802.16e-2005 OFDMA standard, the data is returned in groups of the selected FFT size, where each symbol value will be represented by an integer value within one byte. The FFT size is either 128, 512, 1024, or 2048 sub carriers. Unused carriers, including the zero carrier, are also returned. They are denoted by the string value **NAN**.

The number of repeating groups that are returned will be equal to the number of measured symbols.

64QAM has the highest data rate and it contains symbol values up to 63, making one byte sufficient in size to represent all symbol data values, regardless of the modulation type in use.

Data will be returned in ASCII printable hexadecimal character format. TRACE1 is used for this measurement results.

Statistics Burst Summary data

The return data depends on the current standard and measurement results.

For the IEEE 802.16-2004 OFDM standard, the data will be returned in repeating groups of 6 comma separated values as follows:

- 1st value - burst number
If this value is 0 then it is an FCH burst.
- 2nd value - area with:
 - 0 = preamble
 - 1 = data
- 3rd value - modulation with:
 - 0 = BPSK
 - 1 = QPSK
 - 2 = 16QAM
 - 3 = 64QAM
- 4th value - symbol length
This is an integer value giving the number of symbols in the current area.
- 5th value - power in dBm for the current area
This is returned as a float
- 6th value - EVM in dB for the current area
This is returned as a float.

Example:

Burst	Area	Modulation	Length	Power	EV
FCH	Preamble	QPSK	1	-1.96	-43.75
	Data	BPSK	1	-2.96	-33.75
Burst 2	Preamble	QPSK	1	-3.96	-23.75
	Data	64QAM	26	-4.96	-13.75

SCPI would return the following:

```

B|A|M|L |P |E
u|r|o|e |o |V
r|e|d|n |w |M
s|a| | |e |
t| | | |r |

0,0,1, 1,-1.96,-43.75,
0,1,0, 1,-2.96,-33.75,
2,0,1, 1,-3.96,-23.75,
2,1,3,26,-4.96,-13.75
    
```

The number of repeating groups that are returned will be equal to the number of rows in the Burst Summary results.

For the IEEE 802.16e-2005 OFDMA standard, the data will be returned in repeating groups of 7 comma separated values as follows:

- 1st value - subframe number
- 2nd value - burst number
- 3rd value - burst type:
 - 1 = FCH
 - 2 = DL map
 - 3 = UL map
 - 4 = data

- 4th value - modulation where:
 - 1 = QPSK
 - 2 = 16QAM
 - 3 = 64QAM
- 5th value - number of slots
This is an integer value giving the number of slots associated with the burst.
- 6th value - power in dBm for the current area
This is returned as a float.
- 7th value - EVM in dB for the current area
This is returned as a float.

The number of repeating groups that are returned will be equal to the number of rows in the Burst Summary results.

Data will be returned in ASCII printable hexadecimal character format. TRACE1 is used for this measurement results.

Statistics CCDF - Complementary cumulative distribution function

Up to a maximum of 201 data points will be returned in addition to a data count value. The first value in the return data will represent the quantity of probability values that follow. Each of the potential 201 data points will be returned as probability value and will represent the total number of samples that are equal to or exceed the corresponding power level. Probability data will be returned up to the power level that contains at least one sample. It is highly unlikely that the full 201 data values will ever be returned.

Each probability value will be returned as a floating point number, with a value less than 1.

EVM vs Carrier

Two trace types are provided with this measurement. There is an average EVM value for each of the 53 channels or a repeating group of EVM values for each channel. The number of repeating groups will correspond to the number of fully analyzed trains.

Each EVM value will be returned as a floating point number, expressed in units of dBm.

TRACE1 Average EVM values per channel

TRACE2 All EVM values per channel for each full train of the capture period

For the IEEE 802.16e-2005 standard, the number of sub carriers returned varies according to the FFT size.

Each EVM value will be returned as a floating point number, expressed in units of dBm or percentage.

TRACE1 Minimum EVM values

TRACE2 Mean EVM values

TRACE3 Maximum EVM values

EVM vs Symbol

Three traces types are available with this measurement. The basic trace types show either the minimum, mean or maximum EVM value, as measured over the complete capture period.

The number of repeating groups that are returned will be equal to the number of measured symbols.

Each EVM value will be returned as a floating point number, expressed in units of dBm.

TRACE1	Minimum EVM values
TRACE2	Mean EVM values
TRACE3	Maximum EVM values

Frequency Sweep Measurements

Currently, there is only one measurement that is performed in frequency sweep mode. This is the Spectrum Mask measurement. No data will be returned for this measurement, should it be requested, until such time as a measurement has been previously run.

Running an IQ measurement will not generate results for this type of measurement.

Spectrum Mask

Result data will be returned as 501 trace points in floating point format. These trace points are obtained directly from the base system via the measurement API and the quantity is therefore a fixed value. Only an array of Y data will be returned.

TRACE1	Clear write values
TRACE2	Max hold values
LIST	Spectrum Emission Mask (SEM) summary results (in WiBro standard only):

SEM summary results formats:

1st value	index into table of results (1 - 9)
2nd value	start frequency band (Hz)
3rd value	stop frequency band (Hz)
4th value	RBW (Hz)
5th value	limit fail frequency (Hz)
6th value	power absolute (dBm)
7th value	power relative (dBc)
8th value	limit distance (dB)
9th value	failure flag (1 = fail, 0 = pass)

There are 5 rows of results for downlink, and 9 rows for uplink.

Spectrum ACPR

Result data will be returned as 501 trace points in floating point format. These trace points are obtained directly from the base system via the measurement API and the quantity is therefore a fixed value. Only an array of Y data will be returned.

TRACE1	Clear write values
TRACE2	Max hold values

TRACe[:DATA]

This command returns all the measured data that relates to the currently selected measurement type. All results are returned in ASCII format. The returned data depends on the currently selected measurement type. [DISPlay:FORMat](#) is not supported with this command.

The following measurement types are available:

- ["Constellation vs Symbol"](#) on page 6.847
- ["Constellation vs Carrier"](#) on page 6.848
- ["Power vs Time - Full Burst and Start / End Data"](#) on page 6.848
- ["Power vs Time - Full Subframe and Rising/Falling Subframe"](#) on page 6.848
- ["Spectrum Flatness/Group Delay/Flatness Difference"](#) on page 6.849
- ["Spectrum FFT"](#) on page 6.849
- ["Statistics Bitstream data"](#) on page 6.850
- ["Statistics Burst Summary data"](#) on page 6.850
- ["Statistics CCDF - Complementary cumulative distribution function"](#) on page 6.852
- ["EVM vs Carrier"](#) on page 6.852
- ["EVM vs Symbol"](#) on page 6.852
- ["Frequency Sweep Measurements"](#) on page 6.853
- ["Spectrum Mask"](#) on page 6.853
- ["Spectrum ACPR"](#) on page 6.853

This command is a query only and thus has no *RST value.

Parameter

TRACE1 | TRACE2 | TRACE3 | TRACE4 | TRACE5 | TRACE6 | LIST

For details on the parameters refer to the corresponding measurement type (see list above).

Example

```
TRAC? TRACE2
```

The measurement data for the selected graph is returned.

Characteristics

*RST value: -

SCPI: conform

Mode

OFDM, OFDMA/WiBro

TRACe:IQ:DATA:MEMory?

For details refer to ["TRACe<1|2>:IQ:DATA:MEMory?"](#) on page 6.266.

TRACe:IQ:SRATe

This command allows the sample rate for IQ measurements to be specified.

Parameter

1440000 to 32.248E6 Hz

Example

TRAC:IQ:SRAT 2000000

Specifies a sample rate of 20 MHz.

Characteristics

*RST value: -

SCPI: device-specific

Mode

OFDM, OFDMA/WiBro

TRIGger Subsystem (WiMAX, K92/K93)

The trigger subsystem is used to synchronize device action(s) with events.

Commands of the TRIGger Subsystem

- TRIGger[:SEquence]:HOLDoff
- TRIGger[:SEquence]:MODE
- TRIGger[:SEquence]:LEVel[:EXTernal]
- TRIGger[:SEquence]:LEVel:POWer
- TRIGger[:SEquence]:LEVel:POWer:AUTO

TRIGger[:SEquence]:HOLDoff

This command defines the length of the trigger delay. A negative delay time (pretrigger) can be set in zero span only.

Parameter

-3.25 ms to 837.33 ms

Example

```
TRIG:HOLD 500us
```

A holdoff period of 500 μ s is used after the trigger condition has been met.

Characteristics

*RST value: 0 s

SCPI: conform

Mode

OFDM, OFDMA/WiBro

TRIGger[:SEquence]:LEVel[:EXTernal]

This command defines the level of the external trigger input for which triggering will occur.

Parameter

0.5 V to 3.5 V

Example

```
TRIG:MODE EXT
```

Sets the power trigger mode.

```
TRIG:LEV 1 V
```

Sets the triggering level to 1 V.

Characteristics

RST value: 1.4 V

SCPI: device-specific

Mode

OFDM, OFDMA/WiBro

TRIGger[:SEquence]:MODE

This command configures how triggering is to be performed.

Parameter

- IMMediate No triggering is performed. This corresponds to the **Free Run** trigger mode.
- EXTernal The next measurement is triggered by the signal at the external trigger input e.g. a gated trigger.
- POWer The next measurement is triggered by signals outside the measurement channel.

Example

```
TRIG:MODE IMM
```

No triggering is performed.

Characteristics

*RST value: IMMediate

SCPI: device-specific

Mode

OFDM, OFDMA/WiBro

TRIGger[:SEquence]:LEVel:POWer

This command sets the level of the input signal for which triggering will occur.

Parameter

-50 to 20 dBm

Example

```
TRIG:MODE POW
```

Sets the external trigger mode.

```
TRIG:LEV:POW 10 DBM
```

Sets the level to 10 dBm for RF measurement.

Characteristics

*RST value: -20 DBM

SCPI: device-specific

Mode

OFDM, OFDMA/WiBro

TRIGger[:SEquence]:LEVel:POWer:AUTO

This command specifies whether or not an automatic power trigger level calculation is performed before each main measurement. The setting of this command is ignored if the setting for the `TRIGger[:SEquence]:LEVel[:EXTernal]` command is not `POWer`.

Parameter

ON | OFF

Example

```
TRIG:LEV:POW:AUTO ON
```

Specifies that an automatic power trigger level calculation should be performed before the start of each main measurement.

Characteristics

*RST value: OFF

SCPI: device-specific

Mode

OFDM, OFDMA/WiBro

UNIT Subsystem (WiMAX, K92/K93)

The unit subsystem specifies the units for specific result types.

Commands of the UNIT Subsystem

- UNIT:EVM
- UNIT:PREamble
- UNIT:TABLE

UNIT:EVM

This command specifies the units for EVM results.

Parameter

DB EVM results returned in dB
PCT EVM results returned in %

Example

```
UNIT:EVM PCT  
EVM results to be returned in %.
```

Characteristics

RST value: DB
SCPI: device-specific

Mode

OFDM, OFDMA/WiBro

UNIT:PREamble

This command specifies the units for Preamble error results.

Parameter

HZ Preamble error results returned in Hz
DEG Preamble error results returned in degrees

Example

```
UNIT:PRE HZ  
Preamble error results to be returned in Hz.
```

Characteristics

RST value: Hz
SCPI: device-specific

Mode

OFDM, OFDMA/WiBro

UNIT:TABLE

This command specifies the parameters of the result summary that can be displayed as dB or degrees.

Parameter

DB results returned in dB

PCT results returned in %

Example

UNIT:TABLE DB

Results to be returned in dB.

Characteristics

RST value: DB

SCPI: device-specific

Mode

OFDM, OFDMA/WiBro

Contents of Chapter 7

7 Remote Control - Programming Examples	7.1
Analyzer Measurements - Programming Examples	7.1
Service Request	7.1
Initiate Service Request	7.1
Waiting for the Arrival of a Service Request	7.2
Waiting Without Blocking the Keyboard and Mouse	7.3
Service Request Routine	7.4
Reading Out the Output Buffer	7.5
Reading Error Messages	7.5
Evaluation of SCPI Status Registers	7.5
Evaluation of Event Status Register	7.6
Using Marker and Delta Marker	7.6
Shape Factor Measurement (using n dB down)	7.6
Measuring the Third Order Intercept Point	7.7
Measuring the AM Modulation Depth	7.8
Limit Lines and Limit Test	7.9
Measuring the Channel and Adjacent Channel Power	7.11
Occupied Bandwidth Measurement	7.13
Time Domain Power Measurement	7.14
Fast Power Measurement on Power Ramps	7.15
Power Measurement with Multi-Summary Marker	7.15
Multi-Burst Power Measurement	7.17
Fast Level Measurement Using Frequency Lists	7.18
Level Correction of Transducers	7.20
Measuring the Magnitude and Phase of a Signal	7.21
Averaging I/Q Data	7.23
Reading and Writing Files	7.24
Reading a File from the Instrument	7.24
Creating a File on the Instrument	7.25
Spectrum Emission Mask Measurement	7.26
Using Predefined Standard Wibro	7.26
Defining 5 Ranges with all Parameters	7.27
Spurious Emissions Measurement	7.30
WLAN TX Measurements - Programming Examples (Option K91 / K91n)	7.34
Synchronization Entry of Option	7.34
Selecting Measurements	7.34
Running Synchronized Measurements	7.35
WiMAX, WiBro Measurements - Programming Examples (Options K92/93)	7.37
Synchronization Entry of Option	7.37
Selecting Measurements	7.37
Running Synchronized Measurements	7.38

7 Remote Control - Programming Examples

The following programming examples have a hierarchical structure, i.e. subsequent examples are based on previous ones. It is thus possible to compile very easily an operational program from the modules of the given examples. VISUAL BASIC has been used as programming language. However, the programs can be translated into other languages.



In programming languages as C, C++ or programmes as MATLAB, NI Interactive Control, a backslash starts an escape sequence (e.g. "\n" is used to start a new line). In these programming languages and programmes, two backslashes instead of one must be used in remote commands (for an example refer to the Quick Start Guide, chapter 6.)

Analyzer Measurements - Programming Examples

In this chapter, more complex programming examples are given. In the Quick Start Guide, chapter 6, basic steps in remote control programming are provided.

Service Request

The service request routine requires an extended initialization of the instrument in which the relevant bits of the transition and enable registers are set. In addition the service request event must be enabled in the VISA session.

Initiate Service Request

REM ---- Example of initialization of the SRQ in the case of errors -----

PUBLIC SUB SetupSRQ()

CALL InstrWrite(analyzer, "*CLS") 'Reset status reporting system

CALL InstrWrite(analyzer, "*SRE 168") 'Enable service request for
'STAT:OPER, STAT:QUES and ESR
'register

CALL InstrWrite(analyzer, "*ESE 60") 'Set event enable bit for
'command, execution, device-
'dependent and query error

CALL InstrWrite(analyzer, "STAT:OPER:ENAB 32767")
'Set OPERATION enable bit for
'all events

CALL InstrWrite(analyzer, "STAT:OPER:PTR 32767")
'Set appropriate OPERATION
'Ptransition bits

```

CALL InstrWrite(analyzer,"STAT:QUES:ENAB 32767")
                                'Set questionable enable bits
                                'for all events

CALL InstrWrite(analyzer,"STAT:QUES:PTR 32767")
                                'Set appropriate questionable
                                'Ptransition bits

CALL viEnableEvent(analyzer, VI_EVENT_SERVICE_REQ, VI_QUEUE, 0)
                                'Enable the event for service
                                'request

Status = viWaitOnEvent(analyzer, VI_EVENT_SERVICE_REQ, SRQWaitTimeout,
                        VI_NULL, VI_NULL)

IF (status = VI_SUCCESS) THEN CALL Srq    'If SRQ is recognized =>
                                        'subroutine for evaluation

END SUB

REM *****

```

Waiting for the Arrival of a Service Request

There are basically two methods of waiting for the arrival of a service request:

1. Blocking (user inputs not possible):

This method is appropriate if the waiting time until the event to be signalled by an SRQ is short (shorter than the selected timeout), if no response to user inputs is required during the waiting time, and if - as the main criterion - the event is absolutely certain to occur.

Reason:

From the time the `viWaitOnEvent()` function is called until the occurrence of the expected event, it does not allow the program to respond to mouse clicks or key entries during the waiting time.

Moreover, it returns an error if the SRQ event does not occur within the predefined timeout period. The method is, therefore, in many cases not suitable for waiting for measurement results, especially when using triggered measurements.

The following function calls are required:

```

Status = viWaitOnEvent(analyzer, VI_EVENT_SERVICE_REQ, SRQWaitTimeout,
                        VI_NULL, VI_NULL)
                                'Wait for service request user
                                'inputs are not possible during
                                'the waiting time!

IF (status = VI_SUCCESS) THEN CALL Srq
                                'If SRQ is recognized =>
                                'subroutine for evaluation

```

2. Non-blocking (user inputs possible):

This method is recommended if the waiting time until the event to be signalled by an SRQ is long (longer than the selected timeout), and user inputs should be possible during the waiting time, or if the event is not certain to occur. This method is, therefore, the preferable choice for waiting for the end of measurements, i.e. the output of results, especially in the case of triggered measurements.

The method necessitates a waiting loop that checks the status of the SRQ line at regular intervals and returns control to the operating system during the time the expected event has not yet occurred. In this way, the system can respond to user inputs (mouse clicks, key entries) during the waiting time.

It is advisable to employ the `Hold()` auxiliary function, which returns control to the operating system for a selectable waiting time (see section "[Waiting Without Blocking the Keyboard and Mouse](#)"), so enabling user inputs during the waiting time.

```

result% = 0
For i = 1 To 10           'Abort after max. 10 loop
                        'iterations
Status = viWaitOnEvent(analyzer, VI_EVENT_SERVICE_REQ,
                        VI_TMO_IMMEDIATE, VI_NULL,
                        VI_NULL)
                        'Check event queue

If (status = VI_SUCCESS) Then
    result% = 1
    CALL Srq           'If SRQ is recognized =>
                    'subroutine for evaluation

Else
    CALL Hold(20)     'Call hold function with
                    '20 ms 'waiting time. User inputs
                    'are possible.

Endif
Next i

If result% = 0 Then
    Debug.Print "Timeout Error; Program aborted"
                    'Output error message

    STOP             'Stop software

Endif

```

Waiting Without Blocking the Keyboard and Mouse

A frequent problem with remote control programs using Visual Basic is to insert waiting times without blocking the keyboard and the mouse.

If the program is to respond to user inputs also during a waiting time, control over the program events during this time must be returned to the operating system. In Visual Basic, this is done by calling the *DoEvents* function. This function causes keyboard- or mouse-triggered events to be executed by the associated elements. For example, it allows the operation of buttons and input fields while the user waits for an instrument setting to be completed.

The following programming example describes the *Hold()* function, which returns control to the operating system for the period of the waiting time selectable in milliseconds.

```

Rem *****
Rem The waiting function below expects the transfer of the desired
Rem waiting time in milliseconds. The keyboard and the mouse remain
Rem operative during the waiting period, thus allowing desired elements
Rem to be controlled
Rem *****

Public Sub Hold(delayTime As Single)
    Start = Timer           'Save timer count on calling the
                        'function
    Do While Timer < Start + delayTime / 1000 'Check timer count

```

```

DoEvents                                     'Return control to operating
                                              'system to enable control of
                                              'desired elements as long as
                                              'timer has not elapsed

Loop
End Sub
Rem *****

```

The waiting procedure is activated simply by calling *Hold(<Waiting time in milliseconds>)*.

Service Request Routine

A service request is processed in the service request routine.



The variables userN% and userM% must be pre-assigned usefully!

```

REM ----- Service request routine -----
Public SUB Srq()
ON ERROR GOTO noDevice                                     'No user existing
CALL viReadSTB(analyzer, STB%)                          'Serial poll, read status byte
IF STB% > 0 THEN                                          'This instrument has bits set in
                                                         'the STB

    SRQFOUND% = 1
    IF (STB% AND 16) > 0 THEN CALL Outputqueue
    IF (STB% AND 4) > 0 THEN CALL ErrorQueueHandler
    IF (STB% AND 8) > 0 THEN CALL Questionablestatus
    IF (STB% AND 128) > 0 THEN CALL Operationstatus
    IF (STB% AND 32) > 0 THEN CALL Esrread
END IF
noDevice:
END SUB                                                    'End of SRQ routine
Rem *****

```

Reading out the status event registers, the output buffer and the error/event queue is effected in subroutines.

Reading Out the Output Buffer

```

REM ----- Subroutine for the individual STB bits -----
Public SUB Outputqueue()                                'Reading the output buffer
result$ = SPACE$(100)                                     'Make space for response
CALL InstrRead(analyzer, result$)
Debug.Print "Contents of Output Queue : "; result$
END SUB
REM *****

```

Reading Error Messages

```

REM ----- Subroutine for reading the error queue -----
Public SUB ErrorQueueHandler()
ERROR$ = SPACE$(100)                                     'Make space for error variable
CALL InstrWrite(analyzer, "SYSTEM:ERROR?")
CALL InstrRead(analyzer, ERROR$)
Debug.Print "Error Description : "; ERROR$
END SUB
REM *****

```

Evaluation of SCPI Status Registers

```

REM ----- Subroutine for evaluating Questionable Status Register -----
Public SUB Questionablestatus()
Ques$ = SPACE$(20)                                       'Preallocate blanks to text
                                                         'variable
CALL InstrWrite(analyzer, "STaTus:QUEStionable:EVENT?")
CALL InstrRead(analyzer, Ques$)
Debug.Print "Questionable Status: "; Ques$
END SUB
REM *****
REM ----- Subroutine for evaluating Operation Status Register -----
Public SUB Operationstatus()
Oper$ = SPACE$(20)                                       'Preallocate blanks to text
                                                         'variable
CALL InstrWrite(analyzer, "STaTus:OPERation:EVENT?")
CALL InstrRead(analyzer, Oper$)
Debug.Print "Operation Status: "; Oper$
END SUB
REM *****

```

Evaluation of Event Status Register

```

REM ----- Subroutine for evaluating the Event Status Register -----
Public SUB Esrread()
Esr$ = SPACE$(20)                'Preallocate blanks to text
                                  'variable
CALL InstrWrite(analyzer, "*ESR?") 'Read ESR
CALL InstrRead(analyzer, Esr$)
IF (VAL(Esr$) AND 1) > 0 THEN Debug.Print "Operation complete"
IF (VAL(Esr$) AND 2) > 0 THEN Debug.Print "Request Control"
IF (VAL(Esr$) AND 4) > 0 THEN Debug.Print "Query Error"
IF (VAL(Esr$) AND 8) > 0 THEN Debug.Print "Device dependent error"
IF (VAL(Esr$) AND 16) > 0 THEN
    Debug.Print "Execution Error; Program aborted"
                                  'Output error message
    STOP                          'Stop software
    END IF
IF (VAL(Esr$) AND 32) > 0 THEN
    Debug.Print "Command Error; Program aborted"
                                  'Output error message
    STOP                          'Stop software
    END IF
IF (VAL(Esr$) AND 64) > 0 THEN Debug.Print "User request"
IF (VAL(Esr$) AND 128) > 0 THEN Debug.Print "Power on"
END SUB
REM *****

```

Using Marker and Delta Marker

Shape Factor Measurement (using n dB down)

The n-dB-down function of the R&S FSL is used twice to determine the shape factor of a filter (ratio of bandwidths at 60 dB and 3 dB below the filter maximum).

The following example is again based on a signal with a level of -30 dBm at 100 MHz. The shape factor is determined for the 30 kHz resolution bandwidth. The default setting of the R&S FSL is used for measurements (SetupInstrument).

```

REM *****
Public Sub ShapeFactor()
result$ = Space$(100)
'----- R&S FSL default setting -----
CALL SetupInstrument                'Default setting
CALL InstrWrite(analyzer, "INIT:CONT OFF") 'Single sweep

```

```

'----- Set frequency -----
CALL InstrWrite(analyzer,"FREQ:SPAN 1MHz")
                                     'Span
CALL InstrWrite(analyzer,"BAND:RES 30kHz")
                                     'Resolution bandwidth
CALL InstrWrite(analyzer,"INIT;*WAI")
                                     'Perform sweep with sync
'----- Measure 60 dB value -----
CALL InstrWrite(analyzer,"CALC:MARK:PEXC 6DB")
                                     'Peak excursion
CALL InstrWrite(analyzer,"CALC:MARK:STAT ON")
                                     'Marker1 on
CALL InstrWrite(analyzer,"CALC:MARK:TRAC 1")
                                     'Assign marker1 to trace1
CALL InstrWrite(analyzer,"CALC:MARK:MAX")
                                     'Set marker1 to 100 MHz
CALL InstrWrite(analyzer,"CALC:MARK:FUNC:NDBD 45dB")
                                     'Read out bandwidth measured at
                                     '45 dB
CALL InstrWrite(analyzer,"CALC:MARK:FUNC:NDBD:RES?")
CALL InstrRead(analyzer,result$)
result60 = Val(result$)
'----- Measure 3 dB down value-----
CALL InstrWrite(analyzer,"CALC:MARK:FUNC:NDBD 3dB")
                                     'Read out bandwidth measured at
                                     '3 dB
CALL InstrWrite(analyzer,"CALC:MARK:FUNC:NDBD:RES?")
CALL InstrRead(analyzer,result$)
result3 = Val(result$)
'----- Read out shape factor-----
Print "Shapefaktor 60dB/3dB: ";result60/result3
END SUB
REM *****

```

Measuring the Third Order Intercept Point

The third order intercept point (TOI) is the (virtual) level of two adjacent useful signals at which the intermodulation products of third order have the same level as the useful signals.

The intermodulation product at f_{S2} is obtained by mixing the first harmonic of the useful signal P_{N2} with signal P_{N1} , the intermodulation product at f_{S1} by mixing the first harmonic of the useful signal P_{N1} with signal P_{N2} .

$$f_{S1} = 2 \times f_{n1} - f_{n2}(1)$$

$$f_{S2} = 2 \times f_{n2} - f_{n1}(2)$$

The following example is based on two adjacent signals with a level of -30 dBm at 100 MHz and 110 MHz. The intermodulation products lie at 90 MHz and 120 MHz according to the above formula. The frequency is set so that the examined mixture products are displayed in the diagram. Otherwise, the default setting of the R&S FSL is used for measurements (SetupInstrument).

```

REM *****
Public Sub TOI()
result$ = Space$(100)
'----- R&S FSL default setting -----
CALL SetupStatusReg           'Set status registers
CALL InstrWrite(analyzer,"*RST") 'Reset instrument
CALL InstrWrite(analyzer,"INIT:CONT OFF") 'Single sweep
CALL InstrWrite(analyzer,"SYST:DISP:UPD ON")
                                'ON: display on
                                'OFF: off
'----- Set frequency -----
CALL InstrWrite(analyzer,"FREQ:START 85MHz;STOP 125 MHz")
                                'Span
'----- Set level -----
CALL InstrWrite(analyzer,"DISP:WIND:TRAC:Y:RLEV -20dBm")
                                'Reference level
CALL InstrWrite(analyzer,"INIT;*WAI") 'Perform sweep with sync
'----- TOI measurement -----
CALL InstrWrite(analyzer,"CALC:MARK:PEXC 6DB")
                                'Peak excursion
CALL InstrWrite(analyzer,"CALC:MARK:FUNC:TOI ON")
                                'Switch on TOI measurement
CALL InstrWrite(analyzer,"CALC:MARK:FUNC:TOI:RES?")
                                'and read out results
CALL InstrRead(analyzer,result$)
'----- Read out result -----
Print "TOI [dBm]: ";result$
END SUB
REM *****

```

Measuring the AM Modulation Depth

The example below is based on an AM-modulated signal at 100 MHz with the following characteristics:

- Carrier signal level: -30 dBm
- AF frequency: 100 kHz
- Modulation depth: 50 %

The default setting of the analyzer for measurements can be used for the measurements described below (SetupInstrument).

```

REM *****
Public Sub AMMod()
result$ = Space$(100)
CALL SetupInstrument           'Default setting
CALL InstrWrite(analyzer,"BAND:RES 30kHz") 'Set appropriate RBW

```

```

'----- Peak search -----
CALL InstrWrite(analyzer,"INIT:CONT OFF") 'Single sweep
CALL InstrWrite(analyzer,"INIT;*WAI")      'Perform sweep with sync
CALL InstrWrite(analyzer,"CALC:MARK:PEXC 6DB")
                                         'Peak excursion
CALL InstrWrite(analyzer,"CALC:MARK:STAT ON")
                                         'Marker 1 on
CALL InstrWrite(analyzer,"CALC:MARK:TRAC 1")
                                         'Assign marker1 to trace1

'----- Measure modulation depth-----
CALL InstrWrite(analyzer,"CALC:MARK:MAX;FUNC:MDEP ON")
                                         'Marker to Peak;
CALL InstrWrite(analyzer,"CALC:MARK:FUNC:MDEP:RES?")
                                         'Measure mod. depth
CALL InstrRead(analyzer, result$)        'Read out result

'----- Read out result -----
Print "AM Mod Depth [%]: ";result$
END SUB
REM *****

```

Limit Lines and Limit Test

The example below shows the definition and use of a new limit line 5 for trace 1 with the following characteristics:

- Upper limit line
- Absolute x-axis in the frequency range
- 5 reference values:
 - 120 MHz / -70 dB, 126 MHz/-40 dB, 127 MHz/-40 dB, 128 MHz/-10 dB,
 - 129 MHz/-40 dB, 130 MHz/-40 dB, 136 MHz / -70 dB
- Relative y-axis with unit dB
- Absolute threshold at -75 dBm
- No margin

The signal of the integrated calibration source (128 MHz, -30 dBm) is used to check the limit test.

```

REM *****
Public Sub LimitLine()
result$ = Space$(100)
'----- R&S FSL default setting -----
CALL SetupInstrument                    'Default setting
CALL InstrWrite(analyzer,"FREQUENCY:CENTER 128MHz;Span 10MHz")
                                         'Span
CALL InstrWrite(analyzer,"Diag:Serv:Inp Cal;CSO -30dBm")
                                         'Cal signal on

'----- Definition of limit lines -----
CALL InstrWrite(analyzer,"CALC:LIM5:NAME 'TEST1'")
                                         'Define name

```



```

CALL InstrWrite(analyzer,"CALC:LIM5:COMM 'Upper limit'")
                                'Define comment
CALL InstrWrite(analyzer,"CALC:LIM5:TRAC 1")
                                'Assign trace
CALL InstrWrite(analyzer,"CALC:LIM5:CONT:DOM FREQ")
                                'Define x-axis range
CALL InstrWrite(analyzer,"CALC:LIM5:CONT:MODE ABS")
                                'Define x-axis scaling
CALL InstrWrite(analyzer,"CALC:LIM5:UNIT DB")
                                'Define y-axis unit
CALL InstrWrite(analyzer,"CALC:LIM5:UPP:MODE REL")
                                'Define y-axis scaling
'----- Definition of data points and threshold -----
xlimit$ = "CALC:LIM5:CONT 120MHZ,126MHZ,127MHZ,128MHZ,129MHZ,130MHZ,136MHZ"
CALL InstrWrite(analyzer, xlimit$)          'Set values for x-axis
CALL InstrWrite(analyzer,"CALC:LIM5:UPP -70,-40,-40,-20,-40,-40,-70")
                                'Set values for y-axis
CALL InstrWrite(analyzer,"CALC:LIM5:UPP:THR -75DBM")
                                'Set y threshold (only
                                'possible for relative
                                'y-axis)
'----- Definition of margin or x /y offset-----
'A margin or an x /y offset can be defined here.
'----- Activate and evaluate the limit line -----
CALL InstrWrite(analyzer,"CALC:LIM5:UPP:STAT ON")
                                'Activate line 5
CALL InstrWrite(analyzer,"CALC:LIM5:STAT ON")
                                'Activate limit check
CALL InstrWrite(analyzer,"INIT;*WAI")      'Perform sweep with sync
CALL InstrWrite(analyzer,"CALC:LIM5:FAIL?")
                                'Query result of limit check
CALL InstrRead(analyzer, result$)          'Result: 1 (= FAIL)
'----- Read out result -----
Print "Limit Result Line 5: ";result$
'----- Evaluate limit line by means of status register -----
CALL InstrWrite(analyzer,"*CLS")          'Reset status register
'----- Measure -----
CALL InstrWrite(analyzer,"INIT;*OPC")      'Perform sweep with sync
CALL viEnableEvent(analyzer, VI_EVENT_SERVICE_REQ, VI_QUEUE, 0)
Status = viWaitOnEvent(analyzer, VI_EVENT_SERVICE_REQ, SRQWaitTimeout,
VI_NULL, VI_NULL)
IF (status = VI_SUCCESS) THEN CALL Srq     'If SRQ is recognized =>
                                'subroutine for evaluation

```

```

'----- Read out result -----
IF (status% = 1) THEN
    CALL InstrWrite(analyzer,"STAT:QUES:LIM1:COND?")
                                'Read out STAT:QUES:LIMit
                                'register

    CALL InstrRead(analyzer, result$)

    IF ((Val(result$) And 16) <> 0) THEN
        Print "Limit5 failed"
    ELSE
        Print "Limit5 passed"
    END IF
END IF
END SUB
REM *****

```

Measuring the Channel and Adjacent Channel Power

In the following example, the channel and adjacent channel power is first measured on a signal with a level of 0 dBm at 800 MHz to IS95. Then the channel and adjacent channel power is measured on a GSM signal at 935.2 MHz with fast ACP measurement (FAST ACP).

In addition, the limit test is activated.

```

REM *****
Public Sub ACP()
result$ = Space$(100)

'----- R&S FSL default setting -----
CALL SetupStatusReg                'Set status register
CALL InstrWrite(analyzer,"*RST")    'Reset instrument
CALL InstrWrite(analyzer,"INIT:CONT OFF") 'Single sweep
CALL InstrWrite(analyzer,"SYST:DISP:UPD ON")
                                'ON: display on
                                'OFF: off

'----- Set frequency -----
CALL InstrWrite(analyzer,"FREQ:CENT 800MHz")
                                'Set frequency

'----- Set level -----
CALL InstrWrite(analyzer,"DISP:WIND:TRAC:Y:RLEV 10dBm")
                                'Reference level

'----- Example 1: Configure CP/ACP for CDMA-----
CALL InstrWrite(analyzer,"CALC:MARK:FUNC:POW:SEL ACP")
                                'ACP measurement on
CALL InstrWrite(analyzer,"CALC:MARK:FUNC:POW:PRES F8CDMA")
                                'Select CDMA800 FWD
CALL InstrWrite(analyzer,"SENS:POW:ACH:ACP 2")
                                'Select 2 adjacent channels

```

```
CALL InstrWrite(analyzer,"SENS:POW:ACH:PRES ACP")
                                'Optimize settings
CALL InstrWrite(analyzer,"SENS:POW:ACH:PRES:RLEV")
                                'Optimize reference level
CALL InstrWrite(analyzer,"SENS:POW:ACH:MODE ABS")
                                'Absolute measurement
CALL InstrWrite(analyzer,"SENS:POW:HSP ON")
                                'Fast ACP measurement

'----- Perform measurement and query results -----
CALL InstrWrite(analyzer,"INIT;*WAI")      'Perform sweep with sync
CALL InstrWrite(analyzer,"CALC:MARK:FUNC:POW:RES? ACP")      'Query result
                                CALL InstrRead(analyzer, result$)

'----- Read out result -----
Print "Result (CP, ACP low, ACP up, Alt low, Alt up): "
Print result$

'----- Example 2: Configure CP/ACP manually for GSM-----
result$ = Space$(100)
CALL InstrWrite(analyzer,"FREQ:CENT 935.2MHz")
                                'Set frequency
CALL InstrWrite(analyzer,"CALC:MARK:FUNC:POW:SEL ACP")
                                'ACP measurement on
CALL InstrWrite(analyzer,"SENS:POW:ACH:ACP 1")
'1 adjacent channel
CALL InstrWrite(analyzer,"SENS:POW:ACH:BAND 200KHZ")
'Channel bandw. 200 kHz
CALL InstrWrite(analyzer,"SENS:POW:ACH:BAND:ACH 200KHZ")
                                'Adjacent channel band-
                                'width 200 kHz
CALL InstrWrite(analyzer,"SENS:POW:ACH:SPAC 200KHZ")
                                'Channel spacing 200 kHz
CALL InstrWrite(analyzer,"SENS:POW:ACH:PRES ACP")
                                'Optimize settings
CALL InstrWrite(analyzer,"SENS:POW:ACH:PRES:RLEV")
                                'Optimize reference level
CALL InstrWrite(analyzer,"SENS:POW:ACH:MODE ABS")
                                'Absolute measurement

'----- Start measurement and query result -----
CALL InstrWrite(analyzer,"INIT;*WAI")      'Perform sweep with sync
CALL InstrWrite(analyzer,"CALC:MARK:FUNC:POW:RES? ACP")
                                'Query result

CALL InstrRead(analyzer, result$)

'----- Read out result -----
Print "Result (CP, ACP low, ACP up): "
Print result$
```

```

'----- Active limit check -----
result$ = Space$(100)
CALL InstrWrite(analyzer,"CALC:LIM:ACP:ACH 30DB, 30DB")
                                'Set relative limit
CALL InstrWrite(analyzer,"CALC:LIM:ACP:ACH:ABS -35DBM,-35DBM")
                                'Set absolute limit
CALL InstrWrite(analyzer,"CALC:LIM:ACP:ACH:STAT ON")
                                'Rel. limit check on
CALL InstrWrite(analyzer,"CALC:LIM:ACP:ACH:ABS:STAT ON")
                                'Abs. limit check on
CALL InstrWrite(analyzer,"CALC:LIM:ACP ON")
                                'Limit check on

'----- Start measurement and query result -----
CALL InstrWrite(analyzer,"INIT;*WAI")      'Perform sweep with sync
CALL InstrWrite(analyzer,"CALC:LIM:ACP:ACH:RES?")
                                'Query result of limit check
CALL InstrRead(analyzer, result$)
'----- Read out result -----
Print "Result Limit Check: ";result$
END SUB
REM *****

```

Occupied Bandwidth Measurement

In the following example, the bandwidth is to be found in which 95% of the power of a GSM signal is contained. Signal frequency is 935.2 MHz; channel bandwidth is 200 kHz.

```

REM *****
Public Sub OBW()
result$ = Space$(100)
'----- R&S FSL default setting -----
CALL SetupStatusReg              'Set status register
CALL InstrWrite(analyzer,"*RST")  'Reset instrument
CALL InstrWrite(analyzer,"INIT:CONT OFF") 'Single sweep
CALL InstrWrite(analyzer,"SYST:DISP:UPD ON")
                                'ON: display on
                                'OFF: off
'----- Configure R&S FSL for OBW for GSM-----
CALL InstrWrite(analyzer,"FREQ:CENT 935.2MHz")
                                'Set frequency
CALL InstrWrite(analyzer,"CALC:MARK:FUNC:POW:SEL OBW")
                                'OBW measurement on
CALL InstrWrite(analyzer,"SENS:POW:ACH:BAND 200KHZ")
                                'Channel bandw. 200 kHz

```

```
CALL InstrWrite(analyzer,"SENS:POW:BWID 95PCT")
                                     'Percentage of power
CALL InstrWrite(analyzer,"SENS:POW:ACH:PRES OBW")
                                     'Set frequency and optimize
                                     reference level
CALL InstrWrite(analyzer,"SENS:POW:ACH:PRES:RLEV")
CALL InstrWrite(analyzer,"SENS:POW:NCOR OFF")
                                     'Noise correction
                                     'OFF: switch off
                                     'ON:  switch on

'----- Perform measurement and query results -----
CALL InstrWrite(analyzer,"INIT;*WAI")   'Perform sweep with sync
CALL InstrWrite(analyzer,"CALC:MARK:FUNC:POW:RES? OBW")
                                     'Query result

CALL InstrRead(analyzer, result$)
Print result$
END SUB
REM *****
```

Time Domain Power Measurement

In the following example, the mean carrier power of a signal with 300 kHz bandwidth at 100 MHz is to be determined. In addition, the peak power, the rms value and the standard deviation are measured. To do this, the time-domain-power measurement functions are used.

```
REM *****
Public Sub TimeDomainPower()
result$ = Space$(100)
'----- R&S FSL default setting -----
CALL SetupStatusReg                 'Set status register
CALL InstrWrite(analyzer,"*RST")    'Reset instrument
CALL InstrWrite(analyzer,"INIT:CONT OFF") 'Single sweep
CALL InstrWrite(analyzer,"SYST:DISP:UPD ON")
                                     'ON: display on
                                     'OFF: off

'----- Configure R&S FSL for time domain power measurement -----
CALL InstrWrite(analyzer,"FREQ:CENT 100MHz;SPAN 0Hz")
                                     'Set frequency
CALL InstrWrite(analyzer,"BAND:RES 300kHz")
                                     'Resolution bandwidth
CALL InstrWrite(analyzer,"SWE:TIME 200US") 'Sweep time
CALL InstrWrite(analyzer,"CALC:MARK:FUNC:SUMM:PPE ON")
                                     'Peak measurement on
CALL InstrWrite(analyzer,"CALC:MARK:FUNC:SUMM:MEAN ON")
                                     'Mean measurement on
```

```

CALL InstrWrite(analyzer,"CALC:MARK:FUNC:SUMM:RMS ON")
                                     'RMS measurement on
CALL InstrWrite(analyzer,"CALC:MARK:FUNC:SUMM:SDEV ON")
                                     'Standard deviation on

'----- Perform measurement and query results -----
CALL InstrWrite(analyzer,"INIT;*WAI")   'Perform sweep with sync
                                     'Query results:
query$ = " CALC:MARK:FUNC:SUMM:PPE:RES?;" 'Peak measurement
query$ = query$ + ":CALC:MARK:FUNC:SUMM:MEAN:RES?;"
                                     'Mean measurement
query$ = query$ + ":CALC:MARK:FUNC:SUMM:RMS:RES?;"
                                     'RMS measurement
query$ = query$ + ":CALC:MARK:FUNC:SUMM:SDEV:RES?"
                                     'Standard deviation

CALL InstrWrite(analyzer, query$)
CALL InstrRead(analyzer, result$)
Print result$
END SUB
REM *****

```

Fast Power Measurement on Power Ramps

A frequent task in mobile radio tests is measurement of a DUT at various power control levels at the highest possible speed. The R&S FSL offers two test functions for this task, which can be used depending on the signal characteristics.

In the following, the two methods are presented by means of two examples.

Power Measurement with Multi-Summary Marker

The multi-summary marker function is suitable for measuring the power of a sequence of pulses with the following characteristics:

- The pulses occur at identical time intervals, which is typical of GSM transmission in slots, for example.
- The level of the first signal is reliably above threshold.
- The subsequent pulses may have any levels.

The function uses the first pulse as a trigger signal. The power of the subsequent pulses is determined exclusively via the timing pattern selected for the pulse sequence. The function is, therefore, suitable for adjustments where the DUT output power varies considerably and is not reliably above the trigger threshold.

The measurement accuracy is determined by the ratio of pulse duration to total measurement time; this should not be below 1:50.

The function always uses TRACE 1.

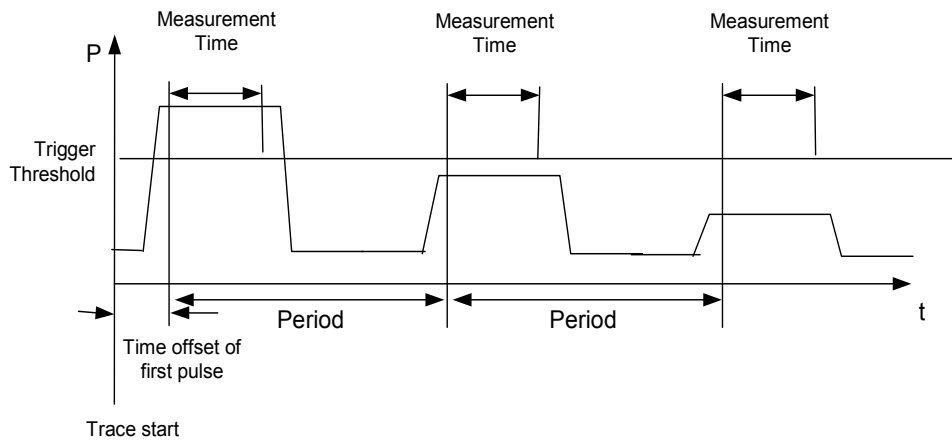

Fig. 7-1 Block diagram illustrating signal processing in analyzer

In the example below, a GSM pulsed sequence of 8 pulses is measured with an offset of 50 μ s of the first pulse, 450 μ s measurement time/pulse and 576.9 μ s pulse period.

```

REM *****
Public Sub MultiSumMarker()
result$ = Space$(200)
'<----- R&S FSL default setting-----'
CALL SetupStatusReg           'Configure status register
CALL InstrWrite(analyzer,"*RST") 'Reset instrument
CALL InstrWrite(analyzer,"INIT:CONT OFF") 'Single sweep mode
CALL InstrWrite(analyzer,"SYST:DISP:UPD ON")
                                'ON: switch display on
                                'OFF: switch display off
'<----- Configure R&S FSL for power measurement in time domain -----'
CALL InstrWrite(analyzer,"FREQ:CENT 935.2MHz;SPAN 0Hz")
                                'Frequency setting
CALL InstrWrite(analyzer,"DISP:WIND:TRAC:Y:RLEV 10dBm")
                                'Set reference level to 10 dB
CALL InstrWrite(analyzer,"INP:ATT 30 dB") 'Set input attenuation to 30 dB
CALL InstrWrite(analyzer,"BAND:RES 1MHz;VID 3MHz")
                                'Bandwidth setting
CALL InstrWrite(analyzer,"DET RMS") 'Select RMS detector
CALL InstrWrite(analyzer,"TRIG:SOUR VID") 'Trigger source: video
CALL InstrWrite(analyzer,"TRIG:LEV:VID 50 PCT")
                                'Trigger threshold: 50%
CALL InstrWrite(analyzer,"SWE:TIME 50ms") 'Sweep time  $\geq$  1 frame
'<----- Perform measurement and query results -----'
CALL InstrWrite(analyzer,"INIT;*WAI") 'Perform sweep with sync
                                'Query results:
cmd$ = "CALC:MARK:FUNC:MSUM? "
    
```

```

cmd$ = cmd$ + "50US,"           'Offset of first pulse
cmd$ = cmd$ + "450US,"        'Measurement time
cmd$ = cmd$ + "576.9US,"     'Pulse period
cmd$ = cmd$ + "8"            'Number of bursts
CALL InstrWrite(analyzer,cmd$)
CALL InstrRead(analyzer, result$) 'Read results
Print result$
END SUB
REM *****

```

Multi-Burst Power Measurement

The multi-burst power measurement function is suitable for measuring the power of a sequence of pulses with the following characteristics:

- The pulses occur at variable time intervals.
- The levels of all pulses of the sequence are reliably above the trigger threshold, or an external trigger signal is used.

The function requires one trigger event per pulse. This means that if the video trigger or the IF power trigger is used, the levels of all pulses must be above the trigger threshold.

The function is, therefore, particularly suitable for re-measuring DUTs already adjusted and whose output power is within the specified range. The measurement is optimized for minimum overhead relative to the actual measurement time.

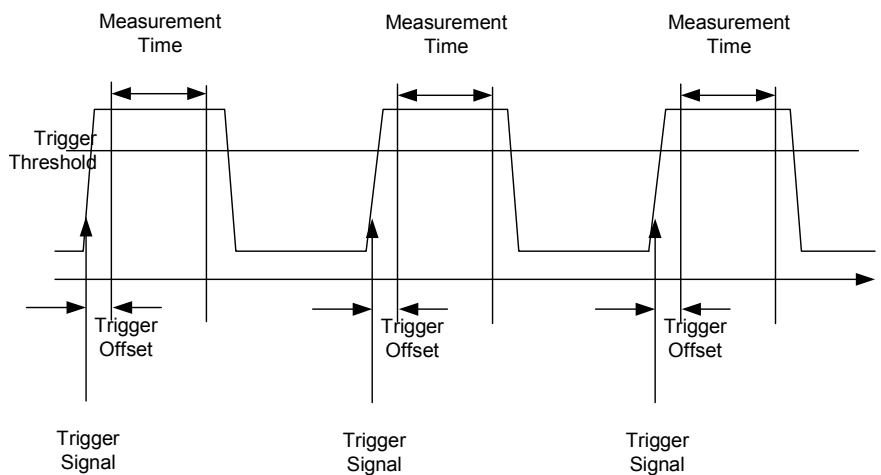

Fig. 7-2 Block diagram illustrating signal processing in analyzer

Either the root-mean-square power or the peak power is measured, depending on whether the RMS detector or the PEAK detector is selected. The function always uses TRACE 1.

The following parameters are to be set for this measurement:

- Analyzer frequency
- Resolution bandwidth
- Measurement time per single pulse
- Trigger source
- Trigger threshold
- Trigger offset

- Type of power measurement (PEAK, MEAN)
- Number of pulses to be measured

During the measurement, each pulse is mapped into a pixel of the screen, i.e. any change of the trace can be detected only at the left-hand edge of the screen. Maximum measurement speed is as usual achieved with the display switched off.

In the example below, a GSM pulse sequence of 8 pulses is measured with 5 µs trigger offset, 434 µs measurement time/pulse, video trigger with 50% trigger threshold, and peak detection:

```

REM *****
Public Sub MultiBurstPower()
result$ = Space$(200)
'----- R&S FSL default setting -----
CALL SetupStatusReg           'Configure status register
CALL InstrWrite(analyzer,"*RST") 'Reset instrument
CALL InstrWrite(analyzer,"INIT:CONT OFF") 'Single sweep mode
CALL InstrWrite(analyzer,"SYST:DISP:UPD OFF")
                                   'OFF: display off
'----- Perform measurement and query results -----
cmd$ = "MPOW? "
cmd$ = cmd$ + "935.2 MHZ,"          'Center frequency
cmd$ = cmd$ + "1MHZ,"              'Resolution bandwidth
cmd$ = cmd$ + "434US,"             'Measurement time
cmd$ = cmd$ + "VID,"               'Trigger source
cmd$ = cmd$ + "50PCT,"             'Trigger threshold
cmd$ = cmd$ + "1US,"               'Trigger offset, must be > 125 ns
cmd$ = cmd$ + "PEAK,"              'Peak detector
cmd$ = cmd$ + "8"                  'Number of bursts
CALL InstrWrite(analyzer, cmd$)
CALL InstrRead(analyzer, result$) 'Read results
Print result$
END SUB
REM *****

```

Fast Level Measurement Using Frequency Lists

A typical task for the R&S FSL is power measurement at a number of frequency points, e.g. at multiples of the fundamental (harmonics measurement), or at frequencies defined by a mobile radio standard (e.g. spectrum due to transients at ± 200 kHz, ± 400 kHz, etc about the carrier frequency of a GSM signal). In many cases, different level and/or bandwidth settings are required for the different frequency points to match the channel spacing and meet the requirements of dynamic range.

Especially for this application, the R&S FSL offers a number of remote-control functions (commands available in SENSE:LIST subsystem) that allow level measurement based on a frequency list with different instrument settings assigned to different frequencies. Not only the frequency list can be

programmed, but also the measurement types (PEAK, RMS, AVG) to be performed simultaneously can be selected.

The example below describes a harmonics measurement on a dual-band amplifier. The harmonics level in general decreases as the frequency increases. To boost measurement sensitivity, therefore, the reference level is lowered by 10 dB from the third harmonic.

The following settings are used:

Reference level: 10.00 dBm up to first harmonic, 0 dBm from 2nd harmonic
 RF attenuation: 20 dB
 Electronic attenuation: 0 dB (OFF)
 Filter type: NORMal
 RBW: 1 MHz
 VBW: 3 MHz
 Measurement time: 300 µs
 Trigger delay: 100 µs
 Trigger: video, 45 %

Frequency	Type
935.2 MHz	GSM 900 fundamental
1805.2 MHz	GSM 1800 fundamental
1870.4 MHz	GSM 900 2nd harmonic
2805.6 MHz	GSM 900 3rd harmonic
3610.4 MHz	GSM 1800 2nd harmonic
3740.8 MHz	GSM 900 4th harmonic
5815.6 MHz	GSM 1800 3rd Harmonic

The frequencies are selected in ascending order to minimize system-inherent waiting times resulting from frequency changes.

At each frequency point the peak power and the rms power are measured. The peak power and the rms power values are stored alternately in the results memory.

```

REM *****
Public Sub FrequencyList()
result$ = Space$(500)

'----- R&S FSL default setting -----
CALL SetupStatusReg           'Configure status register
CALL InstrWrite(analyzer,"*RST") 'Reset instrument
CALL InstrWrite(analyzer,"INIT:CONT OFF") 'Single sweep mode
CALL InstrWrite(analyzer,"SYST:DISP:UPD OFF") 'Display off

'-----Configure R&S FSL for power measurement based on frequency list -
CALL InstrWrite(analyzer, "TRIG:LEV:IFP -20dBm") 'Set IF power trigger level
CALL InstrWrite(analyzer, "LIST:POWer:SET ON,ON,OFF,IFP,POS,100us,0")

'----- Perform measurement and query results -----
cmd$ = "LIST:POWer?"
cmd$ = cmd$ + "935.2MHZ,10dBm,20dB,OFF,NORM,1MHz,3MHz,300us,0,"
cmd$ = cmd$ + "1805.2MHZ,10dBm,20dB,OFF,NORM,1MHz,3MHz,300us,0,"
cmd$ = cmd$ + "1870.4MHZ,10dBm,20dB,OFF,NORM,1MHz,3MHz,300us,0,"
cmd$ = cmd$ + "2805.6MHZ,0dBm,20dB,OFF,NORM,1MHz,3MHz,300us,0,"
    
```

```
cmd$ = cmd$ + "3610.4MHz,10dBm,20dB,OFF,NORM,1MHz,3MHz,300us,0,"
cmd$ = cmd$ + "3740.8MHz,0dBm,20dB,OFF,NORM,1MHz,3MHz,300us,0,"
cmd$ = cmd$ + "5815.6MHz,0dBm,20dB,OFF,NORM,1MHz,3MHz,300us,0"
CALL InstrWrite(analyzer, cmd$)
CALL InstrRead(analyzer, result$)
Print result$
END SUB
```

REM *****

Level Correction of Transducers

In more complex test systems, the frequency response of the test setup must be taken into account in all power measurements to avoid any measurement errors being introduced from sources other than the DUT.

The R&S FSL offers the possibility of defining a frequency-dependent attenuation correction factor (transducer factor).

In the example below, a factor with the following characteristics is defined:

Name:	Transtest
Unit:	dB
Scaling:	lin
Comment:	simulated cable correction
Frequency	Level
10 MHz	0 dB
100 MHz	3 dB
1 GHz	7 dB
3 GHz	10 dB

The factor is defined and can be activated as required.

REM *****

Public Sub TransducerFactor()

'----- Define transducer factor -----'

```
CALL InstrWrite(analyzer,"CORR:TRAN:SEL 'TRANSTEST'")
                                'Define "Transtest"
                                'transducer factor
CALL InstrWrite(analyzer,"CORR:TRAN:UNIT 'DB'")
                                'Unit 'dB'
CALL InstrWrite(analyzer,"CORR:TRAN:SCAL LIN")
                                'Linear frequency-axis
CALL InstrWrite(analyzer,"CORR:TRAN:COMM 'Simulated cable correction'")
cmd$ = "CORR:TRAN:DATA "
cmd$ = cmd$ + "10MHz, 0,"
cmd$ = cmd$ + "100MHz, 3,"
cmd$ = cmd$ + "1GHz, 7,"
cmd$ = cmd$ + "3GHz, 10"
CALL InstrWrite(analyzer,cmd$)
                                'Enter frequency and level values
```

```
'----- Activate transducer -----
CALL InstrWrite(analyzer,"CORR:TRAN:STAT ON")
                                     'Activate transducer factor

END SUB
REM *****
```

Measuring the Magnitude and Phase of a Signal

Due to the R&S FSL's internal architecture, it is capable of measuring and outputting the magnitude and phase of a signal in addition to its power values. This opens up a variety of possibilities for more in-depth analysis (FFT, demodulation, etc).

I/Q data is stored in memory areas each containing 512 k words. Hardware triggering controls the memory.

The following example shows the steps necessary to collect data at a predefined sampling rate and read it from the I/Q memory.

Data is output in the form of voltage values referred to the analyzer input. Data can be read in binary or ASCII format.

In binary format, the length information carried in the message header is evaluated and used for calculating the x-axis values.

In ASCII format, only a list of voltage values is output.

Binary data is read in three steps:

1. The number of digits carrying the length information is read.
2. The length information itself is read.
3. The trace data is read.

This procedure is necessary with programming languages like Visual Basic which support only structures of identical data types (arrays), whereas the binary data format uses different data types in the header and the data section.



The arrays for measured data are dimensioned in such a way that they can accommodate the I/Q data of the R&S FSL (2 x 512 k).

```
REM *****
Public Sub ReadIQData ()
'----- Create variables -----
Dim IData(131072) As Single      'Buffer for floating-point
                                'I data (= 512*1024 bytes)
Dim QData(131072) As Single      'Buffer for floating-point
                                'Q data (= 512*1024 bytes)
                                'Note:
                                'Visual Basic cannot read in
                                'data volumes larger than
                                '512 k words!
Dim digits As Byte              'No. of digits as length
```

```

Dim IQBytes As Long           'Length of trace data in bytes
Dim IQValues As Long         'No. of meas. values in buffer
Dim retCount As Integer      'Return count from read
asciiResult$ = Space$(6553600) 'Buffer for ASCII I/Q data
                               '(= 25*2*1024 bytes)
result$ = Space$(100)        'Buffer for simple results
'----- Default setting -----
CALL SetupInstrument          'Default setting
CALL InstrWrite(analyzer,"TRAC:IQ:STAT ON")
                               'Activate I/Q data
                               'acquisition mode; must be
                               'done before TRAC:IQ:SET !
                               'Select number of test points
                               '(= 512 * 1024 - 512) at
                               'RBW 10 MHz, 'sample rate 32 MHz,
                               'trigger free run, pos. trigger
                               'edge and 0 s trigger delay.
CALL InstrWrite(analyzer,"TRAC:IQ:SET NORM,10MHz,32MHz,IMM,POS,0,130560")
'----- Read-out in binary format-----
CALL InstrWrite(analyzer, "FORMAT REAL,32")
                               'Set binary format
CALL InstrWrite(analyzer, "TRAC:IQ:DATA?")
                               'Measure + read out I/Q data
CALL viRead(analyzer, result$, 2, retCount)
                               'Read and store length for
digits = Val(Mid$(result$, 2, 1)) 'number of digits
result$ = Space$(100)          'Re-initialize buffer
CALL viRead(analyzer, result$, digits, retCount)
                               'Read and store length
IQBytes = Val(Left$(result$, digits))
IQBytes = IQBytes / 2          'Divide no. per buffer in half
CALL viRead(analyzer, IData(0), IQBytes, retCount)
                               'Read I data in buffer
CALL viRead(analyzer, QData(0), IQBytes, retCount)
                               'Read Q data in buffer
CALL viRead(analyzer, result$, 1, retCount)
                               'Read in end character <NL>
'----- Output of binary data as frequency/level pair -----
IQValues = IQBytes/4          'Single Precision = 4 Bytes
For i = 0 To IQValues - 1
    Print "I-Value["; i; "] = "; IData(i)
    Print "Q-Value["; i; "] = "; QData(i)
Next i

```

```
'----- Read-out in ASCII format -----
CALL InstrWrite(analyzer,"FORMAT ASCII") 'Set ASCII format
CALL InstrWrite(analyzer,"TRAC:IQ:DATA?") 'Re-measure and read out
                                          'I/Q data

CALL InstrRead(analyzer, asciiResult$)
CALL InstrWrite(analyzer,"TRAC:IQ:STAT OFF")
                                          'Stop I/Q data aquisition
                                          'mode if no further
                                          'measurements are to be
                                          'done

END SUB
REM *****
```

Averaging I/Q Data

The R&S FSL has averaging capability also for I/Q measurements, i.e. I/Q data can be averaged over several test runs. This is subject to the following conditions:

1. An external trigger signal must be available for data measurement, and the trigger signal must be phase-locked to the signal measured.
2. The same reference-frequency signal must be used for the DUT and the R&S FSL.
3. The sampling rate must be 32 MHz, since only with this sampling frequency will the measurement be performed phase-synchronous with the trigger signal.

If all of the above conditions are fulfilled, no phase shift will occur between consecutive test runs. Phase shift may falsify the measured average so that in extreme cases a value of 0 is obtained.

The default setting of the instrument for data measurement without averaging has to be changed as follows:

```
REM *****
'----- R&S FSL default setting -----
CALL SetupInstrument 'Default setting
CALL InstrWrite(analyzer,"TRAC:IQ:STAT ON")
                  'Activate I/Q data acquisition
                  'mode; this must be
                  'done before TRAC:IQ:SET!

'Select max. number of test points (= 512 * 1024 - 512) at 10 MHz RBW,
                  '32 MHz sampling rate, external
                  'trigger, pos. trigger edge and
                  '0 s trigger delay.

CALL InstrWrite(analyzer,"TRAC:IQ:SET NORM,10MHz,32MHz,EXT,POS,0,130560")
CALL InstrWrite(analyzer,"TRAC:IQ:AVER ON") 'Switch on I/Q averaging
CALL InstrWrite(analyzer,"TRAC:IQ:AVER:COUN 10") 'Set 10 test runs

'----- Read data in binary format -----
...
REM *****
```

Reading and Writing Files

Reading a File from the Instrument

In the following example, the TEST1.FSL.DFL file stored under C:\R_S\Instr\user is read from the instrument and stored in the controller.

```

REM *****
Public Sub ReadFile()
'----- Generate variables -----
Dim digits As Byte           'Number of digits of
                             'length information
Dim fileBytes As Long        'Length of file with trace data
                             'in bytes
result$ = Space$(100)        'Buffer for simple results
'----- Default setting of status register -----
CALL SetupStatusReg         'Configure status register
'----- Read out file -----
CALL InstrWrite(analyzer, "MMEM:DATA? 'C:\R_S\Instr\user\TEST1.FSL.DFL'")
                             'Select file
CALL ilrd(analyzer, result$, 2) 'Read and store number of
digits = Val(Mid$(result$, 2, 1)) 'digits of length information
CALL ilrd(analyzer, result$, digits) 'Read and store length
fileBytes = Val(Left$(result$, digits)) 'information
FileBuffer$ = Space$(fileBytes) 'Buffer for file
CALL ilrd(analyzer, FileBuffer, fileBytes) 'Read file into buffer
CALL ilrd(analyzer, result$, 1) 'Read terminator <NL>
'----- Store file to controller -----
Open "TEST1.FSL.DFL" For Output As #1
Print #1, FileBuffer;        ' ; to avoid linefeed at
                             ' end of file

Close #1
END SUB
REM *****

```

Creating a File on the Instrument

In the following example, the TEST1.FSL.DFL file available on the controller is stored in the instrument under C:\R_S\Instr\user\DUPLICAT.FSL.DFL.

```

REM *****
Public Sub WriteFile()
'----- Generate variables -----
FileBuffer$ = Space$(100000)           'Buffer for file
Dim digits As Long                    'Number of digits of
                                       'length information
Dim fileBytes As Long                 'Length of file in bytes
fileSize$ = Space$(100)               'Length of file as a string
result$ = Space$(100)                'Buffer for simple results
'----- Default setting of status register -----
CALL SetupStatusReg                  'Configure status register
'----- Prepare the definite length block data -----
fileBytes = FileLen("H:\work\vb\TEST1.FSL.DFL")
                                       'Determine length of file
fileSize$ = Str$(fileBytes)
digits = Len(fileSize$) - 1           'Determine number of digits of
fileSize$ = Right$(fileSize$, digits) 'length information
FileBuffer$ = "#" + Right$(Str$(digits), 1) + fileSize$
                                       'Store length information in
                                       'file buffer
'----- Read file from controller -----
Open "H:\work\vb\TEST1.FSL.DFL" For Binary As #1
FileBuffer$ = FileBuffer$ + Left$(Input(fileBytes, #1), fileBytes)
Close #1
'----- Write file -----
CALL InstrWrite(analyzer, "SYST:COMM:GPIB:RTER EOI") 'Set receive
                                                    'terminator on the
                                                    'instrument
CALL InstrWrite(analyzer, "MMEM:DATA 'DUPLICAT.FSL.DFL'," + FileBuffer$)
                                                    'Select file

END SUB
REM *****

```

Spectrum Emission Mask Measurement

You can configure Spectrum Emission Mask measurements via XML files provided for different standards or by defining ranges and parameters. For both ways an example is given.

Using Predefined Standard Wibro

In the following example, the Spectrum Emission Mask measurement is configured using a predefined standard XML file.

```

REM *****
'----- General settings of the instrument -----'
CALL InstrWrite(analyzer,"*RST")           'Reset instrument
CALL InstrWrite(analyzer,"INIT:CONT OFF")  'Switch to single sweep
CALL InstrWrite(analyzer,":SENSel:SWEep:MODE ESpectrum")
                                           'Set measurement mode

Rem After preset 3 ranges are available where the middle one is
Rem the reference range for calculating the TX power
CALL InstrWrite(analyzer,":SENSel:FREQuency:CENTer 2.2GHz")
                                           'Center frequency 2.2 GHz
CALL InstrWrite(analyzer,":SENSel:DETEctor1 RMS")
                                           'Set RMS detector

'----- Setting up the gated trigger -----'
CALL InstrWrite(analyzer,":SENSel:SWEep:EGATE ON")
                                           'Switch on the external gate mode
CALL InstrWrite(analyzer,":SENSel:SWEep:EGATE:SOURce EXTernal")
                                           'Set external gate source
CALL InstrWrite(analyzer,":SENSel:SWEep:EGATE:HOLDoff 0s")
                                           'Set delay time to 0 s
CALL InstrWrite(analyzer,":SENSel:SWEep:EGATE:LENGth 200 US")
                                           'Set time interval

'----- Setting the standard -----'
CALL InstrWrite(analyzer,"SENSel:ESpectrum:PRESet:STANdard
                                           'WIBRO\DL\PowerClass_29_40.xml'")
                                           'Set WiBro standard

'----- Measuring -----'
CALL InstrWrite(analyzer,"INIT;*WAI")      'Perform sweep, wait for sweep
                                           'end

'----- Reading out results -----'
CALL InstrWrite(analyzer,":TRACel:DATA? LIST")
                                           'Query list results
CALL InstrWrite(analyzer,":CALCulate:LIMit:FAIL?")
                                           'Query result of limit check

CALL InstrRead(analyzer, result$)
REM *****

```

Defining 5 Ranges with all Parameters

In the following example, the Spectrum Emission Mask measurement is configured by defining ranges and parameters.

```

REM *****
'----- General settings of the instrument -----'
CALL InstrWrite(analyzer,"*RST")           'Reset instrument
CALL InstrWrite(analyzer,"INIT:CONT OFF")  'Switch to single sweep
CALL InstrWrite(analyzer,":SENSel:SWEep:MODE ESpectrum")
                                           'Set measurement mode
Rem After preset 3 ranges are available where the middle one is
Rem the reference range for calculating the TX power
CALL InstrWrite(analyzer,":SENSel:FREQuency:CENTer 2.2GHz")
                                           'Center frequency 2.2 GHz
CALL InstrWrite(analyzer,":SENSel:DETEctor1 RMS")
                                           'Set RMS detector
CALL InstrWrite(analyzer,":TRIGger1:SEQuence:SOURce IMMEDIATE")
                                           'Trigger setup

'----- Setting up the gated trigger -----'
Rem If a free run trigger is not appropriate a gated trigger can
Rem be set up (just comment in the following lines).
Rem CALL InstrWrite(analyzer,":SENSel:SWEep:EGATE ON")
Rem Switch on the external gate mode
Rem CALL InstrWrite(analyzer,":SENSel:SWEep:EGATE:SOURce EXTERNAL")
Rem Set external gate source
Rem CALL InstrWrite(analyzer,":SENSel:SWEep:EGATE:HOLDoff 0s")
Rem Set delay time to 0 s
Rem CALL InstrWrite(analyzer,":SENSel:SWEep:EGATE:LENGth 200 US")
Rem Set time interval

'----- Setting the span -----'
CALL InstrWrite(analyzer,":SENSel:FREQuency:SPAN 8 MHZ")
                                           'Set the span to 8 MHz

'----- Inserting new ranges -----'
Rem Enlarge number of ranges to 5 by adding one at the end
Rem and one at the beginning. This ensures that the reference range
Rem remains in the middle
CALL InstrWrite(analyzer,":SENSel:ESpectrum:RANGe2:INSert AFter")
                                           'Insert a range after range 2
CALL InstrWrite(analyzer,":SENSel:ESpectrum:RANGe1:INSert BEFore")
                                           'Insert a range before range 1

'----- Defining the limit check for all ranges -----'
CALL InstrWrite(analyzer,":SENSel:ESpectrum:RANGe:LIMit:STATe AND")
                                           'Set check for absolute and
                                           'relative limit

```

```
'----- Defining the reference range settings -----  
Rem The bandwidth of the reference range limits the minimum span  
Rem of the reference range definition later in the script.  
CALL InstrWrite(analyzer,":SENSE1:ESpectrum:RTYPE CPOWER")  
                                     'Set power reference type  
CALL InstrWrite(analyzer,":SENSE1:ESpectrum:BWID 2 MHZ")  
                                     'Set bandwidth  
  
'----- Defining the settings of range 1 -----  
CALL InstrWrite(analyzer,":SENSE1:ESpectrum:RANGE1:FREQUENCY:START -4MHz")  
                                     'Set the start frequency  
CALL InstrWrite(analyzer,":SENSE1:ESpectrum:RANGE1:FREQUENCY:STOP -2MHz")  
                                     'Set the stop frequency  
CALL InstrWrite(analyzer,":SENSE1:ESpectrum:RANGE1:BANDWIDTH:RESOLUTION  
                                     1 MHZ")  
                                     'Set the resolution bandwidth  
CALL InstrWrite(analyzer,":SENSE1:ESpectrum:RANGE1:FILTER:TYPE CFILTER")  
                                     'Set the channel filters  
CALL InstrWrite(analyzer,":SENSE1:ESpectrum:RANGE1:BANDWIDTH:VIDEO 3 MHZ")  
                                     'Set the video bandwidth to 3 MHz  
CALL InstrWrite(analyzer,":SENSE1:ESpectrum:RANGE1:SWEPTIME:TIME 20 ms")  
                                     'Set the sweep time to 20 ms  
CALL InstrWrite(analyzer,":SENSE1:ESpectrum:RANGE1:RLEVEL 5 DBM")  
                                     'Set the reference level to 5 dBm  
CALL InstrWrite(analyzer,":SENSE1:ESpectrum:RANGE1:INPUT:ATTENUATION 20 DB")  
                                     'Set the attenuation to 20 dB  
CALL InstrWrite(analyzer,":SENSE1:ESpectrum:RANGE1:LIMIT:ABSOLUTE:START  
                                     -50")  
                                     'Set an absolute limit of -50 dBm  
CALL InstrWrite(analyzer,":SENSE1:ESpectrum:RANGE1:LIMIT:ABSOLUTE:STOP -50")  
                                     'Set an absolute limit of -50 dBm  
CALL InstrWrite(analyzer,":SENSE1:ESpectrum:RANGE1:LIMIT:RELATIVE:START  
                                     -70")  
                                     'Set a relative limit of -70 dBc  
CALL InstrWrite(analyzer,":SENSE1:ESpectrum:RANGE1:LIMIT:RELATIVE:STOP -60")  
                                     'Set a relative limit of -60 dBc  
  
'----- Defining the settings of range 2 -----  
CALL InstrWrite(analyzer,":SENSE1:ESpectrum:RANGE2:FREQUENCY:START -2MHz")  
CALL InstrWrite(analyzer,":SENSE1:ESpectrum:RANGE2:FREQUENCY:STOP -1MHz")  
CALL InstrWrite(analyzer,":SENSE1:ESpectrum:RANGE2:BANDWIDTH:RESOLUTION  
                                     100 kHz")  
CALL InstrWrite(analyzer,":SENSE1:ESpectrum:RANGE2:FILTER:TYPE NORM")  
CALL InstrWrite(analyzer,":SENSE1:ESpectrum:RANGE2:BANDWIDTH:VIDEO 300 kHz")  
CALL InstrWrite(analyzer,":SENSE1:ESpectrum:RANGE2:SWEPTIME:TIME 50 ms")  
CALL InstrWrite(analyzer,":SENSE1:ESpectrum:RANGE2:RLEVEL 10 DBM")  
CALL InstrWrite(analyzer,":SENSE1:ESpectrum:RANGE2:INPUT:ATTENUATION 30 DB")  
CALL InstrWrite(analyzer,":SENSE1:ESpectrum:RANGE2:LIMIT:ABSOLUTE:START  
                                     -40")
```

```

CALL InstrWrite(analyzer,":SENSE1:ESpectrum:RANGe2:LIMit:RELative:START
                        -60")
CALL InstrWrite(analyzer,":SENSE1:ESpectrum:RANGe2:LIMit:ABSolute:STOP -40")
CALL InstrWrite(analyzer,":SENSE1:ESpectrum:RANGe2:LIMit:RELative:STOP -40")
'----- Defining the settings of range 3 -----'
CALL InstrWrite(analyzer,":SENSE1:ESpectrum:RANGe3:FREQuency:START -1MHz")
CALL InstrWrite(analyzer,":SENSE1:ESpectrum:RANGe3:FREQuency:STOP 1MHz")
CALL InstrWrite(analyzer,":SENSE1:ESpectrum:RANGe3:BANDwidth:RESolution
                        30 kHz")
CALL InstrWrite(analyzer,":SENSE1:ESpectrum:RANGe3:FILTer:TYPE NORM")
CALL InstrWrite(analyzer,":SENSE1:ESpectrum:RANGe3:BANDwidth:VIDeo 100 kHz")
CALL InstrWrite(analyzer,":SENSE1:ESpectrum:RANGe3:SWEep:TIME 5 ms")
CALL InstrWrite(analyzer,":SENSE1:ESpectrum:RANGe3:RLEVel 20 DBM")
CALL InstrWrite(analyzer,":SENSE1:ESpectrum:RANGe3:INPut:ATTenuation 30 DB")
CALL InstrWrite(analyzer,":SENSE1:ESpectrum:RANGe3:LIMit:ABSolute:START
                        200")
CALL InstrWrite(analyzer,":SENSE1:ESpectrum:RANGe3:LIMit:ABSolute:STOP 200")
CALL InstrWrite(analyzer,":SENSE1:ESpectrum:RANGe3:LIMit:RELative:START
                        200")
CALL InstrWrite(analyzer,":SENSE1:ESpectrum:RANGe3:LIMit:RELative:STOP 200")
'----- Defining the settings of range 4 -----'
CALL InstrWrite(analyzer,":SENSE1:ESpectrum:RANGe4:FREQuency:START 1MHz")
CALL InstrWrite(analyzer,":SENSE1:ESpectrum:RANGe4:FREQuency:STOP 2MHz")
CALL InstrWrite(analyzer,":SENSE1:ESpectrum:RANGe4:BANDwidth:RESolution
                        100 kHz")
CALL InstrWrite(analyzer,":SENSE1:ESpectrum:RANGe4:FILTer:TYPE NORM")
CALL InstrWrite(analyzer,":SENSE1:ESpectrum:RANGe4:BANDwidth:VIDeo 300 kHz")
CALL InstrWrite(analyzer,":SENSE1:ESpectrum:RANGe4:SWEep:TIME 50 ms")
CALL InstrWrite(analyzer,":SENSE1:ESpectrum:RANGe4:RLEVel 10 DBM")
CALL InstrWrite(analyzer,":SENSE1:ESpectrum:RANGe4:INPut:ATTenuation 30 DB")
CALL InstrWrite(analyzer,":SENSE1:ESpectrum:RANGe4:LIMit:ABSolute:START
                        -40")
CALL InstrWrite(analyzer,":SENSE1:ESpectrum:RANGe4:LIMit:ABSolute:STOP -40")
CALL InstrWrite(analyzer,":SENSE1:ESpectrum:RANGe4:LIMit:RELative:START
                        -40")
CALL InstrWrite(analyzer,":SENSE1:ESpectrum:RANGe4:LIMit:RELative:STOP -60")
'----- Defining the settings of range 5 -----'
CALL InstrWrite(analyzer,":SENSE1:ESpectrum:RANGe5:FREQuency:START 2MHz")
CALL InstrWrite(analyzer,":SENSE1:ESpectrum:RANGe5:FREQuency:STOP 4MHz")
CALL InstrWrite(analyzer,":SENSE1:ESpectrum:RANGe5:BANDwidth:RESolution
                        1 MHz")
CALL InstrWrite(analyzer,":SENSE1:ESpectrum:RANGe5:FILTer:TYPE CFILTer")
CALL InstrWrite(analyzer,":SENSE1:ESpectrum:RANGe5:BANDwidth:VIDeo 3 MHz")

```

```
CALL InstrWrite(analyzer,":SENSel:ESpectrum:RANGe5:SWEep:TIME 20 ms")
CALL InstrWrite(analyzer,":SENSel:ESpectrum:RANGe5:RLEVel 5 DBM")
CALL InstrWrite(analyzer,":SENSel:ESpectrum:RANGe5:INPut:ATTenuation 20 DB")
CALL InstrWrite(analyzer,":SENSel:ESpectrum:RANGe5:LIMit:ABSolute:START
-50")
CALL InstrWrite(analyzer,":SENSel:ESpectrum:RANGe5:LIMit:ABSolute:STOP -50")
CALL InstrWrite(analyzer,":SENSel:ESpectrum:RANGe5:LIMit:RELative:START
-60")
CALL InstrWrite(analyzer,":SENSel:ESpectrum:RANGe5:LIMit:RELative:STOP -70")
'----- Measuring -----
CALL InstrWrite(analyzer,"INIT;*WAI")      'Perform sweep, wait for sweep
                                           'end
'----- Reading out results -----
CALL InstrWrite(analyzer,":TRACel:DATA? LIST")
                                           'Query list results
CALL InstrWrite(analyzer,":CALCulate:LIMit:FAIL?")
                                           'Query result of limit check
CALL InstrRead(analyzer, result$)
REM *****
```

Spurious Emissions Measurement

In the following example, the Spurious Emissions measurement is configured by defining ranges and parameters.

```
REM *****
'----- General settings of the instrument -----
CALL InstrWrite(analyzer,"*RST")          'Reset instrument
Rem After preset 4 ranges are available. Range settings can be questioned
Rem independent from the set measurement mode.
'----- Deleting all ranges -----
Rem Delete all ranges to prepare for setting up a new measurement
CALL InstrWrite(analyzer,"SENSel:LIST:RANGe4:DELeTe")
                                           'Delete range 4
CALL InstrWrite(analyzer,"SENSel:LIST:RANGe3:DELeTe")
CALL InstrWrite(analyzer,"SENSel:LIST:RANGe2:DELeTe")
CALL InstrWrite(analyzer,"SENSel:LIST:RANGe1:DELeTe")
'----- Defining the start frequency for all ranges -----
CALL InstrWrite(analyzer,"SENSel:LIST:RANGe1:FREQuency:START 1000000")
Rem Setting the start frequency of range 1 will create the ranges and
Rem every other range value will be set to the default value.
CALL InstrWrite(analyzer,"SENSel:LIST:RANGe2:FREQuency:START 2000000")
CALL InstrWrite(analyzer,"SENSel:LIST:RANGe3:FREQuency:START 3000000")
```

```
CALL InstrWrite(analyzer,"SENSE1:LIST:RANGE4:FREQUENCY:START 4000000")
CALL InstrWrite(analyzer,"SENSE1:LIST:RANGE5:FREQUENCY:START 5000000")
CALL InstrWrite(analyzer,"SENSE1:LIST:RANGE:COUNT?")
                                'Queries the number of defined
                                'ranges
```

'----- Querying the parameters of range 1 -----'

```
CALL InstrWrite(analyzer,"SENSE1:LIST:RANGE1:FREQUENCY:START?")
CALL InstrWrite(analyzer,"SENSE1:LIST:RANGE1:FREQUENCY:STOP?")
CALL InstrWrite(analyzer,"SENSE1:LIST:RANGE1:FILTER:TYPE?")
CALL InstrWrite(analyzer,"SENSE1:LIST:RANGE1:BANDWIDTH:RESOLUTION?")
CALL InstrWrite(analyzer,"SENSE1:LIST:RANGE1:BANDWIDTH:VIDEO?")
CALL InstrWrite(analyzer,"SENSE1:LIST:RANGE1:SWEEP:TIME:AUTO?")
CALL InstrWrite(analyzer,"SENSE1:LIST:RANGE1:DETECTOR?")
CALL InstrWrite(analyzer,"SENSE1:LIST:RANGE1:RLEVEL?")
CALL InstrWrite(analyzer,"SENSE1:LIST:RANGE1:INPUT:ATTENUATION:AUTO?")
CALL InstrWrite(analyzer,"SENSE1:LIST:RANGE1:INPUT:GAIN:STATE?")
CALL InstrWrite(analyzer,"SENSE1:LIST:RANGE1:BREAK?")
CALL InstrWrite(analyzer,"SENSE1:LIST:RANGE1:TRANSDUCER?")
CALL InstrWrite(analyzer,"SENSE1:LIST:RANGE1:SWEEP:TIME?")
CALL InstrWrite(analyzer,"SENSE1:LIST:RANGE1:INPUT:ATTENUATION?")
CALL InstrWrite(analyzer,"SENSE1:LIST:RANGE1:POINTS?")
CALL InstrWrite(analyzer,"SENSE1:LIST:RANGE1:LIMIT:START?")
CALL InstrWrite(analyzer,"SENSE1:LIST:RANGE1:LIMIT:STOP?")
CALL InstrWrite(analyzer,"SENSE1:LIST:RANGE1:LIMIT:STATE?")
```

'----- Changing into the Spurious Emissions measurement mode -----'

```
CALL InstrWrite(analyzer,":SENSE1:SWEEP:MODE LIST")
Rem In continuous sweep mode, editing the ranges is not allowed.
Rem You have to stop the measurement first.
Rem In single sweep mode, you can edit the ranges at the end of the sweep.
```

'----- Single sweep version -----'

```
CALL InstrWrite(analyzer,"INIT:CONT OFF") 'Switch to single sweep
CALL InstrWrite(analyzer,"SENSE1:LIST:RANGE1:FREQUENCY:START 500000")
                                'Change the start frequency
CALL InstrWrite(analyzer,"INIT;*WAI") 'Perform sweep, wait for sweep
                                'end
```

'----- Continuous sweep version -----'

```
CALL InstrWrite(analyzer,"INIT:CONT ON") 'Switch to continuous sweep
CALL InstrWrite(analyzer,"ABORT") 'Stop the measurement
CALL InstrWrite(analyzer,"SENSE1:LIST:RANGE1:FREQUENCY:START 500000")
                                'Change the start frequency
CALL InstrWrite(analyzer,":INITiate1:SPURious") 'Restart the measurement
```

```
'----- Defining the range settings in single sweep mode -----'
CALL InstrWrite(analyzer,"INIT:CONT OFF") 'Switch to single sweep
CALL InstrWrite(analyzer,"INIT;*WAI")      'Perform sweep, wait for sweep
                                           'end

Rem Edit one range at a time. Make sure to edit the ranges in a correct
Rem order to prevent limit violations. Ranges cannot overlap.
Rem The best way is to start with range 1.
CALL InstrWrite(analyzer,"SENSE1:LIST:RANGE1:FREQUENCY:START 500000")
CALL InstrWrite(analyzer,"SENSE1:LIST:RANGE1:FREQUENCY:STOP 550000")
CALL InstrWrite(analyzer,"SENSE1:LIST:RANGE1:FILTER:TYPE NORM")
CALL InstrWrite(analyzer,"SENSE1:LIST:RANGE1:BANDWIDTH:RESOLUTION 3000000")
CALL InstrWrite(analyzer,"SENSE1:LIST:RANGE1:BANDWIDTH:VIDEO 10000000")
CALL InstrWrite(analyzer,"SENSE1:LIST:RANGE1:SWEPTIME:AUTO ON")
CALL InstrWrite(analyzer,"SENSE1:LIST:RANGE1:DETECTOR RMS")
CALL InstrWrite(analyzer,"SENSE1:LIST:RANGE1:RLEVEL -10")
CALL InstrWrite(analyzer,"SENSE1:LIST:RANGE1:INPUT:ATTENUATION:AUTO ON")
CALL InstrWrite(analyzer,"SENSE1:LIST:RANGE1:POINTS 8001")
CALL InstrWrite(analyzer,"SENSE1:LIST:RANGE1:INPUT:GAIN:STATE OFF")
CALL InstrWrite(analyzer,"SENSE1:LIST:RANGE1:BREAK OFF")
CALL InstrWrite(analyzer,"SENSE1:LIST:RANGE1:LIMIT:START -20")
CALL InstrWrite(analyzer,"SENSE1:LIST:RANGE1:LIMIT:STOP -20")
CALL InstrWrite(analyzer,"SENSE1:LIST:RANGE1:LIMIT:STATE ON")
Rem Proceed with range 2.
CALL InstrWrite(analyzer,"SENSE1:LIST:RANGE2:FREQUENCY:START 1000000")
CALL InstrWrite(analyzer,"SENSE1:LIST:RANGE2:FREQUENCY:STOP 200000000")
CALL InstrWrite(analyzer,"SENSE1:LIST:RANGE2:FILTER:TYPE CFILTER")
CALL InstrWrite(analyzer,"SENSE1:LIST:RANGE2:BANDWIDTH:RESOLUTION 5000000")
CALL InstrWrite(analyzer,"SENSE1:LIST:RANGE2:DETECTOR POS")
CALL InstrWrite(analyzer,"SENSE1:LIST:RANGE2:RLEVEL -20")
CALL InstrWrite(analyzer,"SENSE1:LIST:RANGE2:INPUT:ATTENUATION 0")
CALL InstrWrite(analyzer,"SENSE1:LIST:RANGE2:POINTS 32001")
CALL InstrWrite(analyzer,"SENSE1:LIST:RANGE2:INPUT:GAIN:STATE ON")
Rem Proceed with range 3.
CALL InstrWrite(analyzer,"SENSE1:LIST:RANGE3:FREQUENCY:START 250000000")
CALL InstrWrite(analyzer,"SENSE1:LIST:RANGE3:FREQUENCY:STOP 1000000000")
CALL InstrWrite(analyzer,"SENSE1:LIST:RANGE3:FILTER:TYPE RRC")
CALL InstrWrite(analyzer,"SENSE1:LIST:RANGE3:POINTS 32001")
Rem Proceed with range 4.
CALL InstrWrite(analyzer,"SENSE1:LIST:RANGE4:FREQUENCY:START 1200000000")
CALL InstrWrite(analyzer,"SENSE1:LIST:RANGE4:FREQUENCY:STOP 4000000000")
CALL InstrWrite(analyzer,"SENSE1:LIST:RANGE4:FILTER:TYPE PULSE")
```

```

CALL InstrWrite(analyzer,"SENSE1:LIST:RANGE4:POINTS 251")
Rem Proceed with range 5.
CALL InstrWrite(analyzer,"SENSE1:LIST:RANGE5:FREQUENCY:START 5000000000")
CALL InstrWrite(analyzer,"SENSE1:LIST:RANGE5:FREQUENCY:STOP 6000000000")
CALL InstrWrite(analyzer,"SENSE1:LIST:RANGE5:POINTS 7001")
'----- Defining the limit check for all ranges -----
CALL InstrWrite(analyzer,"SENSE1:LIST:RANGE1:LIMIT:STATE ON")
                                'Activate the limit check
'----- Setting the span to include all ranges -----
CALL InstrWrite(analyzer,":SENSE1:FREQUENCY:START 500000")
CALL InstrWrite(analyzer,":SENSE1:FREQUENCY:STOP 6000000000")
'----- Measuring -----
CALL InstrWrite(analyzer,"INIT;*WAI")      'Perform sweep, wait for sweep
                                'end
'----- Reading out results -----
CALL InstrWrite(analyzer,":TRAC1:DATA? LIST")
                                'Query list results
CALL InstrWrite(analyzer,":CALCULATE1:PSEARCH[:IMMEDIATE]")
                                'Deactivate limit line and
                                'just look for peaks

Rem Or set margin to 200 in order to find all peaks
CALL InstrWrite(analyzer,":TRAC1:DATA? SPUR")
                                'Query just the peaks
CALL InstrWrite(analyzer,":CALCULATE:LIMIT:FAIL?")
                                'Query result of limit check

CALL InstrRead(analyzer, result$)
REM *****

```

WLAN TX Measurements - Programming Examples (Option K91 / K91n)

The following section provides some examples of commonly performed operations when using the WLAN TX Measurements option (K91 / K91n). For more general remote control examples refer to the programming examples in this chapter.

This option is available from firmware version 1.20. The option R&S FSL-K91n is available from firmware version 1.90.

Synchronization Entry of Option

The following example shows how to synchronize entering the WLAN TX Measurements option.

```
analyzer = 20                                'Instrument address
CALL InstrWrite(analyzer, "INST:SEL WLAN;*OPC?")
                                                'waits for 1 from *OPC?
```

Selecting Measurements

Measurements are selected using the command `CONFigure:BURSt:<Meas Type>` where `<Meas Type>` is as follows:

<Meas Type>	Measurement Type
PVT	Power vs Time (PVT)
PVT:SElect EDGE	PVT rising and falling edge
PVT:SElect FULL	PVT full burst (802.11a only)
PVT:SElect RISE	PVT rising burst (802.11b only)
PVT:SElect FALL	PVT falling burst (802.11b only)
EVM:ECARrier	EVM vs Carrier
EVM:ESYMBOL	EVM vs Symbol
SPECTrum:MASK	Spectrum Mask
SPECTrum:MASK:SElect IEEE	Spectrum Mask IEEE
SPECTrum:MASK:SElect ETSI	Spectrum Mask ETSI
SPECTrum:FLATness	Spectrum Flatness
SPECTrum:FFT	Spectrum FFT
SPECTrum:ACPR	Spectrum ACPR
CONStellation:CCARrier	Constellation vs Carrier

R&S FSL WLAN TX Measurements - Programming Examples (Option K91 / K91n)

<Meas Type>	Measurement Type
CONstellation:CSYMBOL	Constellation vs Symbol
STATistics:CCDF	CCDF
STATistics:BSTReam	Bit Steam
STATistics:SField	Signal Field

The following example shows how to select a Spectrum Mask ETSI measurement:

```
REM select Spectrum Mask Select ETSI
CALL InstrWrite(analyzer, "SPECTrum:MASK:SElect:ETSI")
```

Running Synchronized Measurements

The following examples show how measurements can be synchronized. Synchronization is necessary to ensure that the measurement has completed before the measurement results and markers are requested.

PUBLIC SUB SweepSync()

```
REM The command INITiate[:IMMEDIATE] starts a single sweep if the
REM command INIT:CONT OFF was previously sent. It should be ensured that
REM the next command is only then executed when the entire sweep is
REM complete.
CALL InstrWrite(analyzer, "INIT:CONT OFF")
REM ----- First possibility: Use of *WAI -----
CALL InstrWrite(analyzer, "INIT:IMM;*WAI")
REM ----- Second possibility: Use of *OPC? -----
OpcOk$ = SPACE$(2) 'Space for *OPC?           'Provide response
CALL InstrWrite(analyzer, "INIT:IMM;*OPC?")
REM ----- Here the controller can service other instrument-----
CALL InstrRead(analyzer, OpcOk$)           'Wait for "1" from *OPC?
REM ----- Third possibility: Use of *OPC -----
REM In order to be able to use the service request function in
REM conjugation with a National Instruments GPIB driver, the setting
REM "Disable Auto Serial Poll" must be changed to "yes" by means of
REM the GPIB configuration
REM (e.g. Windows Start menu: Settings -> Control Panel -> GPIB)!
CALL InstrWrite(analyzer, "*SRE 32")       'Permit service request for ESR
CALL InstrWrite(analyzer, "*ESE 1")       'Set event-enable bit for
                                           'operation-complete bit
CALL InstrWrite(analyzer, "INIT:IMM;*OPC") 'Start sweep and
                                           'synchronize with OPC
```

WLAN TX Measurements - Programming Examples (Option K91 / K91n) R&S FSL

```
status = viWaitOnEvent(vi, VI_EVENT_SERVICE_REQ, SRQWaitTimeout, VI_NULL,  
VI_NULL)                                'Wait for service request
```

```
REM ----- Fourth possibility: Use of INIT:IMM -----
```

```
REM In order to be able to use the service request function in  
REM conjugation with a National Instruments GPIB driver, the setting  
REM "Disable Auto Serial Poll" must be changed to "yes" by means of  
REM the GPIB configuration  
REM (e.g. Windows Start menu: Settings -> Control Panel -> GPIB)!  
CALL InstrWrite(analyzer, "*SRE 128")      'Permit service request for ESR  
CALL InstrWrite(analyzer, "*ESE 0")        'Set event-enable bit for  
                                           'operation-complete bit  
CALL InstrWrite(analyzer, "STATus:OPERation:ENABLE 16")  
                                           'Enable bit 4 of status operation  
                                           'register'  
CALL InstrWrite(analyzer, "STAT:OPERation:NTRansition 16")  
                                           'Set Negative transition to 1  
CALL InstrWrite(analyzer, "STATus:OPERation:PTRansition 0")  
                                           'Set Positive transition to 0  
CALL InstrWrite(analyzer, "INIT:IMM")      'Start sweep and synchronize with  
                                           'OPC  
status = viWaitOnEvent(vi, VI_EVENT_SERVICE_REQ, SRQWaitTimeout, VI_NULL,  
VI_NULL)                                'Wait for service request  
REM Continue main program here.
```

```
END SUB
```

```
REM *****
```

WiMAX, WiBro Measurements - Programming Examples (Options K92/93)

The following section provides some examples of commonly performed operations when using the WiMAX IEEE 802.16 OFDM, OFDMA Measurements option (R&S FSL-K93). For more general remote control examples refer to the other programming examples in this chapter.

The WiMAX IEEE 802.16 OFDM, OFDMA Measurements option (R&S FSL-K93) includes the functionality of the WiMAX 802.16 OFDM Measurements option (R&S FSL-K92). Accordingly both options are described together in this section. The options are available from firmware version 1.40 (R&S FSL-K92) and 1.50 (R&S FSL-K93).

Synchronization Entry of Option

The following example shows how to synchronize entering the WiMAX IEEE 802.16 OFDM, OFDMA Measurements option.

```
analyzer = 20                                'Instrument address
CALL InstrWrite(analyzer, "INST:SEL WLAN;*OPC?")
                                                'waits for 1 from *OPC?
```

Selecting Measurements

Measurements are selected using the command `CONFigure:BURSt:<Meas Type>` where `<Meas Type>` is as follows:

<Meas Type>	Measurement Type
PVT	Power vs Time (PVT)
PVT:SElect EDGE	PVT Start and End (OFDM) PVT Rring / Falling (OFDMA & WiBro)
PVT:SElect FULL	PVT Full Burst (OFDM) PVT Full Subframe (OFDMA & WiBro)
EVM:ECARrier	EVM vs Carrier
EVM:ESYMBOL	EVM vs Symbol
SPECTrum:MASK	Spectrum Mask
SPECTrum:MASK:SElect IEEE	Spectrum Mask IEEE
SPECTrum:MASK:SElect ETSI	Spectrum Mask ETSI
SPECTrum:FLATness	Spectrum Flatness
SPECTrum:FLATness:SElect FLATNESS	Spectrum Flatness
SPECTrum:FLATness:SElect GRDELAY	Spectrum Flatness - Group Delay
SPECTrum:FLATness:SElect DIFFERENCE	Spectrum Flatness - Difference

<Meas Type>	Measurement Type
SPECTrum:FFT	Spectrum FFT
SPECTrum:ACPR	Spectrum ACPR
SPECTrum:ACPR:SElect ABS	Spectrum ACPR (Absolute)
SPECTrum:ACPR:SElect REL	Spectrum ACPR (Relative)
CONSt:CCARrier	Constellation vs Carrier
CONSt:CSYMBOL	Constellation vs Symbol
STATistics:CCDF	CCDF
STATistics:BSTReam	Bit Steam
STATistics:BSUMmary	Burst Summary
PREamble	Preamble Error
PREamble:SElect FREQ	Frequency Error vs Preamble
PREamble:SElect PHASE	Phase Error vs Preamble

The following example shows how to select a Spectrum Mask ETSI measurement:

```
REM select Spectrum Mask Select ETSI
CALL InstrWrite(analyzer, "SPECTrum:MASK:SElect:ETSI")
```

Running Synchronized Measurements

The following examples show how measurements can be synchronized. Synchronization is necessary to ensure that the measurement has completed before the measurement results and markers are requested.

PUBLIC SUB SweepSync ()

```
REM The command INITiate[:IMMEDIATE] starts a single sweep if the
REM command INIT:CONT OFF was previously sent. It should be ensured that
REM the next command is only then executed when the entire sweep is
REM complete.
```

```
CALL InstrWrite(analyzer, "INIT:CONT OFF")
```

REM ----- First possibility: Use of *WAI -----

```
CALL InstrWrite(analyzer, "INIT:IMM;*WAI")
```

REM ----- Second possibility: Use of *OPC? -----

```
OpcOk$ = SPACE$(2) 'Space for *OPC?          'Provide response
CALL InstrWrite(analyzer, "INIT:IMM;*OPC?")
```

R&S FSLWiMAX, WiBro Measurements - Programming Examples (K92/93)

```
REM ----- Here the controller can service other instrument-----
CALL InstrRead(analyzer, OpcOk$)          'Wait for "1" from *OPC?

REM ----- Third possibility: Use of *OPC -----
REM In order to be able to use the service request function in
REM conjugation with a National Instruments GPIB driver, the setting
REM "Disable Auto Serial Poll" must be changed to "yes" by means of
REM the GPIB configuration
REM (e.g. Windows Start menu: Settings -> Control Panel -> GPIB)!
CALL InstrWrite(analyzer, "*SRE 32")      'Permit service request for ESR
CALL InstrWrite(analyzer, "*ESE 1")      'Set event-enable bit for
                                          'operation-complete bit
CALL InstrWrite(analyzer, "INIT:IMM;*OPC") 'Start sweep and
                                          'synchronize with OPC
status = viWaitOnEvent(vi, VI_EVENT_SERVICE_REQ, SRQWaitTimeout, VI_NULL,
VI_NULL)                                'Wait for service request

REM ----- Fourth possibility: Use of INIT:IMM -----
REM In order to be able to use the service request function in
REM conjugation with a National Instruments GPIB driver, the setting
REM "Disable Auto Serial Poll" must be changed to "yes" by means of
REM the GPIB configuration
REM (e.g. Windows Start menu: Settings -> Control Panel -> GPIB)!
CALL InstrWrite(analyzer, "*SRE 128")    'Permit service request for ESR
CALL InstrWrite(analyzer, "*ESE 0")      'Set event-enable bit for
                                          'operation-complete bit
CALL InstrWrite(analyzer, "STATus:OPERation:ENABLE 16")
                                          'Enable bit 4 of status operation
                                          'register'
CALL InstrWrite(analyzer, "STAT:OPERation:NTRansition 16")
                                          'Set Negative transition to 1
CALL InstrWrite(analyzer, "STATus:OPERation:PTRansition 0")
                                          'Set Positive transition to 0
CALL InstrWrite(analyzer, "INIT:IMM")    'Start sweep and synchronize with
                                          'OPC
status = viWaitOnEvent(vi, VI_EVENT_SERVICE_REQ, SRQWaitTimeout, VI_NULL,
VI_NULL)                                'Wait for service request
REM Continue main program here.

END SUB

REM *****
```

Contents of Chapter 8

- 8 Maintenance 8.1
 - Storing and Packing 8.1
 - List of Power Cables Available 8.1

8 Maintenance

The following chapter contains information on the maintenance of the R&S FSL. The instrument does not need a periodic maintenance. What is necessary is essentially the cleaning of the instrument. However, it is recommended to check the rated data from time to time.

Follow the instructions in the service manual and the safety instructions when exchanging modules or ordering spares. The order no. for spare parts is included in the service manual. The service manual includes further information particularly on troubleshooting, repair, exchange of modules (including battery exchange, adjustment of the OCXO oscillator) and alignment.

The address of our support center and a list of all Rohde & Schwarz service centers can be found at the beginning of this manual.

Storing and Packing

The storage temperature range of the instrument is given in the data sheet. If the instrument is to be stored for a longer period of time, it must be protected against dust.

Repack the instrument as it was originally packed when transporting or shipping. The two protective foam plastic parts prevent the control elements and connectors from being damaged. The antistatic packing foil avoids any undesired electrostatic charging to occur.

If you do not use the original packaging, provide for sufficient padding to prevent the instrument from slipping inside the package. Wrap antistatic packing foil around the instrument to protect it from electrostatic charging.

List of Power Cables Available

Table 8-1 List of power cables available

Stock No.	Earthed-contact connector	Preferably used in
DS 006.7013.00	BS1363: 1967' complying with IEC 83: 1975 standard B2	Great Britain
DS 006.7020.00	Type 12 complying with SEV-regulation 1011.1059, standard sheet S 24 507	Switzerland
DS 006.7036.00	Type 498/13 complying with US-regulation UL 498, or with IEC 83	USA/Canada
DS 006.7107.00	Type SAA3 10 A, 250 V, complying with AS C112-1964 Ap.	Australia
DS 0025.2365.00 DS 0099.1456.00	DIN 49 441, 10 A, 250 V, angular DIN 49 441, 10 A, 250 V, straight	Europe (except Switzerland)

Contents of Chapter 9

9 Error Messages	9.1
SCPI-Specific Error Messages	9.1
Device-Specific Messages	9.7
Noise Figure Measurements Option Messages (K30)	9.8
3GPP Base Station Measurements Option Messages (K72)	9.9
WLAN TX Measurements Option Messages (K91 / K91n)	9.10
WiMAX IEEE 802.16 OFDM, OFDMA Measurements Option Messages (K92/K93)	9.11

9 Error Messages

Error messages are entered in the error/event queue of the status reporting system in the remote control mode and can be queried with the command `SYSTem:ERRor?`. The answer format of R&S FSL to the command is as follows:

```
<error code>, "<error text with queue query>;
<remote control command concerned>"
```

The indication of the remote control command with prefixed semicolon is optional.

Example:

The command `"TEST:COMMAND"` generates the following answer to the query `SYSTem:ERRor?`

```
-113,"Undefined header;TEST:COMMAND"
```

The subsequent lists contain the description of error texts displayed on the instrument.

Distinction is made between error messages defined by SCPI, which are marked by negative error codes, and the device-specific error messages for which positive error codes are used:

- [SCPI-Specific Error Messages](#)
- [Device-Specific Messages](#)

The right-hand column in the following tables contains the error text in bold which is entered in the error/event queue and can be read out by means of query `SYSTem:ERRor?`. A short explanation of the error cause is given below. The left-hand column contains the associated error code.

Additionally, option-specific warnings and error messages displayed in the status bar are explained.

SCPI-Specific Error Messages

Table 9-1 No Error

Error code	Error text in the case of queue poll Error explanation
0	No error This message is displayed if the error queue does not contain any entries.

Table 9-2 Command Error - Faulty command; sets bit 5 in the ESR register.

Error code	Error text in the case of queue poll Error explanation
-100	Command Error The command is faulty or invalid.
-101	Invalid Character The command contains an invalid sign. Example: A header contains an ampersand, " SENSe& ".

Error code	Error text in the case of queue poll Error explanation
-102	<p>Syntax error The command is invalid. Example: The command contains block data the instrument does not accept.</p>
-103	<p>Invalid separator The command contains an invalid sign instead of a separator. Example: A semicolon is missing after the command.</p>
-104	<p>Data type error The command contains an invalid value indication. Example: ON is indicated instead of a numeric value for frequency setting.</p>
-105	<p>GET not allowed A Group Execute Trigger (GET) is within a command line.</p>
-108	<p>Parameter not allowed The command contains too many parameters. Example: Command SENSe:FREQuency:CENTer permits only one frequency indication.</p>
-109	<p>Missing parameter The command contains too few parameters. Example: The command SENSe:FREQuency:CENTer requires a frequency indication.</p>
-110	<p>Command header error The header of the command is faulty.</p>
-111	<p>Header separator error The header contains an invalid separator. Example: the header is not followed by a "White Space", "*ESE255"</p>
-112	<p>Program mnemonic too long The header contains more than 12 characters.</p>
-113	<p>Undefined header The header is not defined for the instrument. Example: *XYZ is undefined for every instrument.</p>
-114	<p>Header suffix out of range The header contains an invalid numeric suffix. Example: SENSe3 does not exist in the instrument.</p>
-120	<p>Numeric data error The command contains a faulty numeric parameter.</p>
-121	<p>Invalid character in number A number contains an invalid character. Example: An "A" in a decimal number or a "9" in an octal number.</p>
-123	<p>Exponent too large The absolute value of the exponent is greater than 32000.</p>
-124	<p>Too many digits The number includes too many digits.</p>
-128	<p>Numeric data not allowed The command includes a number which is not allowed at this position. Example: The command INPut:COUPLing requires indication of a text parameter.</p>
-130	<p>Suffix error The command contains a faulty suffix.</p>

Error code	Error text in the case of queue poll Error explanation
-131	Invalid suffix The suffix is invalid for this instrument. Example: nHz is not defined.
-134	Suffix too long The suffix contains more than 12 characters.
-138	Suffix not allowed A suffix is not allowed for this command or at this position of the command. Example: The command *RCL does not permit a suffix to be indicated.
-140	Character data error The command contains a faulty text parameter
-141	Invalid character data The text parameter either contains an invalid character or it is invalid for this command. Example: Write error with parameter indication;INPut:COUPling XC.
-144	Character data too long The text parameter contains more than 12 characters.
-148	Character data not allowed The text parameter is not allowed for this command or at this position of the command. Example: The command *RCL requires a number to be indicated.
-150	String data error The command contains a faulty string.
-151	Invalid string data The command contains a faulty string. Example: An END message has been received prior to the terminating apostrophe.
-158	String data not allowed The command contains an allowed string at an invalid position. Example: A text parameter is set in quotation marks, INPut:COUPling "DC"
-160	Block data error The command contains faulty block data.
-161	Invalid block data The command contains faulty block data. Example: An END message was received prior to reception of the expected number of data.
-168	Block data not allowed The command contains allowed block data at an invalid position. Example: The command *RCL requires a number to be indicated.
-170	Expression error The command contains an invalid mathematical expression.
-171	Invalid expression The command contains an invalid mathematical expression. Example: The expression contains mismatching parentheses.
-178	Expression data not allowed The command contains a mathematical expression at an invalid position.

Table 9-3 Execution Error - Error on execution of a command; sets bit 4 in the ESR register

Error code	Error text in the case of queue poll Error explanation
-200	Execution error Error on execution of the command.
-201	Invalid while in local The command is not executable while the device is in local due to a hard local control. Example: The device receives a command which would change the rotary knob state, but the device is in local so the command can not be executed.
-202	Settings lost due to rtl A setting associated with hard local control was lost when the device changed to LOCS from REMS or to LWLS from RWLS.
-210	Trigger error Error on triggering the device.
-211	Trigger ignored The trigger (GET, *TRG or trigger signal) was ignored because of device timing considerations. Example: The device was not ready to respond.
-212	Arm ignored An arming signal was ignored by the device.
-213	Init ignored Measurement initialization was ignored as another measurement was already in progress.
-214	Trigger deadlock The trigger source for the initiation of measurement is set to GET and subsequent measurement is received. The measurement cannot be started until a GET is received, but the GET would cause an interrupted-error)
-215	Arm deadlock The trigger source for the initiation of measurement is set to GET and subsequent measurement is received. The measurement cannot be started until a GET is received, but the GET would cause an interrupted-error.
-220	Parameter error The command contains a faulty or invalid parameter.
-221	Settings conflict There is a conflict between setting of parameter value and instrument state.
-222	Data out of range The parameter value lies out of the allowed range of the instrument.
-223	Too much data The command contains too many data. Example: The instrument does not have sufficient storage space.
-224	Illegal parameter value The parameter value is invalid. Example: The text parameter is invalid , TRIGger : SWEEp : SOURce TASTe
-230	Data corrupt or stale The data are incomplete or invalid. Example: The instrument has aborted a measurement.
-231	Data questionable The measurement accuracy is suspect.

Error code	Error text in the case of queue poll Error explanation
-240	Hardware error The command cannot be executed due to problems with the instrument hardware.
-241	Hardware missing Hardware is missing. Example: An option is not fitted.
-250	Mass storage error A mass storage error occurred.
-251	Missing mass storage The mass storage is missing. Example: An option is not installed.
-252	Missing media The media is missing. Example: There is no floppy in the floppy disk drive.
-253	Corrupt media The media is corrupt. Example: The floppy is bad or has the wrong format.
-254	Media full The media is full. Example: There is no room on the floppy.
-255	Directory full The media directory is full.
-256	File name not found The file name cannot be found on the media.
-257	File name error The file name is wrong. Example: An attempt is made to copy to a duplicate file name.
-258	Media protected The media is protected. Example: The write-protect tab on the floppy is present.
-260	Expression error The expression contains an error.

Table 9-4 Device Specific Error; sets bit 3 in the ESR register

Error code	Error text in the case of queue poll Error explanation
-300	Device-specific error R&S FSL-specific error not defined in greater detail.
-310	System error This error message suggests an error within the instrument. Please inform the R&S Service.
-313	Calibration memory lost Loss of the non-volatile data stored using the *CAL? command. This error occurs when the correction data recording has failed.

Error code	Error test in the case of queue poll Error explanation
-330	Self-test failed The self test could not be executed.
-350	Queue overflow This error code is entered in the queue instead of the actual error code if the queue is full. It indicates that an error has occurred but not been accepted. The queue can accept 5 entries.

Table 9-5 Query Error - Error in data request; sets bit 2 in the ESR register

Error code	Error text in the case of queue poll Error explanation
-400	Query error General error occurring when data are requested by a query.
-410	Query INTERRUPTED The query has been interrupted. Example: After a query, the instrument receives new data before the response has been sent completely.
-420	Query UNTERMINATED The query is incomplete. Example: The instrument is addressed as a talker and receives incomplete data.
-430	Query DEADLOCKED The query cannot be processed. Example: The input and output buffers are full, the instrument cannot continue operation.
-440	Query UNTERMINATED after indefinite response A query is in the same command line after a query which requests an indefinite response.

Device-Specific Messages

Error code	Error text in the case of queue poll Error explanation
1052	Frontend LO is Unlocked This message is displayed when the phase regulation of the local oscillator fails in the RF front-end.
1060	Trigger-Block Gate Delay Error- gate length < Gate Delay This message is displayed when the gate signal length is not sufficient for the pull-in delay with a predefined gate delay.
1064	Tracking LO is Unlocked This message is displayed when the phase regulation of the local oscillator fails on the tracking generator module.
2028	Hardcopy not possible during measurement sequence This message is displayed when a printout is started during scan sequences that cannot be interrupted. Such sequences are for example: <ul style="list-style-type: none"> • Recording the system error correction data (alignment) • Instrument self test In such cases synchronization to the end of the scan sequence should be performed prior to starting the printout.
2033	Printer Not Available This message is displayed when the selected printer is not included in the list of available output devices. A possible cause is that the required printer driver is missing or incorrectly installed.
2034	CPU Temperature is too high This message is displayed when the temperature of the processor exceeds 70 °C.

Noise Figure Measurements Option Messages (K30)

The list of possible warning & error messages for the Noise Figure Measurements option (K30) is shown below.

This option is available from firmware version 1.50.

Status bar message	Description
Frequency list truncated, max 100 entries	The settings for start, stop and step frequencies would require a frequency list greater than 100 entries. The list calculated is terminated at the 100th entry. Try using a larger step size of splitting the test up into a series of frequency list tests.
Missing [ENR][,]&[LossIn][,]&[LossOut] for meas.freq.	No ENR, loss input and/or loss output can be determined for one or all of the measurement frequencies. This occurs when using tables of ENR, loss input and/or loss output values. Check that the frequency ranges of the tables covers the range of frequencies to be measured. For each measurement frequency, where ENR, loss input or loss output cannot be determined, 0 is used.

3GPP Base Station Measurements Option Messages (K72)

The list of possible warning & error messages is shown below.

This option is available from firmware version 1.50.

Status bar message	Description
Sync not found	<p>This message is displayed if synchronization is not possible.</p> <p>Possible causes are that frequency, level, scrambling code, Invert Q values are set incorrectly, or the input signal is invalid.</p>
Sync OK	<p>This message is displayed if synchronization is possible.</p>
Incorrect pilot symbols	<p>This message is displayed if one or more of the received pilot symbols are not equal to the specified pilot symbols of the 3GPP standard. Possible causes are:</p> <ul style="list-style-type: none"> Incorrectly sent pilot symbols in the received frame. Low signal to noise ratio (SNR) of the WCDMA signal. One or more code channels have a significantly lower power level compared to the total power. The incorrect pilots are detected in these channels because of low channel SNR. One or more channels are sent with high power ramping. In slots with low relative power to total power, the pilot symbols might be detected incorrectly (check the signal quality by using the symbol constellation display).

WLAN TX Measurements Option Messages (K91 / K91n)

The list of possible warning & error messages is shown below.

This option is available from firmware version 1.20. The option R&S FSL-K91n is available from firmware version 1.90.

Status bar message	Description
Gate length too small - must be greater than 1	This message is only displayed for the FFT measurement. This message indicates that there are no samples contained within the gating lines. Increase the Gate length and then, in the sweep menu, press the Refresh softkey to remove this error.
No valid analyzed bursts within gating lines	This message is only displayed for the PVT measurement. This message indicates that there are no complete & valid bursts contained within the gating lines. Increase the Gate length and then, in the sweep menu, press the Refresh softkey to remove this error.
No bursts found	<p>This message is displayed if no valid burst was detected in the input data. To correct this problem check the following:</p> <p>The connections between the DUT and analyzer are correct.</p> <p>The input signal is of a sufficient level.</p> <p>The capture time is long enough to capture at least one complete burst. If running with a Free Run trigger then the capture time must be greater than the burst length (ideally at least twice the burst length) to ensure that a complete burst is recorded.</p> <p>Check that the demod settings are correct.</p>
No bursts of desired type to analyze	This message is displayed if bursts are found, but none of desired type to analyse. Check that the setting for Burst Type is correct.
No signal found	This message is displayed when an automatic level detection measurement is executed and the measured signal level is lower the permitted minimum value.
No power trigger for Spectrum Mask ETSI	This message is displayed when the Spectrum Mask ETSI measurement is selected whilst the trigger is set to power. No action is required as the trigger is automatically set to Free Run in this case.
Signal overload detected	This message is displayed when the OVLN enhancement label is displayed and indicates that the input mixer is overloaded. If this message is displayed then try increasing the setting for the Signal Level parameter (or settings Auto Level). If this does not clear the problem then an external attenuation may need to be applied.

WiMAX IEEE 802.16 OFDM, OFDMA Measurements Option Messages (K92/K93)

The list of possible warning & error messages for the WiMAX IEEE 802.16 OFDM, OFDMA Measurements option (R&S FSL-K92/K93) is shown below.

The WiMAX IEEE 802.16 OFDM, OFDMA Measurements option (R&S FSL-K92/K93) includes the functionality of the WiMAX 802.16 OFDM Measurements option (R&S FSL-K92). Accordingly both options are described together in this section. The options are available from firmware version 1.40 (R&S FSL-K92) and 1.50 (R&S FSL-K93).

Status bar message	Description
Gate length too small - must be greater than 1	This message is only displayed for the FFT measurement. This message indicates that there are no samples contained within the gating lines. Increase the Gate length and then, in the sweep menu, press the Refresh softkey to remove this error.
No valid analyzed bursts within gating lines	This message is only displayed for the PVT measurement. This message indicates that there are no complete & valid bursts contained within the gating lines. Increase the Gate length and then, in the sweep menu, press the Refresh softkey to remove this error.
No bursts found	This message is displayed if no valid burst was detected in the input data. To correct this problem check the following: The connections between the DUT and analyzer are correct. The input signal is of a sufficient level. The capture time is long enough to capture at least one complete burst. If running with a Free Run trigger then the capture time must be greater than the burst length (ideally at least twice the burst length) to ensure that a complete burst is recorded. Check that the demodulation settings are correct.
No bursts of desired type to analyze	This message is displayed if bursts are found, but none of desired type to analyze. Check that the setting for Burst Type is correct.
No signal found	This message is displayed when an automatic level detection measurement is executed and the measured signal level is lower the permitted minimum value.
Signal overload detected	This message is displayed when the OVLD enhancement label is displayed and indicates that the input mixer is overloaded. If this message is displayed then try increasing the setting for the Signal Level parameter (or settings Auto Level). If this does not clear the problem then an external attenuation may need to be applied.
The Zone marked for Analysis is not setup correctly (R&S FSL-K93 only)	This message is displayed when there are configuration errors in the frame setup. Check the zone/segment map and burst map for any highlighted errors.

Alphabetical List of Remote Commands

Common Commands

*CAL?	6.6
*CLS	6.6
*ESE	6.6
*ESR?	6.7
*IDN?	6.7
*IST?	6.7
*OPC	6.7
*OPT?	6.7
*PCB	6.8
*PRE	6.8
*PSC	6.8
*RST	6.8
*SRE	6.8
*STB?	6.8
*TRG	6.9
*TST?	6.9
*WAI	6.9

Commands of the ABORt subsystem

ABORt	6.10
-------	------

Commands of the CALCulate subsystem

CALCulate<1 2>:ATV:LIMit:CARRiers:S1IFoffset:LOWer (K20)	6.410
CALCulate<1 2>:ATV:LIMit:CARRiers:S1IFoffset:UPPer (K20)	6.410
CALCulate<1 2>:ATV:LIMit:CARRiers:S1PRelative:LOWer (K20)	6.410
CALCulate<1 2>:ATV:LIMit:CARRiers:S1PRelative:UPPer (K20)	6.411
CALCulate<1 2>:ATV:LIMit:CARRiers:S2IFoffset:LOWer (K20)	6.411
CALCulate<1 2>:ATV:LIMit:CARRiers:S2IFoffset:UPPer (K20)	6.411
CALCulate<1 2>:ATV:LIMit:CARRiers:S2PRelative:LOWer (K20)	6.412
CALCulate<1 2>:ATV:LIMit:CARRiers:S2PRelative:UPPer (K20)	6.412
CALCulate<1 2>:ATV:LIMit:CARRiers:VCFoffse:LOWer (K20)	6.412
CALCulate<1 2>:ATV:LIMit:CARRiers:VCFoffse:UPPer (K20)	6.413
CALCulate<1 2>:ATV:LIMit:CARRiers:VCPabsolute:LOWer (K20)	6.413
CALCulate<1 2>:ATV:LIMit:CARRiers:VCPabsolute:UPPer (K20)	6.413
CALCulate<1 2>:ATV:LIMit:CN:CN[:LOWer] (K20)	6.414
CALCulate<1 2>:ATV:LIMit:CSO:CSO[:LOWer] (K20)	6.414
CALCulate<1 2>:ATV:LIMit:CTB:CTB[:LOWer] (K20)	6.414
CALCulate<1 2>:ATV:LIMit:HUM:HUM:LOWer (K20)	6.415
CALCulate<1 2>:ATV:LIMit:HUM:HUM:UPPer (K20)	6.415
CALCulate<1 2>:ATV:LIMit:RESult:CARRiers:S1IFoffset:LOWer? (K20)	6.418
CALCulate<1 2>:ATV:LIMit:RESult:CARRiers:S1IFoffset:UPPer? (K20)	6.419
CALCulate<1 2>:ATV:LIMit:RESult:CARRiers:S1PRelative:LOWer? (K20)	6.419
CALCulate<1 2>:ATV:LIMit:RESult:CARRiers:S1PRelative:UPPer? (K20)	6.420
CALCulate<1 2>:ATV:LIMit:RESult:CARRiers:S2IFoffset:LOWer? (K20)	6.420
CALCulate<1 2>:ATV:LIMit:RESult:CARRiers:S2IFoffset:UPPer? (K20)	6.420
CALCulate<1 2>:ATV:LIMit:RESult:CARRiers:S2PRelative:LOWer? (K20)	6.421
CALCulate<1 2>:ATV:LIMit:RESult:CARRiers:S2PRelative:UPPer? (K20)	6.421

CALCulate<1 2>:ATV:LIMit:RESult:CARRiers:VCFoffse:LOWer? (K20).....	6.422
CALCulate<1 2>:ATV:LIMit:RESult:CARRiers:VCFoffse:UPPer? (K20).....	6.422
CALCulate<1 2>:ATV:LIMit:RESult:CARRiers:VCPabsolute:LOWer? (K20).....	6.422
CALCulate<1 2>:ATV:LIMit:RESult:CARRiers:VCPabsolute:UPPer? (K20).....	6.423
CALCulate<1 2>:ATV:LIMit:RESult:CN:CN[:LOWer]? (K20).....	6.423
CALCulate<1 2>:ATV:LIMit:RESult:CSO:CSO[:LOWer]? (K20).....	6.424
CALCulate<1 2>:ATV:LIMit:RESult:CTB:CTB[:LOWer]? (K20).....	6.424
CALCulate<1 2>:ATV:LIMit:RESult:HUM:HUM:LOWer? (K20).....	6.424
CALCulate<1 2>:ATV:LIMit:RESult:HUM:HUM:UPPer? (K20).....	6.425
CALCulate<1 2>:ATV:LIMit:RESult:VMODulation:MDEPth:LOWer? (K20).....	6.425
CALCulate<1 2>:ATV:LIMit:RESult:VMODulation:MDEPth:UPPer? (K20).....	6.426
CALCulate<1 2>:ATV:LIMit:RESult:VMODulation:RPC:LOWer? (K20).....	6.426
CALCulate<1 2>:ATV:LIMit:RESult:VMODulation:RPC:UPPer? (K20).....	6.426
CALCulate<1 2>:ATV:LIMit:RESult:VMODulation:VCPower:LOWer? (K20).....	6.427
CALCulate<1 2>:ATV:LIMit:RESult:VMODulation:VCPower:UPPer? (K20).....	6.427
CALCulate<1 2>:ATV:LIMit:VMODulation:MDEPth:LOWer (K20).....	6.415
CALCulate<1 2>:ATV:LIMit:VMODulation:MDEPth:UPPer (K20).....	6.416
CALCulate<1 2>:ATV:LIMit:VMODulation:RPC:LOWer (K20).....	6.416
CALCulate<1 2>:ATV:LIMit:VMODulation:RPC:UPPer (K20).....	6.416
CALCulate<1 2>:ATV:LIMit:VMODulation:VCPower:LOWer (K20).....	6.417
CALCulate<1 2>:ATV:LIMit:VMODulation:VCPower:UPPer (K20).....	6.417
CALCulate<1 2>:ATV:RESult:CARRiers (K20).....	6.429
CALCulate<1 2>:ATV:RESult:CN (K20).....	6.430
CALCulate<1 2>:ATV:RESult:CSO (K20).....	6.430
CALCulate<1 2>:ATV:RESult:CTB (K20).....	6.431
CALCulate<1 2>:ATV:RESult:HUM (K20).....	6.432
CALCulate<1 2>:ATV:RESult:VMODulation (K20).....	6.432
CALCulate<1 2>:ATV:UNIT:POWER:HUM (K20).....	6.433
CALCulate<1 2>:ATV:UNIT:POWER:VCPabsolute (K20).....	6.433
CALCulate<1 2>:BTOoth:ACLR[:LIST]? (K8).....	6.327
CALCulate<1 2>:BTOoth:ACLR:EXCeptions? (K8).....	6.328
CALCulate<1 2>:BTOoth:CFDRift[:MAXimum]? (K8).....	6.328
CALCulate<1 2>:BTOoth:CFDRift:RATE? (K8).....	6.329
CALCulate<1 2>:BTOoth:CFStability:COUnT?.....	6.329
CALCulate<1 2>:BTOoth:CFStability:DEVM:[RMS]?.....	6.330
CALCulate<1 2>:BTOoth:CFStability:DEVM:D99Pct?.....	6.330
CALCulate<1 2>:BTOoth:CFStability:DEVM:DPCT?.....	6.331
CALCulate<1 2>:BTOoth:CFStability:DEVM:PEAK?.....	6.331
CALCulate<1 2>:BTOoth:CFStability:FERRor:[TOTal]?.....	6.331
CALCulate<1 2>:BTOoth:CFStability:FERRor:BLock?.....	6.332
CALCulate<1 2>:BTOoth:CFStability:FERRor:INITial?.....	6.333
CALCulate<1 2>:BTOoth:DPENcoding:[TOTal]?.....	6.333
CALCulate<1 2>:BTOoth:DPENcoding:BER?.....	6.334
CALCulate<1 2>:BTOoth:DPENcoding:NERRor?.....	6.334
CALCulate<1 2>:BTOoth:IBSemissions:[List]?.....	6.335
CALCulate<1 2>:BTOoth:IBSemissions:EXCeptions?.....	6.335
CALCulate<1 2>:BTOoth:IBSemissions:HADJacent?.....	6.336
CALCulate<1 2>:BTOoth:IBSemissions:TXReference?.....	6.336
CALCulate<1 2>:BTOoth:ICFTolerance? (K8).....	6.337
CALCulate<1 2>:BTOoth:MCHar:DF<1 2>:AVERAge? (K8).....	6.337
CALCulate<1 2>:BTOoth:MCHar:DF<1 2>:MAXimum? (K8).....	6.338
CALCulate<1 2>:BTOoth:MCHar:DF2:PERCent? (K8).....	6.339
CALCulate<1 2>:BTOoth:MCHar:RATio? (K8).....	6.339
CALCulate<1 2>:BTOoth:OPower[:PEAK]? (K8).....	6.340
CALCulate<1 2>:BTOoth:OPower:AVERAge? (K8).....	6.340
CALCulate<1 2>:BTOoth:PLENght? (K8).....	6.341
CALCulate<1 2>:BTOoth:PTYPe? (K8).....	6.342
CALCulate<1 2>:BTOoth:RTPower:[DPSK]?.....	6.342

CALCulate<1 2>:BTOoth:RTPower:GFSK?	6.343
CALCulate<1 2>:BTOoth:RTPower:RATio?	6.343
CALCulate<1 2>:BTOoth:STATus? (K8)	6.344
CALCulate<1 2>:BURSt[:IMMediate] (K91 / K91n)	6.667
CALCulate<1 2>:BURSt[:IMMediate] (K92/K93)	6.751
CALCulate<1 2>:DELTamarker<1...4>[:STATe]	6.12
CALCulate<1 2>:DELTamarker<1...4>:AOFF	6.13
CALCulate<1 2>:DELTamarker<1...4>:FUNCTio:n:CPICH (K72)	6.562, 6.569
CALCulate<1 2>:DELTamarker<1...4>:FUNCTio:n:FIXed[:STATe]	6.13
CALCulate<1 2>:DELTamarker<1...4>:FUNCTio:n:FIXed:RPOint:MAXimum[:PEAK]	6.14
CALCulate<1 2>:DELTamarker<1...4>:FUNCTio:n:FIXed:RPOint:X	6.14
CALCulate<1 2>:DELTamarker<1...4>:FUNCTio:n:FIXed:RPOint:Y	6.14
CALCulate<1 2>:DELTamarker<1...4>:FUNCTio:n:FIXed:RPOint:Y:OFFSet	6.15
CALCulate<1 2>:DELTamarker<1...4>:FUNCTio:n:PCCPch (K72)	6.563, 6.570
CALCulate<1 2>:DELTamarker<1...4>:FUNCTio:n:PNOise[:STATe]	6.15
CALCulate<1 2>:DELTamarker<1...4>:FUNCTio:n:PNOise:RESult?	6.16
CALCulate<1 2>:DELTamarker<1...4>:MAXimum[:PEAK]	6.16
CALCulate<1 2>:DELTamarker<1...4>:MAXimum:LEFT	6.17
CALCulate<1 2>:DELTamarker<1...4>:MAXimum:NEXT	6.17
CALCulate<1 2>:DELTamarker<1...4>:MAXimum:RIGHT	6.17
CALCulate<1 2>:DELTamarker<1...4>:MINimum[:PEAK]	6.18
CALCulate<1 2>:DELTamarker<1...4>:MINimum:LEFT	6.18
CALCulate<1 2>:DELTamarker<1...4>:MINimum:NEXT	6.19
CALCulate<1 2>:DELTamarker<1...4>:MINimum:RIGHT	6.19
CALCulate<1 2>:DELTamarker<1...4>:MODE	6.19
CALCulate<1 2>:DELTamarker<1...4>:SPECTrogram:FRAME (K14)	6.386
CALCulate<1 2>:DELTamarker<1...4>:SPECTrogram:SAREa (K14)	6.386
CALCulate<1 2>:DELTamarker<1...4>:SPECTrogram:XY:MAXimum[:PEAK] (K14)	6.387
CALCulate<1 2>:DELTamarker<1...4>:SPECTrogram:XY:MINimum[:PEAK] (K14)	6.387
CALCulate<1 2>:DELTamarker<1...4>:SPECTrogram:Y:MAXimum[:PEAK] (K14)	6.388
CALCulate<1 2>:DELTamarker<1...4>:SPECTrogram:Y:MAXimum:ABOVe (K14)	6.388
CALCulate<1 2>:DELTamarker<1...4>:SPECTrogram:Y:MAXimum:BELow (K14)	6.388
CALCulate<1 2>:DELTamarker<1...4>:SPECTrogram:Y:MAXimum:NEXT (K14)	6.389
CALCulate<1 2>:DELTamarker<1...4>:SPECTrogram:Y:MINimum[:PEAK] (K14)	6.389
CALCulate<1 2>:DELTamarker<1...4>:SPECTrogram:Y:MINimum:ABOVe (K14)	6.390
CALCulate<1 2>:DELTamarker<1...4>:SPECTrogram:Y:MINimum:BELow (K14)	6.390
CALCulate<1 2>:DELTamarker<1...4>:SPECTrogram:Y:MINimum:NEXT (K14)	6.390
CALCulate<1 2>:DELTamarker<1...4>:TRACe	6.20
CALCulate<1 2>:DELTamarker<1...4>:TRACe (K20)	6.435
CALCulate<1 2>:DELTamarker<1...4>:X	6.20
CALCulate<1 2>:DELTamarker<1...4>:X:RELative?	6.21
CALCulate<1 2>:DELTamarker<1...4>:Y?	6.21
CALCulate<1 2>:DELTamarker<1...4>:Y? (K20)	6.435
CALCulate<1 2>:DELTamarker<1...4>:Y? (K8)	6.345
CALCulate<1 2>:DLINe<1 2>	6.23
CALCulate<1 2>:DLINe<1 2>:STATe	6.23
CALCulate<1 2>:DTV:RESult (K20)	6.454
CALCulate<1 2>:DTV:UNIT:POWer:EPATtern (K20)	6.456
CALCulate<1 2>:DTV:UNIT:POWer:EVMPeak (K20)	6.456
CALCulate<1 2>:DTV:UNIT:POWer:EVMRms (K20)	6.457
CALCulate<1 2>:DTV:UNIT:POWer:MERPeak (K20)	6.457
CALCulate<1 2>:DTV:UNIT:POWer:MERRms (K20)	6.457
CALCulate<1 2>:ESpectrum:PSEarch PEAKsearch:PSHow	6.25
CALCulate<1 2>:ESpectrum:PSEarch PEAKsearch:AUTO	6.24

CALCulate<1 2>:ESpectrum:PSEarch PEAKsearch:MARGin	6.24
CALCulate<1 2>:FLINe<1 2>	6.26
CALCulate<1 2>:FLINe<1 2>:STATe	6.26
CALCulate<1 2>:FORMat (K7)	6.281
CALCulate<1 2>:LIMit<1 ... 8>:CONTrol:SPACing	6.43
CALCulate<1 2>:LIMit<1 ... 8>:ESpectrum:PCLass<1...4>:COUNT	6.45
CALCulate<1 2>:LIMit<1 ... 8>:ESpectrum:PCLass<1...4>:STATe	6.45
CALCulate<1 2>:LIMit<1...6>:CONTrol[:DATA] (K30)	6.522
CALCulate<1 2>:LIMit<1...6>:CONTrol:SHIFt (K30)	6.522
CALCulate<1 2>:LIMit<1...6>:COPY (K30)	6.520
CALCulate<1 2>:LIMit<1...6>:DELete (K30)	6.520
CALCulate<1 2>:LIMit<1...6>:FAIL? (K30)	6.520
CALCulate<1 2>:LIMit<1...6>:LOWer[:DATA] (K30)	6.523
CALCulate<1 2>:LIMit<1...6>:LOWer:SHIFt (K30)	6.523
CALCulate<1 2>:LIMit<1...6>:LOWer:STATe (K30)	6.523
CALCulate<1 2>:LIMit<1...6>:NAME (K30)	6.520
CALCulate<1 2>:LIMit<1...6>:STATe (K30)	6.520
CALCulate<1 2>:LIMit<1...6>:UPPer[:DATA] (K30)	6.524
CALCulate<1 2>:LIMit<1...6>:UPPer:SHIFt (K30)	6.524
CALCulate<1 2>:LIMit<1...6>:UPPer:STATe (K30)	6.524
CALCulate<1 2>:LIMit<1...8>:ACPower[:STATe]	6.33
CALCulate<1 2>:LIMit<1...8>:ACPower:ACHannel[:RELative]	6.33
CALCulate<1 2>:LIMit<1...8>:ACPower:ACHannel[:RELative]:STATe	6.34
CALCulate<1 2>:LIMit<1...8>:ACPower:ACHannel:ABSolute	6.35
CALCulate<1 2>:LIMit<1...8>:ACPower:ACHannel:ABSolute:STATe	6.35
CALCulate<1 2>:LIMit<1...8>:ACPower:ACHannel:RESult?	6.36
CALCulate<1 2>:LIMit<1...8>:ACPower:ALTernate<1 2>[:RELative]	6.36
CALCulate<1 2>:LIMit<1...8>:ACPower:ALTernate<1 2>[:RELative]:STATe	6.37
CALCulate<1 2>:LIMit<1...8>:ACPower:ALTernate<1 2>:ABSolute	6.38
CALCulate<1 2>:LIMit<1...8>:ACPower:ALTernate<1 2>:ABSolute:STATe	6.38
CALCulate<1 2>:LIMit<1...8>:ACPower:ALTernate<1 2>:RESult?	6.39
CALCulate<1 2>:LIMit<1...8>:ACTive?	6.28
CALCulate<1 2>:LIMit<1...8>:CLEar[:IMMediate]	6.29
CALCulate<1 2>:LIMit<1...8>:COMMENT	6.29
CALCulate<1 2>:LIMit<1...8>:CONTrol[:DATA]	6.41
CALCulate<1 2>:LIMit<1...8>:CONTrol:DOMain	6.41
CALCulate<1 2>:LIMit<1...8>:CONTrol:MODE	6.42
CALCulate<1 2>:LIMit<1...8>:CONTrol:OFFSet	6.42
CALCulate<1 2>:LIMit<1...8>:CONTrol:SHIFt	6.43
CALCulate<1 2>:LIMit<1...8>:COPY	6.30
CALCulate<1 2>:LIMit<1...8>:DELete	6.30
CALCulate<1 2>:LIMit<1...8>:ESpectrum:MODE (K72)	6.566
CALCulate<1 2>:LIMit<1...8>:ESpectrum:MODE (K82)	6.597
CALCulate<1 2>:LIMit<1...8>:ESpectrum:MODE (K84)	6.630
CALCulate<1 2>:LIMit<1...8>:ESpectrum:RESTore (K72)	6.566
CALCulate<1 2>:LIMit<1...8>:ESpectrum:RESTore (K82)	6.597
CALCulate<1 2>:LIMit<1...8>:ESpectrum:RESTore (K84)	6.630
CALCulate<1 2>:LIMit<1...8>:ESpectrum:TRANSition (K72)	6.567
CALCulate<1 2>:LIMit<1...8>:ESpectrum:VALue (K72)	6.567
CALCulate<1 2>:LIMit<1...8>:ESpectrum:VALue (K82)	6.598
CALCulate<1 2>:LIMit<1...8>:ESpectrum:VALue (K84)	6.631
CALCulate<1 2>:LIMit<1...8>:FAIL?	6.30
CALCulate<1 2>:LIMit<1...8>:FAIL? (K91 / K91n)	6.669
CALCulate<1 2>:LIMit<1...8>:FAIL? (K92/K93)	6.753
CALCulate<1 2>:LIMit<1...8>:LOWer[:DATA]	6.47
CALCulate<1 2>:LIMit<1...8>:LOWer:MARGin	6.48

CALCulate<1 2>:LIMit<1...8>:LOWer:MODE	6.49
CALCulate<1 2>:LIMit<1...8>:LOWer:OFFSet	6.48
CALCulate<1 2>:LIMit<1...8>:LOWer:SHIFt.....	6.49
CALCulate<1 2>:LIMit<1...8>:LOWer:SPACing	6.50
CALCulate<1 2>:LIMit<1...8>:LOWer:STATe.....	6.48
CALCulate<1 2>:LIMit<1...8>:LOWer:THReshold.....	6.50
CALCulate<1 2>:LIMit<1...8>:NAME	6.31
CALCulate<1 2>:LIMit<1...8>:STATe	6.31
CALCulate<1 2>:LIMit<1...8>:TRACe.....	6.32
CALCulate<1 2>:LIMit<1...8>:TRACe (K30).....	6.521
CALCulate<1 2>:LIMit<1...8>:UNIT	6.32
CALCulate<1 2>:LIMit<1...8>:UPPer[:DATA]	6.51
CALCulate<1 2>:LIMit<1...8>:UPPer:MARGin	6.51
CALCulate<1 2>:LIMit<1...8>:UPPer:MODE	6.52
CALCulate<1 2>:LIMit<1...8>:UPPer:OFFSet	6.52
CALCulate<1 2>:LIMit<1...8>:UPPer:SHIFt.....	6.53
CALCulate<1 2>:LIMit<1...8>:UPPer:SPACing	6.53
CALCulate<1 2>:LIMit<1...8>:UPPer:STATe.....	6.54
CALCulate<1 2>:LIMit<1...8>:UPPer:THReshold	6.54
CALCulate<1 2>:LIMit<1>:ACPower:ACHannel (K91 / K91n).....	6.669
CALCulate<1 2>:LIMit<1>:ACPower:ALTErnate? (K91 / K91n)	6.670
CALCulate<1 2>:LIMit<1>:BURSt: BERPilot[:AVERAge] (K93).....	6.754
CALCulate<1 2>:LIMit<1>:BURSt: BERPilot[:AVERAge]:RESult? (K93)	6.755
CALCulate<1 2>:LIMit<1>:BURSt:ALL (K91 / K91n).....	6.670
CALCulate<1 2>:LIMit<1>:BURSt:ALL (K92/K93).....	6.753
CALCulate<1 2>:LIMit<1>:BURSt:ALL:RESUlt (K91 / K91n)	6.671
CALCulate<1 2>:LIMit<1>:BURSt:ALL:RESult? (K92/K93).....	6.754
CALCulate<1 2>:LIMit<1>:BURSt:BERPilot:MAXimum (K93).....	6.755
CALCulate<1 2>:LIMit<1>:BURSt:BERPilot:MAXimum:RESult? (K93)	6.755
CALCulate<1 2>:LIMit<1>:BURSt:EVM[:AVERAge] (K91 / K91n).....	6.671
CALCulate<1 2>:LIMit<1>:BURSt:EVM[:AVERAge]:RESult? (K91 / K91n).....	6.671
CALCulate<1 2>:LIMit<1>:BURSt:EVM:ALL[:AVERAge] (K91 / K91n)	6.672
CALCulate<1 2>:LIMit<1>:BURSt:EVM:ALL[:AVERAge] (K92/K93)	6.756
CALCulate<1 2>:LIMit<1>:BURSt:EVM:ALL[:AVERAge]:RESult? (K91 / K91n)	6.672
CALCulate<1 2>:LIMit<1>:BURSt:EVM:ALL[:AVERAge]:RESult? (K92/K93)	6.756
CALCulate<1 2>:LIMit<1>:BURSt:EVM:ALL:MAXimum (K91 / K91n)	6.672
CALCulate<1 2>:LIMit<1>:BURSt:EVM:ALL:MAXimum (K92/K93)	6.757
CALCulate<1 2>:LIMit<1>:BURSt:EVM:ALL:MAXimum:RESult? (K91 / K91n)	6.673
CALCulate<1 2>:LIMit<1>:BURSt:EVM:ALL:MAXimum:RESult? (K92/K93)	6.757
CALCulate<1 2>:LIMit<1>:BURSt:EVM:DATA[:AVERAge] (K91 / K91n).....	6.673
CALCulate<1 2>:LIMit<1>:BURSt:EVM:DATA[:AVERAge] (K92/K93).....	6.757
CALCulate<1 2>:LIMit<1>:BURSt:EVM:DATA[:AVERAge]:RESult? (K91 / K91n).....	6.673
CALCulate<1 2>:LIMit<1>:BURSt:EVM:DATA[:AVERAge]:RESult? (K92/K93).....	6.758
CALCulate<1 2>:LIMit<1>:BURSt:EVM:DATA:MAXimum (K91 / K91n).....	6.674
CALCulate<1 2>:LIMit<1>:BURSt:EVM:DATA:MAXimum (K92/K93).....	6.758
CALCulate<1 2>:LIMit<1>:BURSt:EVM:DATA:MAXimum:RESult? (K91 / K91n).....	6.674
CALCulate<1 2>:LIMit<1>:BURSt:EVM:DATA:MAXimum:RESult? (K92/K93).....	6.759
CALCulate<1 2>:LIMit<1>:BURSt:EVM:MAXimum (K91 / K91n).....	6.675
CALCulate<1 2>:LIMit<1>:BURSt:EVM:MAXimum:RESult? (K91 / K91n).....	6.675
CALCulate<1 2>:LIMit<1>:BURSt:EVM:PILot[:AVERAge] (K91 / K91n)	6.675
CALCulate<1 2>:LIMit<1>:BURSt:EVM:PILot[:AVERAge]:RESult? (K91 / K91n)	6.676
CALCulate<1 2>:LIMit<1>:BURSt:EVM:PILot:MAXimum (K91 / K91n)	6.676
CALCulate<1 2>:LIMit<1>:BURSt:EVM:PILot:MAXimum:RESult? (K91 / K91n)	6.676
CALCulate<1 2>:LIMit<1>:BURSt:FERRor[:AVERAge] (K91 / K91n)	6.677
CALCulate<1 2>:LIMit<1>:BURSt:FERRor[:AVERAge] (K92/K93)	6.759
CALCulate<1 2>:LIMit<1>:BURSt:FERRor[:AVERAge]:RESult? (K91 / K91n)	6.677
CALCulate<1 2>:LIMit<1>:BURSt:FERRor[:AVERAge]:RESult? (K92/K93)	6.759
CALCulate<1 2>:LIMit<1>:BURSt:FERRor:MAXimum (K91 / K91n)	6.677
CALCulate<1 2>:LIMit<1>:BURSt:FERRor:MAXimum (K92/K93)	6.760

CALCulate<1 2>:LIMit<1>:BURSt:FERRor:MAXimum:RESult? (K91 / K91n)	6.678
CALCulate<1 2>:LIMit<1>:BURSt:FERRor:MAXimum:RESult? (K92/K93)	6.760
CALCulate<1 2>:LIMit<1>:BURSt:IQOFFset[:AVERAge] (K91 / K91n)	6.678
CALCulate<1 2>:LIMit<1>:BURSt:IQOFFset[:AVERAge] (K92/K93)	6.761
CALCulate<1 2>:LIMit<1>:BURSt:IQOFFset[:AVERAge]:RESult? (K91 / K91n)	6.678
CALCulate<1 2>:LIMit<1>:BURSt:IQOFFset[:AVERAge]:RESult? (K92/K93)	6.761
CALCulate<1 2>:LIMit<1>:BURSt:IQOFFset:MAXimum (K91 / K91n)	6.679
CALCulate<1 2>:LIMit<1>:BURSt:IQOFFset:MAXimum (K92/K93)	6.762
CALCulate<1 2>:LIMit<1>:BURSt:IQOFFset:MAXimum:RESult? (K91 / K91n)	6.679
CALCulate<1 2>:LIMit<1>:BURSt:IQOFFset:MAXimum:RESult? (K92/K93)	6.762
CALCulate<1 2>:LIMit<1>:BURSt:SSTiming[:AVERAge] (K92/K93)	6.762
CALCulate<1 2>:LIMit<1>:BURSt:SSTiming[:AVERAge]:RESult? (K92/K93)	6.763
CALCulate<1 2>:LIMit<1>:BURSt:SSTiming:MAXimum (K92/K93)	6.763
CALCulate<1 2>:LIMit<1>:BURSt:SSTiming:MAXimum:RESult? (K92/K93)	6.764
CALCulate<1 2>:LIMit<1>:BURSt:SYMBolerror[:AVERAge] (K91 / K91n)	6.679
CALCulate<1 2>:LIMit<1>:BURSt:SYMBolerror[:AVERAge] (K92/K93)	6.764
CALCulate<1 2>:LIMit<1>:BURSt:SYMBolerror[:AVERAge]:RESult? (K91 / K91n)	6.680
CALCulate<1 2>:LIMit<1>:BURSt:SYMBolerror[:AVERAge]:RESult? (K92/K93)	6.764
CALCulate<1 2>:LIMit<1>:BURSt:SYMBolerror:MAXimum (K91 / K91n)	6.680
CALCulate<1 2>:LIMit<1>:BURSt:SYMBolerror:MAXimum (K92/K93)	6.765
CALCulate<1 2>:LIMit<1>:BURSt:SYMBolerror:MAXimum:RESult? (K91 / K91n)	6.680
CALCulate<1 2>:LIMit<1>:BURSt:SYMBolerror:MAXimum:RESult? (K92/K93)	6.765
CALCulate<1 2>:LIMit<1>:BURSt:TFALI[:AVERAge] (K91 / K91n)	6.681
CALCulate<1 2>:LIMit<1>:BURSt:TFALI[:AVERAge]:RESult? (K91 / K91n)	6.681
CALCulate<1 2>:LIMit<1>:BURSt:TFALI:MAXimum (K91 / K91n)	6.681
CALCulate<1 2>:LIMit<1>:BURSt:TFALI:MAXimum:RESult? (K91 / K91n)	6.682
CALCulate<1 2>:LIMit<1>:BURSt:TRISe[:AVERAge] (K91 / K91n)	6.682
CALCulate<1 2>:LIMit<1>:BURSt:TRISe[:AVERAge]:RESult (K91 / K91n)	6.682
CALCulate<1 2>:LIMit<1>:BURSt:TRISe:MAXimum (K91 / K91n)	6.683
CALCulate<1 2>:LIMit<1>:BURSt:TRISe:MAXimum:RESult? (K91 / K91n)	6.683
CALCulate<1 2>:LIMit<1>:SPEctrum:MASK:CHECK:X (K91 / K91n)	6.683
CALCulate<1 2>:LIMit<1>:SPEctrum:MASK:CHECK:X? (K92/K93)	6.766
CALCulate<1 2>:LIMit<1>:SPEctrum:MASK:CHECK:Y (K91 / K91n)	6.684
CALCulate<1 2>:LIMit<1>:SPEctrum:MASK:CHECK:Y? (K92/K93)	6.766
CALCulate<1 2>:LIMit<1...8>:ESPEctrum:LIMits	6.46
CALCulate<1 2>:LIMit<1...8>:ESPEctrum:PCLass<1...4>[:EXCLusive]	6.44
CALCulate<1 2>:LIMit<1...8>:ESPEctrum:PCLass<1...4>:MAXimum	6.45
CALCulate<1 2>:LIMit<1...8>:ESPEctrum:PCLass<1...4>:MINimum	6.44
CALCulate<1 2>:MARKer<1...4>[:STATe]	6.55
CALCulate<1 2>:MARKer<1...4>:AOFF	6.56
CALCulate<1 2>:MARKer<1...4>:COUNT	6.56
CALCulate<1 2>:MARKer<1...4>:COUNT:FREQuency?	6.57
CALCulate<1 2>:MARKer<1...4>:COUNT:RESolution	6.57
CALCulate<1 2>:MARKer<1...4>:FUNctioN:CDPower[:BTS]:RESult? (K82)	6.599
CALCulate<1 2>:MARKer<1...4>:FUNctioN:CENTer	6.69
CALCulate<1 2>:MARKer<1...4>:FUNctioN:CSTep	6.69
CALCulate<1 2>:MARKer<1...4>:FUNctioN:DEModulation[:STATe]	6.68
CALCulate<1 2>:MARKer<1...4>:FUNctioN:DEModulation:CONTinuous	6.68
CALCulate<1 2>:MARKer<1...4>:FUNctioN:DEModulation:HOLDoff	6.68
CALCulate<1 2>:MARKer<1...4>:FUNctioN:DEModulation:SElect	6.69
CALCulate<1 2>:MARKer<1...4>:FUNctioN:FPEaks[:IMMediate]	6.70
CALCulate<1 2>:MARKer<1...4>:FUNctioN:FPEaks:COUNT?	6.71
CALCulate<1 2>:MARKer<1...4>:FUNctioN:FPEaks:SORT	6.71
CALCulate<1 2>:MARKer<1...4>:FUNctioN:FPEaks:X?	6.71
CALCulate<1 2>:MARKer<1...4>:FUNctioN:FPEaks:Y?	6.72
CALCulate<1 2>:MARKer<1...4>:FUNctioN:HARMonics[:STATe]	6.81
CALCulate<1 2>:MARKer<1...4>:FUNctioN:HARMonics:BANDwidth:AUTO	6.81
CALCulate<1 2>:MARKer<1...4>:FUNctioN:HARMonics:DIStortion?	6.82

CALCulate<1 2>:MARKer<1...4>:FUNction:HARMonics:LIST?	6.82
CALCulate<1 2>:MARKer<1...4>:FUNction:HARMonics:NHARmonics	6.83
CALCulate<1 2>:MARKer<1...4>:FUNction:HARMonics:PRESet	6.83
CALCulate<1 2>:MARKer<1...4>:FUNction:MDEPth[:STATe]	6.73
CALCulate<1 2>:MARKer<1...4>:FUNction:MDEPth:RESult?	6.73
CALCulate<1 2>:MARKer<1...4>:FUNction:MDEPth:SEARChsignal ONCE	6.74
CALCulate<1 2>:MARKer<1...4>:FUNction:NDBDown	6.74
CALCulate<1 2>:MARKer<1...4>:FUNction:NDBDown:FREQuency?	6.75
CALCulate<1 2>:MARKer<1...4>:FUNction:NDBDown:QFACTOR	6.75
CALCulate<1 2>:MARKer<1...4>:FUNction:NDBDown:RESult?	6.76
CALCulate<1 2>:MARKer<1...4>:FUNction:NDBDown:STATe	6.76
CALCulate<1 2>:MARKer<1...4>:FUNction:NDBDown:TIME?	6.77
CALCulate<1 2>:MARKer<1...4>:FUNction:NOISe[:STATe]	6.77
CALCulate<1 2>:MARKer<1...4>:FUNction:NOISe:RESult?	6.77
CALCulate<1 2>:MARKer<1...4>:FUNction:PICH (K82)	6.599
CALCulate<1 2>:MARKer<1...4>:FUNction:REFerence	6.78
CALCulate<1 2>:MARKer<1...4>:FUNction:SUMMery:REFerence:AUTO	6.100
CALCulate<1 2>:MARKer<1...4>:FUNction:TDPIch (K82)	6.600
CALCulate<1 2>:MARKer<1...4>:FUNction:TOI[:STATe]	6.78
CALCulate<1 2>:MARKer<1...4>:FUNction:TOI:RESult?	6.79
CALCulate<1 2>:MARKer<1...4>:FUNction:TOI:SEARChsignal ONCE	6.79
CALCulate<1 2>:MARKer<1...4>:FUNction:WCDPower[:BTS]:RESult? (K72)	6.570
CALCulate<1 2>:MARKer<1...4>:FUNction:ZOOM	6.80
CALCulate<1 2>:MARKer<1...4>:LOEXclude	6.58
CALCulate<1 2>:MARKer<1...4>:MAXimum[:PEAK]	6.58
CALCulate<1 2>:MARKer<1...4>:MAXimum:AUTO	6.58
CALCulate<1 2>:MARKer<1...4>:MAXimum:LEFT	6.59
CALCulate<1 2>:MARKer<1...4>:MAXimum:NEXT	6.59
CALCulate<1 2>:MARKer<1...4>:MAXimum:RIGHT	6.60
CALCulate<1 2>:MARKer<1...4>:MINimum[:PEAK]	6.60
CALCulate<1 2>:MARKer<1...4>:MINimum:AUTO	6.61
CALCulate<1 2>:MARKer<1...4>:MINimum:LEFT	6.61
CALCulate<1 2>:MARKer<1...4>:MINimum:NEXT	6.62
CALCulate<1 2>:MARKer<1...4>:MINimum:RIGHT	6.62
CALCulate<1 2>:MARKer<1...4>:PEXCursion	6.63
CALCulate<1 2>:MARKer<1...4>:PEXCursion (K7)	6.282
CALCulate<1 2>:MARKer<1...4>:PEXCursion (K8)	6.346
CALCulate<1 2>:MARKer<1...4>:SPECTrogram:FRAMe (K14)	6.392
CALCulate<1 2>:MARKer<1...4>:SPECTrogram:SAReA (K14)	6.392
CALCulate<1 2>:MARKer<1...4>:SPECTrogram:XY:MAXimum[:PEAK] (K14)	6.393
CALCulate<1 2>:MARKer<1...4>:SPECTrogram:XY:MINimum[:PEAK] (K14)	6.393
CALCulate<1 2>:MARKer<1...4>:SPECTrogram:Y:MAXimum[:PEAK] (K14)	6.393
CALCulate<1 2>:MARKer<1...4>:SPECTrogram:Y:MAXimum:ABOVe (K14)	6.394
CALCulate<1 2>:MARKer<1...4>:SPECTrogram:Y:MAXimum:BELOW (K14)	6.394
CALCulate<1 2>:MARKer<1...4>:SPECTrogram:Y:MAXimum:NEXT (K14)	6.395
CALCulate<1 2>:MARKer<1...4>:SPECTrogram:Y:MINimum[:PEAK] (K14)	6.395
CALCulate<1 2>:MARKer<1...4>:SPECTrogram:Y:MINimum:ABOVe (K14)	6.396
CALCulate<1 2>:MARKer<1...4>:SPECTrogram:Y:MINimum:BELOW (K14)	6.396
CALCulate<1 2>:MARKer<1...4>:SPECTrogram:Y:MINimum:NEXT (K14)	6.397
CALCulate<1 2>:MARKer<1...4>:TRACe	6.63
CALCulate<1 2>:MARKer<1...4>:TRACe (K20)	6.460
CALCulate<1 2>:MARKer<1...4>:X	6.63
CALCulate<1 2>:MARKer<1...4>:X (K91 / K91n)	6.688
CALCulate<1 2>:MARKer<1...4>:X:SLIMits[:STATe]	6.64
CALCulate<1 2>:MARKer<1...4>:X:SLIMits:LEFT	6.64
CALCulate<1 2>:MARKer<1...4>:X:SLIMits:RIGHT	6.65
CALCulate<1 2>:MARKer<1...4>:X:SSIZe	6.65
CALCulate<1 2>:MARKer<1...4>:Y?	6.66
CALCulate<1 2>:MARKer<1...4>:Y? (K7)	6.282

CALCulate<1 2>:MARKer<1...4>:Y? (K8)	6.346
CALCulate<1 2>:MARKer<1...4>:Y:PERCent	6.66
CALCulate<1 2>:MARKer<1>[:STATe] (K91 / K91n)	6.685
CALCulate<1 2>:MARKer<1>[:STATe] (K92/K93)	6.767
CALCulate<1 2>:MARKer<1>:AOFF (K91 / K91n)	6.685
CALCulate<1 2>:MARKer<1>:AOFF (K92/K93)	6.768
CALCulate<1 2>:MARKer<1>:BSYMBol (K91 / K91n)	6.686
CALCulate<1 2>:MARKer<1>:BURSt (K92/K93)	6.768
CALCulate<1 2>:MARKer<1>:CARRier (K91 / K91n)	6.686
CALCulate<1 2>:MARKer<1>:CARRier (K92/K93)	6.768
CALCulate<1 2>:MARKer<1>:FUNCTion:POWer:RESult[:CURRent]? (K91 / K91n)	6.690
CALCulate<1 2>:MARKer<1>:FUNCTion:POWer:RESult[:CURRent]? (K92/K93)	6.773
CALCulate<1 2>:MARKer<1>:FUNCTion:POWer:RESult:MAXHold? (K91 / K91n)	6.690
CALCulate<1 2>:MARKer<1>:FUNCTion:POWer:RESult:MAXHold? (K92/K93)	6.773
CALCulate<1 2>:MARKer<1>:FUNCTion:ZOOM (K91 / K91n)	6.691
CALCulate<1 2>:MARKer<1>:FUNCTion:ZOOM (K92/K93)	6.774
CALCulate<1 2>:MARKer<1>:MAXimum (K91 / K91n)	6.687
CALCulate<1 2>:MARKer<1>:MAXimum[:PEAK] (K92/K93)	6.769
CALCulate<1 2>:MARKer<1>:MINimum (K91 / K91n)	6.687
CALCulate<1 2>:MARKer<1>:MINimum[:PEAK] (K92/K93)	6.769
CALCulate<1 2>:MARKer<1>:SYMBol (K91 / K91n)	6.687
CALCulate<1 2>:MARKer<1>:SYMBol (K92/K93)	6.770
CALCulate<1 2>:MARKer<1>:TRACe (K91 / K91n)	6.688
CALCulate<1 2>:MARKer<1>:TRACe (K92/K93)	6.770
CALCulate<1 2>:MARKer<1>:TTCapture? (K93)	6.771
CALCulate<1 2>:MARKer<1>:X (K92/K93)	6.771
CALCulate<1 2>:MARKer<1>:Y (K91 / K91n)	6.689
CALCulate<1 2>:MARKer<1>:Y? (K92/K93)	6.772
CALCulate<1 2>:MARKer:FUNCTion:ADEMod:AFRequency[:RESult<1...4>]? (K7)	6.283
CALCulate<1 2>:MARKer:FUNCTion:ADEMod:AM[:RESult<1...4>]? (K7)	6.284
CALCulate<1 2>:MARKer:FUNCTion:ADEMod:CARRier[:RESult<1...6>]? (K7)	6.284
CALCulate<1 2>:MARKer:FUNCTion:ADEMod:FERRor[:RESult<1...6>]? (K7)	6.285
CALCulate<1 2>:MARKer:FUNCTion:ADEMod:FM[:RESult<1...6>]? (K7)	6.285
CALCulate<1 2>:MARKer:FUNCTion:ADEMod:PM[:RESult]? (K7)	6.286
CALCulate<1 2>:MARKer:FUNCTion:ADEMod:SINad:RESult<1...6>? (K7)	6.286
CALCulate<1 2>:MARKer:FUNCTion:ADEMod:THD:RESult<1...6>? (K7)	6.287
CALCulate<1 2>:MARKer:FUNCTion:MSUMmary?	6.93
CALCulate<1 2>:MARKer:FUNCTion:POWer[:STATe]	6.86
CALCulate<1 2>:MARKer:FUNCTion:POWer:MODE]	6.86
CALCulate<1 2>:MARKer:FUNCTion:POWer:PRESet	6.86
CALCulate<1 2>:MARKer:FUNCTion:POWer:RESult?	6.87
CALCulate<1 2>:MARKer:FUNCTion:POWer:RESult:PHZ	6.89
CALCulate<1 2>:MARKer:FUNCTion:POWer:SElect	6.90
CALCulate<1 2>:MARKer:FUNCTion:STRack[:STATe]	6.91
CALCulate<1 2>:MARKer:FUNCTion:STRack:BANDwidth	6.91
CALCulate<1 2>:MARKer:FUNCTion:STRack:BWIDth	6.91
CALCulate<1 2>:MARKer:FUNCTion:STRack:THReshold	6.92
CALCulate<1 2>:MARKer:FUNCTion:STRack:TRACe	6.92
CALCulate<1 2>:MARKer:FUNCTion:SUMMery[:STATe]	6.94
CALCulate<1 2>:MARKer:FUNCTion:SUMMery:AOFF	6.95
CALCulate<1 2>:MARKer:FUNCTion:SUMMery:AVERage	6.95
CALCulate<1 2>:MARKer:FUNCTion:SUMMery:MEAN[:STATe]	6.96
CALCulate<1 2>:MARKer:FUNCTion:SUMMery:MEAN:AVERage:RESult?	6.96
CALCulate<1 2>:MARKer:FUNCTion:SUMMery:MEAN:PHOLd:RESult?	6.97
CALCulate<1 2>:MARKer:FUNCTion:SUMMery:MEAN:RESult?	6.97
CALCulate<1 2>:MARKer:FUNCTion:SUMMery:MODE	6.98
CALCulate<1 2>:MARKer:FUNCTion:SUMMery:PHOLd	6.98
CALCulate<1 2>:MARKer:FUNCTion:SUMMery:PPEak[:STATe]	6.98
CALCulate<1 2>:MARKer:FUNCTion:SUMMery:PPEak:AVERage:RESult?	6.99

CALCulate<1 2>:MARKer:FUNCTion:SUMMary:PPEak:PHOLd:RESult?	6.99
CALCulate<1 2>:MARKer:FUNCTion:SUMMary:PPEak:RESult?	6.100
CALCulate<1 2>:MARKer:FUNCTion:SUMMary:RMS[:STATe]	6.101
CALCulate<1 2>:MARKer:FUNCTion:SUMMary:RMS:AVERAge:RESult?	6.101
CALCulate<1 2>:MARKer:FUNCTion:SUMMary:RMS:PHOLd:RESult?	6.102
CALCulate<1 2>:MARKer:FUNCTion:SUMMary:RMS:RESult?	6.103
CALCulate<1 2>:MARKer:FUNCTion:SUMMary:SDEViation[:STATe]	6.103
CALCulate<1 2>:MARKer:FUNCTion:SUMMary:SDEViation:AVERAge:RESult?	6.103
CALCulate<1 2>:MARKer:FUNCTion:SUMMary:SDEViation:PHOLd:RESult?	6.104
CALCulate<1 2>:MARKer:FUNCTion:SUMMary:SDEViation:RESult?	6.105
CALCulate<1 2>:MATH[:EXPRession][:DEFine]	6.106
CALCulate<1 2>:MATH:MODE	6.106
CALCulate<1 2>:MATH:POSition	6.107
CALCulate<1 2>:MATH:STATe	6.107
CALCulate<1 2>:PMETer:RELative[:MAGNitude] (K9)	6.372
CALCulate<1 2>:PMETer:RELative[:MAGNitude]:AUTO (K9)	6.372
CALCulate<1 2>:PMETer:RELative:STATe (K9)	6.373
CALCulate<1 2>:PSEArch PEAKsearch[:IMMediate]	6.108
CALCulate<1 2>:PSEArch PEAKsearch:AUTO	6.108
CALCulate<1 2>:PSEArch PEAKsearch:MARGin	6.108
CALCulate<1 2>:PSEArch PEAKsearch:PSHow	6.108
CALCulate<1 2>:PSEArch PEAKsearch:SUBRanges	6.109
CALCulate<1 2>:SPECTrogram[:STATe] (K14)	6.398
CALCulate<1 2>:SPECTrogram:CLear[:IMMediate] (K14)	6.398
CALCulate<1 2>:SPECTrogram:COLor (K14)	6.399
CALCulate<1 2>:SPECTrogram:CONTinuous (K14)	6.399
CALCulate<1 2>:SPECTrogram:FRAMe:COUNT (K14)	6.400
CALCulate<1 2>:SPECTrogram:FRAMe:SELEct (K14)	6.400
CALCulate<1 2>:SPECTrogram:HDEPth (K14)	6.401
CALCulate<1 2>:SPECTrogram:SIZE (K14)	6.401
CALCulate<1 2>:SPECTrogram:TSTamp[:STATe] (K14)	6.401
CALCulate<1 2>:SPECTrogram:TSTamp:DATA (K14)	6.402
CALCulate<1 2>:THREshold	6.115
CALCulate<1 2>:THREshold:STATe	6.115
CALCulate<1 2>:TLINe<1 2>	6.116
CALCulate<1 2>:TLINe<1 2>:STATe	6.116
CALCulate<1 2>:UNIT:ANGLe (K7)	6.288
CALCulate<1 2>:UNIT:POWer	6.117
CALCulate<1 2>:UNIT:POWer (K20)	6.464
CALCulate:DTV:LIMit:CFOFFset:LOWer (K20)	6.437
CALCulate:DTV:LIMit:CFOFFset:UPPer (K20)	6.437
CALCulate:DTV:LIMit:CHPower:LOWer (K20)	6.438
CALCulate:DTV:LIMit:CHPower:UPPer (K20)	6.437
CALCulate:DTV:LIMit:CSUPpression[:LOWer] (K20)	6.438
CALCulate:DTV:LIMit:EVMPeak:LOWer] (K20)	6.438
CALCulate:DTV:LIMit:EVMPeak:UPPer (K20)	6.439
CALCulate:DTV:LIMit:EVMRms:LOWer (K20)	6.439
CALCulate:DTV:LIMit:EVMRms:UPPer (K20)	6.439
CALCulate:DTV:LIMit:IMBalance:LOWer (K20)	6.440
CALCulate:DTV:LIMit:IMBalance:UPPer (K20)	6.440
CALCulate:DTV:LIMit:MERPeak:LOWer (K20)	6.440

CALCulate:DTV:LIMit:MERPeak:UPPer (K20).....	6.441
CALCulate:DTV:LIMit:MERRms:LOWer (K20).....	6.441
CALCulate:DTV:LIMit:MERRms:UPPer (K20).....	6.442
CALCulate:DTV:LIMit:PJITter[:UPPer] (K20).....	6.442
CALCulate:DTV:LIMit:QERRor:LOWer (K20).....	6.443
CALCulate:DTV:LIMit:QERRor:UPPer (K20).....	6.443
CALCulate:DTV:LIMit:RESult:CFOffset:LOWer? (K20).....	6.445
CALCulate:DTV:LIMit:RESult:CFOffset:UPPer? (K20).....	6.446
CALCulate:DTV:LIMit:RESult:CHPower? (K20).....	6.446
CALCulate:DTV:LIMit:RESult:CSUPpression[:LOWer]? (K20).....	6.446
CALCulate:DTV:LIMit:RESult:EVMPeak:LOWer? (K20).....	6.447
CALCulate:DTV:LIMit:RESult:EVMPeak:UPPer? (K20).....	6.447
CALCulate:DTV:LIMit:RESult:EVMRms:LOWer? (K20).....	6.448
CALCulate:DTV:LIMit:RESult:EVMRms:UPPer? (K20).....	6.448
CALCulate:DTV:LIMit:RESult:IMBalance:LOWer? (K20).....	6.448
CALCulate:DTV:LIMit:RESult:IMBalance:UPPer? (K20).....	6.449
CALCulate:DTV:LIMit:RESult:MERPeak:LOWer? (K20).....	6.449
CALCulate:DTV:LIMit:RESult:MERPeak:UPPer? (K20).....	6.450
CALCulate:DTV:LIMit:RESult:MERRms:LOWer? (K20).....	6.450
CALCulate:DTV:LIMit:RESult:MERRms:UPPer? (K20).....	6.450
CALCulate:DTV:LIMit:RESult:PJITter[:UPPer]? (K20).....	6.451
CALCulate:DTV:LIMit:RESult:QERRor:LOWer? (K20).....	6.451
CALCulate:DTV:LIMit:RESult:QERRor:UPPer? (K20).....	6.452
CALCulate:DTV:LIMit:RESult:SROffset:LOWer? (K20).....	6.452
CALCulate:DTV:LIMit:RESult:SROffset:UPPer? (K20).....	6.452
CALCulate:DTV:LIMit:SROffset:LOWer (K20).....	6.443
CALCulate:DTV:LIMit:SROffset:UPPer (K20).....	6.444
CALCulate:MARKer:TRACe (K30).....	6.526
CALCulate:MARKer:Y? (K30).....	6.526
CALCulate:STATistics:APD[:STATe].....	6.110
CALCulate:STATistics:CCDF[:STATe].....	6.110
CALCulate:STATistics:NSAMples.....	6.111
CALCulate:STATistics:PRESet.....	6.111
CALCulate:STATistics:RESult<1...6>?.....	6.111
CALCulate:STATistics:SCALE:AUTO.....	6.112
CALCulate:STATistics:SCALE:X:RANGE.....	6.112
CALCulate:STATistics:SCALE:X:RLEVel.....	6.113
CALCulate:STATistics:SCALE:Y:LOWer.....	6.113
CALCulate:STATistics:SCALE:Y:UNIT.....	6.114
CALCulate:STATistics:SCALE:Y:UPPer.....	6.114

Commands of the CALibration subsystem

CALibration[:ALL]?.....	6.118
CALibration:ABORt.....	6.118
CALibration:PMETer:ZERO:AUTO (K9).....	6.374
CALibration:RESult?.....	6.119
CALibration:STATe.....	6.119

Commands of the CONFigure subsystem

CONFigure:ATV:CN:MEASurement (K20).....	6.465
CONFigure:ATV:CSO:MEASurement (K20).....	6.466
CONFigure:ATV:CTB:MEASurement (K20).....	6.466
CONFigure:ATV:MEASurement (K20).....	6.467

CONFigure:BT0oth:ACLR:ACPairs (K8)	6.348
CONFigure:BT0oth:BANDwidth BWIDth[:RESolution] (K8).....	6.348
CONFigure:BT0oth:BANDwidth BWIDth[:RESolution]:AUTO (K8)	6.349
CONFigure:BT0oth:BANDwidth BWIDth:VIDeo (K8)	6.349
CONFigure:BT0oth:BANDwidth BWIDth:VIDeo:AUTO (K8)	6.350
CONFigure:BT0oth:CFSTability:BCOunt (K8).....	6.350
CONFigure:BT0oth:CHANnel (K8)	6.350
CONFigure:BT0oth:DETEctor<1...6> (K8).....	6.351
CONFigure:BT0oth:IBSemiissions:ACPairs (K8)	6.352
CONFigure:BT0oth:IBSemiissions:GATE:AUTO (K8)	6.352
CONFigure:BT0oth:MEASurement (K8).....	6.352
CONFigure:BT0oth:PBSCo (K8).....	6.353
CONFigure:BT0oth:PCLass (K8).....	6.353
CONFigure:BT0oth:POWer:AVERage:STARt (K8).....	6.354
CONFigure:BT0oth:POWer:AVERage:STOP (K8).....	6.354
CONFigure:BT0oth:PRATe (K8).....	6.355
CONFigure:BT0oth:PTYPE (K8).....	6.355
CONFigure:BT0oth:RTPower:DAVerage:STARt (K8).....	6.355
CONFigure:BT0oth:RTPower:DAVerage:STOP (K8).....	6.356
CONFigure:BT0oth:RTPower:GAVerage:STARt (K8).....	6.356
CONFigure:BT0oth:RTPower:GAVerage:STOP (K8).....	6.357
CONFigure:BT0oth:SWEEp:COUNt (K8)	6.357
CONFigure:BT0oth:SWEEp:TIME (K8)	6.358
CONFigure:BT0oth:SWEEp:TIME:AUTO (K8)	6.358
CONFigure:BT0oth:TRACe<1...6>:MODE (K8)	6.359
CONFigure:BT0oth:TRACe<1...6>:SELEct (K8).....	6.360
CONFigure:BURSt:BSTReam:BURSt:SELEct (K93)	6.777
CONFigure:BURSt:BSTReam:FORMat:SELEct (K93).....	6.777
CONFigure:BURSt:BSTReam:SYMBOL:SELEct (K93).....	6.778
CONFigure:BURSt:CONST:CARRier:SELEct (K91 / K91n)	6.692
CONFigure:BURSt:CONST:CCARRier[:IMMEDIATE] (K91 / K91n).....	6.693
CONFigure:BURSt:CONST:CCARRier[:IMMEDIATE] (K92/K93).....	6.779
CONFigure:BURSt:CONST:CSYMBOL[:IMMEDIATE] (K91 / K91n).....	6.693
CONFigure:BURSt:CONST:CSYMBOL[:IMMEDIATE] (K92/K93).....	6.779
CONFigure:BURSt:CONST:FORMat:SELEct (K93)	6.780
CONFigure:BURSt:EVM:ECARRier[:IMMEDIATE] (K91 / K91n).....	6.693
CONFigure:BURSt:EVM:ECARRier[:IMMEDIATE] (K92/K93).....	6.781
CONFigure:BURSt:EVM:ESYMBOL[:IMMEDIATE] (K91 / K91n).....	6.694
CONFigure:BURSt:EVM:ESYMBOL[:IMMEDIATE] (K92/K93).....	6.781
CONFigure:BURSt:PREamble[:IMMEDIATE] (K91 / K91n)	6.694
CONFigure:BURSt:PREamble[:IMMEDIATE] (K92/K93)	6.781
CONFigure:BURSt:PREamble:SELEct (K91 / K91n).....	6.694
CONFigure:BURSt:PREamble:SELEct (K92/K93).....	6.782
CONFigure:BURSt:PVT[:IMMEDIATE] (K91 / K91n).....	6.695
CONFigure:BURSt:PVT[:IMMEDIATE] (K92/K93).....	6.782
CONFigure:BURSt:PVT:AVERage (K91 / K91n).....	6.695
CONFigure:BURSt:PVT:BURSt (K92/K93)	6.783
CONFigure:BURSt:PVT:RPOWER (K91 / K91n).....	6.695
CONFigure:BURSt:PVT:SELEct (K91 / K91n).....	6.696
CONFigure:BURSt:PVT:SELEct (K92/K93).....	6.783
CONFigure:BURSt:SPECTrum:ACPR[:IMMEDIATE] (K91 / K91n).....	6.696
CONFigure:BURSt:SPECTrum:ACPR[:IMMEDIATE] (K92/K93).....	6.783
CONFigure:BURSt:SPECTrum:ACPR:SELEct (K92/K93).....	6.784
CONFigure:BURSt:SPECTrum:FFT[:IMMEDIATE] (K91 / K91n).....	6.696
CONFigure:BURSt:SPECTrum:FFT[:IMMEDIATE] (K92/K93).....	6.784
CONFigure:BURSt:SPECTrum:FLATness[:IMMEDIATE] (K91 / K91n).....	6.697
CONFigure:BURSt:SPECTrum:FLATness[:IMMEDIATE] (K92/K93).....	6.784
CONFigure:BURSt:SPECTrum:FLATness:SELEct (K92/K93).....	6.785

CONFigure:BURSt:SPECTrum:MASK[:IMMediate] (K91 / K91n)	6.697
CONFigure:BURSt:SPECTrum:MASK[:IMMediate] (K92/K93)	6.785
CONFigure:BURSt:SPECTrum:MASK:SELEct (K91 / K91n).....	6.697
CONFigure:BURSt:SPECTrum:MASK:SELEct (K92/K93).....	6.785
CONFigure:BURSt:STATistics:BSTReam[:IMMediate] (K91 / K91n).....	6.698
CONFigure:BURSt:STATistics:BSTReam[:IMMediate] (K92/K93).....	6.786
CONFigure:BURSt:STATistics:BSUMmary[:IMMediate] (K92/K93).....	6.786
CONFigure:BURSt:STATistics:CCDF[:IMMediate] (K91 / K91n)	6.698
CONFigure:BURSt:STATistics:CCDF[:IMMediate] (K92/K93)	6.787
CONFigure:BURSt:STATistics:SFIeld[:IMMediate] (K91 / K91n).....	6.698
CONFigure:CDPower[:BTS]:BCLass (K82).....	6.605
CONFigure:CDPower[:BTS]:BCLass (K84).....	6.641
CONFigure:CDPower[:BTS]:CTABLE[:STATe] (K82).....	6.602
CONFigure:CDPower[:BTS]:CTABLE[:STATe] (K84).....	6.637
CONFigure:CDPower[:BTS]:CTABLE:CATalog? (K82).....	6.603
CONFigure:CDPower[:BTS]:CTABLE:CATalog? (K84).....	6.638
CONFigure:CDPower[:BTS]:CTABLE:COMMeNt (K82)	6.603
CONFigure:CDPower[:BTS]:CTABLE:COMMeNt (K84)	6.638
CONFigure:CDPower[:BTS]:CTABLE:COPIY (K82).....	6.603
CONFigure:CDPower[:BTS]:CTABLE:COPIY (K84).....	6.638
CONFigure:CDPower[:BTS]:CTABLE:DATA (K82)	6.604
CONFigure:CDPower[:BTS]:CTABLE:DATA (K84)	6.639
CONFigure:CDPower[:BTS]:CTABLE:DELEte (K82).....	6.604
CONFigure:CDPower[:BTS]:CTABLE:DELEte (K84).....	6.640
CONFigure:CDPower[:BTS]:CTABLE:NAME (K82).....	6.605
CONFigure:CDPower[:BTS]:CTABLE:NAME (K84).....	6.640
CONFigure:CDPower[:BTS]:CTABLE:SELEct (K82)	6.605
CONFigure:CDPower[:BTS]:CTABLE:SELEct (K84)	6.641
CONFigure:CDPower[:BTS]:MCARier[:STATe] (K82)	6.606
CONFigure:CDPower[:BTS]:MCARier[:STATe] (K84)	6.642
CONFigure:CDPower[:BTS]:MEASurement (K82).....	6.606
CONFigure:CDPower[:BTS]:MEASurement (K84).....	6.642
CONFigure:CDPower[:BTS]:PVTime:BURSt	6.643
CONFigure:CDPower[:BTS]:PVTime:FREStart	6.643
CONFigure:CDPower[:BTS]:PVTime:LIST[:STATe]	6.644
CONFigure:CDPower[:BTS]:PVTime:LIST:RESult?	6.644
CONFigure:CDPower[:BTS]:REVIision	6.644
CONFigure:CDPower[:BTS]:RFSLot.....	6.645
CONFigure:CDPower:CTABLE:REStore (K82)	6.607
CONFigure:CDPower:CTABLE:REStore (K84).....	6.641
CONFigure:CHANnel (K91 / K91n)	6.699
CONFigure:CHANnel (K92/K93)	6.787
CONFigure:CORRection (K30).....	6.528
CONFigure:DTV:MEASurement (K20).....	6.468
CONFigure:DTV:MEASurement:SATTenuation (K20).....	6.468
CONFigure:LIST:CONTinuous (K30)	6.529
CONFigure:LIST:SINGle (K30).....	6.529
CONFigure:POWER:AUTO (K91 / K91n)	6.699
CONFigure:POWER:AUTO (K92/K93)	6.787
CONFigure:POWER:AUTO:SWEEp:TIME (K91 / K91n).....	6.699
CONFigure:POWER:AUTO:SWEEp:TIME (K92/K93)	6.788
CONFigure:POWER:EXPEcted:RF (K91 / K91n)	6.700
CONFigure:POWER:EXPEcted:RF (K92/K93)	6.788

CONFigure:SINGle (K30)	6.529
CONFigure:STANdard (K91 / K91n).....	6.700
CONFigure:STANdard (K92/K93).....	6.788
CONFigure:TV:CTABle:SElect (K20)	6.469
CONFigure:TV:MEASurement (K20).....	6.469
CONFigure:WCDPower:[BTS]:MEASurement (K72)	6.572
CONFigure:WIMax:DLSFrame:PINdex (K93)	6.790
CONFigure:WIMax:DLSFrame:PMODE (K93).....	6.789
CONFigure:WIMax:FBANd (K92/K93)	6.791
CONFigure:WIMax:IGRatio (K92/K93).....	6.791
CONFigure:WIMax:LMODe (K92/K93).....	6.792

Commands of the DIAGnostic subsystem

DIAGnostic<1 2>:SERVice:BIOSinfo?	6.120
DIAGnostic<1 2>:SERVice:HWINfo?	6.120
DIAGnostic<1 2>:SERVice:INPut[:SElect].....	6.121
DIAGnostic<1 2>:SERVice:INPut:PULSed[:STATe]	6.121
DIAGnostic<1 2>:SERVice:INPut:PULSed:PRATe	6.121
DIAGnostic<1 2>:SERVice:NSOurce	6.122
DIAGnostic<1 2>:SERVice:SFUNction.....	6.122
DIAGnostic<1 2>:SERVice:STEst:RESult?.....	6.123

Commands of the DISPlay subsystem

DISPlay[:WINDow<1 2>]:SIZE	6.128
DISPlay[:WINDow<1 2>]:SIZE (K7).....	6.289
DISPlay[:WINDow<1 2>]:SSElect (K82).....	6.608
DISPlay[:WINDow<1 2>]:SSElect (K84).....	6.646
DISPlay[:WINDow<1 2>]:SSElect (K91 / K91n)	6.702
DISPlay[:WINDow<1 2>]:SSElect (K92/K93)	6.803
DISPlay[:WINDow<1 2>]:TABLe (K91 / K91n)	6.703
DISPlay[:WINDow<1 2>]:TABLe (K92/K93)	6.803
DISPlay[:WINDow<1 2>]:TABLe:UNIT (K92/K93).....	6.803
DISPlay[:WINDow<1 2>]:TEXT[:DATA].....	6.129
DISPlay[:WINDow<1 2>]:TEXT:STATe	6.129
DISPlay[:WINDow<1 2>]:TIME	6.129
DISPlay[:WINDow<1 2>]:TRACe<1...4>[:STATe] (K20)	6.470
DISPlay[:WINDow<1 2>]:TRACe<1...4>:MODE (K20).....	6.470
DISPlay[:WINDow<1 2>]:TRACe<1...4>:MODE:FREeze[:STATe]	6.470
DISPlay[:WINDow<1 2>]:TRACe<1...4>:MODE:HCONtinuous (K20).....	6.471
DISPlay[:WINDow<1 2>]:TRACe<1...4>:Y[:SCALe] (K20)	6.471
DISPlay[:WINDow<1 2>]:TRACe<1...4>:Y[:SCALe]:AUTO (K20).....	6.471
DISPlay[:WINDow<1 2>]:TRACe<1...4>:Y[:SCALe]:MODE (K20)	6.471
DISPlay[:WINDow<1 2>]:TRACe<1...4>:Y[:SCALe]:RLEVel (K20).....	6.472
DISPlay[:WINDow<1 2>]:TRACe<1...4>:Y[:SCALe]:RLEVel:OFFSet (K20)	6.472
DISPlay[:WINDow<1 2>]:TRACe<1...4>:Y[:SCALe]:RPOSitioN (K20)	6.472
DISPlay[:WINDow<1 2>]:TRACe<1...4>:Y:SPACing (K20).....	6.472
DISPlay[:WINDow<1 2>]:TRACe<1...6>[:STATe]	6.130
DISPlay[:WINDow<1 2>]:TRACe<1...6>:MODE	6.130
DISPlay[:WINDow<1 2>]:TRACe<1...6>:MODE (K72).....	6.573
DISPlay[:WINDow<1 2>]:TRACe<1...6>:MODE:HCONtinuous	6.131
DISPlay[:WINDow<1 2>]:TRACe<1...6>:Y[:SCALe].....	6.132
DISPlay[:WINDow<1 2>]:TRACe<1...6>:Y[:SCALe]:MAXimum	6.647

DISPlay[:WINDow<1 2>]:TRACe<1...6>:Y[:SCALe]:MINimum	6.609, 6.647
DISPlay[:WINDow<1 2>]:TRACe<1...6>:Y[:SCALe]:MODE	6.132
DISPlay[:WINDow<1 2>]:TRACe<1...6>:Y[:SCALe]:PDIVision (K7)	6.289
DISPlay[:WINDow<1 2>]:TRACe<1...6>:Y[:SCALe]:PDIVision (K72)	6.573
DISPlay[:WINDow<1 2>]:TRACe<1...6>:Y[:SCALe]:PDIVision (K8)	6.361
DISPlay[:WINDow<1 2>]:TRACe<1...6>:Y[:SCALe]:RLEVel	6.133
DISPlay[:WINDow<1 2>]:TRACe<1...6>:Y[:SCALe]:RLEVel:OFFSet	6.133
DISPlay[:WINDow<1 2>]:TRACe<1...6>:Y[:SCALe]:RPOSition	6.133
DISPlay[:WINDow<1 2>]:TRACe<1...6>:Y[:SCALe]:RPOSition (K7)	6.290
DISPlay[:WINDow<1 2>]:TRACe<1...6>:Y[:SCALe]:RPOSition (K8)	6.361
DISPlay[:WINDow<1 2>]:TRACe<1...6>:Y[:SCALe]:RVALue	6.134
DISPlay[:WINDow<1 2>]:TRACe<1...6>:Y[:SCALe]:RVALue (K7)	6.290
DISPlay[:WINDow<1 2>]:TRACe<1...6>:Y[:SCALe]:RVALue (K8)	6.361
DISPlay[:WINDow<1 2>]:TRACe<1...6>:Y[:SCALe]:RVALue:AUTO	6.134
DISPlay[:WINDow<1 2>]:TRACe<1...6>:Y:SPACing	6.132
DISPlay[:WINDow<1 2>]:TRACe<1...6>:Y:SPACing (K7)	6.290
DISPlay[:WINDow<1 2>]:TRACe<1...3>:Y[:SCALe]:RLEVel? (K92/K93)	6.805
DISPlay[:WINDow<1 2>]:TRACe<1...3>:Y[:SCALe]:RLEVel[:RF] (K92/K93)	6.805
DISPlay[:WINDow<1 2>]:TRACe<1...3>:Y[:SCALe]:RLEVel:OFFSet (K92/K93)	6.805
DISPlay[:WINDow<1 2>]:TRACe<1...4>:Y[:SCALe]:AUTO (K91 / K91n)	6.703
DISPlay[:WINDow<1 2>]:TRACe<1...4>:Y[:SCALe]:PDIVision (K91 / K91n)	6.703
DISPlay[:WINDow<1 2>]:TRACe<1...4>:Y[:SCALe]:RLEVel (K91 / K91n)	6.704
DISPlay[:WINDow<1 2>]:TRACe<1...6>:X:SPACing	6.131
DISPlay[:WINDow<1 2>]:TRACe1:Y[:SCALe]:AUTO (K92/K93)	6.804
DISPlay[:WINDow<1 2>]:TRACe1:Y[:SCALe]:PDIVision (K92/K93)	6.804
DISPlay[:WINDow<1 2>]:ZOOM:EPATtern	6.472
DISPlay[:WINDow<1 2>]:ZOOM:EPATtern:STATe	6.472
DISPlay[:WINDow<1 2>]:ZOOM:MERRors	6.473
DISPlay[:WINDow<1 2>]:ZOOM:QUADrant	6.474
DISPlay[:WINDow<1 4>]:TRACe<1...6>:Y[:SCALe]:MAXimum	6.609
DISPlay[:WINDow<1>]:TABLE (K30)	6.531
DISPlay[:WINDow<1>]:TRACe<1 2>[:STATe] (K30)	6.532
DISPlay[:WINDow<1>]:TRACe<1 2>:SYMBOLs (K30)	6.532
DISPlay[:WINDow<1>]:TRACe<1 2>:X[:SCALe] (K30)	6.533
DISPlay[:WINDow<1>]:TRACe<1 2>:Y[:SCALe]:AUTO (K30)	6.533
DISPlay[:WINDow<1>]:TRACe<1 2>:Y[:SCALe]:BOTTOm (K30)	6.533
DISPlay[:WINDow<1>]:TRACe<1 2>:Y[:SCALe]:RLEVel (K30)	6.534
DISPlay[:WINDow<1>]:TRACe<1 2>:Y[:SCALe]:RLEVel:AUTO (K30)	6.535
DISPlay[:WINDow<1>]:TRACe<1 2>:Y[:SCALe]:TOP (K30)	6.535
DISPlay:ANNotation:FREQUency	6.125
DISPlay:CMAP<1...26>:DEFault<1 2>	6.126
DISPlay:CMAP<1...26>:HSL	6.126
DISPlay:CMAP<1...26>:PDEFined	6.126
DISPlay:DATA:TRACe<1> (K30)	6.531
DISPlay:FORMat	6.127
DISPlay:FORMat (K30)	6.531
DISPlay:FORMat (K82)	6.608
DISPlay:FORMat (K84)	6.646
DISPlay:FORMat (K91 / K91n)	6.702
DISPlay:FORMat (K92/K93)	6.802
DISPlay:LOGO	6.127
DISPlay:PSAVE[:STATe]	6.127
DISPlay:PSAVE:HOLDoff	6.128

Commands of the FETCh subsystem

FETCh<1 2>:PMETer? (K9)	6.376
FETCh:ARRAy:MEMory<1...3>:NOISe:FIGure? (K30).....	6.536
FETCh:ARRAy:MEMory<1...3>:NOISe:GAIN? (K30)	6.537
FETCh:ARRAy:MEMory<1...3>:NOISe:TEMPerature? (K30)	6.537
FETCh:ARRAy:NOISe:FIGure? (K30).....	6.537
FETCh:ARRAy:NOISe:GAIN? (K30)	6.538
FETCh:ARRAy:NOISe:TEMPerature? (K30).....	6.538
FETCh:BURSt:ALL? (K91 / K91n).....	6.707
FETCh:BURSt:ALL? (K92/K93).....	6.810
FETCh:BURSt:CINR? (K92/K93)	6.810
FETCh:BURSt:COUNt? (K91 / K91n).....	6.707
FETCh:BURSt:COUNt? (K92/K93).....	6.811
FETCh:BURSt:CRESt[:AVERAge?] (K91 / K91n)	6.708
FETCh:BURSt:CRESt:AVERAge? (K92/K93)	6.811
FETCh:BURSt:CRESt:MAXimum (K91 / K91n)	6.708
FETCh:BURSt:CRESt:MAXimum? (K92/K93)	6.811
FETCh:BURSt:CRESt:MINimum (K91 / K91n).....	6.708
FETCh:BURSt:CRESt:MINimum? (K92/K93).....	6.811
FETCh:BURSt:EVM:[IEEE]:AVERAge? (K91 / K91n)	6.708
FETCh:BURSt:EVM:[IEEE]:MAXimum? (K91 / K91n)	6.708
FETCh:BURSt:EVM:[IEEE]:MINimum? (K91 / K91n).....	6.708
FETCh:BURSt:EVM:ALL:AVERAge (K91 / K91n)	6.708
FETCh:BURSt:EVM:ALL:AVERAge? (K92/K93)	6.812
FETCh:BURSt:EVM:ALL:MAXimum (K91 / K91n)	6.708
FETCh:BURSt:EVM:ALL:MAXimum? (K92/K93)	6.812
FETCh:BURSt:EVM:ALL:MINimum (K91 / K91n)	6.708
FETCh:BURSt:EVM:ALL:MINimum? (K92/K93)	6.812
FETCh:BURSt:EVM:DATA:AVERAge (K91 / K91n).....	6.709
FETCh:BURSt:EVM:DATA:AVERAge? (K92/K93).....	6.812
FETCh:BURSt:EVM:DATA:MAXimum (K91 / K91n).....	6.709
FETCh:BURSt:EVM:DATA:MAXimum? (K92/K93).....	6.812
FETCh:BURSt:EVM:DATA:MINimum (K91 / K91n).....	6.709
FETCh:BURSt:EVM:DATA:MINimum? (K92/K93).....	6.812
FETCh:BURSt:EVM:DIReCt:AVERAge? (K91 / K91n).....	6.709
FETCh:BURSt:EVM:DIReCt:MAXimum? (K91 / K91n).....	6.709
FETCh:BURSt:EVM:DIReCt:MINimum? (K91 / K91n).....	6.709
FETCh:BURSt:EVM:PILot:AVERAge? (K91 / K91n)	6.709
FETCh:BURSt:EVM:PILot:AVERAge? (K92/K93)	6.812
FETCh:BURSt:EVM:PILot:MAXimum? (K91 / K91n)	6.709
FETCh:BURSt:EVM:PILot:MAXimum? (K92/K93)	6.812
FETCh:BURSt:EVM:PILot:MINimum? (K91 / K91n)	6.709
FETCh:BURSt:EVM:PILot:MINimum? (K92/K93)	6.812
FETCh:BURSt:FERRor:AVERAge? (K91 / K91n)	6.710
FETCh:BURSt:FERRor:AVERAge? (K92/K93)	6.813
FETCh:BURSt:FERRor:MAXimum? (K91 / K91n)	6.710
FETCh:BURSt:FERRor:MAXimum? (K92/K93)	6.813
FETCh:BURSt:FERRor:MINimum? (K91 / K91n).....	6.710
FETCh:BURSt:FERRor:MINimum? (K92/K93).....	6.813
FETCh:BURSt:GIMBalance:AVERAge? (K91 / K91n).....	6.710
FETCh:BURSt:GIMBalance:AVERAge? (K92/K93).....	6.813
FETCh:BURSt:GIMBalance:MAXimum? (K91 / K91n).....	6.710
FETCh:BURSt:GIMBalance:MAXimum? (K92/K93).....	6.813
FETCh:BURSt:GIMBalance:MINimum? (K91 / K91n).....	6.710
FETCh:BURSt:GIMBalance:MINimum? (K92/K93).....	6.813
FETCh:BURSt:IQOFfset:AVERAge? (K91 / K91n).....	6.710
FETCh:BURSt:IQOFfset:AVERAge? (K92/K93).....	6.813
FETCh:BURSt:IQOFfset:MAXimum? (K91 / K91n).....	6.710

FETCh:BURSt:IQOFset:MAXimum? (K92/K93).....	6.813
FETCh:BURSt:IQOFset:MINimum? (K91 / K91n).....	6.710
FETCh:BURSt:IQOFset:MINimum? (K92/K93).....	6.813
FETCh:BURSt:PAYLoad? (K91 / K91n).....	6.711
FETCh:BURSt:PEAK? (K91 / K91n).....	6.711
FETCh:BURSt:PREAmble? (K91 / K91n).....	6.711
FETCh:BURSt:QUADoffset:AVERage? (K91 / K91n).....	6.711
FETCh:BURSt:QUADoffset:AVERage? (K92/K93).....	6.814
FETCh:BURSt:QUADoffset:MAXimum? (K91 / K91n).....	6.711
FETCh:BURSt:QUADoffset:MAXimum? (K92/K93).....	6.814
FETCh:BURSt:QUADoffset:MINimum? (K91 / K91n).....	6.711
FETCh:BURSt:QUADoffset:MINimum? (K92/K93).....	6.814
FETCh:BURSt:RMS[:AVERage?] (K91 / K91n).....	6.712
FETCh:BURSt:RMS:DLPreamble:AVERage? (K92/K93).....	6.815
FETCh:BURSt:RMS:DLPreamble:MAXimum? (K92/K93).....	6.815
FETCh:BURSt:RMS:DLPreamble:MINimum? (K92/K93).....	6.815
FETCh:BURSt:RMS:MAXimum (K91 / K91n).....	6.712
FETCh:BURSt:RMS:MINimum? (K91 / K91n).....	6.712
FETCh:BURSt:RSSI (K92/K93).....	6.816
FETCh:BURSt:SYMBolerror:AVERage? (K91 / K91n).....	6.712
FETCh:BURSt:SYMBolerror:AVERage? (K92/K93).....	6.816
FETCh:BURSt:SYMBolerror:MAXimum? (K91 / K91n).....	6.712
FETCh:BURSt:SYMBolerror:MAXimum? (K92/K93).....	6.816
FETCh:BURSt:SYMBolerror:MINimum? (K91 / K91n).....	6.712
FETCh:BURSt:SYMBolerror:MINimum? (K92/K93).....	6.816
FETCh:BURSt:TDOMain:PREAmble? (K93).....	6.817
FETCh:BURSt:TDOMain:SUBFrame? (K93).....	6.817
FETCh:BURSt:TDOMain:ZONE? (K93).....	6.817
FETCh:BURSt:TFALI:AVERage? (K91 / K91n).....	6.712
FETCh:BURSt:TFALI:MAXimum? (K91 / K91n).....	6.712
FETCh:BURSt:TFALI:MINimum? (K91 / K91n).....	6.712
FETCh:BURSt:TRISe:AVERage? (K91 / K91n).....	6.713
FETCh:BURSt:TRISe:MAXimum? (K91 / K91n).....	6.713
FETCh:BURSt:TRISe:MINimum? (K91 / K91n).....	6.713
FETCh:SCALar:NOISE:FIGure? (K30).....	6.538
FETCh:SCALar:NOISE:GAIN? (K30).....	6.539
FETCh:SCALar:NOISE:TEMPerature? (K30).....	6.539
FETCh:SYMBol:COUNt? (K91 / K91n).....	6.713
FETCh:SYMBol:COUNt? (K92/K93).....	6.818

Commands of the FORMat subsystem

FORMat[:DATA].....	6.135
FORMat[:DATA] (K91 / K91n).....	6.714
FORMat[:DATA] (K92/K93).....	6.819
FORMat:DEXPort:DSEPARATOR.....	6.135

Commands of the HCOPy subsystem

HCOPy[:IMMEDIATE<1 2>].....	6.136
HCOPy[:IMMEDIATE<1 2>]:NEXT.....	6.137
HCOPy:ABORT.....	6.137
HCOPy:CMAp<1...26>:DEFault1 2 3 4.....	6.137
HCOPy:CMAp<1...26>:HSL.....	6.138
HCOPy:CMAp<1...26>:PDEFined.....	6.138
HCOPy:DESTination<1 2>.....	6.139
HCOPy:DEvice:COLor.....	6.140
HCOPy:DEvice:LANGUage<1 2>.....	6.140
HCOPy:ITEM:ALL.....	6.141

HCOPy:ITEM:WINDow<1 2>:TEXT	6.141
HCOPy:ITEM:WINDow<1 2>:TRACe:STATe	6.141
HCOPy:PAGE:ORlentation<1 2>	6.142
HCOPy:TDSTamp:STATe<1 2>	6.142

Commands of the INITiate subsystem

INITiate[:IMMediate] (K30)	6.540
INITiate<1 2>[:IMMediate]	6.143
INITiate<1 2>:CONMeas	6.143
INITiate<1 2>:CONTInuous	6.144
INITiate<1 2>:CONTInuous (K14)	6.403
INITiate<1 2>:DISPlay	6.144
INITiate<1 2>:ESpectrum	6.145
INITiate<1 2>:SPURious	6.145

Commands of the INPut subsystem

INPut<1 2>:ATTenuation	6.146
INPut<1 2>:ATTenuation:AUTO	6.146
INPut<1 2>:GAIN:STATe	6.147
INPut<1 2>:IMPedance	6.147
INPut<1 2>:UPORt[:VALue]?	6.148
INPut<1 2>:UPORt:STATe	6.148
INPut:SElect (K92/K93)	6.821

Commands of the INSTrument subsystem

INSTrument[:NSElect] (K20)	6.478
INSTrument[:NSElect] (K7)	6.291
INSTrument[:NSElect] (K72)	6.577
INSTrument[:NSElect] (K8)	6.362
INSTrument[:NSElect] (K91 / K91n)	6.717
INSTrument[:NSElect] (K92/K93)	6.822
INSTrument[:SElect]	6.149
INSTrument[:SElect] (K20)	6.478
INSTrument[:SElect] (K30)	6.542
INSTrument[:SElect] (K7)	6.291
INSTrument[:SElect] (K72)	6.577
INSTrument[:SElect] (K8)	6.362
INSTrument[:SElect] (K82)	6.610
INSTrument[:SElect] (K84)	6.648
INSTrument[:SElect] (K91 / K91n)	6.717
INSTrument[:SElect] (K92/K93)	6.822
INSTrument:NSElect	6.149
INSTrument:NSElect (K82)	6.610
INSTrument:NSElect (K84)	6.648

Commands of the MMEMory subsystem

MMEMory:CATalog?	6.151
MMEMory:CDIRectory	6.151
MMEMory:CLEar:ALL	6.152
MMEMory:CLEar:STATe	6.152
MMEMory:COMMENT	6.153
MMEMory:COpy	6.153
MMEMory:DATA	6.153
MMEMory:DELeTe	6.154
MMEMory:LOAD:AUTO	6.154

MMEMory:LOAD:IQ:STATe (K91 / K91n)	6.718
MMEMory:LOAD:IQ:STATe (K92/K93)	6.823
MMEMory:LOAD:STATe	6.155
MMEMory:MDIRectory.....	6.155
MMEMory:MOVE	6.155
MMEMory:MSIS.....	6.156
MMEMory:NAME	6.156
MMEMory:NETWork:DISConnect	6.157
MMEMory:NETWork:MAP	6.157
MMEMory:NETWork:UNUSeddrives?	6.158
MMEMory:NETWork:USEDdrives?	6.158
MMEMory:RDIRectory	6.158
MMEMory:SElect[:ITEM]:ALL	6.159
MMEMory:SElect[:ITEM]:DEFault	6.159
MMEMory:SElect[:ITEM]:FINal	6.159
MMEMory:SElect[:ITEM]:HWSettings	6.160
MMEMory:SElect[:ITEM]:LINES:ALL	6.160
MMEMory:SElect[:ITEM]:NONE	6.161
MMEMory:SElect[:ITEM]:SCData.....	6.161
MMEMory:SElect[:ITEM]:TRACe[:ACTive].....	6.161
MMEMory:SElect[:ITEM]:TRANSDucer:ALL	6.161
MMEMory:STORe<1 2>:LIST	6.162
MMEMory:STORe<1 2>:PEAK	6.162
MMEMory:STORe<1 2>:STATe:NEXT	6.163
MMEMory:STORe<1 2>:TRACe.....	6.163
MMEMory:STORe:IQ:STATe (K91 / K91n)	6.718
MMEMory:STORe:IQ:STATe (K92/K93)	6.824

Commands of the OUTPUT subsystem

OUTPut<1 2>:STATe]	6.165
OUTPut<1 2>:IF[:SOURce]	6.165
OUTPut:UPORt[:VALue].....	6.166
OUTPut:UPORt:STATe	6.166

Commands of the READ subsystem

READ<1 2>:PMETer? (K9).....	6.377
-----------------------------	-------

Commands of the SENSE subsystem

[SENSe]:CONFigure:MODE:DUT (K30).....	6.549
[SENSe]:CONFigure:MODE:SYSTem:LOSCillator:FREQuency (K30).....	6.550
[SENSe]:CORRection[:STATe] (K30).....	6.543
[SENSe]:CORRection:ENR[:MEASurement]:TABLe:DATA (K30)	6.544
[SENSe]:CORRection:ENR:MODE (K30).....	6.544
[SENSe]:CORRection:ENR:SPOT (K30).....	6.544
[SENSe]:CORRection:IREJection (K30).....	6.545
[SENSe]:CORRection:LOSS:INPut:MODE (K30).....	6.545
[SENSe]:CORRection:LOSS:INPut:SPOT (K30).....	6.546
[SENSe]:CORRection:LOSS:INPut:TABLe (K30)	6.546
[SENSe]:CORRection:LOSS:OUTPut:MODE (K30)	6.547
[SENSe]:CORRection:LOSS:OUTPut:SPOT (K30)	6.547
[SENSe]:CORRection:LOSS:OUTPut:TABLe (K30)	6.547
[SENSe]:CORRection:TEMPerature (K30).....	6.548

[SENSe]:FREQuency[:CW]:FIXed] (K30)	6.550
[SENSe]:FREQuency:LIST:DATA (K30)	6.550
[SENSe]:FREQuency:STARt (K30)	6.551
[SENSe]:FREQuency:STEP (K30)	6.551
[SENSe]:FREQuency:STOP (K30)	6.552
[SENSe]:SWEep:COUNT (K30)	6.552
[SENSe<1...4>]:SWEep:COUNT	6.657
[SENSe<1 2>]:ATV:CN:BWIDth (K20)	6.481
[SENSe<1 2>]:ATV:CN:CFRelative:NEXT (K20)	6.481
[SENSe<1 2>]:ATV:CN:MEASurement:MODE (K20)	6.482
[SENSe<1 2>]:ATV:CN:POWer:NCORrection (K20)	6.482
[SENSe<1 2>]:ATV:CN:POWer:REFerence:CHANnel:MANual (K20)	6.483
[SENSe<1 2>]:ATV:CN:POWer:REFerence:MANual (K20)	6.483
[SENSe<1 2>]:ATV:CN:POWer:REFerence:MODE (K20)	6.484
[SENSe<1 2>]:ATV:CN:TABLE<1...10>:MFRequencies (K20)	6.484
[SENSe<1 2>]:ATV:CSO:CFRelative:NEXT (K20)	6.485
[SENSe<1 2>]:ATV:CSO:MEASurement:MODE (K20)	6.485
[SENSe<1 2>]:ATV:CSO:POWer:NCORrection (K20)	6.486
[SENSe<1 2>]:ATV:CSO:POWer:REFerence:CHANnel:MANual (K20)	6.486
[SENSe<1 2>]:ATV:CSO:POWer:REFerence:MANual (K20)	6.486
[SENSe<1 2>]:ATV:CSO:POWer:REFerence:MODE (K20)	6.487
[SENSe<1 2>]:ATV:CSO:TABLE<1...10>:MFRequencies (K20)	6.487
[SENSe<1 2>]:ATV:CTB:CFRelative:NEXT (K20)	6.489
[SENSe<1 2>]:ATV:CTB:POWer:NCORrection (K20)	6.489
[SENSe<1 2>]:ATV:CTB:POWer:REFerence:CHANnel:MANual (K20)	6.490
[SENSe<1 2>]:ATV:CTB:POWer:REFerence:MANual (K20)	6.490
[SENSe<1 2>]:ATV:CTB:POWer:REFerence:MODE (K20)	6.490
[SENSe<1 2>]:ATV:CTB:TABLE<1...10>:MFRequencies (K20)	6.491
[SENSe<1 2>]:CORRection:RVELocity	6.492
[SENSe<1 2>]:DDEMod:EQUalizer[:STATe]	6.495
[SENSe<1 2>]:DDEMod:EQUalizer:FREeze[:STATe]	6.495
[SENSe<1 2>]:DDEMod:EQUalizer:RESet	6.496
[SENSe<1 2>]:DDEMod:FILTer:ALPHa	6.496
[SENSe<1 2>]:DDEMod:SBANd	6.496
[SENSe<1 2>]:DDEMod:SRATe	6.497
[SENSe<1 2>]:FREQuency:CHANnel (K20)	6.498
[SENSe<1 2>]:FREQuency:RF (K20)	6.498
[SENSe<1 2>]:SWEep:SPACing (K20)	6.501
[SENSe<1 2>]:TV:MSTandard:FILTer:GDELay	6.502
[SENSe<1 2>]:TV:MSTandard:NAME	6.502
[SENSe<1 2>]:TV:MSTandard:STYPE	6.503
[SENSe<1 2>]:ADEMod:ZOOM[:STATe>] (K7)	6.314
[SENSe<1 2>]:ADEMod:ZOOM[:STATe>] (K8)	6.364
[SENSe<1 2>]:ADEMod:ZOOM:STARt (K7)	6.314
[SENSe<1 2>]:ADEMod:ZOOM:STARt (K8)	6.364
[SENSe<1 2>]:AVERAge[:STATe<1...4>]	6.167
[SENSe<1 2>]:AVERAge:COUNT	6.168
[SENSe<1 2>]:AVERAge:COUNT:AUTO	6.168
[SENSe<1 2>]:AVERAge:TYPE	6.169

[SENSe<1 2>:]BANDwidth BWIDth[:RESolution]	6.170
[SENSe<1 2>:]BANDwidth BWIDth[:RESolution]:AUTO	6.170
[SENSe<1 2>:]BANDwidth BWIDth[:RESolution]:RATio	6.171
[SENSe<1 2>:]BANDwidth BWIDth[:RESolution]:TYPE	6.171
[SENSe<1 2>:]BANDwidth BWIDth:DEMod (K7)	6.315
[SENSe<1 2>:]BANDwidth BWIDth:VIDeo	6.172
[SENSe<1 2>:]BANDwidth BWIDth:VIDeo:AUTO	6.172
[SENSe<1 2>:]BANDwidth BWIDth:VIDeo:RATio	6.173
[SENSe<1 2>:]BANDwidth:VIDeo:TYPE	6.173
[SENSe<1 2>:]CDPower:ANTenna (K72)	6.580
[SENSe<1 2>:]CDPower:ANTenna (K82)	6.611
[SENSe<1 2>:]CDPower:ASEQuence (K72)	6.581
[SENSe<1 2>:]CDPower:AVERage	6.649
[SENSe<1 2>:]CDPower:CODE (K72)	6.581
[SENSe<1 2>:]CDPower:CODE (K82)	6.612
[SENSe<1 2>:]CDPower:CODE (K84)	6.650
[SENSe<1 2>:]CDPower:CTReshold	6.651
[SENSe<1 2>:]CDPower:CTYPE	6.651
[SENSe<1 2>:]CDPower:HSDPamode (K72)	6.581
[SENSe<1 2>:]CDPower:ICTReshold (K72)	6.582
[SENSe<1 2>:]CDPower:ICTReshold (K82)	6.612
[SENSe<1 2>:]CDPower:ICTReshold (K84)	6.650
[SENSe<1 2>:]CDPower:IQLength	6.652
[SENSe<1 2>:]CDPower:IQLength (K82)	6.613
[SENSe<1 2>:]CDPower:IQLength (K84)	6.651
[SENSe<1 2>:]CDPower:LCODE[:VALue] (K72)	6.582
[SENSe<1 2>:]CDPower:LCODE:DVALue (K72)	6.583
[SENSe<1 2>:]CDPower:LCODE:SEARch[:IMMediate] (K72)	6.583
[SENSe<1 2>:]CDPower:LCODE:SEARch:LIST? (K72)	6.583
[SENSe<1 2>:]CDPower:LEVel:ADJust	6.652
[SENSe<1 2>:]CDPower:LEVel:ADJust (K72)	6.584
[SENSe<1 2>:]CDPower:LEVel:ADJust (K82)	6.613
[SENSe<1 2>:]CDPower:MAPPING	6.652
[SENSe<1 2>:]CDPower:MMODE	6.653
[SENSe<1 2>:]CDPower:NORMALize	6.653
[SENSe<1 2>:]CDPower:NORMALize (K72)	6.584
[SENSe<1 2>:]CDPower:NORMALize (K82)	6.613
[SENSe<1 2>:]CDPower:ORDER (K82)	6.614
[SENSe<1 2>:]CDPower:OVERview	6.654
[SENSe<1 2>:]CDPower:PNOFfset (K82)	6.614
[SENSe<1 2>:]CDPower:PNOFfset (K84)	6.654
[SENSe<1 2>:]CDPower:PREFerence (K72)	6.585
[SENSe<1 2>:]CDPower:PREFerence (K82)	6.614
[SENSe<1 2>:]CDPower:QINVert (K72)	6.585
[SENSe<1 2>:]CDPower:QINVert (K82)	6.615
[SENSe<1 2>:]CDPower:QINVert (K84)	6.655
[SENSe<1 2>:]CDPower:RSUMmary (K72)	6.586
[SENSe<1 2>:]CDPower:SBANd (K84)	6.655
[SENSe<1 2>:]CDPower:SFACTor (K82)	6.615
[SENSe<1 2>:]CDPower:SLOT (K72)	6.587
[SENSe<1 2>:]CDPower:SLOT (K82)	6.616
[SENSe<1 2>:]CDPower:SLOT (K84)	6.655
[SENSe<1 2>:]CDPower:STYPE (K72)	6.587
[SENSe<1 2>:]CDPower:TPMeas (K82)	6.616

[SENSe<1 2>:]CORRection[:STATe]	6.174
[SENSe<1 2>:]CORRection:COLLect[:ACQuire]	6.174
[SENSe<1 2>:]CORRection:EGain:INPut[:MAGNitude]	6.175
[SENSe<1 2>:]CORRection:EGain:INPut[:MAGNitude] (K8)	6.363
[SENSe<1 2>:]CORRection:METhod	6.175
[SENSe<1 2>:]CORRection:RECall	6.176
[SENSe<1 2>:]CORRection:TRANsdUcer[:STATe]	6.176
[SENSe<1 2>:]CORRection:TRANsdUcer:ADJust:RLEVel[:STATe]	6.176
[SENSe<1 2>:]CORRection:TRANsdUcer:COMMeNt	6.177
[SENSe<1 2>:]CORRection:TRANsdUcer:DATA	6.177
[SENSe<1 2>:]CORRection:TRANsdUcer:DELeTe	6.178
[SENSe<1 2>:]CORRection:TRANsdUcer:SCALing	6.178
[SENSe<1 2>:]CORRection:TRANsdUcer:SELect	6.178
[SENSe<1 2>:]CORRection:TRANsdUcer:UNIT	6.179
[SENSe<1 2>:]CORRection:TRANsdUcer:VIEW	6.179
[SENSe<1 2>:]DDEMod:FiLTeR:MEASurement (K8)	6.366
[SENSe<1 2>:]DDEMod:SEARch:PULSe[:STATe] (K8)	6.366
[SENSe<1 2>:]DDEMod:SEARch:PULSe:OFFSet (K8)	6.367
[SENSe<1 2>:]DDEMod:SEARch:SYNC[:STATe] (K8)	6.367
[SENSe<1 2>:]DDEMod:SEARch:SYNC:LAP (K8)	6.367
[SENSe<1 2>:]DDEMod:SEARch:SYNC:OFFSet (K8)	6.368
[SENSe<1 2>:]DDEMod:SEARch:TIME (K8)	6.368
[SENSe<1 2>:]DDEMod:SEARch:TIME:AUTO (K8)	6.369
[SENSe<1 2>:]DETEctor<1...6>[:FUNction]	6.180
[SENSe<1 2>:]DETEctor<1...6>[:FUNction]:AUTO	6.180
[SENSe<1 2>:]ESPeCtrum:BWID	6.182
[SENSe<1 2>:]ESPeCtrum:FiLTeR[:RRC][:STATe]	6.182
[SENSe<1 2>:]ESPeCtrum:FiLTeR[:RRC]:ALPHa	6.182
[SENSe<1 2>:]ESPeCtrum:PRESet[:STANdard]	6.183
[SENSe<1 2>:]ESPeCtrum:PRESet:REStoRe	6.183
[SENSe<1 2>:]ESPeCtrum:RANGe<1...20>[:FREQuency]:STARt	6.186
[SENSe<1 2>:]ESPeCtrum:RANGe<1...20>[:FREQuency]:STOP	6.186
[SENSe<1 2>:]ESPeCtrum:RANGe<1...20>:BANDwidth	6.184
[SENSe<1 2>:]ESPeCtrum:RANGe<1...20>:BANDwidth:RESolution	6.184
[SENSe<1 2>:]ESPeCtrum:RANGe<1...20>:BANDwidth:VIDeo	6.185
[SENSe<1 2>:]ESPeCtrum:RANGe<1...20>:COUNt?	6.185
[SENSe<1 2>:]ESPeCtrum:RANGe<1...20>:DELeTe	6.185
[SENSe<1 2>:]ESPeCtrum:RANGe<1...20>:FiLTeR:TYPe	6.186
[SENSe<1 2>:]ESPeCtrum:RANGe<1...20>:INPut:ATTenuation	6.187
[SENSe<1 2>:]ESPeCtrum:RANGe<1...20>:INPut:ATTenuation:AUTO	6.187
[SENSe<1 2>:]ESPeCtrum:RANGe<1...20>:INPut:GAIN:STATe	6.188
[SENSe<1 2>:]ESPeCtrum:RANGe<1...20>:INSert	6.188
[SENSe<1 2>:]ESPeCtrum:RANGe<1...20>:LiMiT:ABSolute:STARt	6.189
[SENSe<1 2>:]ESPeCtrum:RANGe<1...20>:LiMiT:ABSolute:STOP	6.189
[SENSe<1 2>:]ESPeCtrum:RANGe<1...20>:LiMiT:RELative:STARt	6.189
[SENSe<1 2>:]ESPeCtrum:RANGe<1...20>:LiMiT:RELative:STOP	6.190
[SENSe<1 2>:]ESPeCtrum:RANGe<1...20>:LiMiT:STATe	6.190
[SENSe<1 2>:]ESPeCtrum:RANGe<1...20>:RLEVel	6.191
[SENSe<1 2>:]ESPeCtrum:RANGe<1...20>:SWEep:TIME	6.191
[SENSe<1 2>:]ESPeCtrum:RANGe<1...20>:SWEep:TIME:AUTO	6.191
[SENSe<1 2>:]ESPeCtrum:RANGe<1...20>:TRANsdUcer	6.192
[SENSe<1 2>:]ESPeCtrum:RRANGe?	6.192
[SENSe<1 2>:]ESPeCtrum:RTYPE	6.193
[SENSe<1 2>:]ESPeCtrum:StoRe	6.184, 6.617

[SENSe<1 2>:]FILTer:DEMPHasis (K7).....	6.316
[SENSe<1 2>:]FILTer:DEMPHasis:TCONStant (K7).....	6.316
[SENSe<1 2>:]FILTer:HPASs[:STATe] (K7)	6.317
[SENSe<1 2>:]FILTer:HPASs:FREQuency (K7)	6.317
[SENSe<1 2>:]FILTer:LPASs[:STATe] (K7).....	6.317
[SENSe<1 2>:]FILTer:LPASs:FREQuency[:ABSolute] (K7)	6.318
[SENSe<1 2>:]FILTer:LPASs:FREQuency:RELAtive (K7)	6.318
[SENSe<1 2>:]FREQuency:CENTer	6.194
[SENSe<1 2>:]FREQuency:CENTer:STEP	6.194
[SENSe<1 2>:]FREQuency:CENTer:STEP:AUTO	6.195
[SENSe<1 2>:]FREQuency:CENTer:STEP:LINK	6.195
[SENSe<1 2>:]FREQuency:CENTer:STEP:LINK (K7)	6.319
[SENSe<1 2>:]FREQuency:CENTer:STEP:LINK:FACTor	6.196
[SENSe<1 2>:]FREQuency:MODE.....	6.196
[SENSe<1 2>:]FREQuency:OFFSet.....	6.196
[SENSe<1 2>:]FREQuency:SPAN.....	6.197
[SENSe<1 2>:]FREQuency:SPAN:FULL.....	6.197
[SENSe<1 2>:]LIST:POWer[:SEQuence]	6.200
[SENSe<1 2>:]LIST:POWer:RESult?	6.202
[SENSe<1 2>:]LIST:POWer:SET	6.202
[SENSe<1 2>:]LIST:POWer:STATe	6.203
[SENSe<1 2>:]LIST:RANGe<1...20>[:FREQuency]:START.....	6.206
[SENSe<1 2>:]LIST:RANGe<1...20>[:FREQuency]:STOP	6.206
[SENSe<1 2>:]LIST:RANGe<1...20>:BANDwidth	6.204
[SENSe<1 2>:]LIST:RANGe<1...20>:BANDwidth:RESolution	6.204
[SENSe<1 2>:]LIST:RANGe<1...20>:BANDwidth:VIDeo	6.205
[SENSe<1 2>:]LIST:RANGe<1...20>:BREAk.....	6.205
[SENSe<1 2>:]LIST:RANGe<1...20>:COUNT?	6.205
[SENSe<1 2>:]LIST:RANGe<1...20>:DELeTe.....	6.205
[SENSe<1 2>:]LIST:RANGe<1...20>:DETEctor	6.205
[SENSe<1 2>:]LIST:RANGe<1...20>:FILTer:TYPE.....	6.206
[SENSe<1 2>:]LIST:RANGe<1...20>:INPut:ATTenuation	6.206
[SENSe<1 2>:]LIST:RANGe<1...20>:INPut:ATTenuation:AUTO	6.206
[SENSe<1 2>:]LIST:RANGe<1...20>:INPut:GAIN:STATe.....	6.206
[SENSe<1 2>:]LIST:RANGe<1...20>:LIMit:START	6.207
[SENSe<1 2>:]LIST:RANGe<1...20>:LIMit:STATe.....	6.208
[SENSe<1 2>:]LIST:RANGe<1...20>:LIMit:STOP	6.207
[SENSe<1 2>:]LIST:RANGe<1...20>:POINTs	6.207
[SENSe<1 2>:]LIST:RANGe<1...20>:RLEVel.....	6.207
[SENSe<1 2>:]LIST:RANGe<1...20>:SWEep:TIME	6.207
[SENSe<1 2>:]LIST:RANGe<1...20>:SWEep:TIME:AUTO	6.207
[SENSe<1 2>:]LIST:RANGe<1...20>:TRANsducer	6.208
[SENSe<1 2>:]MPOWer[:SEQuence].....	6.210
[SENSe<1 2>:]MPOWer:FTYPE	6.212
[SENSe<1 2>:]MPOWer:RESult[:LIST]?	6.212
[SENSe<1 2>:]MPOWer:RESult:MIN?	6.212
[SENSe<1 2>:]PMETer[:STATe] (K9).....	6.378
[SENSe<1 2>:]PMETer:FREQuency (K9)	6.379
[SENSe<1 2>:]PMETer:FREQuency:LINK (K9)	6.379
[SENSe<1 2>:]PMETer:MTIME (K9).....	6.379
[SENSe<1 2>:]PMETer:MTIME:AVERAge[:STATe]	6.380
[SENSe<1 2>:]PMETer:MTIME:AVERAge:COUNT	6.380
[SENSe<1 2>:]PMETer:ROFFset[:STATe] (K9).....	6.381
[SENSe<1 2>:]PMETer:TRIGger:LEVel (K9)	6.381
[SENSe<1 2>:]PMETer:TRIGger:STATe (K9).....	6.381

[SENSe<1 2>:]POWer:ACHannel:ACPairs	6.214
[SENSe<1 2>:]POWer:ACHannel:BANDwidth BWIDth[:CHANnel]	6.215
[SENSe<1 2>:]POWer:ACHannel:BANDwidth BWIDth:ACHannel	6.215
[SENSe<1 2>:]POWer:ACHannel:BANDwidth BWIDth:ALTErnate<1...11>	6.215
[SENSe<1 2>:]POWer:ACHannel:MODE	6.216
[SENSe<1 2>:]POWer:ACHannel:PRESet	6.216
[SENSe<1 2>:]POWer:ACHannel:PRESet:RLEVel	6.217
[SENSe<1 2>:]POWer:ACHannel:REFerence:AUTO	6.217
[SENSe<1 2>:]POWer:ACHannel:REFerence:TXCHannel:AUTO	6.218
[SENSe<1 2>:]POWer:ACHannel:REFerence:TXCHannel:MANual	6.218
[SENSe<1 2>:]POWer:ACHannel:SPACing:ALTErnate<1...11>	6.219
[SENSe<1 2>:]POWer:ACHannel:SPACing:CHANnel<1...11>	6.219
[SENSe<1 2>:]POWer:ACHannel:TXCHannel:COUNT	6.220
[SENSe<1 2>:]POWer:BANDwidth BWIDth	6.220
[SENSe<1 2>:]POWer:HSPeed	6.221
[SENSe<1 2>:]POWer:TRACe	6.221
[SENSe<1 2>:]ROSCillator:SOURce	6.222
[SENSe<1 2>:]SWEep:COUNT	6.223
[SENSe<1 2>:]SWEep:COUNT:CURRent?	6.223
[SENSe<1 2>:]SWEep:EGATe	6.224
[SENSe<1 2>:]SWEep:EGATe:HOLDoff	6.225
[SENSe<1 2>:]SWEep:EGATe:LENGth	6.225
[SENSe<1 2>:]SWEep:EGATe:POLarity	6.225
[SENSe<1 2>:]SWEep:EGATe:SOURce	6.226
[SENSe<1 2>:]SWEep:EGATe:TYPE	6.226
[SENSe<1 2>:]SWEep:MODE	6.226
[SENSe<1 2>:]SWEep:POINts	6.227
[SENSe<1 2>:]SWEep:TIME	6.227
[SENSe<1 2>:]SWEep:TIME (K7)	6.320
[SENSe<1 2>:]SWEep:TIME:AUTO	6.228
[SENSe<1 2>:]TV:TILT:MSTandard:CDISable (K20)	6.503
[SENSe<1 2>:]TV:TILT:MSTandard:CENable (K20)	6.503
[SENSe:]ADEMod[:STATe] (K7)	6.294
[SENSe:]ADEMod:AF:CENTer (K7)	6.295
[SENSe:]ADEMod:AF:COUPling (K7)	6.295
[SENSe:]ADEMod:AF:SPAN (K7)	6.296
[SENSe:]ADEMod:AF:SPAN:FULL (K7)	6.296
[SENSe:]ADEMod:AF:STARt (K7)	6.297
[SENSe:]ADEMod:AF:STOP (K7)	6.297
[SENSe:]ADEMod:AM[:TDOMain][:TYPE] (K7)	6.298
[SENSe:]ADEMod:AM[:TDOMain]:RESult? (K7)	6.298
[SENSe:]ADEMod:AM:RELative[:TDOMain][:TYPE] (K7)	6.299
[SENSe:]ADEMod:AM:RELative[:TDOMain]:RESult? (K7)	6.299
[SENSe:]ADEMod:AM:RELative:AFSPectrum[:TYPE] (K7)	6.300
[SENSe:]ADEMod:AM:RELative:AFSPectrum:RESult? (K7)	6.301
[SENSe:]ADEMod:BANDwidth BWIDth:DEModulation (K7)	6.302
[SENSe:]ADEMod:FM[:TDOMain][:TYPE] (K7)	6.302
[SENSe:]ADEMod:FM[:TDOMain]:RESult? (K7)	6.302
[SENSe:]ADEMod:FM:AFSPectrum[:TYPE] (K7)	6.303
[SENSe:]ADEMod:FM:AFSPectrum:RESult? (K7)	6.304
[SENSe:]ADEMod:FM:OFFSet? (K7)	6.305
[SENSe:]ADEMod:MTIME (K7)	6.306
[SENSe:]ADEMod:PM[:TDOMain][:TYPE] (K7)	6.306
[SENSe:]ADEMod:PM[:TDOMain]:RESult? (K7)	6.306

[SENSe:]ADEMod:PM:AFSPectrum[:TYPE] (K7).....	6.307
[SENSe:]ADEMod:PM:AFSPectrum:RESult? (K7).....	6.308
[SENSe:]ADEMod:PM:RPOint[:X] (K7).....	6.309
[SENSe:]ADEMod:RLENgth? (K7).....	6.309
[SENSe:]ADEMod:SET (K7).....	6.309
[SENSe:]ADEMod:SPEctrum[:TYPE] (K7).....	6.311
[SENSe:]ADEMod:SPEctrum:BANDwidth BWIDth[:RESolution] (K7).....	6.311
[SENSe:]ADEMod:SPEctrum:RESult? (K7).....	6.312
[SENSe:]ADEMod:SPEctrum:SPAN:ZOOM (K7).....	6.313
[SENSe:]ADEMod:SRATe? (K7).....	6.313
[SENSe:]BANDwidth:CHANnel (K92/K93).....	6.826
[SENSe:]BURSt:COUNT (K91 / K91n).....	6.721
[SENSe:]BURSt:COUNT (K92/K93).....	6.826
[SENSe:]BURSt:COUNT:STATe (K91 / K91n).....	6.721
[SENSe:]BURSt:COUNT:STATe (K92/K93).....	6.827
[SENSe:]DEMod:BANalyze:DURation:EQUal (K91 / K91n).....	6.721
[SENSe:]DEMod:BANalyze:DURation:MAX (K91 / K91n).....	6.722
[SENSe:]DEMod:BANalyze:DURation:MIN (K91 / K91n).....	6.722
[SENSe:]DEMod:CEStimation (K91 / K91n).....	6.723
[SENSe:]DEMod:CEStimation (K92/K93).....	6.827
[SENSe:]DEMod:FiLTER:CATalog? (K91 / K91n).....	6.723
[SENSe:]DEMod:FiLTER:CATalog? (K92/K93).....	6.828
[SENSe:]DEMod:FiLTER:MODulation (K91 / K91n).....	6.723
[SENSe:]DEMod:FiLTER:MODulation (K92/K93).....	6.828
[SENSe:]DEMod:FORMat[:BContent]:AUTo (K91 / K91n).....	6.724
[SENSe:]DEMod:FORMat[:BContent]:AUTo (K92/K93).....	6.828
[SENSe:]DEMod:FORMat:BANalyze (K91 / K91n).....	6.724
[SENSe:]DEMod:FORMat:BANalyze (K92/K93).....	6.829
[SENSe:]DEMod:FORMat:BANalyze:BTYPe (K91 / K91n).....	6.725
[SENSe:]DEMod:FORMat:BANalyze:DBYTes:EQUal (K91 / K91n).....	6.725
[SENSe:]DEMod:FORMat:BANalyze:DBYTes:MAX (K91 / K91n).....	6.726
[SENSe:]DEMod:FORMat:BANalyze:DBYTes:MIN (K91 / K91n).....	6.726
[SENSe:]DEMod:FORMat:BANalyze:SYMBols:EQUal (K91 / K91n).....	6.726
[SENSe:]DEMod:FORMat:BANalyze:SYMBols:EQUal (K92/K93).....	6.829
[SENSe:]DEMod:FORMat:BANalyze:SYMBols:MAX (K91 / K91n).....	6.727
[SENSe:]DEMod:FORMat:BANalyze:SYMBols:MAX (K92/K93).....	6.830
[SENSe:]DEMod:FORMat:BANalyze:SYMBols:MIN (K91 / K91n).....	6.727
[SENSe:]DEMod:FORMat:BANalyze:SYMBols:MIN (K92/K93).....	6.830
[SENSe:]DEMod:FORMat:BTRate (K91 / K91n).....	6.728
[SENSe:]DEMod:FORMat:SIGSymbol (K91 / K91n).....	6.728
[SENSe:]POWEr:ACHannel:ACPairs (K92/K93).....	6.831
[SENSe:]POWEr:ACHannel:MODE (K91 / K91n).....	6.729
[SENSe:]POWEr:ACHannel:MODE (K92/K93).....	6.833
[SENSe:]POWEr:NCORrection (K92/K93).....	6.834
[SENSe:]POWEr:SEM:MODE (K93).....	6.834
[SENSe:]SWAPiQ (K91 / K91n).....	6.729
[SENSe:]SWAPiQ (K92/K93).....	6.836
[SENSe:]SWEep:ACPR:TIME (K92/K93).....	6.836
[SENSe:]SWEep:ACPR:TIME:AUTO.....	6.837
[SENSe:]SWEep:COUNT (K91 / K91n).....	6.729
[SENSe:]SWEep:COUNT (K92/K93).....	6.837
[SENSe:]SWEep:EGATe:HOLDoff[:TIME] (K91 / K91n).....	6.730
[SENSe:]SWEep:EGATe:HOLDoff[:TIME] (K92/K93).....	6.838

[SENSe:]SWEep:EGATe:HOLDoff:SAMPle (K91 / K91n).....	6.730
[SENSe:]SWEep:EGATe:HOLDoff:SAMPle (K92/K93).....	6.838
[SENSe:]SWEep:EGATe:LENGth[:TIME] (K91 / K91n).....	6.731
[SENSe:]SWEep:EGATe:LENGth[:TIME] (K92/K93).....	6.838
[SENSe:]SWEep:EGATe:LENGth:SAMPle (K91 / K91n).....	6.731
[SENSe:]SWEep:EGATe:LENGth:SAMPle (K92/K93).....	6.839
[SENSe:]SWEep:EGATe:LINK (K91 / K91n).....	6.731
[SENSe:]SWEep:EGATe:LINK (K92/K93).....	6.839
[SENSe:]SWEep:TIME (K91 / K91n).....	6.732
[SENSe:]SWEep:TIME (K92/K93).....	6.839
[SENSe:]TRACking:LEVel (K91 / K91n).....	6.732
[SENSe:]TRACking:LEVel (K92/K93).....	6.839
[SENSe:]TRACking:PHASe (K91 / K91n).....	6.732
[SENSe:]TRACking:PHASe (K92/K93).....	6.840
[SENSe:]TRACking:TIME (K91 / K91n).....	6.732
[SENSe:]TRACking:TIME (K92/K93).....	6.841

Commands of the SOURce subsystem

SETup:TV:STANdard	6.505
SETup:TV:STANdard:AUDio	6.505
SETup:TV:STANdard:COLor.....	6.506

Commands of the SOURce subsystem

SOURce<1 2>:EXTernal<1 2>:ROSCillator[:SOURce]	6.229
SOURce<1 2>:POWER[:LEVel][:IMMEDIATE][:AMPLitude].....	6.230
SOURce<1 2>:POWER[:LEVel][:IMMEDIATE]:OFFSet.....	6.230
SOURce:TEMPerature:APRobe?.....	6.229

Commands of the STATus subsystem

STATus:ERRor	6.249
STATus:OPERation[:EVENT]?	6.231
STATus:OPERation:CONDition?.....	6.231
STATus:OPERation:ENABle	6.232
STATus:OPERation:NTRansition	6.232
STATus:OPERation:PTRansition	6.232
STATus:PRESet	6.233
STATus:QUEStionable:CORRection[:EVENT]? (K30)	6.553
STATus:QUEStionable:CORRection:CONDition? (K30).....	6.553
STATus:QUEStionable:CORRection:ENABle (K30)	6.554
STATus:QUEStionable:CORRection:NTRansition (K30).....	6.554
STATus:QUEStionable:CORRection:PTRansition (K30)	6.555
STATus:QUEStionable[:EVENT]?	6.234
STATus:QUEStionable:ACPLimit[:EVENT]?	6.236
STATus:QUEStionable:ACPLimit:CONDition?	6.236
STATus:QUEStionable:ACPLimit:ENABle	6.236
STATus:QUEStionable:ACPLimit:NTRansition	6.237
STATus:QUEStionable:ACPLimit:PTRansition	6.237
STATus:QUEStionable:CONDition?	6.234
STATus:QUEStionable:ENABle	6.235
STATus:QUEStionable:FREQuency[:EVENT]?.....	6.237
STATus:QUEStionable:FREQuency:CONDition?	6.238
STATus:QUEStionable:FREQuency:ENABle	6.238
STATus:QUEStionable:FREQuency:NTRansition.....	6.238
STATus:QUEStionable:FREQuency:NTRansition (K30).....	6.555
STATus:QUEStionable:FREQuency:PTRansition.....	6.239

STATus:QUESTionable:FREQuency:PTRansition (K30).....	6.556
STATus:QUESTionable:LIMit<1 2> [:EVENT]?	6.239
STATus:QUESTionable:LIMit<1 2>:CONDition?	6.239
STATus:QUESTionable:LIMit<1 2>:ENABle.....	6.240
STATus:QUESTionable:LIMit<1 2>:NTRansition	6.240
STATus:QUESTionable:LIMit<1 2>:NTRansition (K30)	6.556
STATus:QUESTionable:LIMit<1 2>:PTRansition	6.240
STATus:QUESTionable:LIMit<1 2>:PTRansition (K30).....	6.557
STATus:QUESTionable:LMARgin<1 2>[:EVENT]?	6.241
STATus:QUESTionable:LMARgin<1 2>:CONDition?	6.241
STATus:QUESTionable:LMARgin<1 2>:ENABle.....	6.241
STATus:QUESTionable:LMARgin<1 2>:NTRansition	6.241
STATus:QUESTionable:LMARgin<1 2>:PTRansition	6.242
STATus:QUESTionable:NTRansition	6.235
STATus:QUESTionable:POWEr[:EVENT]?	6.242
STATus:QUESTionable:POWEr:CONDition?.....	6.242
STATus:QUESTionable:POWEr:ENABle	6.243
STATus:QUESTionable:POWEr:NTRansition	6.243
STATus:QUESTionable:POWEr:PTRansition	6.243
STATus:QUESTionable:PTRansition	6.235
STATus:QUESTionable:SYNC[:EVENT]?	6.244
STATus:QUESTionable:SYNC[:EVENT]? (K91 / K91n).....	6.736
STATus:QUESTionable:SYNC[:EVENT]? (K92/K93).....	6.843
STATus:QUESTionable:SYNC:CONDition?.....	6.244
STATus:QUESTionable:SYNC:CONDition? (K91 / K91n).....	6.736
STATus:QUESTionable:SYNC:CONDition? (K92/K93).....	6.843
STATus:QUESTionable:SYNC:ENABle	6.244
STATus:QUESTionable:SYNC:ENABle (K91 / K91n).....	6.736
STATus:QUESTionable:SYNC:ENABle (K92/K93).....	6.844
STATus:QUESTionable:SYNC:NTRansition	6.245
STATus:QUESTionable:SYNC:NTRansition (K91 / K91n).....	6.737
STATus:QUESTionable:SYNC:NTRansition (K92/K93).....	6.844
STATus:QUESTionable:SYNC:PTRansition	6.245
STATus:QUESTionable:SYNC:PTRansition (K91 / K91n).....	6.737
STATus:QUESTionable:SYNC:PTRansition (K92/K93).....	6.844
STATus:QUEEue.....	6.236

Commands of the SYSTem subsystem

SYSTem:COMMunicate:GPIB[:SELf]:ADDRess	6.246
SYSTem:COMMunicate:GPIB[:SELf]:RTERminator.....	6.247
SYSTem:COMMunicate:PRINter:ENUMerate:FIRSt?	6.247
SYSTem:COMMunicate:PRINter:ENUMerate:NEXt?	6.247
SYSTem:COMMunicate:PRINter:SElect <1 2>	6.248
SYSTem:CONFigure:DUT:GAIN (K30)	6.558
SYSTem:CONFigure:DUT:STIME (K30)	6.558
SYSTem:DATE	6.248
SYSTem:DISPlay:FPANel	6.248
SYSTem:DISPlay:UPDate	6.249
SYSTem:ERRor:CLEar:ALL	6.250
SYSTem:ERRor:LIST?	6.250
SYSTem:FIRMware:UPDate	6.250
SYSTem:FORMat:IDENT	6.251
SYSTem:LANGuage.....	6.251
SYSTem:LXI:INFo?	6.251
SYSTem:LXI:LANReset.....	6.252
SYSTem:LXI:MDEscription	6.252
SYSTem:LXI:PASSword.....	6.252
SYSTem:PASSword[:CENable].....	6.253

SYSTem:PASSword:RESet].....	6.253
SYSTem:PRESet.....	6.253
SYSTem:SPEaker:VOLume.....	6.255
SYSTem:TIME.....	6.254
SYSTem:VERSion?.....	6.254

Commands of the TRACe subsystem

TRACe[:DATA] (K91 / K91n).....	6.742
TRACe[:DATA] (K92/K93).....	6.854
TRACe<1 2>[:DATA].....	6.256, 6.512, 6.659
TRACe<1 2>[:DATA] (K7).....	6.321
TRACe<1 2>[:DATA] (K72).....	6.591
TRACe<1 2>[:DATA]? LIST.....	6.658
TRACe<1 2>:IQ[:STATE].....	6.264
TRACe<1 2>:IQ:AVERAge[:STATE].....	6.265
TRACe<1 2>:IQ:AVERAge:COUNT.....	6.265
TRACe<1 2>:IQ:DATA?.....	6.265
TRACe<1 2>:IQ:DATA:MEMory?.....	6.267
TRACe<1 2>:IQ:SET.....	6.268
TRACe<1 2>:IQ:SRATe 15.625kHz to 32MHz.....	6.269
TRACe<1<2>[:DATA] (K82).....	6.618
TRACe:COPIY.....	6.257
TRACe:COPIY (K20).....	6.512
TRACe:IQ:SRATe (K91 / K91n).....	6.743
TRACe:IQ:SRATe (K92/K93).....	6.854
TRACe1:DATA? SPECTrogram (K14).....	6.405

Commands of the TRIGger subsystem

TRIGger[:SEQuence]:HOLDoff (K91 / K91n).....	6.744
TRIGger[:SEQuence]:HOLDoff (K92/K93).....	6.856
TRIGger[:SEQuence]:LEVel:POWer (K91 / K91n).....	6.745
TRIGger[:SEQuence]:LEVel:POWer (K92/K93).....	6.857
TRIGger[:SEQuence]:LEVel:POWer:AUTO (K91 / K91n).....	6.745
TRIGger[:SEQuence]:LEVel:POWer:AUTO (K92/K93).....	6.857
TRIGger[:SEQuence]:MODE (K91 / K91n).....	6.744
TRIGger[:SEQuence]:MODE (K92/K93).....	6.857
TRIGger<1 2>[:SEQuence]:LEVel[:EXTernal].....	6.272
TRIGger<1 2>[:SEQuence]:HOLDoff.....	6.270
TRIGger<1 2>[:SEQuence]:IFPower:HOLDoff.....	6.270
TRIGger<1 2>[:SEQuence]:IFPower:HYSteresis.....	6.271
TRIGger<1 2>[:SEQuence]:LEVel:AM[:ABSolute] (K7).....	6.322
TRIGger<1 2>[:SEQuence]:LEVel:AM:RELative (K7).....	6.322
TRIGger<1 2>[:SEQuence]:LEVel:FM (K7).....	6.323
TRIGger<1 2>[:SEQuence]:LEVel:IFPower.....	6.271
TRIGger<1 2>[:SEQuence]:LEVel:PM (K7).....	6.323
TRIGger<1 2>[:SEQuence]:LEVel:VIDeo.....	6.272
TRIGger<1 2>[:SEQuence]:SLOPe.....	6.272
TRIGger<1 2>[:SEQuence]:SOURce.....	6.272
TRIGger<1 2>[:SEQuence]:SOURce (K7).....	6.323
TRIGger<1 2>[:SEQuence]:SOURce (K72).....	6.593
TRIGger<1 2>[:SEQuence]:TIME:RINTerval.....	6.273
TRIGger<1 2>[:SEQuence]:VIDeo:BFIEld[:NUMBer].....	6.513
TRIGger<1 2>[:SEQuence]:VIDeo:BLINe[:NUMBer].....	6.513
TRIGger<1 2>[:SEQuence]:VIDeo:BLINe:TYPE.....	6.514
TRIGger<1 2>[:SEQuence]:VIDeo:CONTinuous.....	6.273
TRIGger<1 2>[:SEQuence]:VIDeo:FIELd:NUMBer (K20).....	6.514
TRIGger<1 2>[:SEQuence]:VIDeo:FIELd:SElect.....	6.274

TRIGger<1 2>[:SEQuence]:VIDeo:FORMat:LPFRame.....	6.274
TRIGger<1 2>[:SEQuence]:VIDeo:LINE:NUMBer.....	6.274, 6.514
TRIGger<1 2>[:SEQuence]:VIDeo:QFieLd[:NUMBer].....	6.515
TRIGger<1 2>[:SEQuence]:VIDeo:QLINe[:NUMBer].....	6.515
TRIGger<1 2>[:SEQuence]:VIDeo:SSIGnal:POLarity.....	6.275

Commands of the UNIT subsystem

UNIT<1 2>:PMETer:POWer (K9).....	6.383
UNIT<1 2>:PMETer:POWer:RATio (K9).....	6.383
UNIT<1 2>:POWer.....	6.276
UNIT<1 2>:POWer (K20).....	6.516
UNIT:ANGLE (K7).....	6.324
UNIT:EVM (K91 / K91n).....	6.746
UNIT:EVM (K92/K93).....	6.859
UNIT:GIMBalance (K91 / K91n).....	6.746
UNIT:PREamble (K91 / K91n).....	6.747
UNIT:PREamble (K92/K93).....	6.859
UNIT:TABLE (K92/K93).....	6.860

Index

- *
 - * (enhancement label).....4.37
- 1**
 - 1xEV-DO BTS Analyzer mode (K84).....4.121
- 3**
 - 3G FDD BTS mode (K72).....4.121
- A**
 - abbreviations
 - 3GPP Base Station measurements (K72)
 -4.260
 - cable TV terms (K20).....4.200
 - CDMA2000 BTS Analyzer (K82).....4.291
 - WiMAX measurements (K92/K93).....2.144
 - WiMAX, WiBro measurements (K93)2.153
 - absolute grant channel (K72).....4.261
 - Active Channels (K82).....4.312
 - addressed command.....5.33
 - adjacent-channel power
 - number of channels4.89
 - Adjacent-Channel Power measurement (K8)
 -4.152
 - adjustment
 - attenuation (K20).....4.199
 - AF trigger (K7).....4.133
 - alias power (K82).....4.308, 4.314
 - AM demodulation.....4.55
 - AM modulation depth.....4.86
 - amplifier measurement (K30).....2.101
 - amplitude imbalance (K20).....2.66
 - amplitude menu
 - base unit.....4.13
 - K20 option.....4.216
 - K7 option.....4.143
 - K72 option.....4.267
 - K8 option.....4.163
 - K82 option.....4.322
 - K84 option.....4.375
 - K91/K91n option.....4.397
 - K92/K93 option.....4.431
 - AMPT key.....4.13
 - analog demodulation
 - AF trigger (K7).....4.133
 - bandwidth (K7).....4.133
 - circuit description (K7).....4.132
 - measurement results (K7).....4.133
 - measurement time (K7).....4.134
 - sample rate (K7).....4.134
 - trigger offset (K7).....4.134
 - analog demodulation menu (K7).... 4.131, 4.134
 - Analog Demodulation mode (K7).....4.120
 - analog TV basics (K20).....2.44
 - Analog TV Settings dialog box (K20).....4.227
 - analysis of measurement variables (K93) .2.155
 - analysis steps (K92/K93).....2.148
 - antenna gain (K8).....4.159
 - APICH.....4.291
 - ASCII #.....5.10
 - ASCII file export.....4.46
 - ATDPCH.....4.291
 - attenuation
 - adjustment (K20).....4.199
 - automatic.....4.15
 - manual.....4.15, 6.146
 - auto level detection
 - K92/K93 option.....2.143
 - Auto Peak detector.....4.38
 - Average detector.....4.38
 - average or peak values (K8).....2.41
 - Average trace mode.....4.36
 - averaging
 - continuous sweep.....4.37
 - single sweep.....4.37
 - sweep count.....4.37
 - AWGN noise (K20).....2.67
- B**
 - bandwidth
 - K8 option.....2.39
 - occupied.....4.72
 - occupied (K20).....2.86
 - resolution.....4.20
 - resolution (K7).....4.146
 - video.....4.20
 - bandwidth menu
 - base unit.....4.20
 - K7 option.....4.145
 - K8 option.....4.165
 - K82 option.....4.323
 - K84 option.....4.376
 - base station measurements (K72).....2.106
 - base station measurements (K82).....2.114
 - base station tests
 - basic settings (K72).....2.113
 - test setup (K72).....2.112
 - test setup (K82).....2.126
 - BCH.....4.291

BD_ADDR (K8).....	4.160
Bit Reverse Code Order (K82).....	4.305
Bitstream (K84).....	4.369
Blank trace mode.....	4.37
block data	5.9
Bluetooth device address (K8).....	4.160
Bluetooth measurement	
average or peak values (K8).....	2.41
bandwidths (K8)	2.39
data packet structure (K8).....	2.36
filter (K8).....	2.40
functional description (K8).....	2.39
oversampling (K8).....	2.40
supported tests (K8).....	2.37
transmitter tests (K8).....	2.37
trigger concept (K8).....	2.42
Bluetooth menu (K8).....	4.149, 4.157
Bluetooth mode (K8).....	4.121
menus	4.149
Boolean parameter	5.9
BTS (K72).....	4.260
BW key	4.17
C	
C/N Setup dialog box (K20).....	4.223
Cable TV Analyzer menu (K20).....	4.192, 4.211
Cable TV Analyzer mode (K20).....	4.121
menus	4.192
cable TV measurement	
analog TV basics (K20).....	2.44
analog TV measurement examples (K20).....	2.46
analog TV settings (K20).....	2.46
analog TV test setup (K20)	2.47
APD - digital TV (K20).....	4.209
APD (K20).....	2.77
C/N - analog TV (K20).....	4.202
Carriers - analog TV (K20).....	4.201
Carriers (K20).....	2.49
CCDF - digital TV (K20).....	4.210
CCDF (K20)	2.78
Channel Power - digital TV (K20).....	4.209
Channel Power (K20).....	2.76
Constellation Diagram - digital TV (K20).....	4.207
Constellation Diagram (K20).....	2.72
CSO - analog TV (K20).....	4.203
CTB - analog TV (K20).....	4.204
digital TV basics (K20)	2.62
digital TV measurement examples (K20).....	2.68
digital TV settings (K20).....	2.68
digital TV test setup (K20).....	2.69
display labels (K20).....	4.200
Echo Pattern - digital TV (K20)	4.208
Echo Pattern (K20).....	2.75
Hum - analog TV (K20).....	4.206
Hum (K20).....	2.52
measurement overview (K20).....	2.44
measurement with channel table (K20)	2.95
measurement without channel table (K20)	
.....	2.93
Modulation Errors - digital TV (K20).....	4.208
Modulation Errors (K20)	2.73
Overview - digital TV (K20).....	4.207
Overview (K20).....	2.70
Spectrum - analog TV (K20).....	4.201
Spectrum - digital TV (K20).....	4.206
Spectrum (K20)	2.48, 2.69
status bar information (K20).....	4.198
Tilt - TV analyzer (K20).....	4.210
Tilt (K20).....	2.79
TV analyzer measurement examples (K20)	
.....	2.79
Video Scope - analog TV (K20).....	4.205
Video Scope (K20)	2.50
Vision Modulation - analog TV (K20).....	4.205
Vision Modulation (K20)	2.51
with channel table (K20).....	4.197
without channel table (K20).....	4.197
CACH	4.291
calibration	
transmission measurement.....	4.129
calibration (K30).....	2.100, 4.236
Carr Freq Error (K82).....	4.311
Carrier Frequency Drift measurement (K8)	
.....	4.154
carrier frequency error (K20).....	2.67
Carrier Frequency Stability and Modulation	
Accuracy measurement (K8).....	4.156
carrier suppression	2.67
CATV network (K20).....	2.80
CCCH.....	4.291
CCIR 473-4	4.33
CDEP	4.291
CDMA2000 BTS Analyzer mode (K82).....	4.121
CDP.....	4.291
center frequency	4.7
K8 option	4.158
step size	4.8
channel	
active (K72)	4.265
active (K82)	4.301
active (K84)	4.355
bandwidth	4.88, 4.90, 4.95
inactive (K82).....	4.301
inactive (K84).....	4.355
K20 option	2.81
number	4.89
spacing	4.90
threshold (K82).....	4.301
threshold (K84).....	4.355
channel (K72).....	4.261
channel assignment table (K72)	4.272
parameters	4.272
Channel Bitstream (K82).....	4.318
Channel Constell (K82).....	4.316
channel estimation (K93)	2.155
channel filter, list of	4.18
channel number (K8)	4.158
Channel Power Rel / Abs (K82)	4.312

- Channel Results (K84).....4.365
 - channel results (K92/K93)2.148
 - channel table
 - result display(K82).....4.309
 - channel table (K20).....2.80, 4.198
 - creating2.87
 - default2.93
 - measurement with channel table2.95
 - measurement without channel table2.93
 - channel table (K82)
 - Add Channel4.303
 - auto search4.300
 - Cancel4.304
 - Copy4.301
 - Delete4.301
 - delete channel.....4.303
 - Edit4.302
 - Meas4.303
 - name4.301
 - New4.301
 - predefined4.300
 - Reload4.304
 - Restore default channel tables.....4.304
 - Save4.304
 - Sort.....4.304
 - channel table (K84)
 - Add Channel4.356
 - auto search4.355
 - Cancel4.357
 - Copy4.357
 - Delete4.357
 - delete channel.....4.356
 - Edit4.358
 - Meas4.356
 - name4.355
 - New4.355
 - predefined4.355
 - Reload4.357
 - Restore default channel tables.....4.359
 - Save4.357
 - Sort.....4.356
 - Channel Table (K84).....4.368
 - Channel Table dialog box (K20)4.194
 - Channel Table Settings (K84).....4.354
 - Channel Table Settings dialog (K82)4.300
 - Channel Tables dialog box (K20)4.198
 - channel width (K20)2.80
 - characters
 - special6.3
 - Chip Rate Error (K82)4.311
 - CINR (K92/K93).....2.151
 - CINR (K93)2.156
 - Clear Write trace mode.....4.36
 - clock offset (K92/K93)2.149
 - Code Domain Analyzer menu (K82)4.282
 - Code Domain Error (K82)4.314
 - Code Domain Error (K84)4.370
 - Code Domain Power (K82).....4.308
 - Code Domain Power (K84).....4.363
 - colon.....5.10
 - comma5.10
 - command
 - # 5.10
 - addressed.....5.33
 - colon5.10
 - comma.....5.10
 - description6.2
 - header5.5
 - line5.7
 - long form5.6
 - overlapping execution.....5.12
 - programming examples.....7.1
 - query.....5.8
 - question mark5.8, 5.10
 - quotation mark.....5.10
 - recognition5.11
 - sequence5.12
 - short form5.6
 - structure.....5.5
 - suffix5.7
 - syntax elements.....5.10
 - universal5.32
 - white space.....5.10
 - common commands6.6
 - common pilot channel (K72)4.260
 - Composite Constellation (K82)4.317
 - Composite Constellation (K84)4.371
 - Composite EVM4.291, 4.367
 - Composite EVM (K82)4.312, 4.315
 - CONDition register part.....5.13
 - continuous sweep4.23
 - control
 - output level4.128
 - coupling
 - resolution bandwidth.....4.20
 - sweep time4.21
 - video bandwidth.....4.21
 - CPCCH4.291
 - CPICH (K72)4.260
 - Crest factor4.291
 - CSO Setup dialog box (K20)4.225
 - CTB Setup dialog box (K20)4.226
- D**
- data packet
 - structure (k8)2.36
 - DCL5.11
 - dedicated physical channel (K72)4.261
 - default scalings of x- and y-axis4.97
 - definition of transducer factors7.20
 - delay
 - gate signal4.32
 - delimitter.....5.11
 - delta marker4.48
 - Demod Settings (K84).....4.352
 - Demod Settings dialog (K82)4.297
 - Demod Settings dialog box
 - K91/K91n option4.398

K92/K93 option.....	4.432
demodulation bandwidth (K7).....	4.133
detector	
Auto Peak.....	4.41
auto select.....	4.41
Average.....	4.42
IF overload (K20).....	4.199
Negative Peak.....	4.42
Positive Peak.....	4.41
Quasi Peak.....	4.42
RF overload (K20).....	4.199
RMS.....	4.42
Sample.....	4.42
detector overview.....	4.38
dialog	
Channel Table Settings (K84).....	4.354
Demod Settings (K84).....	4.352
Frontend Settings (K84).....	4.350
IQ Capture Settings (K84).....	4.351
Result Settings (K84).....	4.359
dialog box	
Edit Power Classes (remote control).....	6.45
Differential Phase Encoding measurement (K8)	
.....	4.157
digital TV basics (K20).....	2.62
Digital TV Settings dialog box (K20).....	4.231
direct measurement (K30).....	2.99, 4.250
display lines.....	4.115, 4.119
display range	
frequency.....	4.7
level.....	4.14
echo (K20).....	2.74
Edit Limit Line dialog box.....	4.112, 4.114
ENABLE register part.....	5.14
ENR dialog box (K30).....	4.245
EOI (command line).....	5.7
equalization (K93).....	2.155
equalizer (K20).....	2.64
equipment under test (K8).....	4.160
error messages.....	9.1
3GPP Base Station measurements (K72).....	9.9
device-specific.....	9.7
noise figure measurements (K30).....	9.8
SCPI-specific.....	9.1
WiMAX, WiBro measurements (K92/K93)	
.....	9.11
WLAN TX measurements (K91).....	9.10
error queue query.....	5.25
error reporting	
K30 option.....	5.35
K91 option.....	5.40
K92/K93 option.....	5.42
error variable - iberr.....	5.30
ESE (event status enable register).....	5.17
ESR (event status register).....	5.17
EUT (K8).....	4.160
EVENT register part.....	5.14
event status enable register (ESE).....	5.17
event status register (ESR).....	5.17
EVM (K20).....	2.67
EVM (K92/K93).....	2.149
EVM (K93).....	2.155
EVM vs Symbol (K82).....	4.316
EVM vs Symbol (K84).....	4.371
external trigger.....	4.28
F	
FDD (K72).....	4.260
filter	
K8 option.....	2.40
root raised cosine (K20).....	2.64
RX (K20).....	2.64
TX (K20).....	2.64
fixed reference.....	4.54
FM demodulation.....	4.55
FREQ key.....	4.5
frequency	
axis.....	4.5
band (K8).....	4.158
center.....	4.7
line.....	4.119
offset.....	4.9
power meter.....	4.177
specify frequency axis.....	4.5
start.....	4.7
stop.....	4.7
frequency menu	
base unit.....	4.6
K20 option.....	4.214
K30 option.....	4.240
K7 option.....	4.141
K72 option.....	4.266
K8 option.....	4.162
K82 option.....	4.320
K84 option.....	4.373
K91/K91n option.....	4.397
K92/K93 option.....	4.431
frequency offset (K92/K93).....	2.149
frequency plan (K20).....	2.80
Frequency Settings dialog box (K30).....	4.240
frequency-converting measurement (K30)	
.....	2.102, 4.250
Frontend Settings (K84).....	4.350
Frontend Settings dialog (K82).....	4.294
functional description (K8).....	2.39
G	
gate	
delay.....	4.32
external/internal.....	4.31
length.....	4.32
mode.....	4.31
General Results (K84).....	4.363
General Settings dialog box	
K91/K91n option.....	4.397
K92/K93 option.....	4.431
GET (Group Execute Trigger).....	5.11
GPIB	

interface5.30
 interface functions5.31
 Graphic dialog box (K30).....4.242

H

Hadamard Code Order (K82)4.305
 harmonics measurement4.109
 header5.5
 high speed physical downlink shared channel
 (K72)4.261
 high speed shared control channel (K72) ..4.261
 horizontal sync signal4.33
 hybrid acknowledgement indicator channel
 (K72)4.261

I

I/Q data acquisition7.21
 I/Q imbalance (K93).....2.157
 IEC/IEEE bus
 command description6.2
 image-frequency rejection (K30).....2.102
 impedance
 cable TV networks (K20).....4.217
 input4.16
 Inactive Channel Threshold4.291
 Initial Carrier Frequency Tolerance
 measurement (K8)4.154
 initial configuration4.4
 initial configuration (K82)
 Code Domain Analyzer4.285
 instrument functions4.1
 interface functions
 GPIB5.31
 interference
 inter-symbol K202.64
 intermodulation product2.7
 interrupt5.24
 inter-symbol interference K202.64
 IQ Capture Settings (K84)4.351
 IQ Capture Settings dialog (K82).....4.296
 IQ Imbal / Offset (K82).....4.312
 IQ impairments (K92/K93)2.150
 IST flag5.17
 IVI driver5.2

K

key
 AMPT4.13
 BW4.17
 ESC6.29
 FREQ4.5
 LINES4.111
 MEAS4.69
 MENU4.122
 MKR4.48
 MKR->4.60
 MODE4.120
 MODE (remote control).....6.149

PRESET4.3, 6.8, 6.253
 SPAN4.11
 SWEEP4.22
 TRACE4.35
 TRIG4.25

L

LAN5.26
 interface5.26
 RSIB protocol5.29
 VXI protocol5.27
 LAP (K8).....4.160
 level
 axis4.16
 display range4.14
 range4.14
 reference4.14
 trigger4.30
 level detection
 K92/K93 option2.143
 limit
 ACP measurement4.92
 evaluation range4.87
 limit check
 ACP measurement4.92
 Limit Check (remote control).....6.45
 limit line4.115
 copying4.118
 deleting4.118
 editing4.118
 new4.117
 scaling4.112, 4.113
 shift4.114
 span setting4.112
 unit4.113
 Limit Lines dialog box (K30).....4.236
 line
 display4.115
 frequency (Frequency Line 1, 2).....4.119
 limit4.115
 system4.34
 threshold4.67
 time (Time Line 1, 2)4.119
 linear averaging4.45
 LINES key4.111
 lines menu
 base unit4.116
 K30 option4.255
 K91/K91n option4.421
 K93 option4.470
 literature
 K92/K93 option2.151
 K93 option2.157
 LO exclude4.67
 logarithmic averaging4.45
 Loss dialog box (K30)4.246
 lower-case (commands).....5.6, 6.3

M

maintenance	8.1	Channel Table (remote control, K84)	6.629
manual operation		Code Dom Power (K72) .	4.272, 4.273, 4.274, 4.275
return to	5.4	Code Domain Analyzer (K82).....	4.307, 4.330
marker	4.48	Code Domain Analyzer (K84).....	4.362, 4.383
center frequency to	4.65	Code Domain Error (K82).....	4.314
peak	4.65	Code Domain Error (K84).....	4.370
reference level to.....	4.65	Code Domain Error (remote control, K84)	
search limit.....	4.66	6.629
signal track.....	4.9	Code Domain Power (K82).....	4.308
to trace	4.55	Code Domain Power (K84).....	4.363
zoom	4.57	Code Domain Power (remote control, K84)	
marker field		6.629
base unit.....	4.48	Composite Constell (K82)	4.317
K14 option	4.182	Composite Constell (remote control, K84)	
K72 option	4.261	6.629
marker menu		Composite Constellation (K84).....	4.371
base unit.....	4.52	Composite EVM.....	4.367
K14 option	4.186	Composite EVM (K82).....	4.315
K30 option	4.254	Composite EVM (remote control, K84)..	6.629
K72 option	4.268	Differential Phase Encoding (K8)	4.157
K82 option	4.327	distance-to-fault (K20)	2.75
K84 option	4.380	EVM vs Symbol (K82)	4.316
K91/K91n option.....	4.419	EVM vs Symbol (K84)	4.371
K92/K93 option.....	4.469	EVM vs Symbol (remote control, K84) ..	6.629
marker-> menu		functions	4.47
base unit.....	4.64	General Results (K84).....	4.363
K14 option	4.187	Initial Carrier Frequency Tolerance (K8)	4.154
K30 option	4.255	Modulation Characteristics (K8)	4.153
K72 option	4.269	Occupied Bandwidth (K82).....	4.334
K82 option	4.328	Occupied Bandwidth (K84).....	4.387
K84 option	4.381	Output Power (K8).....	4.152
K91/K91n option.....	4.420	parameters	4.2
K92/K93 option.....	4.469	Peak Code Domain Error (K82)	4.315
Max Hold trace mode.....	4.36	Peak Code Domain Error (K84)	4.369
maximum search	4.65	Peak Code Domain Error (remote control,	
maximum value	4.86	K84)	6.629
MC1	4.291	Power (K72).....	4.276
MC2	4.291	Power vs Chip (K84).....	4.366
mean power (GSM burst)	4.86	Power vs PCG (K82)	4.310
MEAS key	4.69	Power vs PCG (remote control, K84)....	6.629
measurement		Power vs Symbol (K82)	4.318
Adjacent-Channel Power (K72).....	4.279	Power vs Symbol (K84)	4.367
Adjacent-Channel Power (K8).....	4.152	reflection	4.126
Bitstream (K84)	4.369	Relative Transmit Power (K8)	4.155
Bluetooth (K8)	4.149	Result Summary (K82)	4.310
cable TV (K20)	4.193	Result Summary (remote control, K84) .	6.629
Carrier Frequency Drift (K8).....	4.154	Signal Channel Power (K82)	4.331
Carrier Frequency Stability and Modulation		Signal Channel Power (K84)	4.384
Accuracy (K8)	4.156	Spectrum Emission Mask (K72).....	4.279
Channel Bitstream (K82).....	4.318	Spectrum Emission Mask (K82) .	4.287, 4.332
Channel Bitstream (remote control, K84)		Spectrum Emission Mask (K84).....	4.385
.....	6.629	Spurious Emissions (K8)	4.156
Channel Constell (K82).....	4.316	Symbol Constellation (K84).....	4.370
Channel Constell (remote control, K84).	6.629	time.....	4.178
Channel Results (K84)	4.365	transmission	4.126
Channel Table (K82)	4.309	WiMAX 802.16 OFDM/OFDMA/WiBro	
Channel Table (K84)	4.368	(K92/K93).....	4.424
		WLAN TX (K91/K91n)	4.392

measurement example	
amplitude distribution	2.32
analog TV (K20)	2.46
analog TV settings (K20).....	2.46
APD (K20)	2.77
basic (K30)	2.99
basic (K92/K93).....	2.141
Carriers (K20).....	2.49
CCDF (K20)	2.78
Channel Power (K20).....	2.76
Code Domain Power measurement (K72)	
.....	2.111
Composite EVM measurement (K82) ...	2.123
Constellation Diagram (K20)	2.72
digital TV (K20)	2.68
digital TV settings (K20).....	2.68
Echo Pattern (K20).....	2.75
harmonics.....	2.2
Hum (K20).....	2.52
intermodulation.....	2.7
modulated signals	2.24
Modulation Errors (K20).....	2.73
noise.....	2.16
Overview (K20)	2.70
Peak Code Domain Error measurement	
(K82).....	2.124
relative Code Domain Power measurement	
(K72).....	2.109
relative Code Domain Power measurement	
(K82).....	2.117
relative Code Domain Power measurement	
triggered (K82).....	2.120
RHO factor (K82)	2.124
Signal Channel Power measurement (K72)	
.....	2.106
Signal Channel Power measurement (K82)	
.....	2.114
signals in the vicinity of noise	2.12
spectra of complex signals.....	2.6
Spectrum (K20).....	2.48, 2.69
Spectrum Emission Mask measurement	
(K72).....	2.108
Spectrum Emission Mask measurement	
(K82).....	2.116
test setup.....	2.2
Tilt (K20).....	2.79
TV analyzer (K20)	2.79
Video Scope (K20)	2.50
Vision Modulation (K20)	2.51
with channel table (K20).....	2.95
without channel table (K20).....	2.93
measurement forms (K30).....	4.237
measurement menu	
base unit.....	4.82
K20 option	4.218
K30 option	4.247
K72 option	4.270
K8 option	4.171
K82 option	4.330
K84 option	4.383
K91/K91n option	4.396
K92/K93 option	4.430
measurement mode	
1xEV-DO BTS Analyzer (K84).....	4.121
3G FDD BTS (K72)	4.121
Analog Demodulation (K7)	4.120
available modes.....	4.120
Bluetooth (K8).....	4.121
Cable TV Analyzer (K20)	4.121
CDMA2000 BTS Analyzer (K82)	4.121
changing.....	4.120
displaying main menus	4.122
K30 option	4.236
Noise (K30).....	4.121
Spectrum Analyzer	4.120
WiMAX/WiBro (K92/92).....	4.121
WLAN (K91/K91n).....	4.121
measurement result	
Active Channels (K82).....	4.312
Carr Freq Error (K82)	4.311
Channel Power Rel / Abs (K82).....	4.312
Chip Rate Error (K82).....	4.311
Composite EVM (K82).....	4.312
IQ Imbalance (K82)	4.312
Modulation (K82)	4.313
Offset (K82).....	4.312
Phase Offset (K82).....	4.313
Pilot PWR (K82)	4.312
RHO (K82).....	4.312
Symbol EVM rms / Pk (K82).....	4.312
Timing Offset (K82)	4.313
Total PWR (K82)	4.312
Trg to Frame (K82).....	4.312
measurement results (K30).....	4.237
Measurement Settings dialog box (K30)...	4.247
measurement variables	
CINR (K92/K93).....	2.151
CINR (K93).....	2.156
EVM (K92/K93).....	2.149
EVM (K93).....	2.155
I/Q imbalance (K93)	2.157
IQ impairments (K92/K93).....	2.150
K93 option	2.155, 2.157
RSSI (K92/K93)	2.151
RSSI (K93)	2.156
menu	
amplitude	4.13
amplitude (K20)	4.216
amplitude (K7)	4.143
amplitude (K72)	4.267
amplitude (K8)	4.163
amplitude (K82)	4.322
amplitude (K84)	4.375
amplitude (K91/K91n).....	4.397
amplitude (K92/K93).....	4.431
analog demodulation (K7)	4.131, 4.134
bandwidth	4.20
bandwidth (K7)	4.145

bandwidth (K8)	4.165
bandwidth (K82)	4.323
bandwidth (K84)	4.376
Bluetooth (K8)	4.149, 4.157
Cable TV Analyzer (K20).....	4.192, 4.211
Code Domain Analyzer (K82).....	4.282
frequency	4.6
frequency (K20).....	4.214
frequency (K30).....	4.240
frequency (K7).....	4.141
frequency (K72).....	4.266
frequency (K8).....	4.162
frequency (K82).....	4.320
frequency (K84).....	4.373
frequency (K91/K91n)	4.397
frequency (K92/K93)	4.431
lines	4.116
lines (K30)	4.255
lines (K91/K91n).....	4.421
lines (K92/K93).....	4.470
marker	4.52
marker (K14)	4.186
marker (K30)	4.254
marker (K72)	4.268
marker (K82)	4.327
marker (K84)	4.380
marker (K91/K91n).....	4.419
marker (K92/K93).....	4.469
marker->	4.64
marker-> (K14).....	4.187
marker-> (K30).....	4.255
marker-> (K72).....	4.269
marker-> (K82).....	4.328
marker-> (K84).....	4.381
marker-> (K91/K91n)	4.420
marker-> (K92/K93)	4.469
measurement (K14)	4.183
measurement (K20)	4.218
measurement (K30)	4.247
measurement (K7)	4.134
measurement (K72)	4.270
measurement (K8)	4.171
measurement (K82)	4.330
measurement (K84)	4.383
menu	4.122
noise figure measurements (K30).....	4.235, 4.239
power measurement	4.82
power meter (K9)	4.176, 4.177
settings (K72)	4.258, 4.262
span	4.11
span (K7).....	4.142
span (K82).....	4.321
span (K84).....	4.374
spectrogram (K14)	4.181, 4.183
sweep	4.22
sweep (K14)	4.185
sweep (K30)	4.252
sweep (K7)	4.146
sweep (K8)	4.167
sweep (K82)	4.324
sweep (K84)	4.378
sweep (K91/K91n).....	4.418
sweep (K92/92)	4.468
trace.....	4.39
trace (K20).....	4.217
trace (K30).....	4.253
trace (K82).....	4.326
trace (K84).....	4.379
trace (K91/K91n)	4.421
trace (K92/K93)	4.470
tracking generator	4.127
trigger	4.29
trigger (K7).....	4.147
trigger (K72).....	4.268
trigger (K8).....	4.171
trigger (K82).....	4.325
trigger (K84).....	4.379
trigger (K91/K91n)	4.397
trigger (K92/K93)	4.431
WiMAX (K92/K93)	4.424, 4.430
WLAN (K91/K91n).....	4.391, 4.396
MENU key	4.122
menu menu	4.122
MER (K20)	2.67
Min Hold trace mode	4.36
minimum search.....	4.66
MKR key.....	4.48
MKR-> key	4.60
mode	
see also measurement mode	4.120
trigger	4.29
MODE key	4.120
model	4.124
13, 16 and 28 - tracking generator	4.125
Modulation (K82).....	4.313
Modulation Characteristics measurement (K8)	4.153
modulation depth.....	4.86
modulation standard (K20).....	2.80, 2.82, 4.199
< unused >	2.81
Modulation Standard Options dialog box (K20)	4.196
modulation standards (K20)	
analog TV	2.83
assigning	2.92
creating.....	2.89
digital TV.....	2.85
N	
Negative Peak detector.....	4.38
noise	
measurement (K30).....	4.235
noise figure measurements menu (K30).....	4.235, 4.239
Noise mode (K30)	4.121
normalization.....	4.129
NTRansition register part	5.14

- numerical values (command)5.8
- O**
- occupied bandwidth4.72
 - K20 option2.86
- offset
 - frequency4.9
 - gate signal4.32
 - reference level4.15
 - trigger4.30
- option4.124
 - 1xEV-DO Base Station Test (K84).....4.340
 - 3GPP Base Station Measurements (K72)
 -4.258
 - Additional Interfaces (B5).....4.176
 - Analog Demodulation (K7)4.131
 - Bluetooth Measurements (K8)4.149
 - Gated Sweep (B8).....4.25
 - Noise Figure Measurements (K30)4.235
 - Power Meter (K9).....4.176
 - RF Preamplifier (B22)4.15
 - Spectrogram Measurement (K14).....4.181
 - TV Trigger (B6)4.28
 - WiMAX IEEE 802.16e, WiBro Measurements (K92/K93)4.423
 - WLAN TX Measurements (K91/K91n)....4.391
- OTD4.291
- output level
 - control4.128
- Output Power measurement (K8).....4.152
- overlapping execution5.11
- oversampling (K8).....2.40
- oversampling factor (K8)4.162
- overview
 - Bluetooth measurements (K8)2.35
- overwrite mode4.36
- P**
- p0 bit (K8)2.43, 4.151
- packing8.1
- paging indication channel (K72)4.261
- parallel poll5.24
 - enable register (PPE).....5.17
- parameter
 - block data5.9
 - boolean5.9
 - numerical values5.8
 - string5.9
 - technical (K8)2.35
 - text5.9
- PCCPCH (K72).....4.260
- PCG4.291
- PCH4.291
- PDCCH4.292
- PDCH.....4.292
- Peak Code Domain Error (K82).....4.315
- Peak Code Domain Error (K84).....4.369
- peak envelope power (K20).....2.67
- peak search4.65
- phase jitter (K20).....2.67
- physical layer (K20).....2.81
- PICH.....4.292
- PICH (K72).....4.260
- Pilot PWR (K82).....4.312
- polarity
 - external trigger/gate.....4.30
 - trigger edge4.30
 - video4.34
- Positive Peak detector4.38
- power
 - 3GPP FDD signal (K72)4.276
 - bandwidth percentage4.95
 - mean.....4.86
- power cables8.1
- power classes
 - bluetooth (K8)2.36
- power measurement4.69
 - occupied bandwidth4.72
 - trace.....4.93
 - zero span.....4.71
- power measurement menu
 - base unit.....4.82
- power meter (K9)4.176
 - frequency.....4.177
 - menu.....4.176, 4.177
- power sensor support (K9).....4.176
- Power vs Chip (K84)4.366
- Power vs PCG (K82).....4.310
- Power vs Symbol (K82).....4.318
- Power vs Symbol (K84).....4.367
- PPE (parallel poll enable register).....5.17
- preset instrument4.2
- PRESET key4.3
- preset spectrum analyzer4.3
- pre-trigger.....4.30
- primary common control physical channel (K72)
 -4.260
- primary synchronization channel (K72).....4.260
- programming examples
 - averaging I/Q data7.23
 - channel power measurement.....7.11
 - I/Q data7.21
 - level measurement7.18
 - limit lines and limit test.....7.9
 - occupied bandwidth measurement.....7.13
 - power ramp measurement7.15
 - reading files7.24
 - service request7.1
 - Spectrum Emission Mask measurement 7.26
 - Spurious Emissions measurement.....7.30
 - time domain power measurement.....7.14
 - transducers.....7.20
 - WiMAX, WiBro measurements (K92/K93)
 -7.37
 - WLAN TX measurements (K91)7.34
 - writing files7.25
- protocol

RSIB	5.29
VXI	5.27
PTTransition register part	5.14
Q	
QAM (K20)	2.85
quadrature error (K20)	2.67
query	5.8, 5.25, 5.33
question mark	5.8, 5.10
quotation mark	5.10
R	
RC	4.292
reference	
fixed	4.54
level to marker level	4.65
value	4.179
reference level	4.14
channel power	4.94
offset	4.15
to marker level	4.65
reference noise bandwidth (K20)	2.53
reference point	
frequency	4.54
level	4.54
peak search	4.54
time	4.54
reflection measurement	4.126
relative grant channel (K72)	4.261
Relative Transmit Power measurement (K8)	4.155
remote control	
basics	5.1
IP address	5.3
programming examples	7.1
starting	5.4
reset	
status reporting system	5.25
switch on or off	4.43
resolution bandwidth	4.20
K7 option	4.146
result display	
Code Dom Channel Table (K72)	4.272
Code Dom Power Diagram (K72)	4.273
Code Dom Result Summary (K72)	4.274, 4.275
Result Settings dialog (K82)	4.304
Result Summary (K82)	4.310
RHO (K82)	4.312
RMS detector	4.38
RMS value	4.86
roll-off factor (K20)	2.64
root raised cosine	2.86
filter (K20)	2.64
RSIB protocol	5.29
RSSI (K92/K93)	2.151
RSSI (K93)	2.156
RX filter (K20)	2.64

S

Sample detector	4.38
sample number	4.96
scalar reflection measurement	4.126
scaling	4.14
level axis	4.16
x- and y-axis (signal statistic)	4.96
SCH (K72)	4.260
SCPI	
conformity information	6.2
introduction	5.5
version	5.1
search	
bandwidth	4.9
minimum	4.66
peak	4.65
range	4.66
secondary common control physical channel (K72)	4.260
secondary synchronization channel (K72)	4.260
Select Limit Line dialog box	4.114
sensitivity	
APD measurement	4.97
CCDF measurement	4.97
serial poll	5.24
service request (SRQ)	5.16, 5.24
service request enable register (SRE)	5.16
setting command	5.33
Settings (K82)	4.293
Settings (K84)	4.349
settings menu (K72)	4.258, 4.262
Settings Overview dialog (K82)	4.294
Settings Overview dialog (K84)	4.349
SF	4.292
sideband suppression (K30)	2.102
signal count	4.55
signal level (K20)	4.199
signal processing	
block diagram (K93)	2.154
IEEE 802.11a (K91)	2.128
IEEE 802.11b (K91)	2.134
IEEE 802.16 OFDMA (K93)	2.153
IEEE 802.16-2004 OFDM (K92/K93)	2.144
signal tracking	4.9
search bandwidth	4.9
softkey	
# of Adj Chan	4.89
# of Adj Chan (remote control)	6.214
# of Samples	4.96
# of Samples (K82)	4.335
# of Samples (K84)	4.388
# of Samples (remote control)	6.111
# of TX Chan	4.89
# of TX Chan (remote control)	6.220
% Power Bandwidth	4.95
% Power Bandwidth (K82)	4.334
% Power Bandwidth (remote control)	6.220
(remote control, K14)	6.386, 6.388

- = Center4.9
- = Chan Spacing (K8).....4.163
- = Marker4.9
- = Marker (remote control)6.69
- 0.1 * RBW4.8
- 0.1 * RBW (remote control).....6.195, 6.196
- 0.1 * Span4.8
- 0.1 * Span (remote control).....6.195, 6.196
- 0.1*Chan Spacing (K8)4.163
- 0.1*Demod BW (K7)4.141
- 0.5 * RBW4.8
- 0.5 * RBW (remote control).....6.195, 6.196
- 0.5 * Span4.8
- 0.5 * Span (remote control).....6.195, 6.196
- 0.5*Demod BW (K7)4.141
- 30kHz/1MHz Transition (K72)4.281
- 30kHz/1MHz Transition (remote control, K72)6.567
- ACP (K72)4.279
- ACP (remote control, K72)6.572
- ACP Abs/Rel4.94
- ACP Abs/Rel (remote control).....6.216
- ACP Ref Setting (remote control)6.218
- ACP Ref Settings4.91
- ACP Ref Spacing (remote control).....6.218
- ACP Rel/Abs (K91/K91n)4.415
- ACP Rel/Abs (remote control, K91)6.690, 6.696
- ACP Settings (K92/K93).....4.463
- ACP Settings (remote control, K92/K93)6.831, 6.832, 6.833
- ACPR Abs/Rel (K92/K93)4.462
- ACPR Abs/Rel (remote control, K92/K93)6.773, 6.783, 6.784
- Activate (K20).....4.211
- Activate (remote control, K20).....6.469
- Active On/Off (remote control)6.176, 6.178
- Add Channel (K82).....4.303
- Add Channel (K84).....4.356
- Adjacent Channel Power (K82).....4.331
- Adjacent Channel Power (K84).....4.384
- Adjacent Channel Power (remote control, K82)6.606
- Adjacent Channel Power (remote control, K84)6.642
- Adjust Attenuation (K20)4.214
- Adjust Gate (K8).....4.168
- Adjust Gate (remote control, K8)6.352
- Adjust Ref Level4.94
- Adjust Ref Level (K72)4.265, 4.281
- Adjust Ref Level (K82)4.320, 4.322, 4.332, 4.335
- Adjust Ref Level (K84)4.373, 4.375, 4.385
- Adjust Ref Level (remote control)6.217
- Adjust Ref Level (remote control, K72) .6.581, 6.584
- Adjust Ref Level (remote control, K82) ..6.613
- Adjust Ref Lvl4.95
- Adjust Settings4.88, 4.93, 4.97, 4.110
- Adjust Settings (K82)..... 4.335, 4.336
- Adjust Settings (K84)..... 4.388, 4.389
- Adjust Settings (remote control) . 6.112, 6.216
- Adjust X-Axis 4.108
- AF Center (K7) 4.142
- AF Center (remote control, K7) 6.295
- AF Coupling AC/DC (K7)..... 4.138
- AF Coupling AC/DC (remote control, K7) 6.295
- AF Filter (K7) 4.138
- AF Full Span (K7) 4.143
- AF Full Span (remote control, K7)..... 6.296
- AF Range (K7)..... 4.137
- AF Span Manual (K7) 4.143
- AF Span Manual (remote control, K7) ... 6.296
- AF Spectrum (K7)..... 4.136
- AF Start (K7)..... 4.142
- AF Start (remote control, K7) 6.297
- AF Stop (K7)..... 4.142
- AF Stop (remote control, K7)..... 6.297
- AF Time Domain (K7)..... 4.135
- All Functions off 4.85
- All Functions off (remote control) 6.95
- All Marker Off 4.57
- All Marker Off (K30)..... 4.255
- All Marker Off (remote control, K30) 6.525
- AM 4.55
- AM (remote control)..... 6.69
- AM Mod Depth..... 4.86
- AM Mod Depth (remote control) 6.73
- Analog TV (K20) 4.220
- Analog TV (remote control, K20)..... 6.467
- Analog TV Settings (K20) 4.227
- Analog TV Settings (remote control, K20) 6.502, 6.513, 6.514, 6.515
- Annotation On/Off (remote control) 6.125
- Antenna Diversity (K82)..... 4.298
- Antenna Diversity On/Off (K72) 4.265
- Antenna Diversity On/Off (remote control, K72) 6.580
- Antenna Gain (K8)..... 4.159
- Antenna Gain (remote control, K8)..... 6.363
- Antenna Number 1/2 (K72) 4.265
- Antenna Number 1/2 (remote control, K72) 6.580
- APD 4.95
- APD (K20) 4.232
- APD (remote control)..... 6.110, 6.111
- ASCII File Export 4.43, 4.58, 4.106
- ASCII File Export (remote control) 6.162
- Auto Level (K91/K91n) 4.419
- Auto Level (K92/K93) 4.468
- Auto Level (remote control, K92/K93) ... 6.787
- Auto Level&Code (K72)..... 4.271
- Auto Level&Code (remote control, K72) 6.581
- Auto Lvl (remote control, K91)..... 6.699
- Auto Max Peak 4.68
- Auto Max Peak (remote control)..... 6.58
- Auto Min Peak 4.68

- Auto Min Peak (remote control)6.61
 Auto Range (K20)4.228, 4.234
 Auto Range (remote control, K20)6.471
 Auto Scale Once (K82)4.323, 4.327
 Auto Scale Once (K84)4.376
 Average4.40
 Average Length (K91/K91n).....4.408
 Average Length (remote control, K91)...6.695
 Average Mode4.44
 Average Mode (remote control)6.106
 Band Class (K82)4.331, 4.333
 Band Class (K84)4.384, 4.386
 Band Class (remote control, K82).....6.605
 Band Class (remote control, K84).....6.641
 Base SF (K82).....4.297
 Bit Selection (K93)4.467
 Bit Selection (remote control, K93)6.777, 6.778
 Bitstream (K91/K91n).....4.416
 Bitstream (K92/K93).....4.465
 Bitstream (remote control, K91).....6.698
 Bitstream (remote control, K92/K93).....6.786
 Blank4.41
 Block Count (K8).....4.168
 Block Count (remote control, K8).....6.350
 Build Tbl (K30)4.251
 Burst Fit On/Off (K84)4.390
 Burst Offset (K8)4.161
 Burst Offset (remote control, K8)6.367
 Burst Selection (K92/K93).....4.448
 Burst Selection (remote control, K92/K93)6.783
 Burst Summary (K92/K93)4.466
 Burst Summary (remote control, K92/K93)6.786
 C/N4.87
 C/N (K20)4.222
 C/N (remote control)6.86, 6.87, 6.90
 C/N (remote control, K20)6.430
 C/N Setup (K20).....4.223
 C/N Setup (remote control, K20)6.481, 6.482, 6.484
 C/N, C/No4.87
 C/No4.88
 C/No (remote control)6.86, 6.87, 6.90
 Cal (K30)4.252
 Cal (remote control, K30).....6.528
 Cal Refl Open.....4.129
 Cal Refl Open (remote control)...6.174, 6.175
 Cal Refl Short.....4.129
 Cal Refl Short (remote control)6.175
 Cal Trans.....4.129
 Cal Trans (remote control)6.175
 Cal Type Sine/Comb (remote control) ...6.121
 Cancel (K82)4.304
 Cancel (K84)4.357
 Capture Length (K82).....4.296
 Capture Length (K84).....4.351
 Carr Freq Drift (K8)4.174
 Carr Freq Drift (remote control, K8)..... 6.328, 6.329
 Carr Freq Stability (K8)..... 4.175
 Carr Freq Stability (remote control, K8) 6.329, 6.330, 6.331, 6.332, 6.333
 Carrier Selection (K91/K91n)..... 4.413
 Carrier Selection (K92/K93)..... 4.456
 Carrier Selection (remote control, K91) . 6.692
 Carrier Selection (remote control, K92/K93)6.779
 Carriers (K20).....4.221
 Carriers (remote control, K20).....6.429
 CCDF4.97
 CCDF (K20).....4.233
 CCDF (K82).....4.335
 CCDF (K84).....4.388
 CCDF (K91/K91n)4.416
 CCDF (K92/K93)4.464
 CCDF (remote control) 6.110, 6.111
 CCDF (remote control, K82).....6.606
 CCDF (remote control, K84).....6.642
 CCDF (remote control, K91).....6.698
 CCDF (remote control, K92/K93)6.787
 CDP Average (K84).....4.361
 Center4.7
 Center (K8).....4.163
 Center (remote control)6.194
 Center =Mkr Freq4.65
 Center =Mkr Freq (remote control).....6.69
 CF Stepsize4.8
 CF Stepsize (remote control)6.194
 CF-Stepsize (K8).....4.163
 Chan Pwr/Hz4.91
 Chan Pwr/Hz (remote control).....6.89
 Chan Type (K84)4.371
 Channel (Code) Number (K82)4.305
 Channel (K20)4.215
 Channel (K8)4.158
 Channel (remote control, K20)6.498
 Channel (remote control, K8)6.350
 Channel Analysis (K20)4.230
 Channel Bandwidth4.88, 4.90, 4.95
 Channel Bandwidth (K82).....4.334
 Channel Bandwidth (remote control).....6.215
 Channel Bitstream (K82)4.318
 Channel Bitstream (remote control, K82)6.595, 6.618
 Channel Constell (K82)4.316
 Channel Constell (remote control, K82)6.595, 6.618
 Channel List Start (K8)4.170
 Channel No (K20).....4.221
 Channel Power (K20)4.232
 Channel Settings4.89
 Channel Setup (K20)4.211
 Channel Spacing4.90
 Channel Spacing (remote control).....6.219
 Channel Table (K82)4.309

- Channel Table (remote control, K82) 6.595, 6.602, 6.603, 6.605, 6.612, 6.618
- Channel Table (remote control, K84) 6.637, 6.638, 6.640, 6.641, 6.650
- Channel Table settings (K82).....4.300
- Channel Table Settings (K84)4.354
- Channel Type (K84)4.360
- Channel Width (K20).....4.215
- Clear All Messages (remote control)....6.249, 6.250
- Clear Write4.40
- Clear/Write4.93
- Close Sweep List4.103
- Code Dom Channel Table (K72).....4.272
- Code Dom Channel Table (remote control, K72)6.565, 6.572
- Code Dom Overview (K84)4.361
- Code Dom Power Diagram (K72)4.273
- Code Dom Power Diagram (remote control, K72)6.565, 6.572
- Code Dom Result Summary (K72)4.274
- Code Dom Result Summary (remote control, K72)6.565, 6.570, 6.572
- Code Domain Analyzer (K82).....4.330
- Code Domain Analyzer (K84).....4.383
- Code Domain Analyzer (remote control, K82)6.606
- Code Domain Analyzer (remote control, K84)6.642
- Code Domain Error (K82)4.314
- Code Domain Error (remote control, K82)6.595
- Code Domain Power (K82)4.308
- Code Domain Power (remote control, K82)6.595, 6.618
- Code Order (K82).....4.305
- Code Power (K82).....4.306
- Code Power Abs Rel (K84)4.361
- Code Power Abs/Rel (K72)4.263
- Code Power Abs/Rel (remote control, K72)6.565
- Color (K14).....4.184
- Color (remote control, K14).....6.399
- Color On/Off (remote control)6.140
- Composite Constell (K82)4.317
- Composite Constell (remote control, K82)6.595
- Composite EVM (K82)4.315
- Composite EVM (remote control, K82) .6.595, 6.618
- Const Diagram (K20)4.230
- Constell Selection (K93).....4.456
- Constell Selection (remote control, K93)6.778, 6.780
- Constell vs Symbol/Carrier (K91/K91n) .4.412
- Constell vs Symbol/Carrier (K92/K93) ...4.455
- Constell vs Symbol/Carrier (remote control, K91)6.693
- Constell vs Symbol/Carrier (remote control, K92/K93) 6.779
- Cont Demod 4.56
- Cont Demod (remote control)..... 6.68
- Cont Meas (remote control)..... 6.143, 6.144
- Continue Frame On/Off (K14) 4.186
- Continue Frame On/Off (remote control, K14) 6.399
- Continue Single Sweep 4.23
- Continue Single Sweep (remote control)6.143
- Continue Test (K8) 4.168
- Continuous Sweep 4.23
- Continuous Sweep (K8)..... 4.168
- Continuous Sweep (remote control).... 6.143, 6.144
- Continuous Sweep Start/Stop (remote control, K14)..... 6.403
- Copy (K20) 4.213
- Copy (K82) 4.301
- Copy (K84) 4.357
- Copy (remote control)..... 6.153
- Copy (remote control, K82) 6.603
- Copy (remote control, K84) 6.638
- Copy Channel (K20) 4.212
- Copy to 4.118
- Copy to (remote control)..... 6.30
- Copy Trace 4.43
- Copy Trace (remote control) 6.257
- Copy Trace (remote control, K20) 6.512
- Copy Zone/Burst (K93)..... 4.446
- Corr Data On/Off (remote control)..... 6.119
- CP / ACP Config..... 4.89
- CP / ACP Standard..... 4.88
- CP / ACP Standard (remote control) 6.86
- CP, ACP, MC-ACP 4.88
- CP, ACP, MC-ACP (remote control) 6.86, 6.87, 6.90
- CPICH (K72)..... 4.270
- CPICH (remote control, K72) 6.562, 6.569
- CSO (K20)..... 4.225
- CSO (remote control, K20)..... 6.430
- CSO Setup (K20)..... 4.225
- CSO Setup (remote control, K20) 6.485, 6.486, 6.487
- CTB (K20)..... 4.226
- CTB (remote control, K20) 6.431
- CTB Setup (K20) 4.226
- CTB Setup (remote control, K20)6.489, 6.491
- Data -> Mem1 (K30)..... 4.253
- Data -> Mem1 (remote control, K30).... 6.528
- Data -> Mem2 (K30)..... 4.253
- Data -> Mem2 (remote control, K30).... 6.528
- Data -> Mem3 (K30)..... 4.253
- Data -> Mem3 (remote control, K30).... 6.528
- Data On/Off (K30) 4.254
- Data On/Off (remote control, K30) 6.530, 6.532
- dB per Division (K7)..... 4.137
- dB per Division (K72)..... 4.267

- dB per Division (remote control, K7) 6.289
 dB per Division (remote control, K72) 6.573
 Decim Sep..... 4.43
 Decim Sep (remote control) 6.135
 Deemphasis (K7) 4.139
 Deemphasis (remote control, K7) 6.316
 Default All (K91/K91n)..... 4.421
 Default All (K92/K93)..... 4.470
 Default Colors 1 (remote control)..... 6.126
 Default Colors 2 (remote control)..... 6.126
 Default Current (K91/K91n)..... 4.421
 Default Current (K92/K93)..... 4.470
 Default Settings 4.97
 Default Settings (remote control) 6.111, 6.113
 Delete 4.118
 Delete (K20) 4.212, 4.213
 Delete (K30) 4.251, 4.257
 Delete (K82) 4.301
 Delete (K84) 4.357
 Delete (remote control) 6.30, 6.154, 6.158, 6.178
 Delete (remote control, K82) 6.604
 Delete (remote control, K84) 6.640
 Delete Channel (K20)..... 4.212
 Delete Channel (K82)..... 4.303
 Delete Channel (K84)..... 4.356
 Delete File (remote control)..... 6.152
 Delete Line (K20) 4.224
 Delete Range 4.104
 Delete Range (remote control)..... 6.185
 Delete Value..... 4.118
 Delete Zone/Burst (K93) 4.446
 Demod Bandwidth (K7) 4.143
 Demod BW (K7)..... 4.136
 Demod BW (remote control, K7)..... 6.315
 Demod Settings (K7)..... 4.138
 Demod Settings (K82)..... 4.297
 Demod Settings (K84)..... 4.352
 Demod Settings (remote control, K82).. 6.611, 6.614, 6.615, 6.616
 Demod Settings (remote control, K84)... 6.654
 Demod Settings (remote control, K91 / K91n) 6.721, 6.722, 6.723, 6.724, 6.725, 6.726, 6.727, 6.728, 6.732
 Deselect All 4.117
 Details On/Off..... 4.108
 Detector Auto Peak 4.41
 Detector Auto Select 4.41
 Detector Auto Select (remote control).... 6.180
 Detector Average 4.42
 Detector Manual Select..... 4.41
 Detector Manual Select (remote control)6.180
 Detector Manual Select (remote control, K8) 6.351
 Detector Negative Peak 4.42
 Detector Positive Peak..... 4.41
 Detector Quasi Peak 4.42
 Detector RMS..... 4.42
 Detector Sample 4.42
 Dev per Division (K7)..... 4.137
 Deviation Lin/Log (K7) 4.138
 Deviation Lin/Log (remote control, K7).. 6.290
 Device 1/2 (remote control) 6.156
 Device Setup (remote control)... 6.139, 6.140, 6.142, 6.247, 6.248
 Diagram Full Size (K7) 4.136
 Diagram Full Size (remote control, K7) . 6.289
 Diff Phase (K8) 4.175
 Diff Phase (remote control, K8) .. 6.333, 6.334
 Digital TV (K20) 4.229
 Digital TV (remote control, K20) . 6.468, 6.469
 Digital TV Settings (K20) 4.231
 Digital TV Settings (remote control, K20) 6.495, 6.496, 6.497
 Disable all Items (remote control)..... 6.161
 Discard Changes (K20) 4.213
 Disconnect Network Drive (remote control) 6.157
 Display Graph/Display List (K92/K93) ... 4.447
 Display Graph/Display List (remote control, K92/K93) 6.803
 Display Line 1 4.119
 Display Line 1 (remote control)..... 6.23
 Display Line 2 4.119
 Display Line 2 (remote control)..... 6.23
 Display Lines 4.119
 Display List/Graph (K30) 4.242
 Display List/Graph (K91/K91n) 4.406
 Display List/Graph (remote control, K30) 6.531
 Display List/Graph (remote control, K91) 6.703
 Display Pwr Save (remote control) 6.127, 6.128
 Display Settings (K30) 4.242
 Display Settings (remote control, K30) . 6.531, 6.532, 6.533, 6.535
 DPSK Start (K8) 4.170
 DPSK Start (remote control, K8) 6.355
 DPSK Stop (K8)..... 4.170
 DPSK Stop (remote control, K8) 6.356
 Echo Pattern (K20)..... 4.230
 Edit 4.118
 Edit (K20)..... 4.213
 Edit (K30)..... 4.257
 Edit (K82)..... 4.302
 Edit (K84)..... 4.358
 Edit (remote control).... 6.29, 6.32, 6.41, 6.42, 6.43, 6.49, 6.50, 6.51, 6.52, 6.53, 6.177
 Edit ACP Limit 4.92
 Edit ACP Limit (remote control)..... 6.33, 6.34, 6.35, 6.36, 6.37, 6.38
 Edit Comment..... 4.117
 Edit Margin 4.117
 Edit Name..... 4.117
 Edit Name (remote control) 6.178
 Edit Path (remote control) 6.151, 6.156
 Edit Power Classes 4.106

Edit Reference Range.....	4.104	Fix Freq (remote control, K30) ...	6.529, 6.550
Edit Reference Range (remote control)	6.182, 6.193	FM	4.55
Edit Table (K20)	4.221	FM (remote control).....	6.69
Edit Table (remote control, K20)	6.410, 6.411, 6.412, 6.413, 6.414, 6.415, 6.416, 6.417, 6.437, 6.438, 6.439, 6.440, 6.441, 6.442, 6.443, 6.444	Format Hex/Dec (K72)	4.264
Edit Unit (remote control)	6.179	Format Hex/Dec (remote control, K72)	6.582, 6.583
Edit Values (remote control).....	6.177	F-PICH (K82).....	4.329
EDR (K8).....	4.174	F-PICH (remote control, K82).....	6.599
Enable all Items (remote control)	6.159	Frame Count (K14).....	4.186
Enable/Disable (K30)	4.257	Frame Count (remote control, K14).....	6.400
ENR Settings (K30).....	4.245	Freeze (K20).....	4.230
ENR Settings (remote control, K30).....	6.544, 6.548	Freeze (remote control, K20)	6.470
Error Frequency/Phase (K91/K91n).....	4.411	Freq Axis Lin/Log (remote control)	6.131
Error Frequency/Phase (K92/K93).....	4.454	Freq Settings (K30)	4.240
Error Frequency/Phase (remote control, K91)	6.694	Freq Settings (remote control, K30)	6.545, 6.549, 6.550, 6.551, 6.552
Error Frequency/Phase (remote control, K92/K93).....	6.781, 6.782	Frequency Abs/Rel (K20)	4.215
EVM Constell (K91/K91n)	4.410	Frequency Abs/Rel (remote control, K20)	6.501
EVM Constell (K92/K93)	4.451	Frequency Coupling (K9).....	4.178
EVM vs Symbol (K82).....	4.316	Frequency Coupling (remote control, K9)	6.379
EVM vs Symbol (remote control, K82) ..	6.595, 6.618	Frequency Line 1	4.119
EVM vs Symbol/Carrier (K91/K91n).....	4.410	Frequency Line 1 (remote control)	6.26
EVM vs Symbol/Carrier (K92/K93).....	4.451	Frequency Line 2.....	4.119
EVM vs Symbol/Carrier (remote control, K91)	6.693, 6.694	Frequency Line 2 (remote control)	6.26
EVM vs Symbol/Carrier (remote control, K92/K93).....	6.781	Frequency Manual (K9)	4.177
Exclude LO.....	4.67	Frequency Manual (remote control, K9)	6.379
Exclude LO (remote control)	6.58	Frequency Offset.....	4.9
Exit (K30)	4.251, 4.256	Frequency Offset (remote control)	6.196
Export (K91/K91n).....	4.409	Frontend Settings (K82)	4.294
Export (K92/K93).....	4.451	Frontend Settings (K84)	4.350
Export (remote control, K91 / K91n)	6.718	F-TDPICH (K82)	4.329
Export (remote control, K92/K93)	6.824	F-TDPICH (remote control, K82).....	6.600
Ext Att (remote control, K91 / K91n)	6.716	Full Burst (K91/K91n)	4.407
Ext Att (remote control, K92/K93)	6.805	Full Burst (K92/K93)	4.447
Ext Power Trigger (K9).....	4.179	Full Burst (remote control, K91)	6.696
Ext Power Trigger (remote control, K9) ..	6.381	Full Burst (remote control, K92/K93)	6.783
Fast ACP On/Off	4.94	Full Size Diagram	4.110
Fast ACP On/Off (remote control).....	6.221	Full Size Diagram (remote control).....	6.128
Field 1/2 (K20).....	4.228	Full Span	4.12
Field 1/2 (remote control, K20).....	6.514	Full Span (K7).....	4.143
File Manager (K93)	4.467	Full Span (remote control).....	6.197
Filter Type	4.21	Full Span (remote control, K7)	6.313
Filter Type (K8)	4.166	Full Subframe (K93)	4.448
Filter Type (remote control).....	6.171	Gate Delay.....	4.32
Find Burst On/Off (K8)	4.160	Gate Delay (K8).....	4.170
Find Burst On/Off (remote control, K8) ..	6.366	Gate Delay (remote control)	6.225
Find Sync (K8).....	4.159	Gate Length.....	4.32
Find Sync On/Off (K8).....	4.159	Gate Length (K8).....	4.170
Find Sync On/Off (remote control, K8)...	6.367	Gate Length (remote control)	6.225
Firmware Update (remote control)	6.250	Gate Mode Lvl/Edge.....	4.31
Fix Freq (K30)	4.252	Gate Mode Lvl/Edge (remote control) ...	6.226
		Gate Settings.....	4.31
		Gated Trigger	4.31
		Gated Trigger (remote control)...	6.224, 6.226
		Gating Settings On/Off (K91/K91n)	4.408
		Gating Settings On/Off (K92/K93)	4.449

- Gating Settings On/Off (remote control, K91 / K91n).....6.730, 6.731
- Gating Settings On/Off (remote control, K92/K93).....6.837, 6.838, 6.839
- General Settings (remote control, K91 / K91n).....6.716, 6.721, 6.729, 6.732, 6.743, 6.744, 6.745
- General Settings (remote control, K91) 6.699, 6.700, 6.704
- GFSK Start (K8).....4.170
- GFSK Start (remote control, K8).....6.356
- GFSK Stop (K8).....4.170
- GFSK Stop (remote control, K8).....6.357
- GPIO Address (remote control).....6.246
- GPIO Terminator LFE0I/EOI (remote control).....6.247
- Grid Abs / Rel.....4.16
- Grid Abs / Rel (remote control).....6.132
- Grid Abs / Rel (remote control, K20).....6.471
- Hardware Info (remote control).....6.7, 6.120
- Harmonic Distort.....4.109
- Harmonic On/Off.....4.109
- Harmonic RBW Auto.....4.110
- Harmonic Sweep Time.....4.109
- High Pass AF Filter (K7).....4.139
- High Pass AF Filter (remote control, K7)6.317
- History Depth (K14).....4.184
- History Depth (remote control, K14).....6.401
- Hold/Cont.....4.43
- Hor Sync.....4.33
- Hor Sync (remote control).....6.274
- HSDPA/HSUPA On/Off (K72).....4.266
- HSDPA/HSUPA On/Off (remote control, K72).....6.581
- Hum (K20).....4.228
- Hum (remote control, K20).....6.432
- IF Output IF/Video (remote control).....6.165
- IF Power Retrigger Holdoff.....4.32
- IF Power Retrigger Holdoff (remote control).....6.270
- IF Power Retrigger Hysteresis.....4.33
- IF Power Retrigger Hysteresis (remote control).....6.271
- Import (K91/K91n).....4.409
- Import (K92/K93).....4.451
- Import (remote control, K91 / K91n).....6.718
- Import (remote control, K92/K93).....6.823
- Inactive Channel Threshold (K72).....4.265
- Inactive Channel Threshold (remote control, K72).....6.582
- Init Carr Freq Tol (K8).....4.174
- Input 50 Ω / 75 Ω4.16
- Input 50 Ω / 75 Ω (remote control).....6.147
- Input RF/Cal/TG (remote control).....6.121
- Insert (K30).....4.251, 4.257
- Insert after Range.....4.103
- Insert after Range (remote control).....6.188
- Insert before Range.....4.103
- Insert before Range (remote control).....6.188
- Insert Line (K20).....4.224
- Insert Value.....4.118
- Insert Zone/Burst (K93).....4.446
- Installed Options (remote control) .. 6.7, 6.120
- Interpolation Lin/Log (remote control) ... 6.178
- Invert Q On/Off (K72).....4.265
- Invert Q On/Off (remote control, K72) ... 6.585
- IQ Capture Settings (K82).....4.296
- IQ Capture Settings (K84).....4.351
- IQ Capture Settings (remote control, K82).....6.613, 6.615
- IQ Capture Settings (remote control, K84).....6.651, 6.655
- LAP (K8).....4.160
- LAP (remote control, K8).....6.367
- Last Span.....4.12
- Left Limit.....4.66, 4.87
- Left Limit (remote control).....6.64
- Limit Checking.....4.92
- Limit Chk On/Off.....4.92
- Limit Chk On/Off (remote control) . 6.33, 6.36, 6.39
- Limit Line Auto (K72).....4.280
- LIMIT LINE AUTO (K82).....6.597
- LIMIT LINE AUTO (K84).....6.630
- Limit Line Auto (remote control, K72).... 6.566
- Limit Line Manual (K72).....4.280
- LIMIT LINE MANUAL (K82).....6.597
- LIMIT LINE MANUAL (K84).....6.630
- Limit Line Manual (remote control, K72).....6.566, 6.567
- Limit Line Manual (remote control, K82) 6.598
- Limit Line Manual (remote control, K84) 6.631
- Limit Line Select dialog box (remote control).....6.48, 6.54
- Limit Line User (K72).....4.281
- LIMIT LINE USER (K82).....6.597
- LIMIT LINE USER (K84).....6.630
- Limit Line User (remote control, K72).... 6.566
- Limits On/Off.....4.87
- Limits On/Off (remote control).....6.64
- Lin (Average Mode).....4.45
- Line (K20).....4.227
- Line (remote control).....6.514
- Lines 625/525.....4.34
- Lines 625/525 (remote control).....6.274
- List Down.....4.105
- List Evaluation.....4.105
- List Evaluation On/Off.....4.105
- List Evaluation On/Off (remote control) ... 6.24
- List Full Screen.....4.105
- List Up.....4.105
- List Zone/Burst (K93).....4.443
- Log (Average Mode).....4.45
- Logo On/Off (remote control).....6.127
- Loss Settings (K30).....4.246
- Loss Settings (remote control, K30).... 6.545, 6.546, 6.547
- Low Pass AF Filter (K7).....4.138

- Low Pass AF Filter (remote control, K7)
.....6.317, 6.318
- Manual4.9
- Manual (remote control).....6.194
- Manual Reference Power (K20).....4.223
- Manual Reference Power (remote control,
K20).....6.483, 6.486, 6.490
- Map Network Drive (remote control).....6.157,
6.158
- Mapping Auto (K84)4.361
- Mapping Complex (K84)4.361
- Margin4.105
- Margin (remote control).....6.24
- Marker 14.53
- Marker 1 (K30).....4.254
- Marker 1 (K82).....4.327
- Marker 1 (K84).....4.381
- Marker 1 (K91/K91n).....4.419
- Marker 1 (K92/K93).....4.469
- Marker 1 (remote control)6.12
- Marker 1 (remote control, K30) ..6.525, 6.526
- Marker 1 (remote control, K91) ..6.685, 6.686,
6.687, 6.688, 6.689
- Marker 1 (remote control, K92/K93).....6.767,
6.768, 6.770, 6.771, 6.772
- Marker 1 to 4 (remote control)6.20, 6.21,
6.55, 6.63, 6.66
- Marker 24.53
- Marker 2 (K82)4.327
- Marker 2 (K84)4.381
- Marker 2 (remote control)6.12
- Marker 34.53
- Marker 3 (K82)4.327
- Marker 3 (K84)4.381
- Marker 3 (remote control)6.12
- Marker 44.53
- Marker 4 (K82)4.327
- Marker 4 (K84)4.381
- Marker 4 (remote control)6.12
- Marker Demod4.55
- Marker Demod Volume4.123
- Marker List (remote control).....6.70
- Marker Norm/Delta4.53
- Marker Norm/Delta (K82).....4.327
- Marker Norm/Delta (K84).....4.381
- Marker Norm/Delta (remote control)6.12
- Marker Off (K91/K91n).....4.420
- Marker Off (K92/K93).....4.469
- Marker Off (remote control, K91)6.685
- Marker Off (remote control, K92/K93).....6.768
- Marker Peak List4.57
- Marker Search Type (K14).....4.190
- Marker Stepsize4.58
- Marker Stepsize (remote control).....6.65
- Marker to Trace4.55
- Marker to Trace (K30).....4.254
- Marker to Trace (remote control)6.20, 6.63
- Marker to Trace (remote control, K20) ..6.435,
6.460
- Marker to Trace (remote control, K30) .. 6.526
- Marker Zoom4.57
- Marker Zoom (K72)4.269
- Marker Zoom (K91/K91n).....4.420
- Marker Zoom (K92/K93).....4.469
- Marker Zoom (remote control)6.80
- Marker Zoom (remote control, K91)6.691
- Marker Zoom (remote control, K92/K93)6.774
- Max Hold4.40, 4.93
- Maximize Size (K14).....4.184
- Maximize Size (remote control, K14).....6.401
- Mean.....4.86
- Mean (remote control)6.96, 6.97
- Meas (K82)4.303
- Meas (K84)4.356
- Meas Carrier (K20).....4.222
- Meas Carrier (remote control, K20).....6.465,
6.466
- Meas Filter (K8)4.167
- Meas Filter (remote control, K8).....6.366
- Meas Settings (K30).....4.247
- Meas Settings (remote control, K30)....6.534,
6.535, 6.543, 6.552, 6.558
- Meas Single/Cont (K91/K91n).....4.419
- Meas Single/Cont (remote control,
K91 / K91n).....6.715
- Meas Start/Stop4.107
- Meas Start/Stop (remote control)6.145
- Meas Time (K7).....4.136
- Meas Time (remote control, K7) .6.306, 6.320
- Meas Time Auto (K8)4.165
- Meas Time Manual (K8)4.165
- Meas Time/Average (K9)4.178
- Meas Time/Average (remote control, K9)
.....6.379, 6.380
- Meas to Ref (K9)4.178
- Meas to Ref (remote control, K9)6.372
- Mem1 On/Off (K30).....4.254
- Mem1 On/Off (remote control, K30).....6.530
- Mem2 On/Off (K30).....4.254
- Mem2 On/Off (remote control, K30).....6.530
- Mem3 On/Off (K30).....4.254
- Mem3 On/Off (remote control, K30).....6.530
- Min4.66
- Min (K14)4.190
- Min (K30)4.255
- Min (K91/K91n).....4.420
- Min (remote control)6.18, 6.60
- Min (remote control, K14)6.387, 6.389, 6.393,
6.395
- Min (remote control, K30).....6.527
- Min (remote control, K91).....6.687
- Min Hold4.40
- MKR -> Trace (K91/K91n).....4.420
- MKR -> Trace (K92/K93).....4.470
- MKR -> Trace (remote control, K91)6.688
- MKR -> Trace (remote control, K92/K93)
.....6.770
- Mkr Demod On/Off4.55

Mkr Demod On/Off (remote control)	6.68	No of Halfslots (K84)	4.389
Mkr List On/Off (remote control)	6.70	No. of ACP Chan (K8)	4.169
Mkr Stop Time	4.56	No. of ACP Chan (remote control, K8) .	6.348, 6.352
Mkr Stop Time (remote control)	6.68	No. of Harmonics.....	4.109
Modulation AM/FM/PM (remote control, K7)	6.280	Noise Meas On/Off.....	4.53
Modulation Analysis (K20).....	4.229	Noise Meas On/Off (remote control)	6.77
Modulation Char (K8)	4.174	Noise Src On/Off (remote control).....	6.122
Modulation Char (remote control, K8) ...	6.337, 6.338, 6.339	Normalize	4.129
Modulation Errors (K20).....	4.230	Normalize (K82).....	4.307
Modulation FM/PM/AM (K7).....	4.135	Normalize (K84).....	4.362
Modulation Options (K20)	4.212	Normalize (remote control).....	6.174
Modulation Options (remote control, K20)	6.496, 6.497, 6.502, 6.503, 6.505, 6.506	Normalize On/Off (K72).....	4.265
Multi Carrier (K82).....	4.299	Normalize On/Off (remote control, K72)	6.584
Multi Carrier (K84).....	4.353	Number of Readings (K9).....	4.179
Multi-Carrier Filter Settings (remote control, K82)	6.606	Number of Readings (remote control, K9)	6.380
Multi-Carrier Filter Settings (remote control, K84)	6.642	OBW	4.95
n dB down	4.56	OBW (remote control)	6.86, 6.90
n dB down (remote control) ...	6.74, 6.75, 6.76, 6.77	Occupied Bandwidth (K82).....	4.334
Name (remote control).....	6.31	Occupied Bandwidth (K84).....	4.387
Name (remote control, K30).....	6.520	Occupied Bandwidth (remote control, K82)	6.606
New	4.117	Occupied Bandwidth (remote control, K84)	6.642
New (K20)	4.212	Output Power (K8).....	4.173
New (K30)	4.256	Output Power (remote control, K8).....	6.340
New (K82)	4.301	Overview (K20).....	4.229
New (K84)	4.355	Packet Bytes SCO (K8)	4.159
New (remote control) ...	6.29, 6.32, 6.41, 6.42, 6.43, 6.49, 6.50, 6.51, 6.52, 6.53	Packet Bytes SCO (remote control, K8)	6.353
New (remote control, K30).....	6.521	Packet Type (K8).....	4.158
New (remote control, K82)	6.604	Packet Type (remote control, K8).....	6.355
New (remote control, K84)	6.639	Password (remote control)	6.253
New Folder (remote control)	6.155	PCCPCH (K72).....	4.270
New Search.....	4.57	PCCPCH (remote control, K72) .	6.563, 6.570
New Segment (K93).....	4.446	Peak	4.65, 4.86
New Zone/Burst (K93).....	4.446	Peak (K14).....	4.188
Next Meas Frequency (K20)	4.224	Peak (K30).....	4.255
Next Meas Frequency (remote control, K20)	6.481, 6.485, 6.489	Peak (K91/K91n)	4.420
Next Min	4.66	Peak (remote control) .	6.16, 6.58, 6.98, 6.100
Next Min (K14)	4.191	Peak (remote control, K14)	6.387, 6.388, 6.393
Next Min (remote control)	6.19, 6.61, 6.62	Peak (remote control, K30)	6.527
Next Min Mode < abs >	4.66	Peak (remote control, K91)	6.687
Next Min X Search < abs > (K14)	4.189	Peak Code Domain Error (K82)	4.315
Next Min Y Search up/abs/dn (K14).....	4.189	Peak Code Domain Error (remote control, K82)	6.595, 6.618
Next Min Y Search up/abs/dn (remote control, K14)	6.390, 6.396, 6.397	Peak Excursion	4.67
Next Peak.....	4.65	Peak Excursion (remote control).....	6.63
Next Peak (K14).....	4.188	Peak List Off.....	4.58
Next Peak (remote control) ...	6.17, 6.18, 6.19, 6.59, 6.60, 6.61, 6.62	Peak Search	4.54
Next Peak Mode < abs >.....	4.65	Peak Search (remote control)	6.14, 6.70, 6.71, 6.72
Next Peak Y Search up/abs/dn (K14) ...	4.188	Peaks per Range.....	4.109
Next Peak Y Search up/abs/dn (remote control, K14)	6.388, 6.389, 6.394, 6.395	Percent Marker	4.96

Ph Noise On/Off (remote control) ..6.13, 6.15, 6.16	Ramp Up/Down/Up & Down (K91/K91n)4.408
Ph Noise/Ref Fixed (remote control).....6.13, 6.15	Ramp Up/Down/Up & Down (remote control, K91) 6.696
Phase Noise 1 2 3 44.54	Range (K8) 4.164
Phase Noise On/Off4.54	Range (remote control, K8) 6.361
Phase Noise/Ref Fixed4.54	Range Lin. Unit 4.14
Phase Unit Rad/Deg (K7).....4.140	Range Lin. Unit (remote control) 6.132
Phase Unit Rad/Deg (remote control, K7)6.324	Range Linear 4.14
Phase Wrap On/Off (K7).....4.140	Range Linear % 4.14
Phase Wrap On/Off (remote control, K7)6.281	Range Linear % (remote control) 6.132
PLCP Header (remote control, K91)6.698	Range Linear (K7) 4.144
PN Offset.....4.354	Range Log 4.144
PN Offset (K82).....4.299	Range Log (remote control) 6.132
Points / Symbol (K8)4.162	Range Log (remote control, K20) 6.471
Points / Symbol (remote control, K8)6.355	Recall.....4.130
Power (Average Mode)4.45	Recall (remote control) 6.176
Power (K72)4.276	Recall File (remote control) 6.155
Power (K82)4.331	Ref Level 4.14
Power (K84)4.384	Ref Level (K8).....4.164
Power (remote control, K72)6.572	Ref Level (remote control)..... 6.113, 6.133
Power (remote control, K82)6.606	Ref Level (remote control, K20) 6.472
Power (remote control, K84)6.642	Ref Level Adjust Man/Auto (remote control) 6.176
Power Avg Start (K8)4.169	Ref Level Offset 4.15
Power Avg Stop (K8).....4.169	Ref Level Offset (remote control) 6.133
Power Class (K8)4.159	Ref Level Offset (remote control, K20).. 6.472
Power Control Group (K82).....4.305	Ref Level Position..... 4.15
Power Level (remote control, K91 / K91n)6.745	Ref Level Position (remote control) 6.133
Power Meter4.122	Ref Level Position (remote control, K20)6.472
Power Mode4.92	Ref Lvl =Mkr Lvl.....4.65
Power Mode (remote control).....6.86	Ref Lvl =Mkr Lvl (remote control) 6.78
Power Offset4.129, 6.230	Ref Point Frequency.....4.54
Power Ref TOT/CPICH (K72)4.263	Ref Point Frequency (remote control) 6.14
Power Ref TOT/CPICH (remote control, K72)6.585	Ref Point Level 4.54
Power Reference (K82).....4.306	Ref Point Level (remote control)..... 6.14
Power vs PCG (K82).....4.310	Ref Point Time (remote control) 6.14
Power vs PCG (remote control, K82)....6.595, 6.618	Ref Pow Max/Mean (K91/K91n) 4.408
Power vs Symbol (K82).....4.318	Ref Pow Max/Mean (remote control, K91) 6.695
Powermeter On/Off (K9)4.177	Ref Value 4.130
Powermeter On/Off (remote control, K9)6.378	Ref Value (remote control) 6.134
Preamp On/Off.....4.15	Ref Value Position 4.130
Preamp On/Off (remote control)6.147	Ref Value Position (remote control) 6.133
Predefined Colors (remote control).....6.126, 6.138	Ref Value Position (remote control, K20) 6.472
Print Screen (remote control).....6.136, 6.137, 6.141, 6.156	Reference Channel (K20).....4.222
PvT (K84)4.389	Reference Channel (remote control, K20) 6.483, 6.486, 6.490
PVT (K91/K91n)4.406	Reference Fixed 4.54
PVT (K92/K93)4.447	Reference Fixed On/Off 4.55
PVT (remote control, K91)6.695	Reference Int/Ext (remote control) 6.222, 6.229
PVT (remote control, K92/K93)6.782	Reference Manual 4.390
R&S Support (K91/K91n)4.409	Reference Mean Power (K84) 4.390
R&S Support (K92/K93)4.451	Reference Mean Power (remote control, K84) 6.643
	Reference Position (K7) 4.137
	Reference Position (K8) 4.164

- Reference Position (remote control, K7) 6.290
Reference Position (remote control, K8) 6.361
Reference Power (K20).....4.222
Reference Power (remote control, K20) 6.484,
6.487, 6.490
Reference Value (K7).....4.137
Reference Value (K8).....4.164
Reference Value (K9).....4.179
Reference Value (remote control, K7) ...6.290
Reference Value (remote control, K8) ...6.361
Reference Value (remote control, K9) ...6.372
Refresh (K91/K91n)4.419
Refresh (K92/K93)4.468
Refresh (remote control, K92/K93)6.820
Rel TX Power (K8)4.174
Rel TX Power (remote control, K8)6.342,
6.343
Reload (K82)4.304
Reload (K84)4.357
Rename (remote control)6.155
Repetition Intervall.....4.31
Res BW4.96
Res BW (K7)4.146
Res BW (K82)4.335
Res BW (K84)4.388
Res BW (remote control)6.170
Res BW (remote control, K7)6.311
Res BW Auto4.20
Res BW Auto (K8).....4.166
Res BW Auto (remote control)....6.170, 6.171
Res BW Auto (remote control, K8)6.349
Res BW Manual4.20
Res BW Manual (K8)4.166
Res BW Manual (remote control)6.170
Res BW Manual (remote control, K8)....6.348
Restart on Fail (K84)4.390
restart on Fail (remote control, K84)6.643
restor STD Lines (K84)4.390
Restore Default Tables (K20)4.213
Restore Default Tables (K82)4.304
Restore Default Tables (K84)4.359
Restore Default Tables (remote control, K82)
.....6.607
Restore Default Tables (remote control, K84)
.....6.641
Restore FSL K82 Files (K82)4.334
Restore FSL K82 Files (remote control, K82)
.....6.597
Restore FSL K84 Files (K84)4.387
Restore FSL K84 Files (remote control, K84)
.....6.630
Restore Standard Files4.107
Restore Std Lines (K72).....4.281
Restore Std Lines (remote control, K72) 6.566
Result (remote control, K82)6.612, 6.613,
6.614, 6.616
Result (remote control, K84)6.650
Result Display (K7).....4.135
Result Settings (K82)4.304
Result Settings (K84).....4.359
Result Summary (K82)4.310
Result Summary (remote control, K82) 6.595,
6.599, 6.618
Result Summary Extended (K72)4.275
Result Summary Extended (remote control,
K72)6.586
Result Summary Normal (K72)4.274
Revision 0 A (remote control, K84)6.644
Revision 0/A (K84).....4.352
RF
SLOT (remote control, K84).....6.645
RF (K20)4.214
RF (remote control, K20)6.498
RF Atten Auto4.15
RF Atten Auto (remote control)6.146
RF Atten Manual.....4.15
RF Atten Manual (K20).....4.217
RF Atten Manual (remote control)6.146
RF Slot Full Idle (K84)4.389
RF Spectrum (K7)4.136
RF Stepsize (K20)4.215
RF Time Domain (K7)4.136
Right Limit.....4.67, 4.87
Right Limit (remote control)6.65
Rising & Falling (K91/K91n)4.407
Rising & Falling (remote control, K91)....6.696
Rising/Falling (K93)4.449
RMS.....4.86
RMS (remote control)6.101, 6.103
Run Single/Cont (K92/K93)4.468
Same as Meas Channel (K20)4.223
Save (K82).....4.304
Save (K84).....4.357
Save (remote control).....6.163
Save As Standard.....4.107
Save Changes (K20)4.213
Save Evaluation List4.106
Save Evaluation List (remote control)....6.162
Save File (remote control)6.163
Save Limit Line4.118
Scaling.....4.96
Scaling (K82)4.322, 4.327, 4.335
Scaling (K84)4.375, 4.388
Schematic (K30).....4.250
Scrambling Code (K72)4.263, 4.264
Scrambling Code (remote control, K72) 6.582,
6.583
Scrambling Code Autosearch (K72).....4.264
Scrambling Code Autosearch (remote
control, K72).....6.583
Screen A/B (K91/K91n)4.421
Screen A/B (remote control, K82)6.608
Screen A/B (remote control, K84)6.646
Screen A/B (remote control, K91)6.702
Screen Colors (remote control) . 6.126, 6.137,
6.138
Screen Focus A/B (K82).....4.307
Screen Focus A/B (K84).....4.362

- Screen Focus A/B (K92/K93)4.471
Screen Focus A/B (remote control, K92/K93)
.....6.802, 6.803
Screen Full/Split (K91/K91n).....4.422
Screen Full/Split (remote control, K91) ..6.702
Screen Size (remote control, K82)6.608
Screen Size (remote control, K84)6.646
Screen Size Full/Split (K82)4.307
Screen Size Full/Split (K84)4.362
Screen Size Full/Split (K92/K93).....4.471
Screen Size Full/Split (remote control,
K92/K93).....6.802
Screen Title (remote control)6.129
Search Len Auto (K8).....4.161
Search Len Manual (K8)4.162
Search Len Manual (remote control, K8)
.....6.368, 6.369
Search Lim Off4.67
Search Lim Off (remote control) ...6.64, 6.115
Search Limits4.66
Search Limits (remote control).....6.64
Search Mode (K14)4.188
Search Signals4.85
Select 1 2 3 44.64
Select 1 2 3 4 (K14)4.187
Select 1 2 3 4 (K82)4.329
Select 1 2 3 4 (K84)4.382
Select 1 2 3 4 (remote control).....6.55, 6.66
Select 1 2 3 4 (remote control, K14)6.386,
6.392
Select Ch/PCG (K82)4.313
Select Channel (K72)4.262
Select Channel (remote control, K72) ...6.581
Select Code Slot (K84).....4.359
Select CPICH Slot (K72)4.263
Select CPICH Slot (remote control, K72)
.....6.587
Select Directory (remote control)6.178
Select Frame (remote control, K14).....6.400
Select Items (remote control).....6.160, 6.161
Select Meas (K82).....4.307
Select Meas (K84).....4.362
Select Print Color Set (remote control) ..6.137
Select Search Area (K14)4.190
Select Search Area (remote control, K14)
.....6.386, 6.392
Select Slot (remote control, K84)6.655
Select Trace4.10, 4.93
Select Trace (K7)4.136
Select Trace (K8)4.162
Select Trace (remote control)6.92, 6.221
Select Traces to check.....4.116
Select Traces to check (remote control) .6.31,
6.32
Self Align (remote control).....6.118
Selftest (remote control).....6.9
Selftest Results (remote control).....6.123
SEM Settings (K92/K93)4.450
Service Function (remote control).....6.122
Set Mean To Manual (K84)4.390
Set Standard.....4.107
Set Standard (remote control).....6.183
Set to Default (remote control) ... 6.126, 6.137
Settings (K82).....4.293
Settings (K84).....4.349
Settings General/Demod (K91/K91n).... 4.397
Settings General/Demod (K92/K93)..... 4.431
Settings General/Demod (remote control,
K92/K93)6.783, 6.787, 6.788, 6.789, 6.790,
6.791, 6.792, 6.793, 6.794, 6.795, 6.796,
6.797, 6.798, 6.799, 6.800, 6.801, 6.805,
6.826, 6.827, 6.828, 6.829, 6.830, 6.831,
6.836, 6.837, 6.839, 6.840, 6.841, 6.846,
6.854, 6.856, 6.857, 6.860
Settings General/Demod (remote control,
K93) 6.835, 6.836
Settings Overview (K82).....4.294
Settings Overview (K84).....4.349
Shift X Limit Line (remote control) 6.43
Shift Y Limit Line (remote control) .. 6.49, 6.53
Shoulder Atten On/Off (K20) 4.221
Show Align Results (remote control) 6.118,
6.119
Show List (K72)4.264
Show List (remote control, K72) 6.583
Show Peaks.....4.105
Show Peaks (remote control) 6.25
Sig Count On/Off4.55
Sig Count On/Off (remote control).. 6.56, 6.57
Signal Field (K91/K91n).....4.417
Signal Field (remote control, K91)..... 6.698
Signal Level (K20)4.216
Signal Track4.9
Signal Track (remote control) 6.91
Single Meas (remote control) 6.143, 6.144
Single Sweep.....4.23
Single Sweep (K8).....4.168
Single Sweep (remote control) ... 6.143, 6.144
Soft Frontpanel (remote control) 6.248
Sort (K82)4.304
Sort (K84)4.356
Sort Mode Freq/Lvl4.57
Sort Mode Freq/Lvl (remote control) 6.71
Source Cal.....4.129
Source On/Off4.128
Source On/Off (remote control).....6.165
Source Power4.128, 6.230
Span Manual4.12
Span Manual (K7).....4.142
Span Manual (remote control).....6.197
Span Manual (remote control, K7) 6.313
Spectrogram4.122
Spectrogram Clear (K14)4.186
Spectrogram Clear (remote control, K14)
.....6.398
Spectrogram On/Off (K14)4.184
Spectrogram On/Off (remote control, K14)
.....6.398

Spectrum (K20).....	4.220, 4.229
Spectrum (K91/K91n).....	4.413
Spectrum (K92/K93).....	4.457
Spectrum ACPR (K91/K91n).....	4.415
Spectrum ACPR (remote control, K91).....	6.690, 6.696
Spectrum Emission Mask	4.98
Spectrum Emission Mask (K72).....	4.279
Spectrum Emission Mask (K82).....	4.332
Spectrum Emission Mask (K84).....	4.385
Spectrum Emission Mask (remote control, K72).....	6.572
Spectrum Emission Mask (remote control, K82).....	6.606
Spectrum Emission Mask (remote control, K84).....	6.642
Spectrum ETSI/IEEE (K91/K91n)	4.413
Spectrum ETSI/IEEE (K92/K93)	4.459
Spectrum FFT (K91/K91n).....	4.414
Spectrum FFT (K92/K93).....	4.461
Spectrum FFT (remote control, K91).....	6.696
Spectrum FFT (remote control, K92/K93)	6.784
Spectrum Flat./Diff./Group Delay (K92/K93)	4.457
Spectrum Flat./Diff./Group Delay (remote control, K92/K93).....	6.784, 6.785
Spectrum Flatness (K91/K91n).....	4.413
Spectrum Flatness (remote control, K91)	6.697
Spectrum IEEE/ETSI (remote control, K91)	6.697
Spectrum IEEE/ETSI (remote control, K92/K93).....	6.785
Spectrum Mask (K91/K91n).....	4.413
Spectrum Mask (remote control, K91).....	6.697
Spurious Emissions.....	4.108
Spurious Emissions (K8).....	4.174
Spurious Emissions (remote control, K8)	6.335, 6.336
Start.....	4.7, 4.12
Start (K82).....	4.320
Start (K84).....	4.373
Start End (K92/K93)	4.448
Start End (remote control, K92/K93).....	6.783
Start Test (K8).....	4.168
Startup Recall (remote control).....	6.154
Statistics (K91/K91n).....	4.415
Statistics (K92/K93).....	4.464
Std Dev	4.87
Std Dev (remote control).....	6.103, 6.105
Stepsize Standard	4.58
Stepsize Standard (remote control)	6.65
Stepsize Sweep Points.....	4.59
Stepsize Sweep Points (remote control).....	6.65
Stop.....	4.7, 4.12
Stop (K82).....	4.320
Stop (K84).....	4.373
Swap IQ (K82).....	4.296
Swap IQ (K84).....	4.351
Sweep Count	4.24, 4.42
Sweep Count (K8)	4.169
Sweep Count (remote control)	6.223
Sweep Count (remote control, K8)	6.357
Sweep List.....	4.98
Sweep List (remote control)	6.184, 6.185, 6.186, 6.187, 6.188, 6.189, 6.190, 6.191, 6.192, 6.204, 6.205, 6.206, 6.207, 6.208
Sweep Points.....	4.24
Sweep Points (remote control)	6.227
Sweep Single/Cont (K30)	4.252
Sweep Single/Cont (remote control, K30)	6.529
Sweep Time.....	4.32, 4.93
Sweep Time (remote control).....	6.227
Sweeptime Auto	4.21, 4.23
Sweeptime Auto (K8).....	4.166
Sweeptime Auto (K82).....	4.21
Sweeptime Auto (remote control).....	6.228
Sweeptime Auto (remote control, K8)	6.358
Sweeptime Manual	4.21, 4.23
Sweeptime Manual (K20)	4.228
Sweeptime Manual (K8)	4.166
Sweeptime Manual (remote control)	6.227
Sweeptime Manual (remote control, K8).....	6.358
Sync Offset (K8)	4.160
Sync Offset (remote control, K8)	6.368
Sync Type CPICH/SCH (K72)	4.266
Sync Type CPICH/SCH (remote control, K72)	6.587
System Messages (remote control).....	6.249, 6.250
Threshold.....	4.67
Threshold (remote control).....	6.115
Tilt (K20).....	4.233
Tilt Setup (K20).....	4.233
Tilt Setup (remote control, K20)	6.503
Time / Phase Estimation (K82).....	4.299
Time / Phase Estimation (K84).....	4.353
Time Domain Power	4.86
Time Domain Power (remote control)	6.94
Time Line 1.....	4.119
Time Line 1 (remote control).....	6.116
Time Line 2.....	4.119
Time Line 2 (remote control)	6.116
Time Stamp On/Off (K14)	4.184
Time Stamp On/Off (remote control, K14)	6.401
Time+Date (remote control)	6.248, 6.254
Time+Date On/Off (remote control)	6.129
TOI.....	4.85
TOI (remote control).....	6.78, 6.79
Trace 1 2 3 4 5 6	4.40
Trace 1 2 3 4 5 6 (remote control).....	6.130
Trace 1 2 3 4 5 6 (remote control, K20)	6.470
Trace 1 2 3 4 5 6 (remote control, K8)	6.360
Trace Math	4.43
Trace Math (remote control).....	6.106, 6.107

Trace Math Position	4.44
Trace Mode	4.40
Trace Mode (K82)	4.326
Trace Mode (K84)	4.379
Trace Mode (remote control) 6.95, 6.96, 6.97, 6.98, 6.99, 6.101, 6.102, 6.103, 6.104, 6.130, 6.132	
Trace Mode (remote control, K20)	6.470, 6.471
Trace Mode (remote control, K8)	6.359
Track BW	4.9
Track BW (remote control)	6.91
Track On/Off	4.9
Track On/Off (remote control)	6.91
Track Threshold	4.10
Track Threshold (remote control)	6.92
Tracking Generator	4.122
Trg / Gate Level	4.30
Trg / Gate Level (remote control)	6.272
Trg / Gate Polarity Pos/Neg	4.30
Trg / Gate Polarity Pos/Neg (remote control)	6.225, 6.272
Trg / Gate Source	4.29
Trg / Gate Source (remote control)	6.226, 6.271, 6.272
Trg/Gate Level (K8)	4.171
Trigger Level (K9)	4.180
Trigger Offset	4.30
Trigger Offset (K20)	4.228
Trigger Offset (K7)	4.148
Trigger Offset (remote control)	6.270
Trigger Polarity (K82)	4.297
Trigger Polarity (K84)	4.351
Trigger Polarity Pos/Neg (K82)	4.326
Trigger Polarity Pos/Neg (K84)	4.379
Trigger Source (K7)	4.147
Trigger Source (K72)	4.268
Trigger Source (K8)	4.171
Trigger Source (K82)	4.296, 4.326
Trigger Source (K84)	4.351, 4.379
Trigger Source (remote control, K7)	6.323
Trigger Source (remote control, K72)	6.593
TV Analyzer (K20)	4.233
TV Free Run On/Off	4.34
TV Free Run On/Off (remote control)	6.273
TV Trig Settings	4.33
TX Spec ACP (K8)	4.173
TX Spec ACP (remote control, K8)	6.327, 6.328
Unit	4.16
Unit (K20)	4.217, 4.231
Unit (remote control)	6.117, 6.276
Unit (remote control, K20)	6.433, 6.456, 6.457, 6.464, 6.516
Unit/Scale (K9)	4.178
Unit/Scale (remote control, K9)	6.373, 6.383
Unzoom (K91/K91n)	4.420
Unzoom (K92/K93)	4.469
Unzoom (remote control, K91)	6.691
Unzoom (remote control, K92/K93)	6.774
Update Path (remote control)	6.250
Use Ref Lev Offset (K9)	4.179
Use Ref Lev Offset (remote control, K9)	6.381
User Defined Colors (remote control)	6.137, 6.138
Value	4.117
Value (remote control)	6.41, 6.47, 6.51
Velocity Factor (K20)	4.231
Velocity Factor (remote control, K20)	6.492
Versions+Options (remote control)	6.7
Vert Sync	4.33
Vert Sync (remote control)	6.274
Vert Sync Even Field	4.33
Vert Sync Even Field (remote control)	6.274
Vert Sync Odd Field	4.33
Vert Sync Odd Field (remote control)	6.274
Video BW Auto	4.21
Video BW Auto (K8)	4.166
Video BW Auto (remote control)	6.172, 6.173
Video BW Auto (remote control, K8)	6.350
Video BW Manual	4.20
Video BW Manual (K8)	4.166
Video BW Manual (remote control)	6.172
Video BW Manual (remote control, K8)	6.349
Video Pol Pos/Neg	4.34
Video Pol Pos/Neg (remote control)	6.275
Video Scope (K20)	4.227
View	4.41
Vision Modulation (K20)	4.228
Vision Modulation (remote control, K20)	6.432
Volume	4.56
Volume (remote control)	6.255
X * RBW	4.8
X * RBW (remote control)	6.195, 6.196
X * Span	4.8
X * Span (remote control)	6.195, 6.196
x Offset (remote control)	6.42
x*Demod BW (K7)	4.142
x-Axis Range	4.96
x-Axis Range (remote control)	6.112
x-Axis Ref Level	4.96
x-Axis Ref Level (remote control)	6.113
XML Export (K82)	4.334
XML Export (K84)	4.387
XML Export (remote control)	6.184, 6.617
XML Import (K82)	4.333
XML Import (K84)	4.386
y Offset (remote control)	6.48, 6.52
y-Axis Max Value	4.97
y-Axis Max Value (remote control)	6.114
y-Axis Maximum (K82)	4.323, 4.327
y-Axis Maximum (K84)	4.376
y-Axis Min Value	4.97
y-Axis Minimum (K82)	4.323, 4.327
y-Axis Minimum (K84)	4.376
Y-Axis/Div (K91/K91n)	4.410
Y-Axis/Div (K92/K93)	4.456
Y-Axis/Div (remote control, K91)	6.703

Y-Axis/Div (remote control, K92/K93)	6.804
y-Unit %/Abs.....	4.97
y-Unit %/Abs (remote control).....	6.114
Zero (K9).....	4.178
Zero (remote control, K9).....	6.374
Zero Phase Reference Point (K7).....	4.140
Zero Phase Reference Point (remote control, K7).....	6.309
Zero Span	4.12
Zero Span (remote control).....	6.197
Zoom (K20).....	4.229, 4.230, 4.231
Zoom (K7).....	4.140
Zoom (K8).....	4.169
Zoom (remote control, K20).....	6.472, 6.473, 6.474
Zoom (remote control, K7).....	6.314
SPAN key.....	4.11
span menu	
base unit.....	4.11
K7 option	4.142
K82 option	4.321
K84 option	4.374
special characters.....	6.3
spectrogram (K14)	
menu	4.181
spectrogram menu (K14).....	4.183
Spectrum Analyzer mode	4.120
Spectrum Emission Mask (K82).....	4.287
Spurious Emissions measurement (K8) ...	4.156
SRE (service request enable register).....	5.16
SRQ (service request).....	5.16, 5.24
start frequency.....	4.7
status bar	
K30 option	4.239
K91/K91n option.....	4.396
K92/K93 option.....	4.429
status byte (STB).....	5.16
STATus OPERation register.....	5.18
STATus QUESTionable register.....	5.18
ACPLimit register	5.20
FREQuency register.....	5.20
LIMit register	5.21
LMARgin register	5.22
POWER register	5.22
SYNC	5.23
status register	
CONDition part.....	5.13
ENABLE part	5.14
ESE	5.17
ESR.....	5.17
EVENT part	5.14
NTRansition part.....	5.14
overview	5.15
PPE	5.17
PTRansition part	5.14
SRE.....	5.16
STATus OPERation	5.18
STATus QUESTionable	5.18
STATus QUESTionable ACPLimit	5.20
STATus QUESTionable FREQuency.....	5.20
STATus QUESTionable LIMit.....	5.21
STATus QUESTionable LMARgin	5.22
STATus QUESTionable POWER.....	5.22
STATus QUESTionable SYNC.....	5.23
STB.....	5.16
structure.....	5.13
sum bit.....	5.14
status reporting system.....	5.13
resetting values	5.25
WiMAX, WiBro measurements (K92/K93)	5.41
STB (status byte)	5.16
step size	
center frequency.....	4.8
stop frequency.....	4.7
storing	8.1
string	5.9
subchannelization (K92/K93)	2.148
suffix.....	5.7
sum bit.....	5.14
supported tests (K8).....	2.37
sweep	
continue single sweep	4.23
continuous	4.23
count.....	4.24, 4.42
Free Run.....	4.28
gated.....	4.25, 4.31
single	4.23
time.....	4.23
SWEEP key	4.22
sweep menu	
base unit.....	4.22
K14 option	4.185
K30 option	4.252
K7 option	4.146
K8 option	4.167
K82 option	4.324
K84 option	4.378
K91/K91n option	4.418
K92/92 option	4.468
sweep time	
coupling	4.21
Symbol Constellation (K84).....	4.370
Symbol EVM rms / Pk (K82)	4.312
symbols	
WiMAX, WiBro measurements (K93)....	2.152
SYNC	4.292
sync signal	4.33
sync word (K8)	2.43, 4.159
synchronization	
K92/K93 option	2.148
K93 option	2.154
syntax elements of commands	5.10
T	
TD	4.292
TDPICH.....	4.292
test	

- supported (K8) 2.37
 - transmitter (K8) 2.37
 - test setup
 - analog TV (K20) 2.47
 - base station tests (K72) 2.112
 - base station tests (K82) 2.126
 - digital TV (K20) 2.69
 - text parameter 5.9
 - threshold
 - line 4.67
 - signal tracking 4.10
 - Tilt Setup dialog box (K20) 4.233
 - time
 - line 4.119
 - Timing Offset (K82) 4.313
 - title bar
 - K91/K91n option 4.396
 - K92/K93 option 4.429
 - Total PWR (K82) 4.312
 - trace 4.40
 - Clear Write 4.36
 - power measurement 4.93
 - signal tracking 4.10
 - TRACE key 4.35
 - trace menu
 - base unit 4.39
 - K20 option 4.217
 - K30 option 4.253
 - K82 option 4.326
 - K84 option 4.379
 - K91/K91n option 4.421
 - K93 option 4.470
 - trace mode 4.40
 - Average 4.36, 4.40
 - Blank 4.37, 4.41
 - Clear Write 4.36, 4.40
 - Max Hold 4.36, 4.40
 - Min Hold 4.36, 4.40
 - View 4.36, 4.41
 - tracking generator 4.125
 - menu 4.125, 4.127
 - transmission measurement 4.126
 - transmitter tests (K8) 2.37
 - Trg to Frame (K82) 4.312
 - TRIG key 4.25
 - trigger
 - concepts (K8) 2.42
 - extern (K8) 2.43
 - external 4.28
 - external gate 4.31
 - gated sweep 4.31
 - level 4.30
 - offset 4.30
 - slope 4.30
 - trigger menu
 - base unit 4.29
 - K7 option 4.147
 - K72 option 4.268
 - K8 option 4.171
 - K82 option 4.325
 - K84 option 4.379
 - K91/K91n option 4.397
 - K92/K93 option 4.431
 - trigger mode 4.29
 - External 4.28
 - Free Run 4.28
 - IF power 4.28
 - TV 4.28
 - Video 4.28
 - TV trigger 4.33
 - TX filter (K20) 2.64
- U**
- unit 4.178
 - universal command 5.32
 - upper-case (commands) 5.6, 6.3
- V**
- velocity factor (K20) 2.74
 - vertical sync signal 4.33
 - video bandwidth 4.20
 - video polarity 4.34
 - video triggering 4.28
 - View trace mode 4.36
 - VXI interface messages 5.28
 - VXI protocol 5.27
- W**
- Walsh code 4.292
 - white space 5.10
 - WiMAX menu (K92/K93) 4.424, 4.430
 - WiMAX mode (K92/92) 4.121
 - WLAN menu (K91/K91n) 4.391, 4.396
 - WLAN mode (K91/K91n) 4.121
- Z**
- zero span 4.12
 - zeroing (K9) 4.176
 - zoom 4.57
 - amplitude 4.37