

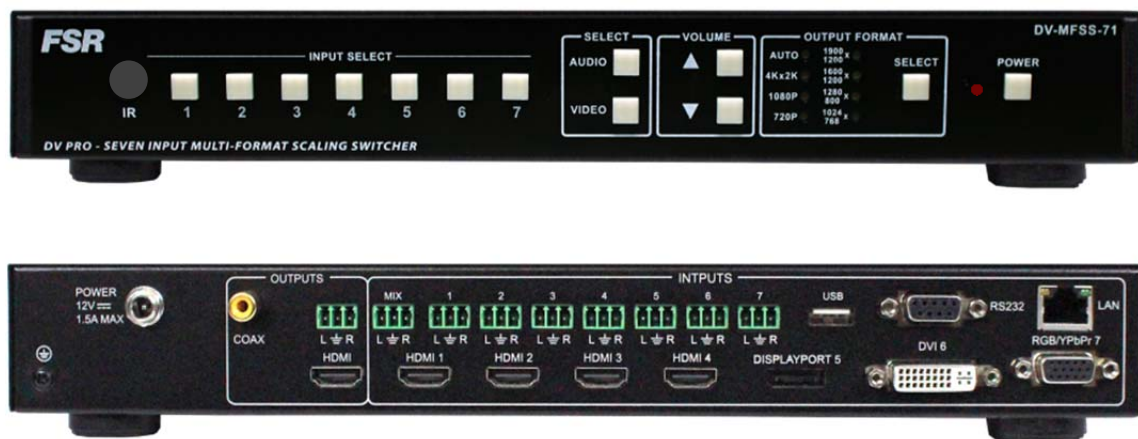

205 Westwood Ave, Long Branch, NJ 07740
Phone: 866-94 BOARDS (26273) / (732)-222-1511
Fax: (732)-222-7088 | E-mail: sales@touchboards.com

4K 7x1 Multi-format Presentation Switcher DV-MFSS-71

Based on firmware revision 1.11 and FSR1.0.0.L



244 Bergen Blvd Woodland Park NJ 07424 973-785-4347 www.fsrinc.com

PROPRIETARY INFORMATION

All information in this manual is proprietary to and the property of FSR Inc. This publication is protected by the Federal Copyright Law, with all rights reserved. No part of this document may be reproduced, transcribed, or transmitted, in any form or by any means, without prior explicit written permission from FSR Inc.

UNPACKING

The DV-MFSS-71 7x1 Switcher package includes the following items:

- DV-MFSS-71 7x1 switcher
- IR remote control
- Rack ears
- Under table brackets
- User's manual
- 12VDC 4A power supply
- 8 Screws
- 9 3-Pin screw terminal



- HDMI is a trademark of HDMI licensing, LLC.
- DisplayPort
- Specifications may be changed without any notice in order to improve the function of the product.

LIMITED WARRANTY

The DV-MFSS-71 is warranted against failures due to defective parts or faulty workmanship for a period of three years after delivery to the original owner. During this period, FSR will make any necessary repairs or replace the unit without charge for parts or labor. Shipping charges to the factory or repair station must be prepaid by the owner, return-shipping charges (via UPS Ground) will be paid by FSR.

This warranty applies only to the original owner and is not transferable. In addition, it does not apply to repairs done by other than the FSR factory or Authorized Repair Stations.

This warranty shall be cancelable by FSR at its sole discretion if the unit has been subjected to physical abuse or has been modified in any way without written authorization from FSR. FSR's liability under this warranty is limited to repair or replacement of the defective unit.

FSR will not be responsible for incidental or consequential damages resulting from the use or misuse of its products. Some states do not allow the exclusion of incidental or consequential damages, so the above limitations may not apply to you. This warranty gives you specific legal rights, and you may also have other rights which vary from state to state.

Warranty claims should be accompanied by a copy of the original purchase invoice showing the purchase date (if a Warranty Registration Card was mailed in at the time of purchase, this is not necessary). Before returning any equipment for repair, please read the important information on service below.

SERVICE

Before returning any equipment for repair, please be sure that it is adequately packed and cushioned against damage in shipment, and that it is insured. We suggest that you save the original packaging and use it to ship the product for servicing. Also, please enclose a note giving your name, address, phone number and a description of the problem.

NOTE: all equipment being returned for repair must have a Return authorization (RMA) Number. To get a RMA Number, please call the FSR Service Department (1-800-332-FSR1). Please display your RMA Number prominently on the front of all packages.

CONTACT INFORMATION
FSR INC.
244 Bergen Blvd.
Woodland Park, NJ 07424
Phone: (973) 785-4347
Order Desk Fax: (973) 785-4207
E-mail: sales@fsrinc.com
Web Site: www.fsrinc.com

SURGE PROTECTION DEVICE RECOMMENDED

This product contains sensitive electrical components that may be damaged by electrical spikes, surges, electric shock, lightning strikes, etc. Use of surge protection systems is highly recommended in order to protect and extend the life of your equipment.

SAFETY

- All the safety and user manual should be read before the appliance is operated.
- The safety and operating instructions should be retained for future reference.
- Unplug this product from the wall outlet before cleaning. Do not use liquid cleaners or aerosol cleaners. Use a damp cloth for cleaning.
- Do not use this equipment near wet place.
- This product should be operated only from the type of power sources indicated on the marking label. If you are not sure of the type of power supplied to your home, consult your local power company.
- This equipment may be equipped with a 3 wire grounding-type plug, a plug having a third (grounding) pin. This pin will only fit in to a grounding type power outlet. This is a safety feature. If you are unable to insert the plug in to the outlet, contact your electrician to replace your obsolete outlet. Do not defeat the safety purpose of the grounding-type plug.
- Openings on the case are provided for ventilation and to ensure reliable operation of the equipment and to protect it from overheating. The openings should never be blocked.
- Do not use any damaged power cords or plugs, or loosed outlets, this may cause electrical shock or fire.
- Do not put heavy articles such as other equipment on this product. Keep it away from liquid, magnetic and flammable substances.

TABLE OF CONTENTS

PROPRIETARY INFORMATION	3
UNPACKING	3
LIMITED WARRANTY	4
SAFETY	5
DESCRIPTION	8
FEATURES	8
TYPICAL APPLICATION	9
AUDIO BLOCK DIAGRAM.....	9
DIMENSIONS	10
FRONT PANEL.....	11
VGA INPUT AUTO ADJUST BEHAVIOR:	11
REAR PANEL	12
OPERATION.....	13
IR REMOTE CONTROL	14
ON SCREEN DISPLAY (OSD)	15
IP SETTINGS	16
OSD	16
IP CONFIGURATION TOOL APPLICATION	17
FIRMWARE UPDATE (EXTERNAL CONTROL BOARD).....	20
EMBEDDED WEB SERVER.....	21
CONTROL PORTS.....	23
RS-232 SETTINGS	23
ETHERNET SETTINGS.....	23
RS-232 SERIAL AND ETHERNET CONTROL PROTOCOL.....	24
FIRMWARE UPDATE (AUDIO AND VIDEO BOARD)	29
SPECIFICATIONS	30

DESCRIPTION

The DV-MFSS-71 7 x 1 Seamless Switcher has been designed to address the needs of the corporate, education, medical, and houses of worship fields. It can be easily operated from the front panel or remotely with a Flex Control System to create a powerful and cost effective switching system.

The DV-MFSS-71 features 4 HDMI, 1 Display Port, 1 DVI and 1 HD-15 video inputs. The HDMI inputs are HDCP compliant and accept resolutions up to 4K 2160p (3840x2160) @ 30Hz. The HD-15 input supports VGA, RGB, and YPbPr input up to 1920x1200 @ 60Hz.

The DV-MFSS-71 has an HDCP compliant output that supports resolutions up to 4K 2160p (3840x2160) @ 30Hz. Each of the inputs is scaled to match the output resolution and switching between them is seamless and instantaneous, meaning no still frame or black screen during switching.

The HDMI input has embedded audio along with analog stereo inputs. The DisplayPort, DVI and VGA also have an analog stereo input. There is an additional analog input that is mixed into the audio output for voice over program applications. All analog audio inputs are via captive screw terminals. The HDMI inputs support up to 7.1 multichannel embedded audio. The audio can follow the video during switching or can be switched separately in breakaway mode. Audio outputs are available either embedded on the HDMI port, via the multi-channel digital coaxial, or via stereo analog out connectors.

FEATURES

- Upscaler and downscaler 7x1 switcher
- 4 HDMI, 1 DisplayPort, 1 DVI, 1 VGA (RGB/YPbPr)
- HDMI up to 4kx2k 30Hz and DisplayPort up to 4kx2k 60Hz
- HDMI output supports resolutions up to 4Kx2K 30Hz
- Each source input is automatically scaled to match the optimal output resolution
- Each input also has an unbalanced stereo audio input via captive screw terminals
- Coax and HDMI supports up to 7.1 audio channels
- HDCP compliant
- Additional mix Stereo audio input
- Easy-to-use front panel control, Web GUI, IR, RS- 232 and Telnet.
- Can be controlled via FSR's FLEX Touch Panel Control System with pre-made templates available.
- 1 RU Height, 19" wide with rack ears
- VGA input with auto adjust

TYPICAL APPLICATION

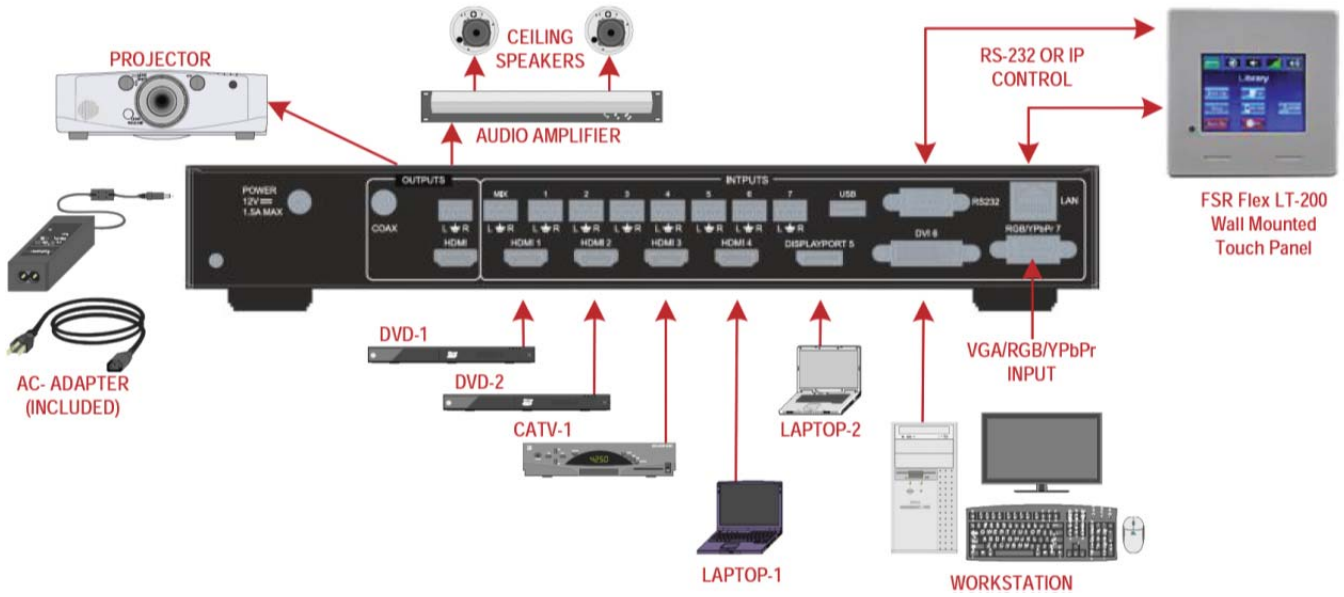

AUDIO BLOCK DIAGRAM

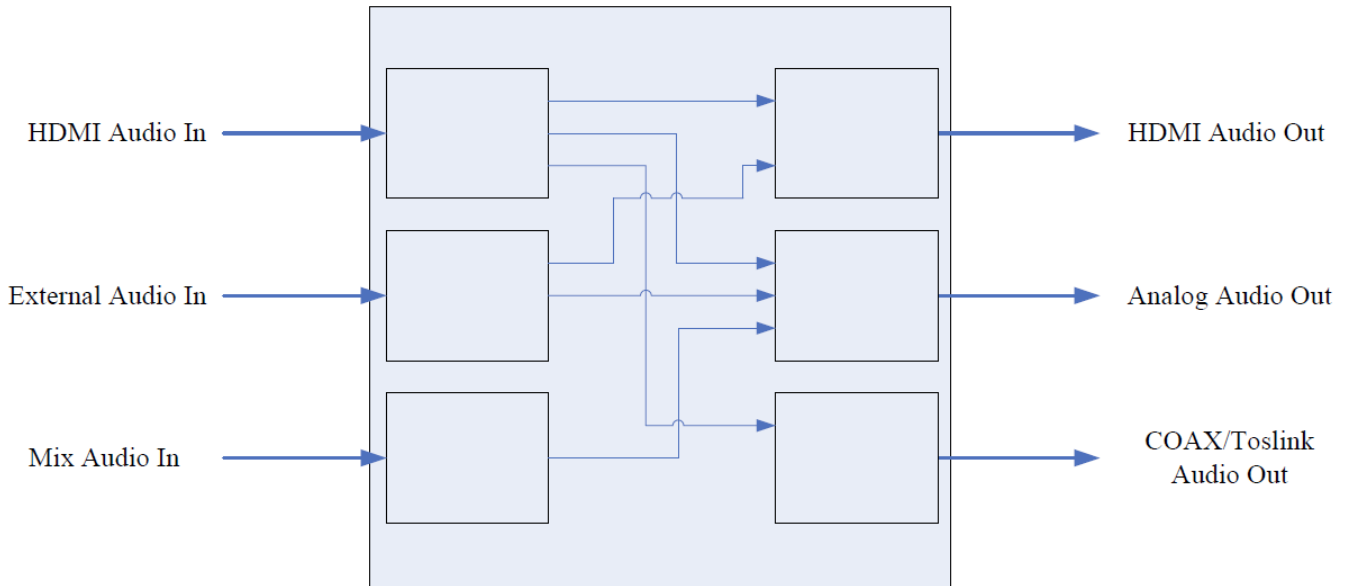

FRONT PANEL

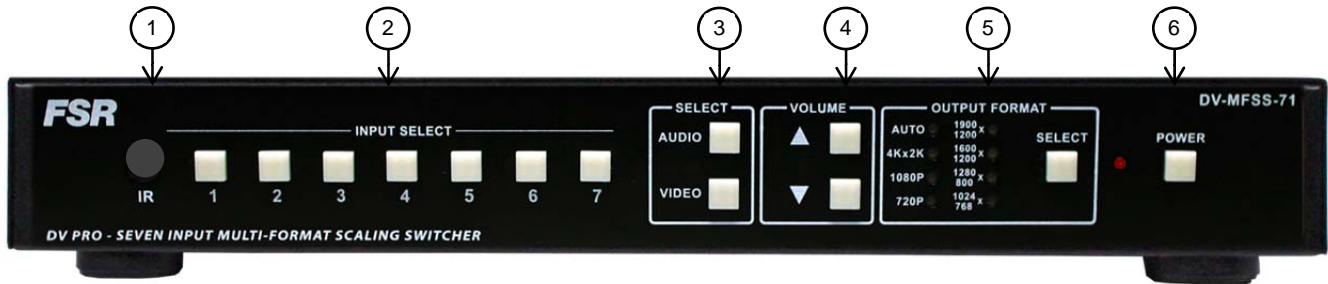

ID	Name
1	IR receiver
2	Input select*
3	Video and Audio select
4	Volume up and down
5	Output resolution
6	Power ON and OFF (Standby)

* The VGA auto adjust command can also be executed by pressing and holding the input 7 switch for 3 seconds. (See below)

VGA INPUT AUTO ADJUST BEHAVIOR:

The DV-MFSS-71 switcher will automatically adjust to new VGA sources when they are first connected. The process will take several seconds during which time the image will move around the screen until the optimal scaler settings are determined. Once a particular source is learned, the switcher will recognize it and readjustment will not be necessary. Up to 10 unique sources can be stored in the unit's memory, after which additional sources will result in one of the others being overwritten. If for any reason the image does not display correctly, the auto-adjust process can be triggered manually by pressing and holding the input 7 switch for 3 seconds.

REAR PANEL

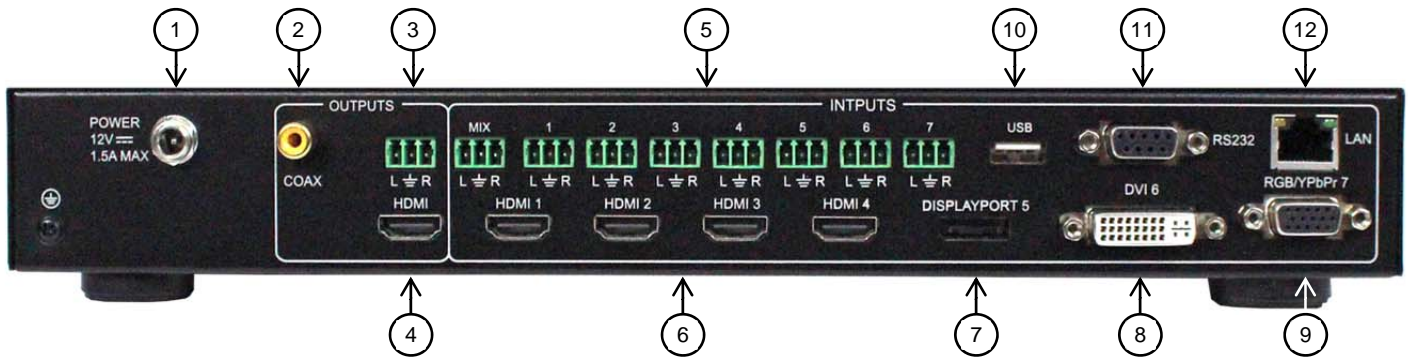

ID	Name
1	Power input
2	Digital audio output
3	Analog audio output
4	HDMI output
5	Analog audio inputs
6	HDMI inputs
7	DisplayPort input
8	DVI input
9	VGA (RGB/YPbPr) input
10	USB service port
11	RS-232
12	LAN

OPERATION



Power ON and OFF (Standby)

NOTE: To reset to factory default, press and hold Input Select 5 during the power up cycle until the front panel LEDs blink.



Output format



To select the video, press video and one of the inputs.



To select the audio, press audio and one of the inputs.





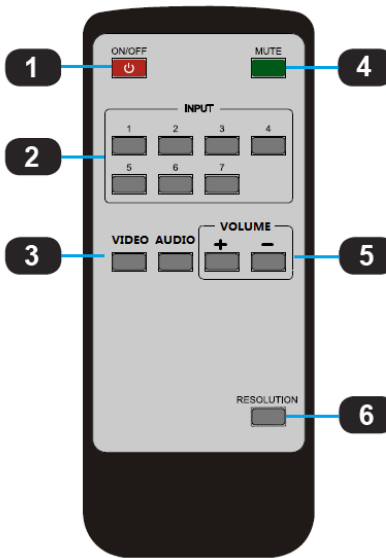

Volume up and down

IR REMOTE CONTROL

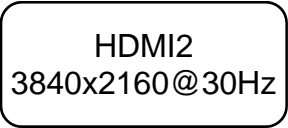
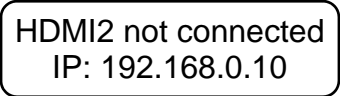

ID	Name
1	Power ON and OFF (Standby)
2	Input
3	Video and Audio select To select the video, press video and one of the inputs To select the audio, press audio and one of the inputs
5	Volume up and down
4	Mute and unmute
6	Output resolution Auto (Display's native resolution) → 4Kx2K 30Hz → 1920x1080 60Hz → 1280x720 60Hz → 1920x1200 60Hz → 1600x1200 60Hz → 1280x800 60Hz → 1024x768 60Hz

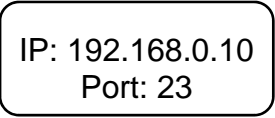
ON SCREEN DISPLAY (OSD)

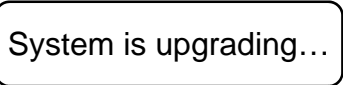
	Selected input and its input resolution
	Selected input state and DV-MFSS-71's IP address
	VGA auto adjust
	Volume
	DV-MFSS-71's IP address and port number
	Mute
	Unmute
	IMPORTANT: Do not power OFF or remove the USB drive during the firmware upgrade.

IP SETTINGS

There are two methods to obtain the IP address:

1. Obtain the IP address and port number via the information from the on-screen display (OSD).
2. Obtain the IP address and port number via the IP CONFIGURATION TOOL APPLICATION.

The following presents the two methods:

OSD

Obtain the IP address and port number via the information from the OSD:

When there is no signal, the following OSD in the window will be displayed:

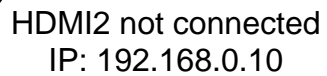

HDMI2 not connected
IP: 192.168.0.10

Or when an image is displayed, the IP information is displayed in the area above the middle of the window.

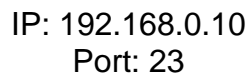

IP: 192.168.0.10
Port: 23

The IP address in this example, is 192.168.0.10 and the port number is 23.

IP CONFIGURATION TOOL APPLICATION

To obtain the IP address and port number via the IP CONFIGURATION TOOL APPLICATION:

Download the application "FSR_DV_71_74_Switcher.exe" file from the FSR Document Library at www.fsrinc.com.



NOTE: Make sure the PC and DV-MFSS-71 are on the same network.

Run the application on the PC to show the main screen:

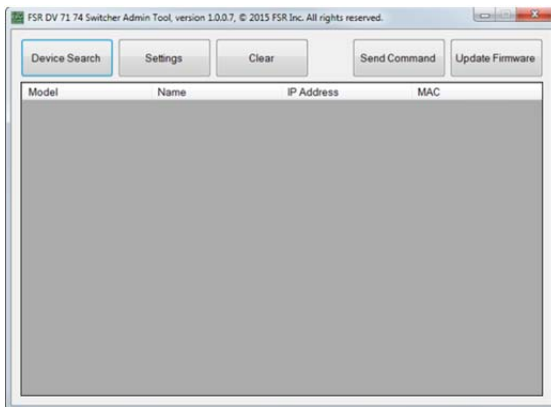

Click *Device Search*, the following device list is shown. Select the device, and click *Settings*

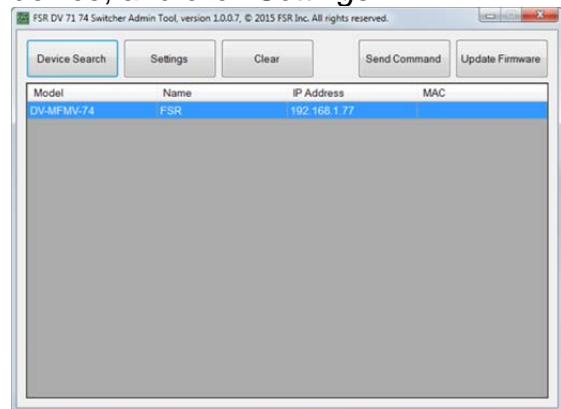

The screen defaults to the *Status* tab where the DV-MFSS-71's information is shown.

The DV-MFSS-71 settings can be returned to factory default by clicking *Factory Default*.

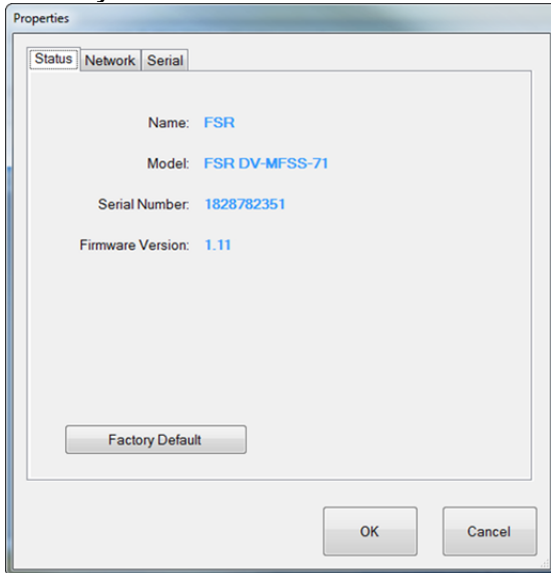

Click the *Network* tab to view the DV-MFSS-71's IP information. DHCP is enabled by default. The static IP address can be entered manually by disabling the DHCP via the pulldown menu.

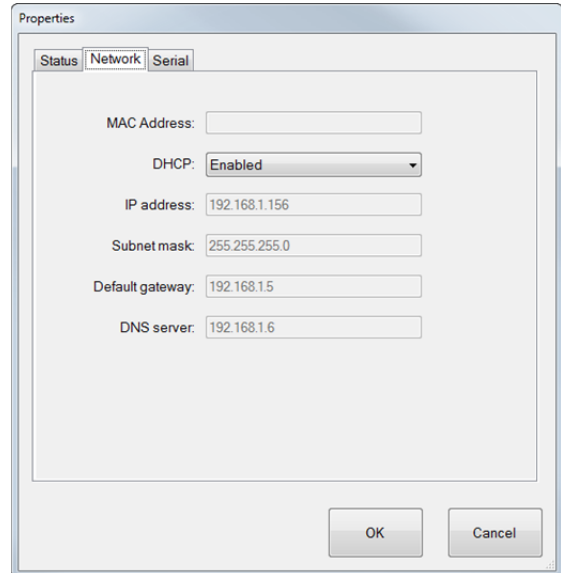

The *Serial* tab is an informational screen that will display the DV-MFSS-71 serial port settings. The settings are fixed at 9600, 8, 1, None and None.

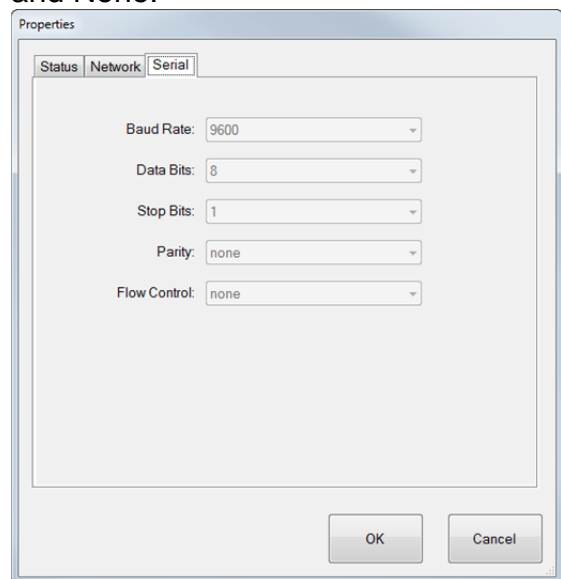

Single commands may be sent to change the display capabilities of the unit by clicking on **SEND COMMAND**.

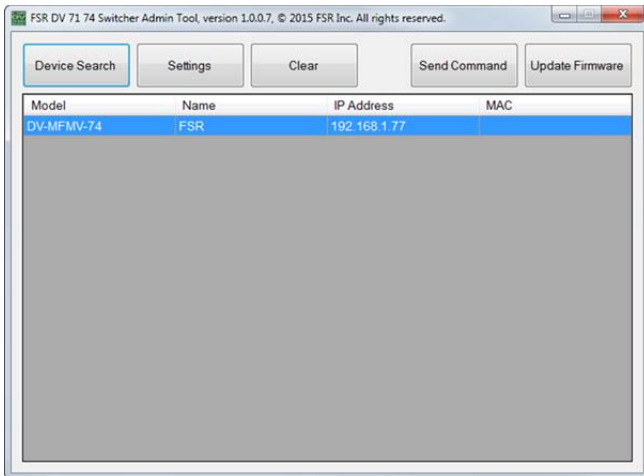

Select either *Ethernet* or *Serial* radio button

Select the appropriate COM port or Ethernet address.

Then either select a predefined command or enter a user defined command.

Click the **SEND** button to send the command:

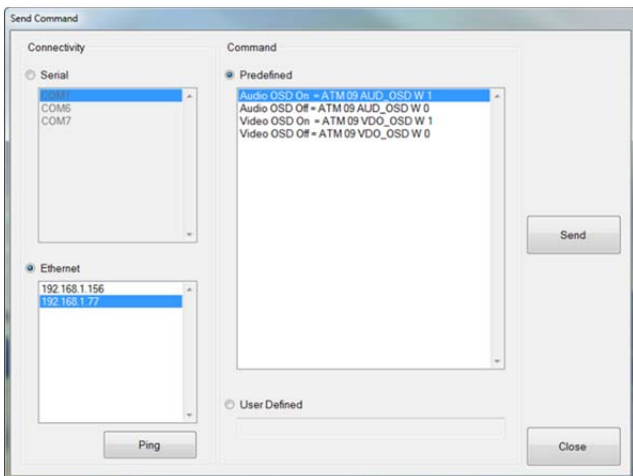

FIRMWARE UPDATE (EXTERNAL CONTROL BOARD)

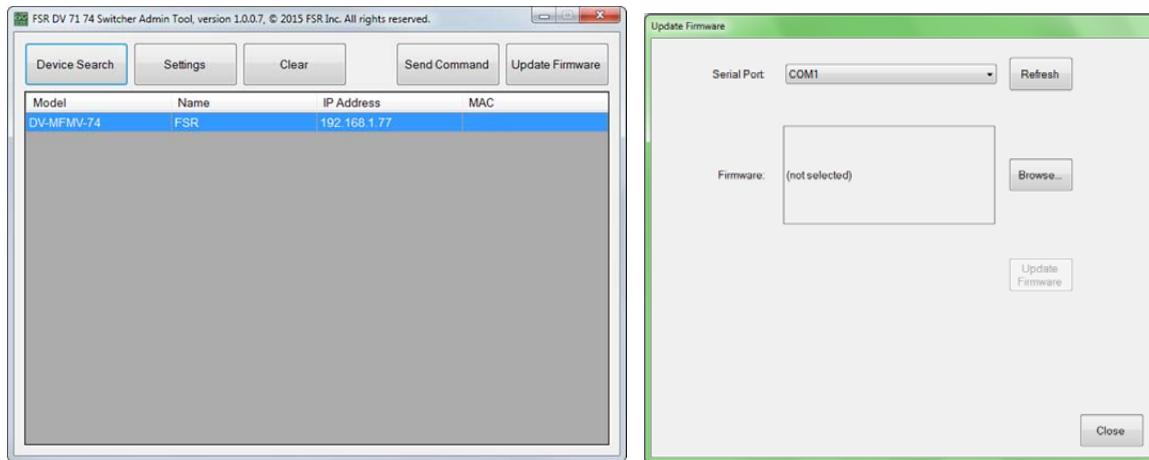

Download the update file from the FSR website doc library.

(Example: FSR_741_20xx_xxxx_xxx.frm)

1. Connect a Serial straight-through cable to the DV-MFSS-71's RS-232 port. If present, disconnect the Ethernet cable from the LAN port.
2. Turn on the DV-MFSS-71 and wait for it to finish booting up before proceeding to the next step.
3. Click on "Update Firmware".
4. Select a Serial port.
5. Browse for the location of the firmware file.
6. Click on "Update Firmware" and wait for its completion.
7. Power cycle the DV-MFSS-71 by disconnecting the power supply.

The current firmware version can be obtained from the "Status" tab.

IMPORTANT: Do not power OFF or remove the Serial cable during the firmware upgrade.

EMBEDDED WEB SERVER

The DV-MFSS-71 can be controlled via a Web browser, which contains General, Advanced and Network settings. For more information about how to obtain the IP address, see the section on “IP SETTINGS”.

For example, the obtained IP address is 192.168.0.115

Type 192.168.0.115 in the address bar of the web browser



The screenshot displays the web interface for the FSR DV-MFSS-71. At the top left is the FSR logo. The page title is "DV-MFSS-71 DV PRO - Seven Input Multi-Format Scaling Switcher". Below the title are three navigation tabs: "General", "Advanced", and "Network", with "General" selected. The "General" settings section includes:

- Video Input: 1 (dropdown) with a "Submit" button.
- Ratio: Normal (dropdown) with a "Submit" button.
- Audio Input: 1 (dropdown) and Audio Volume (0~10): 8 (input field) with a "Submit" button.
- Audio Input Config: 1 Auto (dropdown), 2 Auto (dropdown), 3 Auto (dropdown), 4 Auto (dropdown), 5 Auto (dropdown), 6 Auto (dropdown) with a "Submit" button.
- Output Timing: AUTO (dropdown) with a "Submit" button.

At the bottom of the page, contact information is provided: FSR Inc. 244 Bergen Boulevard, Woodland Park, NJ 07424 • Tel 973-785-4347 • Fax 973-785-4207 • E-Mail: sales@fsrinc.com. The copyright notice is ©2015 FSR Inc. All Rights Reserved.



General

Advanced

Network

Advanced

Power Switch Power Saving (0~60min)

Audio Mute Audio Delay (0~10)

Auto position Restore to default

Unit Firmware Version: FSR1.0.0.L_CL732

GUI Version: 1.11_CL624

FSR Inc. 244 Bergen Boulevard, Woodland Park, NJ 07424 • Tel 973-785-4347 • Fax 973-785-4207 • E-Mail: sales@fsrinc.com

©2015 FSR Inc. All Rights Reserved



General

Advanced

Network

Network Management

Network:

DHCP:

IP: 192.168.0.115 Mask: 255.255.255.0

Gate: 192.168.0.50 DNS: 192.168.0.6

Sockets:

Socket:

Port:

Others:

Network Settings Restore To Default:

FSR Inc. 244 Bergen Boulevard, Woodland Park, NJ 07424 • Tel 973-785-4347 • Fax 973-785-4207 • E-Mail: sales@fsrinc.com

©2015 FSR Inc. All Rights Reserved

CONTROL PORTS

To control the DV-MFSS-71 use the RS-232 or LAN port but not both at the same time.

RS-232 SETTINGS

RS-232 Settings	
Baud rate	9600
Data bits	8
Parity	None
Stop bits	1
Flow control	None

DTE	DB-9	DCE
Computer	Pin	DV-MFSS-71
Rx	2	Tx
Tx	3	Rx
Ground	5	Ground

NOTE: For serial control, use a straight-through cable.

ETHERNET SETTINGS

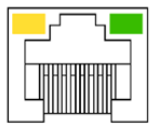
DHCP	ON (Default)
Telnet port	23 (Default)
Speed	10/100Mbps
	Yellow = Link Green = Speed/Activity at 100Mbps

RS-232 SERIAL AND ETHERNET CONTROL PROTOCOL

Settings	Command	Reply																								
Aspect ratio	ATM 0A WIN_RAT W 1 X	0A WIN_RAT W 1 X																								
Ex: Input set to 16:9	ATM 0A WIN_RAT W 1 3	0A WIN_RAT W 1 3																								
Window aspect ratio request	ATM 09 WIN_RAT R 1	09 WIN_RAT R X WIN_RAT 1 X																								
X = (1 = Normal, 2 = Full, 3 = 16:9 or 4 = 4:3)																										
Audio delay	ATM 09 AUD_DLY W X	09 AUD_DLY W X																								
Ex: Audio delay OFF	ATM 09 AUD_DLY W 0	09 AUD_DLY W 0																								
Audio delay request	ATM 08 AUD_DLY R	08 AUD_DLY R AUD_DLY X																								
Audio delay																										
<table border="1" style="width: 100%; border-collapse: collapse;"> <thead> <tr> <th style="width: 5%;"></th> <th style="width: 10%;">0</th> <th style="width: 10%;">1</th> <th style="width: 10%;">2</th> <th style="width: 10%;">3</th> <th style="width: 10%;">4</th> <th style="width: 10%;">5</th> <th style="width: 10%;">6</th> <th style="width: 10%;">7</th> <th style="width: 10%;">8</th> <th style="width: 10%;">9</th> <th style="width: 10%;">A</th> </tr> </thead> <tbody> <tr> <td style="text-align: center;">X</td> <td style="text-align: center;">OFF</td> <td style="text-align: center;">40ms</td> <td style="text-align: center;">80ms</td> <td style="text-align: center;">120ms</td> <td style="text-align: center;">160ms</td> <td style="text-align: center;">200ms</td> <td style="text-align: center;">240ms</td> <td style="text-align: center;">280ms</td> <td style="text-align: center;">320ms</td> <td style="text-align: center;">360ms</td> <td style="text-align: center;">400ms</td> </tr> </tbody> </table>				0	1	2	3	4	5	6	7	8	9	A	X	OFF	40ms	80ms	120ms	160ms	200ms	240ms	280ms	320ms	360ms	400ms
	0	1	2	3	4	5	6	7	8	9	A															
X	OFF	40ms	80ms	120ms	160ms	200ms	240ms	280ms	320ms	360ms	400ms															
Audio input configuration	ATM 0A AUD_MOD W X Y	0A AUD_MOD W X Y																								
Ex: Input 2 set to external	ATM 0A AUD_MOD W 2 1	0A AUD_MOD W 2 1																								
Audio input configuration request	ATM 09 AUD_MOD R X	09 AUD_MOD R X Port X Audio: Y																								
X = Input (1-4) Y = (0 = Auto or 1 = External) Auto: Analog or HDMI audio (priority) External: Only analog audio																										
Audio OSD	ATM 09 AUD_OSD W X	09 AUD_OSD W X																								
Ex. Audio OSD OFF	ATM 09 AUD_OSD W 0	09 AUD_OSD W 0																								
Audio OSD request	ATM 08 AUD_OSD R	08 AUD_OSD R AUD_OSD X																								
X = (0 = OFF and 1 = ON)																										
Audio select	ATM 09 ADO_IPT W X	09 ADO_IPT W X																								
Ex: Audio input 2	ATM 09 ADO_IPT W 2	09 ADO_IPT W 2																								
Audio input request	ATM 08 ADO_IPT R	08 ADO_IPT R ADO_IPT X																								
X = Input (1-7)																										
Copy display's EDID	ATM 09 EDI_CPY X Y	09 EDI_CPY X Y																								
Ex: Copy display's EDID to input 4	ATM 09 EDI_CPY 1 4	09 EDI_CPY 1 4																								

Settings	Command	Reply																
X = Output (1 = Main output or 2 = Second output if applicable)																		
Y = Input (1-7)																		
EDID presets	ATM 0B EDI_POR W X C Y	0B EDI_POR W X C Y																
Ex: Assign EDID preset 3 to input 1	ATM 0B EDI_POR W 1 C 3	0B EDI_POR W 1 C 3																
<p>X = input (1-7)</p> <p style="text-align: center;">EDID presets</p> <table border="1" style="margin-left: auto; margin-right: auto;"> <thead> <tr> <th></th> <th>1</th> <th>2</th> <th>3</th> </tr> </thead> <tbody> <tr> <td>Y</td> <td>4Kx2K 30Hz 7.1Ch</td> <td>4Kx2K 30Hz 2Ch</td> <td>1920x1080 60Hz 7.1Ch</td> </tr> <tr> <td></td> <th>4</th> <th>5</th> <th>6</th> </tr> <tr> <td></td> <td>1920x1080 60Hz 2Ch</td> <td>1920x1080 60Hz (VGA)</td> <td>4Kx2K 60Hz (DisplayPort)</td> </tr> </tbody> </table>				1	2	3	Y	4Kx2K 30Hz 7.1Ch	4Kx2K 30Hz 2Ch	1920x1080 60Hz 7.1Ch		4	5	6		1920x1080 60Hz 2Ch	1920x1080 60Hz (VGA)	4Kx2K 60Hz (DisplayPort)
	1	2	3															
Y	4Kx2K 30Hz 7.1Ch	4Kx2K 30Hz 2Ch	1920x1080 60Hz 7.1Ch															
	4	5	6															
	1920x1080 60Hz 2Ch	1920x1080 60Hz (VGA)	4Kx2K 60Hz (DisplayPort)															

Settings	Command	Reply
Firmware version request	ATM 08 CSW_VER W	08 CSW_VER W X
Ex: X = FSR1.0.0.L Data:2015.07.15		
HDCP input	ATM 09 IPT_DCP W X	09 IPT_DCP W X
Ex: HDCP input ON	ATM 09 IPT_DCP W 1	09 IPT_DCP W 1
X = (0 = OFF and 1 = ON)		
HDCP output	ATM 0A HDO_HDP W X Y	0A HDO_HDP W X Y
Ex: HDMI 1 HDCP output ON	ATM 0A HDO_HDP W 1 0	0A HDO_HDP W 1 0
HDCP output request	ATM 08 HDO_HDP R	08 HDO_HDP R HDMI_1_HDCP: Z HDMI_2_HDCP: Z
<p>X = Output (1 = Main output or 2 = Second output if applicable)</p> <p>Y = (0 = ON or F = OFF)</p> <p>Z = ON or OFF</p> <p>HDMI_1_HDCP = Main output</p> <p>HDMI_2_HDCP = Second output if applicable</p>		
HDMI output audio mute	ATM 09 AUD_OPT W X	09 AUD_OPT W X
Ex: HDMI audio output mute ON	ATM 09 AUD_OPT W 1	09 AUD_OPT W 1
HDMI output audio mute request	ATM 08 AUD_OPT R	08 AUD_OPT R AUD_OPT X

Settings	Command	Reply																					
X = (0 = Mute OFF or 1 = Mute ON)																							
Master audio mute	ATM 09 AUD_MUT W X	09 AUD_MUT W X																					
Ex: Master audio mute OFF	ATM 09 AUD_MUT W 0	09 AUD_MUT W 0																					
Master audio mute request	ATM 08 AUD_MUT R	08 AUD_MUT R AUD_MUT X																					
X = (0 = Mute OFF or 1 = Mute ON)																							
Output timing	ATM 09 OPT_TIM W X	09 OPT_TIM W X																					
Ex: 1920x1080 60Hz	ATM 09 OPT_TIM W 3	09 OPT_TIM W 3																					
Output timing request	ATM 08 OPT_TIM R	08 OPT_TIM R OPT_TIM X																					
Output timing																							
<table border="1" style="width: 100%; border-collapse: collapse;"> <thead> <tr> <th style="width: 25%;"></th> <th style="width: 25%; text-align: center;">1</th> <th style="width: 25%; text-align: center;">2</th> <th style="width: 25%; text-align: center;">3</th> <th style="width: 25%; text-align: center;">4</th> </tr> </thead> <tbody> <tr> <td style="text-align: center;">X</td> <td>Auto (Display's native resolution)</td> <td>4Kx2K 30Hz</td> <td>1920x1080 60Hz</td> <td>1280x720 60Hz</td> </tr> <tr> <td></td> <th style="text-align: center;">5</th> <th style="text-align: center;">6</th> <th style="text-align: center;">7</th> <th style="text-align: center;">8</th> </tr> <tr> <td></td> <td>1920x1200 60Hz</td> <td>1600x1200 60Hz</td> <td>1280x800 60Hz</td> <td>1024x768 60Hz</td> </tr> </tbody> </table>					1	2	3	4	X	Auto (Display's native resolution)	4Kx2K 30Hz	1920x1080 60Hz	1280x720 60Hz		5	6	7	8		1920x1200 60Hz	1600x1200 60Hz	1280x800 60Hz	1024x768 60Hz
	1	2	3	4																			
X	Auto (Display's native resolution)	4Kx2K 30Hz	1920x1080 60Hz	1280x720 60Hz																			
	5	6	7	8																			
	1920x1200 60Hz	1600x1200 60Hz	1280x800 60Hz	1024x768 60Hz																			
Power	ATM 09 POW_CRL W X	09 POW_CRL W X																					
Ex: power ON	ATM 09 POW_CRL W 1	09 POW_CRL W 1																					
Power state request	ATM 08 POW_CRL R	08 POW_CRL R POW_CRL X																					
X = (0 = OFF (Standby) or 1 = ON)																							
<ul style="list-style-type: none"> • The Power ON command is the only command honored if the scaler switcher is OFF (Standby). • The entire Power ON command via Ethernet must be contained within a single TCP/IP packet. 																							

Settings	Command	Reply
Power save	ATM 0A POW_SAV W XX	0A POW_SAV W XX
Ex: Power save set to 30 minutes	ATM 0A POW_SAV W 1E	0A POW_SAV W 1E
Power save request	ATM 08 POW_SAV R	08 POW_SAV R POW_SAV R XX
XX = (00 – 3C), 00 = OFF and 3C = 60 minutes		
<ul style="list-style-type: none"> • Convert the decimal value to Hex and use the result as ASCII characters. Ex. 30 minutes = 1E (ASCII) • The scaler switcher will turn OFF (Standby) at the specified time if there is no video present on the selected input and it will turn ON automatically if there is video present on the selected input. 		
Restore to factory default	ATM 08 RST_SET W	08 RST_SET W

Settings	Command	Reply
Factory default		
Aspect ratio	Audio delay	Audio input configuration
Normal	OFF	Auto
Audio OSD	Audio selected	DHCP
ON	1	ON
HDCP input	HDCP output	HDMI audio mute
ON	ON	OFF
Input EDID	Master audio mute	Output timing
HDMI 1-4: 4Kx2K 30Hz 7.1Ch DisplayPort 5: 4Kx2K 60Hz DVI 6: 4Kx2K 30Hz VGA 7: 1920x1080 60Hz	OFF	Auto (Display's native resolution)
Power save	Video OSD	Video selected
OFF	ON	Input 1
Volume		
8		

Settings	Command	Reply
VGA auto adjust* * The VGA auto adjust command can also be executed by pressing and holding the input 7 switch for 3 seconds.	ATM 08 VGA_AUT W	08 VGA_AUT W
Video OSD	ATM 09 VDO_OSD W X	09 VDO_OSD W X
Ex: Video OSD ON	ATM 09 VDO_OSD W 1	09 VDO_OSD W 1
Video OSD request	ATM 08 VDO_OSD R	08 VDO_OSD R VDO_OSD X
X = (0 = OFF and 1 = ON)		
Video select	ATM 0A VDO_IPT W 1 X	0A VDO_IPT W 1 X
Ex: Input 4	ATM 0A VDO_IPT W 1 4	0A VDO_IPT W 1 4
Video select request	ATM 09 VDO_IPT R 1	09 VDO_IPT R 1 VDO_IPT 1 X
X = Input (1-7)		
Volume	ATM 09 VOL_CRL W X	09 VOL_CRL W X
Ex: Volume set to 5	ATM 09 VOL_CRL W 5	09 VOL_CRL W 5
Ex: Volume Up	ATM 09 VOL_CRL W +	09 VOL_CRL W +
Volume request	ATM 08 VOL_CRL R	08 VOL_CRL R VOL_CRL Y
X = (0-A, + = Up or - = Down), 10 = A Y = (0-A), 10 = A Volume control for HDMI and analog audio out.		

FIRMWARE UPDATE (AUDIO AND VIDEO BOARD)

Download the MERGE.BIN file from the FSR website doc library

The DV-MFSS-71 can be updated through a USB drive as follows.

1. Copy the MERGE.BIN update file to the root directory of a blank USB drive.
2. Connect the USB drive to the USB service port on the rear of the DV-MFSS-71. If present, disconnect the Serial and Ethernet cable from its respective port.
3. Connect the HDMI output of the DV-MFSS-71 to a display.
4. Turn on the DV-MFSS-71 and wait for it to finish booting up before proceeding to the next step.
5. Press and hold Input Select 1 until, "System upgrading..." appears on the display. During this process the button indicators will blink at a steady rate.
6. The DV-MFSS-71 will reboot automatically after loading the firmware.
7. Power cycle the DV-MFSW-71 by disconnecting the power supply.

The firmware version can be obtained using the "firmware version request" command.

IMPORTANT: Do not power OFF or remove the USB drive during the firmware upgrade.

SPECIFICATIONS

Supported Formats	
Input	HDMI video up to 3840x2160 30Hz and audio up to 7.1Ch DisplayPort up to 3840x2160 60Hz DVI up to 3840x2160 30Hz VGA (RGB/YPbPr) up to 1920x1200 60Hz
Output	HDMI video up to 3840x2160 30Hz and audio up to 7.1Ch Stereo analog audio Coax audio up to 7.1Ch
Connectors	
Input	4 HDMI Type A 19-pin, female 1 DisplayPort (Full Size) 20-pin, female 1 DVI, female 1 VGA HD-15 15-pin, female 7 Program audio inputs via captive screw terminals 1 Mix audio input via captive screw terminals
Output	1 HDMI Type A 19-pin, female 1 Stereo via captive screw terminals 1 Coax
RS-232	1 DB-9, female
LAN	1 RJ-45
USB	1 Type A 4-pin, female
Power consumption	12VDC, 1.5A Max
Physical	
Dimensions (W x H x D)	12.8" x 1.71" x 7.09" (326mm x 43.5mm x 181mm)
Unit Weight	6lbs (3.3kg)

