



User Manual

HD-HWP-TX

100m HDBaseT HDMI Extender Wallplate



244 Bergen Boulevard, Woodland Park, NJ 07424 • Tel 973-785-4347 • FAX 973-785-3318 • Web: www.fsrinc.com

Important Safety Instructions

Contents are subject to change without notice

Warnings

To reduce the risk of fire, electric shock or product damage:



1. Do not expose this device to rain, moisture, dripping or splashing and that no objects filled with liquids, such as vases, shall be placed on the unit.



6. Clean this device only with dry cloth.



2. Do not install or place this unit in a bookcase, built-in cabinet or in another confined space. Ensure the unit is well ventilated.



7. Unplug this device during lightning storms or when unused for long periods of time.



3. To prevent risk of electric shock or fire hazard due to overheating, do not obstruct the unit's ventilation openings with newspapers, tablecloths, curtains, and similar items.

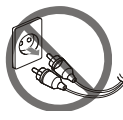

8. Protect cables and cords from being walked on or pinched particularly at plugs.



4. Do not install near any heat sources such as radiators, heat registers, stoves, or other device (including amplifiers) that produce heat.



9. Only use attachments/accessories specified by FSR.



5. Do not place sources of open flames, such as lighted candles, on the unit.



10. Refer all servicing to qualified service personnel.

Table of Contents

Overview	4
Features	4
Cable Distances & Resolutions:	5
Typical Application	6
HD-HWP-TX Dimensions	7
HD-HWP-Tx Front Panel	8
HD-HWP-Tx Rear Panel	9
Hardware Installation	10
IR and RS-232 Operation	11
IR Control	11
RS-232 Control	13
Specifications	14
Limited Warranty	16

OVERVIEW

The HD-HWP-TX transmitter is a true HDBaseT 5-Play device that transmits HD Video (4K UHD), Audio, Bi-directional control (IR & RS-232), Ethernet, and Power via 1 CAT-6A shielded cable up to 100 Meters.

The HD-HWP-TX works with any of FSR's 100 Meter HDBaseT Receivers and can be powered by any 100m Receiver or powered locally

The unit fits in a standard 2-gang box.



FEATURES

- Supports 4K UHD / 2160p (3840 x 2160 or 4096 x 2160p @ 24Hz / 25Hz / 30Hz / 50 Hz / 60 Hz) (4:2:0 8-bit)
- Supports an HDMI input
- HDBaseT 1.0 compliance
- HDMI 1.4 with 4K compliance
- HDCP 2.2 pass-through
- Bi-directional PoE (HD-HWP-TX only)
- Bi-directional IR
- IR, Ethernet and RS232 control over HDBaseT
- Space saving design

CABLE DISTANCES & RESOLUTIONS:

CAT-5e / CAT-6:

100 Meters: 1080p @60 Hz (36 bpp)

70 Meters: 1080p @60 Hz (48 bpp) or 3D and 4K UHD / 2160p (3840 x 2160 or 4096 x 2160p @ 24Hz / 25Hz / 30Hz / 50 Hz / 60 Hz) (4:2:0 8-bit)

CAT-6a / CAT-7:

100 Meters: 1080p @60 Hz (48 bpp) or 3D and 4K UHD / 2160p (3840 x 2160 or 4096 x 2160p @ 24Hz / 25Hz / 30Hz / 50 Hz / 60 Hz) (4:2:0 8-bit)

NOTE:

The actual signal transmission distance can vary and depends on signal resolution, cable quality, graphics card, and display used in the system.

TYPICAL APPLICATION

HD-HWP-Tx shown

Transmitter

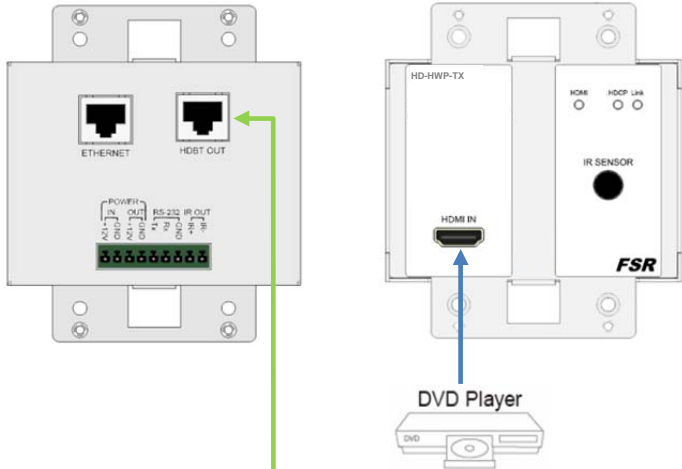

Any FSR HDBaseT Receiver

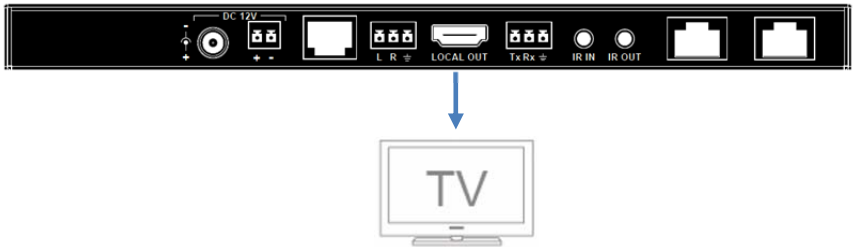

NOTE: Only one power supply is needed to power the Transmitter and Receiver set from any of the FSR's 100m HDBaseT receivers. The HD-HWP-Tx transmitter can be powered locally but it cannot send power to the receiver. Transmitters do not include a Power Supply. An FSR 17762 Power Supply is included with any of the FSR HDBaseT Receivers. FSR 17762 Power Supplies can also be ordered separately.

HD-HWP-TX DIMENSIONS

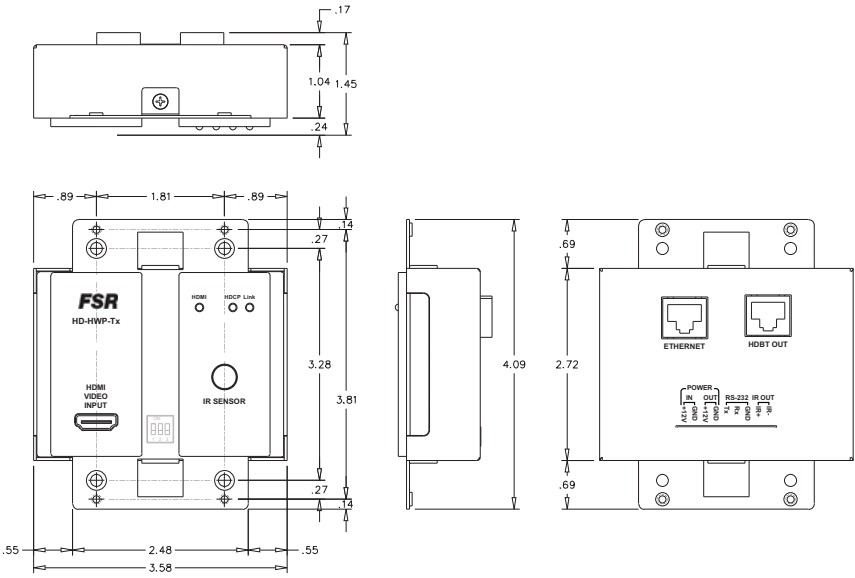

HD-HWP-TX FRONT PANEL

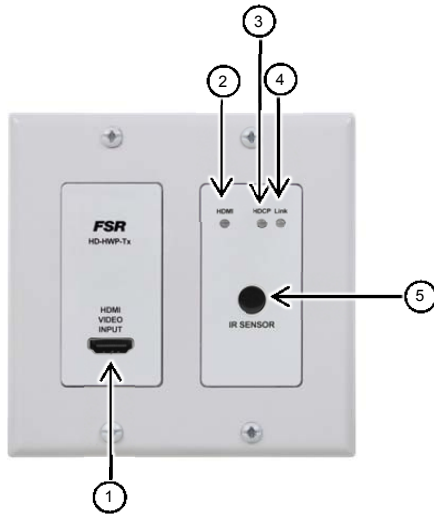

ID	Name	Description
1	HDMI VIDEO INPUT	HDMI input connection from source
2	HDMI LED	Indicates an active HDMI input
3	HDCP LED	On: HDCP video is being transmitted. Off / Intermittent: No HDCP video is being transmitted
4	Link LED	ON: Receiver and Transmitter are linked to each other OFF / Intermittent: Fault in unit(s) or cabling.
5	IR SENSOR	Infrared Sensor window for remote control

HD-HWP-TX REAR PANEL

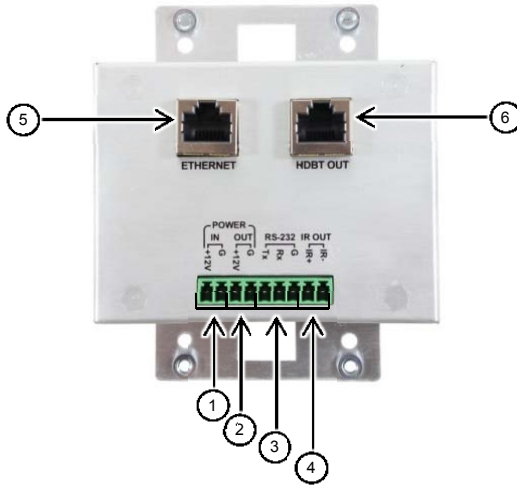

ID	Name	Description
1	POWER IN	12V 2A DC power supply input (power supply sold separately. (See note under "Typical Application")
2	POWER OUT	12VDC 250mA max
3	RS-232	Serial port
4	IR OUT	Connects to IR transmitter
5	ETHERNET	Connects to an Ethernet device
6	HDBT OUT	Connects to HDBT IN port of receiver

HARDWARE INSTALLATION

Warnings

- Before the installation, disconnect the power supply from all the devices.
- Do not connect or disconnect cables from the Transmitter and Receiver while they are powered ON. To connect or disconnect cables from the units, power them OFF first.
- For best resolution and ESD performance, a shielded CAT6A in a TIA / EIA 568B wiring configuration is recommended. Please use care when installing, connecting and disconnecting cables.

1. Connect the source to the **HDMI IN** on the Transmitter.
2. Connect the IR emitter to the **IR OUT** and the IR Receiver to the **IR IN** on both the Transmitter and Receiver.
3. Connect a Display to the **HDMI OUT** on the Receiver.
4. Connect the **HDBT OUT** on the Transmitter to the **HDBT IN** on the Receiver via a shielded CAT5e / CAT6 / CAT6A / CAT7 cable. (CAT6A shielded cable is recommended for best performance.)
5. Connect the power supply.

IR AND RS-232 OPERATION

IR Control

The IR pass-through feature on the Transmitter and Receiver allows you to control the Source from the Display's location or vice versa.

Scenario 1

The TV can be controlled from the Transmitter's location with the TV remote. The IR receiver is connected to the IR IN on the Transmitter and the IR emitter is connected to the IR OUT on the Receiver.

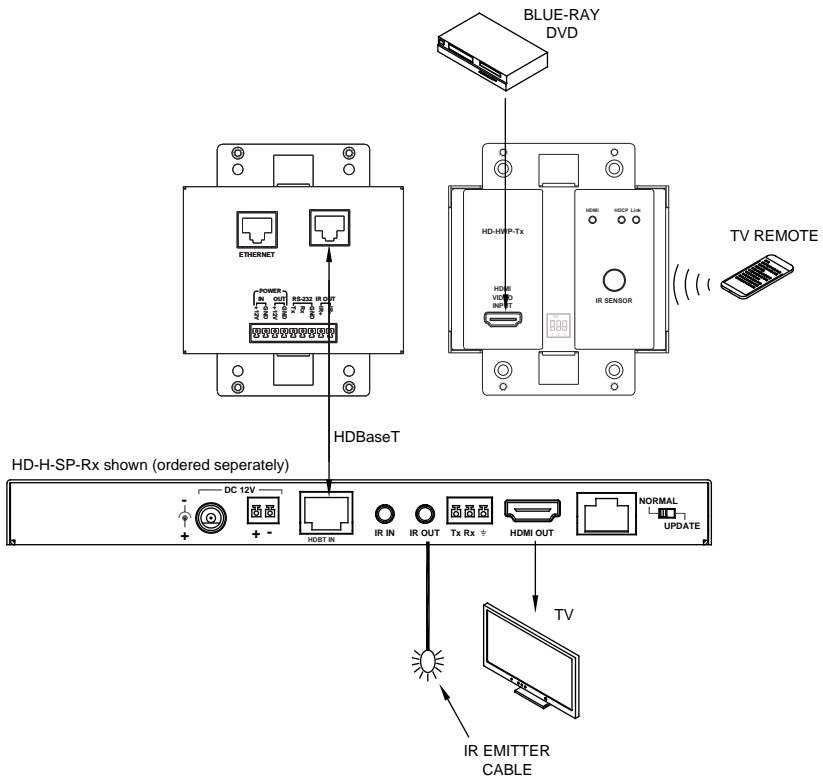

Scenario 2

The DVD Player can be controlled from the Receiver's location with the DVD Player Remote. The IR emitter is connected to the IR OUT on the Transmitter and the IR receiver is connected to the IR IN on the Receiver.

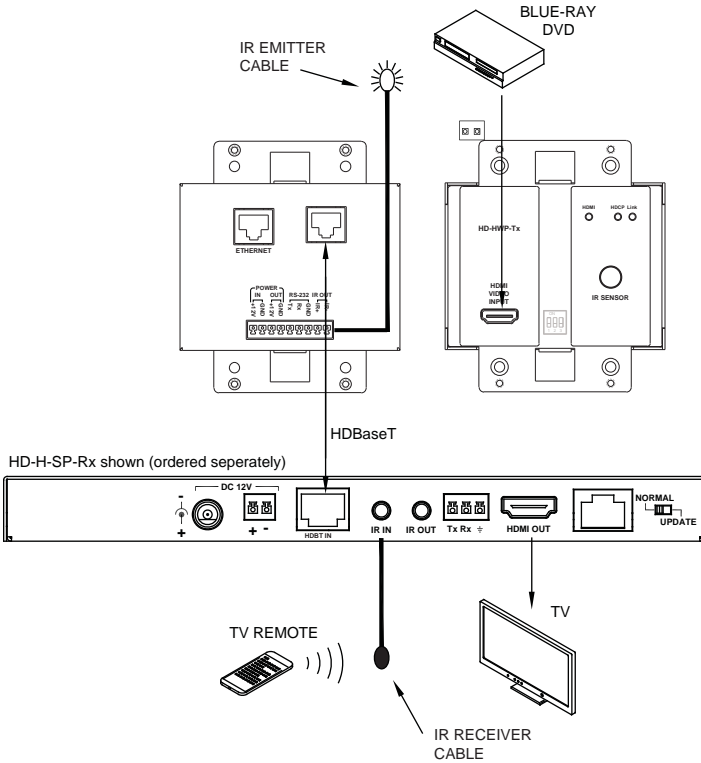

RS-232 Control

The RS-232 port can be used as a pass-through to control a device connected to the Transmitter from the Receiver or vice versa.

RS-232 Control

Maximum baud rate is 115.2 Kbps.

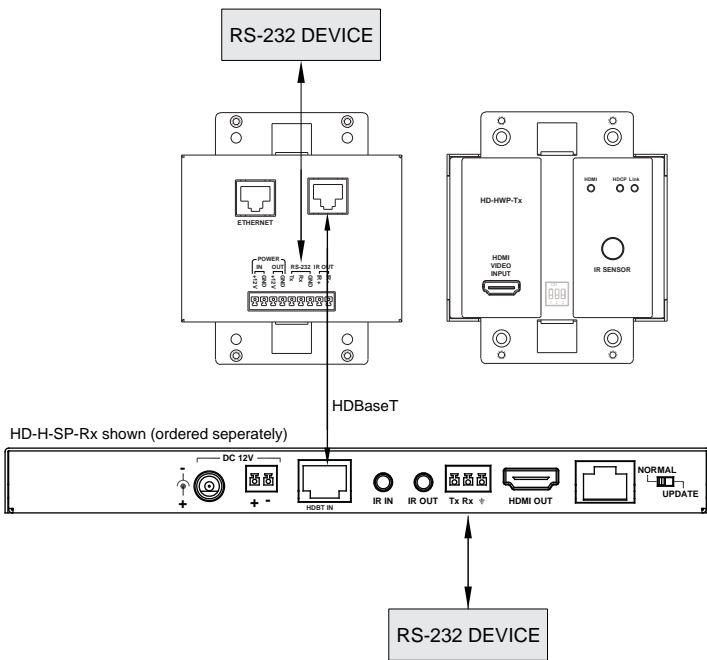

SPECIFICATIONS

Technical	
Video input Connector	1 HDMI
Input Signal Types	4K UHD / 2160p (3840 x 2160 or 4096 x 2160p @ 24Hz / 25Hz / 30Hz / 50 Hz / 60 Hz (4:2:0 8-bit) 7.1ch audio HDMI 1.4 and HDCP compliant
Output	1 HDBT
Output Signal Type	HDBT
Video Impedance	100Ω
Control	
Control input	RS-232 via 3.81mm 3 Pin pluggable screw terminal Connector IR input via sensor on front panel IR output via 3.81mm pluggable screw terminal
Maximum Pixel Clock	297MHz
Operating Temperature	32°F to 95°F (0°C to 35°C) 10% to 90%, non-condensing
Storage Temperature	-4°F to 140°F (-20°C to 70°C) 10% to 90%, non-condensing
Power Supply	DC 12V 2A (power supply sold separately)
ESD Protection	Human-body Model: ±8kV (Air-gap discharge) ±4kV (Contact discharge)
Surge Protection	IEC 61000-4-4 (EFT) 40A (5/50ns); IEC 61000-4-5 (Lightning) 25A (8/20μs)

Cable Specifications

For best resolution and ESD performance, Shielded CAT6A in a TIA / EIA 568B wiring configuration is recommended.

CAT-5e / CAT-6:

100 Meters: 1080p @60 Hz (36 bpp)

70 Meters: 1080p @60 Hz (48 bpp) or 3D and 4K UHD / 2160p (3840 x 2160 or 4096 x 2160p @ 24Hz / 25Hz / 30Hz / 50 Hz / 60 Hz) (4:2:0 8-bit)

CAT-6a / CAT-7:

100 Meters: 1080p @60 Hz (48 bpp) or 3D and 4K UHD / 2160p (3840 x 2160 or 4096 x 2160p @ 24Hz / 25Hz / 30Hz / 50 Hz / 60 Hz) (4:2:0 8-bit)

NOTE:

The actual signal transmission distance can vary and depends on signal resolution, cable quality, graphics card, and display used in the system.

General

Shipping Weight	1.45 lbs. (0.66 kg)
Dimension (W x H x D)	3.58"W (90.9 mm) x 4.09"H (103.9 mm) x 1.45"D (37.8 mm)

LIMITED WARRANTY

The HD-HWP-TX Extenders are warranted against failures due to defective parts or faulty workmanship for a period of three years after delivery to the original owner. During this period, FSR will make any necessary repairs or replace the unit without charge for parts or labor. Shipping charges to the factory or repair station must be prepaid by the owner, return-shipping charges (via UPS Ground) will be paid by FSR.

This warranty applies only to the original owner and is not transferable. In addition, it does not apply to repairs done by other than the FSR factory or Authorized Repair Stations.

This warranty shall be cancelable by FSR at its sole discretion if the unit has been subjected to physical abuse or has been modified in any way without written authorization from FSR. FSR's liability under this warranty is limited to repair or replacement of the defective unit.

FSR will not be responsible for incidental or consequential damages resulting from the use or misuse of its products. Some states do not allow the exclusion of incidental or consequential damages, so the above limitations may not apply to you. This warranty gives you specific legal rights, and you may also have other rights which vary from state to state.

Warranty claims should be accompanied by a copy of the original purchase invoice showing the purchase date (if a Warranty Registration Card was mailed in at the time of purchase, this is not necessary). Before returning any equipment for repair, please read the important information on service below.

SERVICE

Before returning any equipment for repair, please be sure that it is adequately packed and cushioned against damage in shipment, and that it is insured. We suggest that you save the original packaging and use it to ship the product for servicing. Also, please enclose a note giving your name, address, phone number and a description of the problem.

NOTE: all equipment being returned for repair must have a Return authorization (RMA) Number. To get a RMA Number, please call the FSR Service Department (1-800-332-FSR1).

Please display your RMA Number prominently on the front of all packages.

CONTACT INFORMATION:

FSR INC.

244 Bergen Blvd.

Woodland Park, NJ 07424

Phone: (973) 785-4347

Order Desk Fax: (973) 785-4207

Web Site: <http://www.fsrinc.com>