

T3U Rim Series Table Top Tilt Up Boxes

FSR

Metal Products Group

T3U RIM Series



The T3U RIM Series (Table Top Tilt Up) table boxes are designed expressly for applications requiring multiple access boxes within the same table, the FSR T3U RIM Series handles data, power, and AV connections in a low profile box.



You can match almost any decor with the T3U RIM Series cover finish selection. The T3U RIM Series easily installs in any table surface with thickness ranging from a minimum .75" to a maximum of 2.75". In the open position, the T3U RIM Series cover protrudes a mere 1.19" from the table top. Under the table, the T3U RIM Series extends only 4.25" from the table top surface.

T3U-3R-BLK

(Shown with accessory plates and connectors.)

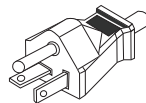

NEMA
5-20 Plug

The FSR T3U RIM Series offer a variety of connection schemes through the use of interchangeable snap in connectors and mounting plates. This allows the plates to be populated by the installer and can be changed as the need arises. FSR offers a complete line of connectors and plates to satisfy most installation requirements. (See options on the following pages).

NOTE: The T3U-3 model has a 9' NEMA 5-20 SJ cordset.

FSR Inc.

244 Bergen Boulevard, Woodland Park, NJ 07424
Phone: 973.998.2300 · Fax: 973.785.420
Web: www.fsrinc.com · E-mail: sales@fsrinc.com

LIT 1134H

T3U-3 DRAWING

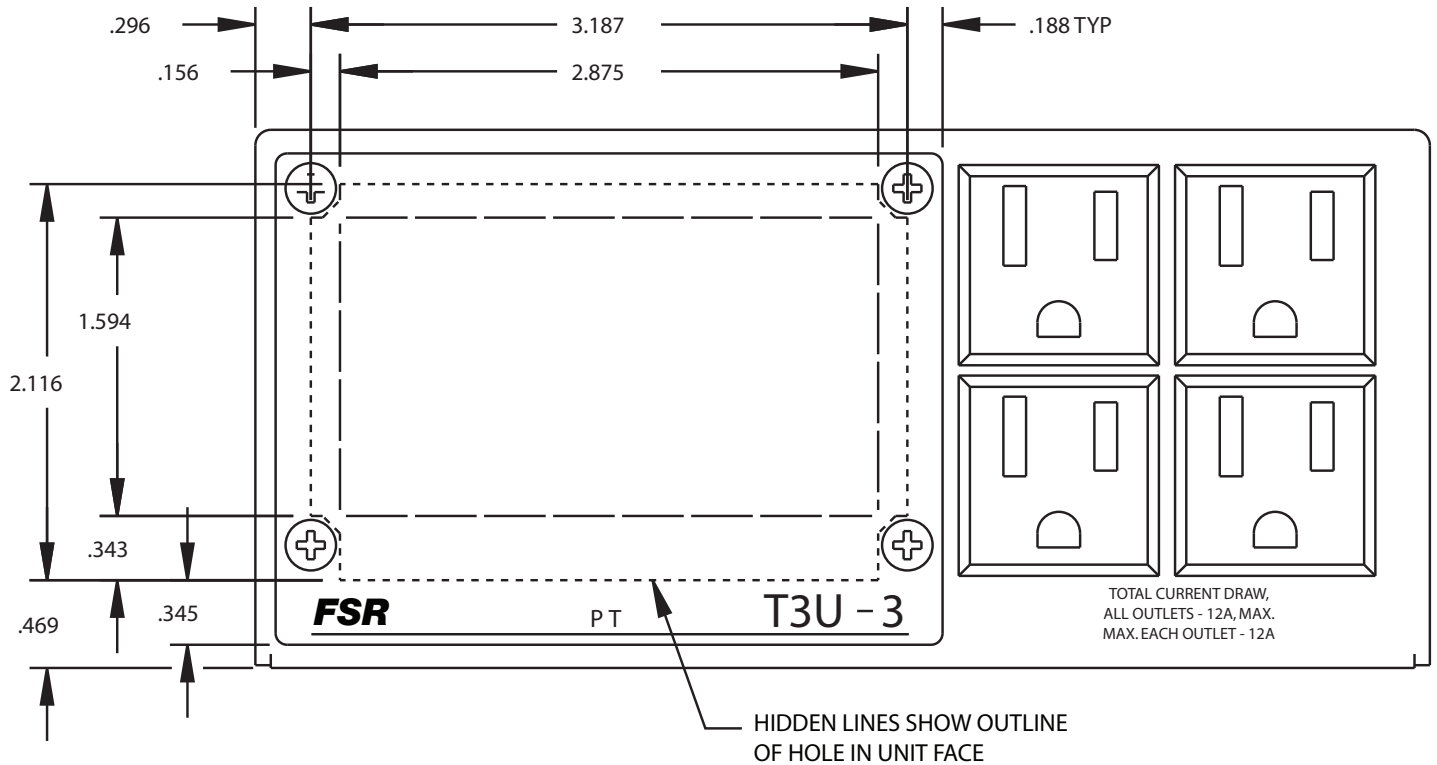

T3U-3
Connector Plate View

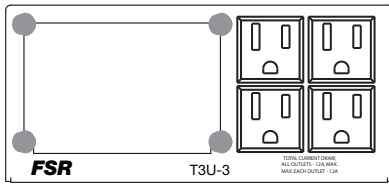

ORDERING INFORMATION

MODEL	FINISH	ACCEPTS
T3U-3R-BLK	BLACK	(see connector plate view) ONE T3U-3 CONNECTOR PLATE

SNAP IN CONNECTOR ORDERING DETAILS

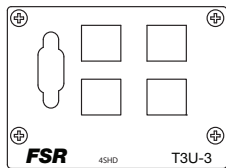

T3U-3-4SHD

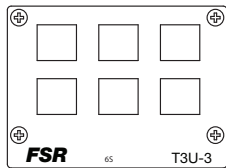







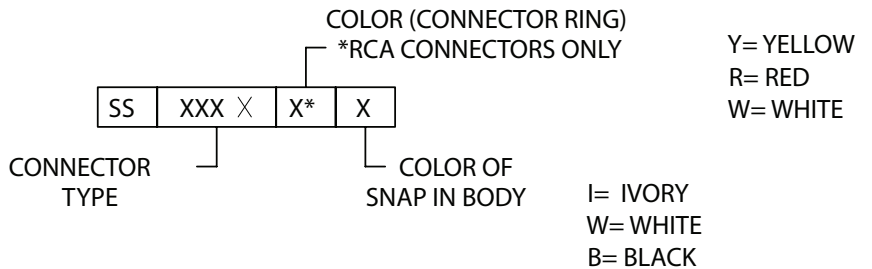













T3U-3-6S



T3U-3-PT



SNAP-IN CONNECTORS AVAILABLE FOR T3U-3

						
SS-RJ45* *SS-RJ45-WHT Punch Down SS-RJ45-BLK = Pass Thru	SS-RJCAT6 CAT 6 to Punch Down (Black Only)	SS-RJ11* *SS-RJ11-WHT Punch Down SS-RJ11-BLK = Pass Thru	SS-LC Fiber LC Pass Thru (Black Only)	SS-HDMI HDMI Pass Thru (White and Black Only)	SS-BNC BNC Pass Thru	SS-SCON S-Video Connector Pass Thru
						
SS-FCON F Connector Pass Thru	SS-RCA-R Red RCA Pass Thru	SS-RCA-B Black RCA Pass Thru	SS-RCA-Y Yellow RCA Pass Thru	SS-MINI 3.5mm Stereo to Solder	SS-SWMOM Momentary Switch	SS-SWMAIN Maintained Switch
						
SS-CBLNK Blank Insert	SS-USBA USB A Pass Thru (Black Only)	SS-USBAHW USB A to Punch Down (Black Only)	SS-USBB USB B Pass Thru (Black Only)	SS-USBBHW USB B to Punch Down (Black Only)	SS-USB-CHRG USB Universal 10W Charging Port (black only) with Power Supply	

TYPICAL INSTALLATION FOR ALL T3U TABLE BOXES

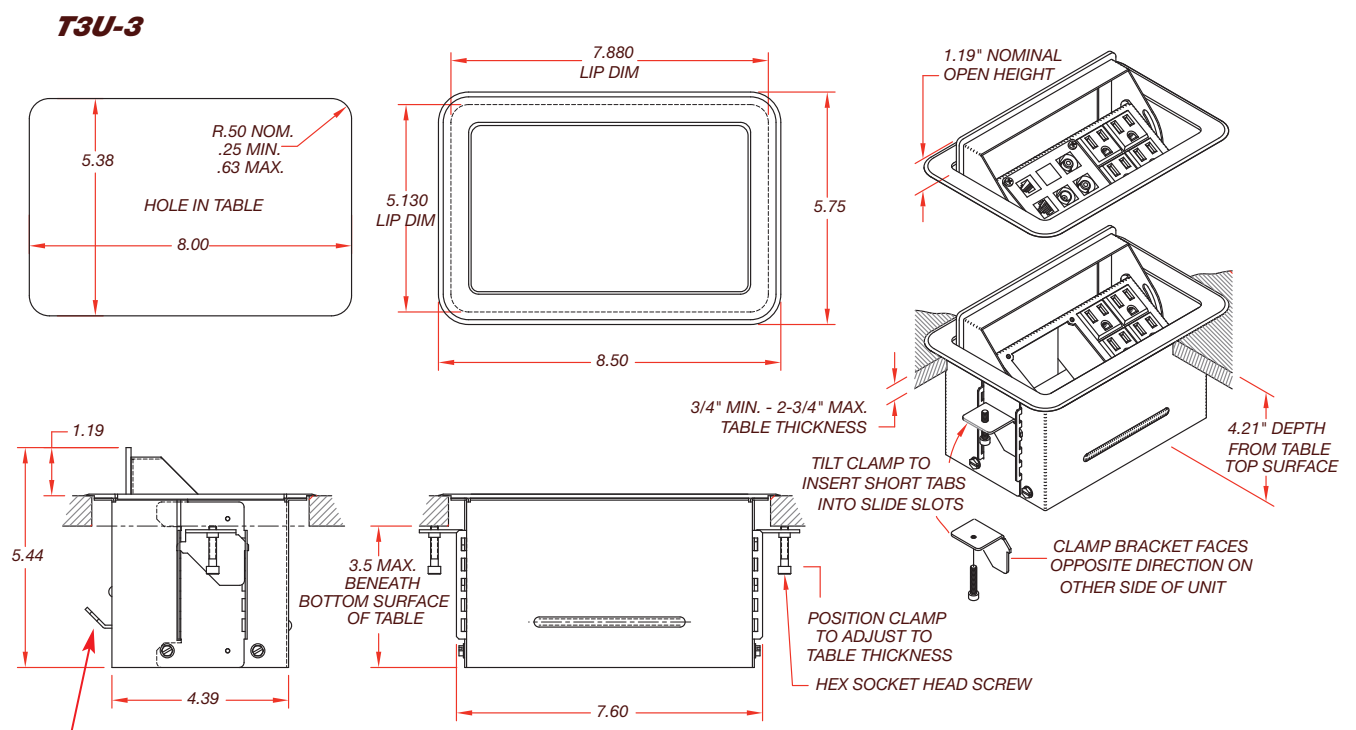

Tie wrap bracket(s) can be removed to provide additional connector clearance.

NOTE: The T3U-3 model has a 9' NEMA 5-20 SJ cordset.

SIMILAR FSR PRODUCT OFFERINGS

The T3-AC2 and T3-PC1D are perfect table boxes for single users, where convenient access to network drops, ac power sources and video/audio displays are required. The small footprint provides an unobtrusive complement to any decor.



T3-AC2



T3-PC1D



244 Bergen Boulevard, Woodland Park, NJ 07424
 Phone: 973.998.2300 · Fax: 973.785.4207
 Web: www.fsrinc.com · E-mail: sales@fsrinc.com

Specifications are subject to change without notice.

