

PWB-100

Plasma/Flat Panel Display Wall Box

FSR

Metal Products Group

PWB-100



With Cover



Without Cover

**Now
with three
"block off" plates
and one grommet
included!**

DESCRIPTION

The PWB-100 is the essential installation accessory for any flat panel display. It installs easily in the wall behind any display allowing your screen to sit flush against the wall. This unit provides a neat and secure environment for the audio, video, control and power connections.

The PWB-100 is 11"W x 5.25"H x 3.57"D and installs easily between any two standard studs in the wall. Once populated the overall height is 7.39" behind the wall. Connections and cable entry can be on the top or the bottom depending on installation preference. Designed to mount along the bottom edge behind a Plasma or LCD display, the PWB-100 provides a single point for all your connections. The unit accommodates up to six single space Intelligent Plate Solution plates and a UL listed single gang gem box for AC power.

The PWB is available in white or black and is suitable for painting or other finishing, matching any décor. It has a cable exit slot for the display connections and the excess cable can easily be hidden inside of the box making the entire installation as clean as possible. The cover screws onto the front of the box once all connections are in place.

FSR designed this unit for new and existing construction. Brackets are included for mounting to studs in new construction as well as surface mount clips for mounting to sheet rock or plywood in existing construction.

INCLUDED ACCESSORIES

- | | |
|--|--------------------------|
| 1 - Low voltage back box | 1 - UL listed Gem box |
| 3 - Block off plates | 2 - Custom madison clips |
| 2 - Surface mount clips | 2 - Stud mount brackets |
| 1- Pass through grommet,
additional grommets available
use part #13342 | |

ORDERING INFORMATION

- PWB-100-WHT = White Cover
PWB-100-BLK = Black Cover

FEATURES

- Rugged 14 gauge steel back box with 1/16" front cover
- Compatible with FSR's IPS inserts
- Can be installed in new or old work (mounting adapters included)
- AC and low voltage back box included
- Connectors are hidden behind an attractive cover
- Multiple knockouts in a variety of sizes
- UL listed AC back box provided

APPLICATIONS

- Anywhere a video display is wall mounted!
- Digital Signage
- Conference Centers
- Schools
- Airports
- Electronic Billboards
- Museums
- General Meeting Facilities
- Arenas

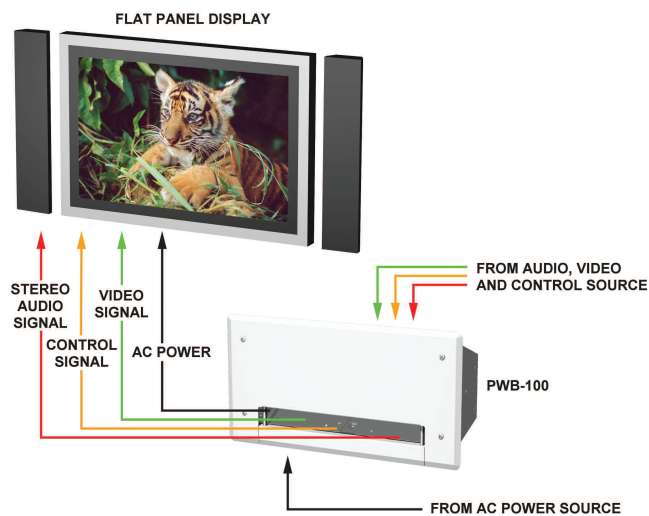





FSR Inc.

Touchboards





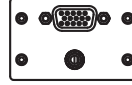
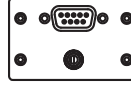
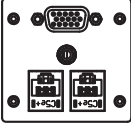
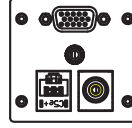
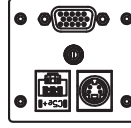

205 Westwood Ave, Long Branch, NJ 07740
Phone: 866-94 BOARDS (26273) / (732)-222-1511
Fax: (732)-222-7088 | E-mail: sales@touchboards.com

PWB-100 ACCESSORIES

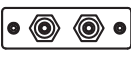
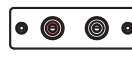
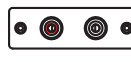

IPS Audio/Video Inserts

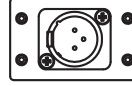
 IPS-AV230S RCA (RED, WHT, YEL) to Solder Cup	 IPS-AV231S RCA (RED, WHT, YEL) to RCA Bulkhead	 IPS-AV922S RCA (YEL) to Solder Cup w/3.5mm St. to Solder Cup
 IPS-AV920D HD-15 Female to HD-15 Female w/3.5mm St. to Solder Cup	 IPS-AV921D HD-15 Female to 5-BNC Tails w/3.5mm St. to Solder Cup	 IPS-AV923D 9-Pin D Female to Female Bulkhead w/3.5mm St. to Solder Cup
 IPS-AVC940T HD-15 to 5 BNC, 3.5mm St., 2 RJ-45 IDC (Cat 5e)	 IPS-AVC941T HD-15 to 5 BNC, 3.5mm St., RCA, RJ-45 IDC (Cat 5e)	 IPS-AVC942T HD-15 to 5 BNC, 3.5mm St., S-Video, RJ-45 IDC (Cat 5e)

IPS Audio Inserts

 IPS-A220S RCA (RED, WHT) to RCA Bulkhead	 IPS-A221S RCA (RED, WHT) to Solder Cup	 IPS-A222S RCA (RED, WHT) to Screw Terminal
 IPS-A510S 3.5mm St. to Solder Cup	 IPS-A610S 3-Pin Mini XLR (Switchcraft)	
 IPS-A611D Female XLR 3-Pin (Neutrik)	 IPS-A612D Male XLR 3-Pin (Neutrik)	 IPS-A613D NEUTRIK SPEAKON

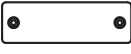
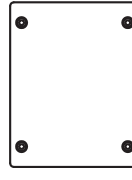
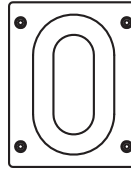

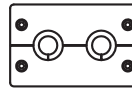
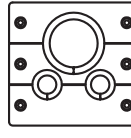
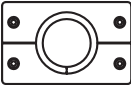







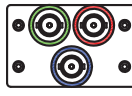

IPS Blank Inserts

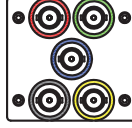
 IPS-B000S Single Space Blank	 IPS-B000Q Four Space Blank	 IPS-B011Q Pass Thru .69" x 1.69" ID Rubber Bushing
 IPS-B000D Double Space Blank	 IPS-B020D Pass Thru 2x .312" ID Bushings	 IPS-B030T Pass Thru 2x .312" ID & .812" ID Bushings
 IPS-B010D Pass Thru .812" ID Bushing		

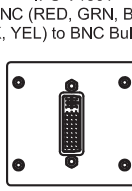

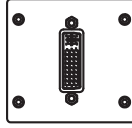



AC Receptacle Accessories

 SS-DPLT1-BLK Black Decora Plastic Plate	 27863 Black Decora 15A Receptacle
---	---





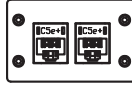

IPS Video Inserts

 IPS-V110S BNC (YEL) to BNC Bulkhead	 IPS-V120S BNC (YEL) to BNC Bulkhead	 IPS-V130D BNC (GRN, RED, BLU) to BNC Bulkhead
 IPS-V210S RCA (YEL) to Solder Cup	 IPS-V211S RCA (YEL) to RCA Bulkhead	 IPS-V150T BNC (RED, GRN, BLU, BLK, YEL) to BNC Bulkhead
 IPS-V213S RCA (YEL) to BNC Bulkhead	 IPS-V230S RCA (GRN, BLU, RED) to RCA Bulkhead	 IPS-V150T BNC (RED, GRN, BLU, BLK, YEL) to BNC Bulkhead
 IPS-V310S S-Video to 2 BNC Tails	 IPS-V610S HDMI Female to Female Bulkhead	 IPS-V611T DVI-I Female to Female Bulkhead
 IPS-V311S S-Video to S-Video Bulkhead	 IPS-V410S HD-15 Female to HD-15 Female	
 IPS-V921S RCA (YEL) to BNC S-Video (YEL) to S-Video	 IPS-V922S BNC (YEL) to BNC S-Video (YEL) to S-Video	

IPS Voice/Data Inserts

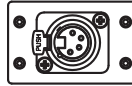
 IPS-D710S RJ-45 IDC (Cat 5e)	 IPS-D711S RJ-45 IDC (Cat 6)	 IPS-D712S RJ-45 Bulkhead (Cat 5e)
 IPS-D713S RJ-45 Bulkhead (Cat 6)	 IPS-D714S RJ-11 IDC	 IPS-D720D RJ-45 IDC (Cat 5e)
	 IPS-D715S USB Type A Bulkhead	

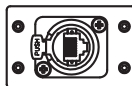
Control Inserts

 IPS-C410S 9-Pin D Male to Female Bulkhead	 IPS-C411S 9-Pin D Male to Solder Cup	 IPS-C610D Female XLR 4-Pin (Neutrik)
 IPS-C611S 4-Pin Mini XLR (Switchcraft)	 IPS-C612S Hole for Crest Net Cable	 IPS-C710D Neutrik RJ-45
 IPS-C910S 1 Momentary Button w/Lamp 5-24V	 IPS-C920S 2 Momentary Buttons w/Lamp 5-24V	

TYPICAL INSTALLATIONS

NEW WORK INSTALLATION

WALL OPENING: 11" x 5-1/4"

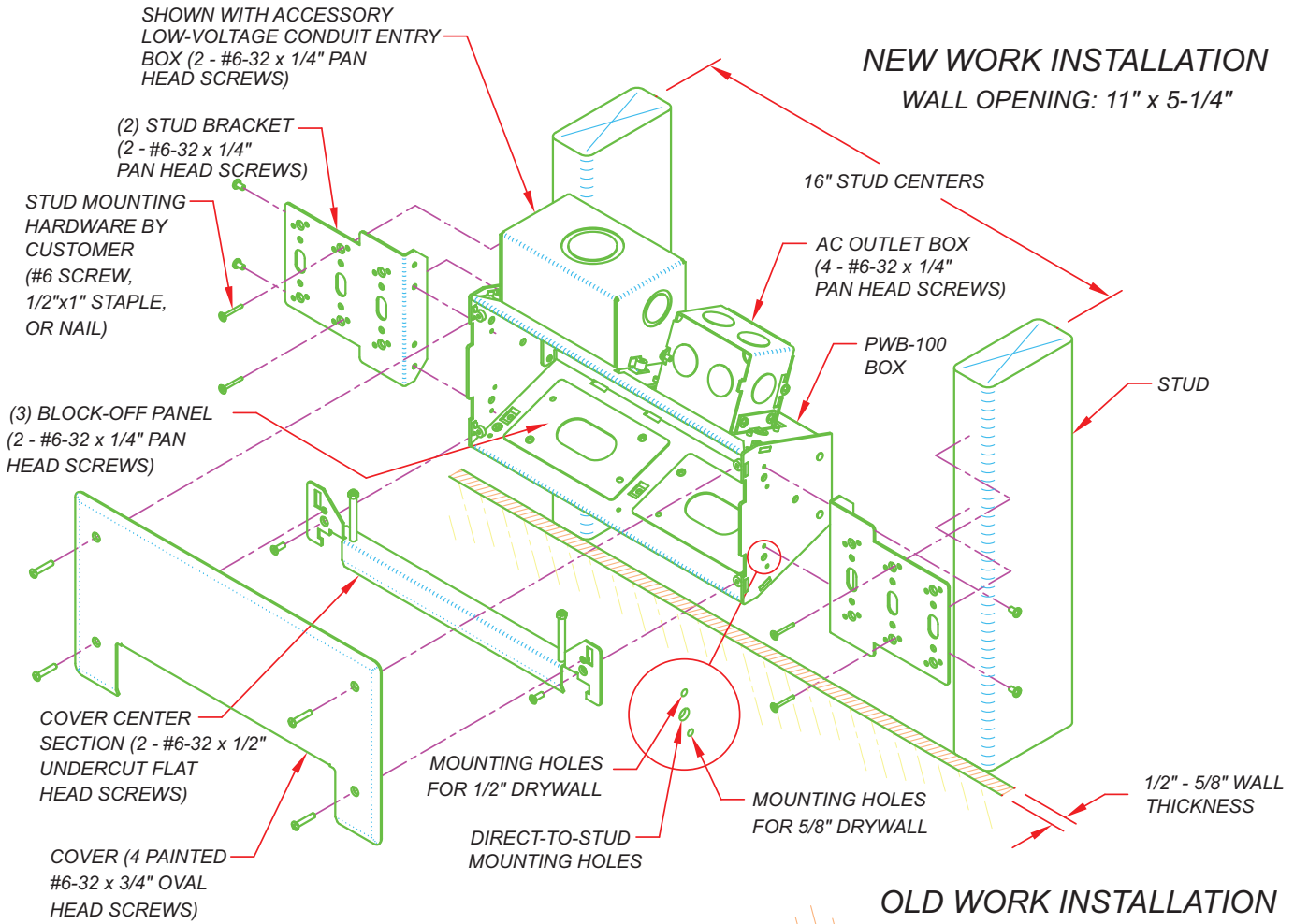

OLD WORK INSTALLATION

WALL OPENING: 11" x 5-1/4"

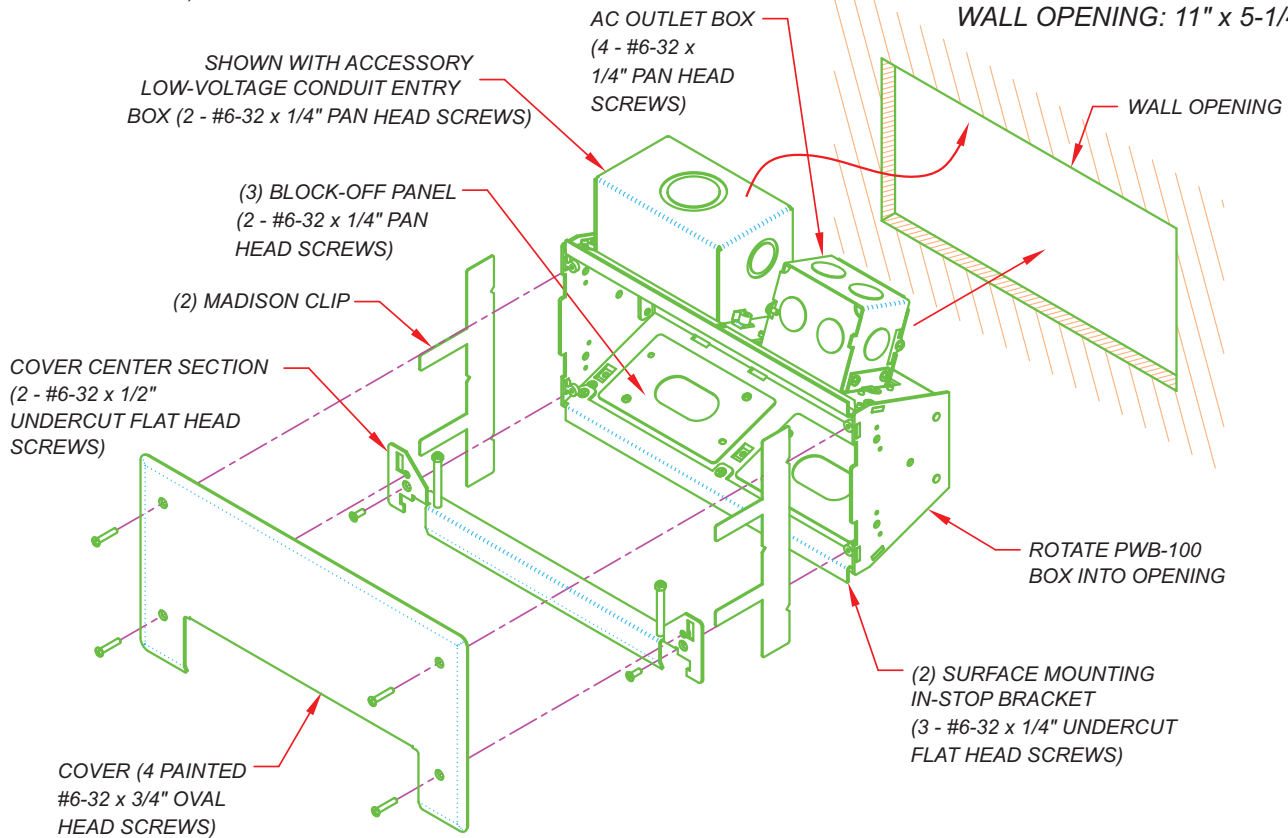

PWB-100 OVERALL DIMENSIONS

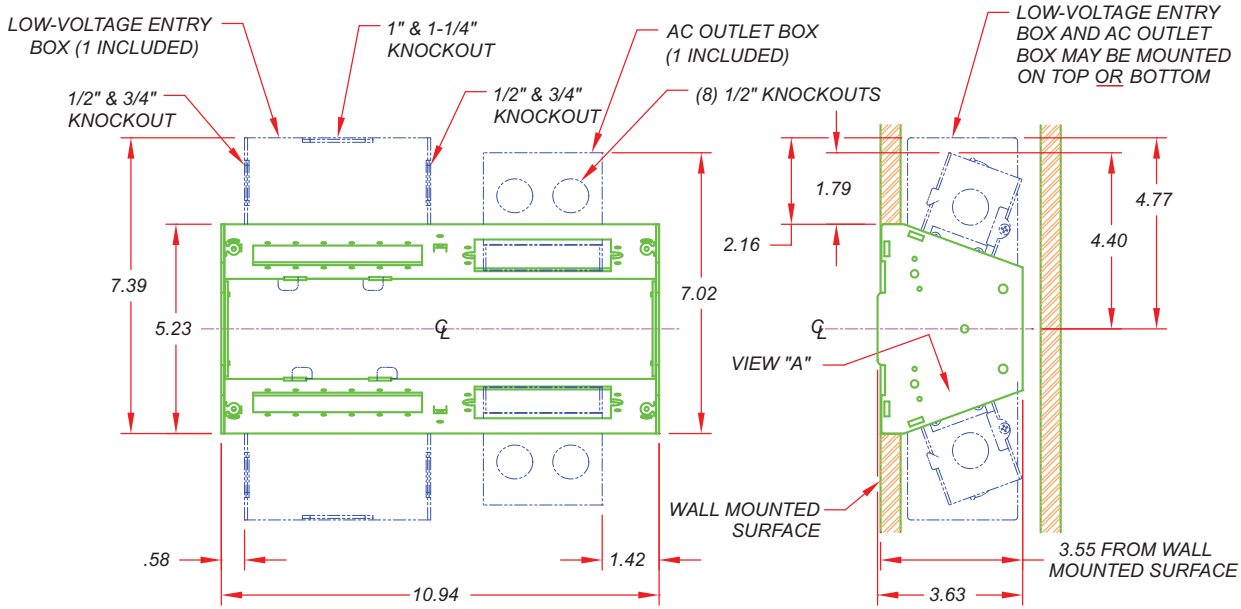
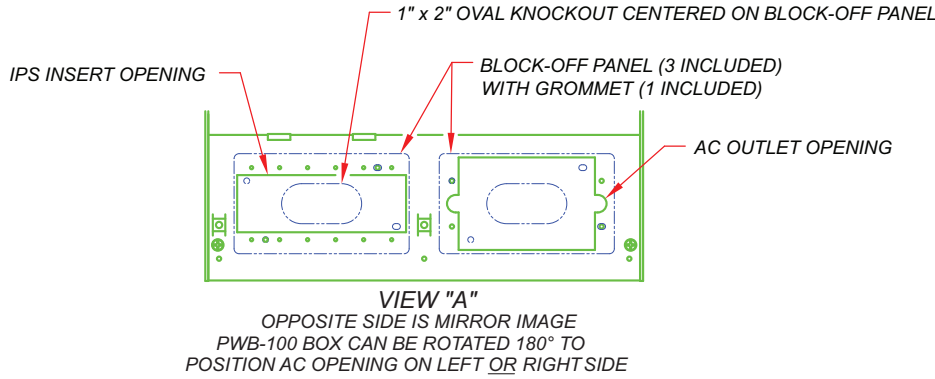

OTHER FSR PRODUCT OFFERINGS

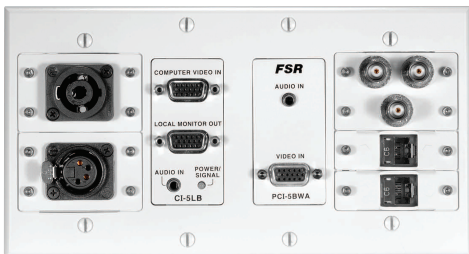

IPS-WP2Q-WHT (populated)



WB-PR26 (populated)

The Intelligent Plate Solution (IPS) line is a wide variety of inter-connect solutions to satisfy any AV interface application. Create unlimited combinations of connector inserts with this diverse assortment of sleek wall plate and under table mounting styles. Customize your table, wall or floor box with our IPS plates.

FSR addresses the rising issue of network security with the new series of locking wall boxes. With 18 different models, everything from recessed to surface mounts are available for new or existing construction. Store any wall plate or connections safely and securely.

Specifications are subject to change without notice.

