



# User Manual



## HD-HPCUWP-TX 100m HDBaseT 2.0 Transmitter Wall Plate



244 Bergen Boulevard, Woodland Park, NJ 07424 • Tel 973-785-4347 • FAX 973-785-3318 • Web: [www.fsrinc.com](http://www.fsrinc.com)

# Important Safety Instructions



1. Do not expose this apparatus to rain, moisture, dripping or splashing and that no objects filled with liquids, such as vases, shall be placed on the apparatus.



6. Clean this apparatus only with dry cloth.



2. Do not install or place this unit in a bookcase, built-in cabinet or in another confined space. Ensure the unit is well ventilated.



7. Unplug this apparatus during lightning storms or when unused for long periods of time.



3. To prevent risk of electric shock or fire hazard due to overheating, do not obstruct the unit's ventilation openings with newspapers, tablecloths, curtains, and similar items.



8. Protect the power cord from being walked on or pinched particularly at plugs.



4. Do not install near any heat sources such as radiators, heat registers, stoves, or other apparatus (including amplifiers) that produce heat.



9. Only use attachments / accessories specified by the manufacturer.



5. Do not place sources of naked flames, such as lighted candles, on the unit.



10. Refer all servicing to qualified service personnel.

# FCC Compliance

This equipment has been tested and found to comply with the limits for a Class B digital device, pursuant to Part 15 of the FCC Rules. These limits are designed to provide reasonable protection against harmful interference in a residential installation. This equipment generates uses and can radiate radio frequency energy and, if not installed and used in accordance with the instructions, may cause harmful interference to radio communications. However, there is no guarantee that interference will not occur in a particular installation. If this equipment does cause harmful interference to radio or television reception, which can be determined by turning the equipment off and on, the user is encouraged to try to correct the interference by one or more of the following measures:

- Reorient or relocate the receiving antenna.
- Increase the separation between the equipment and receiver.
- Connect the equipment into an outlet on a circuit different from that to which the receiver is connected.
- Consult the dealer or an experienced radio/TV technician for help.

Changes or modifications not expressly approved by the party responsible for compliance could void the user's authority to operate the equipment.



# Table of Contents

Important Safety Instructions .....	2
FCC Compliance .....	3
Overview.....	7
Features .....	8
Package Contents.....	8
Specifications .....	9
Panel Layout .....	12
Inputs Switching .....	14
Connection and Installations .....	15
API Command Control .....	17
Troubleshooting.....	21
Limited Warranty .....	22
CONTACT INFORMATION: .....	23



# Overview

The FSR HD-HPCUWP-TX is a 2x1 switcher for HDMI and VGA w/audio inputs with an HDBaseT 2.0 output. It features standard two-gang mounting, with one HDMI and one VGA plus audio input, a separate stereo audio channel on a 3.5 mm connector, Ethernet pass-through, IR receiver pass-through, and USB pass-through. The USB port is configurable to host or device. HDMI signals up to 4K/UHD@60(YUV 4:2:0 color sub-sampling), VGA input signals up to 1920 x 1200, embedded audio, and control signals can be extended up to 328feet (100 meters). A micro-USB connector located under the 2-gang cover plate is used to configure the unit.

The USB 2.0 pass-through provides a solution for users who want to control or monitor a remote server or connect to an electronic whiteboard. An additional analog audio pass-through allows distribution of a separate stereo audio source to the receiver side. The Ethernet pass-through provides a convenient network drop for PC's or other equipment. The IR receiver pass-through allows control of remotely located equipment at the receiver side of the system.

The HD-HPCUWP-TX wall plate can be the central component of a small, automated AV system. Automatic display control via CEC or RS-232 turns on the display whenever a source is connected. When the source is removed, the display is turned off. Automatic input selection on the wall plate works by detecting the presence of any video signal. With automatic input selection, manual control systems can be eliminated. The HD-HPCUWP-Tx is normally powered by a receiver unit having 48V PoH such as the HD-HU-SP-Rx (sold separately), but a local 12 volt power input screw terminal connector is provided for additional flexibility.

## Features

- One switched, HDMI or VGA with stereo audio input
- Auto switching with video detection technology
- Display Auto-power feature via CEC or RS-232
- Manual override switches for source selection and display power
- One analog stereo audio input to receiver
- 4Kx2K@60Hz (YUV 4:2:0 color sub-sampling) and 1080P@60Hz output up to 100m via Cat 6/6a/7 cable
- 4Kx2K@60Hz (YUV 4:2:0 color sub-sampling) output up to 90m, while 1080P@60Hz up to 100m Via Cat 5e cable
- HDMI with 4k@60Hz (Chroma sub-sampling 4:2:0 8-bit only) and HDCP 2.2 compliance
- Supports Long Reach Mode, extending 1080p@60Hz signals to 150m via the API command interface.
- High-speed USB 2.0, up to 480Mbps, over HDBaseT up to 100m
- 2-Gang Decora wall plate
- Ethernet and IR pass-through over HDBaseT 2.0
- PoH support or powered locally
- Firmware upgrade and device configuration via Micro USB for easy field service (located under 2-gang cover plate)

## Package Contents

- One FSR HD-HPCUWP-TX HDBaseT Wall Plate Transmitter
- One Phoenix Male Connector (3.5mm, 2 Pins)
- One 2-gang plastic cover plate with mounting screws



# Specifications

Video	
Input	1 x VGA IN 1 x HDMI IN
Input Signal Type	HDMI with HDCP2.2
Input Resolution Support	<p>VGA: 800x600<sup>8</sup>, 1024x768<sup>8</sup>, 1280x720<sup>8</sup>, 1280x800<sup>8</sup>, 1280x960<sup>8</sup>, 1280x1024<sup>8</sup>, 1360x768<sup>8</sup>, 1440x900<sup>8</sup>, 1600x900<sup>8</sup>, 1600x1200<sup>8</sup>, 1680x1050<sup>8</sup>, 1920x1080<sup>8</sup>, 1920x1200<sup>8</sup></p> <p>HDMI: 800x600<sup>8</sup>, 1024x768<sup>8</sup>, 1280x720<sup>8</sup>, 1280x768<sup>8</sup>, 1280x800<sup>8</sup>, 1280x960<sup>8</sup>, 1280x1024<sup>8</sup>, 1360x768<sup>8</sup>, 1366x768<sup>8</sup>, 1440x900<sup>8</sup>, 1600x900<sup>8</sup>, 1600x1200<sup>8</sup>, 1680x1050<sup>8</sup>, 1920x1080<sup>8</sup>, 1920x1200<sup>8</sup>, 2560x1440<sup>8</sup>, 2560x1600<sup>8</sup>, 3840x2160P<sup>2,3,5,8(YUV4:2:0)</sup>, 4096x2160P<sup>2,3,5,8(YUV4:2:0)</sup> 1 = at 23.98 Hz, 2 = at 24 Hz, 3 = at 25 Hz, 4 = at 29.97 Hz, 5 = at 30 Hz, 6 = at 50 Hz, 7 = at 59.94 Hz, 8 = 60 Hz</p>
Input Video Level	0.5~1.0Vp-p

Maximum Pixel Clock	297MHz
Output	1 x HDBT
Output Signal Type	HDBT
Output Resolution Support	<p>800x600<sup>8</sup>, 1024x768<sup>8</sup>, 1280x720<sup>8</sup>,  1280x768<sup>8</sup>, 1280x800<sup>8</sup>, 1280x960<sup>8</sup>,  1280x1024<sup>8</sup>, 1360x768<sup>8</sup>, 1366x768<sup>8</sup>,  1440x900<sup>8</sup>, 1600x900<sup>8</sup>, 1600x1200<sup>8</sup>,  1680x1050<sup>8</sup>, 1920x1080<sup>8</sup>, 1920x1200<sup>8</sup>,  2560x1440<sup>8</sup>, 2560x1600<sup>8</sup>,  3840x2160P<sup>2,3,5,8(YUV4:2:0)</sup>,  4096x2160P<sup>2,3,5,8(YUV4:2:0)</sup></p> <p>1 = at 23.98 Hz, 2 = at 24 Hz, 3 = at 25 Hz,  4 = at 29.97 Hz, 5 = at 30 Hz, 6 = at 50 Hz,  7 = at 59.94 Hz, 8 = 60 Hz</p>
Video Impedance	100ohms
<b>Audio</b>	
Audio Input	<p>1 x unbalanced stereo 3.5mm mini jack,  binding with VGA input;  1 x extra unbalanced stereo 3.5mm mini  jack</p>
Supported Audio Format	<p><b>HDMI:</b>  Stereo, LPCM 5.1, LPCM 7.1; Dolby True  HD, DTS-HD Master Audio</p> <p><b>Unbalanced mini jack:</b>  Stereo</p>

<b>General</b>	
Operating Temperature	0 to + 45°C (32 to + 113 °F)
Storage Temperature	-20 to +70°C (-4 to + 158 °F)
Humidity	10% to 90%, non-condensing
Power Supply	DC 12V/PoH
Power Consumption	7 W (Max)
ESD Protection	Human-body Model: ±8kV(Air-gap discharge)/ ±4kV(Contact discharge)
Device Dimension (W x H x D)	3.6" x 4.18" x 1.7" (overall) 3.6" x 2.72" x 1.5" (rear dimensions)
Product Weight	0.18kg
Certification	CE, FCC

## Cable Specifications

**Note:** FSR recommends use of straight-through Category cables wired to T568B standard.

<b>Cable Type</b>	<b>Range</b>	<b>Supported Video</b>
Cat5e	90m	4Kx2K@60Hz (YUV 4:2:0 color sub-sampling)
	100m	1080P@60Hz
Cat6/6a/7	100m	4Kx2K@60Hz (YUV 4:2:0 color sub-sampling) 1080P@60Hz

# Panel Layout

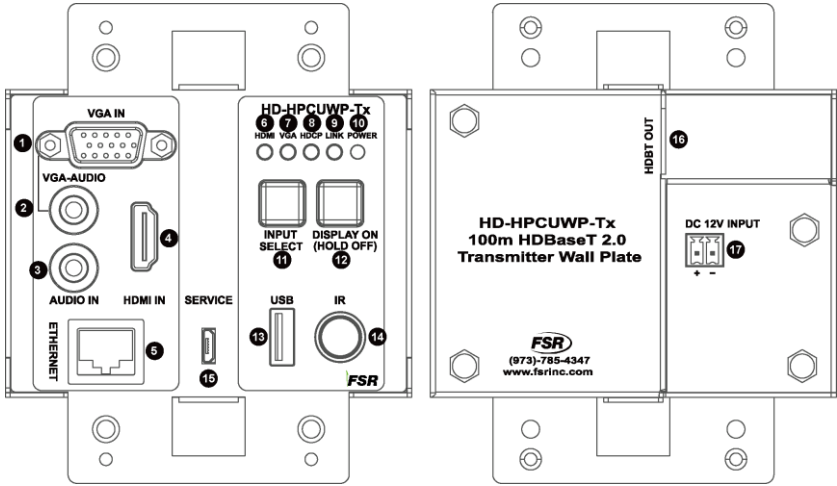

ID	Name	Description
1	VGA IN	Connect to VGA source device.
2	VGA-AUDIO	Stereo audio input, for use with VGA source
3	AUDIO IN	Unbalanced stereo audio input
4	HDMI IN	Connect to HDMI source device.
5	ETHERNET	RJ45 port, connect to PC or other network port
6	HDMI LED	<b>ON:</b> HDMI signal is being transmitted. <b>OFF:</b> No signal or signal is unstable.
7	VGA LED	<b>ON:</b> VGA signal is being transmitted. <b>OFF:</b> No signal or signal is unstable.
8	HDCP LED	<b>ON:</b> HDCP video is being transmitted <b>Blinking:</b> Non-HDCP video is being transmitted <b>OFF:</b> No video is being transmitted

9	LINK LED	<b>ON:</b> HDBT link is normal <b>OFF/Blinking:</b> No link or link error.	
10	Power LED	<b>ON:</b> The transmitter is powered on. <b>OFF:</b> The transmitter is powered off.	
11	INPUT SELECT Button	a	Short press to select the HDMI or VGA source
		b	Hold press for at least 10 seconds to switch to USB modes: <ul style="list-style-type: none"> <li>• <b>USB Host mode:</b> The HDMI and VGA LED indicators will be solid on for 3 seconds.</li> <li>• <b>USB Device mode:</b> The HDMI and VGA LED indicators will flash 3 times.</li> </ul>
12	DISPLAY ON/OFF Button	<b>Display On:</b> Short press to power on the display device immediately. <b>Display Off:</b> Hold press for at least 3 seconds to power off the display device immediately. <b>Note:</b> API command control is also available to power on/off the display.	
13	USB	Connect to a USB host or device.	
14	IR Sensor	IR window with built in IR receiver (30-55KHz).	
15	SERVICE	Micro USB port for firmware upgrade and device configuration	
16	HDBT OUT	Connect to an HDBT receiver.	
17	POWER INPUT	Connect to 12V power supply with 2-pin pluggable male connector if not powering via PoH receiver.	

# Inputs Switching

- The front panel SELECT INPUT button is used for selecting an input source when VGA and HDMI video signals are connected.
- When both VGA and HDMI are present, detecting another valid input signal, it will follow the rule—"Last in-First out".
- When both VGA and HDMI inputs are connected and are active, the unit will output the HDMI signal (HDMI priority over VGA). While under other auto switching scenarios, please refer to following table:

VGA Input	HDMI Input	Output
No Signal	Signal Present	HDMI
No Signal	No Signal	No Output
Signal Present	Signal Present	HDMI
Signal Present	No Signal	VGA
Not Connected	Signal Present	HDMI
Not Connected	No Signal	No Output

# Connection and Installations

1. Connect an HDMI or VGA source (such as Blu-ray, DVD, HDD, camera, games console, Satellite/cable TV, computer, CCTV, media server etc.) to the HD-HPCUWP-TX Transmitter.

**Note:** Take care when connecting cables and do not force insertion if resistance is felt.

2. Connect a high quality, well-terminal Cat5e/6/6a/7 cable from the HDBT OUT port of the HD-HPCUWP-TX to HDBT IN Input of your HDBT Receiver.

**Note:** 90m @4K or 100m @1080p video are the maximum recommended transmission distances for this model and denotes ideal transmission conditions – including straight cable runs with no electrical interference, bends, kinks, patch panels or wall outlets.

If any of the above is a factor in your installation, transmission range may be affected – take care to avoid where possible.

3. Connect a PC to the ETHERNET port of the HD-HPCUWP-TX.
4. Connect the USB port to the PC, at the same time connect the receiver's USB ports to USB devices (such as keyboard, mouse and interactive whiteboard) for remote control.
5. Connect an HDMI display device (LED/LCD display or projector) to the HDMI OUT of your HDBT Receiver.
6. Connect an audio amplifier to the audio out of your receiver.
7. Connect an IR emitter cable to the IR OUT of your receiver to control the display device at HD-HPCUWP-TX transmitter side with the display remote from IR sensor.
8. Connect a PC to the ETHERNET port of the receiver.
9. Power on the HDBT receiver which supports PoH function, it will power the HD-HPCUWP-TX Transmitter. The HD-HPCUWP-TX may be

powered locally via the pluggable screw terminals on the back of the unit



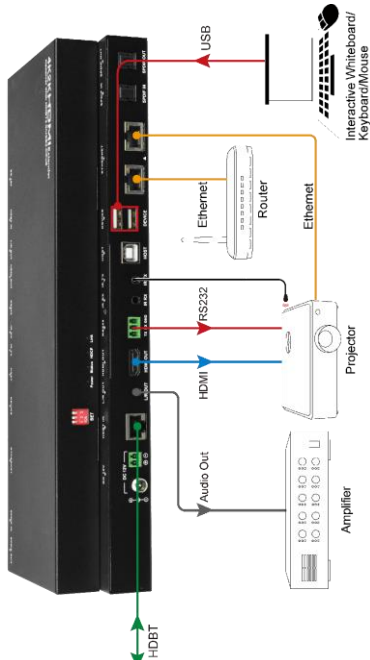

HDBT

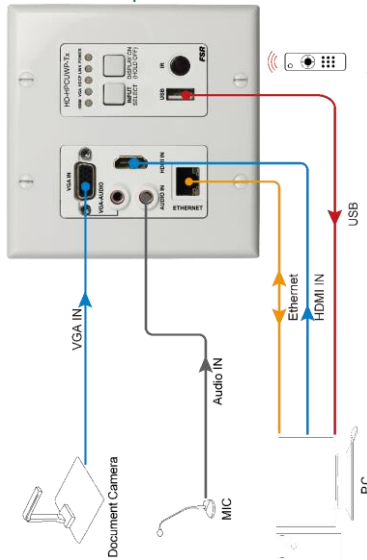

# API Command Control

(See the API Command Set Manual for more details)

Users can control the device via sending API commands as well. Please refer to the following steps.

**Step 1.** Connect the HD-HPCUWP-TX HDBT OUT and your receiver HDBT IN, HD-HPCUWP-TX can be powered by receiver via CatX cable.

**Step 2.** Use a Micro USB-B to USB-A cable to connect the HD-HPCUWP-TX SERVICE port and your PC USB port. It is ready for sending API commands.

**Step 3.** Open your PC **Device manager**, find out the port, here is **COM 2** as example.

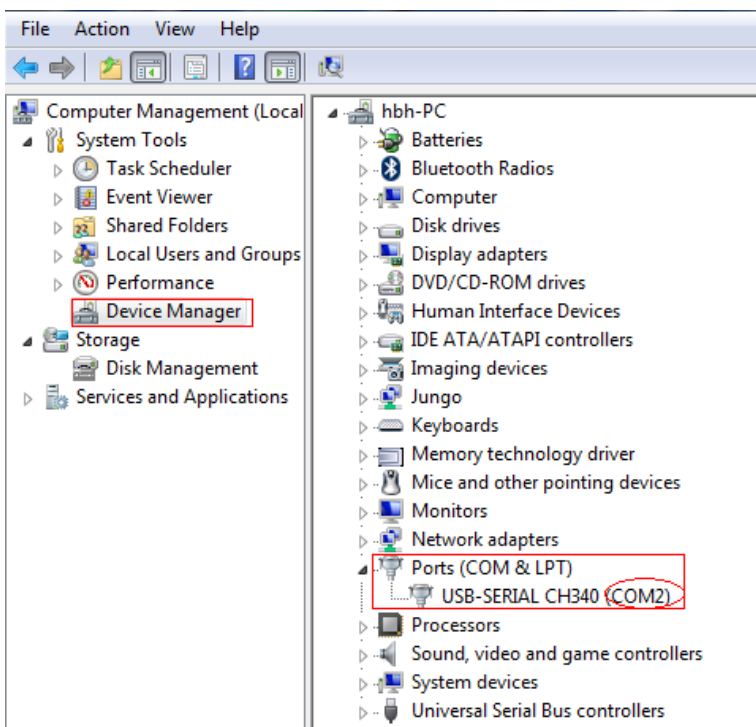

**Step 4.** Use your favorite serial communication utility program (CommUart Assistant shown in example)

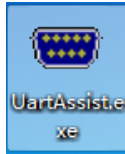

**Step 5.** Open **UartAssist** tool and type the port number **COM 2** and Baud Rate **115200**.

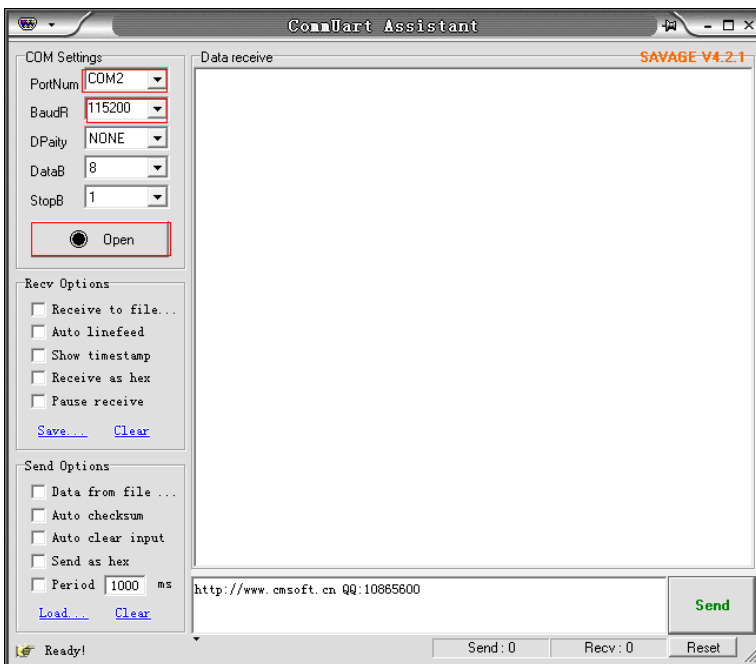

**Step 6.** Click **Open**, the button will become red for operation.

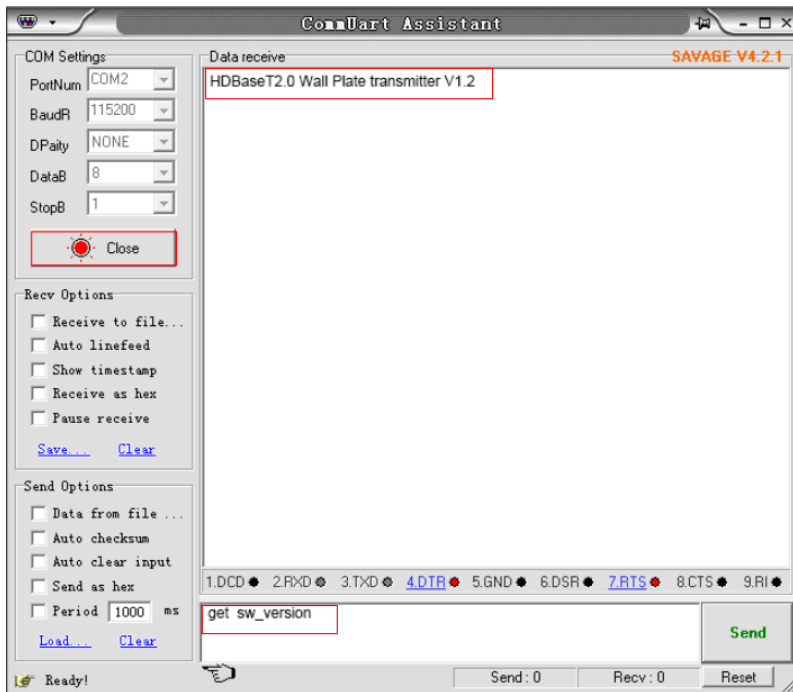

Type the commands in the data transmit window , for example “get sw\_version”, click your PC **Enter** button and click the Uart Tool **Send** button, the Data receive window will show the response.

**Note:** More information please refer to the **API Commands list**.

# Troubleshooting

## Steps of Regular Troubleshooting Routine

1. **Power:** Please make sure all devices are powered on (the sources, wall plate transmitter HD-HPCUWP-TX, receiver and display).
2. **Indicator:** Please make sure LED indicators of HD-HPCUWP-TX is normal according to user manual.
3. **Devices:** Please make sure picture can be shown normally when connecting source to display devices directly.
4. **Cable:** Plug in and out HDMI/Cat X cable or try another HDMI/Cat X cable.
  - Please make sure the specific cable length is within the transmission range in Specification section.
  - Cat 5e/6/6a/7 cable is recommended. Do not use Cat 5 cable.
  - Please make sure the two connectors of one Cat X cable are the same standard (EIA/TIA 568B).
5. **Compatibility:** Please test other source and display devices to determine if it is a compatibility issue.

# Limited Warranty

The HD-HPC-SP-TX, HD-HPCWP-SP-TX 100m HDBaseT HDMI and VGA 2x1 Switcher / Extender are warranted against failures due to defective parts or faulty workmanship for a period of three years after delivery to the original owner. During this period, FSR will make any necessary repairs or replace the unit without charge for parts or labor. Shipping charges to the factory or repair station must be prepaid by the owner, return-shipping charges (via UPS Ground) will be paid by FSR.

This warranty applies only to the original owner and is not transferable. In addition, it does not apply to repairs done by other than the FSR factory or Authorized Repair Stations.

This warranty shall be cancelable by FSR at its sole discretion if the unit has been subjected to physical abuse or has been modified in any way without written authorization from FSR. FSR's liability under this warranty is limited to repair or replacement of the defective unit.

FSR will not be responsible for incidental or consequential damages resulting from the use or misuse of its products. Some states do not allow the exclusion of incidental or consequential damages, so the above limitations may not apply to you. This warranty gives you specific legal rights, and you may also have other rights which vary from state to state.

Warranty claims should be accompanied by a copy of the original purchase invoice showing the purchase date (if a Warranty Registration Card was mailed in at the time of purchase, this is not necessary). Before returning any equipment for repair, please read the important information on service below.

## SERVICE

Before returning any equipment for repair, please be sure that it is adequately packed and cushioned against damage in shipment, and that it is insured. We suggest that you save the original packaging and use it to ship the product for servicing. Also, please enclose a note giving your name, address, phone number and a description of the problem.

NOTE: all equipment being returned for repair must have a Return authorization (RMA) Number. To get a RMA Number, please call the FSR Service Department (1-800-332-FSR1).

Please display your RMA Number prominently on the front of all packages.

# CONTACT INFORMATION:

FSR INC.

244 Bergen Blvd.

Woodland Park, NJ 07424

Phone: (973) 785-4347

Order Desk Fax: (973) 785-4207

**Web Site:** <http://www.fsrinc.com>