

# *ML-400*

*Room Combining System  
Operation & Installation  
Manual*

---

## *FSR*

244 Bergen Boulevard, West Paterson, NJ 07424

E-Mail [sales@fsrinc.com](mailto:sales@fsrinc.com)

Tel 973-785-4347

Fax 973-785-3318

Web [www.fsrinc.com](http://www.fsrinc.com)



## THE ML-400 ROOM AUDIO COMBINING SYSTEM

The ML-400 is a direct microphone input (no external mixer required) version of the popular ML-104 system.

The ML-400 is a small (4-room or less) combining system that benefits from FSR's experience as the leader in room combining. This system is being offered as a very cost-effective solution to the needs of smaller venues (conference centers, churches, funeral homes, country clubs, meeting facilities, gymnasiums).

**The ML-400 system is designed for background music and the use of only 1 microphone per room. The cost of microphone mixers are eliminated from the installation.**

The system features in-room control plates to operate microphone on or off, background music on or off, a combine switch that can select one of two tielines or local, and a volume control for both mic and music.

Efficient and foolproof installation is assured. The in-room, 3-gang wallplates have a 7-wire cable that con-

nects via a pluggable screw connector to the main control unit, and power for the main unit is provided by a PM-2 power supply.

System operation is easily understood and can be controlled by the staff.

To combine two rooms, place each room's combining switch to Tieline A. The rooms are now mixed. For background music set the music volume control on each room's wallplate to the same value, and select "music on" in both rooms. Music will be heard in both rooms equally loud. The other two rooms could be combined by placing each room combining switch to Tieline B.

If microphone operation is desired then the rooms could be mixed as above, the microphone switch turned on in all mixed rooms (two in this example), and then only the room in which the microphone will be used should have the volume control adjusted for a comfortable listening level in both rooms.

If none of the rooms are combined, then each room's combining switch must be set on local. This allows full control of each room's audio from the wallplate.

All microphone inputs as well as the music input are electronically balanced. All audio outputs are balanced, 600 ohm, transformer-coupled outputs insuring trouble-free installation.

There are two busses: Line A and Line B. Any wallplate that selects either of these busses will have its associated audio summed with any other wallplate that selects the same line. Since this is a four-room system (or less), only two busses are required to mix rooms in any conceivable fashion.

Whenever rooms are combined, those room's music volume controls should be set at the same level. However, the microphone volume control should be set at minimum and only increased to proper level in the room that has the microphone.

Note that the music audio can be summed with the microphone audio anytime the microphone switch and the music switch are in the on position. This is not a usual condition and should be explained to the user.

The wallplates fully control the system; however, the wallplates receive no audio signals. This design permits the main unit to be placed with the rest of the audio equipment, again simplifying installation and servicing.

A "QUICK SETUP GUIDE" has been provided to simplify day-to-day operation. Please instruct the user on the proper use of the ML-400 with the use of this guide.

## **ML-400 INSTALLATION DATA**

The ML-400 Room Combining System is shipped with the following equipment:

- Audio Control Unit
- 4 wallplates with one packet of wallplate connectors (Crimp terminals)
- PM-2 Power Supply

Refer to the hookup diagram before installing.

The Audio Control Unit is to be located wherever the audio amplifiers are located. If the amplifiers are rack mounted, then the ML-400 should be located near the top of the rack. The PM-2 power supply can be located anywhere — the rear of the rack or on a nearby shelf.

The wallplates are mounted in standard 3-gang electrical boxes in the wall with the four 6/32 screws supplied.

Prior to fastening the wallplate, connect the wallplate wires to the cable that homeruns to the main unit. The packet of wallplate connectors permits direct connection to the cable with no wire stripping (see diagram).

If you use West Penn Wire #271 cable (8-conductor #22 AWG stranded, the yellow conductor is unused), the colors from the wallplate will match the cable colors. The pinout for the pluggable screw connectors can be found in the control hookup diagram.

NOTE: No audio lines are run to the wallplates.

# CONTROL HOOKUP DIAGRAM

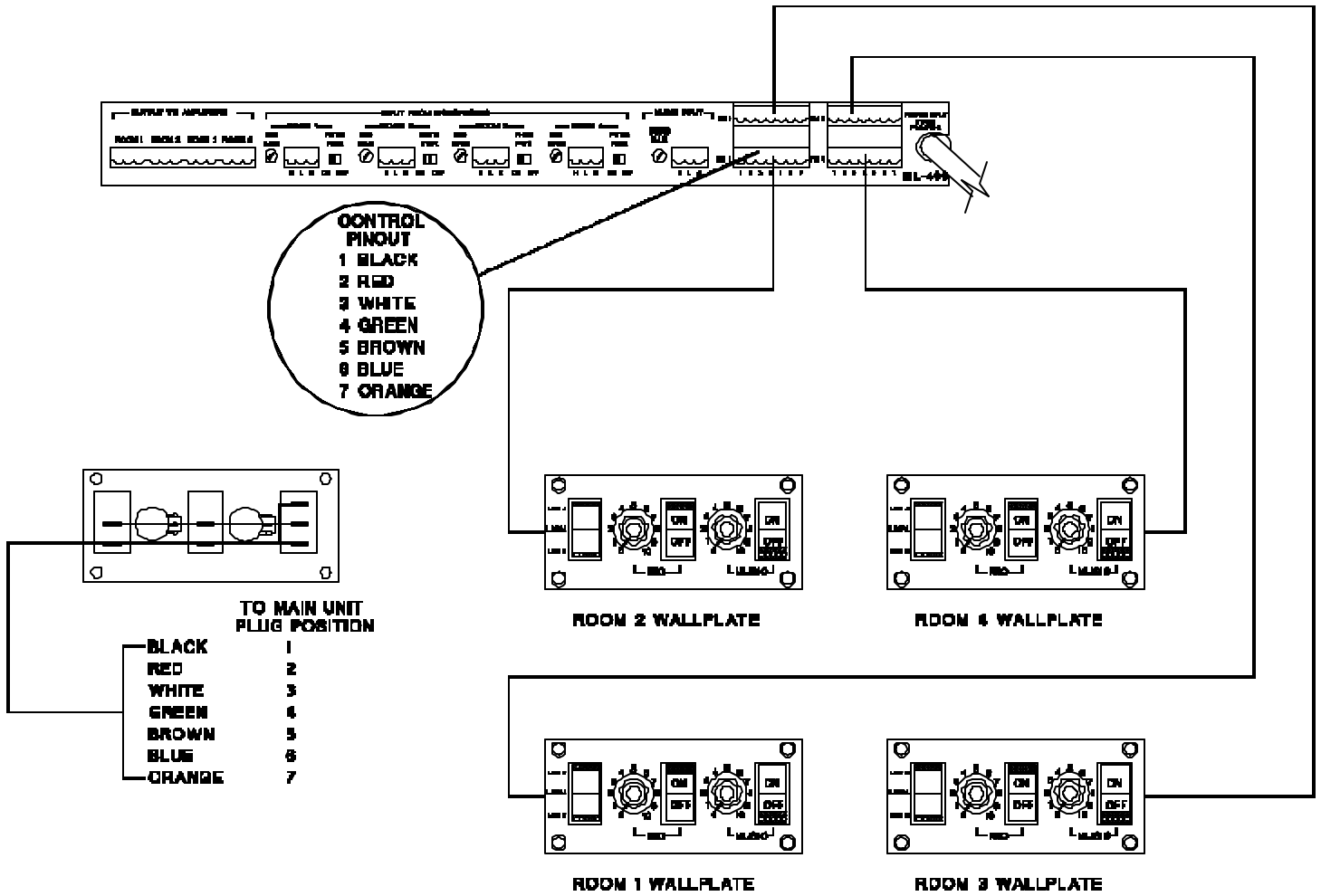

*NOTE: Use the insulated self-piercing connectors to connect the wallplate wires to the already installed cable (West Penn #271). To use these splicing connectors just insert the wallplate wire and the corresponding cable wire and crimp with a pair of pliers.*

AUDIO HOOKUP DIAGRAM

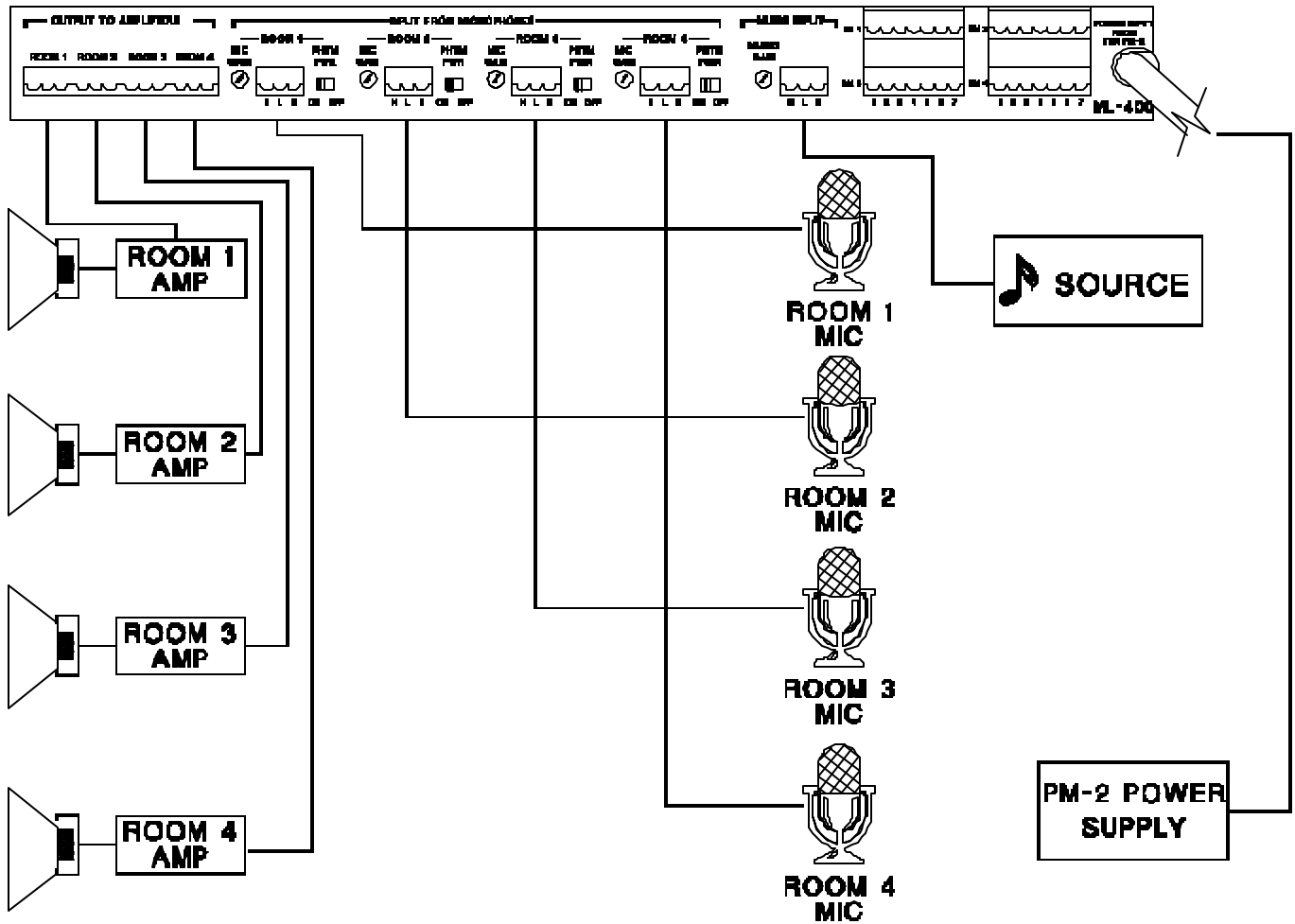

The microphone and music inputs are screw terminals and can be wired one of two ways:

**For balanced lines** (the usual case with microphones):

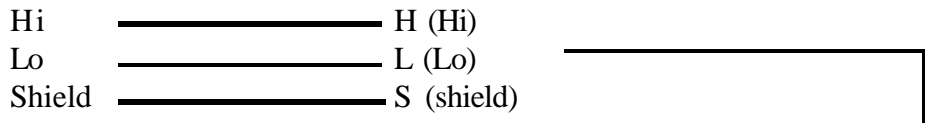

**For unbalanced lines** (the usual case with music sources):

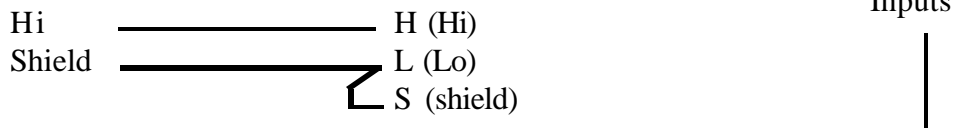

The audio outputs are screw terminals and can be wire one of two ways:

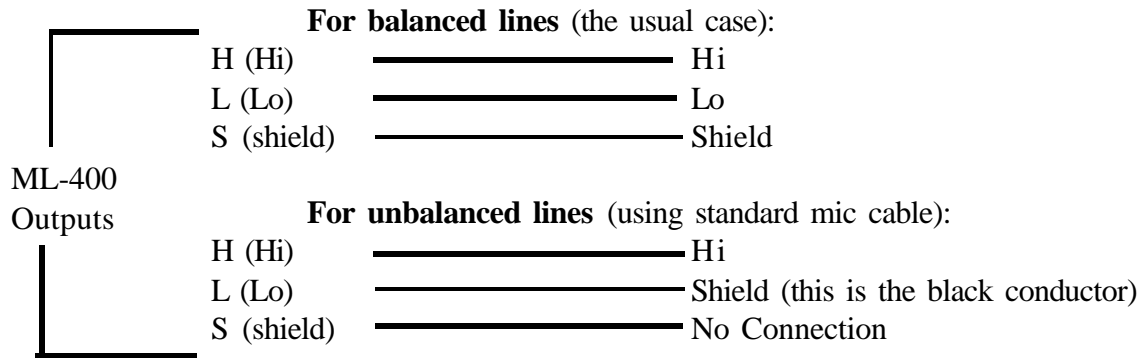

**SYSTEM SET UP (TURN ON)**

**OPERATE MUSIC:**

Referring to the audio hookup diagram, connect the room microphones, and room amplifiers. Connect the background music source to the MUSIC INPUT located on the rear of the Audio Control Unit. Set each wallplate as shown below. Check to make sure the input trim pot (MUSIC GAIN) on the rear of the unit is set midway. Play some music and then adjust the amplifier volume for equal loudness in each room (**this is very important**).

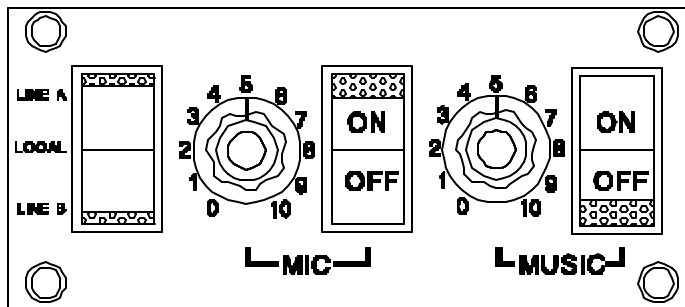

Only readjust the GAIN SET (Located on the rear of the Audio Control Unit) to maintain a comfortable level in each room if the music source has a very low output (not usually the case).

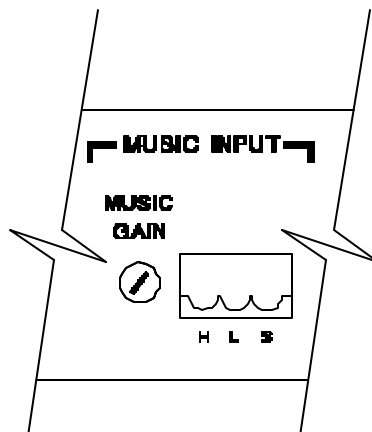

**OPERATE MICROPHONES:**

Shut music off and turn microphones on in all rooms. Wallplates in all rooms should look as follows:

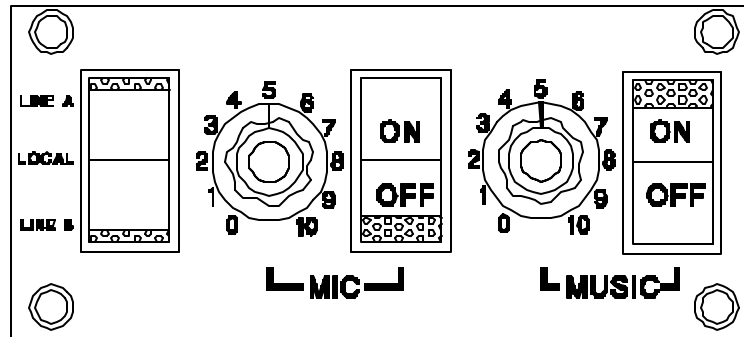

Have someone talk into each room's microphone in turn and adjust each room's rear panel gain adjust (MIC GAIN) for a comfortable listening level (this means the same level as agreed upon when setting up the music) in each room. If phantom powered microphones are used, turn on the switch labeled PHTM PWR.

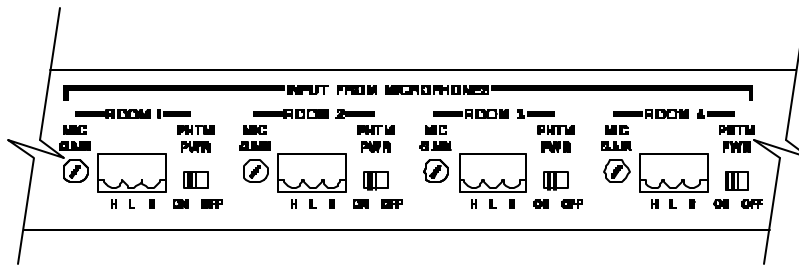

To check the wallplates combining function, adjust all wallplates as shown:

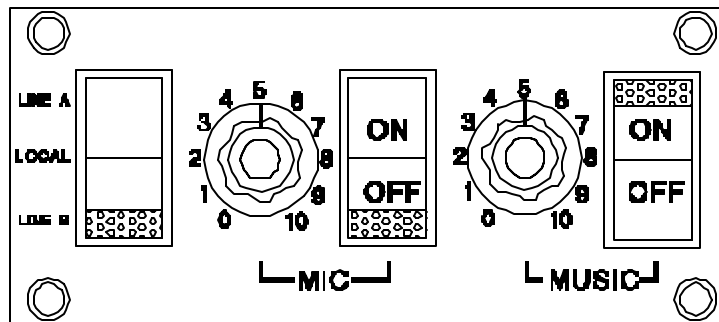

When speaking into a room's microphone, one's voice should be heard equally loud in all rooms. Combine any two rooms and leave two separate by setting the wallplates as follows:

**ROOMS 1 AND 2 COMBINED / ROOMS 3 AND 4 SEPARATE**

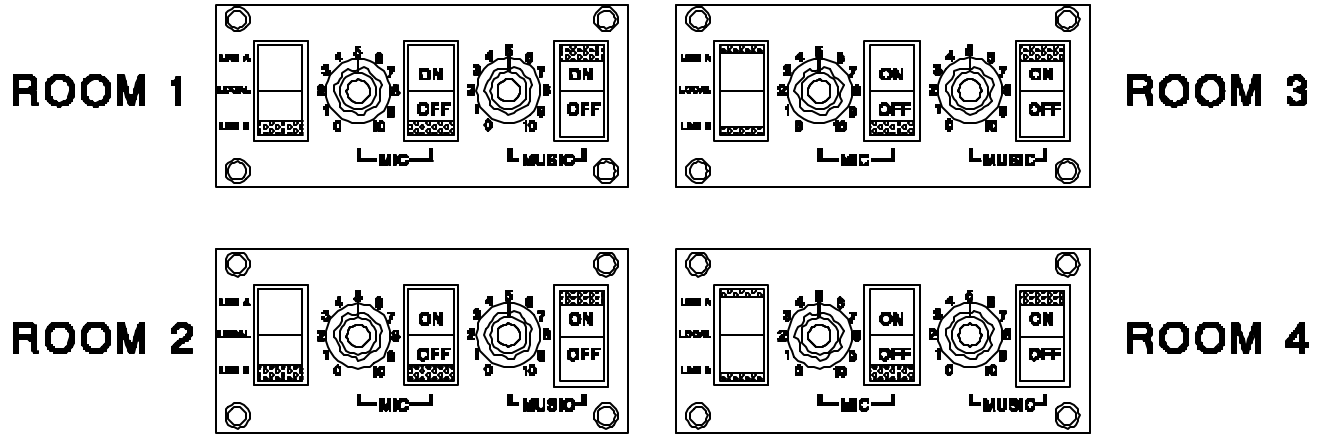

When speaking into the combined room's microphone, one's voice should be heard only in the combined rooms. The other two rooms will be silent.

Combine rooms 1 and 2 and also rooms 3 and 4 by setting the wallplates as shown:

**ROOMS 1 AND 2 COMBINED / ROOMS 3 AND 4 COMBINED**

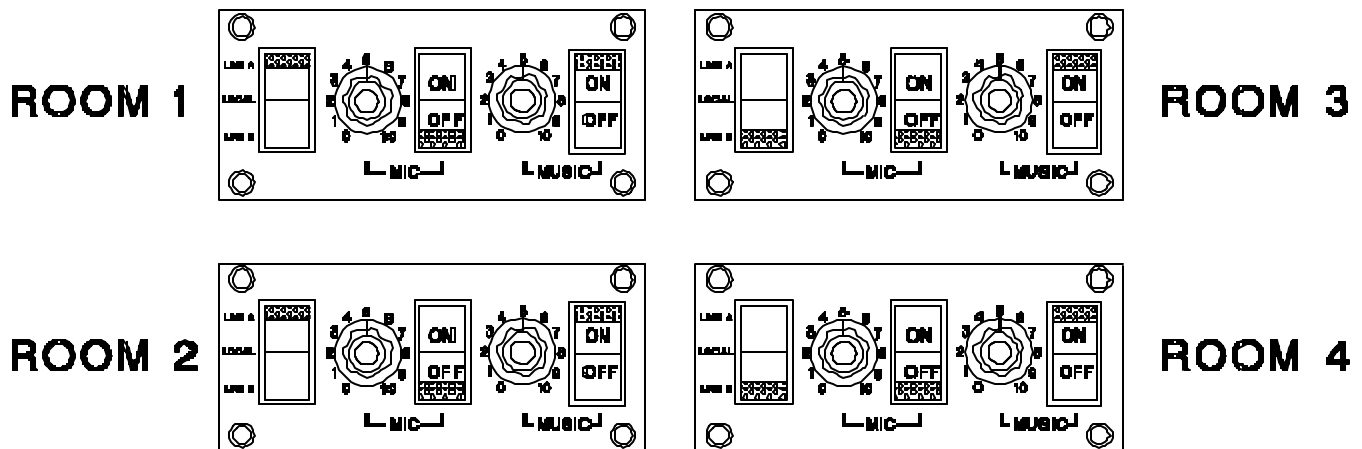



This configuration permits two separate sets of combined rooms to operate independent of each other. Check this by having someone else speak into the other combined rooms. The audio in each pair of combined rooms should be separate.

Finally, set each wall plate as shown (no sound should be heard in any of the rooms). This concludes the installation of the ML-400.

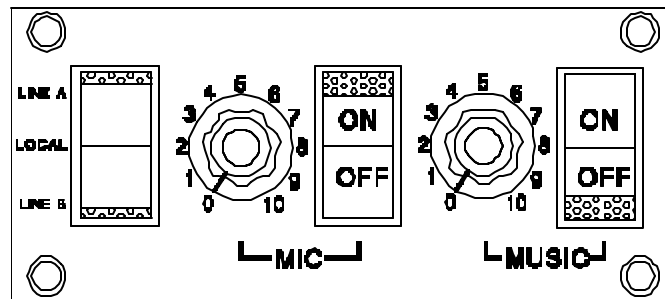

The ML-400 system should now be in full operation and ready to be turned over to your client. Remember to take your client through the simple setup procedures.

**A “QUICK SETUP GUIDE” has been provided to simplify day to day operation. Please instruct the user on the proper use of the ML-400 with the use of this guide.**

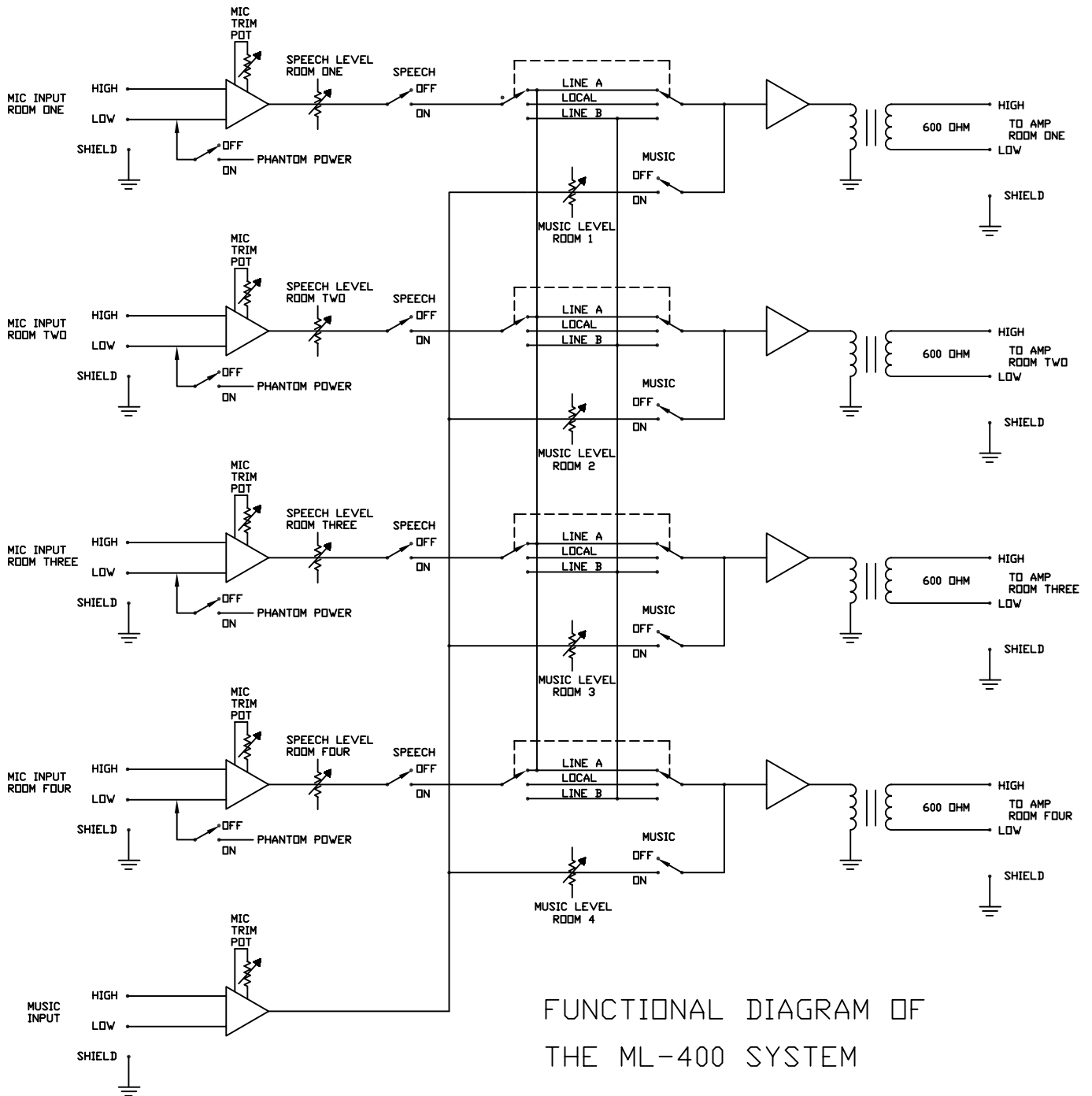

FUNCTIONAL DIAGRAM OF THE ML-400 SYSTEM

ML-400 QUICK SETUP GUIDE

PLAY MUSIC

ROOM 1

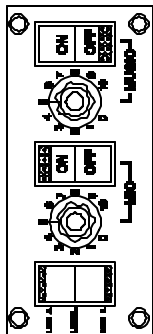

ROOM 2

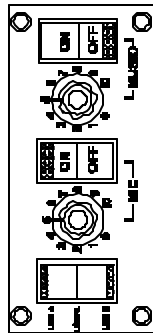

ROOM 3

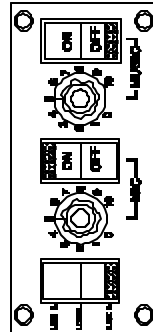

ROOM 4

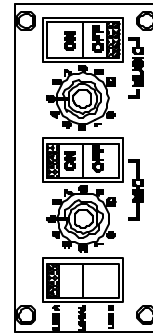

OPERATE MICROPHONE

EACH ROOM SEPARATE

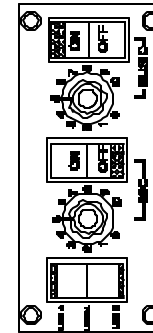
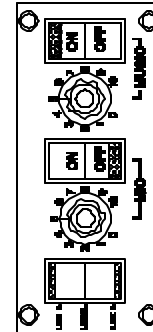
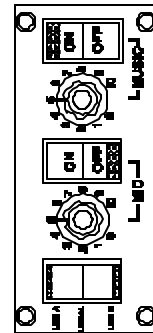
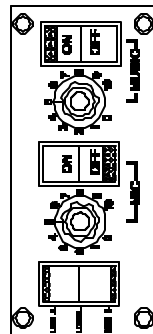

ALL ROOMS COMBINED

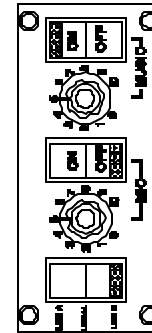
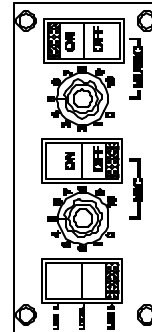
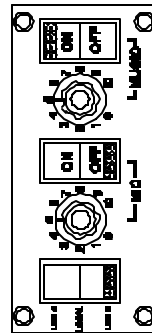
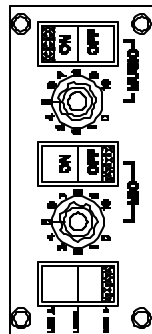

ROOMS 1 AND 2 COMBINED / ROOMS 3 AND 4 SEPARATE

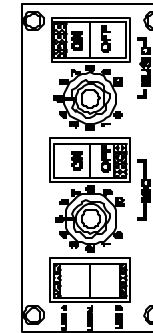
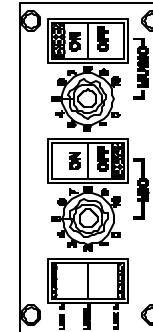
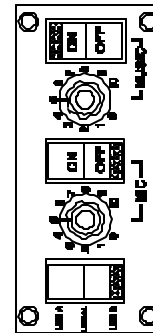
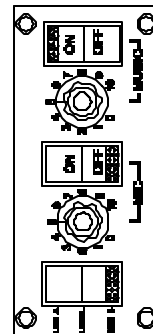

ROOMS 1 AND 2 COMBINED / ROOMS 3 AND 4 COMBINED

