

# *ML-500*

*Room Combining System  
Operation & Installation  
Manual*

---

---

## **FSR**

244 Bergen Boulevard, West Paterson NJ 07424  
E-Mail [sales@fsrinc.com](mailto:sales@fsrinc.com)

Tel 973-785-4347 Fax 973-785-3318  
Web [www.fsrinc.com](http://www.fsrinc.com)



# FSR inc.

AUDIO PRODUCT GROUP

244 Bergen Boulevard, West Paterson, NJ 07424

Tel 973-785-4347

Fax 973-785-3318

E-Mail fsr!sales@attmail.com

## ML-500

### OPERATION and INSTALLATION



## THE ML-500 ROOM AUDIO COMBINING SYSTEM

Ideal for smaller hotels and conference centers with more stringent budget restraints, the ML-500 strikes a good balance in the basic requirements of microphone and music control and the more elaborate features found in our larger combining systems.

The system features in-room control plates to operate microphone (on or off), background music (on or off), a combine switch that can select one of two tielines or local, and a volume control for the mic and music audio levels.

Efficient and fool proof installation is assured. The in-room, 3-gang wallplates have a 7-wire cable that connects via a pluggable screw connector to the main control unit, and power for the main unit is provided by a PM-2 power supply.

System operation is easily understood and can be controlled by the staff.

To combine two rooms, place each room's combining switch to Tieline A. The rooms are now mixed. For background music set the music volume control on each

room's wallplate to the same value, and select "music on" in both rooms. Music will be heard in both rooms equally loud. The other two rooms could be combined by placing each room combining switch to Tieline B.

If microphone operation is desired, the rooms could be mixed as above, the microphone switch turned on in all mixed rooms (two in this example), and then set the volume control equally in both rooms, for a the desired listening level.

If none of the rooms are combined, then each room's combining switch must be set on local. This allows full control of each room's audio from the wallplate. All mixer inputs as well as the music input are electronically balanced. All audio outputs are balanced, 600 ohm, transformer-coupled outputs insuring trouble-free installation.

There are two busses: Line A and Line B. Any wallplate that selects either of these busses will have its associated audio summed with any other wallplate that selects the same line. Since this is a four-room system (or less), only two busses are required to mix rooms in any conceivable fashion.

Whenever rooms are combined, the volume controls in those rooms should be set at the same level.

Note that the music audio can be summed with the microphone audio anytime the microphone switch and the music switch are in the on position.

The wallplates fully control the system; however, the wallplates receive no audio signals. This design permits the main unit to be placed with the rest of the audio equipment, again simplifying installation and servicing.

A "QUICK SETUP GUIDE" has been provided to simplify day-to-day operation. Please instruct the user on the proper use of the ML-500 with the use of this guide.

## **ML-500 INSTALLATION DATA**

The ML-500 Room Combining System is shipped with the following equipment:

- Audio Control Unit
- 4 wallplates with one packet of wallplate connectors (Crimp terminals)
- PM-2 Power Supply

Refer to the hookup diagram before installing.

The Audio Control Unit is to be located wherever the audio amplifiers are located. If the amplifiers are rack mounted, then the ML-500 should be located near the top of the rack. The PM-2 power supply can be located at the rear of the rack or on a nearby shelf.

The wallplates are mounted in standard 3-gang electrical boxes (2 3/4" deep) in the wall with the four 6/32 screws (supplied).

Prior to fastening the wallplate, connect the wallplate wires to the cable that homeruns to the main unit. The packet of wallplate connectors permits direct connection to the cable with no wire stripping.

If you use West Penn Wire #271 cable (8-conductor #22 AWG stranded) the colors from the wallplate will match the cable colors. The pinout for the pluggable screw connectors can be found in the control hookup diagram.

NOTE: No audio lines are run to the wallplates.

### CONTROL HOOKUP DIAGRAM

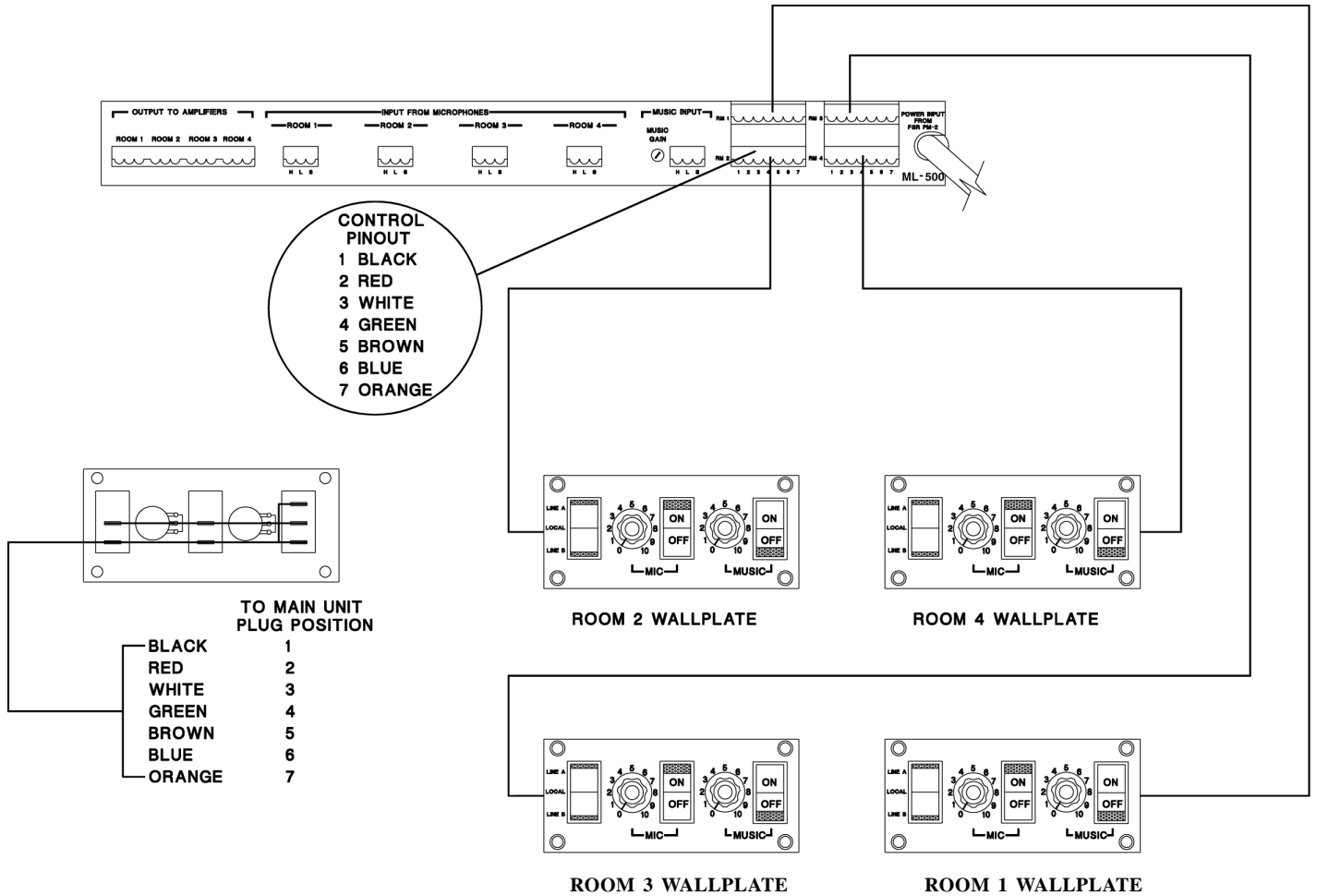

*NOTE: Use the insulated self piercing connectors to connect the wallplate wires to the already installed cable (West Penn #271). To use these splicing connectors just insert the wallplate wire and the corresponding cable wire and crimp with a pair of plier*



The audio outputs are screw terminal connectors and can be wired one of two ways:

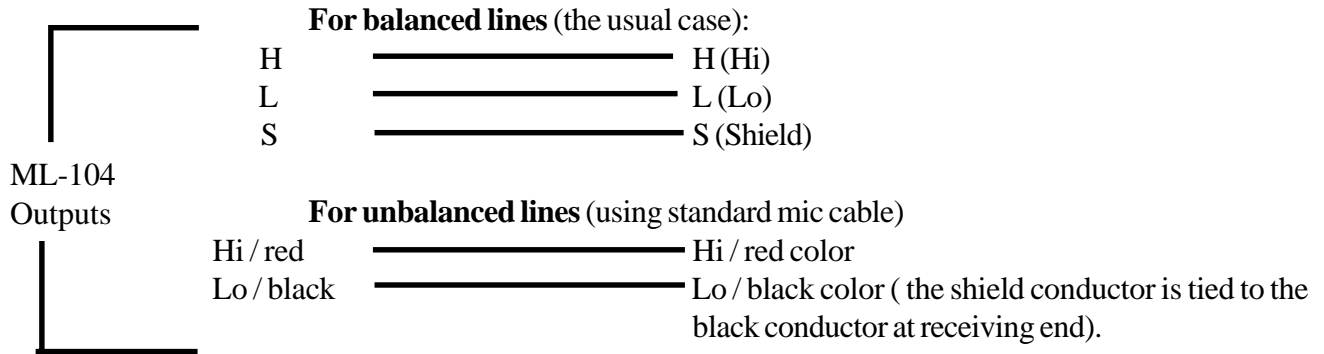

### SYSTEM SET UP (TURN ON)

#### OPERATE MUSIC:

Referring to the audio hookup diagram, connect the room microphones, and room amplifiers. Connect the background music source to the MUSIC INPUT located on the rear of the Audio Control Unit. Set each wallplate as shown below. Check to make sure the input trim pot (MUSIC GAIN) on the rear of the unit is set midway. Play some music and then adjust the amplifier volume for equal loudness in each room (**this is very important**).

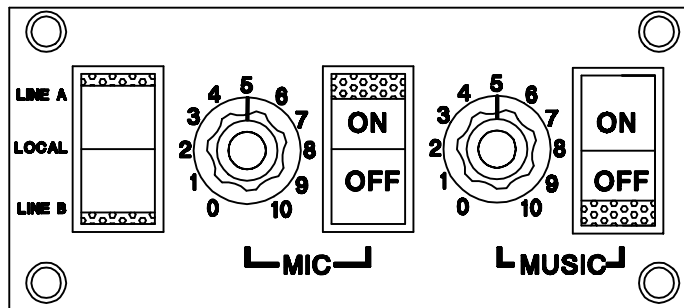

Only readjust the GAIN SET (located on the rear of the Audio Control Unit) to maintain a comfortable level in each room if the music source has a very low output (not usually the case).

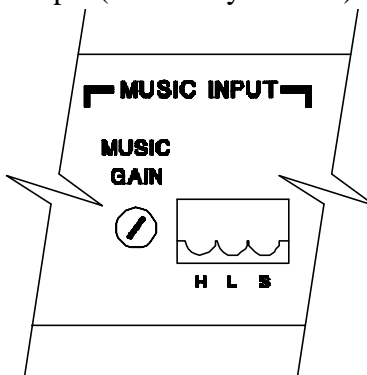

### OPERATE MICROPHONES:

Shut music off and turn microphones on in all rooms. Wallplates in all rooms should look as follows:

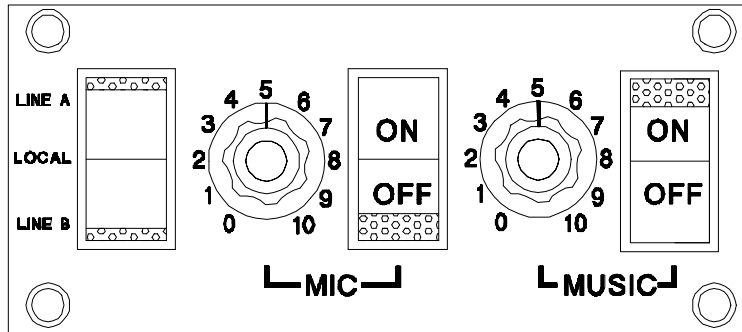

Have someone talk into each room's microphone in turn and adjust each room's mixer output level for a comfortable listening level (this means the same level as agreed upon when setting up the music) in each room.

### COMBINING ROOMS

To check the wallplates combining function, adjust all wallplates as shown:

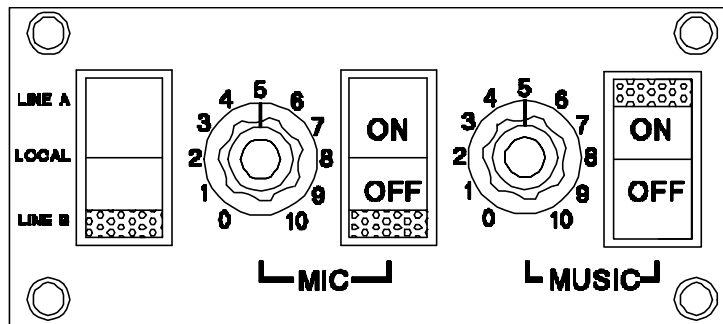

When speaking into a room's microphone, one's voice should be heard equally loud in all rooms. Proceed next to demonstratedifferent combinations



Combine any two rooms and leave two separate by setting the wallplates as follows:

**ROOMS 1 AND 2 COMBINED / ROOMS 3 AND 4 SEPARATE**

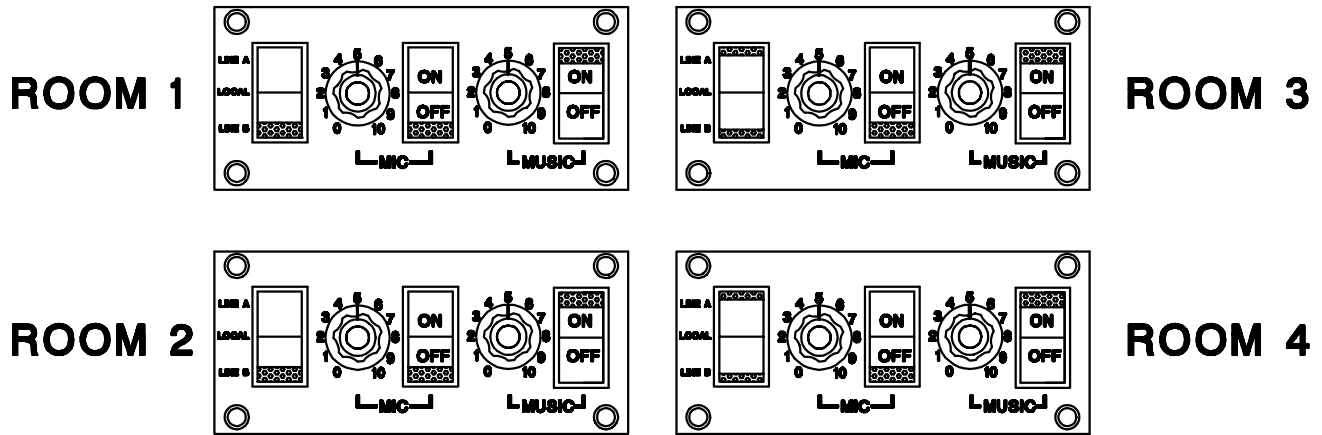

When speaking into the combined room's microphone, the voice should be heard only in the combined rooms. The other two rooms will be silent.

Combine rooms 1 and 2 and also rooms 3 and 4 by setting the wallplates as shown:

**ROOMS 1 AND 2 COMBINED / ROOMS 3 AND 4 COMBINED**

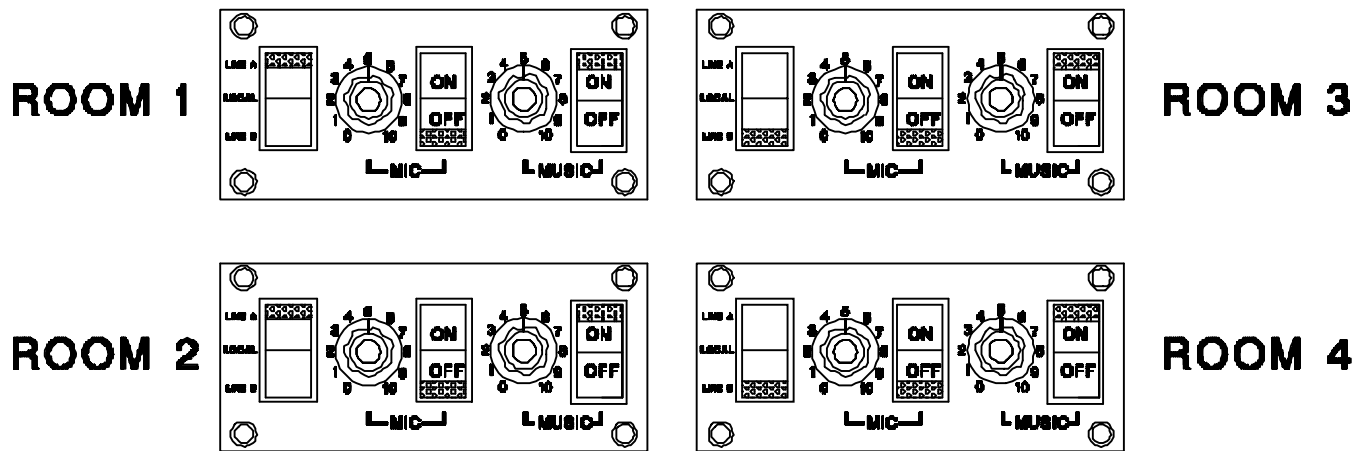

This configuration permits two separate sets of combined rooms to operate independent of each other. Check this by having someone else speak into the other combined rooms. The audio in each pair of combined rooms should be separate.

Finally, set each wall plate as shown (music will be heard in each room). This concludes the installation of the ML-500.

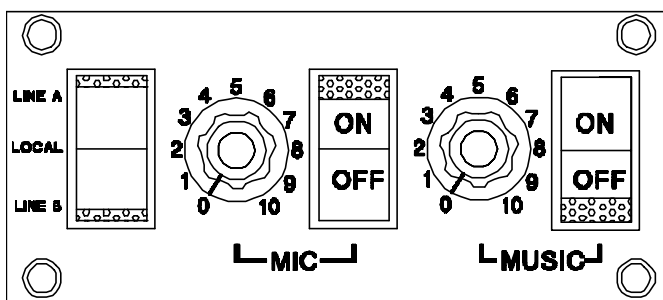

The ML-500 system should now be in full operation and ready to be turned over to your client. Remember to take your client through the simple setup procedures.

**A “QUICK SETUP GUIDE” has been provided to simplify day to day operation. Please instruct the user on the proper use of the ML-500 with the use of this guide.**

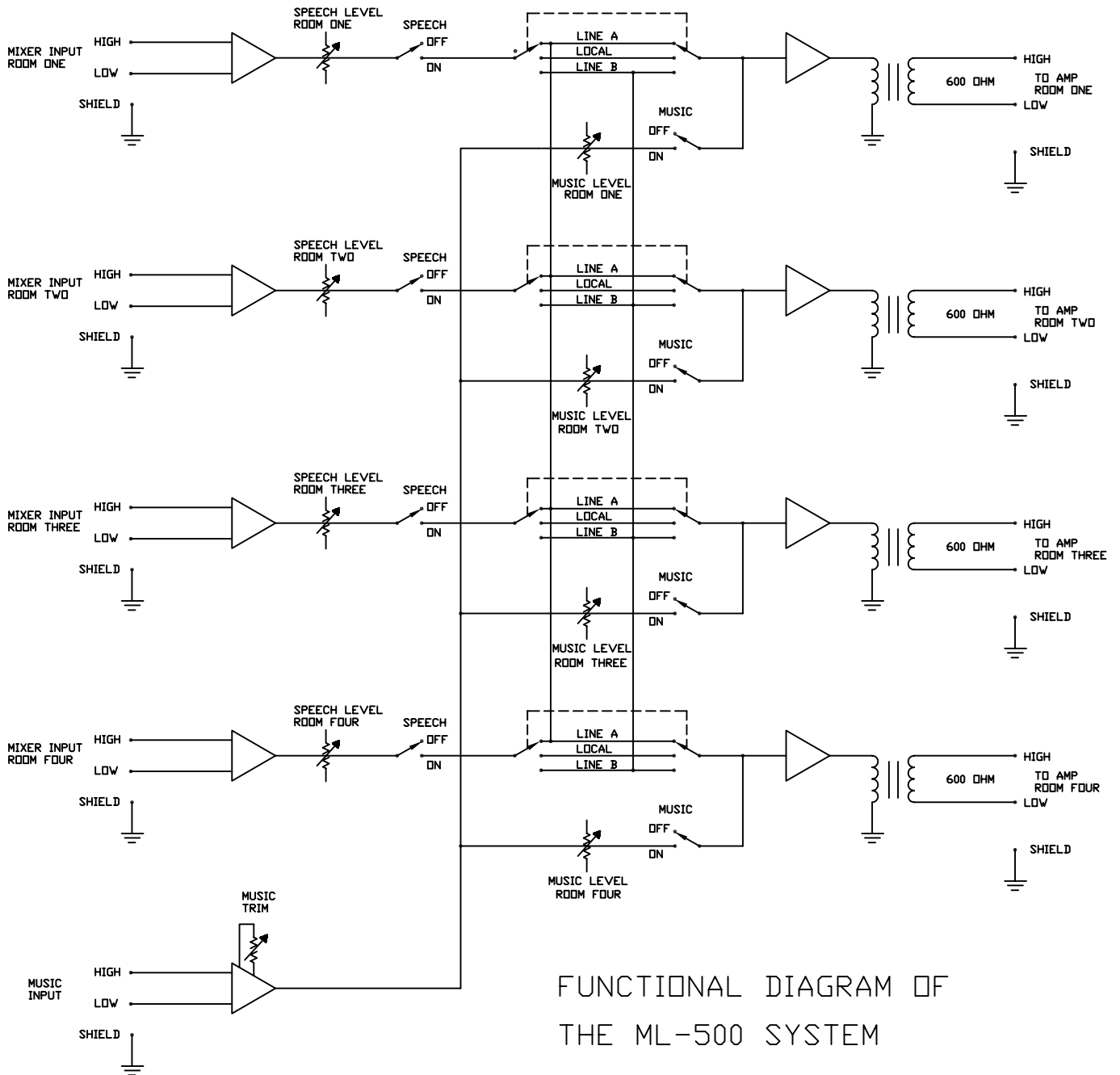

FUNCTIONAL DIAGRAM OF THE ML-500 SYSTEM

**ML-500 QUICK SETUP GUIDE**

**PLAY MUSIC**

**ROOM 1**

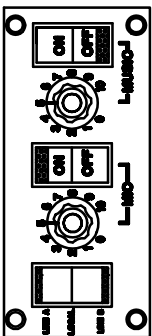

**ROOM 2**

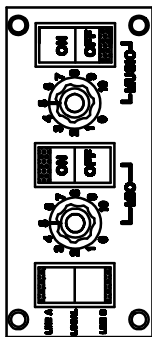

**ROOM 3**

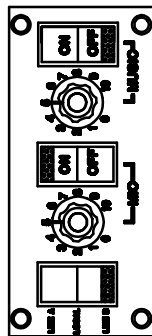

**ROOM 4**

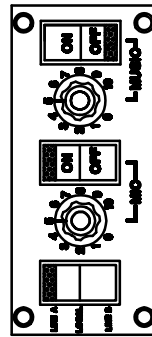

**OPERATE MICROPHONE  
EACH ROOM SEPARATE**

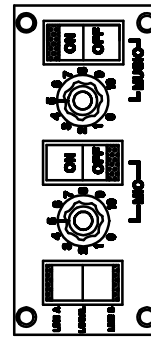
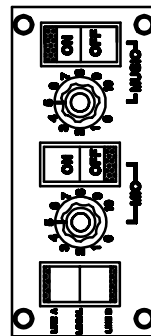
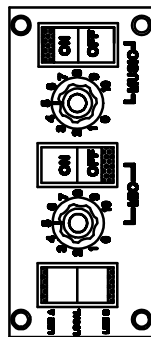
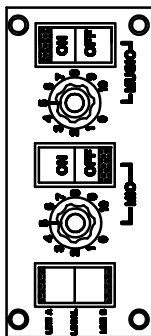

**ALL ROOMS COMBINED**

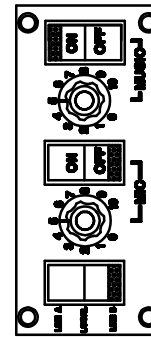
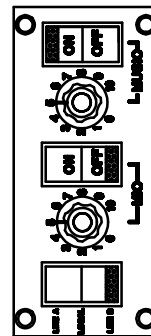
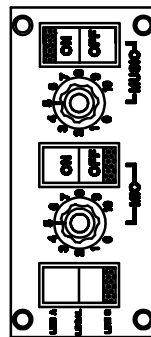
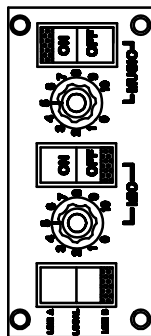

**ROOMS 1 AND 2 COMBINED / ROOMS 3 AND 4 SEPARATE**

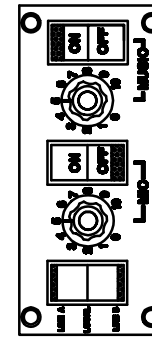
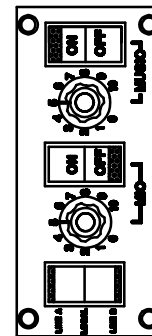
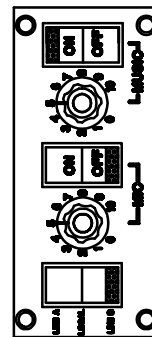
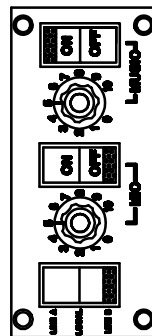

**ROOMS 1 AND 2 COMBINED / ROOMS 3 AND 4 COMBINED**

