



PATHFINDER

MATRIX SWITCHER SERIES

USER'S GUIDE

COVERS PATHFINDER 12X8 THROUGH 32X32 MODELS



This guide is based on software rev. 3.02

244 Bergen Boulevard, Woodland Park, NJ 07424 • Tel 973.785.4347 • Fax 973.785.3318 • Web www.fsrinc.com

Contact and Warranty Information

Copyright

© FSR Inc. May 6, 2010 12:50 PM

All rights reserved. No part of this document may be copied, reproduced or translated. It shall not otherwise be recorded, transmitted or stored in a retrieval system without the prior written consent of FSR.

Notice

FSR provides this manual “as is” without warranty of any kind, either expressed or implied, including but not limited to the implied warranties or merchantability and fitness for a particular purpose. FSR may make improvements and/or changes to the product(s) and/or the program(s) described in this publication at any time without notice.

This publication could contain technical inaccuracies or typographical errors. Changes are periodically made to the information in this publication; these changes are incorporated in new editions of this publication.

Federal Communications Commission (FCC) Statement

This equipment has been tested and found to comply with the limits for a class A digital device, pursuant to Part 15 of the FCC rules. These limits are designed to provide reasonable protection against harmful interference when the equipment is operated in a commercial environment. This equipment generates, uses, and can radiate radio frequency energy and, if not installed and used in accordance with the instruction manual, may cause harmful interference to radio communications. Operation of this equipment in a residential area may cause harmful interference, in which case the user will be responsible for correcting any interference.

Guarantee and Compensation

FSR provides a guarantee relating to perfect manufacturing as part of the legally stipulated terms of guarantee. On receipt, the purchaser must immediately inspect all delivered goods for damage incurred during transport, as well as for material and manufacturing faults FSR must be informed immediately in writing of any complaints.

The period of guarantee begins on the date of transfer of risks, in the case of special systems and software on the date of commissioning, at latest 30 days after the transfer of risks. In the event of justified notice of complaint, FSR can repair the fault or provide a replacement at its own discretion within an appropriate period. If this measure proves to be impossible or unsuccessful, the purchaser can demand a reduction in the purchase price or cancellation of the contract. All other claims, in particular those relating to compensation for direct or indirect damage, and also damage attributed to the operation of software as well as to other services provided by FSR, being a component of the system or independent service, will be deemed invalid provided the damage is not proven to be attributed to the absence of properties guaranteed in writing or due to the intent or gross negligence or part of FSR.

If the purchaser or a third party carries out modifications or repairs on goods delivered by FSR, or if the goods are handled incorrectly, in particular if the systems are commissioned operated incorrectly or if, after the transfer of risks, the goods are subject to influences not

agreed upon in the contract, all guarantee claims of the purchaser will be rendered invalid. Not included in the guarantee coverage are system failures which are attributed to programs or special electronic circuitry provided by the purchaser, e.g. interfaces. Normal wear as well as normal maintenance are not subject to the guarantee provided by FSR either.

The environmental conditions as well as the servicing and maintenance regulations specified in this manual must be complied with by the customer.

Warranty

All video products are designed and tested to the highest quality standards and are backed by a full 3-year parts and labor warranty. Warranties are effective upon delivery date to customer and are non-transferable. FSR warranties are only valid to the original purchaser/owner. Warranty related repairs include parts and labor, but do not include faults resulting from user negligence, special modifications, lightning strikes, abuse (drop/crush), and/or other unusual damages.

The customer shall pay shipping charges when unit is returned for repair. FSR will cover shipping charges for return shipments to customers.

Return Material Authorization (RMA)

In the unlikely event that a product is required to return for repair, please call the following number and ask for a Sales Engineer to receive a Return Merchandise Authorization number (RMA).

•(973) 785-4347

RMA Conditions are listed below:

- a. Prior to returning any item, you must receive a Return Merchandise Authorization (RMA) number.
- b. All RMA numbers must appear on their return-shipping label.
- c. RMA numbers are valid for ten (10) days from issue date.
- d. All shipping and insurance charges on all RMAs must be prepaid by the customer

Trademarks

Brand and product names mentioned in this manual may be trademarks, registered trademarks or copyrights of their respective holders. All brand and product names mentioned in this manual serve as comments or examples and are not to be understood as advertising for the products or their manufactures.

Company Address



FSR Inc.

244 Bergen Blvd.
Woodland Park, NJ 07424

USA

- Phone: (973) 785-4347
- Fax: (973) 785-4207
- Website: www.fsrinc.com

Operators Safety Summary

The general safety information in this summary is for operating personnel.

Do Not Remove Covers or Panels

There are no user-serviceable parts within the unit. Removal of the top cover will expose dangerous voltages. To avoid personal injury, do not remove the top cover. Do not operate the unit without the cover installed.

Power Source

This product is intended to operate from a power source that will not apply more than 230 volts rms between the supply conductors or between both supply conductor and ground. A protective ground connection by way of grounding conductor in the power cord is essential for safe operation.

Grounding the Product

This product is grounded through the grounding conductor of the power cord. To avoid electrical shock, plug the power cord into a properly wired receptacle before connecting to the product input or output terminals. A protective-ground connection by way of the grounding conductor in the power cord is essential for safe operation.

Use the Proper Power Cord

Use only the power cord and connector specified for your product. Use only a power cord that is in good condition. Refer cord and connector changes to qualified service personnel.

Use the Proper Fuse

To avoid fire hazard, use only the fuse having identical type, voltage rating, and current rating characteristics. Refer fuse replacement to qualified service personnel.

Do Not Operate in Explosive Atmospheres

To avoid explosion, do not operate this product in an explosive atmosphere.

Terms In This Manual and Equipment Marking

WARNING



Highlights an operating procedure, practice, condition, statement, etc., which, if not strictly observed, could result in injury to or death of personnel.

Note

Highlights an essential operating procedure, condition or statement.

CAUTION



The exclamation point within an equilateral triangle is intended to alert the user to the presence of important operating and maintenance (servicing) instructions in the literature accompanying the appliance.

AVERTISSEMENT!



Le point d'exclamation dans un triangle équilatéral signale à alerter l'utilisateur qu'il y a des instructions d'opération et d'entretien très importantes dans la littérature qui accompagne l'appareil.

VORSICHT



Ein Ausrufungszeichen innerhalb eines gleichwinkligen Dreiecks dient dazu, den Benutzer auf wichtige Bedienungs- und Wartungsanweisungen in der dem Great beiliegenden Literatur aufmerksam zu machen.

Change History

Rev	Date	Description	Approved By
	4/1/10	Initial Release	
	4/22/10	Updated feature descriptions and menus	
	5/27/11	Updated feature descriptions and menus	

TABLE OF CONTENTS

CONTACT AND WARRANTY INFORMATION.....	3
OPERATORS SAFETY SUMMARY	5
CHANGE HISTORY	7
INTRODUCTION.....	11
BANDWIDTH AND FREQUENCY RESPONSE	11
RGB DELAY SWITCHING	11
PRESETS AND I/O GROUPS.....	11
SPLIT MODE.....	11
STEREO AUDIO	11
SERIAL AND IP CONTROL.....	12
FEATURES	12
APPLICATIONS.....	12
APPLICATION EXAMPLES.....	13
NATIVE MODE APPLICATION	13
SPLIT MODE APPLICATION	13
INSTALLATION	14
ENVIRONMENT.....	14
AUDIO INPUT WIRING.....	15
AUDIO OUTPUT WIRING.....	15
RJ-45 LAN INTERFACE CABLING.....	16
RS-232 REMOTE HOST PORT CABLING (DB9).....	16
LCD DISPLAY MENU TREE.....	17
UNDERSTANDING THE LCD DISPLAY.....	18
LED INDICATOR LAMP BEHAVIOR.....	18
FRONT AND REAR PANEL VIEWS.....	19
INSTALLING THE LEGEND LABEL ASSEMBLY	22
SETUP MODE	23
MAIN SETUP MENU PAGE.....	23
INPUT SETUP MENU PAGE.....	23

OUTPUT SETUP MENU PAGE.....	26
SYSTEM SETUP MENU PAGE	28
PRESET SETUP MENU PAGE.....	32
OPERATING MODE	36
MAIN OPERATING PAGE:	36
VOLUME HANDLING PAGE.....	38
EXECUTING PRESETS.....	39
FACTORY RESET	40
PATHFINDER WITH EAGLE CONTROLLER SETUP	41
UPDATING SOFTWARE	53
SOFTWARE UPDATE OVERVIEW	53
HARDWARE REQUIREMENTS.....	53
DOWNLOADING SOFTWARE	53
UPDATING PATHFINDER MATRIX SOFTWARE.....	54
SPECIFICATIONS.....	63

INTRODUCTION

The Pathfinder Matrix family is a ground-up development aimed at bringing new capabilities and a new level of performance to matrix switching.

In order for a display to accurately reproduce the original image, every component in the video system must have enough bandwidth to carry the signal and be as flat as possible in order to maintain the clarity and color fidelity. The Pathfinder Matrix Switchers set a new standard in both areas.

Bandwidth and Frequency Response

At the heart of the Pathfinder Matrix Series is a design that delivers high bandwidth and flat frequency response to insure that the original image is switched and distributed without being altered. Proper signal reproduction is much more than bandwidth. Frequency response plays a vital role in the clarity and accuracy of an image.

The HD Component and RGB units feature greater than 600 MHz of bandwidth to -3dB. Better, from 0 to 300MHz the signal is +/-1.0 dB making the Pathfinder Matrix the highest bandwidth and flattest matrix switchers on the market.

RGB Delay Switching

All models have a user definable RGB delay switch mode. When enabled and a new route selected, the H and V sync switch on command and black is sent down the RGB lines. This allows downstream equipment to lock into the new signal before anything is visible on the screen. After the preset interval, the RGB signal is then restored making the switch appear as clean as possible.

Presets and I/O Groups

The Pathfinder Matrix' family offers up to 32 presets, one for each input and output button. Presets make a very easy way to reconfigure all of the routes in a system with the touch of a button. I/O groups are handy if there are some inputs or outputs that must be isolated from one another. An example would be that certain inputs from the executive boardroom may never wish to be switched to the video conferencing system.

Split Mode

The newest feature to be added to the Pathfinder Matrix is Split Mode Switching. This allows each color channel to be switched independently. Take an 12x8 RGBHV matrix as an example. Inputs 1-4 could be assigned to be RGB while the Red channel on inputs 5-8 can be composite while the Green and Blue channels on inputs 9-12 are S-Video. This allows 1 physical matrix switcher to perform the duties of several units saving money by ensuring that the switching capabilities are present as video types and resolutions are upgraded in the future.

Stereo Audio

The stereo audio option provides balanced and unbalanced stereo audio switching with independent input trim control and output volume control. Independent input gain switches allow unity or +14 dB

gain settings for each input to maintain optimal S/N ratio.

Serial and IP Control

The Pathfinder Matrix command set is an easy to follow easy to implement ASCII command set that gives control systems complete access to all functions. Each unit is equipped with an RS-232 serial port along with an IP port for today's remote communications systems.

NOTE: The default IP Address is: 192.168.0.243

FEATURES

Very High and Very Flat Bandwidth

600MHz of Bandwidth to -3dB

+/-1.0 dB to 300MHz

Sizes to Fit the Install

12x8, 16x16 and 32x32 sizes available

Composite, S-Video, Component and RGBHV configurable

HD Compatible

720p, 1080i, 1080p and 2k by 1k Digital Cinema

Split Mode Switching

Optional Balanced Stereo Audio (Audio models only)

+/-10 dB Input Trim

Pro / Consumer Pad

-45 to +5 Output Volume Control

32 Presets

RS-232 and IP Remote Control

APPLICATIONS

- ◆ Boardrooms
- ◆ Schools
- ◆ House of Worship
- ◆ Rental and Staging
- ◆ Convention Centers
- ◆ Divisible Ballrooms
- ◆ Security and Surveillance System Integration
- ◆ Monitoring Centers
- ◆ Courtrooms

APPLICATION EXAMPLES

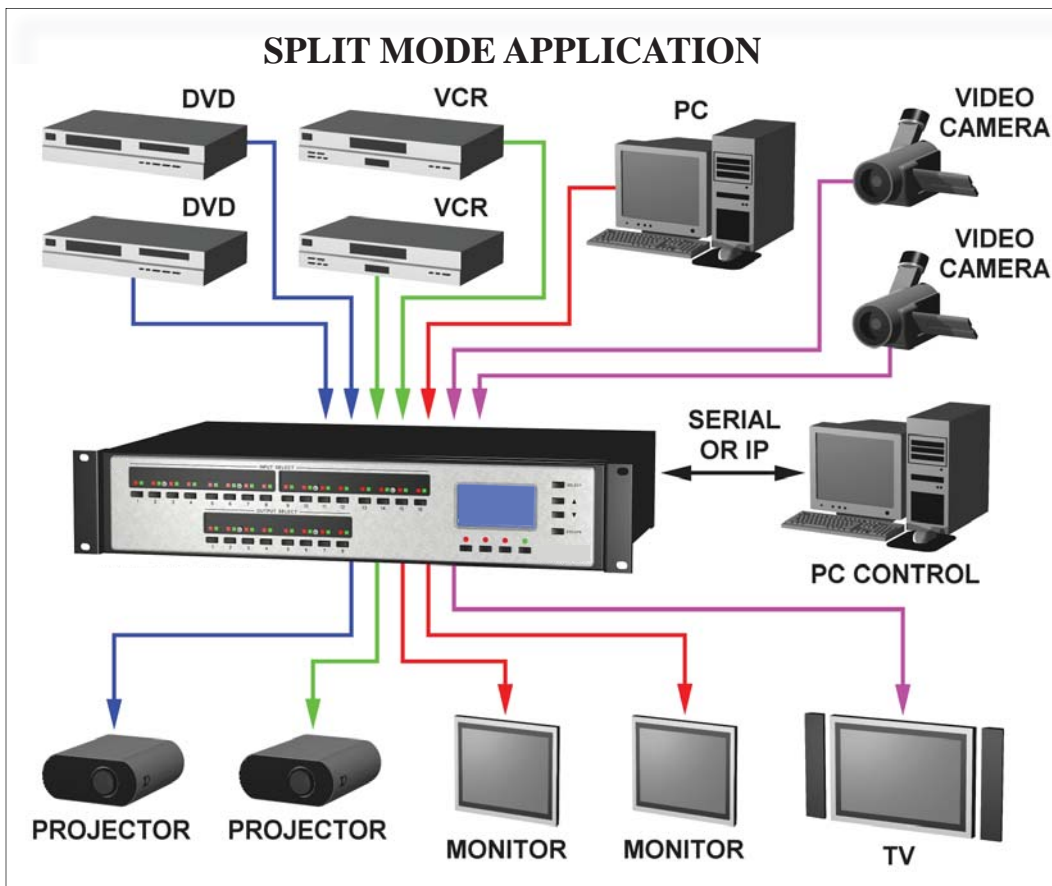
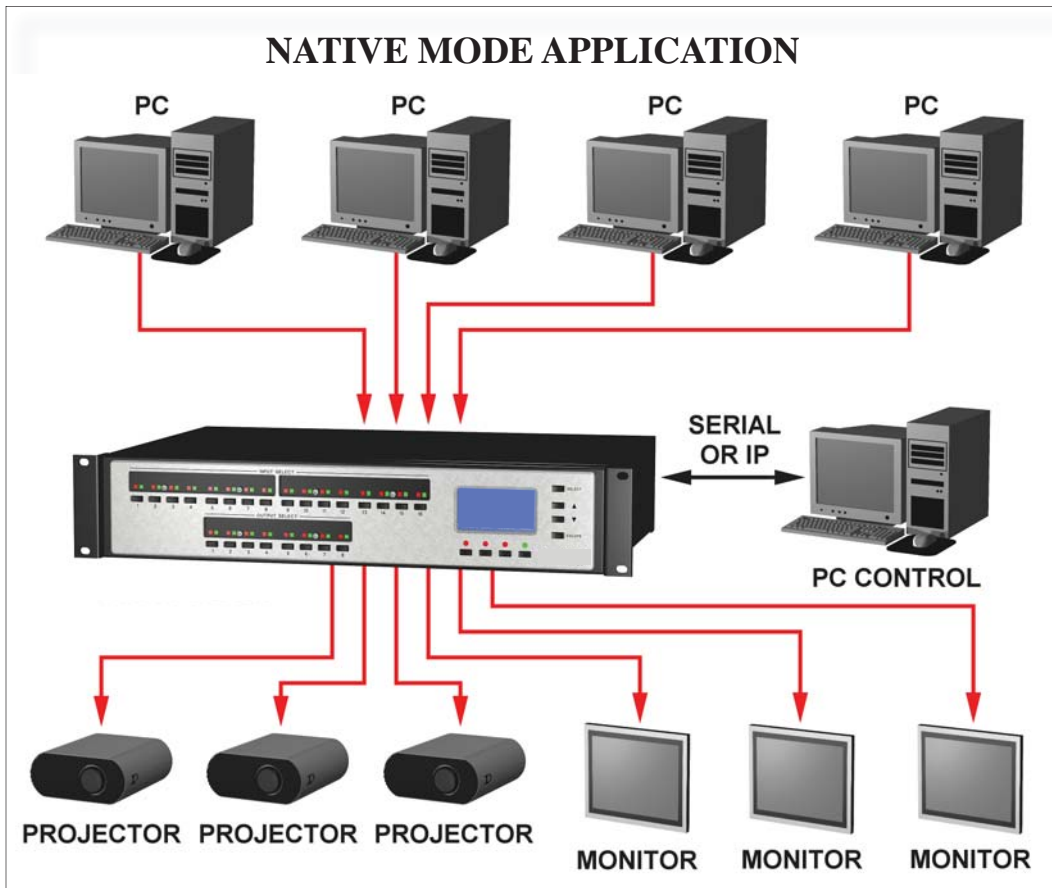

INSTALLATION

ENVIRONMENT

The Matrix rack unit should be mounted in a rack where an AC power outlet is nearby. It is a direct AC plug in unit via the supplied EIA power cord. The front and back of the unit should be positioned so that both the installer and operator can conveniently access the front and back for wiring and adjustments.

Check each the manufacturer's recommendations on cable requirements and termination. Use standard approved wiring practices.

The integrity of all audio and video sources should be pretested BEFORE they are connected to the Matrix rack. This holds true for the display devices as well. Simply direct connect the various sources and displays to pretest the cable runs and equipment. The tested equipment can then be connected to the Matrix rack unit. All terminations should have "ID" cable markers to aid in cabling and troubleshooting.

In installing the Matrix rack unit in a suitable manner, the following is required:

1. TMRA – The maximum recommended ambient temperature (TMRA) for the Matrix is 40°C.
2. Ambient Temperature Inside the Rack – The ambient temperature inside the rack should not exceed 40°C.
3. Air Flow – Installation of the Matrix inside the rack should not impede air flow.
4. Mechanical Loading – Mounting of the Matrix inside the rack shall not result in a hazardous condition due to uneven loading.
5. Circuit Overloading – Refer to equipment nameplate ratings when addressing branch circuit and/or overcurrent protection requirements.
6. Reliable Earthing – Reliable earthing of the Matrix shall be maintained after rack mounting.
Note – Earthing via the rack could be required if supply connection is not made directly to branch circuit (e.g. use of power strips).

WIRING DETAIL FOR PATHFINDER MODELS WITH AUDIO OPTION

PATHFINDER AUDIO INPUT CONNECTOR WIRING

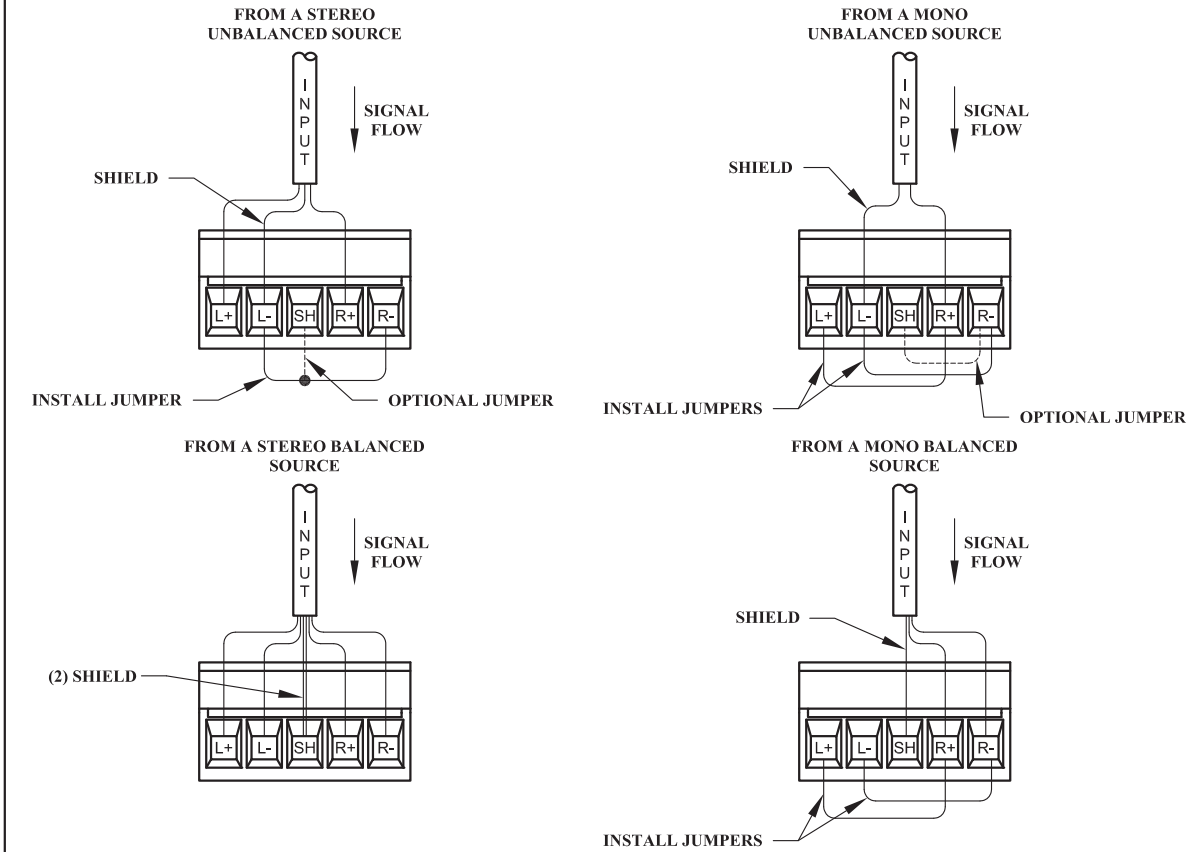

PATHFINDER AUDIO OUTPUT CONNECTOR WIRING

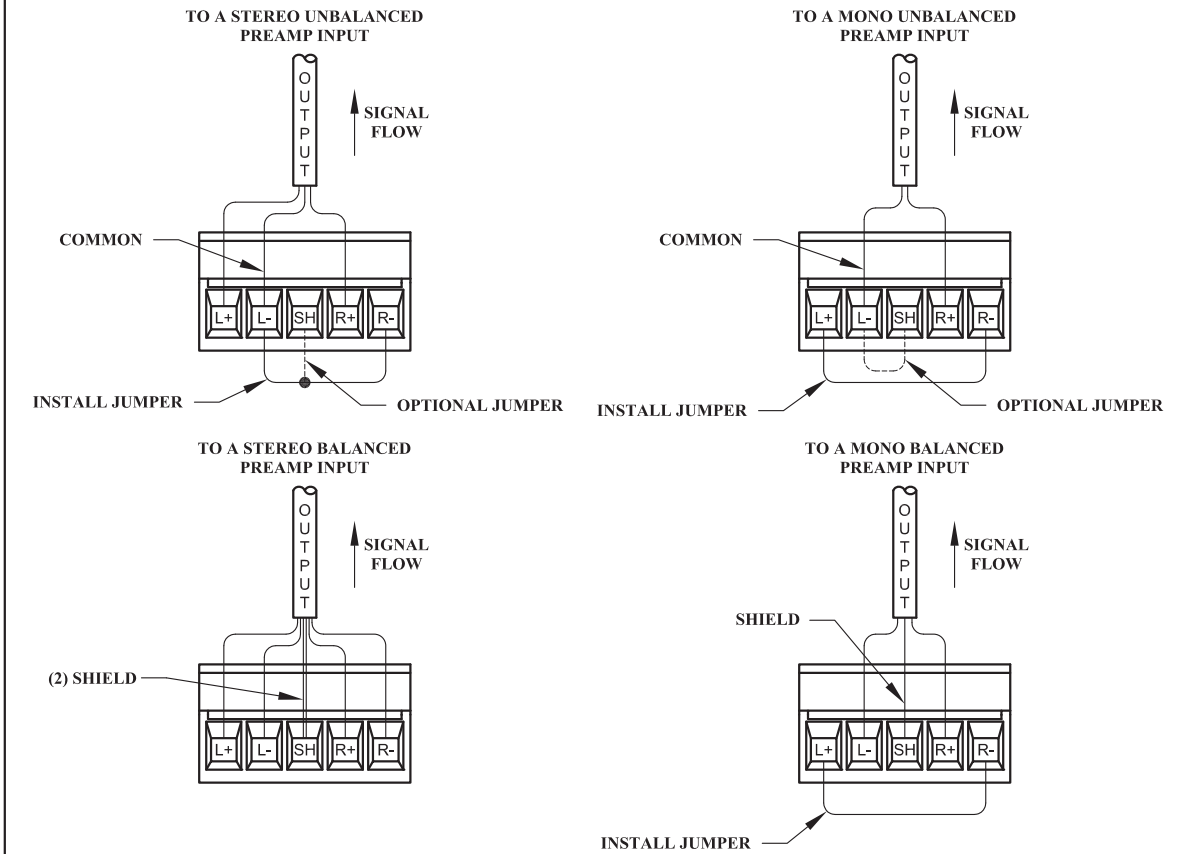

RJ-45 LAN Interface Cabling

This port is used to access the Pathfinder Matrix via TCP-IP from a host computer or network.

Cable type:

RJ-45 Crossover for direct computer to Pathfinder Matrix control

RJ-45 Straight through for Network to Pathfinder Matrix control

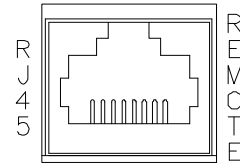

Recommended Maximum Length: 329 feet

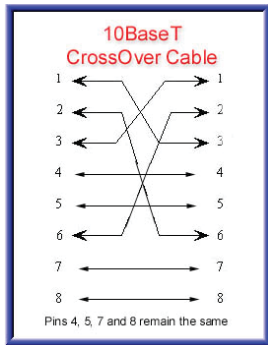

Crossover Cable

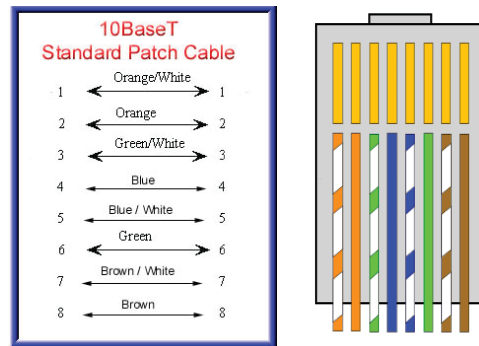

Standard Patch Cable

NOTE: The default IP Address is: 192.168.0.243

RS-232 Remote Host Port Cabling (DB9)

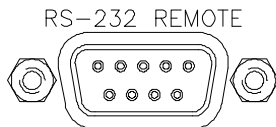

The Pathfinder Matrix has a standard RS-232 (DB9F) communication port that connects the host PC to the Rack Unit allowing control and configuration.

Cable Type: Straight through DB-9 Male (To mate with Female on Rack Unit) to DB-9 Male (to mate with DB-9 Male on typical PC COMM port).

Recommended Maximum Length: 50 ft

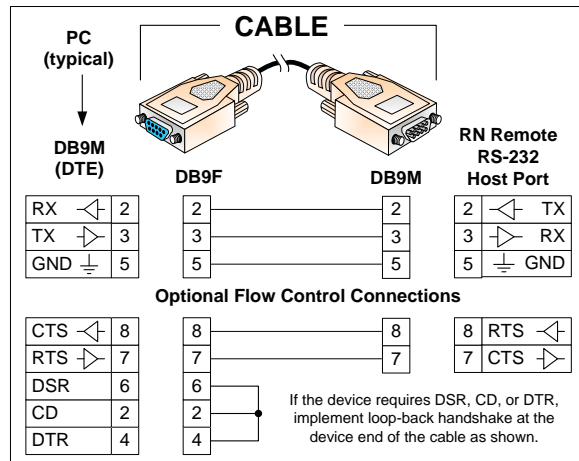

LCD DISPLAY MENU TREE

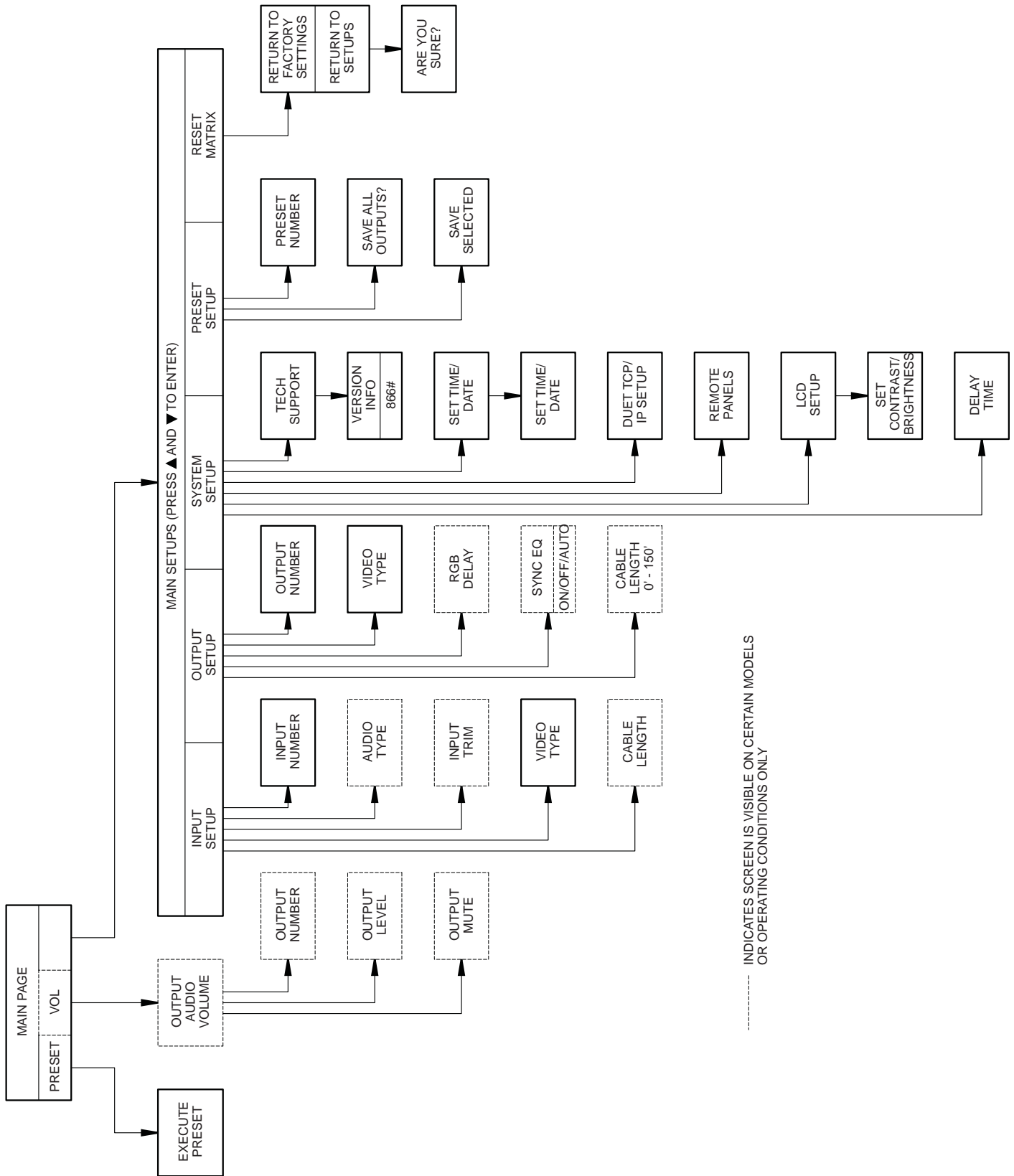

UNDERSTANDING THE LCD DISPLAY

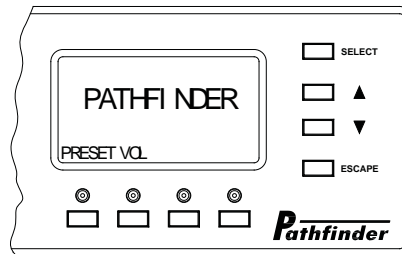

LCD SCREEN: The visual interface for the Pathfinder Matrix rack

SELECT PUSH BUTTON: used to select a menu item or an AV route

UP AND DOWN ARROW PUSH BUTTONS: increases or decreases a menu value such as volume level or a numeric value. Also used to scroll through menu items.

ESCAPE PUSH BUTTON: allows the user to cancel a command and back out to the previous menu page

ON SCREEN MENU ITEM SELECT PUSHBUTTONS(4): used to select page menu items that are located above the individual push buttons on the LCD screen. Functions will vary and are dependant on page status In the example below, the two left push buttons are for preset and volume settings respectively

ON LCD SCREEN CURSORS:

- A ">" is used to point to a menu item.
- A "*" indicates that the menu item has been selected.

LED INDICATOR LAMP BEHAVIOR

The color and state of the indicator LED's provide the following status information. This holds true for ALL LED's on the rack:

- RED LED: indicates Video
-
- GREEN LED: indicates Audio
-
- STEADY LED: a routed input or output
-
- FLASHING LED: indicates an available input or output

FRONT AND REAR PANEL VIEWS

(Not all models are shown. Visit the FSR website document library for detailed drawings on all models)

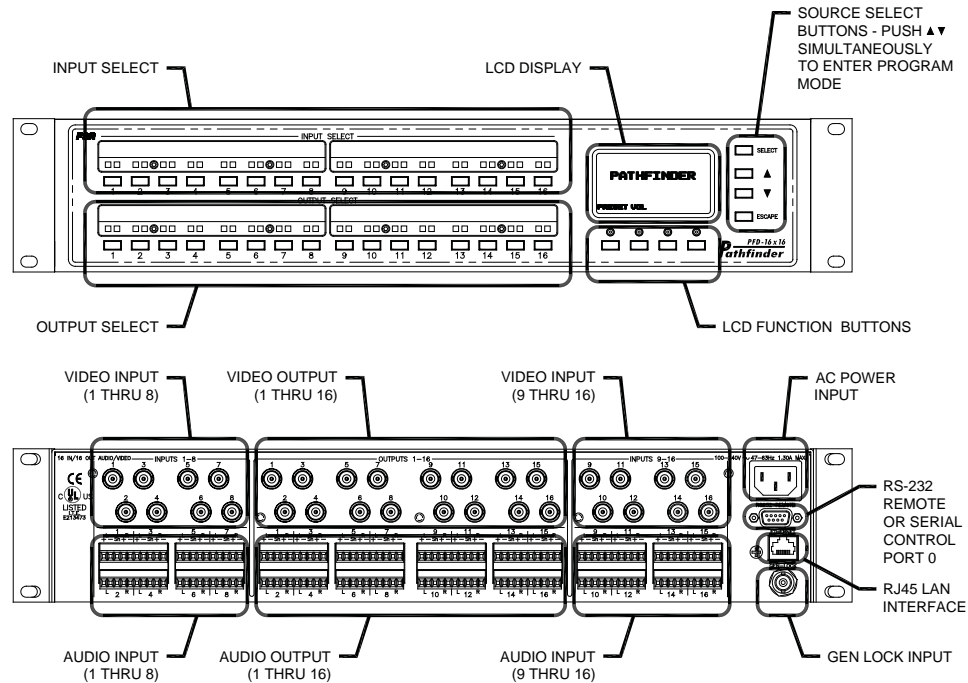

PFD-16x16-CA SHOWN

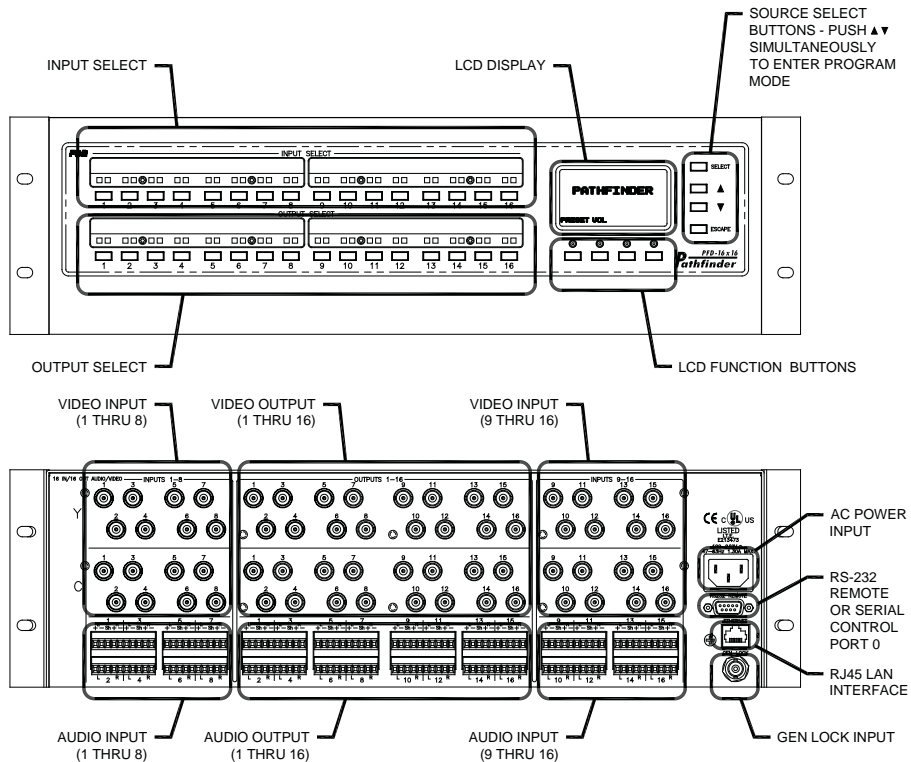

PFD-16x16-SA SHOWN

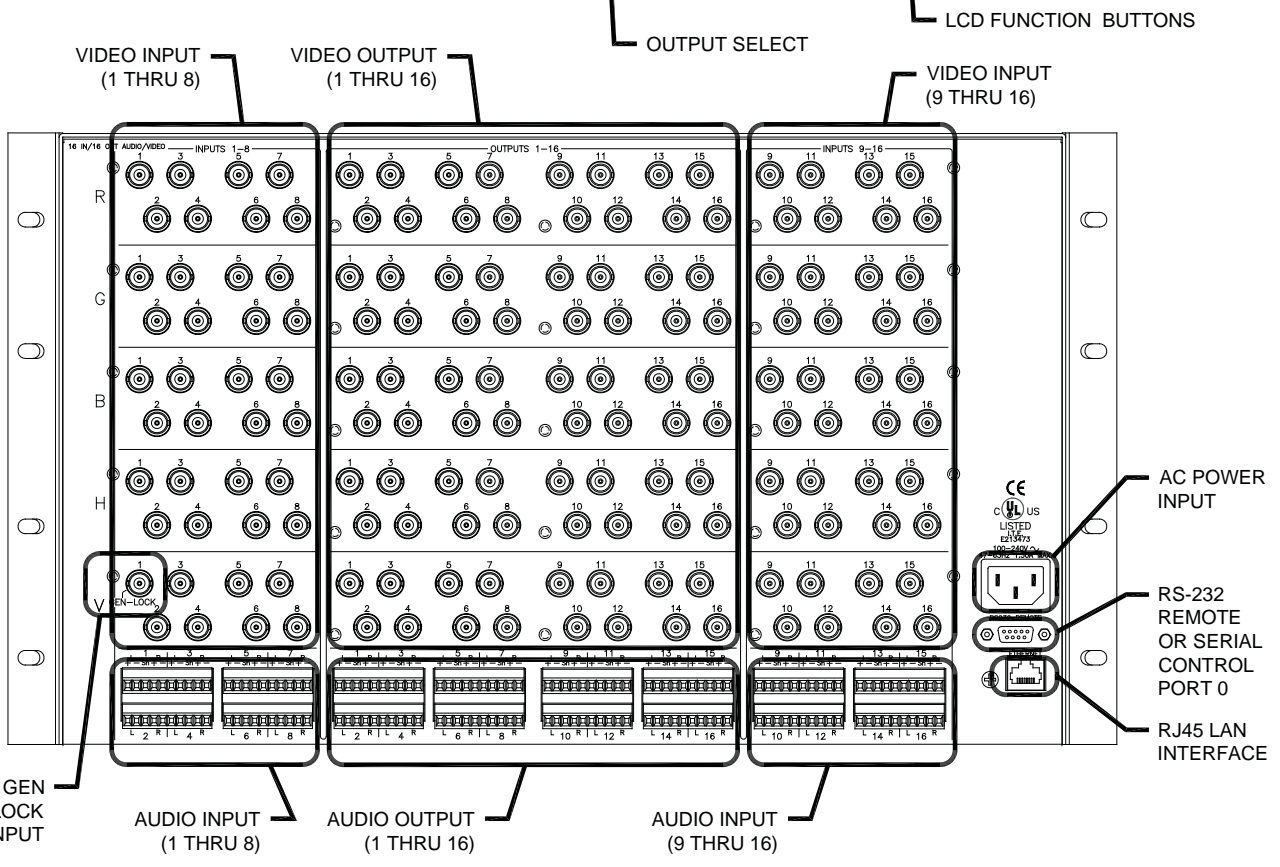
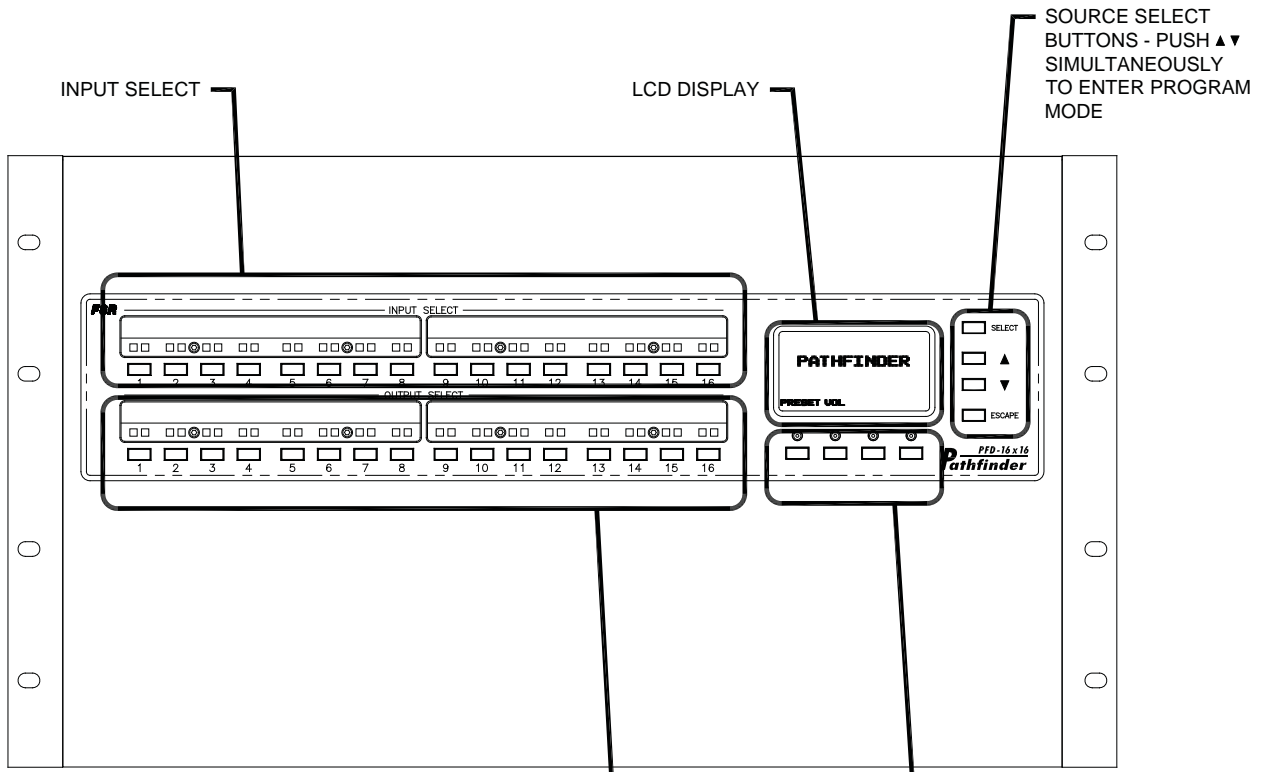

PFD-16x16-RGBAEQ SHOWN

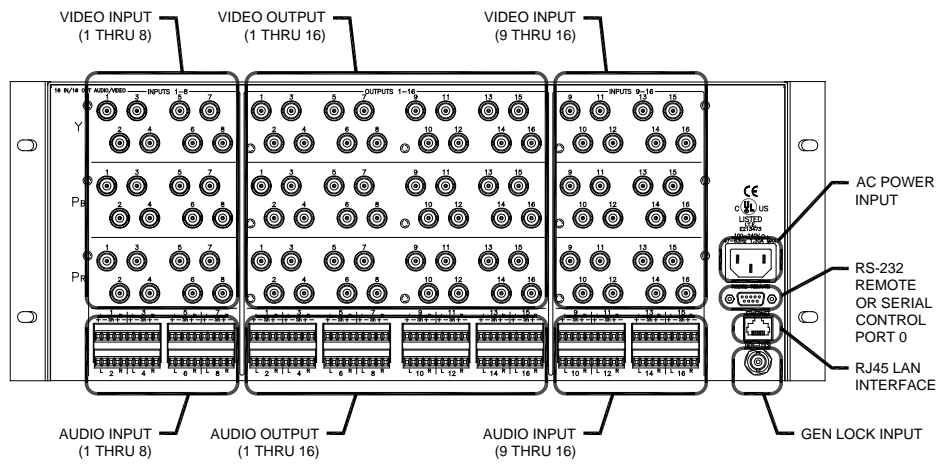
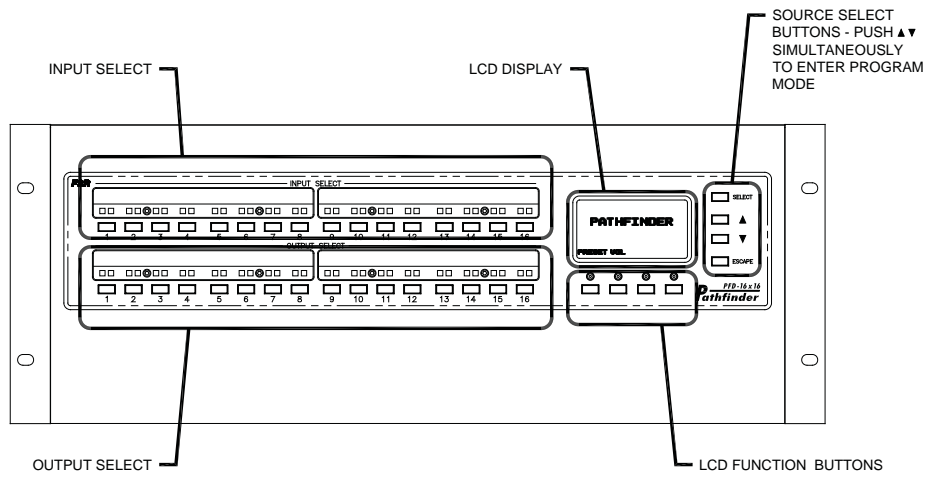

PFD-16x16-HDAEQ SHOWN

INSTALLING THE LEGEND LABEL ASSEMBLY

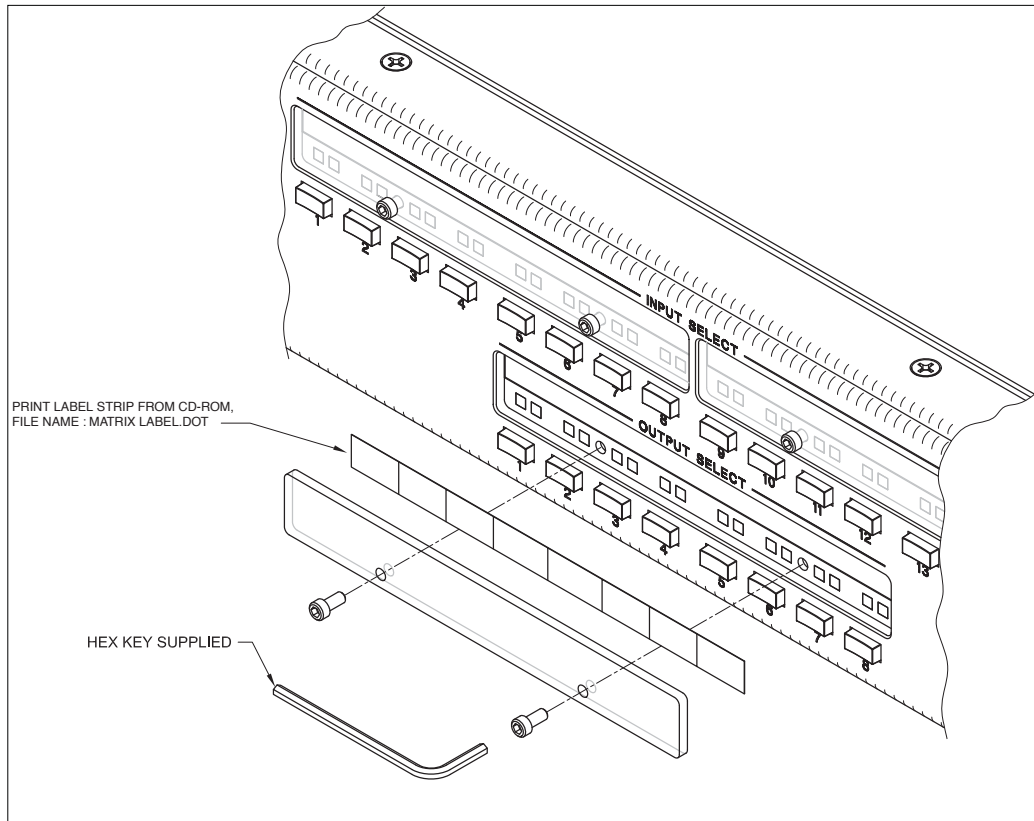

SETUP MODE

MAIN SETUP MENU PAGE

The Pathfinder Matrix is initially setup from the front panel LCD screen on the rack. To enter the setup pages, press the UP and DOWN buttons simultaneously. The front panel will display the main setup menu page:

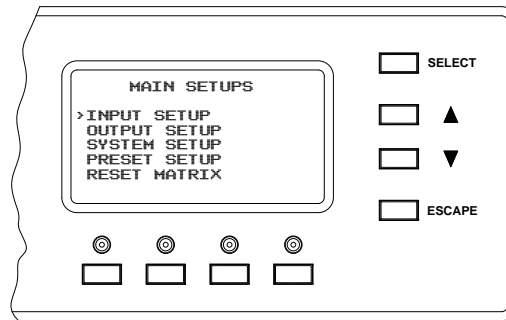

A ">" cursor is used to point to a menu option. The ">" cursor is moved up and down using the UP and DOWN arrow buttons to the right of the LCD screen. Pressing the SELECT button causes the front panel to enter the menu or sub-menu page that is next to the cursor. The ">" will change to a "*" to indicate that the selected menu option is selected and ready to be adjusted. The up and down arrow buttons are then used to make the actual setting adjustment. When satisfied with the setting, pressing the select button will save the selection. Pressing ESCAPE a second time will return to the main operating page.

NOTE: The LCD display will automatically return to the main operating page after 45 seconds of inactivity.

INPUT SETUP MENU PAGE

Pressing the up and down buttons to position the ">" cursor next to INPUT SETUP then pressing the SELECT button will display the input setup menu pages. The INPUT SETUP page will default to Input 01.

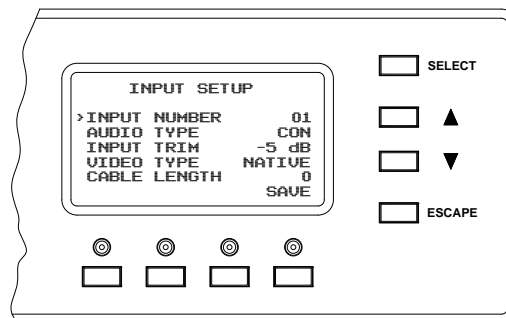

INPUT NUMBER

This function is used to select which input to setup. At the “>” prompt either press an input button to select that input or change the input number by positioning the cursor to INPUT NUMBER Press the SELECT button. The UP and DOWN buttons can then be used to scroll through the input adjustment options and press select to choose one of the following options.

AUDIO TYPE

The user can, after selecting an input, adjust the parameters for that input. The user may scroll down to AUDIO TYPE and select between PRO for profession, and CON for consumer types of audio input. AUDIO TYPE is only available on units with the audio option.-

INPUT TRIM

The user may choose to adjust the audio INPUT TRIM. It may be desirable that the input’s audio be connected to an output audio, so the user can hear the adjustment. The range of the input trim will be -10dB to +10dB in one dB increments. The user scrolls down to INPUT TRIM and presses SELECT. The user uses the UP and DOWN buttons to change the input’s trim value. The front panel will send an Input Trim value message to the rack each time the value is changed so the user can hear the difference. INPUT TRIM is only available on units with the audio option.

VIDEO TYPE

A unique feature of the Pathfinder Matrix series is the ability to configure inputs (and outputs) for not only the default source type, but also be able to split the port in order to input other source types. When an input is set to split mode, an RGB matrix port can be configured as:

- One RGB port, (Default)
- One Component video
- One S-Video and one composite
- Three Composites.

The ports will default to RGB.and NATIVE for the VIDEO TYPE.

If the user wishes to split an input in order to use another video type(s), the user positions the cursor to VIDEO TYPE and presses SELECT. The user can toggle between NATIVE and SPLIT by using the up and down buttons.

If the input is split and the user selects NATIVE, the front panel will simply return to the default video setting of RGB.

If the user chooses SPLIT , and presses the SELECT button, the screen will change to allow the user to scroll through and select one of five pre-defined split configurations.

The screen will look like this:

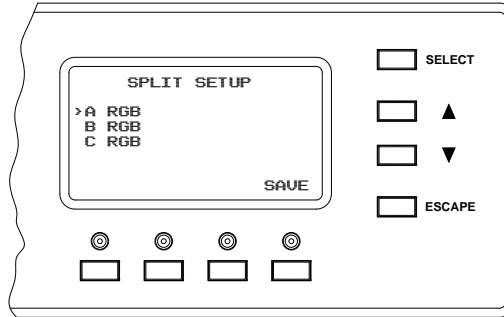

The "A-B-C" (labeled R-G-B on the unit) designations refer to the physical location of the video cards from top to bottom in the Pathfinder Matrix chassis. Pressing the UP and DOWN buttons will scroll through the five available configurations. In this example the input is set to one S-video and one Composite video.

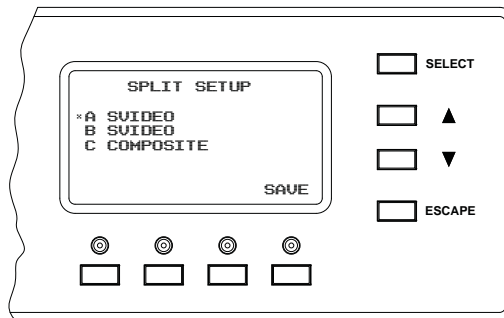

Pressing SAVE will store the selected configuration for that input. The user can then select another input to set up, or press the ESCAPE button to return to the INPUT SETUP menu.

CABLE LENGTH (Input)

CABLE LENGTH gives the user the ability compensate for the length of cable from the source to the Pathfinder Matrix. The user will scroll down to CABLE LENGTH press SELECT. The user will then use the UP and DOWN buttons to adjust the cable length from 00' to 150' in 10 foot lengths. When finished the user will press SELECT to save the setting.

NOTE: A final phase adjustment of the display should be performed after cable EQ adjustments are completed to optimize the image quality

OUTPUT SETUP MENU PAGE

There are three differences between the input and output setup screens. One is that on the input screen the user will be able to adjust the audio input trim. The second difference between an RGB input and RGB output is the ability to enable or disable the RGB delay on the RGB output. The third difference is the ability to enable and set sync equalization. Below is a screen for output 1. The method of setting the output type works exactly the same as the input type setup except that the message changes from input to output. The user can either choose an output directly using one of the output buttons or use the UP, DOWN, and SELECT buttons to choose the output.

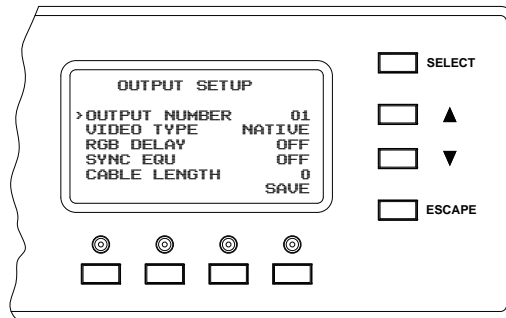

RGB DELAY

RGB DELAY is used so that the display can sync up to the new sources' sync signals before switching in the new source video. RGB DELAY is only for the RGB matrix and can be set as ON or OFF (will not appear on the display when in split mode or on non-RGB models).

SYNC EQU

SYNC EQU is a feature designed to restore sync rise and fall time to compensate for losses in sync levels over long cable runs. There are three settings: OFF, ON, or AUTO. When set to AUTO, sync equalization will automatically turn on when CABLE LENGTH setting is set to 50' or more (will not appear on the display when in split mode or on non-RGB models)

CABLE LENGTH (Output)

CABLE LENGTH gives the user the ability to compensate for the length of cable from the Pathfinder Matrix to the display. The settings are from 0 to 150 feet in increments of 10 feet. Zero feet is off. The user presses the up and down buttons to select the length and presses the SELECT button.

NOTE: A final phase adjustment of the display should be performed after cable EQ adjustments are completed to optimize the image quality

VIDEO TYPE

A unique feature of the Pathfinder Matrix series is the ability to configure outputs (and inputs) for not only the default video type, but also be able to split the port in order to output video types. When an output is set to split mode, an RGB matrix port can be configured as:

- One RGB port, (Default)
- One Component video
- One S-Video and one composite
- Three Composites.

The ports will default to RGB and NATIVE for the VIDEO TYPE.

If the user wishes to split an output in order to use another video type(s), the user positions the cursor to VIDEO TYPE and presses SELECT. The user can toggle between NATIVE and SPLIT by using the up and down buttons.

If the output is split and the user selects NATIVE, the front panel will simply return to the default video setting of RGB.

If the user chooses SPLIT, and presses the SELECT button, the screen will change to allow the user to scroll through and select one of five pre-defined split configurations. The screen will look like this:

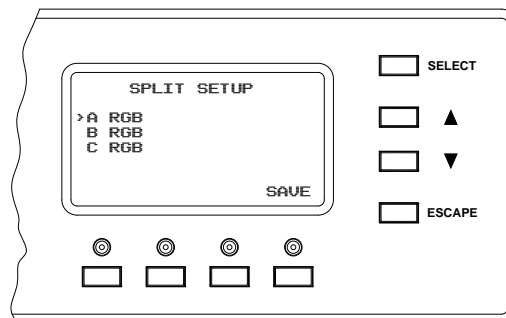

The "A-B-C" (labeled R-G-B on the unit) designations refer to the physical location of the video cards from top to bottom in the Pathfinder Matrix chassis. Pressing the UP and DOWN buttons will scroll through the five available configurations. In this example the output is set to one S-video and one Composite video.

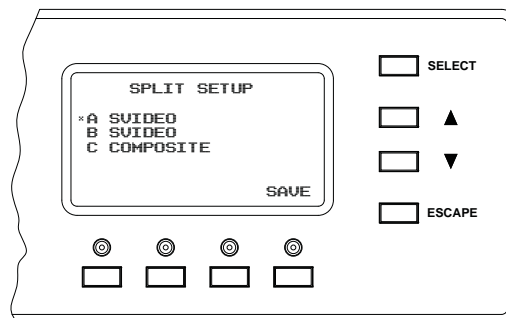

Pressing SAVE will store the selected configuration for that output. The user can then select another output to set up, or press the ESCAPE button to return to the OUTPUT SETUP menu.

SYSTEM SETUP MENU PAGE

SYSTEM SETUP MENU PAGE allows the user to view and set system parameters from the front panel. The system setup main menu page looks like this:

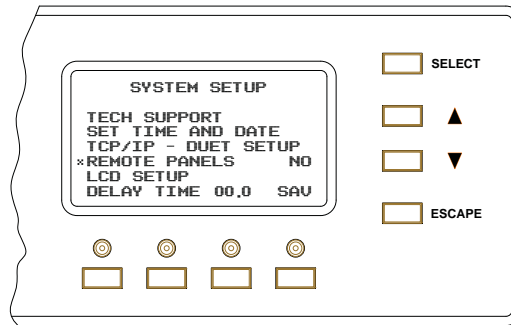

TECH SUPPORT

TECH SUPPORT brings up a screen that looks like this.

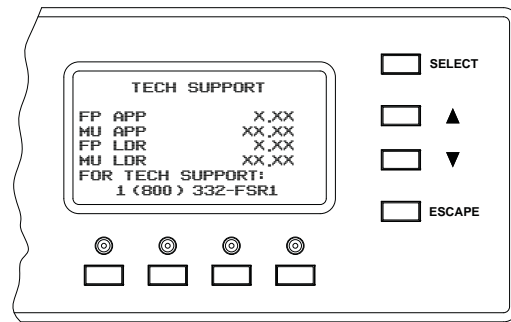

The screen reports the front panel's application version and the matrix application version. The FL and ML numbers are the front panel and main unit loader versions. It will have the FSR 800 number as the tech support number. Pressing the ESCAPE or BACK button will return to the system setup menu.

SET TIME DATE

SET TIME DATE sets the real time clock to the current time and date. The time and date will be used in the future to schedule events, such as presets that are recurring.

The user selects SET TIME AND DATE. During the setting of date and time, the SELECT button is used to navigate through the different fields. To move to the next field the user presses the SELECT button. To save the date and time the user will need to press SAVE; which may be pressed at any time, after saving the new time and date the SAVE button will return to the system setup menu. The ESCAPE button is used to return to the SYSTEM SETUP main page.

The set time and date screen looks like this:

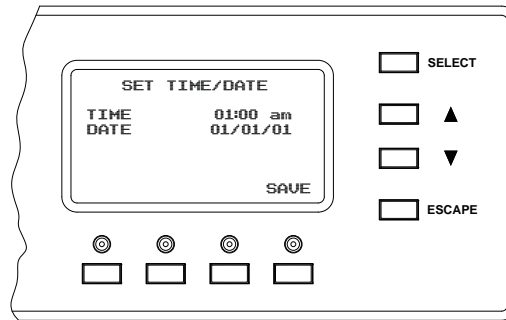

The user presses the SELECT button, the display changes to the following screen:

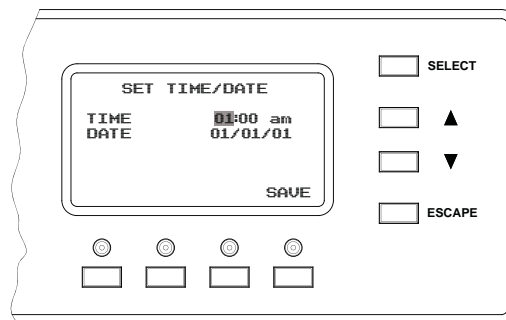

This signifies that the user can now change the hour value; the user would use the UP and DOWN buttons to change the hour setting. When the user is finished setting the hour the user will press the SELECT button, which would change the display as follows:

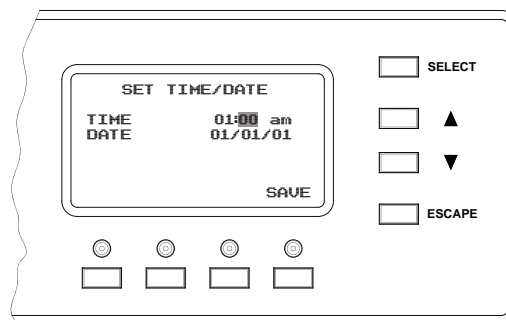

The user can set the current minutes month day and year in the same fashion as above by pressing the SELECT button to scroll to the next desired field and select a value using the UP and DOWN buttons. The user may press ESCAPE at any point to return to the SYSTEM SETUP menu (settings will not be saved).

When finished setting time and date, press the SAVE button. Pressing the SAVE button will save the new settings. A "Saving time and date " message will appear briefly on the LCD screen. The front panel will then return to the system setup menu.

DUET TCP/IP SETUP

TCPIP/IP-DUET SETUP brings up a screen that looks like this.

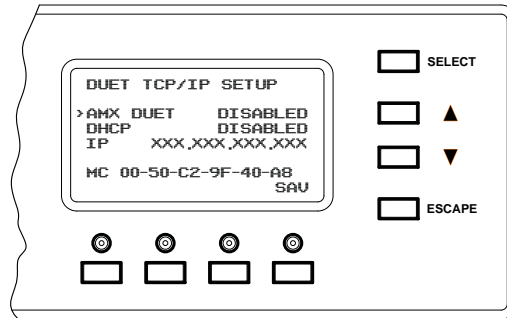

AMX DUET

The user can enable the use of AMX Duet by selecting AMX DUET, using the up down buttons to scroll and selecting ENABLE. When enabled, the Pathfinder Matrix will send a UDP beacon that can be discovered by an AMX DUET system.

DHCP and IP

When DHCP is enabled, the Pathfinder Matrix will request an IP address from the DHCP server on the local network it is connect to. When DHCP is DISABLED, a static IP address can be set. Scroll to IP and press SELECT. Use the UP and DOWN buttons to change the numeric value of the first three digit group and press SELECT. The three indicator arrows will move to the next three digit group to be set. Continue this procedure to set the desired static IP address.

Pressing SAV will save the settings above.

The SAV will result in a reset of the Ethernet Connection Module (ECM) and takes approximately 30 seconds before the changes take effect.

REMOTE PANELS SETUP under SYSTEM SETUP is used when a Pathfinder Matrix Remote Panel is connected to the Pathfinder Matrix. Once selected, the user can choose "YES or "NO" to activate or deactivate a Pathfinder Matrix Remote Panel.

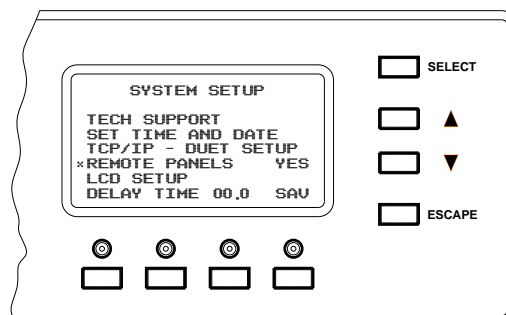

LCD APPEARANCE SETUP

FRONT PANEL SETUP brings up the following screen:

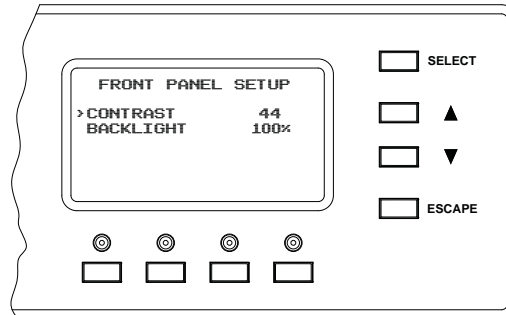

This screen allows adjustment of the CONTRAST and BACKLIGHT on the LCD display, . CONTRAST deals with the difference in shade between the characters and the background, the higher the number the bigger the difference.

DELAY TIME

DELAY TIME sets the RGB time delay for all RGB outputs. This is a global setting. RGB delay is independently enabled or disabled via the output setup for any given RGB output.

The time range is .1 to 10.0 seconds with 00.0 indicating off. Each RGB output's setup has the ability to turn on or off RGB delay. The user will position the cursor using UP or DOWN buttons to DELAY TIME and presses SELECT. The user then uses the UP and DOWN buttons to set the delay time to the correct seconds, and tenths of seconds. Pressing the SELECT button then sets and stores the delay time setting.

PRESET SETUP MENU PAGE

All Pathfinder Matrix models are capable of storing up to 32 presets. A stored preset is a saved "snapshot" of a particular input output scenario that can be recalled at a later time. When the user is in either preset select or preset setup mode, the input and output select buttons become preset number select buttons. Preset numbers are selected from the front panel either by pressing an input or output select button, or using the UP and DOWN buttons and SELECT to choose a preset number not represented by an input or output button.

NOTE: If the matrix is a 12 X 8 matrix, only presets 1 to 20 can be accessed using an input or output button. Presets 21 to 32 will need to be accessed using the UP, DOWN and SELECT buttons. Preset numbers accessed by the input and output buttons are determined by the button they are associated with. For example; on a 12 X 8 matrix, output button 3 would represent preset 15, output button 8 would be preset 20.

Presets are set up and stored by entering the PRESET SETUP menu. A preset can be stored in two ways; saving the current output matrix settings to a preset, or defining a preset based on selected outputs.

To define a preset:

Define a new route or select a pre defined route by pressing an output button.

Enter the preset setup menu. The main screen for the preset setup will look like this:

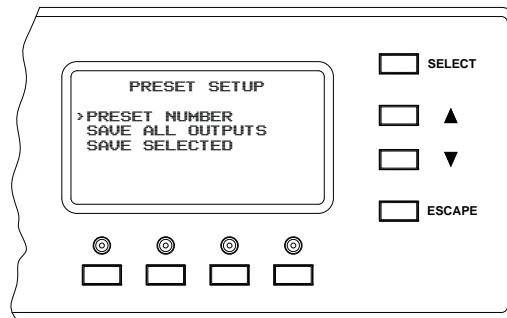

Select "Preset Number" and press select

Using the UP and DOWN arrow buttons and SELECT to choose a preset number.

To save the current route as a preset:

Scroll down to SAVE ALL OUTPUTS and press SELECT. This will save the last route and associated settings.

Press ESCAPE to return to the PRESET SETUP menu.

To add or remove only certain selected outputs to the preset:

To include only certain outputs into the preset, the user will select SAVE SELECTED, then choose the outputs (using the output buttons and saving each time) that are to be included in the preset as described below.

Choose the desired output number(s) by pressing the desired output button and then the SELECT button upon each entry. Depending on whether the selected output is preconfigured for split or native video the following screens will appear:

If the selected output is **not split**, the user will have the option of selecting VIDEO routing, AUDIO routing or both by pressing the VIDEO and AUDIO buttons.. The following screen will be displayed to allow the user to confirm that the settings are correct and to select video and/or audio.

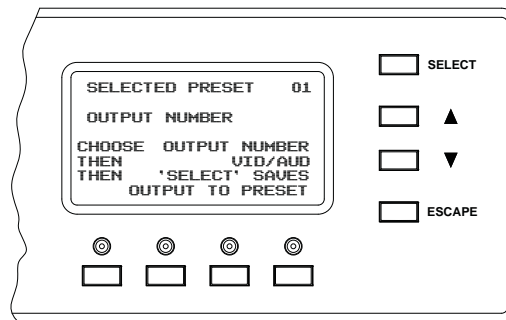

You will be prompted with:

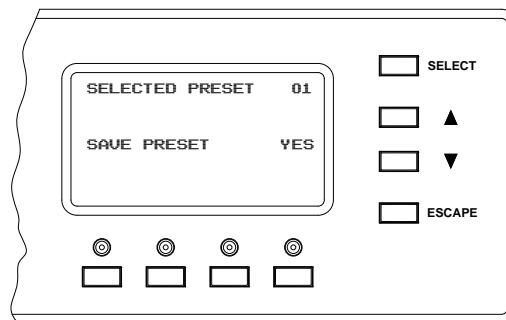

Press the SELECT button to save the preset
Press ESCAPE to return to the main PRESET SETUP screen

If the selected output is **split**, the user will have to decide which of the output's cards the user wishes to include in the preset. The following screen will be displayed:

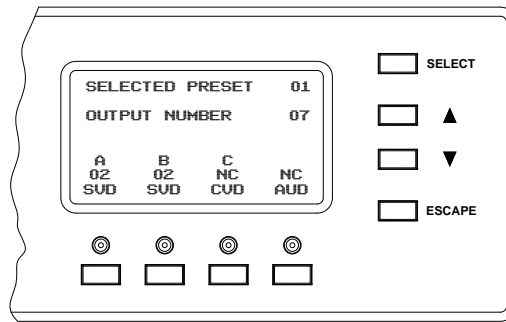

In this example above, output 7 is setup as a S-Video input on “A” and “B” and a Composite video on “C”. The front panel also shows which input is currently connected to each card. The user will then select which video cards the user wishes to include in preset 1. The user can also select output 7’s audio to be included in the preset. Pressing the SELECT button will save the selected output 7 cards locally.

When finished selecting and saving all the desired outputs, press ESCAPE to save the preset.

You will be prompted with:

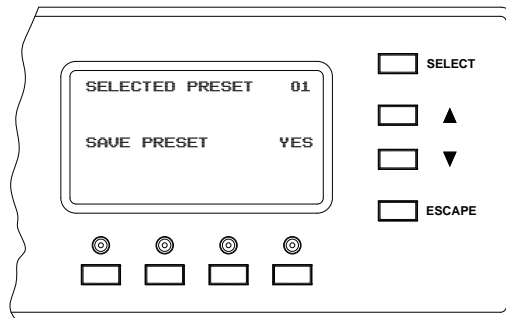

Press the SELECT button to save the preset
 Press exit to return to the main PRESET SETUP screen

To Review a Preset:

Press the PRESET button on the main operating screen below

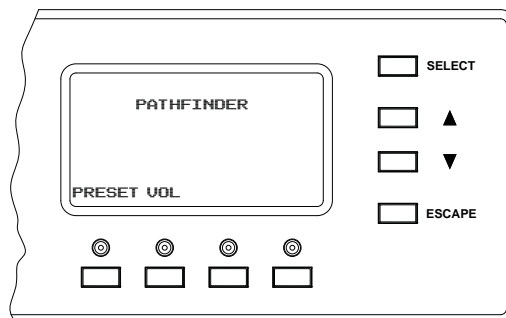

The PRESET HANDLER screen appears. A preset number can now be selected by either using the up down arrow push buttons to scroll to the desired preset number or by selecting a preset number directly via the input or output select push buttons. Use either method to select a preset number.

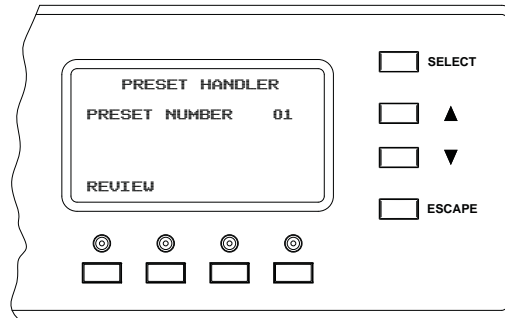

Pressing REVIEW will show the output settings of the preset. The output LED's will light indicate which outputs are active for the selected preset.

See the section on "EXECUTING PRESETS" under the OPERATING MODE section for information on executing presets.

OPERATING MODE

The main purpose of the matrix is to connect inputs to outputs; the front panel is one method of accomplishing this. The main screen is used and will look something like this:

MAIN OPERATING PAGE:

Main operating page with audio option

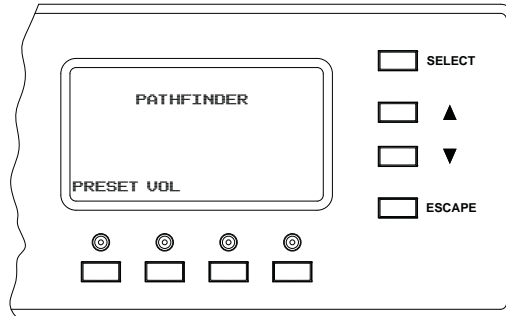

Pressing the VIDEO button for connecting video, the AUD button for switching audio, both VIDEO and AUD to switch both. Pressing the VOL button allows the user to select and adjust an output audio level. Pressing the PRESET button allows the user to select a preset to execute.

Main operating page without audio option

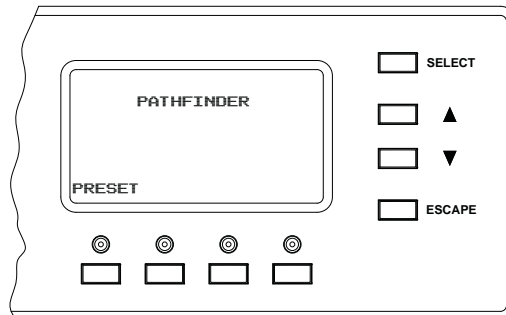

The main screen is used to select the connection type, and which inputs and outputs are to be connected. Pressing the VIDEO button sets the connection as a video connection. Pressing the AUDIO button sets the connection as a audio connection Pressing both the VIDEO and AUDIO buttons indicate that the connection will connect both the video and audio. The user may also press an input or output select button at this screen that would cause the matrix to go into connection mode. When connection mode is entered in that manner, the front panel will light both the audio and video lamps.

The user will normally press an input button first, when that happens if the input is not split it will be displayed as follows:

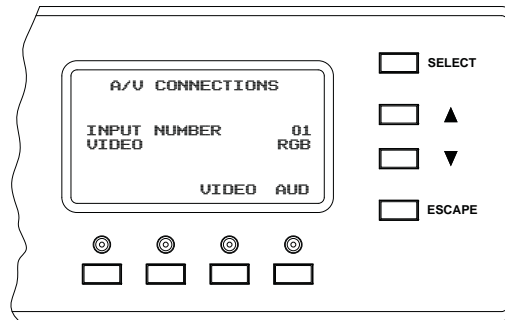

In the example above, Input 1 is not split; because of this, the output lamps that are connected to Input 1 are lit. All un-selected outputs that are not split will blink, indicating they are available for this connection as well. If the user presses an output when already connected to the input, that output lamp will blink, and will be marked for disconnection when the user presses the SELECT button. If the user presses a blinking output button, the lamp will stop blinking and remain on and will be marked for connection when the SELECT button is pushed. If the input is split the following screen will appear:

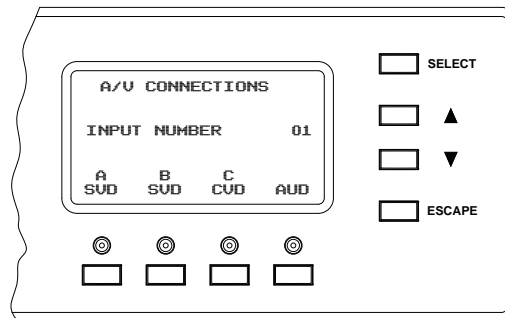

This indicates that input 1 is split and has a S-Video input on “A” and “B” and a composite on “C”. The user will then select either the S-Video, or composite level using the A, B, or C buttons. When the user makes the selection the LED below the selection will be lit, if the selection is S-Video the A&B or B&C lamp will be lit. This makes it intuitive for the user to determine what is being represented on the front panel. If the user selects S-Video all S-Video output connections to this input will be lit, and all S-Video on “A” outputs that are not connected to this input will blink. The same goes for the composite on “C”, if selected, all “C” output connections will be lit, and all “C” outputs will blink.

VOLUME HANDLING PAGE

To adjust output audio levels the user would select the VOL button on the main screen. The Output Audio Volume page will default to output 1. The screen will show the output number, current dB setting, mute status and a bar graph, and will look something like this:

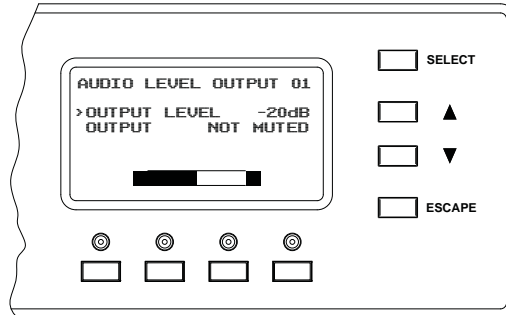

The user will be able to use the output select buttons or the UP, DOWN and SELECT buttons to choose an output. The user will then use the UP, DOWN, and SELECT buttons to scroll down to adjust the volume of the output. When satisfied with the level adjustment the user will press SELECT to store the level and then press the ESCAPE button to return to the main screen.

EXECUTING PRESETS

At the main screen pressing the PRESET button will display the PRESET HANDLER screen

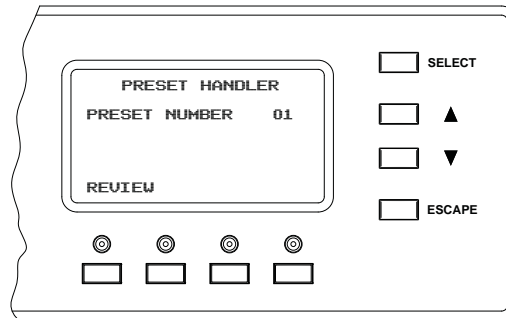

A preset number can now be selected by either using the up down arrow push buttons to scroll to the desired preset number or by selecting a preset number directly via the input or output select push buttons. The selected preset number will be displayed on the menu page in either case. Pressing the PRESET button again will execute the preset and bring up the executing preset confirmation message

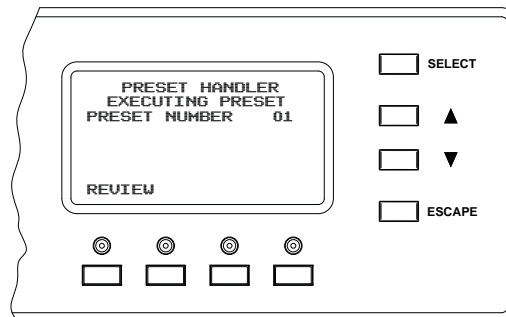

If the user tries to execute an unused preset number the following screen will appear:

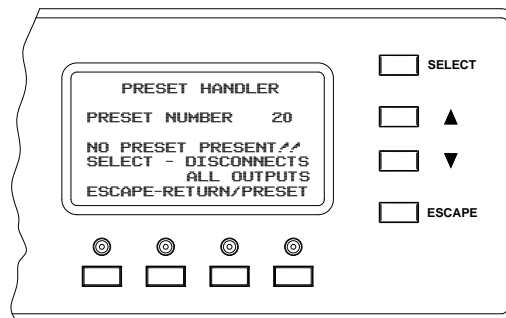

The review button is used to display output status. When selected, the active output LEDs will light (steady) indicating an active output. Pressing any of the active output push buttons will display detailed route information for that given preset. It displays what type of connection (audio, video, or both) and what input the output is connected to in that preset.

NOTE: See "**PRESET SETUP MENU PAGE**" for additional information

FACTORY RESET

The user can perform a factory reset from the front panel by selecting RESET MATRIX from the MAIN SETUPS MENU.

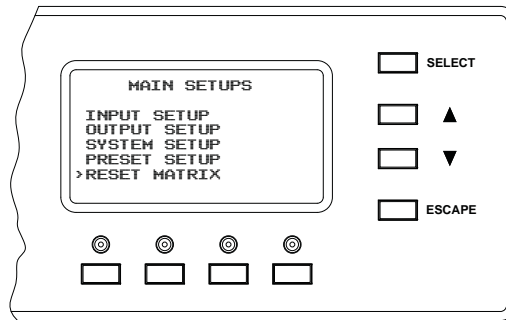

Selecting RESET MATRIX will bring up the following screen.

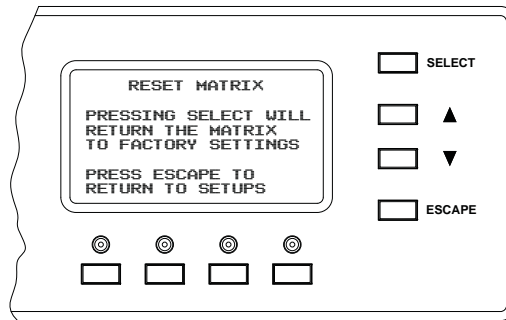

Pressing SELECT will bring up the confirmation screen below. Pressing ESCAPE will return the user to the MAIN SETUPS SCREEN.

Selecting YES will return the Pathfinder Matrix to original factory default settings. Selecting NO will return the user to the RESET MATRIX menu above.

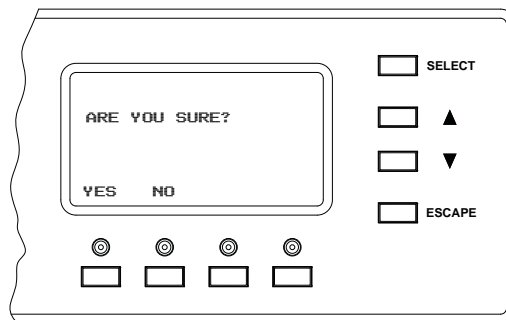

PATHFINDER WITH EAGLE CONTROLLER SETUP

1.) Configuring the Pathfinder

The Pathfinder is configured with an IP address compatible with the Eagle controller. The address is 192.168.0.243. The IP port address is also configured to Port 23. No other configuration is necessary. To check and/or change the address the IP address can be accessed via the front panel by getting into the setup menu (pressing the up and down buttons simultaneously), then selecting SYSTEM SETUP, TCP/IP - DUET SETUP.

2.) Setting Up the Eagle Controller

There is a distinct order for configuring Eagle Controller and Pathfinder. Following this order makes the process simpler, and prevents omission of key steps. The order of setup is as follows:

- A.) System Reset
- B.) Destination Setup
- C.) Router Setup
- D.) Output Patch Setup
- E.) Input Patch Setup
- F.) Output Setup
- G.) Input Setup
- H.) Save Setups

The Eagle 200 Controller has two rotary encoders (knobs) that are used for navigation and option selection. Use the top rotary encoder to scroll up or down lines. Then use the bottom rotary encoder to change the option. When this document says scroll down, the top rotary encoder to scroll down. When this document says select an option use the bottom rotary encoder.

NOTE: Prior to setting up the Eagle Controller, set any Eagle 200 Switcher/ scalers that are controlled in the system to "REMOTE CONTROL ON" under the "REMOTE CONTROL" menu section in each of their setup menus as shown below:

Select "REMOTE CONTROL" from the main EAGLE 200 switcher/scaler setup screen

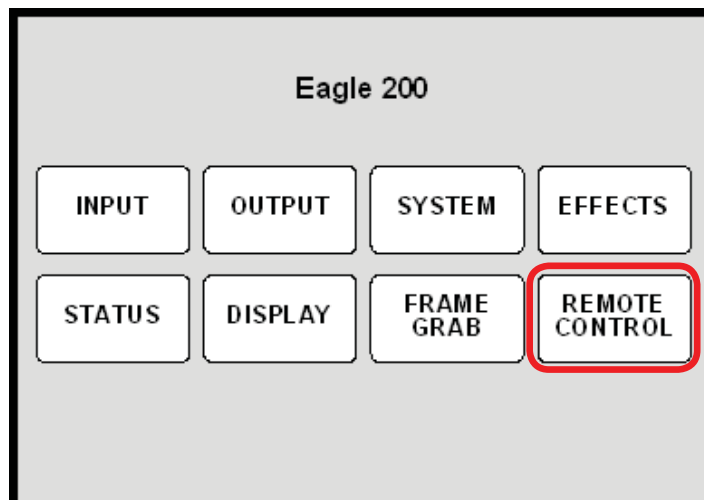

Turn on "Remote Control / DHCP" on each Eagle 200 switcher/ scaler used in the system as shown below

REMOTE CONTROL	
Unit ID	1
Remote Control / DHCP	ON
Unit IP: 192.168.0.5	
----- STATUS -----	
Connected to E 200	
Ctrlr IP:	192.168.0.1
Destination	[1]
Router	[Internal]

SAVE

2A.) System Reset

It is always a good idea to start with a system in a known state. Doing a system reset will assure that all the components, except for the Pathfinder, is clear of all previous setup information.

To reset the Controller and Eagle 200s, from the home menu select SYSTEM from the home menu page as seen below.

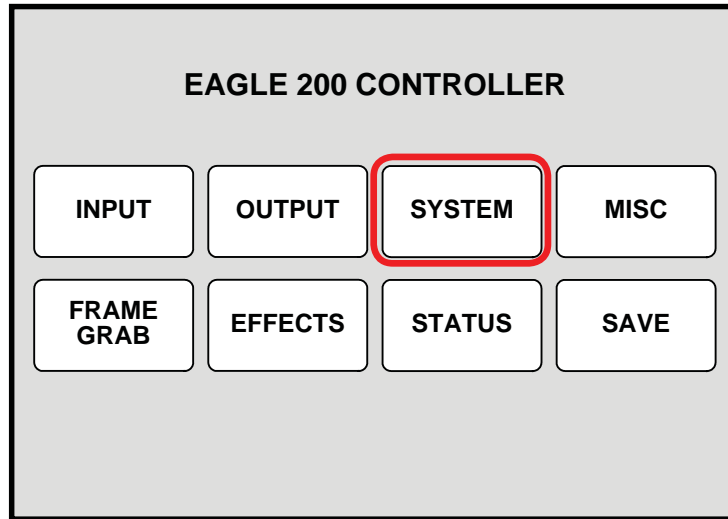

This will display the System menu; you then press the RESET button.

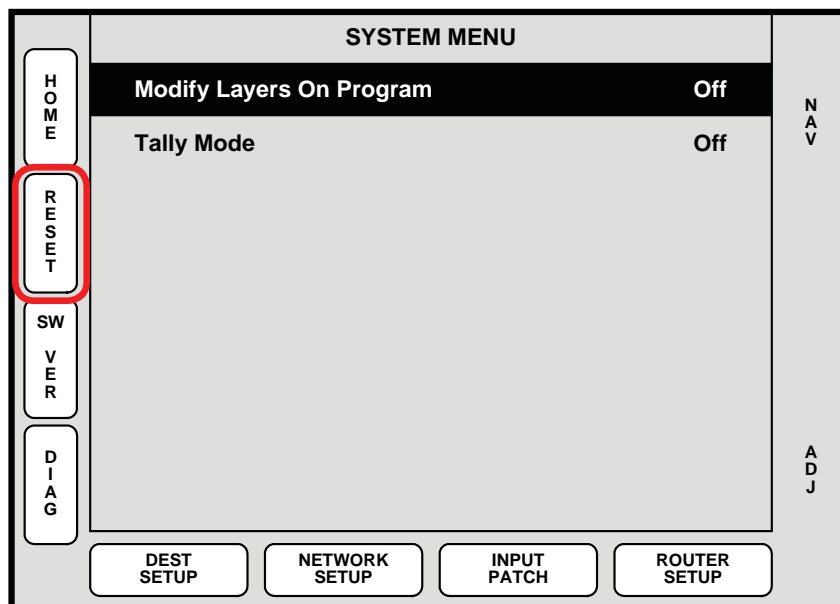

After pressing the RESET button the LCD will display the SYSTEM RESET menu.
Pathfinder Matrix

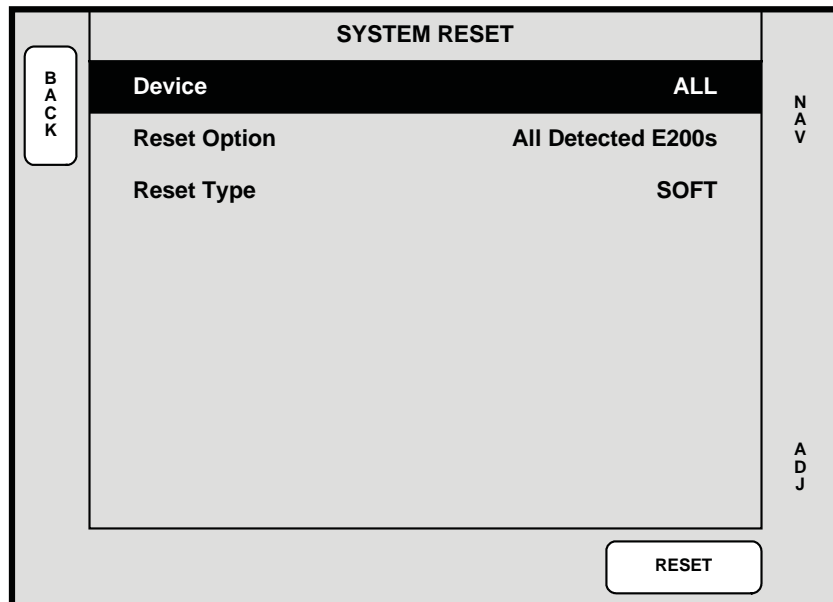

The **System Reset Menu** enables you to perform various system-reset functions. The following functions are provided:

- **Device:** selects which device(s) to reset. Choose between ALL CONTROLLER, E200, or BP (select ALL).
- **Reset Option:** for the selected device(s), chooses the specific subset that the user wishes to reset. Choose between All Detected E200s or Active Dests.(select Active Dests.)

Reset Type: selects the type of reset that you wish to perform. Choose between **SOFT** and **FACTORY**. Note that selecting **SOFT** will not delete any user-defined configurations, while **FACTORY** deletes all user configurations (select **FACTORY**).

Press {**RESET**} to perform the selected reset operation. When the confirmation screen appears:

Press {**YES**} to start the reset procedure. An “**In Progress**” message will be displayed

Press {**NO**} to cancel the procedure.

2B.) Destination Setup

The next step is to setup the destinations, the Eagle 200s. Since it is possible to have multiple Eagle 200s you must remember to repeat the steps that follow for each Eagle 200.

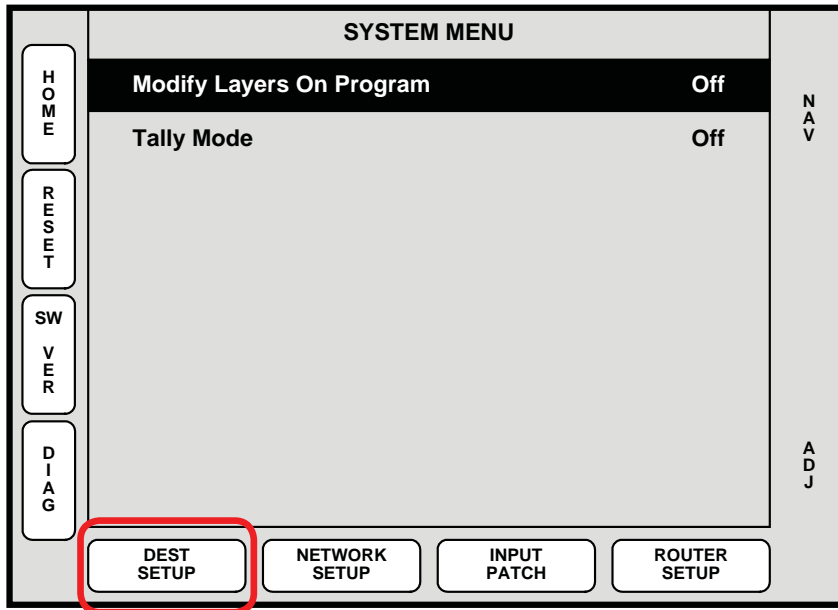

On the SYSTEM MENU page select DEST SETUP, which brings up this screen:

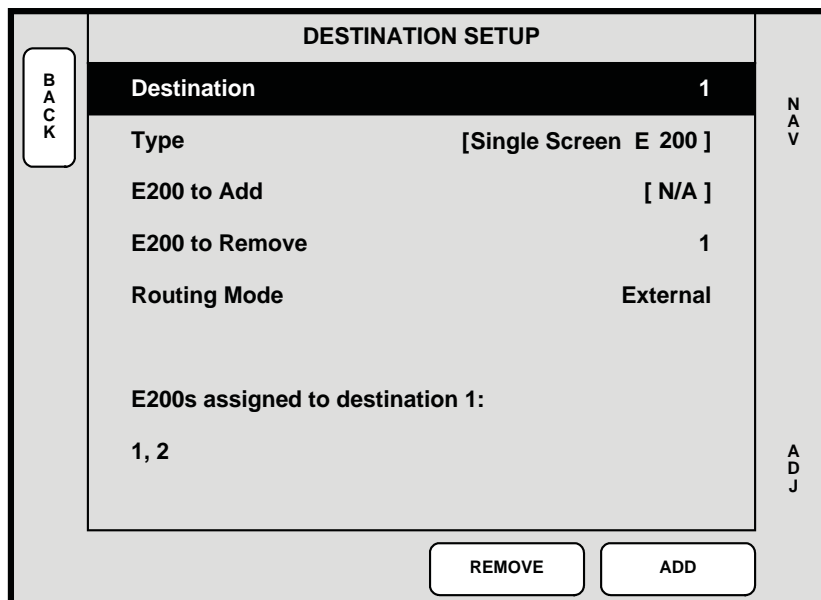

The **Destination Setup Menu** enables you to define each destination. The following functions are provided:

Destination: Sets the destination that you want to define. Choices are **1 - 4** (standard destinations), and Aux 1 - 4. This field is independent of the destination(s) currently selected on the Destination Bus (select 1 – 4)

NOTE: The destination chosen here corresponds to the Destination Button number.

Type: Displays (or sets) the selected destination type.

Select [**Single Screen E200**] if one Eagle 200 has been added to the destination's configuration.

E200 to Add: Lists all available Eagle 200 units that can be assigned to the selected destination. **Units are identified by their ID number.** If an Eagle 200 is currently assigned to another destination, it will not appear in the list.

E200 to Remove: Lists all assigned Eagle 200 units that can be removed from the selected destination. **Units are identified by their ID number.**

Routing Mode: Enables you to set the Eagle 200's routing mode — either

Internal or **External.** This function instructs the system how sources are used on the assigned Eagle 200 unit(s) (select External).

At the bottom of the menu, the **Status** section dynamically lists the Eagle 200 Ids assigned to the current destination.

Press {**ADD**} to add the selected Eagle 200 (on the **E200 to Add** line) to the current destination configuration.

Press {**REMOVE**} to remove the selected Eagle 200 (on the **E200 to Remove** line) from the current destination configuration.

If there are additional Eagle 200s scroll up to destination and repeat the steps, incrementing the destination number each time.

The user must also change the Unit ID on the Eagle 200, below is the Remote Control page for the Eagle 200. Press {**BACK**} to return to the **System Menu**..

2C.) Router Setup

The Router Setup is used to configure the Controller to control the Pathfinder.

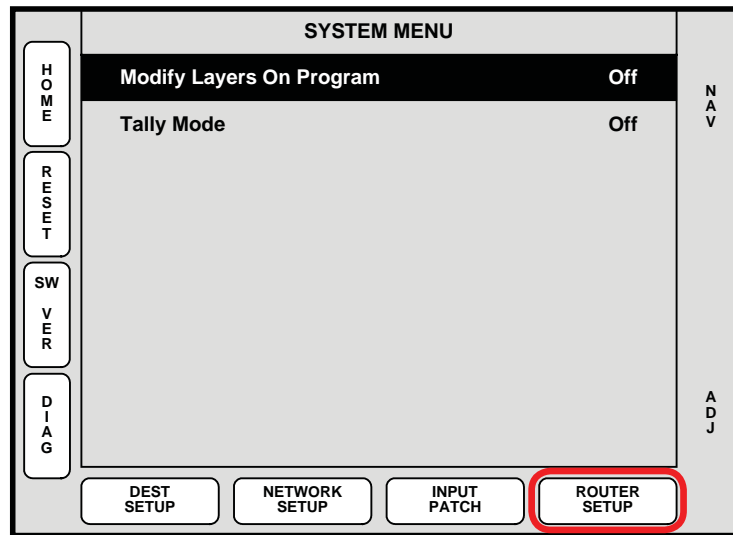

Pressing the Router setup will bring up the '**ROUTER SPECIFICATION**' screen which is shown below:

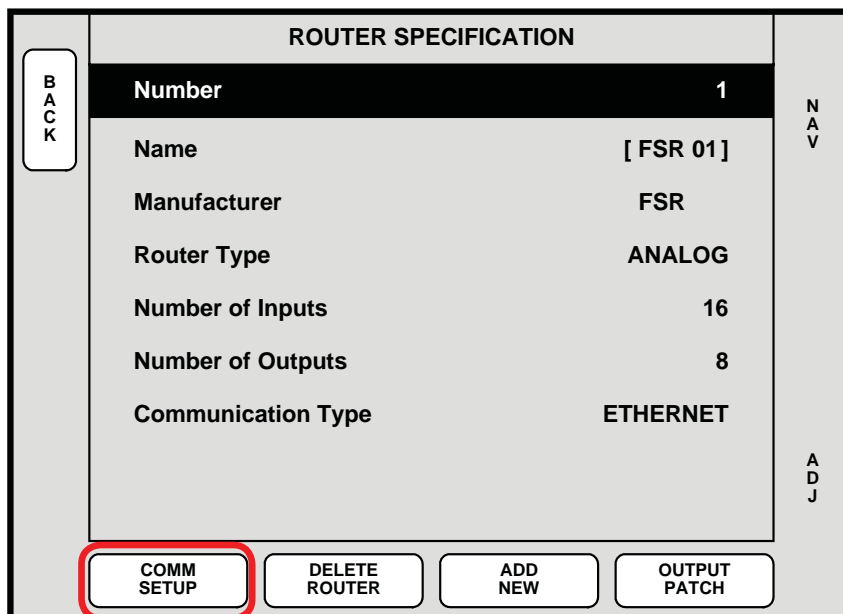

Use the top rotary encoder to scroll down to the "**Manufacturer**" line and then use the bottom rotary encoder to change the matrix manufacturer to FSR. As you scroll through the choices the "Name" line will change automatically. After choosing "FSR", scroll down using the top rotary encoder to "**Communication Type**" and use the bottom rotary encoder to select "**ETHERNET**". Once "**FSR**" and "**ETHERNET**" are selected, press the "**COMM SETUP**" button to go to the "**ETHERNET SETUP**" screen, which is shown below:

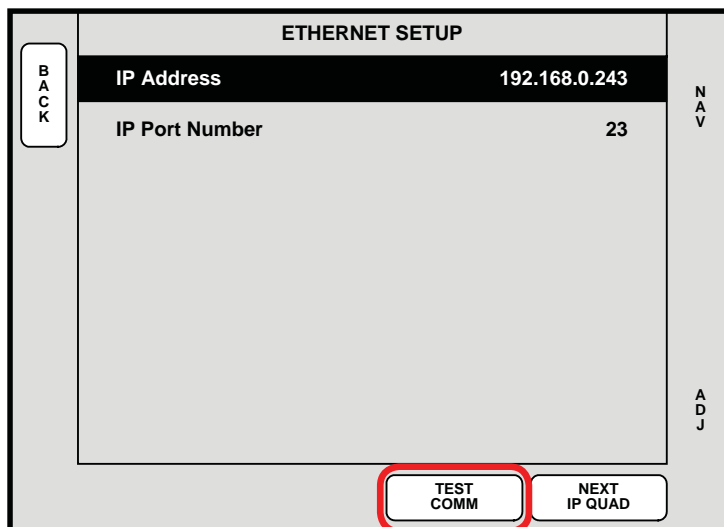

Set the **IP Address** to 192.168.0.243 using the bottom rotary encoder and the “NEXT IP QUAD” button to go from one field to the next. When the IP address is set and the **IP Port Number** is set to ‘23’ press the ‘**TEST COMM**’ button to establish communications between the controller and the Pathfinder. A popup window will come up with the configuration of the Pathfinder.

2D.) Output Patch Setup

The OUTPUT PATCH setup is used to define which outputs on the Pathfinder are used for which Eagles. That is which Pathfinder outputs are used for inputs for which Eagle 200.

Use the BACK button to return to the “ROUTER SPECIFICATION” screen. Press the “OUTPUT PATCH” button to bring up the “OUTPUT PATCH” menu.

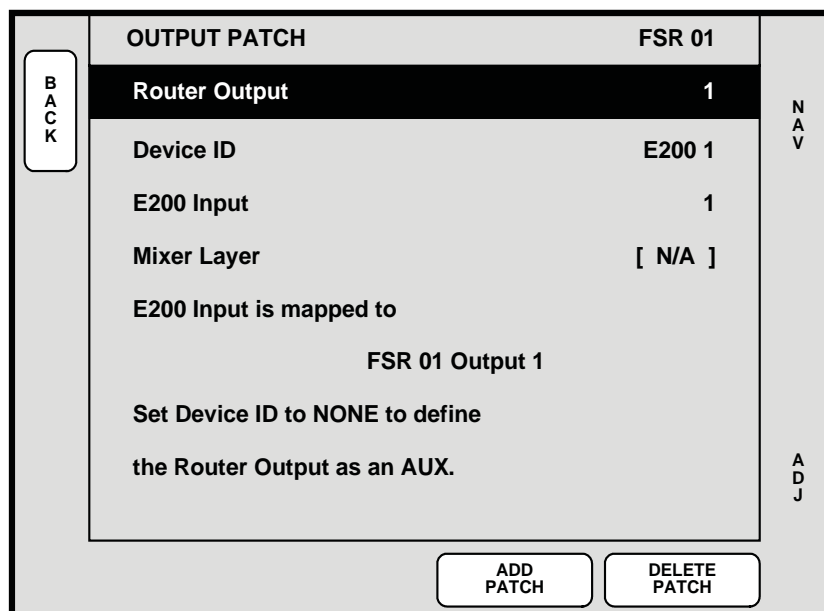

You then start to define which outputs to use for which Eagle 200, you only need 2 outputs per Eagle 200 (one for layer A, another for layer B).

To set the Pathfinder outputs, select Router Output 1, then scroll down to DEVICE ID and select E200 1 (the first Eagle 200). Scroll down to E200 Input, then select 1. Press ADD PATCH. Scroll back up to Router Output and select 2. Scroll down to E200 Input and select 2. Press ADD PATCH and you're done with this step.

The basic explanation of the options on this screen:

- **Router Output:** selects the specific router output that is being patched. The selectable range is **1** to the number of outputs present on the router.
- **Device ID:** selects the Eagle 200 ID to which the Router's output will be connected. The selectable range is **1 - 32**.
- **E200 Input:** selects the physical Eagle 200 input to which the router's output is patched.
- **Mixer Layer:** this line displays **A** or **B**, normally the first input on an Eagle is assigned layer A, the second layer B. This line should change automatically.

Press {**ADD PATCH**} to confirm any change that you make on the menu. As you dial through the choices, the "**E200 Input is mapped to**" lines will show if the current choice is already in use. If the patch already exists and you "add" it, you will be asked to confirm.

Press {**DELETE PATCH**} to delete all "Output Patch Table" registers for the selected router output. This function is an excellent starting point if you are uncertain about specific output patch settings.

Note: Since Eagle 200s only have layer A and layer B, you only need 2 outputs per Eagle 200. If you have multiple Eagle 200s the second Eagle would have outputs 3 & 4 assigned to Eagle 2's layer A & B respectively. For Eagle 200 3, the outputs would be 5 & 6 and for Eagle 200 4, the outputs would be 7&8. Only 4 Eagle 200s can be controlled by an Eagle 200 Controller.

2E.) Input Patch Setup

The INPUT SOURCE PATCH screen is used to define the input sources available on the Pathfinder that are available to the Eagle 200s.

INPUT SOURCE PATCH	
Source Number	1
Connection Type	FSR 01
Router Input	E 200 1
Tally Number	1

Press "ADD PATCH" to log change

ADD PATCH DELETE PATCH

This is a simple menu to work with, all you need to do is select a source number, then scroll down to the router input that it's connected to (normally source 1 goes to input 1, source 2 to input 2, etc.). You then press the ADD PATCH button to save the patch, and repeat for as many inputs you are using on the Pathfinder.

2F.) Output Setup

This menu is used to setup the Eagle 200's output so that it matches the display devices used. This menu is accessed from the home menu.

OUTPUT MENU	
Destination	1
Format	1024x768 @ 59.94
Color Space	[RGB]

Press APPLY FORMAT to select the output resolution.
DVI EDID format can be adjusted to match the output format in the MISC > EDID menu.

APPLY FORMAT SETTINGS TEST PATTERN WIDE SCREEN

2G.) Input Setup

This menu used to setup the input formats and types. This menu is accessed from the home menu.

INPUT MENU		SRC_1
Destination	1	
ID	1	
Layer	[A]	
Input Connector	HD-15	
Format	1024 x 768 @ 60	
Input Type	[RGB]	
Color Space	[RGB]	
Sampling Mode	1:1	
Contrast < % >	100.0	

HOME
CFG
AR
SAVE

NAV
ADJ

APPLY FORMAT SIZING COLOR BALANCE FORCE ACQUIRE

You should press FORCE ACQUIRE then when the controller has the correct setup, it will automatically save the setup.

NOTE: If there are multiple Eagles present, make sure that all the available destination buttons are pressed. Selecting all the destinations allows you to set each input up ONCE, instead of doing the Eagle 200's individually.

2H.) Save Setups

The last step is to save the system, press the “**BACK**” button until the Home Screen is displayed. It will look like this:

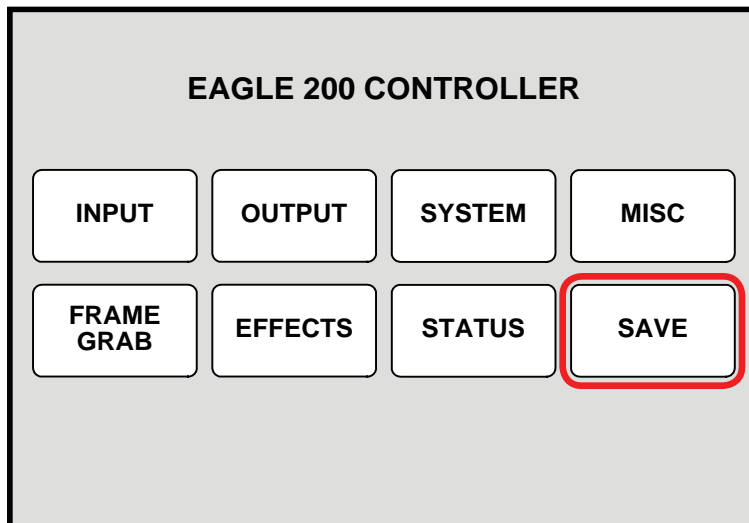

Press “**SAVE**” to save the configuration. Once pressed, the Touch Screen menu reads “**Saving System Configuration.**” If you cycle power, the Controller will return to its state at the time of the “save.”

Updating Software

Software Update Overview

For a “new” software update, following is an overview of the steps required:
Verify your hardware. Refer to the “ Hardware Requirements” section below.
Download the appropriate “update” file. Refer to the “ Downloading Software” section.

Hardware Requirements

The following hardware items are required for upgrading Pathfinder Matrix Series software:

- IBM compatible computer with an available Serial port.
- USB thumb drive, minimum 1 GB.
- Internet connection.
- Straight through DB-9 to DB-9 serial cable

Downloading Software

Via Web Site

On the web, navigate to: <http://www.fsrinc.com>

Select "Document Library" on the menu bar and navigate to the /Matrix Switchers/Pathfinder Series/
FIRMWARE-SOFTWARE section

Click on "Multiloader.exe to begin the installation process.

Updating Pathfinder Matrix Software

Use the following steps to update Pathfinder Matrix Analog Router software. Ensure that the correct version of software has been properly downloaded from the website or the FTP site. If not, refer to the “Downloading Software” section for instructions.

On your PC or laptop double click on the Pathfinder Matrix Install. exe file. or icon if the file resides on your desktop to begin the loader installation:



The Install Shield Welcome screen will appear:



Click on Next to bring up this screen:

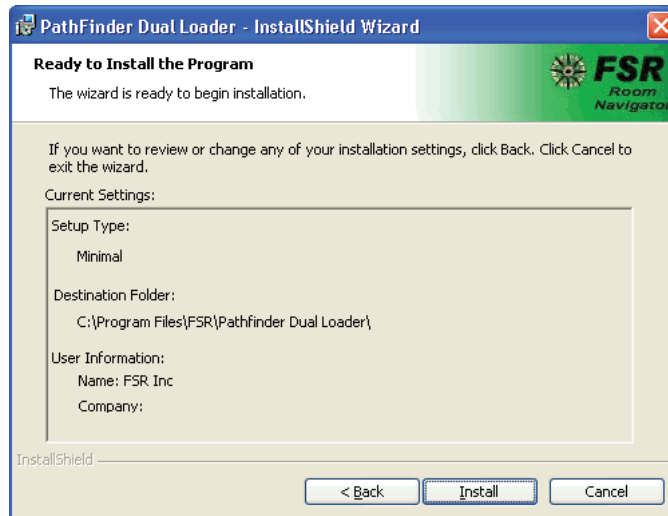

Click on install to bring up this screen and start the Loader installation. A progress bar will monitor the installation status:

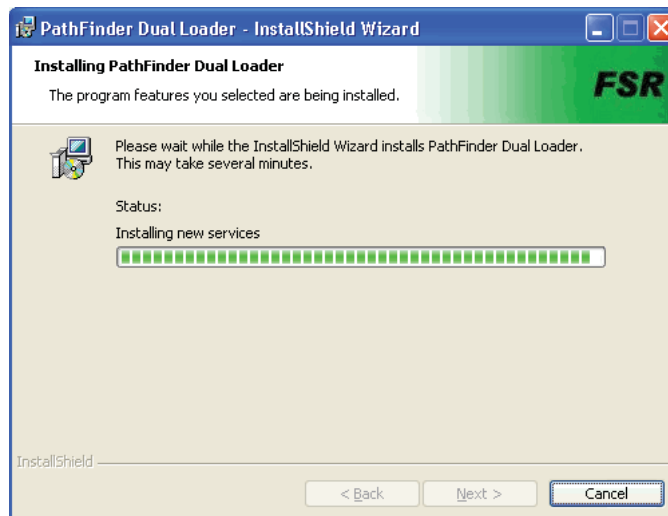

When the installation is completed the following screen will appear. Check the box if you wish to launch the program and click finish



The loader program creates a desktop icon. Click on the icon to begin the Pathfinder Matrix updates.

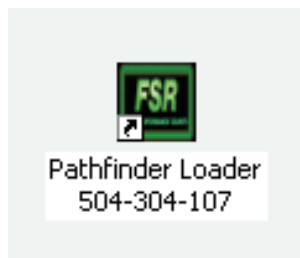

The program will setup the available Comm Ports on your PC.

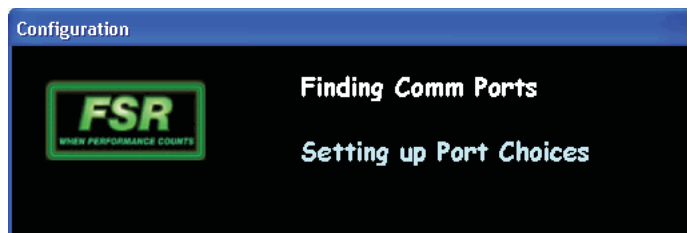

Use the pull-down menu shown below to select an available Comm Port and begin the update

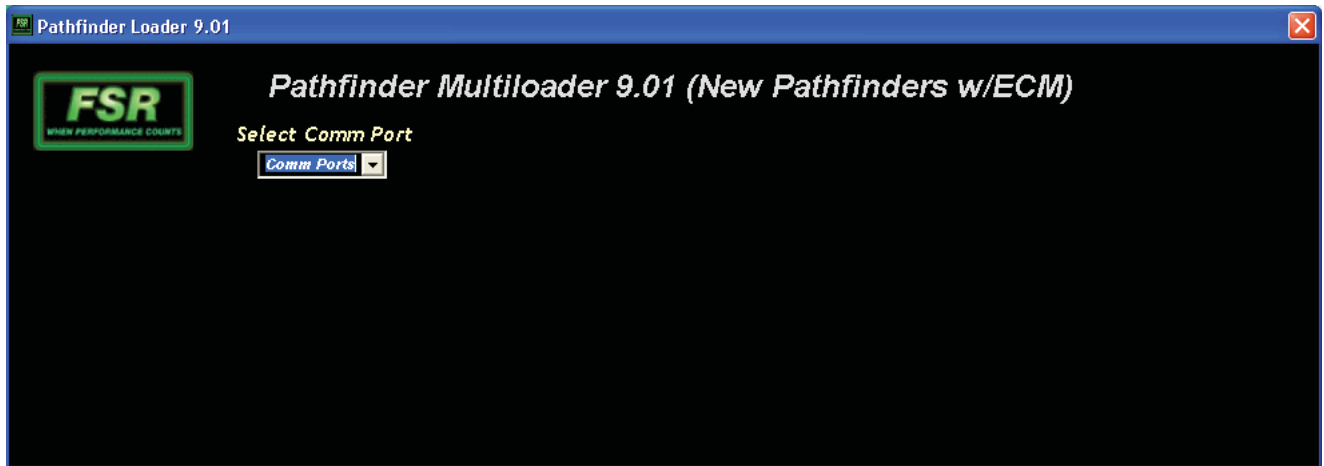

The error pop-up window below usually indicates a bad serial cable, wrong cable type, or an improperly configured Comm port.



When the loader application locates a good Comm Port, the following screen will appear. It will indicate the current versions of Pathfinder Matrix firmware and the allow selection of the latest versions available. Select the most recent version of the Front Panel application and click on the "Click to load Front Panel" button to update the Front Panel Application

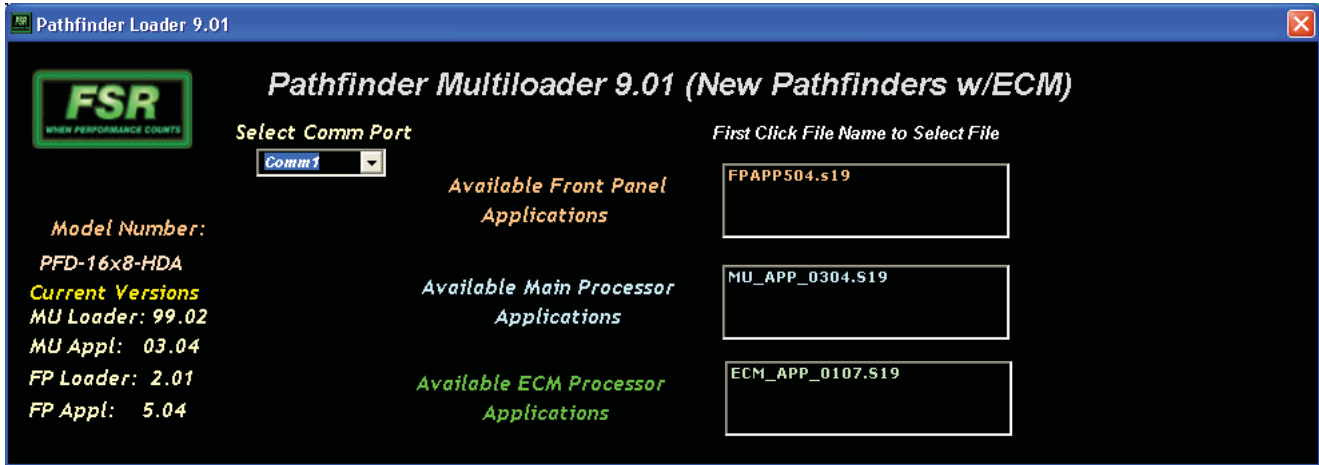

Click on a file to select it. The load button(s) will appear and the file name will be highlighted as shown below. In this example all three files were selected for illustration purposes.

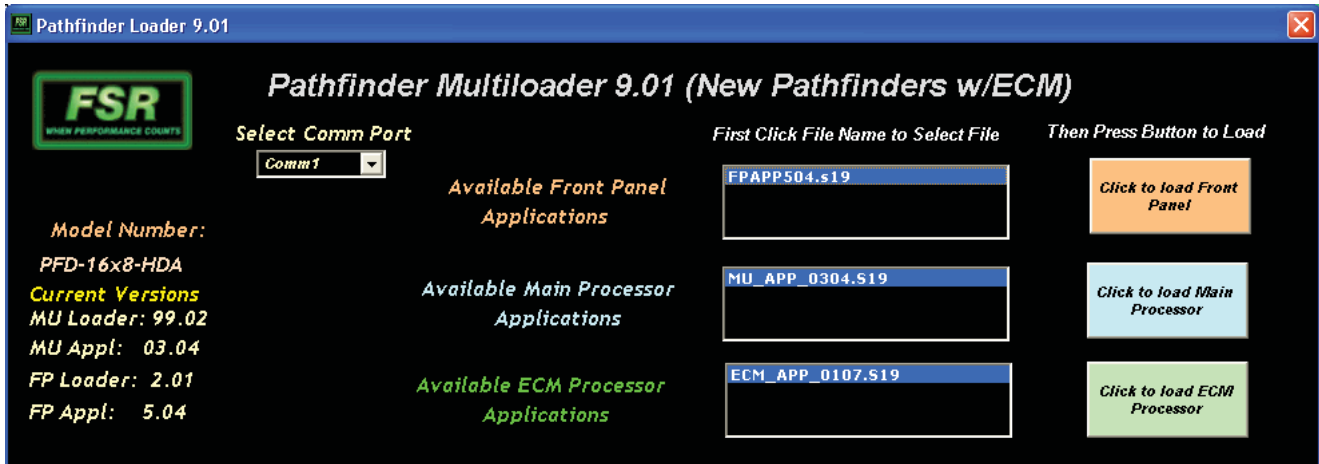

When the pop-up window below appears, click "OK" to confirm and launch the Front panel update

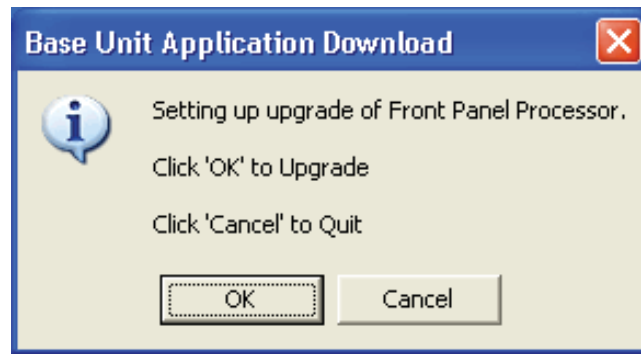

When the pop-up window below appears, click OK to complete the Front Panel update installation.

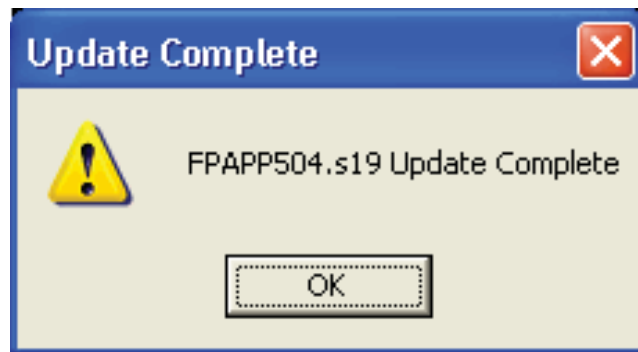

Select the most recent version of the Main Processor application and click on the " Click to load Main Processor" button to update the Main Processor Application

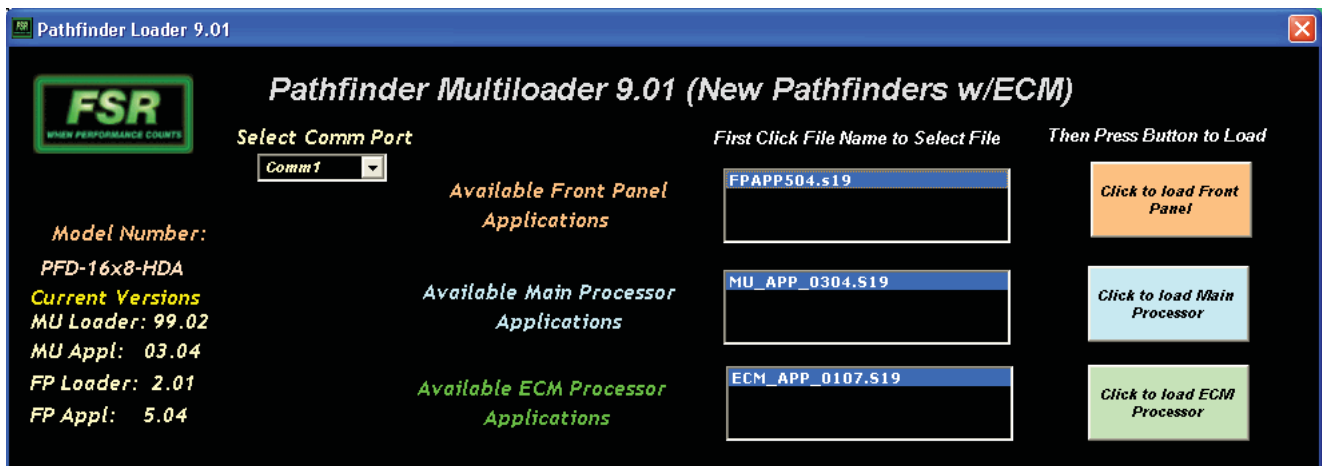

When the pop-up window below appears, click "OK" to confirm and launch the Main Processor update

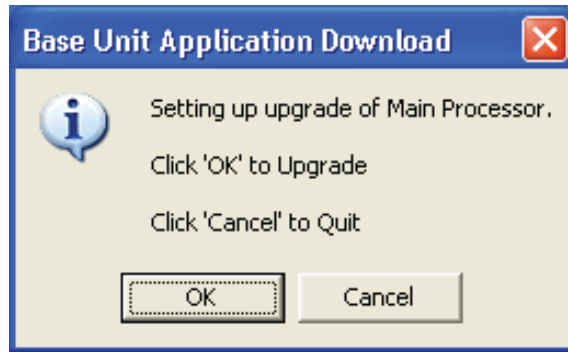

Click OK to complete the Main Processor update installation:

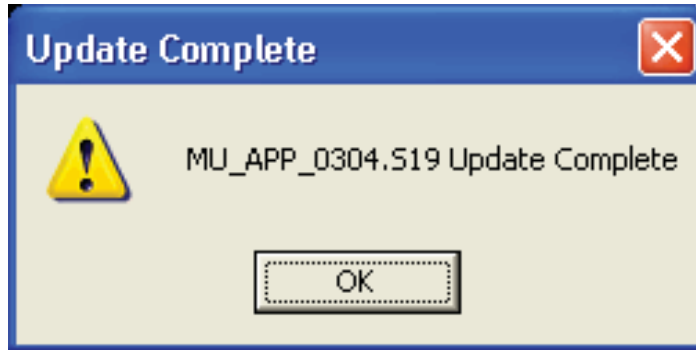

Select the most recent version of the ECM Processor application and click on the " Click to load ECM Processor" button to update the Main Processor Application

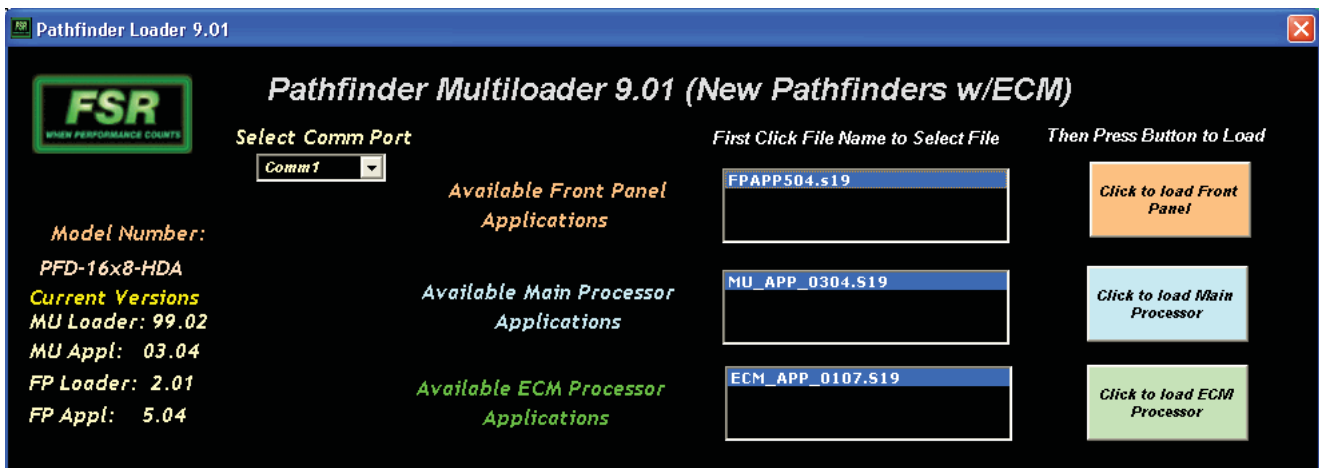

When the pop-up window below appears, click "OK" to confirm and launch the ECM Processor update

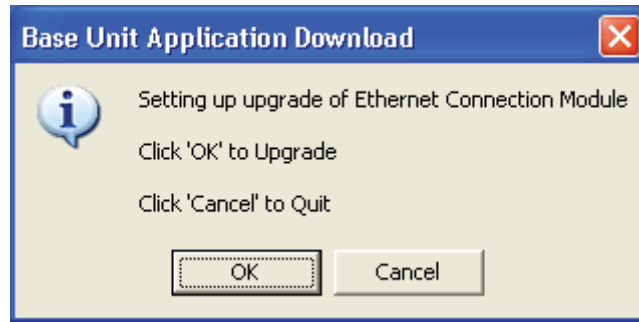

Updates are complete and the Pathfinder Matrix can be returned to service.

SPECIFICATIONS

	Composite and S-Video	Component and RGBHV
Matrix Sizes*	8x4, 8x8, 12x8, 16x8, 16x16, 16x24, 24x24, 24x16, 8x32, 16x32, 24x32, 32x32, 32x8, 32x16 and 32x24	
Connector Type	Female BNC	
Bandwidth Fully Loaded @0.7Vpp	200MHz at -3dB	600MHz at -3dB (550 MHz @ -3dB on 8x4 models)
Flatness	+/- .5 dB to 150MHz	+/- 1.0dB to 300MHz
Gain	Unity	
Impedance	75 Ohm	
Level	.7V Nominal, 2V Max p-p	

		RGBHV Only
Sync		
Input Level		.5V to 5V p-p 4V Nominal
Output Level		TTL 2.4V into 75 Ohm Load
Impedance		75 Ohm
Polarity		Same as Input
Cable Equalization	N/A	Available on EQ models

	<i>Optional</i>	<i>Optional</i>
Audio		
Input and Output #	Matches Video I/O Configuration	
Type	Balanced Stereo	
Connector	5 Position Pluggable Captive Screw Terminal	
Frequency	20Hz to 20KHz	
HD + Noise	.05% at 1KHz at Max rated output	
S/N Ratio	>90dB	
Impedance	Input: 10K Ohm Output: 50 Ohm	
Max Level	Input and Output: +22dBm	
Input Gain Switch	0/ +14 dB Switchable per Input	
Input Trim Range	+/-10 dB per Input	
Output Volume Range	-45 to +5 dB per Output	
Audio Test Conditions	Input- 1kHz tone @ 0 dBm. Output- 600 ohm load.	