



*Our new Fire-Resistant solutions expand the versatility of our floor and wall box lines by providing enhanced, fire-resistant versions of our existing products. All of our FR products are UL listed and comply with UL 263 Fire Resistance Ratings.*

## **Fire-Resistant Floor & Wall Solutions**



# Pour in Place Floor Box Solutions

The Fire-Resistant Kit is offered in two sizes: the 17508 FL-500P-6-FRK and 17509 FL-605P-6-FRK. Both models include a UL listed 3-hour Fire-Resistant Floor Box system comprised of a FireStop box, and four FL-FRK 1½" Intumescent-lined Conduit Assemblies, hardware and installation instructions. A temporary cover is included and protects the floor boxes interior during installation.

The systems are approved for installations using either light or normal weight concrete. The floor box height position can be adjusted accordingly to bring the floor box to the proper level before the pour. When the pour box cavity is filled, the concrete thickness around the floor box meets or exceeds the UL fire-resistant ratings of the floor.

The support structure of the decking must be designed by a Structural Engineer to assure conformance to local building codes. The FL-FRK FireStop Box is affixed to the decking by means of welding, or TEK screws.

Our Floor Boxes combine rugged construction and an elegant design for use in carpet, tile or wood covered floors over poured concrete applications. They are perfect for ballrooms, convention spaces and high traffic areas. Detailed spec sheets on these systems can be found in FSR's document library.

There is ample compartment room to accommodate power, audio, video, telecommunications and data in these elegant and practical boxes. The floor boxes include all the necessary internal plates and brackets to make "pre" and "post" pour compartment changes quick and easy. Using this system, both high and low voltage gang configurations along with compartment isolation can be implemented "on the fly". This makes just about any cabling/connector scenario possible using FSR's IPS or other connector sources.

## FL-500P-6-FRK Fire-Resistant Transformable Floor Box Systems

- Leveling feet
- Removable center divider for passing cables through compartments
- Up to 8-gang capacity undivided. If divided any combination that totals 3 to 4 gangs per side is permissible
- 11-gauge steel temporary construction cover included
- Internal plates and brackets included

**Other depths available  
consult an FSR sales associate**

Watch the video at  
<http://bit.ly/1j7yT0Z>  
or scan this QR code



FSR FL-500P-6 shown  
UL Listed Floor Box

(4) FL-FRK 1½"  
Intumescent-Lined  
Conduit Assemblies

6" depth shown

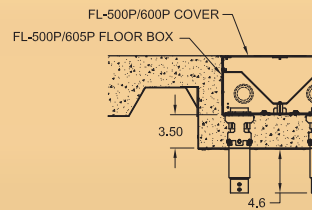

FSR FL-605P-6 shown  
UL Listed Floor Box

## FL-605P-6-FRK Fire-Resistant Transformable Floor Box Systems

Same features as the FL-500P-6-FRK plus additional space and gang openings.

- Up to 12-gang capacity undivided. If divided any combination that totals 4 to 5 gangs per side is permissible



(4) FL-FRK 1½"  
Intumescent-Lined  
Conduit Assemblies

FL-FRK-605P  
FireStop Box  
Assembly

6" depth shown

## Elegant Cover Choices for Carpet, Wood and Tile Floors

There are a variety of covers to choose from. Options include integrated carpet flange. The lift-off section of the cover allows full access to internal connector plates which remain in place after connections are made and cables are routed through it. The

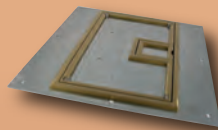

BLP - Brass  
Carpet Flange

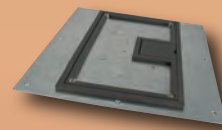

PLP - Gray Painted  
Carpet Flange

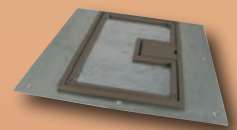

PLP - Clay Painted  
Carpet Flange



SLP -  
Carpet

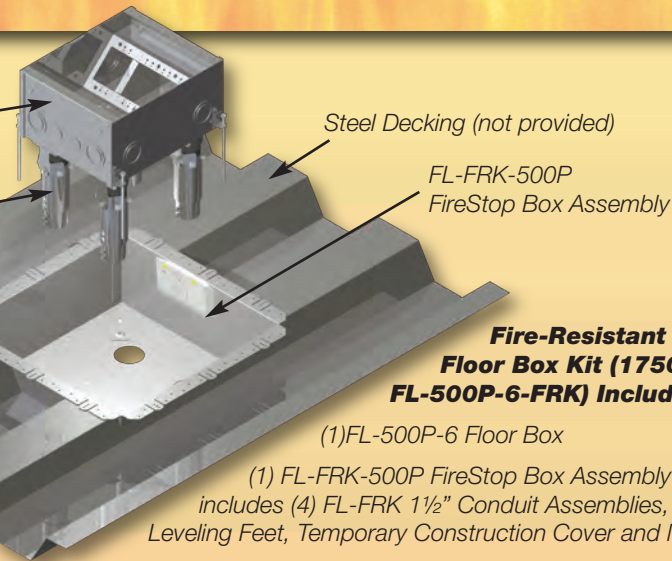

**Fire-Resistant Floor Box Kit (17508 FL-500P-6-FRK) Includes:**

- (1) FL-500P-6 Floor Box
- (1) FL-FRK-500P FireStop Box Assembly Kit includes (4) FL-FRK 1 1/2" Conduit Assemblies, Hardware, Leveling Feet, Temporary Construction Cover and Manual

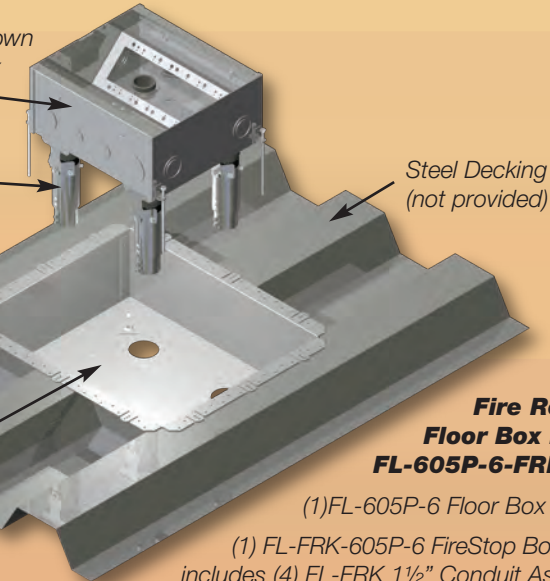
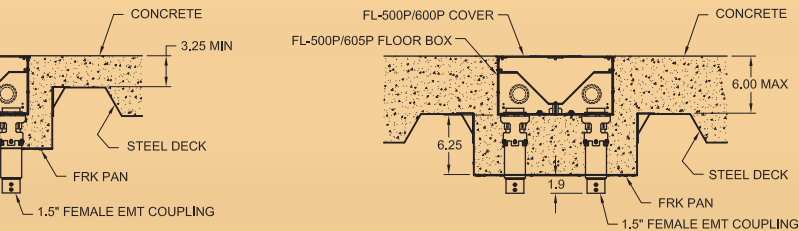

**Fire Resistant Floor Box Kit (17509 FL-605P-6-FRK) Includes:**

- (1) FL-605P-6 Floor Box
- (1) FL-FRK-605P-6 FireStop Box Assembly Kit includes (4) FL-FRK 1 1/2" Conduit Assemblies, Hardware, Leveling Feet, Temporary Construction Cover and Manual

**FL-500P-6-FRK and FL-605P-6-FRK box interior view. (FL-500P-6-FRK shown)**



**THE LITE WITH A BRAIN**

LITE-it easily provides lighting in floor, wall and ceiling boxes, or anywhere a work light is needed. LITE-it can be used with all our Core Solutions. Add LITE-it to every box!

**GANG PLATE DIVIDERS**

Add and remove as needed to form a multitude of gang arrangement possibilities

**CENTER DIVIDERS**

Remove to run cables across compartments (in " deep back boxes)

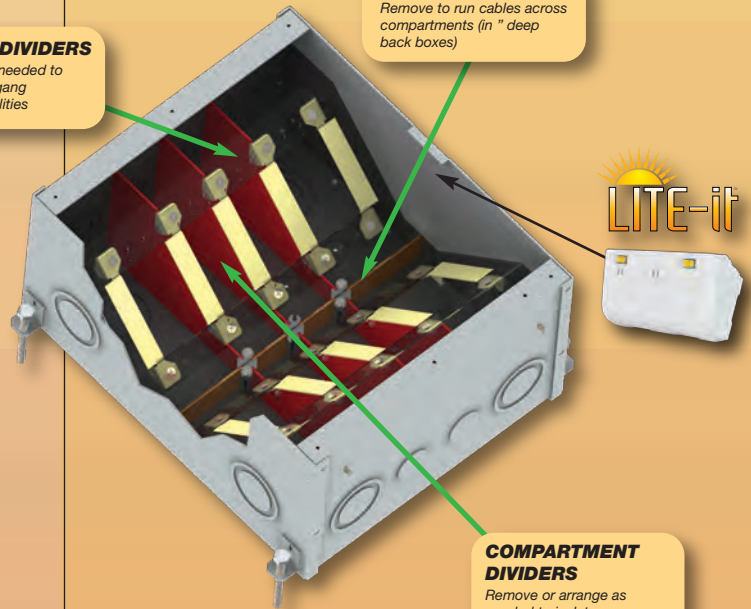

**COMPARTMENT DIVIDERS**

Remove or arrange as needed to isolate compartments

**WARNING:** Must be used on a compartment where line voltage wiring is present

**Floor Covers**  
 t edging, flat covers for non-carpeted, bare floor applications and different finishes.  
 and stored cables. The hinged cable exit door flips back to allow the cover to  
 The 0.25" raised edge style covers are UL scrub water approved.

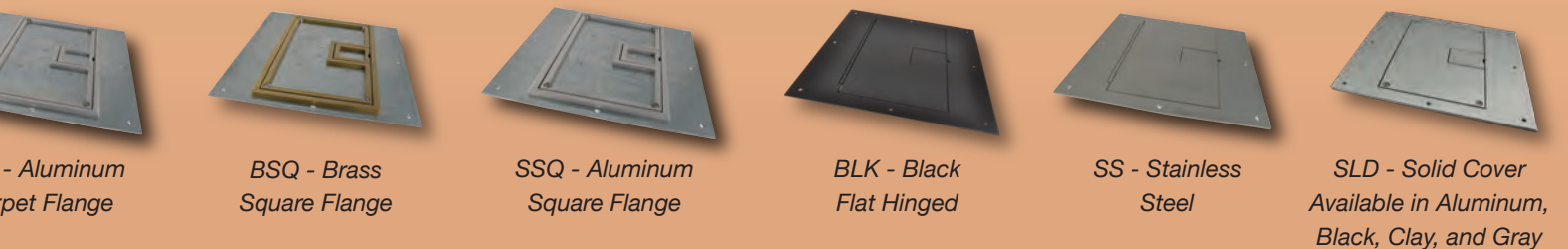



# FSR Fire-Resistant Wall Box

The PWB-FR-450 is the only fire rated wall box in the infrastructure industry. It is designed for 1 hour rated walls that require more connectivity than is allowed by code. The PWB-FR-450 lets you hang flat screen displays with plenty of room for all your in-wall connections and large interfaces. Integrated within the cover frame assembly are two long vent openings or cable exits for wiring and convection cooling of internally mounted devices. Connections to the PWB-FR-450 are made via 3/4" and 1" - 1/2" concentric knockouts which provide ample wiring flexibility to feed the 4 pre-wired AC outlets and 4 removable single gang mounting bracket.

- Rugged 14 Gauge Steel
- Black or White cover
- Simple installation
- Mounting Hardware Included

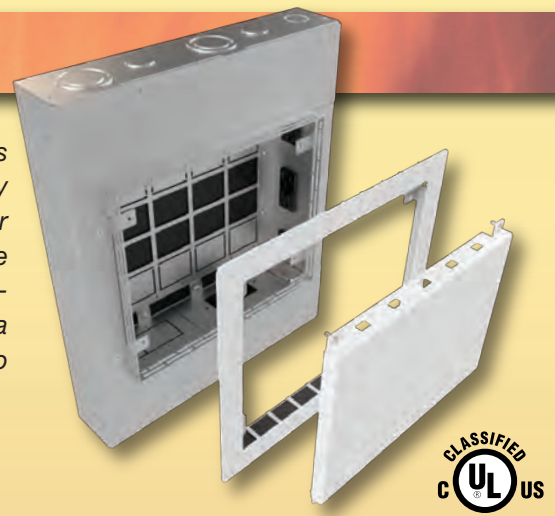

# FSR Fire-Resistant Poke-Thru Floor Boxes

Designed for use in fire rated floors, these sturdy core hole products are available in 4", 6", 8" and 10" diameters.

All models offer flexibility via mounting bracketry to accommodate a wide assortment of power, data and audio video connection options.

A complete line of sub-plates for device mounting and connectors is available.

Cover finishes available in Brushed Aluminum, Brushed Brass, and Black.

The cover technology exceeds UL scrub water testing requirements.

## SmartFit 10"

- Drop down cable access doors to reduce trip hazards
- Pre-pour tubes to remove the need for core hole drilling
- Sub-plates to accept third party devices
- NEMA device spacing available
- 2-hour fire rating
- 180° access door opening
- Flange height 0.16" and complies with ADA requirements
- Power wiring junction box included
- 1000 lb. cover load rating with 2x safety factor
- ULC and cULus



## SmartFit 4"

- Easy installation
- "Step down" installation clips allow the fitting to be removed from the floor from above
- Stationary fire barrier expands during fire conditions to provide an upper fire seal
- Adjustable fire barrier accommodates concrete thickness from 3" to 6"
- Accepts FSR SmartFit cover for both carpet and tile applications
- UL Listed for use in 2 hour rated floors

## SmartFit 6"

- Easy installation, simply drill a 6" hole and install
- Drop down cable access doors to reduce trip hazards
- Furniture feed option (6" core hole) for up to thirty CAT 6a data cables and ten 10 AWG power wires
- Pre-pour sleeve eliminates the need for core hole drilling
- Sub-plates accept IPS Plates and third party devices
- Features 3/4" and 2" EMT conduits tubes
- UL Listed for use in 2 hour rated floors

## SmartFit 8"

Same features as SmartFit 6" plus...

- Easy installation, simply drill a 8" hole and install
- Drop down cable access doors to reduce trip hazards
- Pre-pour sleeve eliminates the need for core hole drilling
- Sub-plates accept IPS Plates and third party devices
- Multiple conduit tube options are available.
- UL Listed for use in 2 hour rated floors

Individual spec sheets and drawings available on the FSR website.



244 Bergen Boulevard · Woodland Park, NJ 07424

973.998.2300 · F: 973.785.3318

W: [fsrinc.com](http://fsrinc.com) · E: [sales@fsrinc.com](mailto:sales@fsrinc.com)

LIT1458E

© 2020 FSR, Inc. All Rights Reserved. Specifications subject to change.