

TYPICAL INSTALLATION FOR ALL T3U TABLE BOXES

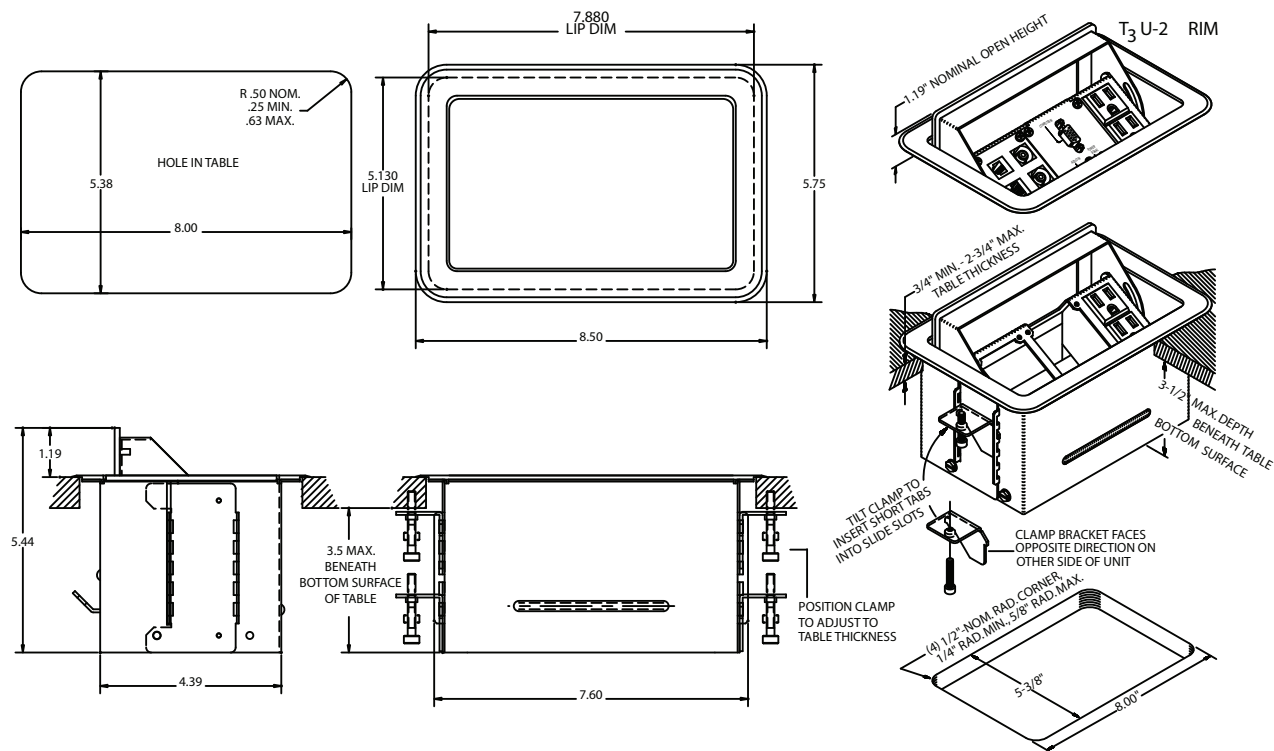

NOTE: T3U-1 and T3U-2 models have a 6' NEMA 5-15 SJ cordset.
The T3U-3 model has a 9' NEMA 5-20 SJ cordset.

SIMILAR FSR PRODUCT OFFERINGS

The T3-AC2 and T3-PC1D are perfect table boxes for single users, where convenient access to network drops, ac power sources and video/audio displays are required. The small footprint provides an unobtrusive complement to any decor.



T3-AC2

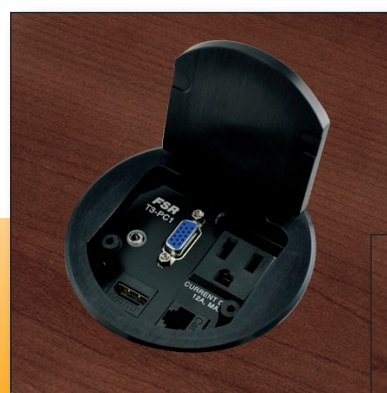

T3-PC1D



FSR

244 Bergen Boulevard, Woodland Park, NJ 07424
Phone: 973.785.4347 · Fax: 973.785.4207
Web: www.fsrinc.com · E-mail: sales@fsrinc.com



Specifications are subject to change without notice.



T3U Rim Series Table Top Tilt Up Boxes

FSR

Metal Products Group

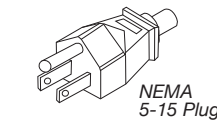

T3U-1R-BRS
(Shown with accessory plates and connectors.)

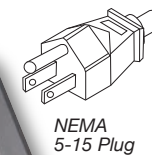

T3U-2R-BLK

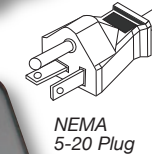

T3U-3R-BLK
(Shown with accessory plates and connectors.)

Touchboards

205 Westwood Ave, Long Branch, NJ 07740
Phone: 866-94 BOARDS (26273) / (732)-222-1511
Fax: (732)-222-7088 | E-mail: sales@touchboards.com

Introducing FSR's expanded line of table box solutions...

The T3U RIM Series (Table Top Tilt Up) table boxes.

Designed expressly for applications requiring multiple access boxes within the same table, the FSR T3U RIM Series handles data, power, and AV connections in a low profile box.

You can match almost any decor with the T3U RIM Series cover finish selection. Colors include Black, brushed Brass or brushed Nickel. The T3U RIM Series easily installs in any table surface with thickness ranging from a minimum .75" to a maximum of 2.75". In the open position, the T3U RIM Series cover protrudes a mere 1.19" from the table top. Under the table, the T3U RIM Series extends only 4.25" from the table top surface.

The FSR T3U RIM Series offer a variety of connection schemes through the use of interchangeable snap in connectors and mounting plates. This allows the plates to be populated by the installer and can be changed as the need arises. FSR offers a complete line of connectors and plates to satisfy most installation requirements. (See options on the following pages).

NOTE: T3U-1 and T3U-2 models have a 6' NEMA 5-15 SJ cordset. The T3U-3 model has a 9' NEMA 5-20 SJ cordset.

FSR Inc.

244 Bergen Boulevard, Woodland Park, NJ 07424
Phone: 973.785.4347 · Fax: 973.785.4207
Web: www.fsrinc.com · E-mail: sales@fsrinc.com



T3U-1

T3U-1
Connector Plate View

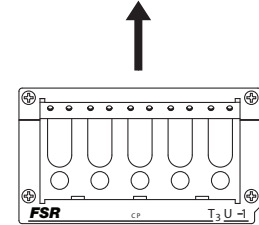
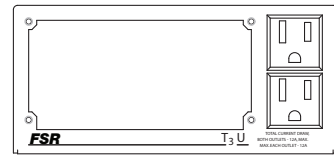

T3U-1-CP

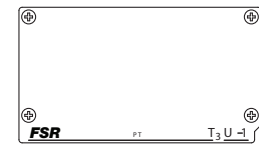

T3U-1-PT

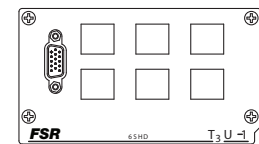

T3U-1-6SHD

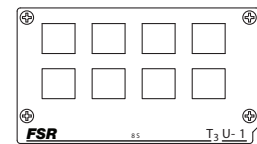

T3U-1-8S

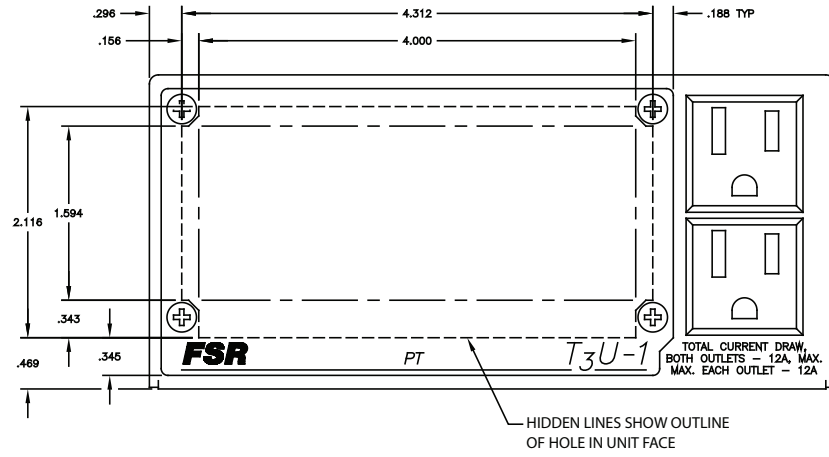

T3U-2

Connector Plate View

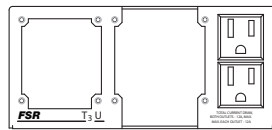

Left Plate Options

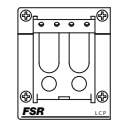

T3U-2-LCP

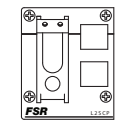

T3U-2-L2SCP

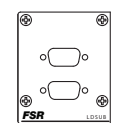

T3U-2-LDSUB

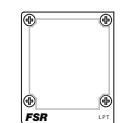

T3U-2-LPT

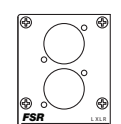

T3U-2-LXLR

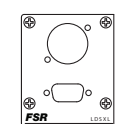

T3U-2-LDSXL

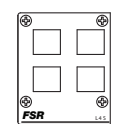

T3U-2-L4S

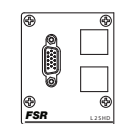

T3U-2-L2SHD

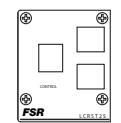

T3U-2-LCR5T2S

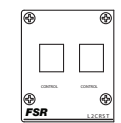

T3U-2-L2CR5T

Right Plate Options

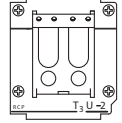

T3U-2-RCP

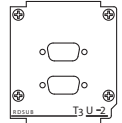

T3U-2-RC15

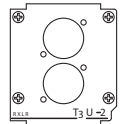

T3U-2-RDSUB
No Connectors

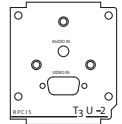

T3U-2-RXLR
No Connectors



T3U-2-RDSXL
No Connectors

T3U-2

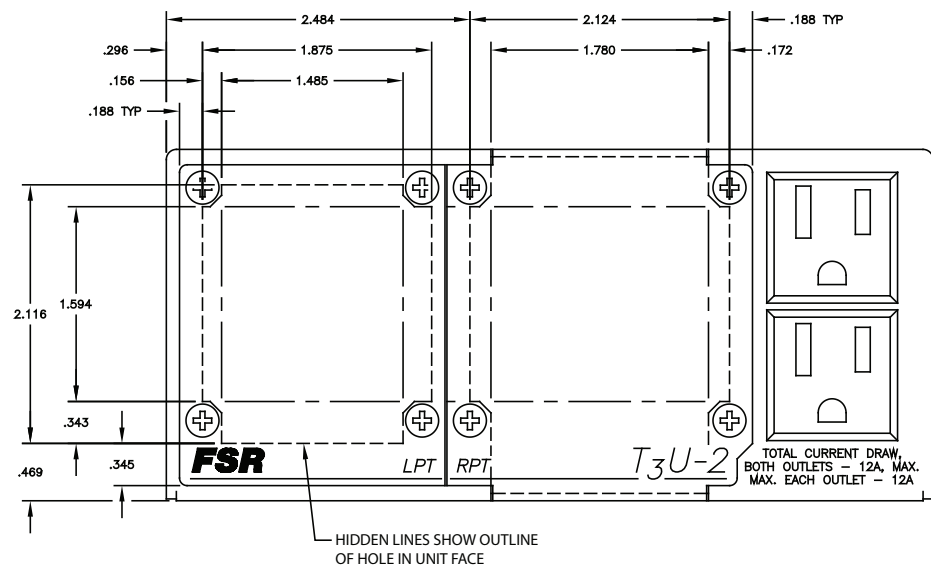

T3U-3

T3U-3
Connector Plate View

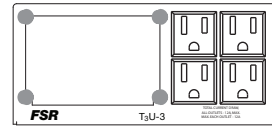

T3U-3-4SHD



T3U-3-6S



T3U-3-PT

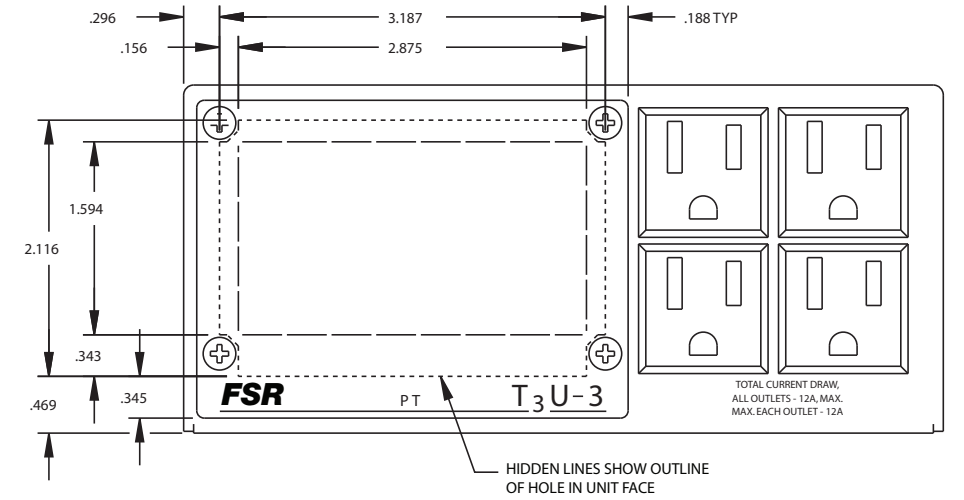

SNAP IN CONNECTORS AVAILABLE (ALL MODELS)

- SS-RJ45***
*SS-RJ45-WHT or IVO= Punch Down
SS-RJ45-BLK = Pass Thru
- SS-RJCAT6**
CAT 6 to Punch Down
(Black Only)
- SS-RJ11***
*SS-RJ11-WHT or IVO= Punch Down
SS-RJ11-BLK = Pass Thru
- SS-LC**
Fiber LC Pass Thru
(Black Only)
- SS-HDMI**
HDMI Pass Thru
(White and Black Only)
- SS-BNC**
BNC Pass Thru
- SS-SCON**
S-Video Connector Pass Thru
- SS-FCON**
F Connector Pass Thru
- SS-RCA-R**
Red RCA Pass Thru
- SS-RCA-B**
Black RCA Pass Thru
- SS-RCA-Y**
Yellow RCA Pass Thru
- SS-MINI**
3.5mm Stereo to Solder
- SS-SWMOM**
Momentary Switch
- SS-SWMAIN**
Maintained Switch
- SS-CBLNK**
Blank Insert
- SS-USBA**
USB A Pass Thru
(Black Only)
- SS-USBAHW**
USB A to Punch Down
(Black Only)
- SS-USBB**
USB B Pass Thru
(Black Only)
- SS-USBBHW**
USB B to Punch Down
(Black Only)
- SS-USB-CHRG**
USB Universal 10W Charging Port (black only) with Power Supply

SNAP IN CONNECTOR ORDERING DETAIL

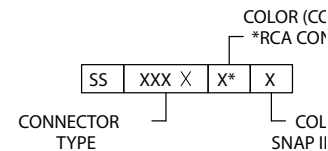

ORDERING INFORMATION

MODEL	FINISH	ACCEPTS (see connector plate view)
T3U-1R-BLK	BLACK	ONE T3U-1 CONNECTOR PLATE
T3U-1R-BRS	BRUSHED BRASS	ONE T3U-1 CONNECTOR PLATE
T3U-1R-NKL	BRUSHED NICKEL	ONE T3U-1 CONNECTOR PLATE
T3U-2R-BLK	BLACK	ONE SET OF T3U-2 LEFT AND RIGHT CONNECTOR PLATES
T3U-2R-BRS	BRUSHED BRASS	ONE SET OF T3U-2 LEFT AND RIGHT CONNECTOR PLATES
T3U-2R-NKL	BRUSHED NICKEL	ONE SET OF T3U-2 LEFT AND RIGHT CONNECTOR PLATES
T3U-3R-BLK	BLACK	ONE T3U-3 CONNECTOR PLATE
T3U-3R-BRS	BRUSHED BRASS	ONE T3U-3 CONNECTOR PLATE
T3U-3R-NKL	BRUSHED NICKEL	ONE T3U-3 CONNECTOR PLATE