

REGULATORY COMPLIANCE

FSR'S ELECTRONIC PRODUCTS have been tested for compliance with: FCC Class A and CE The Power Adapter has been tested for compliance with: UL, CSA and CE.

WARRANTY POLICY

This product is warranted against failures due to defective parts or faulty workmanship for a period of one year after delivery to the original owner. During this period, FSR will make any necessary repairs or replace the unit without charge for parts or labor. Shipping charges to the factory or repair station must be prepaid by the owner, return-shipping charges, via UPS / FedEx ground, will be paid by FSR.

This warranty applies only to the original owner and is not transferable. In addition, it does not apply to repairs done by other than the FSR factory or Authorized Repair Stations.

This warranty shall be cancelable by FSR at its sole discretion if the unit has been subjected to physical abuse or has been modified in any way without written authorization from FSR. FSR's liability under this warranty is limited to repair or replacement of the defective unit.

FSR will not be responsible for incidental or consequential damages resulting from the use or misuse of its products. Some states do not allow the exclusion of incidental or consequential damages, so the above limitations may not apply to you. This warranty gives you specific legal rights, and you may also have other rights which vary from state to state.

Warranty claims should be accompanied by a copy of the original purchase invoice showing the purchase date (if a Warranty Registration Card was mailed in at the time of purchase, this is not necessary). Before returning any equipment for repair, please read the important information on service below.

SERVICE

Before returning any equipment for repair, please be sure that it is adequately packed and cushioned against damage in shipment, and that it is insured. We suggest that you save the original packaging and use it to ship the product for servicing. Also, please enclose a note giving your name, address, phone number and a description of the problem.

NOTE: all equipment being returned for repair must have a Return Authorization (RMA) Number. To get a RMA Number, please call the FSR Service Department (973-785-4347).

Please display your RMA Number prominently on the front of all packages.

Contact Information:

244 Bergen Boulevard,
West Paterson, NJ 07424

Tel: (973) 785-4347 · Fax: (973) 785-4207

E-Mail: sales@fsrinc.com · Web: <http://www.fsrinc.com>

issue date: 9-16-02



TN - 2105 EQA

TABLE NAVIGATOR COMPUTER SWITCHER with AUDIO

OPERATIONS MANUAL



Touchboards

205 Westwood Ave, Long Branch, NJ 07740
Phone: 866-94 BOARDS (26273) / (732)-222-1511
Fax: (732)-222-7088 | E-mail: sales@touchboards.com

244 Bergen Boulevard, West Paterson, NJ 07424
Tel: (973) 785-4347 · Fax: (973) 785-4207
E-Mail: sales@fsrinc.com
Web: <http://www.fsrinc.com>

PROPRIETARY INFORMATION

All information in this manual is proprietary to and the property of FSR inc. This publication is protected by the Federal Copyright Law, with all rights reserved. No part of this document may be reproduced, transcribed, or transmitted, in any form or by any means, without prior explicit written permission from FSR inc.

Operators Safety Summary

The general safety information in this summary is for operating personnel.

Do Not Remove Covers or Panels There are no user-serviceable parts within the unit. Removal of the top cover will expose dangerous voltages. To avoid personal injury, do not remove the top cover. Do not operate the unit without the cover installed.

Power Source This product is intended to operate from a power source that will not apply more than 230 volts rms between the supply conductors or between both supply conductor and ground. A protective ground connection by way of grounding conductor in the power supply is essential for safe operation.

Grounding the Product This product is grounded through the grounding conductor of the power supply. To avoid electrical shock, plug the power supply into a properly wired receptacle before connecting to the product input or output terminals. A protective-ground connection by way of the grounding conductor in the power supply is essential for safe operation.

Use the Proper Power Cord Use only the power supply, shipped with and specified for your product. Use only a power cord that is in good condition. Refer cord and connector changes to qualified service personnel.

Do Not Operate in Explosive Atmospheres To avoid explosion, do not operate this product in an explosive atmosphere.

AUDIO INPUT

Number/type: 2 stereo unbalanced
Connectors: Two 3.5mm stereo mini connectors
Impedance: 10K Ohms unbalanced
Max level: +6 dBm

AUDIO OUTPUT

Number/type: 1 Balanced Stereo (may be used in unbalanced configuration)
Connector: 5 Position mini Phoenix
Impedance: 50 ohms
Maximum Level: 600 ohms: +12 dBm Balanced / +6 dBm Unbalanced
Hi – Z: +14 dBm Balanced / +8 dBm Unbalanced

SYNC

Input level: 2.0 Vp-p to 5.0 Vp-p
Output level: 5.0 Vp-p into Hi-Z, 2.5 Vp-p into 75 ohm
Input Impedance: 475 ohms
Output impedance: 75 ohms
Polarity: Positive or negative
Horizontal frequency: 15 kHz - 200 kHz
Vertical frequency: 30 Hz - 150 Hz

CONTROL

Automatic operation: Detects signal on “B” channel (jumper “AUTO” to “SW” on control connector)
Remote control: Control system or push-button Switch (maintained closure between “SW” and “GND” on control connector)
Front panel: Momentary push-button Switch
Connectors: 3 Position pluggable screw terminal

POWER

Power: 9 VAC / DC, 50/60 Hz: 8 – 14 VDC, 9 VAC
Power Supply included.
Mounting: 1/2 rack or under table (includes under table brackets, 1/2 rack mount ordered separately.
Enclosure Type: Metal
Size: 8.5" W x 5.5" D x 1.5" H
Approvals: UL / CE

TECHNICAL SPECIFICATIONS

VIDEO INPUT

Number/type: 2 VGA / SVGA / XGA / SXGA / UXGA / RGBHV / RGSB / RGB / RsGsBs
Connectors: Two, 15 pin HD female
Level (nominal): Analog 0.7 Vp-p
Level (maximum): 2 Vp-p
Impedance: 75 ohms

EQUALIZED VIDEO OUTPUT

Number/type: 1 VGA / SVGA / XGA / SXGA / UXGA / RGBHV / RGSB / RGB / RsGsBs
Connectors: 5 female BNC's (RGBHV)
Bandwidth: 400 MHz @ -3 dB
100' cable 180 MHz @ +/-0.5dB, Gain LOW
150' cable 150 MHz @ +/-0.5dB, Gain HIGH
Level (nominal): Unity / User adjustable via HI / LOW / OFF Jumper
Gain: HI = 125' to 175', LOW = 60' to 125', OFF = 0' to 60'
Impedance: 75 ohms
Design Cable: West Penn WP8255 or equal

LOCAL VIDEO OUTPUT

Number/type: 1 VGA / SVGA / XGA / SXGA / UXGA / RGBHV / RGSB / RGB / RsGsBs
Connectors: One 15 pin HD female
Bandwidth: 320MHz @ -3dB
Gain: Unity (buffered)
Impedance: 75 ohms

AUDIO

Bandwidth: 20 Hz to 20 kHz (+/-0.05 dB)
THD + Noise: 0.01% @ 20 kHz at rated Max Output S/N >98 dB
Noise Floor: < 98 dB
Stereo separation: -90 dB @ 1 kHz

INTRODUCTION

The Table Navigator, from FSR, is the perfect solution for the classroom, church or boardroom where 2 computer and audio inputs need to be switched and sent to display devices which are located way more than 25 feet. Computer video signals quickly lose color and clarity after about 25 feet. In addition, audio signals easily pick up noise if they are not balanced.

The Table Navigator solves both of these problems and more in one easy to install package.

The Table Navigator combines an A/B auto switch, an ultra high bandwidth line driver and an active audio balancer into one easy to install package. The unit also features user selectable cable equalization, a fully buffered local monitor output, remote switch operation via a contact closure and greater than 400MHz of bandwidth.

It also functions as a universal interface when connected to any FSR seamless switcher, allowing for one central connection point for composite, S-Video component video and RGB signals.

The Table Navigator may be mounted under a table, podium or shelf with the included mounting bracket. An optional rack kit allows it to be mounted in a standard 19" rack.

If this Table Navigator is mounted under the table or lectern, a more convenient way to hookup a laptop (or equivalent device) would be to use the T-3U Table Box with the pull out cable. This arrangement provides the convenience of the table top box with the advanced electronics of the Navigator.

SETUP and INSTALLATION

Front view

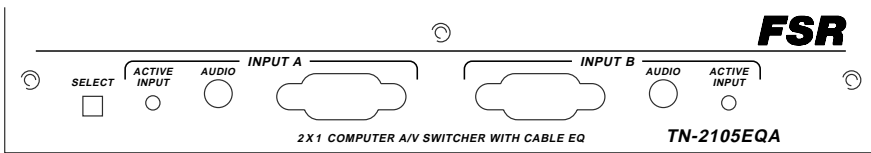

Connect laptop or similar device to the front of the unit. Laptops must be switched to dual output or external video output mode (see computer manual)

Rear view

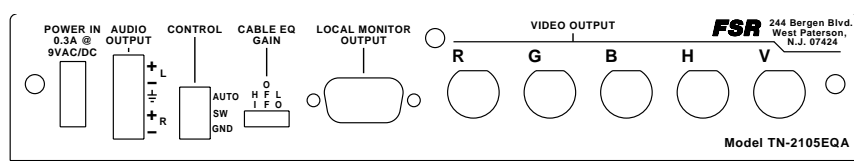

The 5 BNC output cable, 9 VAC power supply leads and audio leads should be prewired prior to completing the steps below. **Do not plug in the power supply until all wiring is completed.**

Connect the 5 BNC female connectors to the 5 BNC male output cable leading to the projector or monitor.

Connect the audio output cables to the captive screw terminals labeled "Audio Out". The appropriate wiring configuration for balanced and unbalanced connections is shown on the next page. Connect the Computer's video and audio outputs to Input A and B as shown in the installation diagram.

Set the cable equalization jumpers for optimum performance at the desired cable length (OFF=0-60', LO=60-125', HI=125-175').

Connect the 9 VAC power supply output to the Power In connector

Confirm proper video and audio operation before mounting the CI - 5UT.

Use the supplied brackets to mount the CI - 5UT to the underside or topside of the table.

Perform the final operational check.

MOUNTING DETAIL

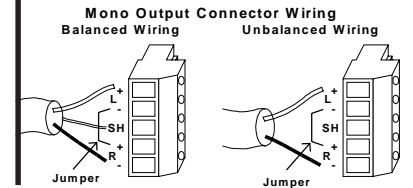
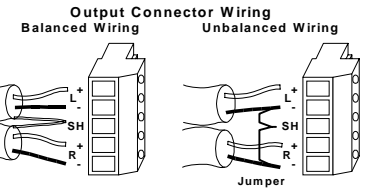
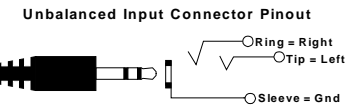
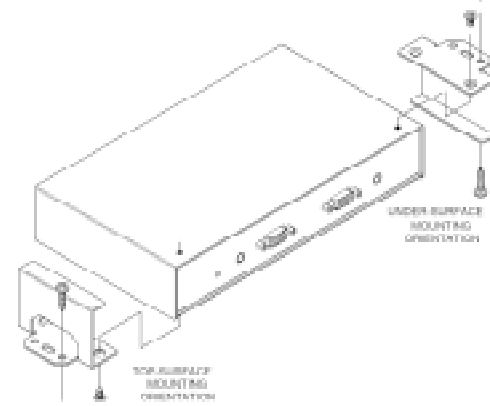

TYPICAL INSTALLATION

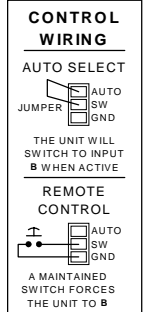
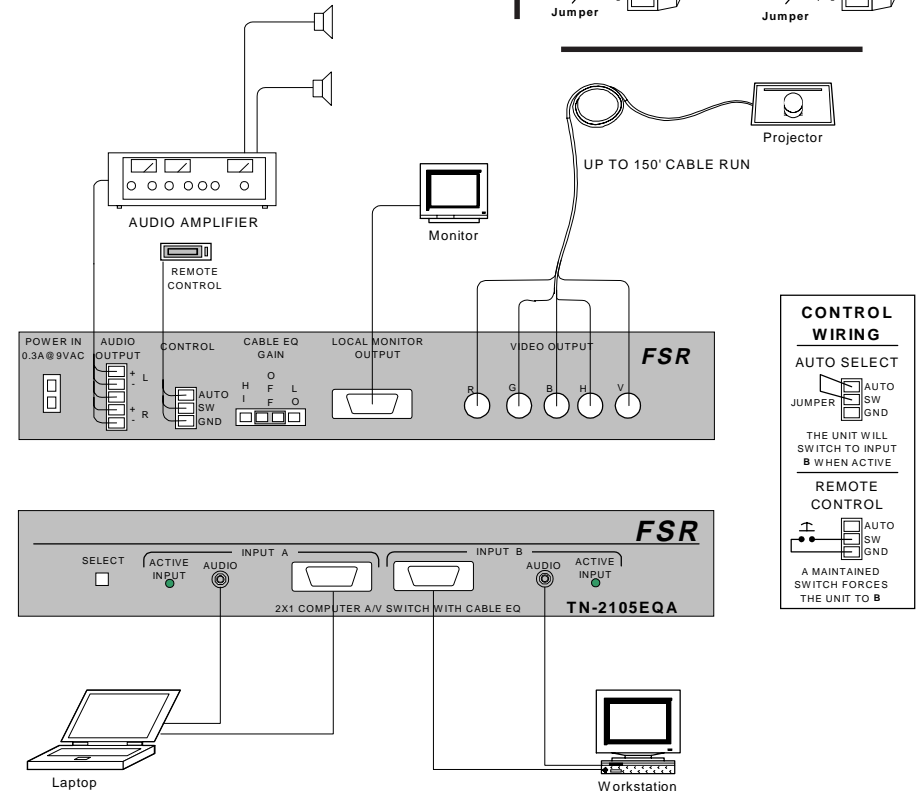

2 X 1 COMPUTER SWITCHER TYPICAL APPLICATION