

FX-2000

owner's manual



DELMHORST[®]
INSTRUMENT CO.

WHEN ACCURACY IS THE POINT.[™]

TABLE OF CONTENTS

- 2 FX-2000 Features
- 3 Before You Begin
- 3 Using the Meter In The Portable Mode
- 3 Check Calibration
- 4 Change the Set-Point
- 5 To Operate The Backlight
- 5 To Reset Meter
- 5 Testing Baled Hay
- 6 Testing in the Windrow
- 8 To Check Stored Readings
- 8 Factors Affecting Your Reading
- 9 Range of Moisture Content
- 9 Hay Temperature
- 10 Curing
- 10 Density
- 10 Use of Preservatives
- 11 Sample Size
- 11 Using the Meter For Continuous Monitoring
- 12 To Install The #1986 Bale Sensor
- 13 Installation on an Inline or Center Line
Small Square Baler
- 13 Installation on a Large or Mid-size Baler
- 13 Installation on a John Deere Round Baler
- 14 Installation on a New Holland or Case RBX
Round Baler
- 14 Installation on all other Round Balers
- 15 Using the Meter in the Continuous Mode
- 15 About Your Readings
- 16 Care of Your Meter
- 16 Warranty
- 17 Service For Your Meter

DELMHORST FX-2000

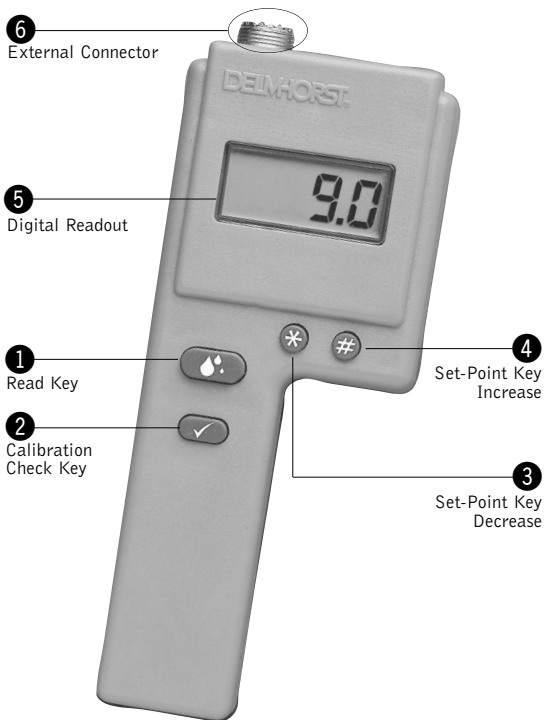

FX-2000 FEATURES

- ▶ 6% to 40% moisture range (starting with serial number 19569) Dual mode - portable or continuous (on-the-go monitoring)
- ▶ Digital readout- On-screen statistics
- ▶ Built-in calibration check
- ▶ Ergonomic case design
- ▶ Includes (1) 9-volt battery
- ▶ Three year warranty

BEFORE YOU BEGIN

Key Functions

- 1 Read Key - Reads the percent moisture content value %MC when the meter is in the portable mode. Turns the meter on in the continuous mode.
- 2 Calibration Check Key - When pressed with the read key checks the meter calibration. It also displays the number of readings in memory (up to 100), the average, and the highest stored reading. It also clears the memory. Turns the meter off in the continuous mode.
- 3 Set-Point (Decrease) Key - Allows you to decrease the set-point to a lower value. Acts as an arrow (scroll) key when pressed after the set-point key to decrease the set-point value in 1% increments.
- 4 Set-Point (Increase) Key - Displays the current set-point. Acts as an arrow (scroll) key to increase the set-point value in 1% increments. Also operates the backlight in the portable mode.

When the battery is replaced, the meter displays its software version for one second and then turns itself off. After replacing the battery, you must reset the meter as described on page 3.

USING THE METER IN THE PORTABLE MODE:

Please read this section carefully. In the portable mode, the FX-2000 is powered by its 9v battery and has different functions than in the continuous mode.

CHECK CALIBRATION

- ▶ Remove the probe from the top of the meter.
- ▶ Press and hold the read button 1 and check button 2 simultaneously. Meter is in calibration if it displays "12" (± 0.2).





If you check the calibration and the display does not read "12," it is likely an indication of a low battery. If this occurs, replace the battery with a new one immediately. Continued use with a low battery may cause the meter to go out of calibration. If you have a fresh battery and the instrument still does not indicate an acceptable calibration, return it to DELMHORST for service. See **Service for Your Meter** section.

A hard Reset is required if after changing the battery, the display is frozen. This is sometimes caused by the interruption of contact between the battery and battery lead wire. Resolve this as follows:

Disconnect the battery. Press and hold the Read key for 15 seconds. Release the Read key. Press and hold the Check key for 15 seconds. Release the Check key.

Connect a fresh battery to the lead wire in a single action, making sure to align the poles properly and without interrupting contact. If the display remains frozen, repeat the procedure. If this procedure does not solve the problem, refer to the Service For Your Meter section.

CHANGE THE SET-POINT

- ▶ **To change the set-point value** press the set-point increase key . The meter will display the current set-point value.
- ▶ **To scroll forward** to a higher value, hold the set-point increase key  while the current value is displayed and scroll up to the set-point value desired.
- ▶ **To scroll backward** through the set-point values, press and release the set-point increase key . Within one second press and hold the set-point decrease key .
- ▶ **Continue to hold the set-point decrease key**  and the set-point value will decrease.
- ▶ **When scrolling in either direction**, release the button to stop at your desired set-point.

If the meter reads a %MC higher than that of the set-point, a buzzer will sound.

TO OPERATE THE BACKLIGHT

- ▶ Press and release the calibration check key ②. Within one second, press and hold the set-point increase key ④.
- ▶ Hold the set-point increase key ④ until the backlight turns on. The backlight will be activated and remain lit as long as the meter remains on. After the meter turns off, the backlight will also turn off.
- ▶ The backlight will remain activated while the meter is off and will light up when any function is activated.
- ▶ To deactivate the backlight, repeat the same steps taken to activate it.

If there are readings stored in memory, the meter will run through the check cycle while activating the backlight. If no readings are stored, it will display "0".

The backlight will be deactivated automatically when changing from the portable mode to the continuous mode.

Use of the backlight should be kept to a minimum to avoid draining the battery.

TO RESET METER

- ▶ Press and release the calibration check key ②.
- ▶ Within one second, press and hold the set-point decrease key ③.
- ▶ The meter will reset itself and display "222." It will also reset the set-point to 19% and clear all of the readings stored in memory.

Note: The meter will also reset itself if you change from the portable mode to the continuous mode.

TAKING A READING

Testing Baled Hay

- ▶ Connect the bale prod or H-4 handle to the external connector on the top of the meter ⑥.
- ▶ Insert the probe into the bale.
- ▶ Press the read key ①. The meter displays the %MC and stores the reading in memory if the key is released within two seconds. If you do not want to store the reading, press and hold the read key for more than two seconds or until the meter completes another read cycle.

Notes

- ▶ The bale prod is electrically insulated, except at the metal points near the tip. The moisture content measured represents the hay in contact with the tip of the prod only.
- ▶ Partially cured hay may have wide variations in moisture content throughout the bale. Readings should be taken in several different parts of the bale and the highest readings used as a guideline. The arrangement and compaction of hay fibers in a bale may have an effect on meter readings.
- ▶ If you are testing high density bales, we recommend using the H-4 handle with the 830-2 10" prod, 830-3 18" prod, or the 830-4 36" prod. Using the handle/prod combination eliminates excess stress on the instrument case that may occur when trying to insert the prod into a high density or large bale.
- ▶ When using the 36" prod, be sure to guide the prod into the bale with one hand while pushing on the H-4 handle.

Testing in the Windrow

There are three ways to test moisture content in the windrow:

Test A

- ▶ **Attach the #831 short pin prod** to the H-4 handle and connect the handle to the external connector on top of the meter.
- ▶ **Prepare a representative sample** by collecting hay from various parts of the windrow.
- ▶ **Place hay in a non-conductive container** (such as a 5 to 10 gallon plastic pail) and apply the short pin prod to the hay.
- ▶ **Press down on the electrode** to make firm contact with the hay sample.
- ▶ **Press the read key 1** and take a reading.
- ▶ **Mix the sample once again** and take at least two more readings. Use the highest readings.

Notes

- ▶ Whenever pressure is being applied on the electrode, be sure that the points of the electrode are touching nothing but the hay.
- ▶ Repeat the steps above if considerable variations are found in the meter readings. To reduce these variations, chop the hay, mix it thoroughly and take several readings by following the procedures above. This will make the moisture distribution in the sample more uniform.

Test B

- ▶ Attach the #831 short pin prod to the H-4 handle and connect the handle to the external connector on top of the meter.
- ▶ Apply the prod to the hay in the windrow.
- ▶ Press the read key **1** and take a reading.
- ▶ Make several tests on the hay exposed to the sun, then turn the windrow over and make an equal number of tests on the hay that had been closer to the ground. Use the highest readings.

Notes

- ▶ Make sure that the points of the electrode are not touching the ground. The electrode points should make contact with the hay only.

Test C

- ▶ Select up to five large, slower-drying stems from a section of the windrow.
- ▶ Place them one at a time across two adjacent points on the #831 short pin prod.
- ▶ The average of these stem readings should be about two to five points higher than the actual moisture content.

Notes

- ▶ Repeat these steps in different parts of the field and pay special attention to the areas where the hay is heaviest.
- ▶ The amount of variation found among windrow readings as well as the average stem moisture should be taken into consideration before the decision is made to start baling.

TO CHECK STORED READINGS

This feature allows you to view the total number of all accumulated readings, the average of those readings, and the highest stored reading.

- ▶ **To view the readings** press and release the calibration check button ②. First the meter displays the number of accumulated readings for one second, then the average of those readings for two seconds. Then it displays the highest stored reading for two seconds. The total "cycle" time is five seconds.
- ▶ **To erase all the accumulated readings**, hold the calibration check key ② for more than 5 seconds until the meter displays "0".
- ▶ **To keep the accumulated readings in memory**, release the calibration check key ② before the total cycle time is complete.

The meter will accumulate up to 100 readings. After all 100 readings are stored, it will not add new readings until the memory has been cleared. It will also continue to display the average of all 100 readings as a reminder that the memory is full.

Readings below 6% will be displayed as ".0". Those above 40% will be displayed as "99.9." Neither will be added to the accumulated readings or used in calculation of average or highest reading.

FACTORS AFFECTING YOUR READINGS

Because of the many variables that affect the electrical meter readings, the indicated moisture content should not be used as an absolute quantitative measurement. Meter readings are very useful guidelines for safe storability of hay.

Meter readings become more significant when they are considered in the light of the density of the bales, anticipated handling and storage, and prevailing climate conditions.

Range of Moisture Content

The FX-2000 is designed to test moisture in hay over a range of 6%-40%. Readings over 30% should be used only as a qualitative indication of high moisture content. Delmhorst moisture meters use the relationship existing between electrical conductivity and moisture content in hay. As moisture content increases, so does the conductivity.

Tests on hay at high moisture content, over 25%, are less accurate. This is mostly due to the variability in moisture distribution. The reduced level of accuracy in the high range does not significantly affect the usefulness of the meter, as a few high readings indicate that some action be taken to dry the hay to avoid spoilage or even self-combustion.

While it is important to note the average of several readings, it is even more important to note the high readings and the frequency at which they occur.

Hay Temperature

The FX-2000 has been calibrated at 80°F on various samples of different types of hay, mostly alfalfa, and on different cuttings and mixtures. The higher the temperature of the sample, the higher the meter readings will be. Temperatures lower than 80°F cause lower meter readings. The correction is approximately 1% point for every 20° difference. Refer to chart below:

Hay temperature	Add to reading	Subtract from reading
20°F/-7°C	3	--
40°F/ 5°C	2	--
60°F/15°C	1	--
80°F/30°C	0	0
100°F/40°C	--	1
120°F/50°C	--	2
140°F/60°C	--	3

Example

Meter reading: 22%
Temperature: 40°F/5°C
Moisture Content: 24% (22 + 2)

Curing

Before proper curing has taken place, wide variations in moisture content should be expected in both recently baled hay and hay in the windrow. These variations will be exposed by meter readings taken on different parts of the windrow or bale. **The higher the moisture range, the wider are the variations. The more curing has been allowed to take place, the greater uniformity in moisture distribution can be expected.**

The validity of the meter readings is closely related to the care spent in sampling the hay to be tested. Whether hay in the windrow or baled hay is tested, the number of tests made should be increased whenever the initial readings show considerable variations.

Density

The calibration of the moisture testers applies to bales of normal "average" density. Generally:

- ▶ Denser bales may yield readings 1-2% points higher.
- ▶ Looser bales tend to yield 1-2% point lower.
- ▶ Tests in stacks usually yield readings 2%-3% lower.
- ▶ Tests on grass hay may yield readings about 3% lower.

Baling should be done according to the lower meter reading.

When testing baled hay, drive the prod across the slices of the bale, not between them. This will ensure firmer and more uniform contact.

Use of Preservatives

Hay preservative or stabilizers may also have an affect on meter readings. Normally a bale of hay treated with preservative will read higher than a bale of the same hay that had not been treated. The readings typically increase by 2-4% points, and 24-48 hours after treatment, the readings between the bales tends to equalize.

Occasional higher readings may occur if, in addition to the effect of the increased conductivity due to the stabilizer, the bales tested also show an increase in temperature and "sweating." As the stabilizer becomes more thoroughly absorbed and the sweating subsides, the meter readings recede to the initial level and will continue to decrease, assuming that the bale becomes progressively dryer.

Sample Size

When testing baled hay, it is essential to take readings at several different points in the bale. Hay moisture may vary a great deal in the same bale. For example, at one point bale moisture may be 20% and at another over 35%.

More tests must be made whenever the variations among readings are greater. If there is a possibility of high moisture areas, samples from these locations should be taken. Areas of high moisture content will spoil, resulting in loss.

It is extremely important to note the high readings and the frequency at which they occur.

USING THE METER FOR CONTINUOUS MONITORING

The FX-2000 can be used for on-the-go-monitoring, powered by the 12v tractor battery. To install the meter and power supply:

- ▶ **Attach the red lead of the power cable to a positive (+) 12-volt supply point controlled by the ignition switch or attach it directly to the tractor battery.**
- ▶ **Ground the other lead.** A replaceable fuse protects the circuit.

The meter can also be powered independently of the tractor's electrical system by using a 12V, (Eveready 732 or equivalent) all-purpose battery.
- ▶ **Select a location in the cab** where the display can be easily viewed while baling. Install the stainless steel mounting loop and slide the meter onto the loop.
- ▶ **Connect the power cable to the meter.**

To install the #1986 bale sensor:

Installation on a conventional small square baler:

- ▶ **Locate a spot on either side of the bale chamber, approximately halfway up the side of the bale, 12" to 24" in from the rear of the chamber.** The sensor pad and crop diverter need to be located in the baler chamber as close to the plunger face as possible. The sensor must mount flat.

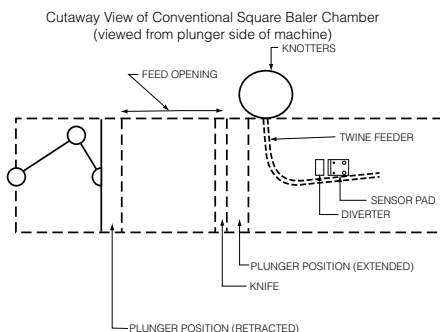

- ▶ **Tape the drilling template onto the location.** Make sure before drilling that when the bolts come through the side of the chamber that they do not interfere or touch any other pieces of metal. Using the size drill indicated, drill the mounting holes. File any burrs from the holes.
- ▶ **Install the sensor plate** with only the bale chamber wall between it and the backplate. The beveled edge of the insulation must face the plunger (opposite direction of bale movement).
- ▶ **Slide the coaxial cable lugs** between two flat washers. Secure all six nuts.
- ▶ **Secure the coaxial cable** at several points with tape or nylon ties so that it does not interfere with any moving parts of the baler.
- ▶ **Connect the coaxial sensor cable** to the meter.

Installation on an Inline or Center Line small square baler:

- ▶ Follow instructions for installation as above.

Top View of Inline or Centerline Small Square Baler

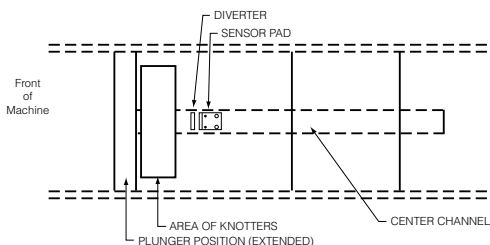

If placing the #1986 in the center channel you may need to cut an opening from the outside to be able to tighten down the nuts and secure the wire or use longer bolts and spacers.

Installation on a large or mid-size square baler:

When installing the #1986 on a large square baler, use the same guidelines as above. However, we recommend that you add a 1/4" thick piece of strap iron in front of the sensor's beveled edge. This will provide additional protection to the sensor plate.

Installation on a John Deere Round Baler:

- ▶ Locate a spot on the right hand side of the bale chamber, approximately 4.5" up from the bottom of the frame. The back edge of the sensor pad should be vertical so that the top rear corner of the sensor pad is approximately 3/8" forward from the rear edge of the upright frame tube.
- ▶ Follow instructions for installation as above.

Make sure that the beveled edge of the sensor pad is facing the front of the baler.

Installation on a New Holland or Case RBX Round Baler:

- ▶ Locate a spot on either side of the bale chamber.
- ▶ Your baler may contain a circular crop diverter plate. If it does, a notch must be cut out of the plate so that the sensor can rest against the chamber wall.

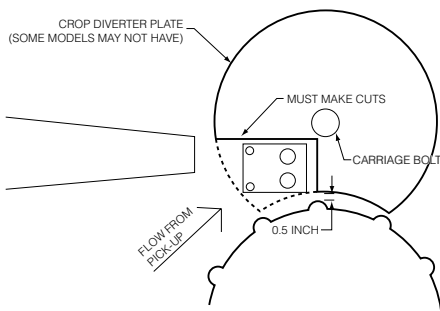

- ▶ Follow instructions for installation as above.

Make sure that the beveled edge of the sensor pad is facing the front of the baler.

Installation on all other Round Balers:

- ▶ Locate a spot on the side wall or tailgate, on either side of the baler, as low as possible to the bottom.

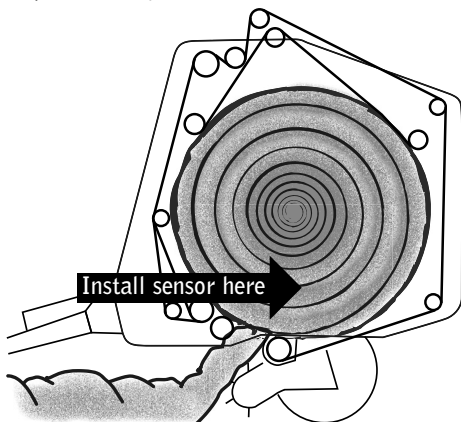

- ▶ Follow instructions for installation as above.

Be sure the sensor plate lies flat, with the beveled edge facing the pickup. The hay will begin to pass over the sensor when the bale is formed to approximately $\frac{1}{4}$ of full size.

USING THE METER IN THE CONTINUOUS MODE

- ▶ **Change the set-point** to the desired value as described on page 3. This must be done prior to turning the meter on.
- ▶ **Plug the external power supply** into the side of the meter. This will automatically put the meter in the continuous mode. Once power is supplied, the backlight will turn on and remain on until the external power is removed.
- ▶ **Turn the meter on** by pressing the read key **1**. A decimal point will display for a few seconds and then the meter will begin displaying the average and highest readings.

When the meter is operating continuously, it takes two readings every second, and accumulates eight readings before calculating their AVERAGE and HIGHEST values. After all eight readings have been taken, the meter will begin a new read cycle. **The meter displays the average as Axx.x and the highest as xx.x alternately for two seconds each.**

- ▶ **Turn the meter off** by either removing the external power supply or pressing and holding the calibration check key **2** until the meter is off. The backlight will stay on until the power supply is removed.

Notes

- ▶ **Start tractor before powering up meter.**
- ▶ **Disconnect meter before shutting down tractor.**

ABOUT YOUR READINGS

The meter reads between 6% and 40%. Readings below 6% are displayed as “.0” and are used in calculation as 7.5%; readings above 40% are displayed as “99.9” and are used in calculation as 45%.

Readings obtained while using the FX-2000 in its continuous mode are usually higher than those obtained when probing the bale by hand. Under normal conditions, expect the continuous readings to be around 2-4 points higher on average. Tests show this difference can be even greater, especially on large square bales, depending on overall conditions.

Do not be concerned that such differences exist. However, it is important to have a feel for what the difference is since conditions in the field change rapidly.

We recommend that you spot check the windrow and freshly made bales to give additional information with regard to these differences and to help establish the appropriate range for baling.

CARE OF YOUR METER

To keep your meter in good working order:

- ▶ Store your meter in a clean, dry place. The optional protective carrying case is an ideal storage place when the meter is not in use.
- ▶ Change the 9-Volt battery as needed. Continued use with a low battery may cause the meter to go out of calibration.
- ▶ Clean the meter and probe with any biodegradable cleaner. Use the cleaner sparingly and on external parts only. **Do not immerse the meter or any prod in water.**
- ▶ Remove the battery if the meter will not be used for one month or longer.

WARRANTY

Delmhorst Instrument Co., referred to hereafter as Delmhorst, guarantees its FX-2000 meter for three years from date of purchase and any optional electrodes against defects in material or workmanship for 90 days. If, within the warranty period of the FX-2000, you find any defect in material or workmanship return the meter following the instructions in the **Service for Your Meter** section. This limited warranty does not cover abuse, alteration, misuse, damage during shipment, improper service, unauthorized or unreasonable use of the meter or electrodes. This warranty does not cover batteries, pin assemblies, or pins. If the meter or any optional electrodes have been tampered with, the warranty shall be void. At our option we may replace or repair the meter.

Delmhorst shall not be liable for incidental or consequential damages for the breach of any express or implied warranty with respect to this product or its calibration. With proper care and maintenance the meter should stay in calibration; follow the instructions in the **Care of Your Meter** section.

UNDER NO CIRCUMSTANCES SHALL DELMHORST BE LIABLE FOR ANY INCIDENTAL, INDIRECT, SPECIAL, OR CONSEQUENTIAL DAMAGES OF ANY TYPE WHATSOEVER, INCLUDING, BUT NOT LIMITED TO, LOST PROFITS OR DOWNTIME ARISING OUT OF OR RELATED IN ANY RESPECT TO ITS METERS OR ELECTRODES AND NO OTHER WARRANTY, WRITTEN, ORAL OR IMPLIED APPLIES. DELMHORST SHALL IN NO EVENT BE LIABLE FOR ANY BREACH OF WARRANTY OR DEFECT IN THIS PRODUCT THAT EXCEEDS THE AMOUNT OF PURCHASE OF THIS PRODUCT.

The express warranty set forth above constitutes the entire warranty with respect to Delmhorst meters and electrodes and no other warranty, written, oral, or implied applies. This warranty is personal to the customer purchasing the product and is not transferable.

SERVICE FOR YOUR METER

If your meter is not working properly, replace the battery with a new one and check the calibration. If this does not resolve the problem please send your meter back to Delmhorst for repair. Go to www.delmhorst.com and click on Support and then download the Return Form. If you require further assistance please call 877-DELMHORST (335-6467) or 973-334-2557. E-mail info@delmhorst.com

For more than 65 years Delmhorst Instrument has been the leading manufacturer of high quality, US-made moisture meters and thermohygrometers. Today we offer a wide range of meters for applications including water damage restoration, construction, flooring, lumber/woodworking, paper, and agriculture.

DELMHORST[®]
INSTRUMENT CO.

WHEN ACCURACY IS THE POINT.[™]

51 Indian Lane East
Towaco, NJ 07082

(877)-DELMHORST
www.delmhorst.com
info@delmhorst.com