

FLIR MODEL DM285

Imaging Multimeter with IGM™ and Bluetooth®

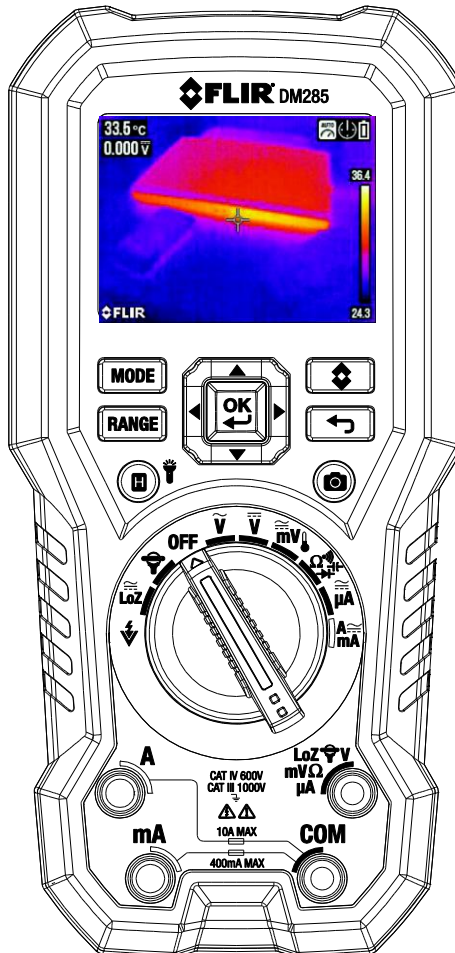

Table of Contents

1. ADVISORIES	5
1.1 Copyright	5
1.2 Quality Assurance	5
1.3 Documentation	5
1.4 Disposal of Electronic Waste	5
2. SAFETY	5
3. INTRODUCTION	8
3.1 Key Features	8
4. METER DESCRIPTION AND REFERENCE GUIDE	9
4.1 Front and Back Meter Descriptions	9
4.2 Function Switch Positions	10
4.3 Function Buttons and Navigation Pad	11
4.3.1 MODE Button Operation	11
4.3.2 OK Button/Navigation Pad Operation	12
4.4 Status Bar Display Icons	12
4.5 Other Display Icons	13
5. METER POWER	14
5.1 Powering the Meter	14
5.2 Auto Power OFF (APO)	14
5.3 Battery Type Selection	14
6. MENU SYSTEM	15
6.1 Using the Menu System	15
6.2 Main Menu Options	15
6.2.1 Image Mode Menu	15
6.2.2 Thermal Settings Menu	15
6.2.3 Gallery Mode	16
6.2.4 Advanced Functions Menu	16
6.2.5 General Settings Menu	16
7. GENERAL SETTINGS	17
7.1 General Settings Navigation	17
7.1.1 Diode SMART/CLASSIC	17
7.1.2 APO (Auto Power OFF)	17
7.1.3 Temperature units select °C/°F	17
7.1.4 Datalogger Sample Rate	17
7.1.5 Real-time Clock	17
7.1.6 Auto Hold / Data Hold	18
7.1.7 Coarse Resolution	18
7.1.8 Bluetooth® ON/OFF	18

7.1.9 Button-press tone ON/OFF	18
7.1.10 Battery type selection	18
7.1.11 Language selection	18
7.1.12 Delete all Datalogger readings	18
7.1.13 Delete all Stored Thermal Images	18
7.1.14 View HELP Screen	18
7.1.15 Viewing firmware, Bluetooth®, and Laser data	18
8. THERMAL IMAGING	19
8.1 Thermal Imager Basics	19
8.2 Thermal Imager Operation	20
8.3 Thermal Settings Menu (Color Palette, Emissivity, Laser Pointer, Crosshairs)	21
8.4 Image Mode Menu	22
8.5 Thermal Image Capture	22
8.6 Thermal Image Freeze (Data Hold)	22
8.7 Using the Multimeter in the IGM™ mode	22
9. MULTIMETER OPERATION	23
9.1 Auto/Manual Range Mode	23
9.2 Probe Connection Alert	23
9.3 Test Lead Holder Accessory	23
9.4 Out of Range Warning (OL)	24
9.5 Data Hold and Auto Hold	24
9.5.1 Data Hold Mode	24
9.5.2 Auto Hold Mode	24
9.6 Status Bar and Menu Icons	25
9.7 VFD (Low Pass Filter)	25
9.8 MAX-MIN-AVG mode	26
9.9 Peak Mode (AC Current and Voltage Measurements only)	26
9.10 Relative mode	26
9.11 Voltage and Frequency Measurements	27
9.12 Non-Contact Voltage Detector	28
9.13 Resistance Measurements	28
9.14 Continuity Test	29
9.15 Classic Diode Test	30
9.16 Smart Diode Test	31
9.17 Capacitance Measurements	32
9.18 Type K Temperature Measurements	33
9.19 Current and Frequency Measurements (A, mA, μ A)	33

9.19.1 Test Lead Current Measurements (A, mA, and μ A)	34
9.19.2 FLEX Clamp Adaptor Current and Frequency Measurements	36
10. DATALOGGER	37
10.1 Start Datalogging	37
10.2 Stop Datalogging	37
10.3 View Datalogger Sets	37
10.4 Delete Datalogger Sets	37
10.5 Transmit Datalogger Sets via Bluetooth®	37
11. BLUETOOTH® TRANSMISSION	38
12. APPENDICES	39
12.1 Emissivity Factors for Common Materials	39
12.2 Non-Uniformity Correction	39
12.3 Infrared Energy and Thermal Imaging Overview	40
13. MAINTENANCE	41
13.1 Cleaning and Storage	41
13.2 Battery Replacement	41
13.3 Fuse Replacement	41
13.4 Disposal of Electronic Waste	41
14. SPECIFICATIONS	42
14.1 General specifications	42
14.2 Thermal Imaging Specifications	43
14.3 Electrical Specifications	43
15. TECHNICAL SUPPORT	48
16. WARRANTIES	49

1. Advisories

1.1 Copyright

© 2017, FLIR Systems, Inc. All rights reserved worldwide. No parts of the software including source code may be reproduced, transmitted, transcribed or translated into any language or computer language in any form or by any means, electronic, magnetic, optical, manual or otherwise, without the prior written permission of FLIR Systems. The documentation must not, in whole or part, be copied, photocopied, reproduced, translated or transmitted to any electronic medium or machine readable form without prior consent, in writing, from FLIR Systems.

Names and marks appearing on the products herein are either registered trademarks or trademarks of FLIR Systems and/or its subsidiaries. All other trademarks, trade names or company names referenced herein are used for identification only and are the property of their respective owners.

1.2 Quality Assurance

The Quality Management System under which these products are developed and manufactured has been certified in accordance with the ISO 9001 standard.

FLIR Systems is committed to a policy of continuous development; therefore, we reserve the right to make changes and improvements on any of the products without prior notice.

1.3 Documentation

To access the latest manuals and notifications, go to the Download tab at:

<http://support.flir.com>. It only takes a few minutes to register online. In the download area you will also find the latest releases of manuals for our other products, as well as manuals for our historical and obsolete products.

1.4 Disposal of Electronic Waste



As with most electronic products, this equipment must be disposed of in an environmentally friendly way, and in accordance with existing regulations for electronic waste.

Please contact your FLIR Systems representative for more details.

2. Safety

Safety Notes

- Before operating the device, you must read, understand, and follow all instructions, dangers, warnings, cautions, and notes.
- FLIR Systems reserves the right to discontinue models, parts or accessories, and other items, or to change specifications at any time without prior notice.
- Remove the batteries if the device is not to be used for an extended period of time.

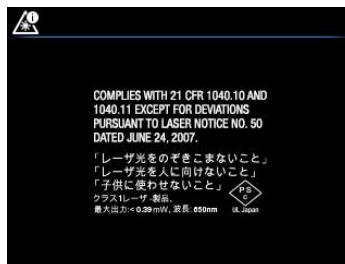

Warning Statements

- Do not operate the device if you do not have the correct knowledge. Incorrect operation of the device can cause damage, shock, injury or death to persons.
- Do not start a measuring procedure before you have set the function switch to the correct position. Failure to do so can cause damage to the instrument and can cause injury to persons.
- Do not change to the resistance mode when measuring voltage. This can cause damage to the instrument and can cause injury to persons.
- Do not measure the current on a circuit when the voltage increases to more than 1000 V. This can cause damage to the instrument and can cause injury to persons.
- You must disconnect the test leads from the circuit under test before you change the range. Failure to observe this warning can damage the instrument and cause bodily injury.
- Do not replace the batteries before you remove the test leads. This can cause damage to the instrument and can cause injury to persons.
- Do not use the device if the test leads and/or the device show signs of damage. Injury to persons can occur.
- Be careful performing measurements if the voltages are > 25 VAC rms or 35 VDC. There is a risk of shock from these voltages. Injury to persons can occur.
- Do not do diode, resistance or continuity tests before you have removed the power from capacitors and other devices under test. Injury to persons can occur.
- Be careful when performing voltage checks on electrical outlets. These checks are difficult because of the uncertainty of the connection to the recessed electrical contacts. You must not rely solely on this device when determining if the terminals are not “live”. There is a risk of electrical shock. Injury to person can occur.
- Do not touch expired/damaged batteries without gloves. Injury to persons can occur.
- Do not cause a short circuit of the batteries. This can cause damage to the instrument and can cause injury to persons.
- Do not put the batteries into a fire. Injury to persons can occur.
- Use extreme caution when the laser pointer is on.
- Do not point the beam toward anyone's eye or allow the beam to strike the eye from a reflective surface.
- Do not use the laser near explosive gases or in other potentially explosive areas.
- Refer to the CAUTION statement label (shown below) for critical safety information.



Cautions

Do not use the device in a manner not specified by the manufacturer. This can cause damage to the protection provided.

	This symbol, adjacent to another symbol or terminal, indicates that the user must refer to the user manual for further information.
	This symbol, adjacent to a terminal, indicates that, under normal use, hazardous voltages may be present.
	Double insulation.



UL listing is not an indication or a verification of the accuracy of the meter

3. Introduction

Thank you for selecting the FLIR DM285 True RMS Digital MultiMeter with IGM™ (Infrared Guide Measurement) and Bluetooth®. The DM285 can measure voltage up to 1000V AC/DC and includes Low-Z (low impedance), VFD (low pass filter), and Smart/Classic Diode modes. This device is shipped fully tested and calibrated and, with proper use, will provide years of reliable service.

3.1 Key Features

- 6000 count 2.8" digital TFT display with bargraph
- Built-in IGM™ Infrared imager (120x160 pixel) with laser pointer and crosshair targeting
- Capture fully radiometric thermal images where a temperature measurement is saved for each display pixel
- Bluetooth® connectivity
- Measures Voltage, Current (A, mA, μ A), Frequency, Resistance/Continuity, Diode (Classic and Smart modes), Capacitance, and Temperature
- Built-in non-contact voltage detector (NCV)
- Customizable via easy-to-use menu system
- Datalogger stores up to 40,000 readings in 10 sets
- Gallery mode for displaying stored screen shots and data log sets
- Automatic and Manual ranging
- Input over-voltage warning
- MIN-MAX-AVG memory
- PEAK MIN and PEAK MAX for ACA and ACV measurements
- Flex Clamp direct input
- On-screen programming menu navigation
- Variable-frequency drive VFD mode (low-pass filter)
- Low-Z (low impedance) mode
- Relative mode
- Data Hold and Auto Hold
- Auto Power OFF
- Safety Category Rating: CAT IV-600V, CAT III-1000V.
- Equipped with batteries, test leads, alligator clips, test lead storage/holder attachment, Type-K thermocouple, and Quick Start booklet.

4. Meter Description and Reference Guide

4.1 Front and Back Meter Descriptions

Fig. 4-1 Front View

1. Work Light and NCV detector area
2. LCD Display
3. Navigation/OK Buttons
4. MODE Button
5. RANGE Button
6. Data Hold/Work Light Button
7. Rotary Function Switch
8. Positive (+) Probe Input Jack for **A** (Current)
9. Positive (+) Probe Input Jack for **mA** (Current)
10. COM (-) Probe Input Jack
11. Positive (+) Probe Input Jack for all inputs except **A** and **mA**
12. Display Save Button
13. Cancel/Return Button
14. IGM™ Button
15. Test Lead holder attachment mounts
16. Thermal Imaging lens
17. Tripod mount (test lead holder attaches here also)
18. Tilt Stand/Battery compartment
19. Laser pointer lens
20. Lens cover slide control

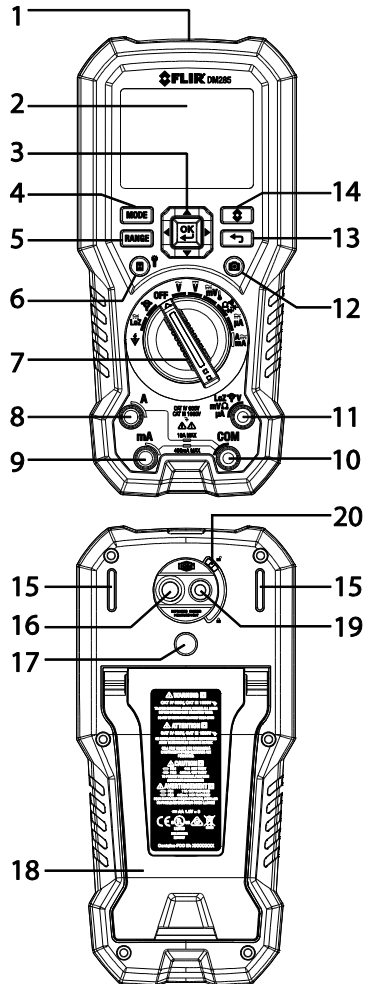

Fig. 4-2 Rear View

4.2 Function Switch Positions



















	Detect AC voltage through the non-contact sensor at the top of the meter
	Measure voltage through the probe inputs with a low-impedance load positioned across the inputs that stabilizes the measurement.
OFF	Meter is switched OFF and in full power-saving mode.
	FLEX Direct: Auxiliary channel for use with optional Flexible Current clamp or standard clamp adaptors when > 600A measurements are required. In this mode, the meter will display true rms ACA measurements from the connected device. Frequency (Hz) can be displayed by pressing the MODE button.
	Measure AC voltage (V) through the probe inputs.
	Measure DC voltage (V) through the probe inputs.
	Measure low voltage (mV) through the probe inputs. Use the MODE button to select AC/DC voltage.
	Measure temperature through the probe inputs using a thermocouple adaptor. Use the MODE button to select Temperature (see Section 6.2.2, Thermal Settings Menu , to select °C or °F unit of measure).
	Measure resistance, continuity, capacitance, or diode through the probe inputs. Use the MODE button to select the desired function.
	Measure µA current through the probe inputs. Use the MODE button to select AC or DC.
	Measure current through the probe inputs (A or mA). Use the MODE button to select AC or DC.

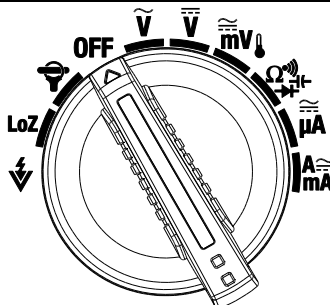







Fig. 4-3 Function Switch



4.3 Function Buttons and Navigation Pad

	Use to select a sub-function of the primary function. See Section 4.3.1, MODE Button Operation , for details
	From Auto range mode, short press to select Manual range mode. From Manual range mode, short press to change the range (scale). Long press to return to the Auto range mode
	Short press to open/close the Thermal Imager with IGM™ (Infrared Guided Measurement)
	OK button with arrow keypad allows you to confirm settings, navigate the menu system, and otherwise control the DM285 features and functions
	Press to exit modes or return from a menu screen (no function in normal mode)
	Short press to enter the Hold mode (display hold or auto hold as selected in the General Settings Menu (see Section 6.2.5, General Settings Menu and Section 7, General Settings). Long press to enable/disable the work light
	Display Save button. Short press to capture a fully radiometric thermal image or DMM screenshot. Images are saved to the device's file system accessible in Gallery mode. The thermal imager must be fully initialized (indicated by display of IR temperature measurement) before radiometric data can be captured

4.3.1 MODE Button Operation

Rotary Switch Position and Description	Sequence of operations
	Non-contact voltage detector No operation
	Low impedance ACV > DCV > Frequency
	Clamp adaptor ACA < > Frequency
	AC Voltage ACV < > Frequency
	DC Voltage No operation
	Milli-volts / Temperature ACmV > DCmV > Frequency > °C/°F
	Resistance/Continuity/Capacitance/Diode Resistance > Continuity > Capacitance > Diode
	AC/DC micro-amperes ACµA < > DCµA
	AC/DC amps or milli-amps ACA > DCA > Frequency ACmA > DCmA > Frequency

4.3.2 OK Button/Navigation Pad Operation

There are five (5) buttons arranged in a square that make up the Navigation pad, as shown in Figure 4-4.



Fig. 4-4 Navigation Pad

OK button (center) Access the main menu and select/change menu options

LEFT/RIGHT buttons: Navigate the menu system

UP/DOWN buttons: Navigate the menu system

4.4 Status Bar Display Icons













The Status Bar is located at the top of the display.



Fig. 4-5 Status Bar Display Icons

- L to R, row 1: Flex clamp icon/range, Laser, Relative, Continuity, Diode, VFD, LoZ, Work light, Bluetooth®, APO, Battery status
- L to R, row 2: Datalogger, Data Hold, Auto Hold, Auto Range.
- Additional display symbols are shown in the next section.

4.5 Other Display Icons

	Sensed voltage is > 30 V (AC or DC)
	Left: Non-contact Voltage detector icon (high sensitivity 80~1000V range) Right: Non-contact Voltage detector icon (low sensitivity 160~1000V range)
	Non-contact Voltage detector display alert when voltage is detected
	MAX (maximum), MIN (minimum), AVG (average) reading value displayed
	PEAK MAX and PEAK MIN value displayed
	Primary display (large digits)
	Secondary display (smaller digits)
	Emissivity setting
	AC current or voltage
	DC current or voltage
	Bar Graph Measurement Indicator
	Bar Graph OL (overload) Indicator

5. Meter Power

5.1 Powering the Meter

1. Set the function switch to any position to switch on the meter.
2. If the battery indicator  shows that the battery voltage is low, if one of the Low Battery screens appears (Fig. 5-1), or if the meter does not power on, replace the three (3) 'AA' batteries. See [Section 13.2, Battery Replacement](#). If using the Model TA04 charging system, please recharge the rechargeable battery.

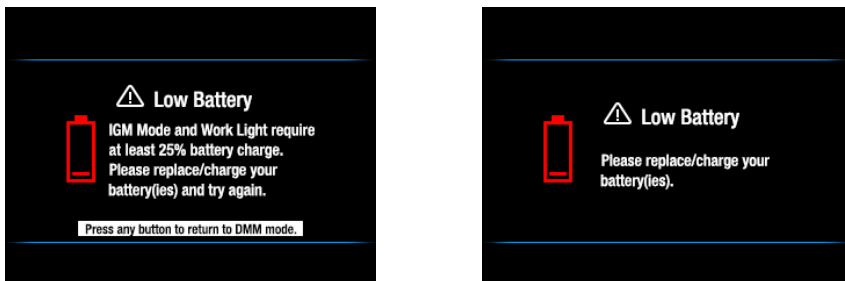

FIG. 5-1 Low Battery Alerts

5.2 Auto Power OFF (APO)

The meter enters sleep mode after a programmable period of inactivity, to customize this setting please see [Section 7.1.2, APO \(Auto Power OFF\)](#). The default time-out is 10 minutes. The time can be set to 1, 2, 5, or 10 minutes (select OFF to disable the APO). Twenty (20) seconds prior to entering APO mode, the meter beeps; at this point, press any button or turn the Rotary Switch to reset the APO timer.

5.3 Battery Type Selection

The user must enter the battery type (Lithium or Alkaline) in the General Settings menu before use. This allows the meter to display battery status as accurately as possible. Refer to [Section 7.1.10, Battery Selection](#).

6. Menu System

6.1 Using the Menu System

- Press **OK** to open the main menu, shown below:





Fig. 6-1 Main Menu

- Use the **Navigation Pad** left/right arrows to highlight an icon. From left to right the icons are *Image Mode*, *Imager Settings*, *Gallery (for viewing thermal images and data logs)*, *Advanced Menu*, and *General Settings*.
- Press **OK** to open a menu or to set an option ON or OFF. When an option is ON a blue dot will appear next its icon. In some cases, use the navigation arrows to select an option.
- Use the Return  button to exit menu levels and to return to the normal display mode.
- The mode of the meter dictates what icons are available for use.

6.2 Main Menu Options

6.2.1 Image Mode Menu

This Image mode icon  is only available in the thermal imaging mode. The Image mode has two options:

 **Image + DMM** mode (default): Display will show DMM data on the thermal images while in the thermal imaging mode.

 **Image-only** mode: Display shows thermal images only in the thermal imaging mode.

Press **OK** on the Image mode icon to open the menu and use the arrow buttons to select the desired option.

6.2.2 Thermal Settings Menu

Press **OK** at the Thermal Settings icon  to access the following options: *Color Palette*, *Emissivity*, *Laser pointer ON/OFF*, and *Cross hairs ON/OFF* shown top to bottom in **Fig. 6-2** below. Refer to [Section 8.3, Thermal Settings Menu](#) (*Color Palette*, *Emissivity*, *Laser Pointer*, and *Crosshairs*) for detailed information.

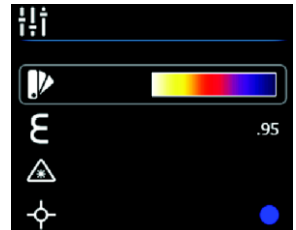





Fig. 6-2 Thermal Settings Menu



6.2.3 Gallery Mode

In Gallery  mode, view stored thermal images and logged readings.

- Press **OK** at the Gallery  icon. The display will show rows of stored thermal images (100 max.) on the lower area of the display and data logs (up to 10 sets with 40,000 readings max.) on the upper area.
- Use the up/down arrows to step between image and reading log areas.
- Use the left/right arrows to scroll through data logs or images.
- Press **OK** to open a reading log or a thermal image.
- Press **OK** again on a thermal image to bring up icons that will permit you to delete the image, transmit the images via Bluetooth®, and to resize the image to full screen.
- Press **OK** again on a data log set to bring up icons that will permit you to delete the log or to transmit the log via Bluetooth®.
- For More detailed information, [see Section 7.1.11, Delete all Datalogger Readings](#), [Section 7.1.12, Delete all Stored Thermal Images](#), [Section 8.5, Thermal Image Capture](#), and [Section 10, Datalogger](#)

6.2.4 Advanced Functions Menu

Press **OK** at the Advanced Functions menu icon  to access the functions listed below. Highlight a function using the arrow buttons and then press **OK** to activate it. Refer to the dedicated section for each as listed below for detailed information:

-  VFD (low pass filter), see [Section 9.7, VFD \(Low Pass Filter\)](#)
-  MAX-MIN-AVG Readings, see [Section 9.8, MAX-MIN-AVG mode](#)
- **(P)** Peak mode, see [Section 9.9, Peak mode](#)
- **Δ** Relative mode, see [Section 9.10, Relative mode](#)
-  Datalogger, see [Section 10, Datalogger](#)

6.2.5 General Settings Menu

1. Press **OK** to open the main menu.
2. Press **OK** at the Settings icon  to access the options.
3. See next section for detailed information on the General Settings mode.

7. General Settings

7.1 General Settings Navigation

Under General Settings, the user can customize a variety of features.



1. Press **OK** to open the Main Menu
2. Scroll to the Settings  icon and press **OK** to open the Settings menu (see Fig. 7-1)
3. Press **OK** on a menu item and customize the item per the sections below
4. Use the  button to exit screens and to return to the normal mode
5. A blue dot next to an option indicates that an option is ON



Fig. 7-1 General Settings Menu

7.1.1 Diode SMART/CLASSIC

 Press **OK** to toggle SMART/CLASSIC diode modes. see [Section 9.15, Classic Diode](#), and [Section 9.16, Smart Diode](#). Use the **OK** button to choose the desired setting.

7.1.2 APO (Auto Power OFF)



Press **OK** to open the sub-menu. Scroll to OFF, 1, 2, 5, or 10 minutes for the Auto Power OFF timer and press **OK** to select. Press  to exit the menu.

7.1.3 Temperature units select °C/°F



Press **OK** to toggle the temperature units °C and °F.

7.1.4 Datalogger Sample Rate



Press **OK** to access the selector. Use the arrow buttons to select the desired datalogger sampling rate from 1 ~ 99 seconds. Press **OK** to confirm.

7.1.5 Real-time Clock



Press **OK** to open the date/time setting screen. Use the arrow buttons to scroll through the date and time fields and to select the current date and time. Press **OK** to confirm.

7.1.6 Auto Hold / Data Hold



Auto hold: Use the **OK** button to toggle ON (blue dot) and OFF. For more information, see [Section 9.5, Data Hold and Auto Hold](#).

7.1.7 Coarse Resolution



Coarse Resolution (*C.r.* ON/OFF) allows the user to reduce the resolution to remove distracting, quickly changing least significant digits. Use the **OK** button to toggle ON (blue dot) and OFF. This function is for Voltage function only. The range and resolution for the Voltage function will be adjusted as follows when Coarse Resolution is enabled:

- 600.0mV → 600mV
- 6.000V → 6.00V
- 60.00V → 60.0V
- 600.0V → 600V
- 1000V → 1000V
- Default: OFF

7.1.8 Bluetooth® ON/OFF



Press **OK** to toggle Bluetooth® ON/OFF (default is ON). See [Section 11, Bluetooth®](#)

7.1.9 Button-press tone ON/OFF



Press **OK** to toggle the button-press tone ON/OFF

7.1.10 Battery type selection

Press **OK** to select Alkaline or Lithium AA batteries in use.

7.1.11 Language selection

Press **OK** to open the menu. Scroll to the desired language and press **OK**. Press  to exit

7.1.12 Delete all Datalogger readings



Press **OK** to delete all datalogger records. The meter will ask for confirmation.

7.1.13 Delete all Stored Thermal Images



Press **OK** to delete all saved thermal images. The meter will ask for confirmation.

7.1.14 View HELP Screen







Press **OK** to view FLIR support contact information.

7.1.15 Viewing meter component information



Press **OK** to view meter component firmware version information and Laser data:

-  Meter firmware version
-  Lepton® camera interface firmware version
-  Bluetooth® firmware version
-  Laser data

8. Thermal Imaging

8.1 Thermal Imager Basics

In the Thermal Imaging mode, the user can measure a targeted surface's temperature by detecting the energy emitted by the surface under test. Color variations reflect temperature variations. See [Section 12.3, Infrared Energy and Thermal Imaging Overview](#) for in-depth information. The laser pointer and display cross hairs assist in targeting.

Press the IGM button to open the Thermal Imager. In **Fig 8-1** the meter is set to color palette IRON. Select other palettes in the Thermal Settings Menu (refer to [Section 8.3, Thermal Settings Menu](#)).

Fig. 8-1 Thermal Image Example



1. **IR Temperature measurement** represents the temperature of the spot sensed. Note that while the imager initializes, dashes will display.
2. **MultiMeter Measurement**
3. **Cross hairs** for targeting spots
4. **Thermal image** (120 x 160 pixels)
5. **Main Menu** (Press OK to open this menu)
6. **Lowest reading** measured in the current frame
7. **Thermal scale** shows the range of colors for the thermal image. The lighter the color, the warmer the temperature; the darker the color, the cooler the temperature.
8. **Highest reading** measured in the current frame.
9. **Status Icon Bar** (see [Section 4.4, Status Bar Display Icons](#) for definitions)

8.2 Thermal Imager Operation

To customize the Thermal Imager, refer to [Section 8.3, Thermal Settings Menu](#). For basic operation, follow these steps:

1. Set the function switch to any position.
2. Press the **IGM** button  to switch the Thermal Imager ON. Point the thermal imaging lens (back of meter) toward an area to test.
3. The display will show the temperature in the upper left hand corner of the targeted area.
4. In the Thermal Imaging mode, use the laser pointer and display cross hairs for targeting. These can be switched ON or OFF in the Thermal Settings Menu.
5. In the Thermal Imaging mode, the meter continues to operate normally as a MultiMeter. In the Thermal Imaging mode, view electrical measurements and functions on the left side of the display. If desired, the meter can be set to image-only mode in the Image Mode menu, see [Section 8.4, Image Mode Menu](#).
6. The Distance to Spot ratio for the imager is 30:1 meaning that the measurement spot is 30 times smaller than the distance from meter to spot (at a distance of 30", the meter 'sees' a target spot of 1"). **See Fig. 8-2.**
7. The thermal imager's resolution is 120 x 160 pixels and its FOV (Field of View) is 50 degrees (top view) by 38.6 degrees (side view) see **Fig. 8-3 (a) and (b)**.

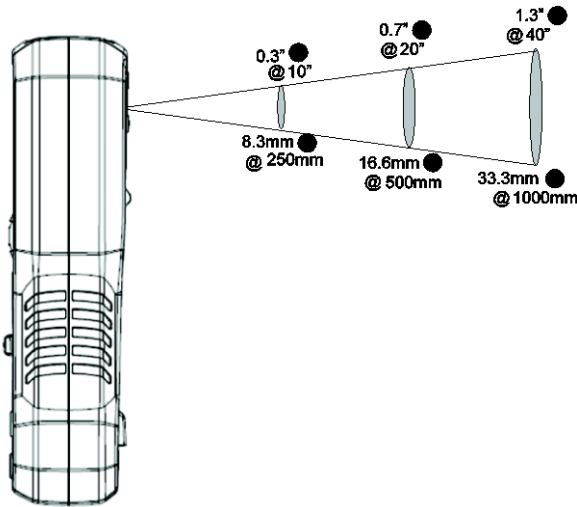

Fig. 8-2 Distance-to-Spot ratio 30:1

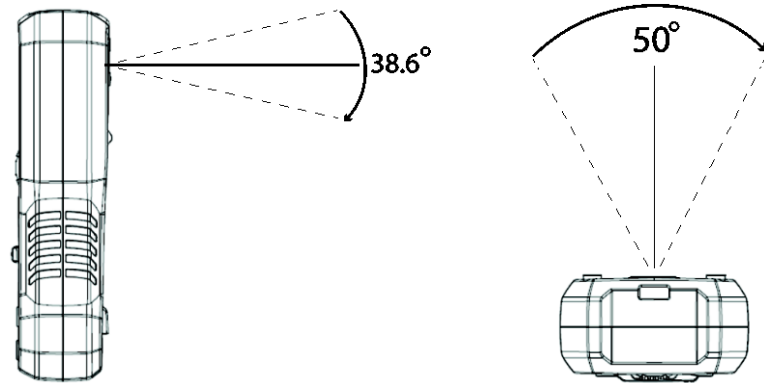



Fig. 8-3 (a) Field of View – side view **Fig. 8-3 (b)** Field of View - top view

8.3 Thermal Settings Menu (Color Palette, Emissivity, Laser Pointer, Crosshairs)

1. Press **OK** to open the main menu
2. Scroll to the Thermal Settings  icon and press **OK**
3. Refer to the Thermal Settings screenshot and details below

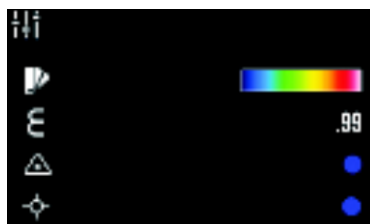





Fig. 8.4 Thermal Settings Menu

Icon	Description	Use
	Color Palette	Press OK to step through the display color palettes (Iron, Rainbow, or Gray).
	Emissivity	Press OK and then use up/down arrows to scroll to a preset (0.95, 0.85, 0.75, or 0.65) or to the fine-tuning icon ε . To fine tune, press OK at the fine-tuning icon and use the arrow buttons to set the value, press OK to confirm. The range is 0.10 to 0.99 in 0.01 steps.
	Laser pointer	Press OK to toggle the laser pointer ON (blue circle) or OFF
	Cross hairs	Press OK to switch the cross hairs ON or OFF

8.4 Image Mode Menu

The Image Mode menu  allows you to select:





Image + DMM mode  where you can view DMM data superimposed on the thermal images or:

Image-only mode  where DMM measurements are removed from the thermal images

8.5 Thermal Image Capture

Short press the Display Save button  to store a displayed thermal image (or DMM screen) to the meter's internal memory. Up to 100 images can be stored. Saved thermal images are fully radiometric (each pixel includes temperature measurement data). Note that the imager must be fully initialized (indicated by display of IR temperature measurement instead of dashes) before radiometric data can be captured. To view radiometric data within captured thermal images, copy the images to a PC and view using *FLIR Tools*.

To view stored images:

1. Press **OK** to open the Main Menu
2. Press **OK** at the Gallery  icon
3. Use the left/right arrow buttons to scroll through the images (note that the datalogging records are located here also, on the upper display area)
4. Press **OK** to open a selected image
5. Press **OK** to open a menu permitting recycling of image, full-screen sizing, and transmission of image via Bluetooth®
6. Use the RETURN  button to exit screens and to return to the normal operating mode

8.6 Thermal Image Freeze (Data Hold)

In Data Hold mode, the displayed reading or thermal image is frozen. To enter/exit Data Hold mode, press the **H** (hold) button. In Hold mode, the  indicator appears.

8.7 Using the Multimeter in the IGM™ mode

The Multimeter can be used as described in [Section 9, Multimeter Operation](#) while the IGM™ mode is active. Multimeter readings, status bar icons, and operational modes such as PEAK, RELATIVE, and MIN-MAX-AVG can be viewed directly on top of the thermal image when **IMAGE + DMM** mode is selected in the Image Mode menu (see [Section 6.2.1, Image Mode Menu](#)).

9. MultiMeter Operation

Caution: Before operating the device, you must read, understand, and follow all instructions, dangers, warnings, cautions, and notes.





Caution: When the meter is not in use, the function switch should be set to the OFF position.

Caution: When connecting the probe leads to the device under test, connect the COM (negative) lead before connecting the positive lead. When removing the probe leads, remove the positive lead before removing the COM (negative) lead.

9.1 Auto/Manual Range Mode

In Auto range mode, the meter automatically selects the most appropriate measurement scale. In Manual range mode, the desired range (scale) can be adjusted by the user.

Auto range mode is the default mode of operation. When a new function is selected with the function switch, the starting mode is Auto range and the  indicator is displayed.

1. To enter Manual range mode, short press the  button. To change the range, press the  button repeatedly until the desired range is displayed.
2. To return to the Auto range mode, long press the  button until the Auto Range  indicator is again displayed.

9.2 Probe Connection Alert

For voltage or current measurements (except μA), with the tests leads incorrectly connected to the meter (or not connected at all), one of the error displays shown below will appear:

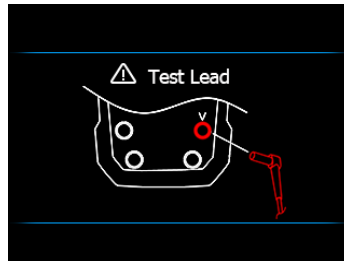
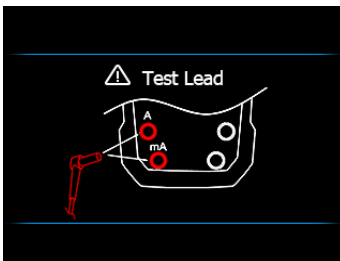

9.3 Test Lead Holder Accessory

If desired, connect the supplied Test Lead Holder to the rear of the meter. The Test Lead Holder connects to the back of the meter (to items 1 and 5 as shown in Fig. 4-2 in [Section 4, Meter Description and Reference Guide](#)).



9.4 Out of Range Warning (OL)

If the input is over/under the full-scale range in Manual range mode, or if the signal has exceeded the maximum/minimum input in Auto range mode, 'OL' is displayed.

9.5 Data Hold and Auto Hold

The meter has two HOLD modes: classic Data Hold and Auto Hold. To select Data Hold or Auto Hold as the default, please use the General Settings menu ([see Section 6.2.5, General Settings Menu](#) and [Section 7, General Settings](#)). Refer to the paragraphs below for instructions on using the Hold modes.

9.5.1 Data Hold Mode

In Data Hold mode, the primary meter display freezes the last reading. To enter/exit Data Hold mode, short press the  (hold) button. In Hold mode, the  indicator appears.

9.5.2 Auto Hold Mode

In Auto hold mode, the secondary display freezes the last reading and the  icon appears.

The real-time reading appears on the primary display.

The held reading will not change unless the difference between the held reading and any new reading is > 50 digits.

The Auto hold function will capture a reading if the reading is > 1% full scale (trigger level) for Voltage, Current, and Capacitance. For Resistance, Diode, and Temperature the trigger is active as long as OL (over range).

To enter/exit Auto hold mode, short press the  (hold) button.

9.6 Status Bar and Menu Icons

The Status Bar is located at the top of the display.

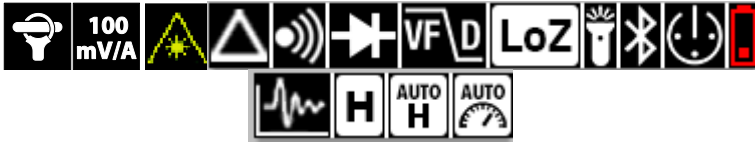

- L to R, row 1: Flex clamp icon/range, Laser, Relative, Continuity, Diode, VFD, LoZ, Work light, Bluetooth®, APO, Battery status
- L to R, row 2: Datalogger, Data Hold, Auto Hold, Auto Range.

There are 5 main options in the Menu bar. See [Section 6, Menu System](#).



- Image Mode (available in IGM™ mode only)
 - Thermal Settings (available in IGM™ mode only)
 - Gallery Mode (view stored screenshots and data logs)
 - Advanced Features Menu
 - General Settings
- Use the Left / Right buttons to move the cursor.
 - Press the **OK** button to select an option.
 - Up / Down buttons are not used for Menu bar operation.
 - If an option is disabled (grayed) it is not available for the currently active mode.





9.7 VFD (Low Pass Filter)

VFD eliminates high-frequency noise from AC current/voltage measurements using a low-pass filter. Access VFD through the Advanced Menu; see [Section 6.2.4, Advanced Functions menu](#).

1. Press **OK** at the VFD icon ; the blue dot next to the icon and the VFD display icon will appear
2. De-select the VFD mode by pressing **OK** again at the VFD icon.



9.8 MAX-MIN-AVG mode

Access MAX-MIN-AVG mode  through the Advanced Menu; see [Section 6.2.4, *Advanced Functions menu*](#). Press **OK** on this icon to begin recording and viewing the highest, lowest, and average readings.

1. A blue dot appears next to the icon when you select this mode.
2. The highest reading will be shown next to the MAX icon 
3. The lowest reading will be shown next to the MIN icon 
4. The average reading will be shown next to the AVG icon 
5. Press **OK** at this icon  in the Advanced Menu to exit this mode.

9.9 Peak Mode (AC Current and Voltage Measurements only)

Access Peak mode (**P**) through the Advanced Menu; see [Section 6.2.4, *Advanced Functions menu*](#). In Peak mode, the meter captures and displays the positive and negative ACA or ACV peak values. The Peak display values change only when higher/lower values are registered.

1. Press **OK** to show the Peak Max  and Peak Min  readings on the display.
2. Press **OK** to switch this mode OFF.

9.10 Relative mode

Access Relative mode () through the Advanced Menu; see [Section 6.2.4, *Advanced Functions menu*](#). Press **OK** on this icon to capture a reference reading which to compare subsequent measurements.

1. A blue dot appears next to the icon when you select this mode.
2. The reference value will be displayed next to the Relative icon.
3. The primary display will show the difference between the measured value and the stored reference.
4. Press **OK** at this icon to switch the Relative mode OFF.

9.11 Voltage and Frequency Measurements

1. Set the function switch to one of the following positions:
 - $\overline{\overline{V}}$ (VDC) or \widetilde{V} (VAC) for high voltage measurements.
 - $\overline{\overline{mV}}$ (milli-volts) for low voltage measurements (use MODE to select AC or DC).
 - **LoZ** for voltage measurements using the meter's low input impedance mode. The **LoZ** indicator will be displayed (use MODE to select AC or DC).
2. Insert the black probe lead into the negative COM terminal and the red probe lead into the positive terminal.
3. For **mV** and **LoZ** measurements use the **MODE** button to select AC or DC measurement:
 - The \sim indicator will be displayed for AC measurements.
 - The \equiv indicator will be displayed for DC measurements.
4. Connect the probe leads in parallel to the part under test.
5. Read the voltage value on the display.
6. The Frequency (Hz) of the measured voltage is shown on the smaller, secondary display digits above the primary voltage reading. Press the **MODE** button to view only the Frequency reading.
7. Refer to [Section 6.2.4, Advanced Functions Menu](#), for details on VFD, MIN-MAX-AVG, Peak, and Relative modes of operation.

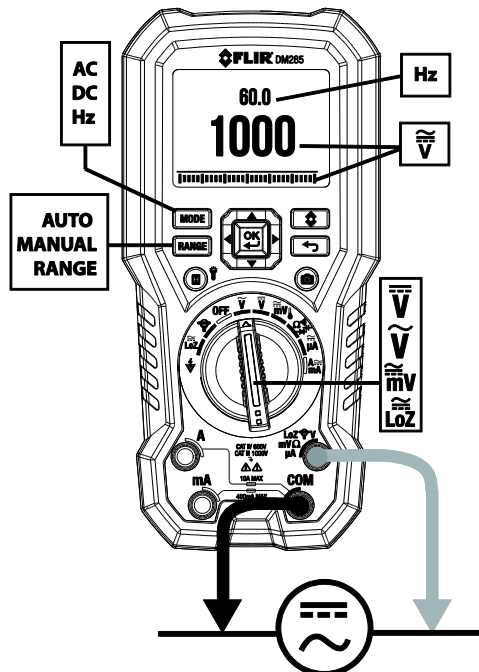



Fig. 9-1 Voltage and Frequency Measurements

9.12 Non-Contact Voltage Detector

1. Set the function switch to the NCV  position. See **Fig. 9-2**.
2. Be sure to remove the test leads from the meter when doing NCV tests.
3. Use the **RANGE** button to choose High (80~1000V) or Low (160~1000V) Sensitivity range (see the sensitivity icons in **Fig. 9-2**).
4. Position the top of the meter close to a source of voltage or electromagnetic field.
5. When the meter detects a voltage or electromagnetic field it emits a continuous tone and the displayed NCV icon will turn red and blink.

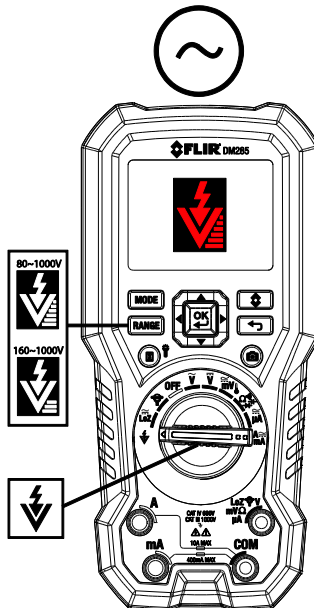



Fig. 9-2 Non-Contact Voltage Detector

9.13 Resistance Measurements

Warning: Do not perform diode, resistance or continuity tests before removing power from capacitors and other devices under test during a measurement. Injury to persons can occur.

1. Refer to **Fig. 9-3**. Set the function switch to the  position.
2. Use **MODE** to step to the Ω display if necessary.
3. Insert the black probe lead into the negative COM terminal and the red probe lead into the positive Ω terminal.
4. Touch the tips of the probe across the circuit or component under test.
5. Read the resistance value on the display.
6. Refer to [Section 6.2.4, Advanced Functions Menu](#), for details on MIN-MAX-AVG and Relative modes of operation.

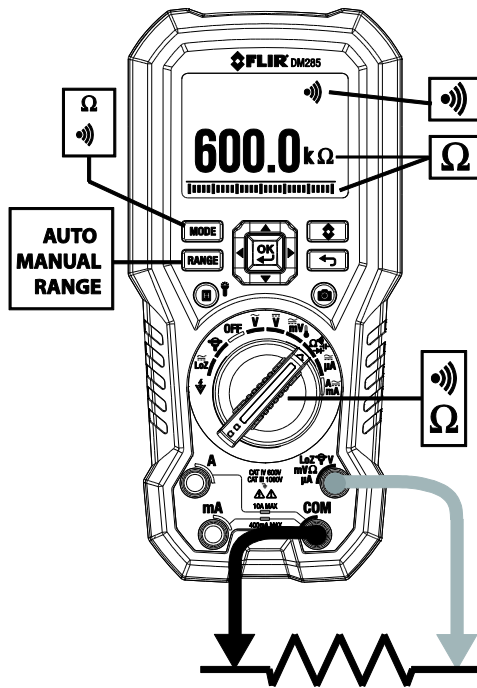



Fig. 9-3 Resistance and Continuity Measurements



9.14 Continuity Test

Warning: Do not perform diode, resistance or continuity tests before removing the power from capacitors and other devices under test during a measurement. Injury to persons can occur.

1. Refer to **Fig. 9-3**. Set the function switch to the Ω  position.
2. Use the **MODE** button to select continuity. The  indicator will be displayed.
3. Insert the black probe lead into the negative COM terminal and the red probe lead into the positive terminal.
4. Touch the tips of the probe across the circuit or component under test.
5. If the resistance is $< 20\Omega$ the meter beeps. If the resistance is $> 200\Omega$ the meter will not beep. $> 20\Omega$ but $< 200\Omega$ the beeping will stop at an unspecified point.

9.15 Classic Diode Test

Warning: Do not perform diode tests before removing the power to the diode or other devices under test during a measurement. Injury to persons can occur.

1. If not already selected, choose CLASSIC Diode test mode in the General Settings menu (see [Section 6.2.5, General Settings Menu](#) and [Section 7, General Settings](#)).
2. Set the function switch to the diode  position. Use the MODE button to select the diode test function. The diode indicator  will be displayed.
3. Insert the black probe lead into the negative COM terminal and the red probe lead into the positive terminal.
4. Touch the tips of the probe across the diode or semiconductor junction under test in one polarity (direction) and then in the opposite polarity as shown in **Fig. 9-4**.
5. If the reading is between 0.400 and 0.800V in one direction and OL (overload) in the opposite direction, the component is good. If the measurement is 0V in both directions (shorted) or OL in both directions (open), the component is bad.

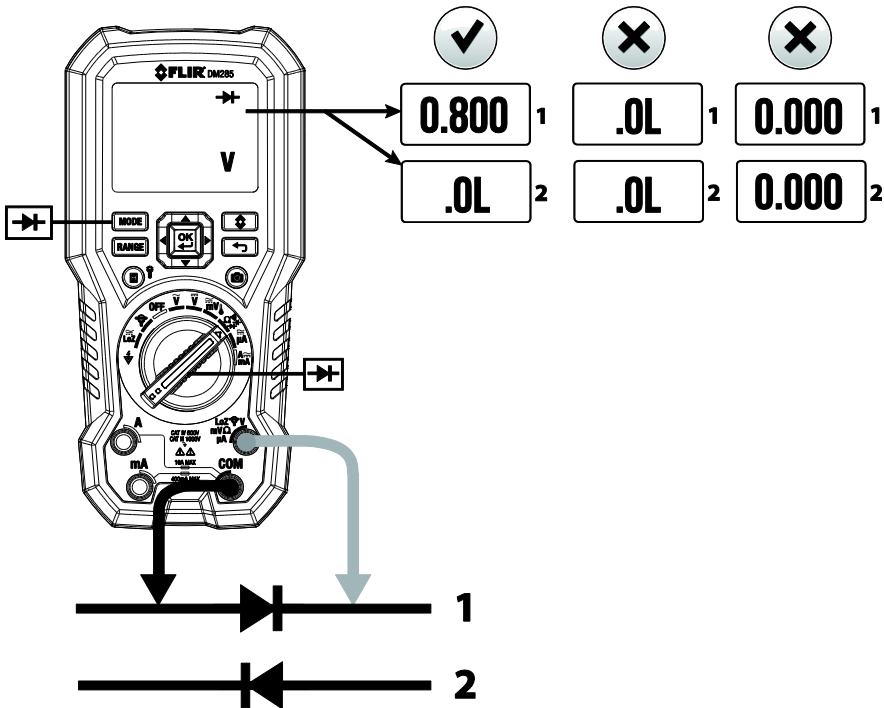



Fig. 9-4 Classic Diode Test

9.16 Smart Diode Test

Warning: Do not perform diode tests before removing the power from capacitors and other devices under test during a measurement. Injury to persons can occur.

1. If not already selected, choose SMART Diode test mode in the General Settings menu ([see Section 6.2.5, General Settings Menu](#) and [Section 7, General Settings](#)).
2. Set the function switch to the diode  position. Use the MODE button to select the diode test function. The diode indicator  will be displayed.
3. Insert the black probe lead into the negative COM terminal and the red probe lead into the positive Ω terminal.
4. Touch the tips of the probe across the diode or semiconductor junction under test.
5. If the reading is between $\pm 0.400 \sim 0.800V$, the component is good; BAD or O.L displays indicate a defective component.

NOTES: In SMART Diode mode the meter checks diodes using an alternating test signal sent through the diode in both directions. This allows the user to check the diode without having to reverse polarity manually. The meter display will show $\pm 0.400 \sim 0.800V$ for a good diode, 'BAD' for a shorted diode, and 'O.L' for an opened diode. See **Fig. 9-5** below:

Fig. 9-5 SMART Diode Test

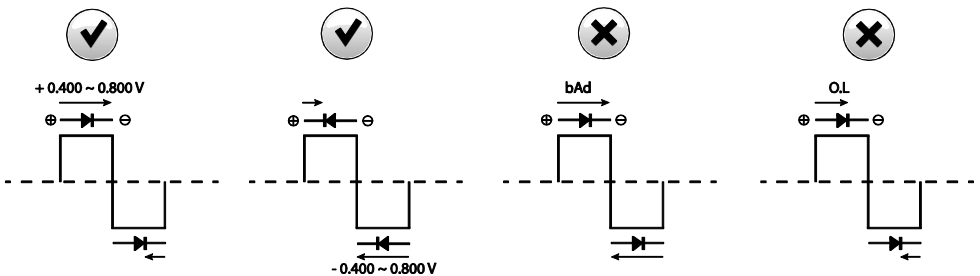

9.17 Capacitance Measurements

Warning: Do not perform capacitance tests before removing power to the capacitor or other devices under test during a measurement. Injury to persons can occur.

1. Set the function switch to the  position.
2. Use the **MODE** button to select the capacitance measurement. The F (Farad) unit of measure will be displayed.
3. Insert the black probe lead into the negative COM terminal and the red probe lead into the positive terminal.
4. Touch the tips of the probe across the part under test.
5. Read the capacitance value on the display.
6. Refer to [Section 6.2.4, Advanced Functions Menu](#), for details on MIN-MAX-AVG and Relative modes of operation.

Note: For very large capacitance values, it may take several minutes for the measurement to settle and the final reading to stabilize.

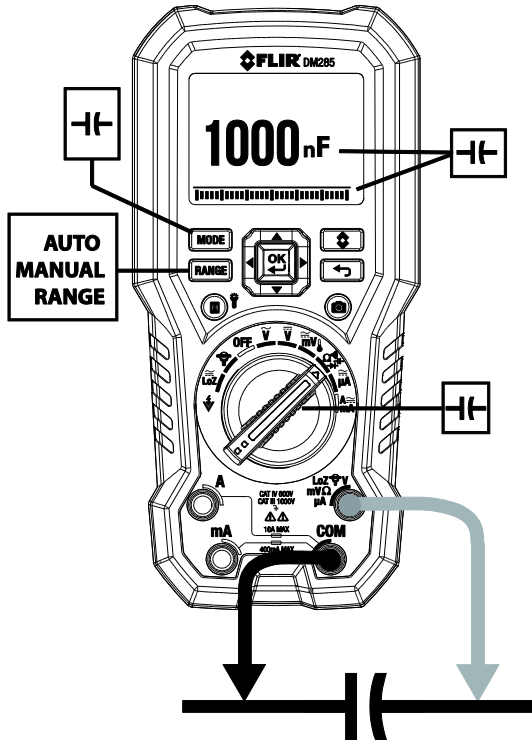

Fig. 9-6 Capacitance Measurements

9.18 Type K Temperature Measurements

1. Set the function to the Temperature t position.
2. Use the **MODE** button to select temperature measurement. The $^{\circ}\text{F}$ or $^{\circ}\text{C}$ unit will be displayed. To change from F to C or from C to F, please use the General Settings menu ([see Section 6.2.5, General Settings Menu](#) and [Section 7, General Settings](#)).
3. While observing the polarity, insert the thermocouple adapter into the negative terminal and the positive terminal.
4. Touch the tip of the thermocouple to the part under test. Keep the thermocouple tip on the part until the reading stabilizes.
5. Read the temperature value on the display.
6. To avoid electrical shock, disconnect the thermocouple adapter before turning the function switch to another position.

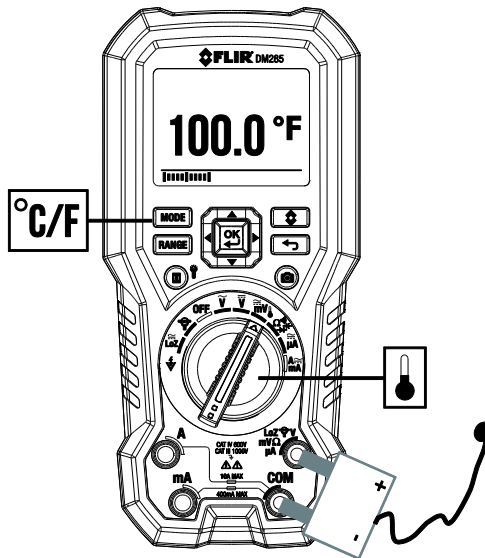

Fig. 9-7 Temperature Measurements

9.19 Current and Frequency Measurements (A, mA, μA)

For test lead current measurements, disconnect the part under test and connect the test leads in series with the part, see Fig. 9-8.



Fig. 9-8 Disconnected component

9.19.1 Test Lead Current Measurements (A, mA, and μA)

A \approx or \approx **μA**

1. For test lead measurements (A, mA, and μA), set the function switch to the **A** or **μA** position.
2. Insert the black probe lead into the negative COM terminal and the red probe lead into one of the following positive terminals:
 - **A** for high current measurements.
 - **mA** for lower current measurements.
 - **μA** for micro-amp measurements
3. Use the **MODE** button to select AC or DC measurement.
 - The \approx indicator will be displayed for AC measurements.
 - The \equiv indicator will be displayed for DC measurements.
4. Connect the probe leads in series with the part in accordance with **Fig. 9-8** and **Fig. 9-9** for 'A' measurements, **Fig. 9-10** for mA measurements, or **Fig. 9-11** for μA measurements.
5. Read the current and frequency values on the display. Frequency (Hz) is available only in the **A AC** and **mA AC** modes. Use the **MODE** to view the Frequency only.
6. Refer to [Section 6.2.4, Advanced Functions Menu](#), for details on VFD, MIN-MAX-AVG, Peak, and Relative modes of operation.

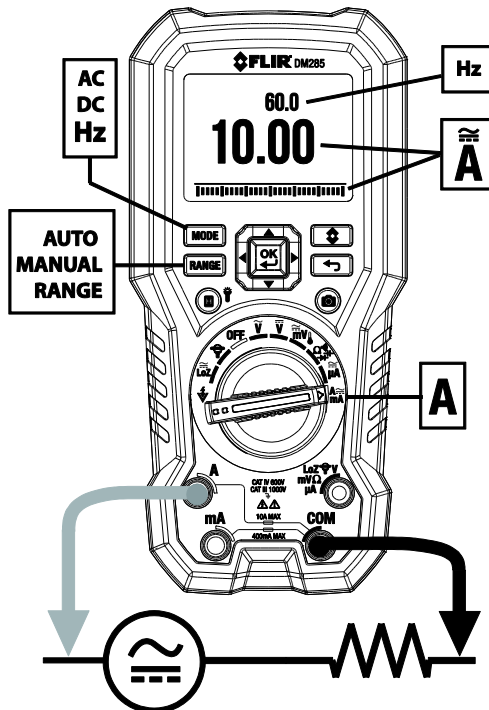

Fig. 9-9 High Current 'A' Measurements

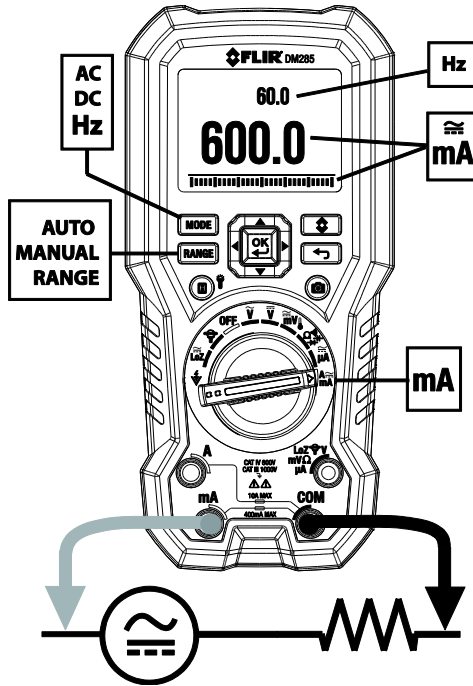

Fig. 9-10 mA Current Measurements

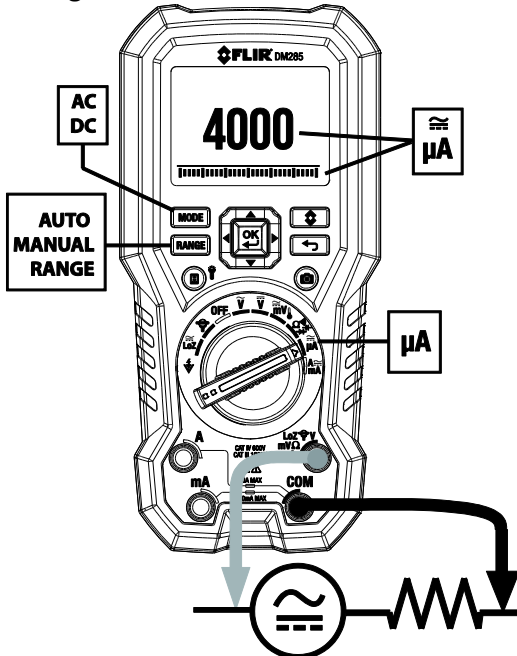



Fig. 9-11 μA Current Measurements

9.19.2 FLEX Clamp Adaptor Current and Frequency Measurements

FLIR Flex Clamp Adaptors (Models TA72 and TA74, for example) and other clamp adaptors connect to the DM285 to display current measurements made by a clamp adaptor.

1. Turn the function dial to the  position.
2. Connect a Clamp adaptor as shown in **Fig. 9-12**.
3. Set the Range of the Flex Clamp Adaptor to match the range of the DM285.
4. Use the RANGE button to select the range of the DM285 (1, 10, 100 mV/A). The selected range appears on the upper left side of the DM285 display.
5. Operate the Flex Clamp per instructions provided with the Flex Clamp meter.
6. Read the current measured by the Flex Clamp on the DM285 LCD. The frequency also appears on the DM285's secondary display.

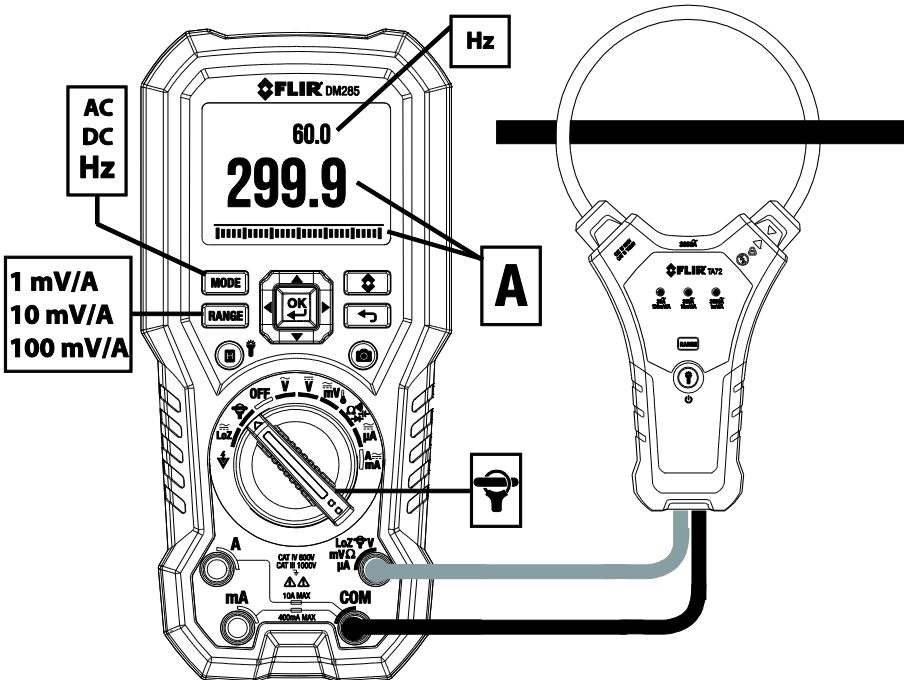



Fig. 9-12 FLEX Clamp Adaptor Application



10. Datalogger

Log up to 40,000 total readings over ten memory 'sets'. Each time the datalogger is started a new memory set is opened and the previous one is archived.

10.1 Start Datalogging

1. Press **OK** to access the main menu
2. Press **OK** at the Advanced Menu  icon
3. Press **OK** at the datalogger icon  to begin storing readings at the sample rate selected in the General Settings menu, see [Section 7.1.4, Datalogger Sample Rate](#). The datalogger display menu will appear while the logger is running

10.2 Stop Datalogging

1. Press **OK** to access the main menu
2. Press **OK** at the Advanced Menu  icon
3. Press **OK** at the datalogger icon  to stop logging. The datalogger display icon will switch off

10.3 View Datalogger Sets

1. Press **OK** to access the Main menu
2. Press **OK** at the Gallery  icon
3. Use the up arrow to move the cursor up to the log area of the display (the lower area is reserved for saved screenshot images). Scroll left/right to a data 'set' and press **OK** to open it. The list of recorded measurements for the set will appear.

10.4 Delete Datalogger Sets

1. With a datalog set open, press **OK**. Two icons will appear on the bottom of the display, one for transmitting data and one for deleting.
2. Scroll to the Trash icon and press **OK** to delete all of the readings in the selected set.
3. Delete data using the General Settings menu also, however using this method, all readings are deleted, not individual sets. See [Section 6.2.5, General Settings Menu](#) and [Section 7, General Settings](#).

10.5 Transmit Datalogger Sets via Bluetooth®

Transmit data logs to a remote device running the FLIR Tools software suite. Refer to the next section (Bluetooth® Transmission) for more information.

1. With a datalog 'set' open, press **OK**. Two icons will appear on the bottom of the display (one for transmitting or one for deleting).
2. Scroll to the transmission icon and press **OK** to begin transmitting all of the readings in the selected set.
3. Note that a micro USB port is located in the battery compartment. When connected to a PC the DM285 operates in the same manner as an external storage medium where you can drag and drop data logs and images from the meter to a PC.

11. Bluetooth® Transmission

When connected to a remote device running the **FLIR Tools** software suite, the DM285 (using the **METERLiNK**® protocol) can:



- Send readings for live display on the remote device
- Send saved data log files to the remote device
- Send saved screen images (thermal and DMM) to the remote device

When connected to a remote FLIR camera that supports Bluetooth® BLE (Bluetooth® Low Energy), the DM285 can:

- Send meter readings for live display on the camera screen

Download the **FLIR Tools** software suite at the link below:

<http://www1.flir.com/l/5392/2011-06-08/IUUE>

1. Any Bluetooth® BLE device running FLIR Tools can find and connect to the meter.
2. When successful communication between the meter and a remote device or FLIR camera is established, the Bluetooth® icon  appears on the meter display.
3. Open the Main menu (by pressing **OK**) and use the Gallery mode  to locate the stored images and data log sets. You can transmit Images and data log sets directly from the Gallery mode. For further information, refer to [Section 6.2.3, Gallery mode](#). See additional information provided in [Section 10, Datalogger](#).
4. Refer to the **FLIR Tools** help utility from within the software suite for detailed information and tutorials on using the **FLIR Tools** application.

Note: The Bluetooth® utility defaults to ON but can be disabled if desired in the General Settings menu (see [Section 7, General Settings](#)).

12. Appendices

12.1 Emissivity Factors for Common Materials

Material	Emissivity	Material	Emissivity
Asphalt	0.90 to 0.98	Cloth (black)	0.98
Concrete	0.94	Skin (human)	0.98
Cement	0.96	Leather	0.75 to 0.80
Sand	0.90	Charcoal (powder)	0.96
Soil	0.92 to 0.96	Lacquer	0.80 to 0.95
Water	0.92 to 0.96	Lacquer (matt)	0.97
Ice	0.96 to 0.98	Rubber (black)	0.94
Snow	0.83	Plastic	0.85 to 0.95
Glass	0.90 to 0.95	Timber	0.90
Ceramic	0.90 to 0.94	Paper	0.70 to 0.94
Marble	0.94	Chromium Oxides	0.81
Plaster	0.80 to 0.90	Copper Oxides	0.78
Mortar	0.89 to 0.91	Iron Oxides	0.78 to 0.82
Brick	0.93 to 0.96	Textiles	0.90

12.2 Non-Uniformity Correction

A non-uniformity correction (or NUC) is an image correction carried out by the camera software to compensate for different sensitivities of detector elements and other optical and geometrical disturbances¹.

The NUC is an automatic function that takes place periodically (approximately every 2-3 minutes) or whenever the inner core of the camera detects a $\pm 2^{\circ}\text{C}$ temperature change.

1. Definition from the imminent international adoption of DIN 54190-3 (Non-destructive testing – Thermographic testing – Part 3: Terms and definitions).

12.3 Infrared Energy and Thermal Imaging Overview

A thermal imager generates an image based on temperature differences. In a thermal image, the hottest item in the scene appears as white and the coldest item as black. All other items are represented as a gray scale value between white and black. The DM285 also offers color images to simulate hot (lighter colors) and cold (darker colors) temperatures.

It may take some time to get used to the thermal imagery. Having a basic understanding of the differences between thermal and daylight cameras can help with getting the best performance from the DM285.

One difference between thermal and daylight cameras has to do with where the energy comes from to create an image. When viewing an image with an ordinary camera, there has to be some source of visible light (something hot, such as the sun or other lighting) that reflects off the objects in the scene to the camera. The same is true with human eyesight; the vast majority of what people see is based on reflected light energy. On the other hand, the thermal imager detects energy that is directly radiated from objects in the scene.

This is why hot objects such as parts on engines and exhaust pipes appear white, while the sky, puddles of water and other cold objects appear dark (or cool). Scenes with familiar objects will be easy to interpret with some experience.

Infrared energy is part of a complete range of radiation called the electromagnetic spectrum. The electromagnetic spectrum includes gamma rays, X-rays, ultraviolet, visible, infrared, microwaves (RADAR), and radio waves. The only difference is their wavelength or frequency. All of these forms of radiation travel at the speed of light. Infrared radiation lies between the visible and RADAR portions of the electromagnetic spectrum.

The primary source of infrared radiation is heat or thermal radiation. Any object that has a temperature radiates in the infrared portion of the electromagnetic spectrum. Even objects that are very cold, such as an ice cube, emit infrared. When an object is not quite hot enough to radiate visible light, it will emit most of its energy in the infrared. For example, hot charcoal may not give off light, but it does emit infrared radiation, which we feel as heat. The warmer the object, the more infrared radiation it emits.

Infrared imaging devices produce an image of invisible infrared or “heat” radiation that is unseen by the human eye. There are no colors or “shades” of gray in infrared, only varying intensities of radiated energy. The infrared imager converts this energy into an image that we can interpret.

The **FLIR Infrared Training center** offers training (including online training) and certification in all aspects of thermography: <http://www.infraredtraining.com/>.

13. Maintenance

13.1 Cleaning and Storage

Wipe the housing with a damp cloth as needed. Use a high quality lens wipe to remove dirt or smudges from the meter lenses and display window. Please do not use abrasives or solvents to clean the meter housing, lenses, or display window.

If the meter is not to be used for an extended period, remove the batteries and store them separately.

13.2 Battery Replacement

The Battery symbol flashes with no 'bars' when the batteries have reached a critical level. The meter displays readings within specifications while the low battery indicator is on. The meter powers off before it displays an out of tolerance reading.

WARNING: To avoid electrical shock, disconnect the meter from any connected circuits, remove the test leads from the meter terminals, and set the function switch to the OFF position before attempting to replace the batteries.

1. Unscrew and remove the battery compartment cover.
2. Replace the four (4) standard AAA batteries, observing correct polarity.
3. If using the Model TA04 rechargeable lithium polymer battery system, please recharge the rechargeable battery.
4. Secure the battery compartment cover.

13.3 Fuse Replacement

The two fuses are accessed via the battery compartment. The fuses are rated:

- mA: 440 mA, 1000 V IR 10 kA fuse (Bussmann DMM-B-44/100).
- A: 11 A, 1000 V IR 20 kA fuse (Bussmann DMM-B-11A).
- Fuse kit PN: FS881, contains one of each fuse type.

13.4 Disposal of Electronic Waste

As with most electronic products, this equipment must be disposed of in an environmentally friendly way, and in accordance with existing regulations for electronic waste. Please contact your FLIR Systems representative for more details.

14. Specifications

14.1 General specifications

Maximum voltage:	1000 V DC or 1000 V AC RMS
Display Counts:	6000
Polarity Indication:	Automatic, positive implied, negative indicated
Over-range Indication:	OL
Measuring Rate:	3 samples per second
Power Requirements:	3 x 1.5 V AA alkaline/lithium batteries or optional Model TA04-KIT lithium polymer rechargeable battery system

Approximate battery life for thermal imager:

- 6 hours: Alkaline 'AA' Battery x 3
- 13 hours: Energizer L91 Lithium (Li/FeS₂) 'AA' Battery x 3
- 13 hours: Optional Rechargeable Battery: Li-Polymer; FLIR PN: TA04-KIT

Auto Power Off:	Default 10 minutes
Operating Temp/RH:	14°F to 86°F (-10°C to 30°C), < 85% RH 86°F to 104°F (30°C to 40°C), < 75% RH 104°F to 122°F (40°C to 50°C), <45% RH
Storage Temperature/RH:	-4°F to 140°F (-20°C to 60°C), 0-80% RH (without batteries)
Temperature Coefficient:	0.1 x (specified accuracy)/°C, < 64.4°F (18°C), > 82.4°F (28°C)
Operating Altitude:	6560' (2000m)
Calibration Cycle:	One year
Weight:	18.9 oz. (537g)
Dimensions:	(L x W x H) 7.9 x 3.7 x 1.9 in. (200 x 95 x 49mm)
Safety:	Complies with IEC 61010-1 CAT IV-600 V, CAT III-1000V

CAT	Application Field
I	Circuits not connected to mains.
II	Circuits directly connected to a low-voltage installation.
III	Building installation.
IV	Source of the low-voltage installation.

EMC: EN 61326-1
Pollution degree: 2
Drop protection: 9.8' (3m)

14.2 Thermal Imaging Specifications

IR Temperature Range	14 ~ 302°F (-10 ~150°C)
IR Temperature Resolution	0.1°F/C
Image Sensitivity	< or equal to 150mK (0.15°C)
IR Temperature Accuracy	3°C or 3% whichever is greater (> 77°F [25°C]) or 5°C (14~77°F [-10 to 25°C])
Emissivity	0.95 maximum (4 presets and a fine tuning feature)
Distance to Spot ratio	30:1
Response time	150ms
Spectral Response	8~14um
Scanning type	Continuous
Repeatability	0.5%
Image Detector	Lepton [®]
Field of View (FOV)	120 x 160 pixels (38° x 50°)
Color Palettes	Iron, Rainbow, and Greyscale
Stored thermal image radiometry	Fully radiometric
Laser type	Class 1
Laser power	< 0.4mW

14.3 Electrical Specifications

Accuracy is given as ± (% of reading + counts of least significant digit) at 23°C ± 5°C, with relative humidity < 80%

Temperature coefficient: 0.1 * (Specified accuracy) / °C, < 18°C, > 28°C

AC Function notes:

- ACV and ACA are ac coupled, true RMS.
- For all AC functions, LCD displays 0 counts when the reading < 10 counts.
- For square waves, accuracy is unspecified.
- For non-sinusoidal waveforms, additional accuracy for Crest Factor (C.F.):
 - Add 1.0% for C.F. 1.0 to 2.0
 - Add 2.5% for C.F. 2.0 to 2.5
 - Add 4.0% for C.F. 2.5 to 3.0
- Max. Crest Factor of Input Signal:
 - 3.0 @ 3000 counts
 - 2.0 @ 4500 counts
 - 1.5 @ 6000 counts
- Frequency Response is specified for sine waveform.

DC Voltage

Range	OL Reading	Resolution	Accuracy
6.000V	6.600V	0.001V	±(0.09% + 2D)
60.00V	66.00V	0.01V	
600.0V	660.0V	0.1V	
1000V	1100V	1V	

Input Impedance: 10MΩ

Overload Protection: AC/DC 1000V

AC Voltage

Range	OL Reading	Resolution	Accuracy	Freq. Response
6.000V	6.600V	0.001V	$\pm(1.0\% + 3D)$	45Hz ~ 500Hz
60.00V	66.00V	0.01V	$\pm(1.0\% + 3D)$	45Hz ~ 1kHz
600.0V	660.0V	0.1V		
1000V	1100V	1V		

Input Impedance: 10M Ω (< 100pF)

Overload Protection: AC/DC 1000V

Lo-Z Voltage (Auto AC & DC Detection)

Range	OL Reading	Resolution	Accuracy
600.0V DC & AC	660.0V	0.1V	$\pm(2.0\% + 3D)$
1000V DC & AC	1100V	1V	

Input Impedance: about 3k Ω

Frequency Response: 45 ~ 1kHz (Sine Wave)

Overload Protection: AC/DC 1000V

DC mV

Range	OL Reading	Resolution	Accuracy
600.0mV	660.0mV	0.1mV	$\pm(0.5\% + 2D)$

Input Impedance: 10M Ω

Overload Protection: AC/DC 1000V

AC mV

Range	OL Reading	Resolution	Accuracy
600.0mV	660.0mV	0.1mV	$\pm(1.0\% + 3D)$

Frequency Response: 45 ~ 1kHz (Sine Wave)

Input Impedance: 10M Ω

Overload Protection: AC/DC 1000V

DC Current

Range	OL Reading	Resolution	Accuracy
60.00mA	66.00mA	0.01mA	$\pm(1.0\% + 3D)$
400.0mA	660.0mA	0.1mA	
6.000A	6.600A	0.001A	$\pm(1.0\% + 3D)$

10.00A	20.00A	0.01A	
--------	--------	-------	--

The accuracy of measurements > 10A is unspecified.

Maximum measurement time: > 5A for max. 3 minutes with at least 20-minute rest time.

> 10A for max.30 seconds with at least 10-minute rest time.

Overload Protection: AC/DC 11A for A terminal. AC/DC 660mA for mA terminal.

AC Current

Range	OL Reading	Resolution	Accuracy
60.00mA	66.00mA	0.01mA	±(1.5% + 3D)
400.0mA	660.0mA	0.1mA	
6.000A	6.600A	0.001A	±(1.5% + 3D)
10.00A	20.00A	0.01A	

Accuracy of readings > 10A is unspecified.

Maximum measurement time: > 5A for max. 3 minutes with at least 20-minute rest time.

> 10A for max. 30 seconds with at least 10-minute rest time.

Frequency Response: 45 ~ 1kHz (Sine Wave)

Overload Protection: AC/DC 11A for A terminal. AC/DC 660mA for mA terminal.

DC µA

Range	OL Reading	Resolution	Accuracy
400.0µA	440.0µA	0.1µA	±(1.0% + 3D)
4000µA	4400µA	1µA	

Input Impedance: approx. 2kΩ

Overload Protection: AC/DC 1000V

AC µA

Range	OL Reading	Resolution	Accuracy
400.0µA	440.0µA	0.1µA	±(1.0% + 3D)
4000µA	4400µA	1µA	

Input Impedance: approx. 2kΩ; Frequency Response: 45 ~ 1kHz (Sine Wave)

Overload Protection: AC/DC 1000V

Resistance

Range	OL Reading	Resolution	Accuracy
600.0Ω	660.0Ω	0.1Ω	±(0.9% + 5D)
6.000kΩ	6.600kΩ	0.001kΩ	±(0.9% + 2D)

60.00kΩ	66.00kΩ	0.00kΩ	±(0.9% + 2D)
600.0kΩ	660.0kΩ	0.1kΩ	±(0.9% + 2D)
6.000MΩ	6.600MΩ	0.001MΩ	±(0.9% + 2D)
50.00MΩ	55.00MΩ	0.01MΩ	±(3.0% + 5D)

Overload Protection: AC/DC 1000V

Continuity

Range	OL Reading	Resolution	Accuracy
600.0Ω	660.0Ω	0.1Ω	±(0.9% + 5D)

Continuity: Built-in beeper sounds when measured resistance is less than 20Ω and is off when measured resistance is more than 200Ω. Between 20Ω and 200Ω the beeper will stop at an unspecified point.

Continuity Indicator: 2KHz Tone Buzzer; Response Time of Buzzer: < 500μsec.

Overload Protection: AC/DC 1000V

Diode

Range	OL Reading	Resolution	Typical Reading
1.500V	1.550V	0.001V	0.400 ~ 0.800V

Open Circuit Voltage: Approx. 1.8V; Overload Protection: AC/DC 1000V

Frequency

Range	OL Reading	Resolution	Accuracy
100.00Hz	100.00Hz	0.01Hz	±(0.1% + 2D)
1000.0Hz	1000.0Hz	0.1Hz	
10.000kHz	10.000kHz	0.001kHz	
100.00kHz	100.00kHz	0.01kHz	

ACV - Minimum Sensitivity (including LoZ ACV):

Range	5Hz ~ 1kHz	1kHz ~ 10kHz	>10kHz
600.0mV	60mV	100mV	Unspecified
6.000V	0.6V	6V	Unspecified
60.00V	6V	10V	Unspecified
600.0V	60V	100V	Unspecified
1000V	600V	Unspecified	Unspecified

ACA - Minimum Sensitivity:

Range	5Hz ~ 10kHz	>10kHz
60.00mA	10mA	Unspecified
600.0mA	60mA	Unspecified
6.000A	2A	Unspecified
10.00A	2A	Unspecified

FLEX Clamp Adaptor Current - Minimum Sensitivity:

Range	5Hz ~ 10kHz	>10kHz
30.00A	3.00A (0.300V)	Unspecified
300.0A	30.0A (0.300V)	Unspecified
3000A	300A (0.300V)	Unspecified

Minimum Frequency: 5Hz

Overload Protection: AC/DC 1000V

Capacitance

Range	OL Reading	Resolution	Accuracy
1000nF	1100nF	1nF	$\pm(1.9\% + 5D)$
10.00 μ F	11.00 μ F	0.01 μ F	$\pm(1.9\% + 2D)$
100.0 μ F	110.0 μ F	0.1 μ F	
1.000mF	1.100mF	0.001mF	
10.00mF	11.00mF	0.01mF	

Overload Protection: AC/DC 1000V

Flex Current

Range	OL Reading	Resolution	Accuracy
30.00A	33.00A	0.01A	$\pm(1.0\% + 3D)$
300.0A	330.0A	0.1A	
3000A	3300A	1A	

Accuracy does not include the accuracy of the Flexible Clamp Meter.

Frequency Response: 45 ~ 1kHz (Sine Wave)

Overload Protection: AC/DC 1000V

Type-K Temperature

Range	OL Reading	Resolution	Accuracy (DMM)	Accuracy (IGM)
-40.0°C to 400.0°C	$\leq -44.0^\circ\text{C}, \geq 440.0^\circ\text{C}$	0.1°C	$\pm (1\% + 3^\circ\text{C})$	$\pm (1\% + 5^\circ\text{C})$
-40.0°F to 752.0°F	$\leq -44.0^\circ\text{F}, \geq 824.0^\circ\text{F}$	0.1°F	$\pm (1\% + 5.4^\circ\text{F})$	$\pm (1\% + 9^\circ\text{F})$

The accuracy applies with a 30-minute warmup time and is unspecified when the Work Light is ON.

Accuracy does not include the accuracy of the thermocouple probe.

Accuracy specification assumes surrounding temperature stable to $\pm 1^\circ\text{C}$. For surrounding temperature changes of $\pm 2^\circ\text{C}$, rated accuracy applies after 2 hours.

Overload Protection: AC/DC 1000V.

NCV (Non-Contact Voltage Detector)

Voltage Range (High Sensitivity): 80V to 1000V

Voltage Range (Low Sensitivity): 160V to 1000V

Peak Max and Peak Min Hold

For ACV, AC mV, ACA, ACmA, AC μA , and Flex Current modes (unavailable for LoZ mode)

Specified accuracy ± 150 digits for < 6000 counts

Specified accuracy ± 250 digits for ≥ 6000 counts

VFD (Low Pass Filter)

For ACV, AC mV, ACA, ACmA, AC μA , and Flex Current modes (unavailable for LoZ mode)

Specified accuracy is for 45Hz ~ 65Hz

Specified accuracy $\pm 4\%$ for 65Hz ~ 400Hz

Accuracy is unspecified for $> 400\text{Hz}$

Cut-off Frequency: 800Hz ($\pm 100\text{Hz}$)

Work Light

Color Temperature: 4000-5000°K

Beam Angle: $\pm 20^\circ$

Light Output: 70 lumens, minimum

Power: 0.5 Watt RMS

15. Technical Support

Main Website	http://www.flir.com/test
Technical Support Website	http://support.flir.com
Technical support Email	TMSupport@flir.com
Service/Repair Support Email	Repair@flir.com
Support Telephone number	+1 855-499-3662 option 3 (toll-free)

16. Warranties

16.1 FLIR Test & Measurement Imaging Product 10-year/10-year Warranty

Congratulations! You (the “Purchaser”) are now the owner of a world-class FLIR Imaging Test and Measurement product. A qualifying FLIR Imaging Test and Measurement product (the “Product”) purchased either directly from FLIR Commercial Systems Inc. and affiliates (FLIR) or from an authorized FLIR distributor that Purchaser registers on-line with FLIR is eligible for coverage under FLIR’s industry-leading 10-10 Limited Warranty, subject to the terms and conditions in this document. This warranty only applies to purchases of Qualifying Products (see below) purchased after September 2015 and only to the original Purchaser of the Product.

PLEASE READ THIS DOCUMENT CAREFULLY; IT CONTAINS IMPORTANT INFORMATION ABOUT THE PRODUCTS THAT QUALIFY FOR COVERAGE UNDER THE 10-10 LIMITED WARRANTY, PURCHASER’S OBLIGATIONS, HOW TO ACTIVATE THE WARRANTY, WARRANTY COVERAGE, AND OTHER IMPORTANT TERMS, CONDITIONS, EXCLUSIONS AND DISCLAIMERS.

1. **PRODUCT REGISTRATION.** To qualify for FLIR’s 10-10 Limited Warranty, the Purchaser must fully register the Product directly with FLIR on-line at www.flir.com WITHIN Sixty (60) DAYS of the date the Product was purchased by the first retail customer (the “Purchase Date”). PRODUCTS THAT ARE NOT REGISTERED ON-LINE WITHIN Sixty (60) DAYS OF THE PURCHASE DATE OR PRODUCTS WHICH DO NOT QUALIFY FOR THE 10-10 WARRANTY WILL HAVE A LIMITED ONE YEAR WARRANTY FROM THE DATE OF PURCHASE.
2. **QUALIFYING PRODUCTS.** Upon registration, a list of thermal Imaging Test and Measurement Products that qualify for coverage under FLIR’s 10-10 Warranty can be found at www.flir.com/testwarranty
3. **WARRANTY PERIODS.** The 10-10 Limited Warranty has two separate periods of warranty coverage (the “Warranty Period”), depending on the Imaging Test and Measurement Product part:

Product components are warranted for a period of ten (10) years from the Purchase Date;

Thermal imaging sensor is warranted for a period of ten (10) years from the Purchase Date.

Any Product that is repaired or replaced under warranty is covered under this 10-10 Limited Warranty for one hundred eighty days (180) days from the date of return shipment by FLIR or for the remaining duration of the applicable Warranty Period, whichever is longer.

4. **LIMITED WARRANTY.** In accordance with the terms and conditions of this 10-10 Limited Warranty, and except as excluded or disclaimed in this document, FLIR warrants, from the Purchase Date, that all fully registered Products will conform to FLIR’s published Product specifications and be free from defects in materials and workmanship during the applicable Warranty Period. PURCHASER’S SOLE AND EXCLUSIVE REMEDY UNDER THIS WARRANTY, AT FLIR’S SOLE DISCRETION, IS THE REPAIR OR REPLACEMENT OF DEFECTIVE PRODUCTS IN A MANNER, AND BY A SERVICE CENTER, AUTHORIZED BY FLIR. IF THIS REMEDY IS ADJUDICATED TO BE INSUFFICIENT, FLIR SHALL REFUND PURCHASER’S PAID PURCHASE PRICE AND HAVE NO OTHER OBLIGATION OR LIABILITY TO BUYER WHATSOEVER.
5. **WARRANTY EXCLUSIONS AND DISCLAIMERS.** FLIR MAKES NO OTHER WARRANTY OF ANY KIND WITH RESPECT TO THE PRODUCTS. ALL OTHER WARRANTIES, EXPRESS OR IMPLIED, INCLUDING BUT NOT LIMITED TO IMPLIED WARRANTIES OF MERCHANTABILITY, FITNESS FOR A PARTICULAR PURPOSE (EVEN IF PURCHASER HAS NOTIFIED FLIR OF ITS INTENDED USE FOR THE PRODUCTS), AND NON-INFRINGEMENT ARE EXPRESSLY EXCLUDED FROM THIS AGREEMENT.

THIS WARRANTY EXPRESSLY EXCLUDES ROUTINE PRODUCT MAINTENANCE, AND SOFTWARE UPDATES. FLIR FURTHER EXPRESSLY DISCLAIMS ANY WARRANTY COVERAGE WHERE THE ALLEGED NONCONFORMITY IS DUE TO NORMAL WEAR AND TEAR OTHER THAN SENSORS, ALTERATION, MODIFICATION, REPAIR, ATTEMPTED REPAIR, IMPROPER USE, IMPROPER MAINTENANCE, NEGLIGENCE, ABUSE, IMPROPER STORAGE, FAILURE TO FOLLOW ANY PRODUCT INSTRUCTIONS, DAMAGE (WHETHER CAUSED BY ACCIDENT OR OTHERWISE), OR ANY OTHER IMPROPER CARE OR HANDING OF THE PRODUCTS CAUSED BY ANYONE OTHER THAN FLIR OR FLIR’S EXPRESSLY AUTHORIZED DESIGNEE.

THIS DOCUMENT CONTAINS THE ENTIRE WARRANTY AGREEMENT BETWEEN PURCHASER AND FLIR AND SUPERSEDES ALL PRIOR WARRANTY NEGOTIATIONS, AGREEMENTS, PROMISES AND UNDERSTANDINGS BETWEEN PURCHASER AND FLIR. THIS WARRANTY MAY NOT BE ALTERED WITHOUT THE EXPRESS WRITTEN CONSENT OF FLIR.

6. **WARRANTY RETURN, REPAIR AND REPLACEMENT.** To be eligible for warranty repair or replacement, Purchaser must notify FLIR within thirty (30) days of discovering of any apparent defect in materials or workmanship. Before Purchaser may return a Product for warranty service or repair, Purchaser must first obtain a returned material authorization (RMA) number from FLIR. To obtain the RMA number Owner must provide an original proof of purchase. For additional information, to notify FLIR of an apparent defect in materials or workmanship, or to request an RMA number, visit www.flir.com. Purchaser is solely responsible for complying with all RMA instructions provided by FLIR including but not limited to adequately packaging the Product for shipment to FLIR and for all packaging and shipping costs. FLIR will pay for returning to Purchaser any Product that FLIR repairs or replaces under warranty.

FLIR reserves the right to determine, in its sole discretion, whether a returned Product is covered under warranty. If FLIR determines that any returned Product is not covered under warranty or is otherwise excluded from warranty coverage, FLIR may charge Purchaser a reasonable handling fee and return the Product to Purchaser, at Purchaser's expense, or offer Purchaser the option of handling the Product as a non-warranty return. FLIR shall not be responsible for any data, images or other information that may be stored on the returned Product which was not included in the Product at the time of purchase. It is Purchaser's responsibility to save any and all data prior to returning the Product for warranty service.

7. **NON-WARRANTY RETURN.** Purchase may request that FLIR evaluate and service or repair a Product not covered under warranty, which FLIR may agree to do in its sole discretion. Before Purchaser returns a Product for non-warranty evaluation and repair, Purchaser must contact FLIR by visiting www.flir.com to request an evaluation and obtain an RMA. Purchaser is solely responsible for complying with all RMA instructions provided by FLIR including but not limited to adequately packaging the Product for shipment to FLIR and for all packaging and shipping costs. Upon receipt of an authorized non-warranty return, FLIR will evaluate the Product and contact Purchaser regarding the feasibility of and the costs and fees associated with Purchaser's request. Purchaser shall be responsible for the reasonable cost of FLIR's evaluation, for the cost of any repairs or services authorized by Purchaser, and for the cost of repackaging and returning the Product to Purchaser. Any non-warranty repair of a Product is warranted for one hundred eighty days (180) days from the date of return shipment by FLIR to be free from defects in materials and workmanship only, subject to all of the limitations, exclusions and disclaimers in this document.



Corporate Headquarters
FLIR Systems, Inc.
2770 SW Parkway Avenue
Wilsonville, OR 97070
USA
Telephone: +1 503-498-3547

Customer Support
Technical Support Website
Technical Support Email
Service and Repair Email
Customer Support Telephone

<http://support.flir.com>
TMSupport@flir.com
Repair@flir.com
+1 855-499-3662 option 3 (toll free)

Publication Identification No.: DM285-en-US
Release Version: AA
Release Date: October 2017
Language: en-US