

Instrument Security Procedures

Model:

Fluke 1750

Product Name:

1750 Power Recorder

Instrument Description:

Three-Phase Power Quality Recorder

Memory Description:

The 1750 Power Recorder has numerous internal non-volatile memory devices for holding instrument firmware and data:

- Dedicated flash memories store CPU boot firmware and Bluetooth radio embedded processor firmware.
- An internal Compact Flash memory card stores CPU and DSP application firmware, FPGA configuration, flash memory and configuration backup files, application log files, application data-capture files, and user-inserted annotations.
- A small microcontroller has firmware in on-chip flash memory.
- A battery-backed real-time clock stores date and time.
- A small EEPROM stores calibration constants and other instrument-specific data such as serial number, recorder name, recorder password, recorder Ethernet network address, recorder Ethernet MAC address, and Bluetooth Device address.

An externally accessible Secure Digital card socket provides additional non-volatile data storage when a card is present.

The 1750 Power Recorder has an internal uninterruptible power supply (UPS) that keeps the 1750 operating and maintains the values of otherwise volatile registers, FPGA configuration, static RAM, and dynamic RAM memories during power interruptions of up to five minutes. These memories contain copies of application firmware, FPGA configuration, and working data.

Memory Cleaning Instructions:

1. Connect to the 1750 Power Recorder using either Fluke Power Analyze (FPA) running on a compatible PC connected via Ethernet or Fluke Power View (FPV) running on the supplied PDA connected wireless via Bluetooth. If the 1750 is password protected, the user must know and enter the password before proceeding.

Note

For more information, detailed step-by-step procedures start on page 3.

2. Use the "Erase 1750 memory" feature of either FPA or FPV to clean application data-capture files and user-inserted annotation files stored in the internal Compact Flash memory card.
3. Use the "1750 SD Memory" feature of FPV to clean files from the Secure Digital card if the SD card is present in the 1750 Power Recorder SD card socket.
4. Use the "1750 Setup" feature of either FPA or FPV to clean user-accessible recorder configuration data such as recorder date and time, recorder name, recorder password, and recorder Ethernet network address by setting data fields to 0 or blank as appropriate.

Note

Cleaning the Ethernet network address will render the Ethernet interface unusable and cause the Ethernet connection to be lost. Be sure to complete the previous steps first.

5. Remove external AC power continuously for at least six minutes. The internal UPS will power down after five minutes at which time the application firmware, FPGA configuration, and working data will be lost from volatile memory.

Memory Cleaning Limitations:

CPU boot firmware and Bluetooth radio embedded processor firmware in dedicated flash memories, CPU and DSP application firmware, FPGA configuration, and flash memory and configuration backups in the internal Compact Flash memory card are factory programmed or updated with Fluke field service authorized upgrades, contain no user data, are not unique to the instrument, and cannot be cleaned.

The internal Compact Flash memory card contains application log files that cannot be cleaned. They save a limited rolling history of status and diagnostic information for the instrument for use by service personnel.

The calibration constants, recorder serial number, Ethernet MAC address, and Bluetooth Device address that are stored in the small EEPROM cannot be modified by the user and cannot be cleaned.

The 1750 Power Recorder does not provide secure erasure of memories/files. Consequently, it may be possible to recover data from the 1750 even after these memory cleaning instructions have been followed. In addition, some files that cannot be cleaned by this procedure, such as application log files, may contain Ethernet network addresses and other information that could conceivably be used to identify specific instruments, when and where they recorded data, and other potentially sensitive information.

Fluke Power Analyze

To clean user data from the Compact Flash card:

1. Using Fluke Power Analyze (FPA), connect to the Power Recorder to be cleaned. If the 1750 is password protected, you must enter the password at this time.
2. Select **Tools > Erase 1750 Memory**.

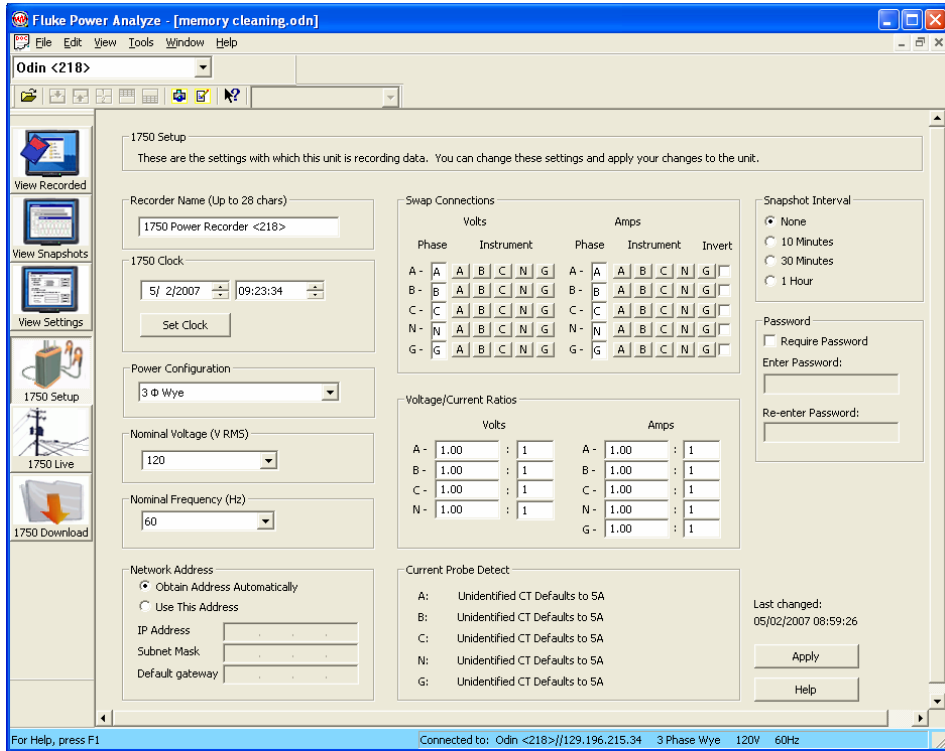

3. Click **OK** to the dialog "Erase all data from Recorder?"

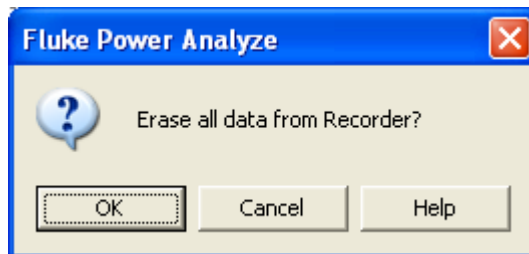

4. Click **OK** to the dialog "Recorder data erased."



To clean user-accessible configuration data in the EEPROM:

1. Using FPA, connect to the Power Recorder to be cleaned.
2. Click the **1750 Setup** button as shown.
3. Type some non-empty string in the “Recorder Name” field (e.g., change “1750 Power Recorder <218>” to “0”).
4. Restore Swap Connections settings back to defaults: set both Volts and Amps to A-A, B-B, C-C, N-N, G-G (or L1-L1, L2-L2, L3-L3, N-N, G-G).
5. Restore the Voltage/Current Ratio defaults to 1:1.
6. Click **Apply**.

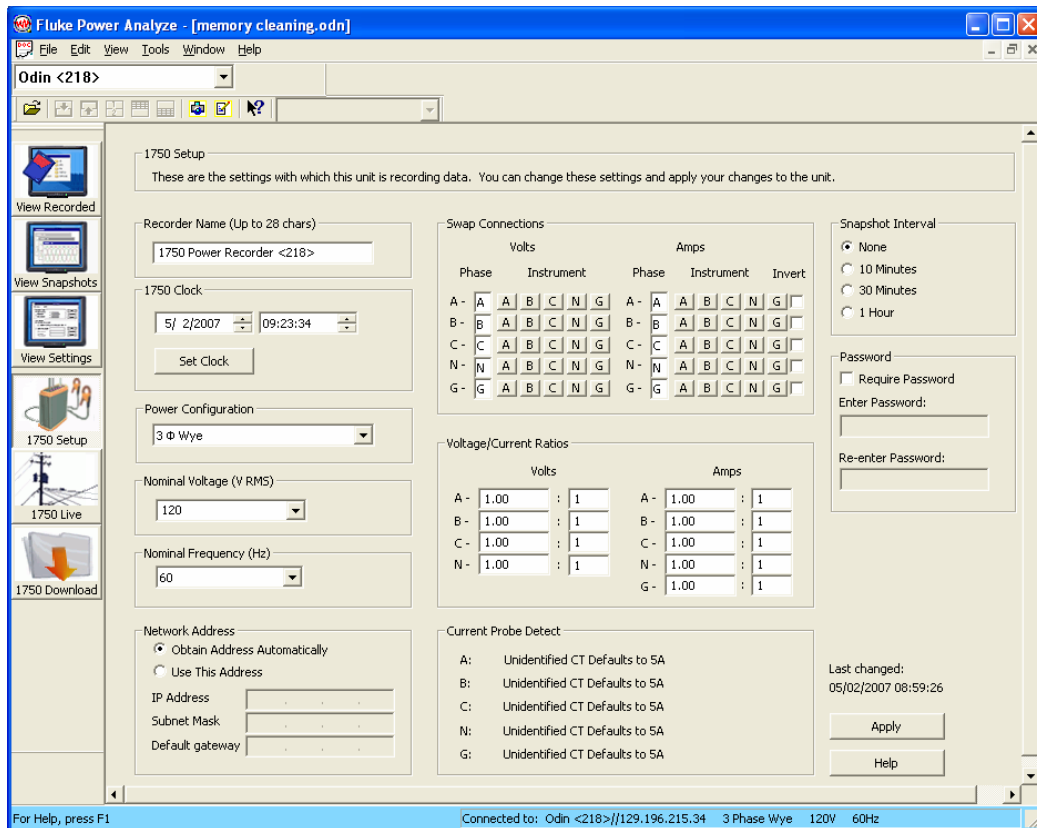

7. Click **OK** to the “Settings saved” dialog.

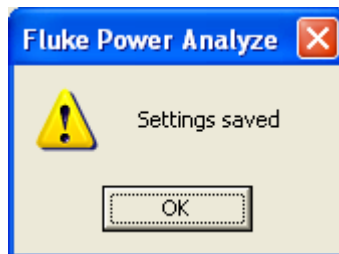

Note

The following steps will make the Power Recorder inaccessible via the Ethernet connection.

8. Select the **Network Address / Use This Address** radio button.
9. Set the fields in “Network Address” to zeros.
10. Click **Apply**.

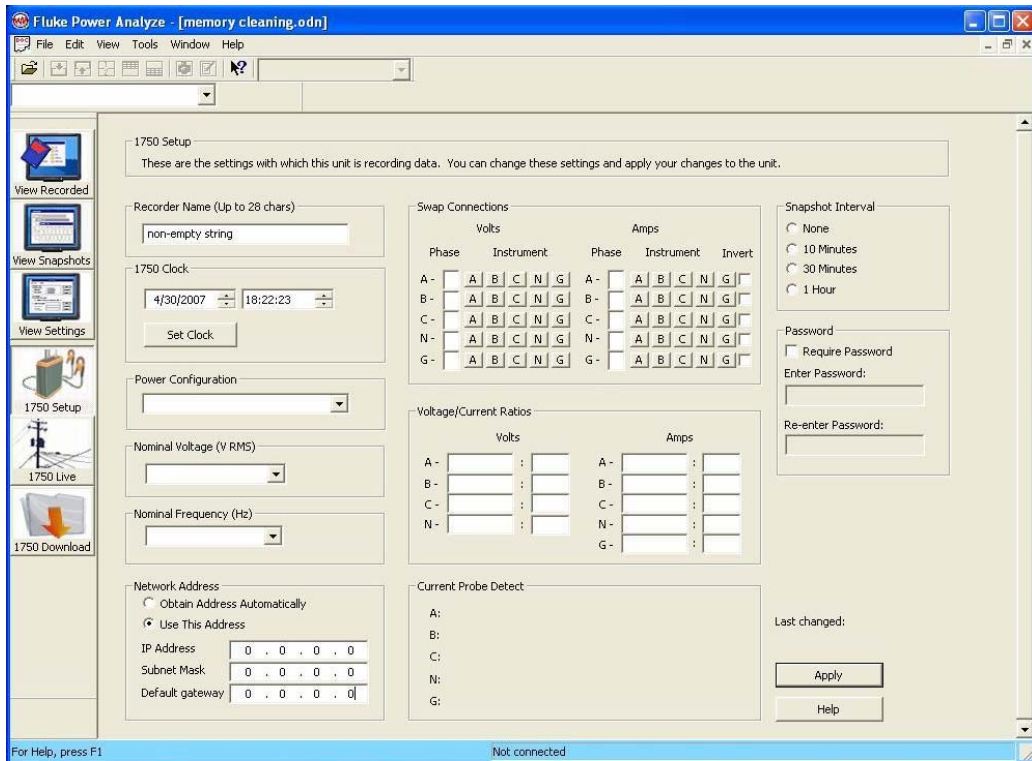

11. Click **OK** to the “Settings saved” dialog.

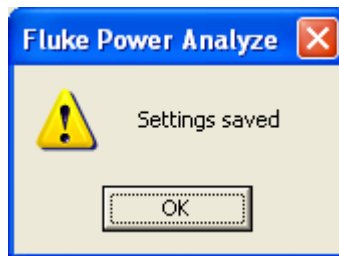

Fluke Power View

To clean user data from the Compact Flash card:

1. Using FPV, connect to the Power Recorder to be cleaned. If the 1750 is password protected, you must enter the password at this time.
2. Select **Data > Erase 1750 Memory** as shown.

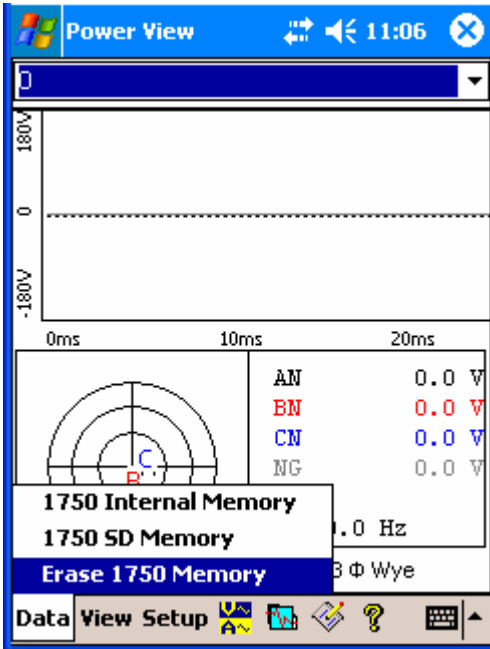

3. Click **Erase All**.

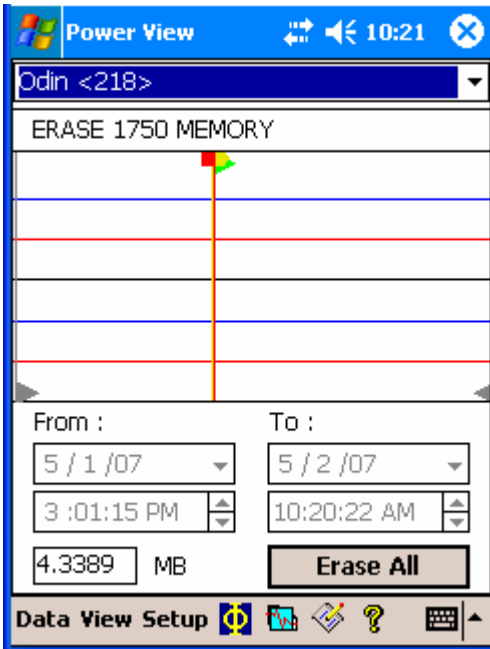

The screen briefly displays the message, "Downloading Data Please Wait..."

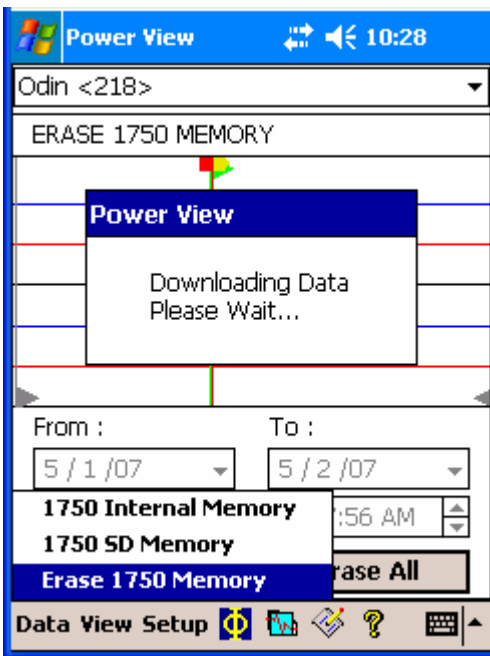

4. Click **Yes** to the dialog **Are you sure?**

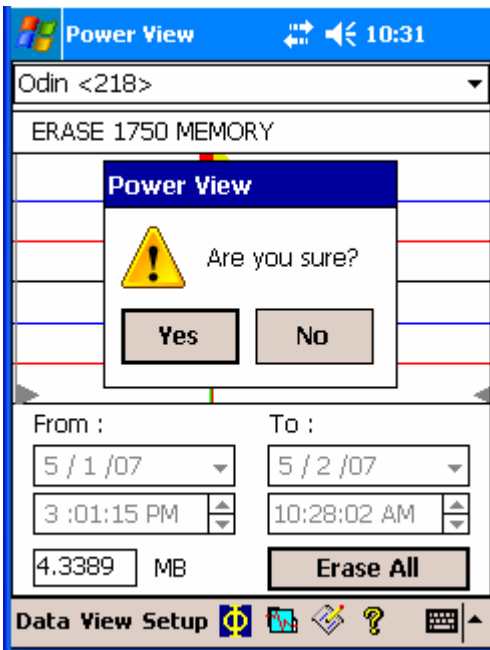

After a few seconds, the dialog will disappear indicating that the memory has been erased.

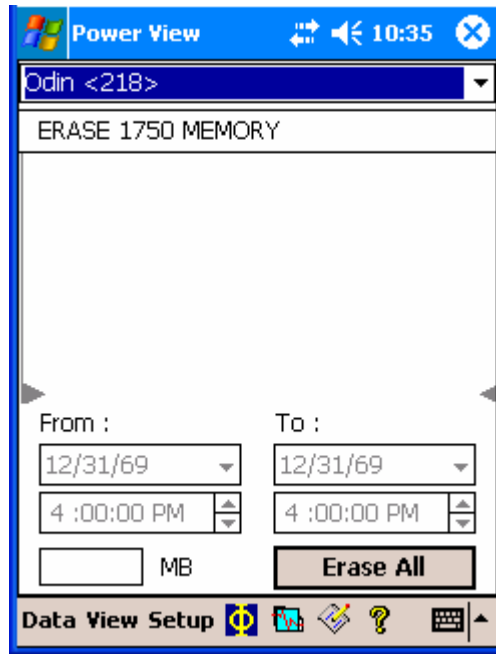

To clean user data from the Secure Digital card:

1. Using FPV, connect to the Power Recorder to be cleaned.
2. Select **Data > 1750 SD Memory** as shown.

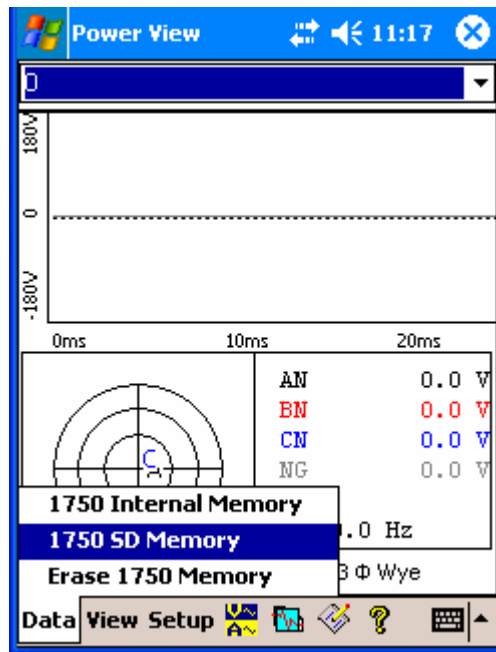

3. Select the file to delete and press **Delete File**.

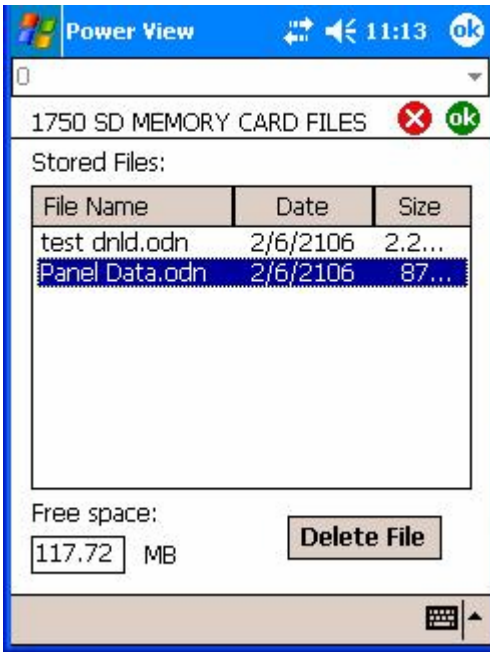

Selected file has been deleted.

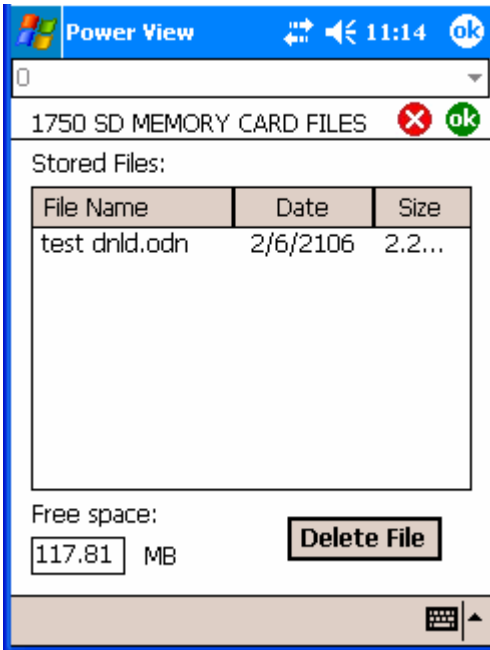

- Repeat steps 3 and 4 until the list of "Stored Files" is empty. This indicates that all user-accessible files on the Secure Digital card have been removed as shown in the next screen.

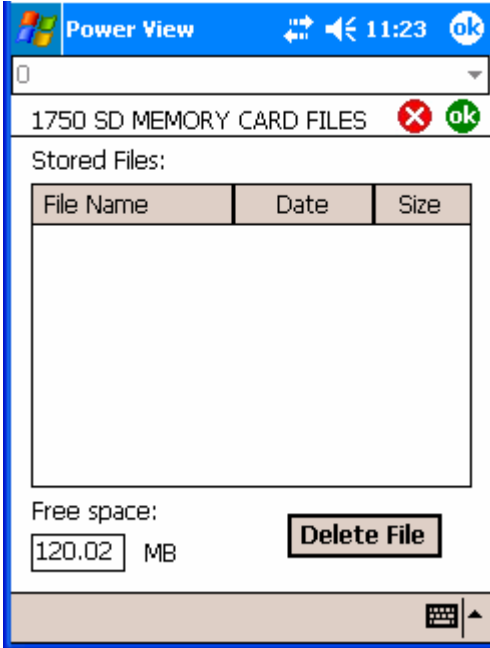

To clean user-accessible configuration data in the EEPROM:

- Using FPV, connect to the Power Recorder to be cleaned.
- Select **Setup > 1750 Setup** as shown.

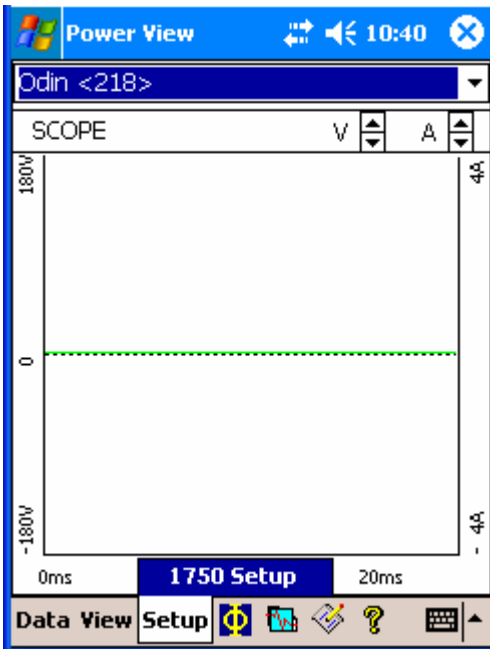

The "Setup" screen appears as shown next. For each of the next few steps you will select icons from this Setup screen, see the resulting screen and make changes to match the example in this document.

3. Click **OK** to return to the Setup screen.

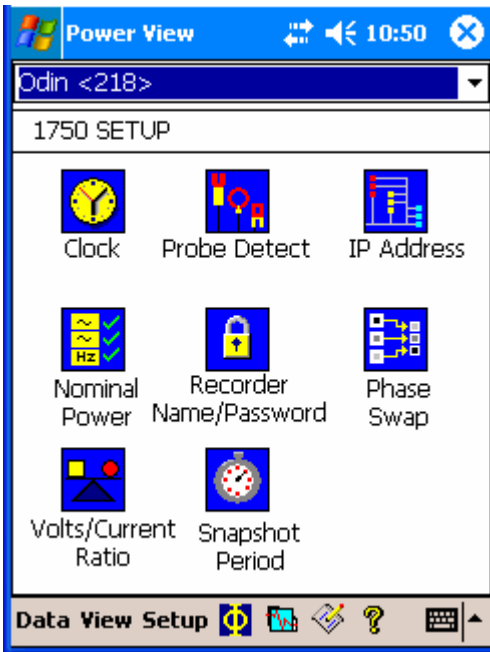

Note

The next step will make the Power Recorder inaccessible via the Ethernet connection.

4. From the Setup screen, select **IP Address**. If needed, enter settings to match the example and click **OK**.

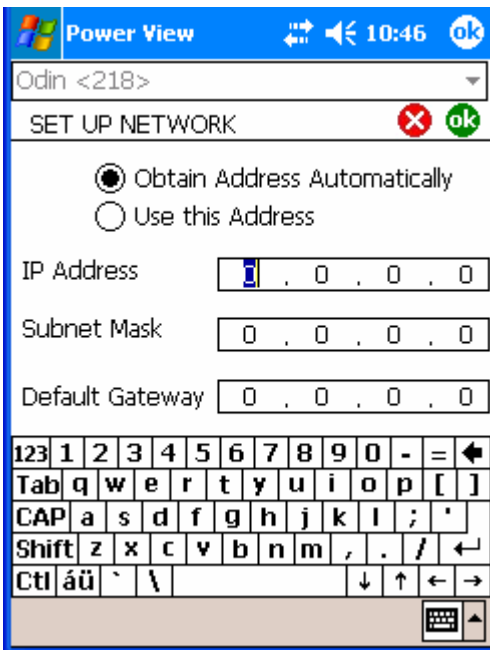

5. From the Setup screen, select **Phase Swap**. If needed, enter settings to match the example and click **OK**.

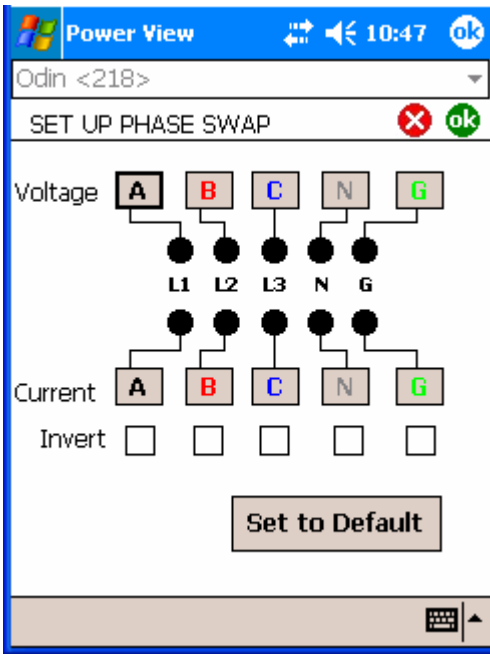

6. From the Setup screen, select **Recorder Name/Password**. If needed, enter settings to match the example and click **OK**.

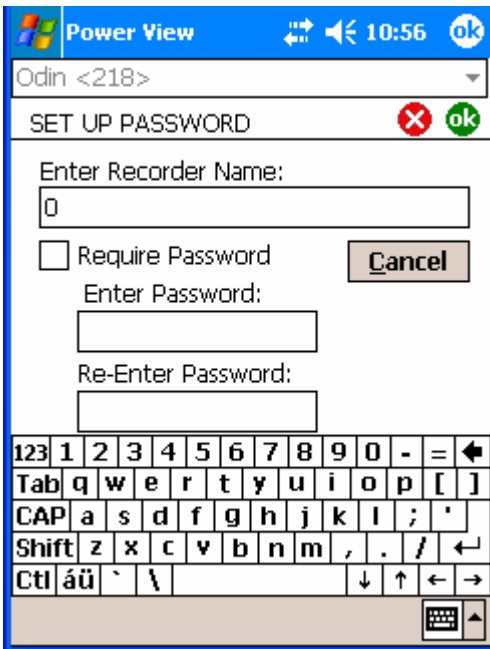

- From the Setup screen, select **Volts/Current Ratio**. If needed, enter settings to match the example and click **OK**.

