

7526A

Precision Process Calibrator

Calibration Manual

March 2013

© 2013 Fluke Corporation. All rights reserved. Specifications are subject to change without notice.
All product names are trademarks of their respective companies.

LIMITED WARRANTY AND LIMITATION OF LIABILITY

Each Fluke product is warranted to be free from defects in material and workmanship under normal use and service. The warranty period is one year and begins on the date of shipment. Parts, product repairs, and services are warranted for 90 days. This warranty extends only to the original buyer or end-user customer of a Fluke authorized reseller, and does not apply to fuses, disposable batteries, or to any product which, in Fluke's opinion, has been misused, altered, neglected, contaminated, or damaged by accident or abnormal conditions of operation or handling. Fluke warrants that software will operate substantially in accordance with its functional specifications for 90 days and that it has been properly recorded on non-defective media. Fluke does not warrant that software will be error free or operate without interruption.

Fluke authorized resellers shall extend this warranty on new and unused products to end-user customers only but have no authority to extend a greater or different warranty on behalf of Fluke. Warranty support is available only if product is purchased through a Fluke authorized sales outlet or Buyer has paid the applicable international price. Fluke reserves the right to invoice Buyer for importation costs of repair/replacement parts when product purchased in one country is submitted for repair in another country.

Fluke's warranty obligation is limited, at Fluke's option, to refund of the purchase price, free of charge repair, or replacement of a defective product which is returned to a Fluke authorized service center within the warranty period.

To obtain warranty service, contact your nearest Fluke authorized service center to obtain return authorization information, then send the product to that service center, with a description of the difficulty, postage and insurance prepaid (FOB Destination). Fluke assumes no risk for damage in transit. Following warranty repair, the product will be returned to Buyer, transportation prepaid (FOB Destination). If Fluke determines that failure was caused by neglect, misuse, contamination, alteration, accident, or abnormal condition of operation or handling, including overvoltage failures caused by use outside the product's specified rating, or normal wear and tear of mechanical components, Fluke will provide an estimate of repair costs and obtain authorization before commencing the work. Following repair, the product will be returned to the Buyer transportation prepaid and the Buyer will be billed for the repair and return transportation charges (FOB Shipping Point).

THIS WARRANTY IS BUYER'S SOLE AND EXCLUSIVE REMEDY AND IS IN LIEU OF ALL OTHER WARRANTIES, EXPRESS OR IMPLIED, INCLUDING BUT NOT LIMITED TO ANY IMPLIED WARRANTY OF MERCHANTABILITY OR FITNESS FOR A PARTICULAR PURPOSE. FLUKE SHALL NOT BE LIABLE FOR ANY SPECIAL, INDIRECT, INCIDENTAL, OR CONSEQUENTIAL DAMAGES OR LOSSES, INCLUDING LOSS OF DATA, ARISING FROM ANY CAUSE OR THEORY.

Since some countries or states do not allow limitation of the term of an implied warranty, or exclusion or limitation of incidental or consequential damages, the limitations and exclusions of this warranty may not apply to every buyer. If any provision of this Warranty is held invalid or unenforceable by a court or other decision-maker of competent jurisdiction, such holding will not affect the validity or enforceability of any other provision.

Fluke Corporation
P.O. Box 9090
Everett, WA 98206-9090
U.S.A.

Fluke Europe B.V.
P.O. Box 1186
5602 BD Eindhoven
The Netherlands

Table of Contents

Title	Page
Introduction.....	1
Contact Fluke Calibration.....	1
Safety Information.....	2
Specifications.....	4
Resistance Specifications, Output.....	6
RTD and Thermistor Specification, Output.....	8
Maintenance.....	10
Clean the Product.....	10
Replace a Line Fuse.....	10
Change the Line Voltage.....	11
Performance Tests.....	12
Required Test Equipment.....	12
DC Voltage.....	13
DC Current.....	14
Thermocouple Output.....	15
CJC (Cold Junction Compensation).....	16
Thermocouple Input.....	17
Ohms Output.....	18
Ohms Input.....	19
Pressure Modules.....	22
Isolated DC Voltage.....	23
Isolated DC Current.....	24
Isolated Loop Power.....	24
Calibration Adjustment.....	25
Initiate Communication.....	25
Starting Adjustment Mode.....	25
Adjustment Sequence.....	26
Steps 1 through 4: DC mV and DC V Source Adjustment.....	26
Step 5: 100 mA Source - DC Current Source Adjustment.....	27
Steps 6 and 7: Hi Ohms Source and Low Ohms Source Adjustment.....	28
Steps 8 through 11: 100 Ohms Measure, Resistance Measure Adjustment ..	29
Step 12: TC SOURCE, TC mV Source Adjustment.....	30
Step 13: TC Read, TC mV Measure Adjustment.....	31
Step 14: TC Cold Junction Temperature (TC CJC) Adjustment.....	31
Step 15: mA Read Adjustment.....	31
Step 16: 10 V Read Adjustment.....	32

Step 17: 100 V Read Adjustment	33
User-Replaceable Parts	34
Accessories	36

List of Tables

Table	Title	Page
1.	Symbols.....	3
2.	Replacement Fuses.....	10
3.	Required Equipment.....	12
4.	DC Voltage Verification.....	13
5.	DC Current Verification.....	14
6.	TC mV Test.....	15
7.	Ohms Output Ranges.....	18
8.	Ohms Ratio Table.....	20
9.	Isolated DC Voltage.....	23
10.	Isolated DC Current.....	24
11.	User-Replaceable Parts.....	34
12.	Accessories.....	36

List of Figures

Figure	Title	Page
1.	Replace the Line Fuse	11
2.	DC Current Performance Test Connections	14
3.	Thermocouple Output Performance Test Connections	15
4.	CJC Performance Test Connections.....	16
5.	TC Input Performance Test Connections	17
6.	Resistance Output Performance Test Connections	18
7.	Ohms Input Performance Test Connections.....	19
8.	Ohms Measurement Performance Test Connections	21
9.	Pressure Module Performance Test Connections.....	22
10.	Isolated DC Voltage Performance Test Connections.....	23
11.	Isolated DC Current Performance Test Connections	24
12.	DC Volts Source Performance Test Connections	27
13.	High and Low Ohms Adjustment Connections.....	27
14.	Hi Ohms Source and Low Ohms Source Adjustment Connections	28
15.	100 Ohms Measure, Resistance Measurement Adjustment Connections	29
16.	mA Read Adjustment Connections	32
17.	10 V Read Adjustment Connections	33
18.	User-Replaceable Parts	35

Introduction

Warning

To prevent possible electrical shock, fire, or personal injury, read all safety information before you use the Product.

This manual contains the verification and calibration adjustment procedures for the 7526A Precision Process Calibrator (the Product). Please see the *7526A Users Manual* for usage information.

The Product is an accurate, full-featured temperature, pressure, and dc calibrator. It is meant for research and development, manufacturing, and calibration laboratory procedures.

Contact Fluke Calibration

To contact Fluke Calibration, call one of the subsequent telephone numbers:

- Technical Support USA: 1-877-355-3225
- Calibration/Repair USA: 1-877-355-3225
- Canada: 1-800-36-FLUKE (1-800-363-5853)
- Europe: +31-40-2675-200
- Japan: +81-3-6714-3114
- Singapore: +65-6799-5566
- China: +86-400-810-3435
- Brazil: +55-11-3759-7600
- Anywhere in the world: +1-425-446-6110

To see product information and download the latest manual supplements, visit Fluke Calibration's website at www.flukecal.com.

To register your product, visit <http://flukecal.com/register-product>.

Safety Information

A **Warning** identifies conditions and procedures that are dangerous to the user. A **Caution** identifies conditions and procedures that can cause damage to the Product or the equipment under test.













Warnings

To prevent possible electrical shock, fire, or personal injury:

- Read all safety information before you use the Product.
- Carefully read all instructions.
- Use the Product only as specified, or the protection supplied by the Product can be compromised.
- Use this Product indoors only.
- Examine the case before you use the Product. Look for cracks or missing plastic. Carefully look at the insulation around the terminals.
- Use only the mains power cord and connector approved for the voltage and plug configuration in your country and rated for the Product.
- Replace the mains power cord if the insulation is damaged or if the insulation shows signs of wear.
- Make sure the ground conductor in the mains power cord is connected to a protective earth ground. Disruption of the protective earth could put voltage on the chassis that could cause death.
- Do not put the Product where access to the mains power cord is blocked.
- Do not touch voltages >30 V ac rms, 42 V ac peak, or 60 V dc.
- Use only cables with correct voltage ratings.
- Do not apply more than the rated voltage, between the terminals or between each terminal and earth ground.
- Do not use the Product around explosive gas, vapor, or in damp or wet environments.
- Remove all probes, test leads, and accessories that are not necessary for the measurement.
- Do not use the Product if it operates incorrectly.
- Do not use and disable the Product if it is damaged.

Table 1 shows the symbols used on the Product and in this manual.

Table 1. Symbols

Symbol	Definition	Symbol	Definition
	Risk of Danger. Important information. See Manual.		This product complies with the WEEE Directive (2002/96/EC) marking requirements. The affixed label indicates that you must not discard this electrical/electronic product in domestic household waste. Product Category: With reference to the equipment types in the WEEE Directive Annex I, this product is classed as category 9 "Monitoring and Control Instrumentation" product. Do not dispose of this product as unsorted municipal waste. Go to Fluke's website for recycling information.
	Hazardous voltage. Risk of electric shock.		Fuse
	AC (Alternating Current)		Protective Earth Ground
	Earth Terminal		Conforms to European Union directives.
	AC (Alternating Current) and DC (Direct Current)		DC (Direct Current)
	This product has been tested to the requirements of CAN/CSA-C22.2 No. 61010-1, third edition.		Pressure

Specifications

General Specifications

Warm-up Time Twice the time since last warmed up, to a maximum of 30 minutes

Settling Time Less than 5 seconds for all functions and ranges except as noted

Standard Interfaces RS-232
IEEE-488 (GPIB)

Temperature Performance

Operating 0 °C to 50 °C

Calibration (tcal) 18 °C to 28 °C

Storage -20 °C to 70 °C

Temperature Coefficient Temperature coefficient for temperatures outside tcal 5 °C is 10 % of the 90-day specification (or 1 year if applicable) per °C

Relative Humidity

Operating <80 % to 30 °C

<70 % to 40 °C

<40 % to 50 °C

Altitude

Operating 3,000 m (9,800 ft) maximum

Non-operating 12,200 m (40,000 ft) maximum

Safety EN/IEC 61010-1, ANSI/ISA 61010-1, CAN/CSA 22.2 No. 61010-1

EMC Complies with EN/IEC 61326-1, EN/IEC 61326-2-1 for controlled EM environments except when used in the following conditions:

- In electromagnetic fields from 0.08-2.7 GHz in excess of 1V/m.
- When subjected to electrostatic discharge (ESD) to the binding posts. Good static awareness practices should be followed when handling this product such as discharging any built up static charge to the product chassis prior to handling terminals or test connections.
- When the product is used with data I/O cables in excess of 3 m.

Analog Low Isolation 20 V

Line Power Line Voltage (selectable)

120 V~ 100 V to 120 V

240 V~ 220 V to 240 V

Line Frequency 47 to 63 Hz

Line Voltage Variation ±10 % about setting

Power Consumption 15 VA maximum

Dimensions

Height 14.6 cm (5.75 inch)

Width 44.5 cm (17.5 inch)

Depth 29.8 cm (11.75 inch) overall

Weight (without options) 4.24 kg (9.35 lb)

DC Voltage Specifications, Output

Ranges ^[1]	Absolute Uncertainty, tcal $\pm 5^{\circ}\text{C}$, $\pm(\text{ppm of output} + \mu\text{V})$				Stability	Resolution	Maximum Burden ^[2]
	90 Days		1 Year		24 hours, $\pm 1^{\circ}\text{C}$ $\pm(\text{ppm of output} + \mu\text{V})$		
0 mV to 100.000 mV	25	3	30	3	5 ppm + 2 μV	1 μV	10 mA
0 V to 1.00000 V	25	10	30	10	4 ppm + 10 μV	10 μV	10 mA
0 V to 10.0000 V	25	100	30	100	4 ppm + 100 μV	100 μV	10 mA
0 V to 100.000 V	25	1 mV	30	1 mV	5 ppm + 1 mV	1 mV	1 mA

[1] All outputs are positive only, unless otherwise noted.
[2] Remote sensing is not provided. Output resistance is < 1 Ω .

Noise		
Ranges	Bandwidth 0.1 to 10 Hz p-p $\pm(\text{ppm of output} + \mu\text{V})$	Bandwidth 10 Hz to 10 kHz rms μV
0 mV to 100.000 mV	1 μV	6 μV
0 V to 1.00000 V	10 μV	60 μV
0 V to 10.0000 V	100 μV	600 μV
0 V to 100.000 V	10 ppm+1 mV	20 mV

DC Voltage Specifications, Thermocouple Jack, Input and Output

Ranges ^[1]	Absolute Uncertainty, tcal $\pm 5^{\circ}\text{C}$, $\pm(\text{ppm of output} + \mu\text{V})$				Stability	Resolution	Maximum Burden ^[2]
	90 Days		1 Year		24 hours, $\pm 1^{\circ}\text{C}$ $\pm(\text{ppm of output} + \mu\text{V})$		
-10 to 75.000 mV	25	2 μV	30	2 μV	5 ppm + 2 μV	1 μV	10 Ω

[1] All outputs are positive only, unless otherwise noted.
[2] Remote sensing is not provided. Output resistance is < 1 Ω .

DC Voltage Specifications, Isolated Input

Ranges	Absolute Uncertainty, tcal $\pm 5^{\circ}\text{C}$, $\pm(\text{ppm of reading} + \text{mV})$		Resolution
0 V to 10.0000 V	50	0.2	100 μV
0 V to 100.000 V	50	2.0	1 mV

DC Current Specifications, Output

Ranges ^[1]	Absolute Uncertainty, tcal $\pm 5^{\circ}\text{C}$, $\pm(\text{ppm of output} + \mu\text{A})$				Resolution	Maximum Compliance Voltage	Maximum Inductive Load
	90 Days		1 Year				
0 mA to 100.000 mA	40 ^[2]	1	50 ^[2]	1	1 μA	12 V	100 mH

[1] All outputs are positive only.
[2] For line voltages less than 95 V (± 100 ppm of reading)

Ranges	Noise	
	Bandwidth 0.1 to 10 Hz p-p	Bandwidth 10 Hz to 10 kHz rms μV
0 mA to 100.000 mA	2000 nA	20 μA

DC Current Specifications, Isolated Input

Ranges	Absolute Uncertainty, tcal $\pm 5^{\circ}\text{C}$, $\pm(\text{ppm of reading} + \mu\text{A})$		Resolution
0 mA to 50.0000 mA	100	1	0.1 μA
0 mA to 24.0000 mA (Loop Power) ^{[1][2]}	100	1	0.1 μA

[1] Loop Power: 24 V $\pm 10\%$
[2] HART Resistor: 250 Ω $\pm 3\%$

Resistance Specifications, Output

Ranges	Absolute Uncertainty, tcal ± 5 °C, \pm Ohms		Resolution	Nominal Current ^[1]
	90 Days	1 Year		
5 Ω to 400.000 Ω	0.012	0.015	0.001 Ω	1 to 3 mA
5 Ω to 4.00000 k Ω	0.25	0.3	0.01 Ω	100 μ A to 1 mA

[1] For currents lower than shown, the specification becomes
 New Spec. = Stated Spec. x Imin/lactual.
 For example, a 500 μ A stimulus that measures 100 Ω has a specification of: 0.015 Ω x 1 mA/500 μ A=0.03 Ω

Resistance Specifications, Input

Ranges	Absolute Uncertainty, tcal ± 5 °C \pm (ppm of reading + Ω)		Resolution	Stimulus Current
	90 Days	1 Year		
0 Ω to 400.000 Ω	± 20 ppm + 0.0035 Ω	± 20 ppm + 0.004 Ω	0.001 Ω	1 mA
0 Ω to 4.00000 k Ω	± 20 ppm + 0.035 Ω	± 20 ppm + 0.04 Ω	0.01 Ω	0.1 mA

Thermocouple Specification, Output and Input

TC Type	Range (°C)		Absolute Uncertainty, tcal ± 5 °C, \pm (°C) ^[1]	
			Output/Input	
	Minimum	Maximum	90 days	1 Year
B	600 °C	800 °C	0.35 °C	0.35 °C
	800 °C	1550 °C	0.28 °C	0.28 °C
	1550 °C	1820 °C	0.21 °C	0.22 °C
C	0 °C	1000 °C	0.15 °C	0.16 °C
	1000 °C	1800 °C	0.22 °C	0.23 °C
	1800 °C	2000 °C	0.24 °C	0.26 °C
	2000 °C	2316 °C	0.32 °C	0.35 °C
E	-250 °C	-200 °C	0.24 °C	0.25 °C
	-200 °C	-100 °C	0.10 °C	0.12 °C
	-100 °C	0 °C	0.07 °C	0.09 °C
	0 °C	600 °C	0.06 °C	0.08 °C
	600 °C	1000 °C	0.08 °C	0.10 °C
J	-210 °C	-100 °C	0.13 °C	0.14 °C
	-100 °C	800 °C	0.07 °C	0.09 °C
	800 °C	1200 °C	0.08 °C	0.10 °C
K	-250 °C	-200 °C	0.45 °C	0.46 °C
	-200 °C	-100 °C	0.15 °C	0.16 °C
	-100 °C	500 °C	0.08 °C	0.10 °C
	500 °C	800 °C	0.09 °C	0.10 °C
	800 °C	1372 °C	0.11 °C	0.13 °C
L	-200 °C	-100 °C	0.08 °C	0.10 °C
	-100 °C	900 °C	0.07 °C	0.09 °C
N	-250 °C	-200 °C	0.72 °C	0.73 °C
	-200 °C	-100 °C	0.22 °C	0.23 °C
	-100 °C	0 °C	0.11 °C	0.12 °C
	0 °C	100 °C	0.09 °C	0.11 °C
	100 °C	800 °C	0.08 °C	0.10 °C
	800 °C	1300 °C	0.10 °C	0.12 °C

TC Type	Range (°C)		Absolute Uncertainty, tcal ±5 °C, ±(°C) ^[1]	
			Output/Input	
	Minimum	Maximum	90 days	1 Year
R	-50 °C	-25 °C	0.54 °C	0.55 °C
	-25 °C	0 °C	0.44 °C	0.45 °C
	0 °C	100 °C	0.38 °C	0.39 °C
	100 °C	400 °C	0.27 °C	0.28 °C
	400 °C	600 °C	0.21 °C	0.22 °C
	600 °C	1000 °C	0.19 °C	0.21 °C
	1000 °C	1600 °C	0.18 °C	0.19 °C
	1600 °C	1767 °C	0.21 °C	0.23 °C
S	-50 °C	-25 °C	0.51 °C	0.51 °C
	-25 °C	0 °C	0.43 °C	0.43 °C
	0 °C	100 °C	0.37 °C	0.38 °C
	100 °C	400 °C	0.28 °C	0.29 °C
	400 °C	600 °C	0.22 °C	0.23 °C
	600 °C	1000 °C	0.21 °C	0.22 °C
	1000 °C	1600 °C	0.20 °C	0.22 °C
	1600 °C	1767 °C	0.24 °C	0.26 °C
T	-250 °C	-200 °C	0.34 °C	0.35 °C
	-200 °C	-100 °C	0.14 °C	0.16 °C
	-100 °C	0 °C	0.09 °C	0.11 °C
	0 °C	200 °C	0.07 °C	0.09 °C
	200 °C	400 °C	0.06 °C	0.09 °C
U	-200 °C	0 °C	0.15 °C	0.16 °C
	0 °C	200 °C	0.08 °C	0.10 °C
	200 °C	600 °C	0.07 °C	0.10 °C
XK	-200 °C	-100 °C	0.10 °C	0.11 °C
	-100 °C	0 °C	0.07 °C	0.09 °C
	0 °C	600 °C	0.06 °C	0.08 °C
	600 °C	800 °C	0.07 °C	0.09 °C
BP	0 °C	200 °C	0.17 °C	0.18 °C
	200 °C	600 °C	0.14 °C	0.16 °C
	600 °C	800 °C	0.15 °C	0.17 °C
	800 °C	1600 °C	0.22 °C	0.23 °C
	1600 °C	2000 °C	0.26 °C	0.28 °C
	2000 °C	2500 °C	0.38 °C	0.40 °C

[1] Does not include thermocouple wire error.
 Type B, E, J, K, N, R, S and T are based on ITS-90
 Type L and U are based on DIN 43710-1985
 Type C is based on ASTM standard E 988-96
 Type XK and BP are based on GOST R 8.585-2001

RTD and Thermistor Specification, Output

RTD Types	Range °C		Absolute Uncertainty, tcal ± 5 °C \pm (°C) ^[1]	
	Minimum	Maximum	90 Days	1 Year
Pt 385, 100 Ω	-200 °C	800 °C	0.04 °C	0.05 °C
Pt 3926, 100 Ω	-200 °C	630 °C	0.04 °C	0.05 °C
Pt 3916, 100 Ω	-200 °C	630 °C	0.04 °C	0.05 °C
Pt 385, 200 Ω	-200 °C 400 °C	400 °C 630 °C	0.35 °C 0.42 °C	0.40 °C 0.50 °C
Pt 385, 500 Ω	-200 °C	630 °C	0.15 °C	0.17 °C
Pt 385, 1000 Ω	-200 °C	630 °C	0.07 °C	0.09 °C
Ni 120, 120 Ω	-80 °C	260 °C	0.02 °C	0.02 °C
Cu 427, 10 Ω ^[2]	-100 °C	260 °C	0.30 °C	0.38 °C
YSI 400	15 °C	50 °C	0.005 °C	0.007 °C

[1] 2-wire output
[2] Based on MINCO Application Aid No. 18

RTD and Thermistor Specification, Input

RTD Type	Range (°C)		Absolute Uncertainty, tcal ± 5 °C, \pm (°C) ^[1]	
	Minimum	Maximum	Output/Input	
			90 Days	1 Year
Pt 385, 100 Ω	-200 °C	-80 °C	0.012 °C	0.013 °C
	-80 °C	100 °C	0.018 °C	0.020 °C
	100 °C	300 °C	0.022 °C	0.024 °C
	300 °C	400 °C	0.025 °C	0.026 °C
	400 °C	630 °C	0.031 °C	0.033 °C
	630 °C	800 °C	0.037 °C	0.038 °C
Pt 3926, 100 Ω	-200 °C	-80 °C	0.012 °C	0.013 °C
	-80 °C	0 °C	0.014 °C	0.015 °C
	0 °C	100 °C	0.016 °C	0.017 °C
	100 °C	300 °C	0.022 °C	0.022 °C
	300 °C	400 °C	0.022 °C	0.026 °C
	400 °C	630 °C	0.024 °C	0.032 °C
Pt 3916, 100 Ω	-200 °C	-190 °C	0.009 °C	0.010 °C
	-190 °C	-80 °C	0.012 °C	0.013 °C
	-80 °C	0 °C	0.014 °C	0.015 °C
	0 °C	100 °C	0.016 °C	0.017 °C
	100 °C	300 °C	0.021 °C	0.022 °C
	300 °C	400 °C	0.024 °C	0.026 °C
	400 °C	600 °C	0.030 °C	0.031 °C
	600 °C	630 °C	0.031 °C	0.033 °C
Pt 385, 200 Ω	-200 °C	-80 °C	0.047 °C	0.053 °C
	-80 °C	0 °C	0.050 °C	0.056 °C
	0 °C	100 °C	0.053 °C	0.060 °C
	100 °C	260 °C	0.054 °C	0.060 °C
	260 °C	300 °C	0.062 °C	0.069 °C
	300 °C	400 °C	0.064 °C	0.071 °C
	400 °C	630 °C	0.079 °C	0.088 °C
Pt 385, 500 Ω	-200 °C	0 °C	0.023 °C	0.025 °C
	0 °C	100 °C	0.026 °C	0.028 °C
	100 °C	300 °C	0.031 °C	0.034 °C
	300 °C	400 °C	0.035 °C	0.038 °C
	400 °C	630 °C	0.041 °C	0.045 °C

RTD Type	Range (°C)		Absolute Uncertainty, tcal ±5 °C, ±(°C) ^[1]	
			Output/Input	
	Minimum	Maximum	90 Days	1 Year
Pt 385, 1000 Ω	-200 °C	0 °C	0.014 °C	0.015 °C
	0 °C	100 °C	0.017 °C	0.018 °C
	100 °C	300 °C	0.022 °C	0.024 °C
	300 °C	400 °C	0.024 °C	0.026 °C
	400 °C	630 °C	0.031 °C	0.033 °C
Ni 120, 120 Ω	-80 °C	260 °C	0.008 °C	0.009 °C
Cu 427, 10 Ω ^[2]	-100 °C	260 °C	0.097 °C	0.110 °C
YSI 400	15 °C	50 °C	0.005 °C	0.007 °C
SPRT	-200 °C	660 °C	0.05 °C	0.06 °C

[1] 4-wire mode. Uncertainties shown do not include probe uncertainties.
 [2] Based on MINCO Application Aid No. 18.

Pressure Measurement Specifications

The Calibrator can accept the Fluke 700 or 525A-P Series pressure modules. Pressure modules connect directly into the front panel Lemo connector with the Calibrator firmware auto-detecting the type and value of the module you connect.

Range	Accuracy and Resolution	Units
Determined by the pressure module	Determined by the pressure module	PSI (pounds per square inch)
		in H2O 4 °C (inches of water at 4 degrees Celsius)
		in H2O 20 °C (inches of water at 20 degrees Celsius)
		in H2O 60 °C (inches of water at 60 degrees Fahrenheit)
		cm H2O 4 °C (centimeters of water at 4 degrees Celsius)
		cm H2O 20 °C (centimeters of water at 20 degrees Celsius)
		mm H2O 4 °C (millimeters of water at 4 degrees Celsius)
		mm H2O 20 °C (millimeters of water at 20 degrees Celsius)
		BAR (bars)
		mBAR (millibars)
		kPa (kilopascals)
		MPa (megapascals)
		in HG 0 °C (inches of mercury at 0 degrees Celsius)
		mm HG 0 °C (millimeters of mercury at 0 degrees Celsius)
		kg/cm2 (kilograms per square centimeter)

Switch Test Specifications, Isolated Input

Contact Closure Resistance	<1 kΩ
Excitation Current	27 mA Max

Maintenance

This section explains typical maintenance and tasks necessary to keep the Product in service.

Warnings

To prevent possible electrical shock, fire, or personal injury:

- **Have an approved technician repair the Product.**
- **Disconnect the mains power cord before you remove the Product covers.**
- **Do not operate the Product with covers removed or the case open. Hazardous voltage exposure is possible.**
- **Use only specified replacement parts.**



Clean the Product

Clean the Product and pressure modules with a soft cloth dampened with water, or mild soap and water.

Replace a Line Fuse

The line power fuses and line voltage selector are found in the compartment above the power switch on the right rear side of the Product. Table shows the correct replacement fuse for each line voltage setting.

Table 2. Replacement Fuses

Fuse Description	Line Voltage Setting
 0.25 A/250 V (SB)	120 V (Operating Range 90 V to 132 V)
 0.125 A/250 V (SB)	240 V (Operating Range 198 V to 264 V)
 To ensure safety, use exact replacement only.	

To examine or replace a fuse:

1. Disconnect the mains power.
2. Use a flat-head screwdriver to pry up the tab at the base of the line fuse compartment. Insert the blade into the center slot under the tab. The compartment cover will come part way out. See Figure 1.
3. Remove the compartment cover. The fuses come out with the compartment cover and can be examined or replaced.
4. To install the fuse holder, push the compartment cover back into the compartment until the tab locks in position.

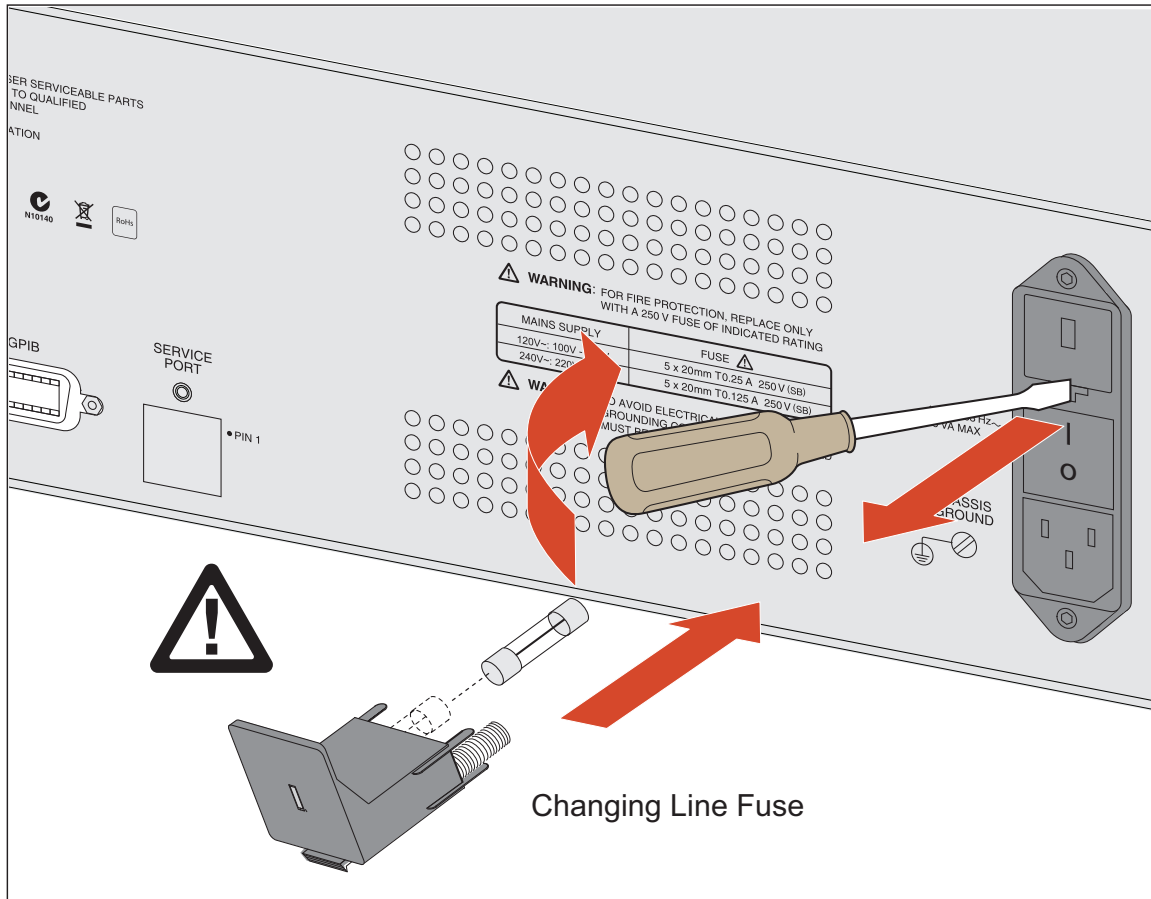

Figure 1. Replace the Line Fuse

Change the Line Voltage

The Product comes from the factory configured for the line voltage applicable for the country of purchase, or as specified when it is ordered. To verify the line voltage setting, examine the line voltage indicator on the power line fuse compartment cover.

Make sure that the line voltage selection is set for 120 V for line voltages between 100 V and 120 V $\pm 10\%$ about setting. The selector must be set to 240 V for line voltages between 220 V and 240 V $\pm 10\%$ about setting.

Performance Tests

Warning

To prevent possible electrical shock, fire, or personal injury, do not perform the performance test procedures unless the Product is fully assembled.

The performance tests verify the complete operation of the Product and measure the accuracy of each function against Product specifications. If the Product fails a part of the test, calibration adjustment or repair is necessary. See “Calibration Adjustment”.

Required Test Equipment

The equipment listed in Table 3 is necessary to do the performance tests and calibration adjustment.

Table 3. Required Equipment

Equipment	Recommended Model	Where Used
8-1/2 digit Precision Digital Multimeter (DMM)	Fluke 8508A	DC volts, dc current, resistance
Ohms shorting block		Low ohms measure and SPRT calibration and high ohms measure calibration
1 Ω Resistance Standard	Fluke 742A-1	DC current
Resistance standard, 10 Ω	Fluke 742A-10	100 mA source calibration
Resistance standard, 100 Ω	Fluke 742A-100	Low ohms measure and SPRT calibration
1 K Ω Resistance Standard	Fluke 742A-1K	Resistance
10 K Ω Resistance Standard	Fluke 742A-10K	Resistance
Multifunction Calibrator	Fluke 5522A	DC volts, dc current, resistance
Thermistor probe	Fluke 5640-D	TC CJC calibration
Thermocouple probe	Omega E-type thermocouple probe	TC CJC calibration
Pressure Module	Any Fluke 700 Series Module	Pressure
Lead Set	5520A-525A/LEADS Leads Kit	Necessary test cables
Precision Thermistor	Fluke 5640-D	Temperature
Thermometer Readout	Fluke 1504	Temperature
Dewar Flask with Lid	---	Thermocouple
Characterized Type E Thermocouple	---	Thermocouple
Banana Jack to Copper TC Mini-connector	---	Thermocouple
Lag bath		TC CJC calibration

DC Voltage

The dc voltage performance test verifies the accuracy of the **Volts Source** output from the front panel of the Product. Verify the measurements shown in Table 4 with a digital multimeter (DMM).

Table 4. DC Voltage Verification

Range	Nominal Value	Measured Value	90-Day Specification (V)	1-Year Specification (V)
100 mV	0 V		3.00E-06	3.00E-06
	0.035 V		3.88E-06	4.05E-06
	0.065 V		4.63E-06	4.95E-06
	0.1 V		5.50E-06	6.00E-06
1.0 V	0 V		1.00E-05	1.00E-05
	0.35 V		1.88E-05	2.05E-05
	0.65 V		2.63E-05	2.95E-05
	1 V		3.50E-05	4.00E-05
10.0 V	0 V		1.00E-04	1.00E-04
	3.5 V		1.88E-04	2.05E-04
	6.5 V		2.63E-04	2.95E-04
	10 V		3.50E-04	4.00E-04
100.0 V	0 V		1.00E-03	1.00E-03
	35 V		1.88E-03	2.05E-03
	65 V		2.63E-03	2.95E-03
	100 V		3.50E-03	4.00E-03

DC Current

The dc current performance test verifies the accuracy of the current output from the front panel of the Product. Use the 8508A and the precision shunt to measure the Product output. Divide the voltage indication from the 8508A by the 742A-1 actual value to determine the current output. Verify the measurements shown in Table 5. See Figure 2 for connections.

Table 5. DC Current Verification

100 mA Output	Volt	Current (I=E/R)	742A-1 Shunt Value	90-Day Specification	1-Year Specification
0.000 mA			Direct into 8508A Current Input, Autorange	1.0 μ A	1.0 μ A
35.000 mA				2.4 μ A	2.75 μ A
65.000 mA				3.6 μ A	4.25 μ A
100.000 mA				5 μ A	6 μ A

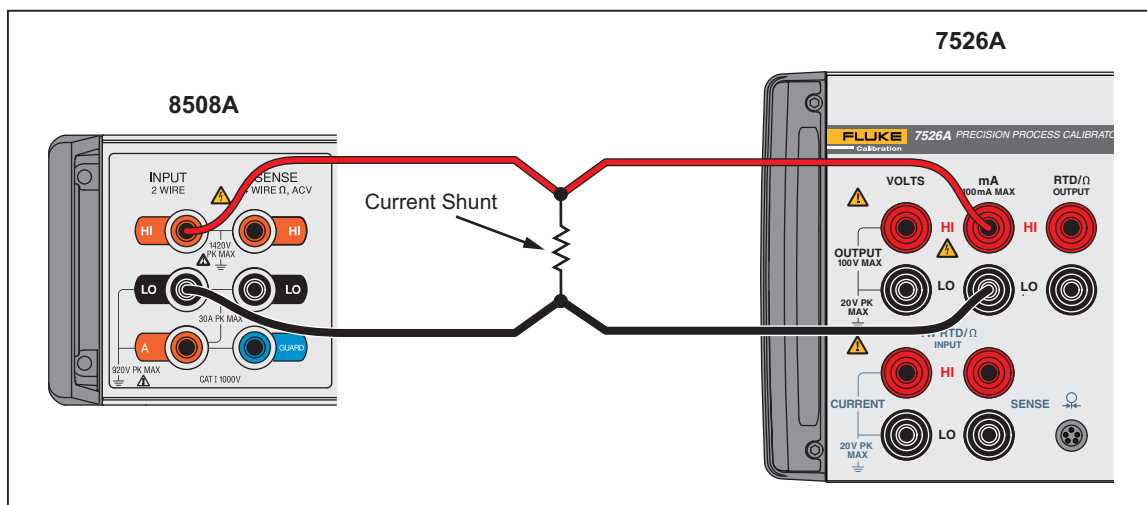

Figure 2. DC Current Performance Test Connections

gxm010.eps

Thermocouple Output

The thermocouple (TC) output performance test verifies the accuracy of the TC output on the front panel of the Product. Thermocouple mV specifications will be used for this test. When this test is combined with the cold junction compensation (CJC) test, all functions of the TC output are checked. The cable necessary to connect the Product to the 8508A will need to be constructed. The TC mini-connector needs copper-copper (white). With copper wire, connect the mini-connector to standard banana jacks. See Figure 3 for connections.

1. Push **SHIFT** and then **7** to select TC output.
2. Push **TYPE UNITS** until **mV/°C** shows on the display.
3. Output the mV values listed in Table 6.

Table 6. TC mV Test

Nominal Voltage	90-Day Specification	1-Year Specification
-10.000 mV	3.125 μ V	3.15 μ V
15.000 mV	3.375 μ V	3.45 μ V
35.000 mV	3.750 μ V	3.90 μ V
55.000 mV	4.250 μ V	4.50 μ V
75.000 mV	4.750 μ V	5.10 μ V

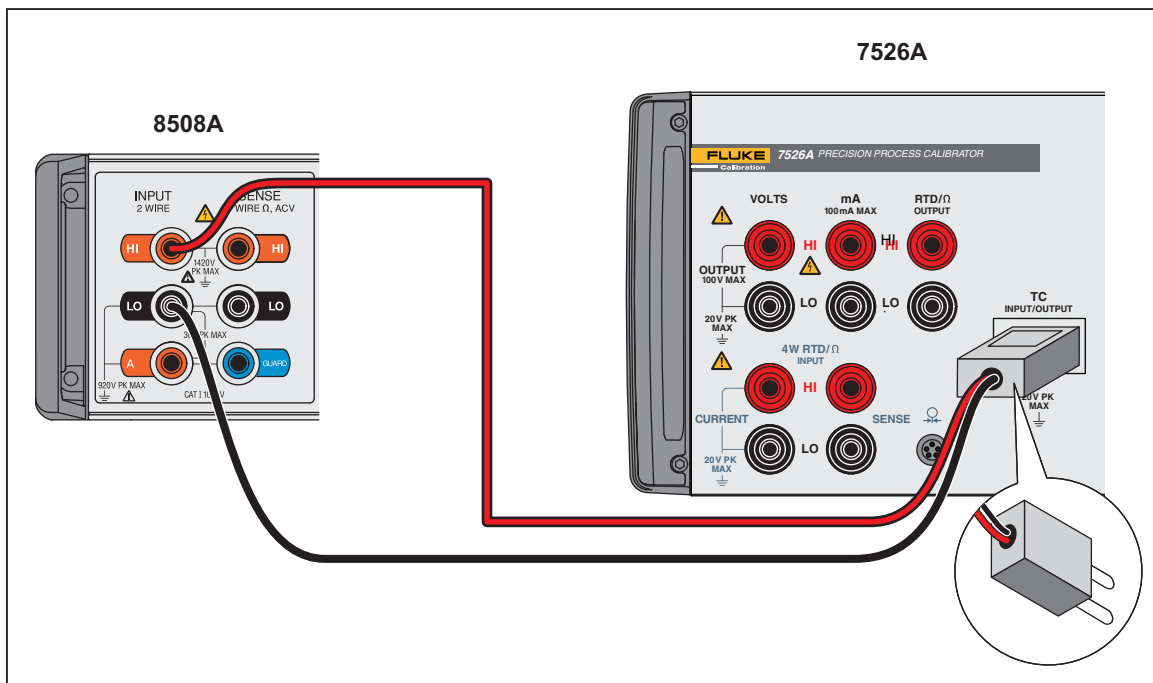

Figure 3. Thermocouple Output Performance Test Connections

gxm011.eps

CJC (Cold Junction Compensation)

The CJC performance test verifies the accuracy of the cold junction compensation of the Product. Connect a Type-E thermocouple to the TC terminals on the Product. Immerse the thermocouple and a precision thermometer in a mineral oil lag bath. See Figure 4 for connections.

1. Push **SHIFT** then **8** to switch to TC input.
2. Push **SHIFT** then **5** to turn on the internal junction. XCJC is not shown when the internal junction is used.
3. Push **TYPE UNITS** until Type E is shown on the display.

Make sure that the indications of the Product and the precision thermometer are within the Type-E specifications:

- 90-Day specification is 0.06 °C
- 1-Year specification is 0.08 °C

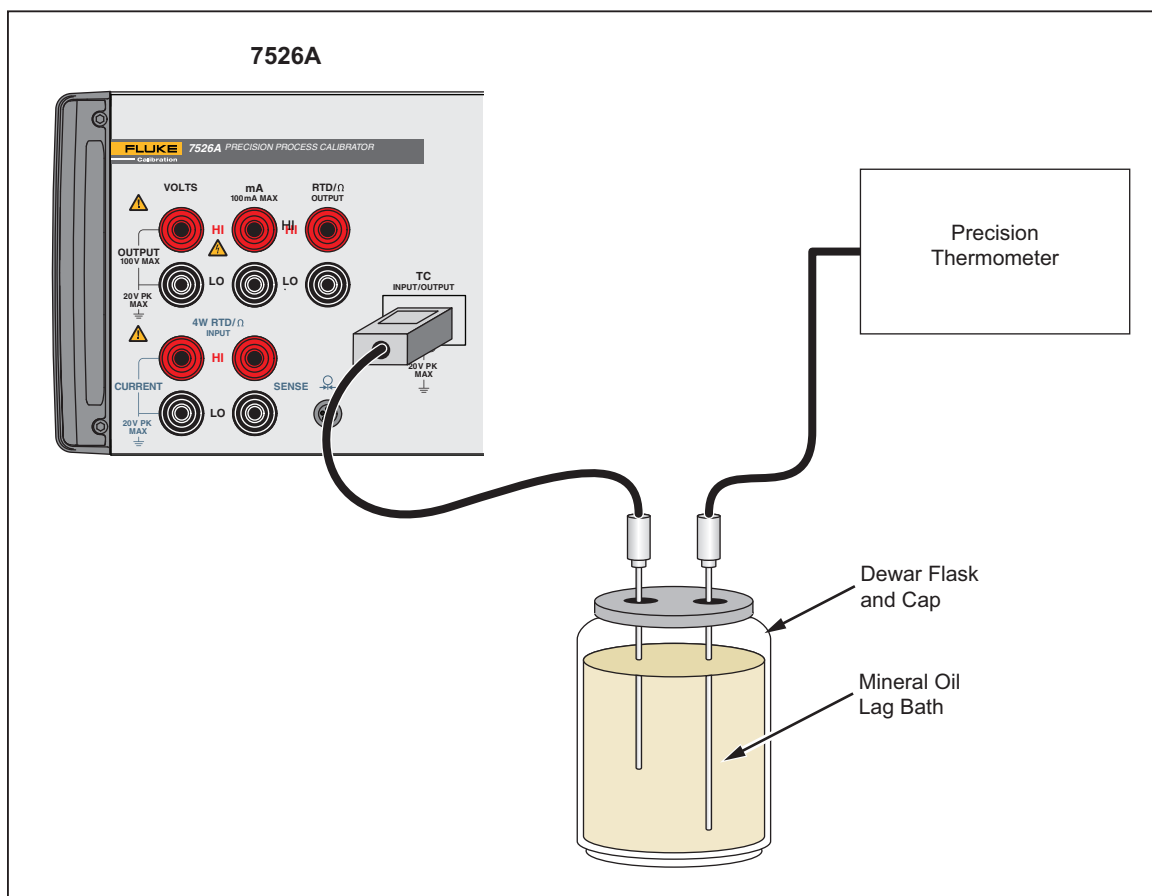

Figure 4. CJC Performance Test Connections

gxm012.eps

Note

Typical Type-E thermocouples do not have specifications accurate enough to be used as a standard. To maintain a good test uncertainty ratio (TUR), a characterized Type-J thermocouple can be used.

Thermocouple Input

The TC input performance test verifies the accuracy of the TC input. Push **SHIFT** and then **8** on the Product to set the Product to TC input. All Product conditions will be the same as the Thermocouple Output test mode (CJC off, mV/ °C). Set the 5522A to the mV values listed in Table 6. See Figure 5 for connections.

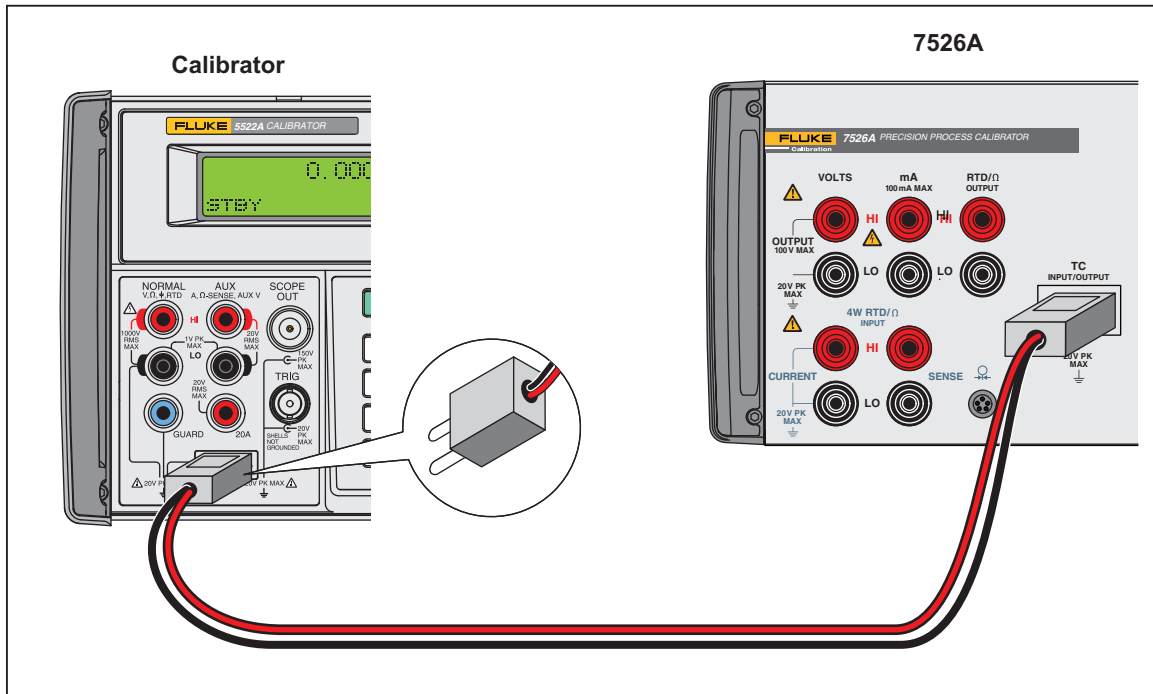

Figure 5. TC Input Performance Test Connections

gxm013.eps

Ohms Output

The ohms output performance test verifies the accuracy of the ohms output from the front of the Product. Use the DMM to measure the ohms output. Apply the values shown in Table 7. See Figure 6 for connections.

Note

Make sure the sense wires from the 8508A are on the bottom of the stackable leads.

Push **TYPE UNITS** to select the 400 Ω, then the 4000 Ω range.

Note

The 8508A should be set to the 2 kΩ range when you measure the 7526A 400 Ω range. After the 1000 Ω measurement, the 8508A should be set to the 20 kΩ range with loI off. To prevent an overload, the 8508A must be in the “loI” (low current mode) to measure 5 Ω in the 4 kΩ range.

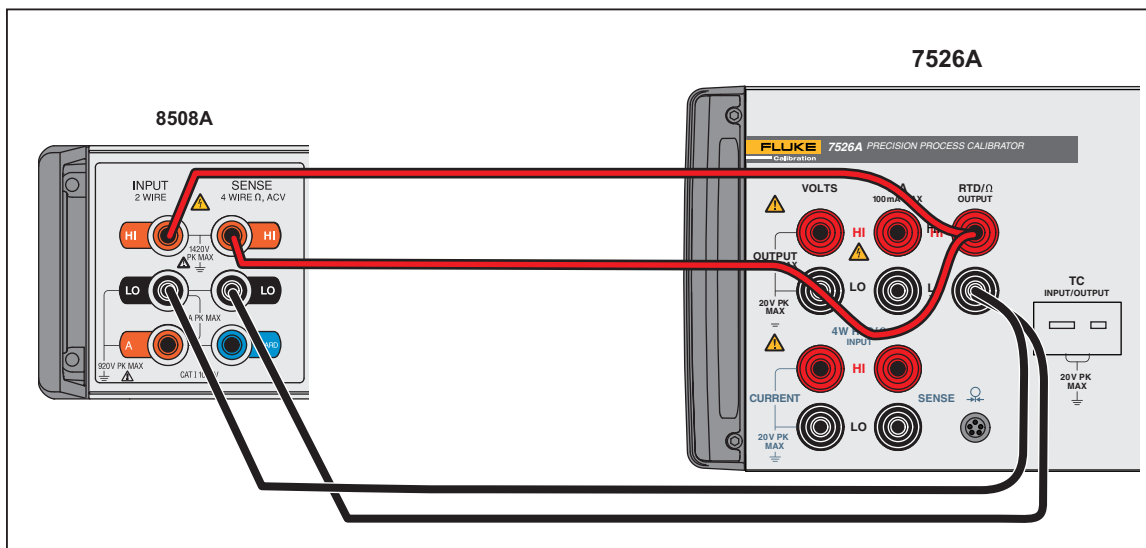

Figure 6. Resistance Output Performance Test Connections

gxm014.eps

Table 7. Ohms Output Ranges

Range	Output	90-Day Specification	1-Year Specification
400 Ω	5 Ω	0.012 Ω	0.015 Ω
	100 Ω	0.012 Ω	0.015 Ω
	200 Ω	0.012 Ω	0.015 Ω
	300 Ω	0.012 Ω	0.015 Ω
	400 Ω	0.012 Ω	0.015 Ω
4000 Ω	5 Ω	0.25 Ω	0.30 Ω
	1000 Ω	0.25 Ω	0.30 Ω
	2000 Ω	0.25 Ω	0.30 Ω
	3000 Ω	0.25 Ω	0.30 Ω
	4000 Ω	0.25 Ω	0.30 Ω

Ohms Input

The ohms input performance test verifies the ohms input on the front of the Product. Before an ohms input is measured, the ohms output of a 5522A must be “characterized”. To get the necessary accuracy, the 8508A is used as a transfer standard and the 742A is used as the reference standard. To find the true value of the 5522A output, use the ratio input function of the 8508A. This is located on the front and rear panels. Connect the 742A to the front terminal and connect the 5522A to the rear terminals. Use four-wire measure for both. See Figure 7 for connections.

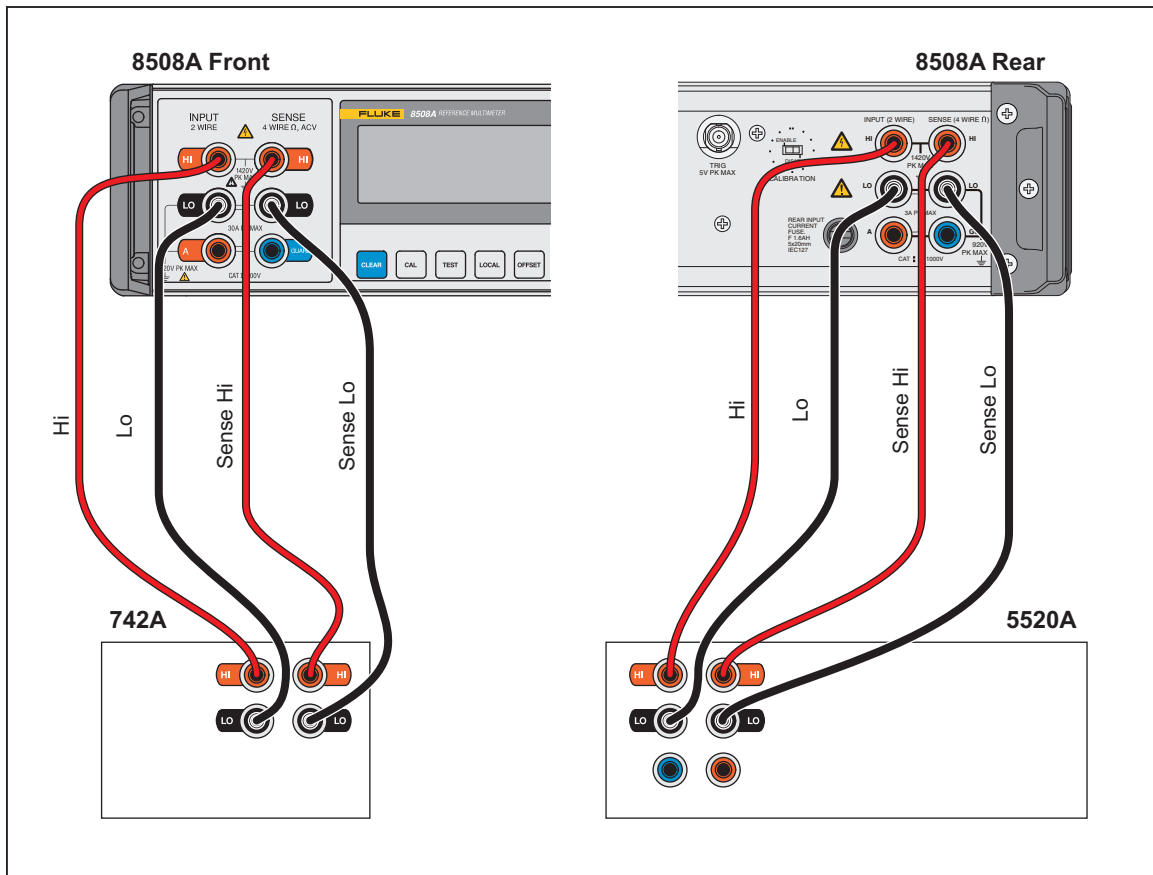

Figure 7. Ohms Input Performance Test Connections

gxm015.eps

Use the 742A-1K for the 400 Ω range. Use the 742A-10K for the 4 K Ω range. For more information about how to use the ratio mode, see the *8508A Operators Manual*. Note the ratio indication on the 8508A in Table 8. Use the formula: (742A actual value/ratio indication x 100 = actual 5522A actual value). Start with the 7526A in the 400 Ω range. After the 400 Ω test, change the 7526A to the 4000 Ω range.

Table 8. Ohms Ratio Table

Range	742A Value (Ω)	Ratio	5522A Actual Value (Ω)	7526A Reading	90-Day Specification	1-Year Specification
0 Ω					0.0035 Ω	0.004 Ω
25 Ω					0.004 Ω	0.0045 Ω
75 Ω					0.005 Ω	0.0055 Ω
95 Ω					0.0054 Ω	0.0059 Ω
100 Ω					0.0055 Ω	0.0060 Ω
105 Ω					0.0056 Ω	0.0061 Ω
150 Ω					0.0065 Ω	0.007 Ω
300 Ω					0.0095 Ω	0.010 Ω
400 Ω					0.0115 Ω	0.012 Ω
0 Ω					0.035 Ω	0.04 Ω
250 Ω					0.04 Ω	0.045 Ω
750 Ω					0.05 Ω	0.055 Ω
1000 Ω					0.055 Ω	0.06 Ω
1500 Ω					0.065 Ω	0.07 Ω
2000 Ω					0.075 Ω	0.08 Ω
3000 Ω					0.095 Ω	0.10 Ω
4000 Ω					0.115 Ω	0.12 Ω

To test the ohm input:

1. Apply a four-wire short to the Product 4W RTD/ Ω input.
2. For the first test, set the Product to the 400 Ω range.
3. For the second test, connect the Product 4W RTD/ Ω input to the output of the 5522A as shown in Figure 8.
4. Set the Product to the 400 Ω range. Note the indication in Table 8.
5. Set the Product to the 4000 Ω range after the 400 Ω test. Note the indication in Table 8.
6. Output the same nominal values and note the Product indication in the 7526A Reading column of Table 8.
7. Subtract the 5522A Actual Value from the 7526A Reading and ensure that it is within the specified tolerance.

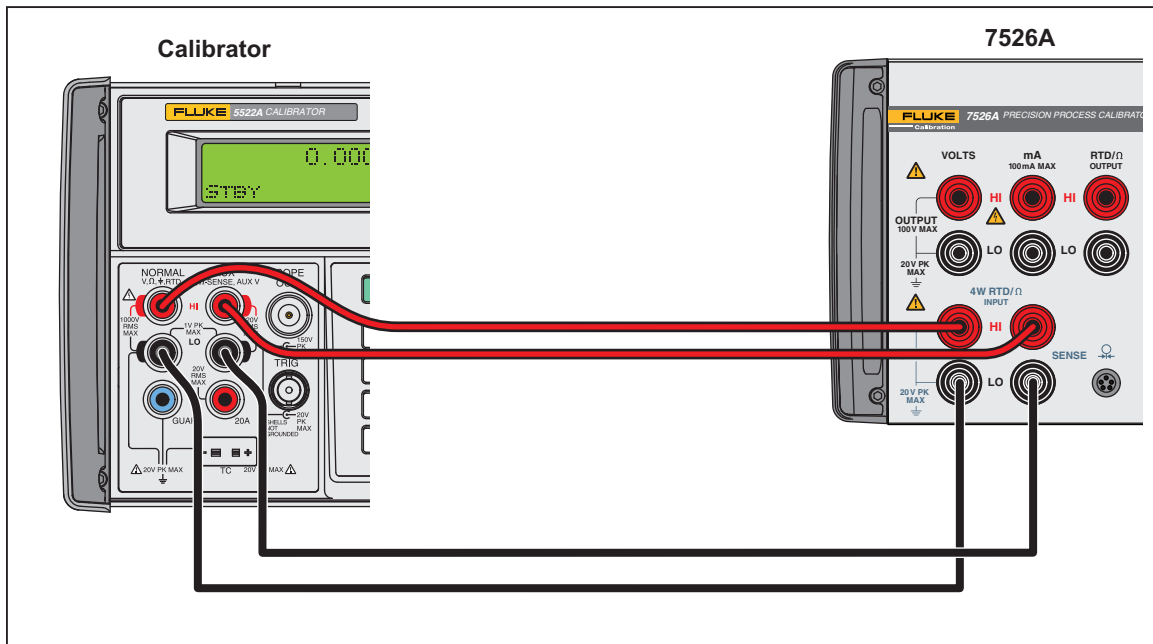

Figure 8. Ohms Measurement Performance Test Connections

gxm016.eps

Pressure Modules

The Fluke 700 and 525A-P series pressure modules are calibrated separately from the Product. Only a performance test is necessary. Connect any of the Fluke 700 and 525A-P series pressure modules to the pressure module connector. Make sure that the Product reads pressure. See Figure 9 for connections.

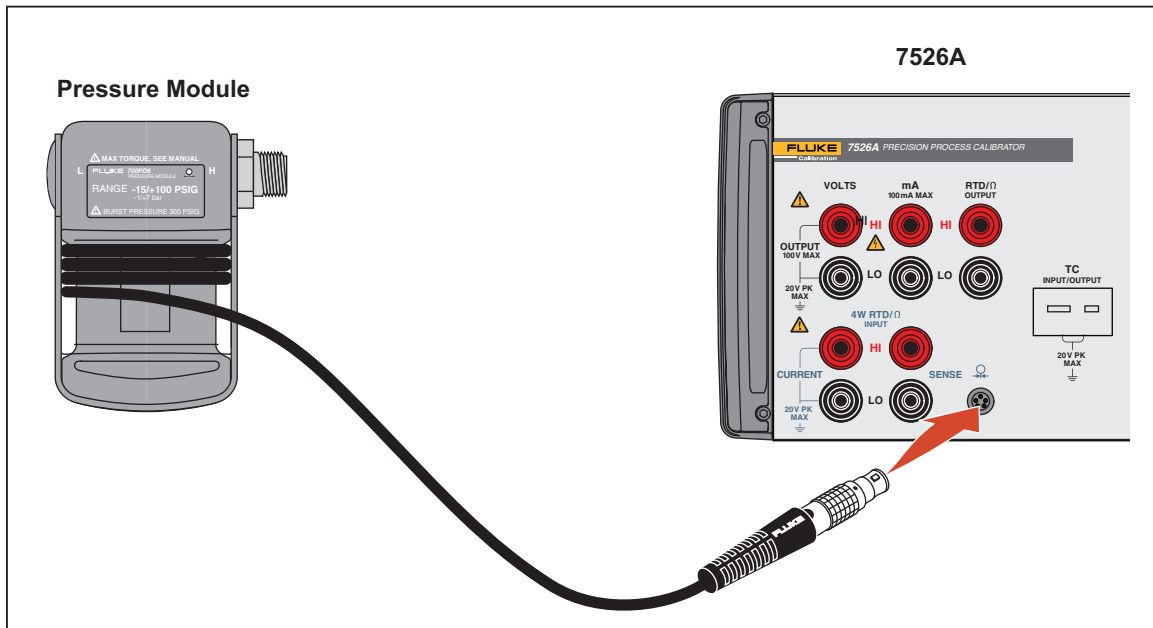

Figure 9. Pressure Module Performance Test Connections

gxm017.eps

Isolated DC Voltage

The isolated dc voltage performance test verifies the accuracy of the isolated dc voltage source output from the front panel of the Product. Connect the 5522A Normal HI and LO to the Product Isolated input HI and LO jacks located on the right side of the Product. Verify the measurements listed in Table 9. See Figure 10 for connections.

Table 9. Isolated DC Voltage

Range	Nominal Value	Measured Value	Deviation %	Specification
10.0 V	0 V			0.0002 V
	2.500 V			0.0003 V
	5.000 V			0.0005 V
	10.000 V			0.0007 V
100.0 V	0 V			0.002 V
	25 V			0.003 V
	50 V			0.005 V
	75 V			0.006 V
	100 V			0.007 V

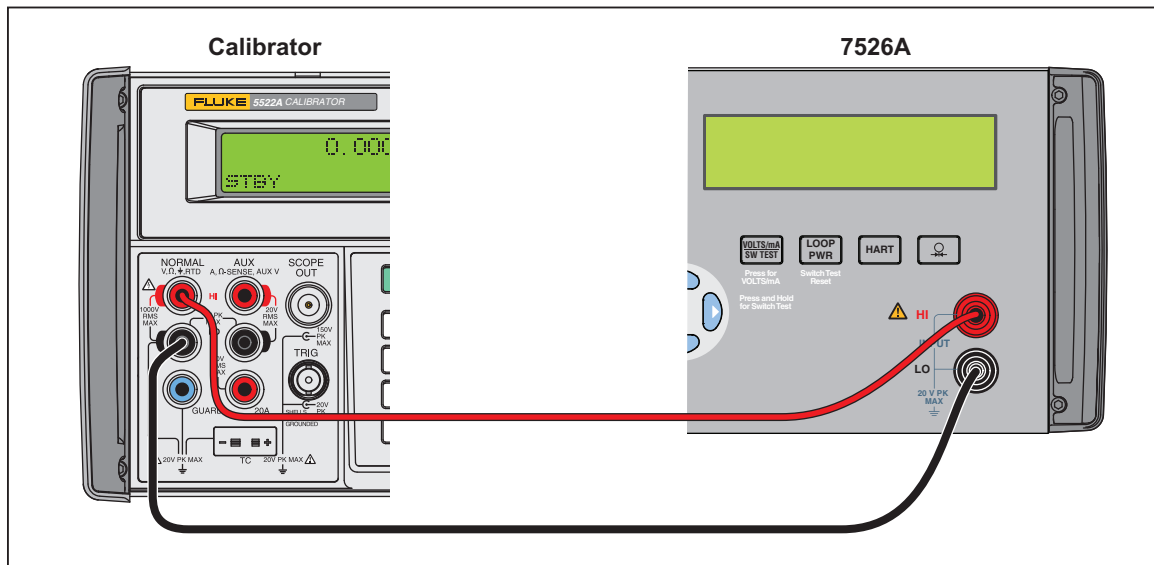

Figure 10. Isolated DC Voltage Performance Test Connections

gxm018.eps

Isolated DC Current

The isolated dc current performance test verifies the accuracy of the isolated dc current source output from the front panel of the Product. Connect 5522A Normal HI to the Product Isolated Input LO. Connect the Product Isolated input HI to 8508A input A. Connect 8508A Input LO to 5522A Normal LO. Use the 8508A to measure the 5522A output as shown in Figure 2. Take the dc current indication from the 8508A as the applied current. Verify the measurements listed in Table 10. See Figure 11 for connections.

Table 10. Isolated DC Current

50 mA Input	8508A Reading	Specification
0.000 mA		0.0010 mA
25.000 mA		0.0035 mA
50.000 mA		0.0060 mA

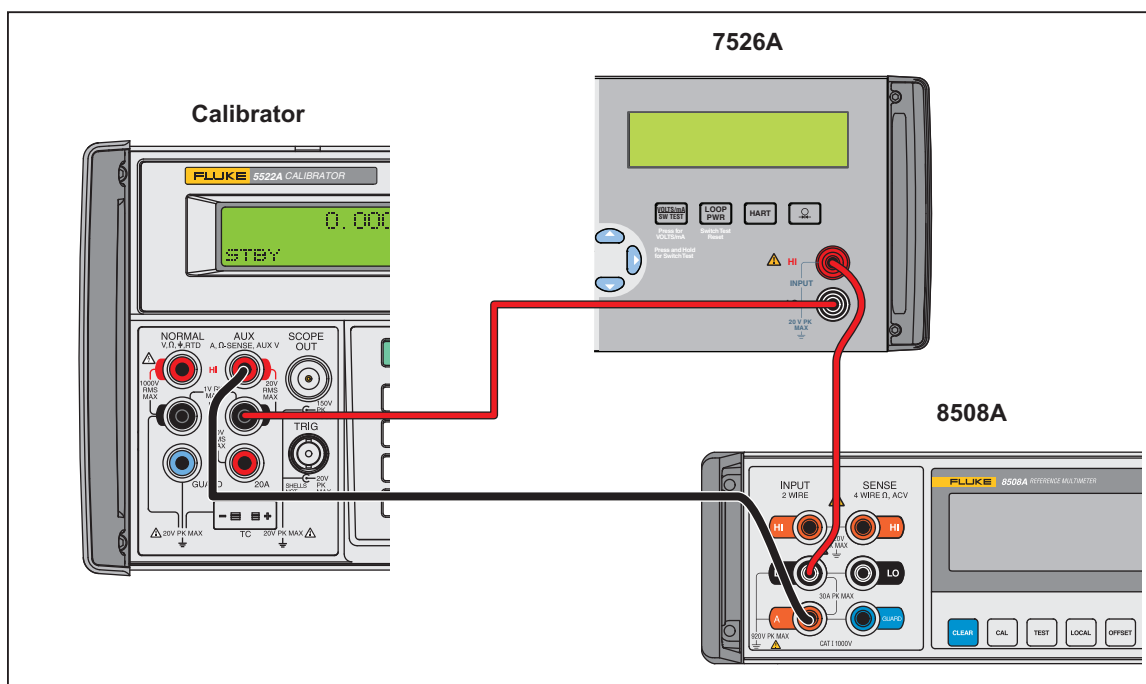

Figure 11. Isolated DC Current Performance Test Connections

gxm019.eps

Isolated Loop Power

1. Connect a 1 k Ω , 1%, 1 W resistor across Isolated Input HI and LO.
2. Set Isolated input to mA.
3. Push **LOOP PWR**. The upper ISO display shows 24 mA LPWR. The indication on the ISO lower display must be between 26.300 mA to 21.500 mA to pass.
4. Push **HART**. The indication must be between 21.336 mA to 17.104 mA to pass.

The verification procedure is complete. If any steps did not pass, adjustment or repair is necessary.

Calibration Adjustment

The Product features electronic calibration adjustment. There are no mechanical adjustments. Calibration adjustment is done with the case closed through the serial communications port that sends and receives commands and readings with a RS232 interface.

The adjustment procedure for resistance measure is flexible to allow for the use of fixed resistors. See Table 3 for the required equipment.

Initiate Communication

Terminal communications can be set up with terminal communication software on a personal computer (PC). Connect a 9-pin null modem cable to the RS232 connector on the back of the Product. Connect the other end of the cable to the PC/PC serial port. An adapter may be necessary for terminals that use 25 pin “D” serial connectors. A terminal program, such as Windows HyperTerminal, can be used in the PC. The terminal settings must be set as follows:

- Bits per second: 9600
- Data bits: 8
- Parity: None
- Stop bits: 1
- Flow control: None
- Local echo: on

Starting Adjustment Mode

The Product temperature must be stable before calibration adjustments are done. Make sure the Product has warmed up for a minimum of 30 minutes. To start the calibration mode, use the PC terminal program to send the CAL_START command.

The PC shows:

Calibration is password protected

Enter Password:

Correctly enter the password with the PC keyboard. The password is **525**.

The PC shows the calibration adjustment steps:

Calibration Menu

1: 100 mV Source

2: 1 V Source

3: 10 V Source

4: 100 V Source

5: 100 mA Source

6: Hi Ohms Source

7: Low Ohms Source

8: Hi Ohms Measure

9: 1K Ohms Measure

10: Low Ohms Measure

11: 100 Ohms Measure

12: TC SOURCE

13: TC READ

14: TC CJC

15: mA Read

16: 10V Read

17: 100V Read

18: Exit

Enter Selection:

Adjustment Sequence

Calibration adjustment is a menu-driven process. Fluke Calibration recommends that calibration be done in the order specified by the menu. However, each step is independent and can be performed separately if necessary, with the exception of the TC function. The TC calibration adjustment must be done in the order shown in the menu (steps 1-18). TC read uses the internal source mode and it must be adjusted after TC source. Do not source with an external instrument for TC read. Connect a DMM and adjust the output to the necessary value with the PC keyboard.

Exit the calibration mode at any time by typing **18**.

Steps 1 through 4: DC mV and DC V Source Adjustment

Voltage output adjustment is done for four distinct ranges. Each range can be adjusted separately with menu selections 1 through 4. The adjustment of each range uses the same procedure and is done in two parts. The first part sets the zero and span values. The second part fine-adjusts the zero, span, and adjusts the linearity if necessary. See Table 3 for the test equipment used for this procedure.

Connect the Product volts HI and LO to the DMM input. Set the DMM to measure dc volts. See Figure 12 for connections.

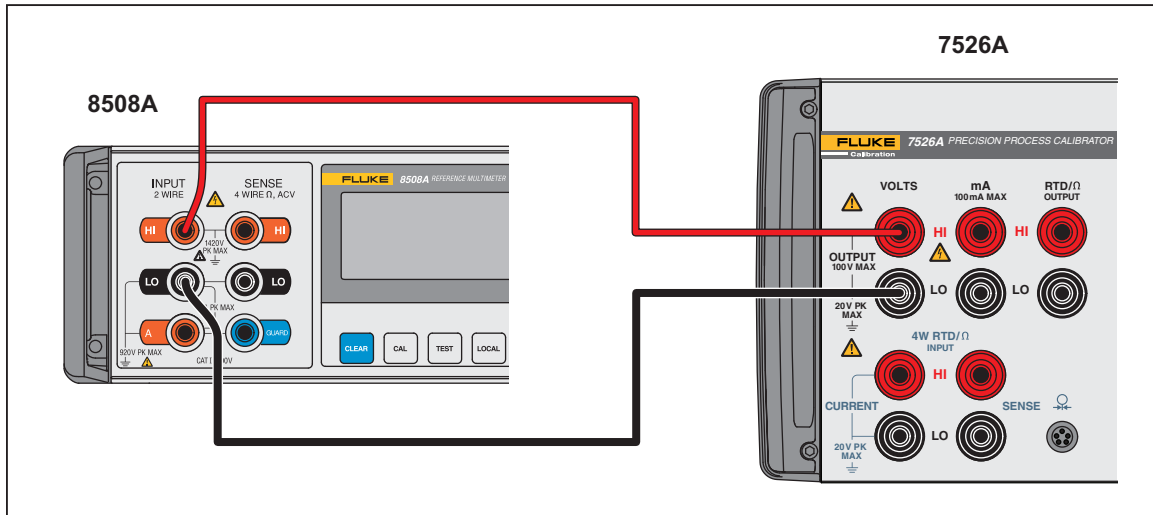

Figure 12. DC Volts Source Performance Test Connections

gxm020.eps

Enter **2** on the PC to choose the 1 V source calibration.

The value for the first calibration point (approximately 0 V) will be sourced by the Product. When the output is stable, type the value shown on the DMM. After the value is entered, the value for the second calibration point (approximately 1 V) will be sourced by Product. Type the new value to complete the 1 V source calibration.

Step 5: 100 mA Source - DC Current Source Adjustment

The dc current output adjustment uses similar calibration steps to the voltage source calibration. The adjustment is done in two parts. The first part sets the zero and span values. The second part fine adjusts the zero, span and the linearity if necessary. Table 3 for the test equipment used for this procedure. See Figure 13 for connections.

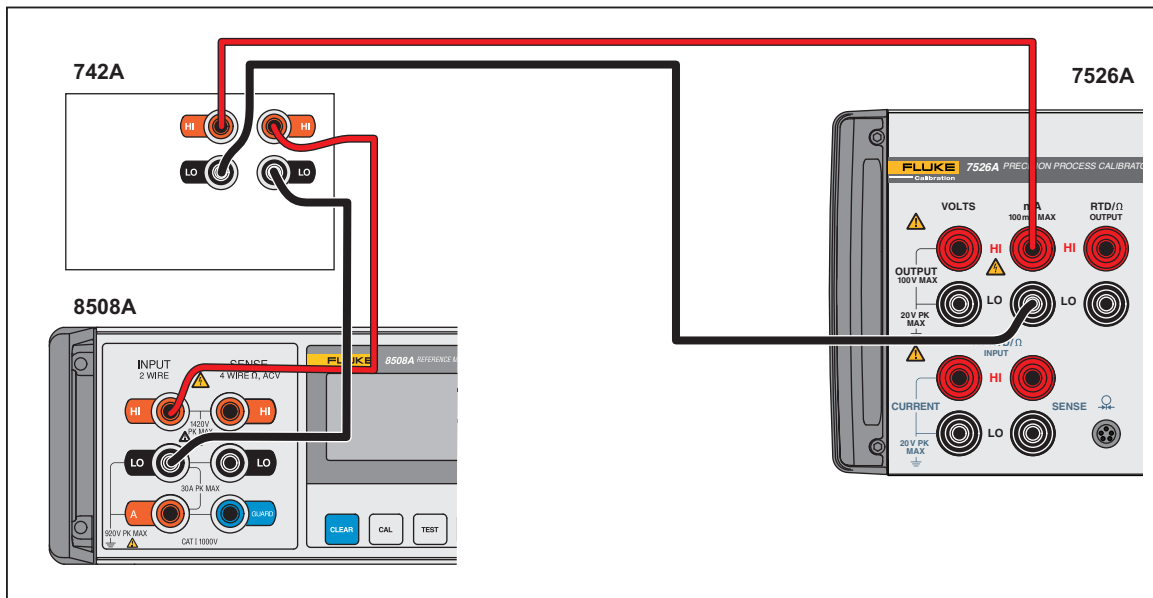

Figure 13. High and Low Ohms Adjustment Connections

gxm023.eps

The voltage is measured across a 10 Ω shunt resistor instead of measuring current directly. Readings from the DMM must be converted to mA (multiplied by 100) before they can be entered with the PC. Set the DMM to read DC Volts.

Enter 5 on the PC. The calibration procedure for current output is similar to voltage output except there is only one range and the voltage is measured across a 10 Ω shunt resistor instead of a direct current measurement. Readings from the DMM must be converted to mA (multiplied by 100) before they can be entered on the PC.

Steps 6 and 7: Hi Ohms Source and Low Ohms Source Adjustment

When the 5 Ω - 4000 Ω output range (high ohms source) is calibrated, the Product outputs two calibration points. After the output becomes stable, the values are entered at the PC. See Table 3 for the test equipment used for this procedure. See Figure 14 for connections.

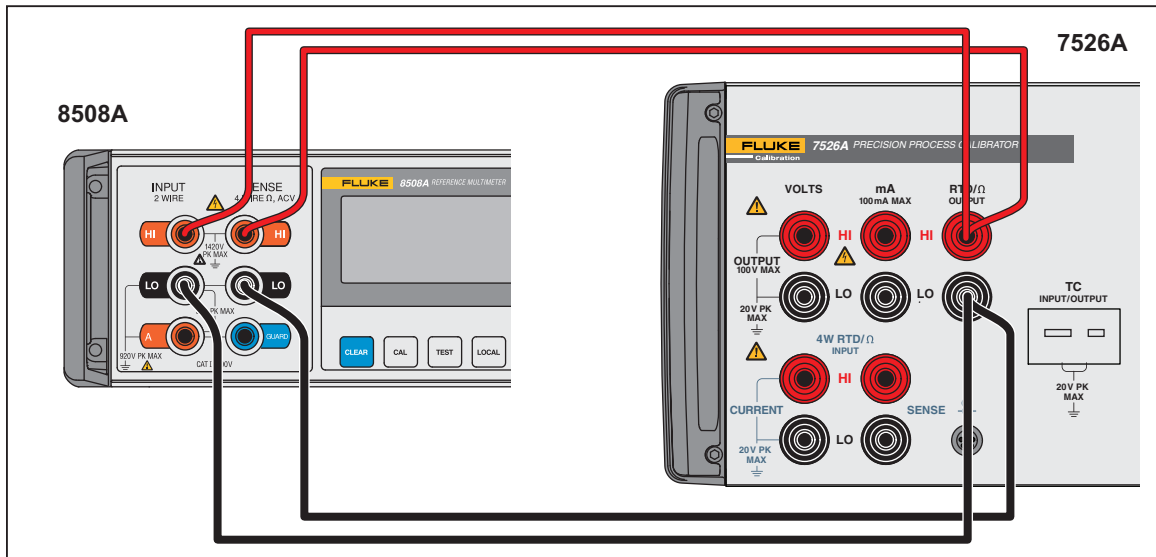

Figure 14. Hi Ohms Source and Low Ohms Source Adjustment Connections

It is important that the sense leads be on the bottom of the stack on the Product ohms source jacks.

1. Set the DMM to measure 4-wire ohms.
2. The calibration of the 5 Ω - 4000 Ω output range (high ohms source) is similar to the voltage source calibration. The Product outputs two calibration points. After the output becomes stable, enter the values on the PC.

It is recommended to lock the DMM in the proper range (first range greater than 4000 Ω). The maximum excitation current of the DMM is 1 mA.

3. Enter the ohms shown on the DMM at the PC. The Product sources the maximum value.
4. Enter the ohms shown on the DMM at the PC. After the value has been entered for the second calibration point you will return to the main calibration menu.

The calibration of the 5 Ω - 400 Ω output range (low ohms source) is similar. The maximum excitation current of the DMM is 3 mA.

Steps 8 through 11: 100 Ohms Measure, Resistance Measure Adjustment

The ohms measure calibration adjustment allows the use of a medium-quality resistor decade in conjunction with a good-quality DMM by using flexible calibration points. This way, if resistance standards are not available, the resistor decade can be set to 1 K, the actual value of the DMM value can be read (1002.45 Ω for example), and this value can be entered when asked for 1000 Ω .

You can use a resistor decade box, adjustable in 25 Ω to 4000 Ω range, to cover all of the values that are requested (maximum 5 % tolerance):

- 25 Ω
- 50 Ω
- 100 Ω
- 200 Ω
- 400 Ω
- 1000 Ω
- 2000 Ω
- 4000 Ω

The subsequent procedure uses the Fluke 5522 for ohms source to adjust the Product reading. See Table 3 for the test equipment used for this procedure. See Figure 15 for connections.

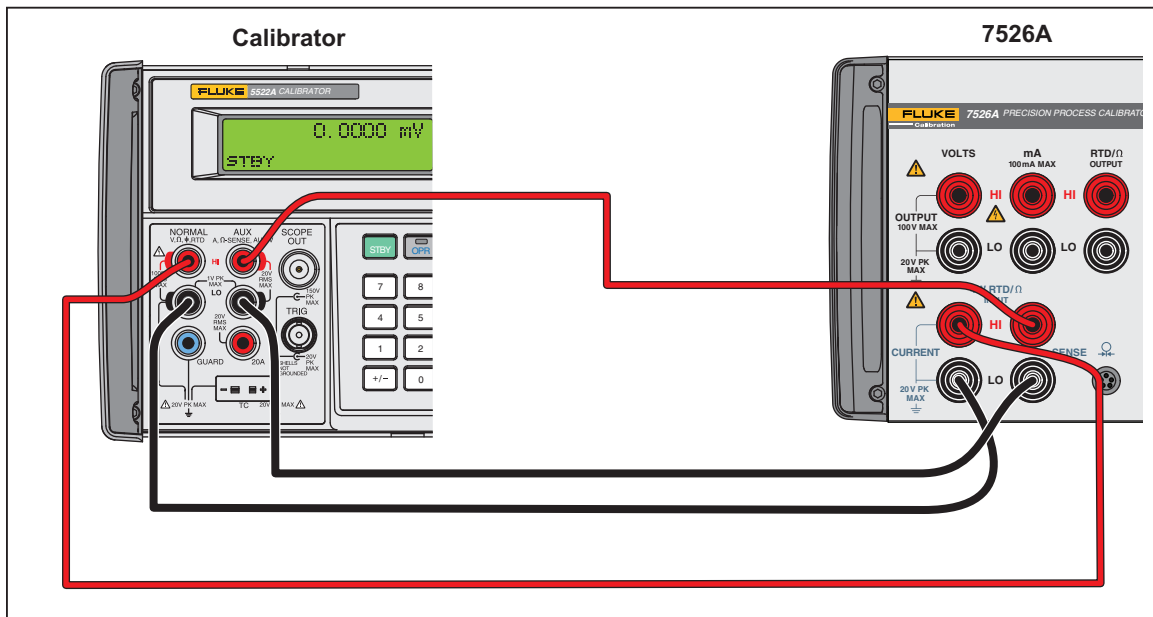

Figure 15. 100 Ohms Measure, Resistance Measurement Adjustment Connections

gxm024.eps

This adjustment procedure requests approximately:

- 1000 Ω
- 2000 Ω
- 4000 Ω

The actual value used must be entered.

1. For the 0 Ω connection, connect a short to the 4 terminals for 4W RTD/ Ω .
2. For the 5522A connections, see Figure 15 for connections.
3. Follow the steps in the menu.
4. Use the 5522A to enter 4000 Ω (nominal) and enter the actual value calculated as described above.
5. Repeat for all calibration points.

Step 12: TC SOURCE, TC mV Source Adjustment

The adjustment of the TC Source output range is similar to the first part of the voltage source calibration. Use the test leads and a DMM for this procedure.

Use a copper TC mini-plug cable with low thermal EMF jacks on the other end to connect the Product to the DMM. Make sure the polarity is correct. Set the DMM to read dc volts.

Enter **12** at the PC. The calibration of the TC source output range is similar to the first part of the voltage source calibration. The Product outputs two calibration points, after the output becomes stable, enter the values on the PC.

After the mV reading on the DMM is entered, you are prompted to enter the second calibration point.

Step 13: TC Read, TC mV Measure Adjustment

The adjustment of the TC source output range is similar to the first part of the voltage source calibration. The Product outputs two adjustment points. After the output becomes stable, the values can be entered at the PC. Use the test leads and a DMM for this procedure.

Use a copper TC mini-plug cable with low thermal EMF jacks on the other end to connect the Product to the DMM. Make sure the polarity is correct. Set the DMM to read dc volts.

Enter **13** on the PC. The calibration of the TC read input range is based on the TC source. Make sure that TC source is calibrated first.

The Product sources 5 calibration points:

- -10 mV
- 15 mV
- 40 mV
- 65 mV
- 75 mV

For each test point, push 8 and 2 on the PC to adjust the output if necessary. Use the 8508A indication to monitor this voltage. After the output is within 1 μ V of the necessary value, push ENTER on the PC to go to the next calibration point.

Step 14: TC Cold Junction Temperature (TC CJC) Adjustment

The Calibration of the thermocouple cold junction temperature (TC CJC) is a critical part of the adjustment process. It is important that the thermocouple junction be completely stable. Use the precision thermometer, E thermocouple probe, lag bath, and thermistor probe for this procedure. See Figure 4 for connections.

The precision thermometer probe must already be in the lag bath along with the E thermocouple probe. Plug the mini-plug on the E thermocouple probe into the TC jack on the Product.

Enter **14** at the PC. It is important that the thermocouple junction be completely stable. After the TC junction is stable, enter the temperature from the temperature reference.

Push ENTER on the PC to return to the calibration menu.

Step 15: mA Read Adjustment

Connect 5522A mA source jacks to Product isolated jacks and add the 742A-1 resistance standard in series. Use the sense jacks of the resistor to monitor the voltage drop on the resistor with the 8508A DMM. See Table 3 for the test equipment used for this procedure.

Connect 5522A mA source jacks to the Product isolated jacks and add the 742A-1 resistance standard in series. Use the sense jacks of the resistor standard to monitor the voltage drop on the resistor with the 8508A DMM. See Table 3 for the test equipment used for this procedure. See Figure 16 for connections.

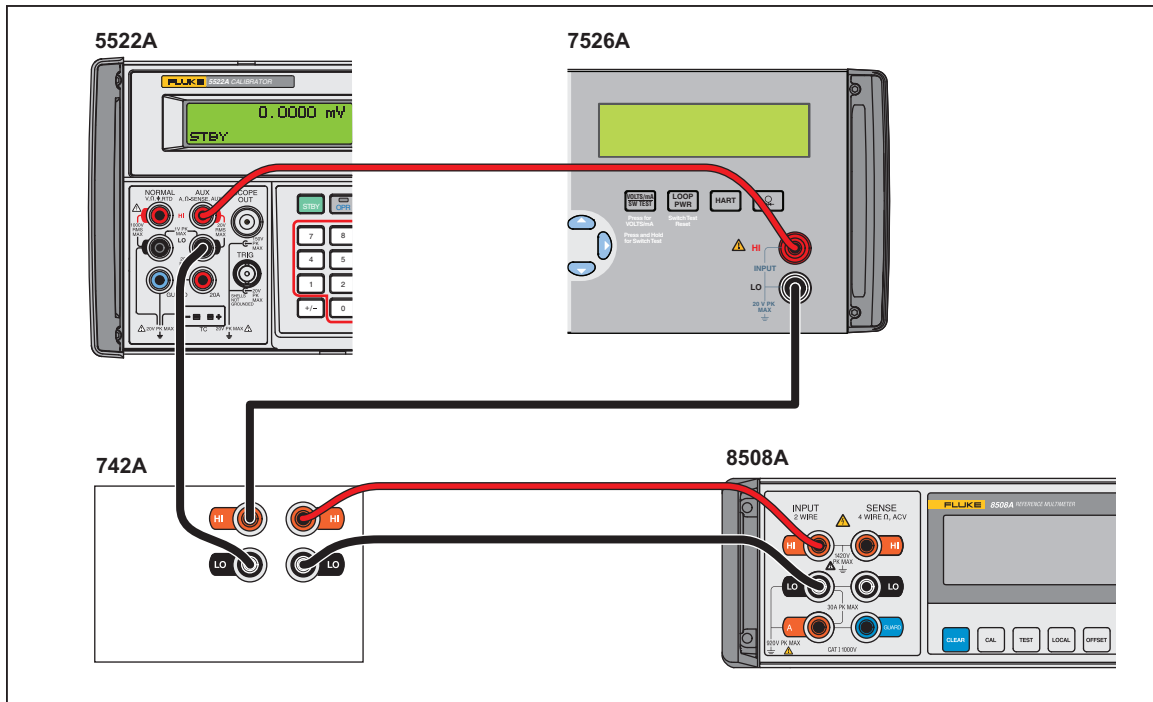

Figure 16. mA Read Adjustment Connections

gxm026.eps

Enter **15** at the PC. Source five calibration points from the 5522A:

- 0 mA
- 13 mA
- 26 mA
- 39 mA
- 52mA

For each calibration point adjust the current for the maximum accuracy with the DMM indication as feedback. Push ENTER on the PC when stable to go to the next calibration point.

Step 16: 10 V Read Adjustment

Connect 5522A V source jacks to 7526A isolated jacks. Use the 8508A DMM to monitor the voltage.

Enter **16** on the PC. Source three calibration points from the 5522A:

- 0 V
- 5 V
- 10 V

For each calibration point, adjust the voltage for the maximum accuracy. Use the DMM indication as feedback. Push ENTER on the PC when stable to go to the next calibration point. See Table 3 for the test equipment used for this procedure. See Figure 17 for the connections.

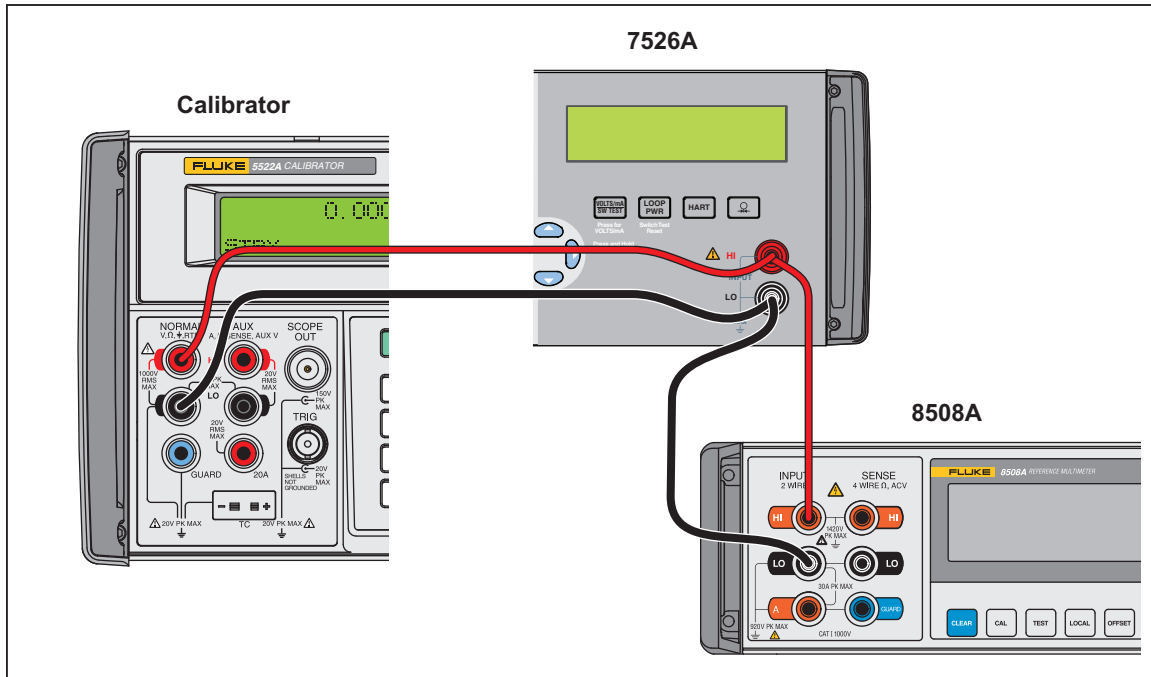

Figure 17. 10 V Read Adjustment Connections

gxm022.eps

Step 17: 100 V Read Adjustment

Use the test equipment shown in Table 3. Connect the 5522A V source jacks to the Product isolated jacks. Use the 8508A DMM to monitor the voltage. See Figure 17 for the connections.

Enter **17** on the PC. Source three calibration points from 5522A:

- 0 V
- 50 V
- 100 V

For each calibration point, adjust the voltage for the maximum accuracy. Use the DMM indication as feedback. Push ENTER on the PC when stable to go to the next calibration point.

Calibration is complete. Enter **18** at the PC to exit calibration mode.

User-Replaceable Parts

User-replaceable parts are listed in Table 11 and shown in Figure 18. To get parts and accessories, see the “Contact Fluke Calibration” section.

Table 11. User-Replaceable Parts

Item Number	Fluke Part Number	Description	Quantity
①	4285232	7526A Chassis, Base and Top	1
②	295105	Allen Head Screw	20
③	3693680	Chassis Cap	2
④	3468883	Chassis Handles with Grip	2
⑤	4285267	7526A Front Panel Decal	1
⑥	4285271	7526A Keypad	1
⑦	886382	Red 5-Way Binding Post	6
⑧	886379	Black 5-Way Binding Post	6
⑨	868786	Plastic Feet	4
⑩	152165	#6 X 3/8 in. Screw, PH	1
⑪	1601078	Programming Door	1
⑫	△1645311	Fuse, (1/4A), Fuse for 120 VAC (nominal)	2
⑬	△1645327	Fuse, (1/8A), Fuse for 240 VAC (nominal)	2
⑭	448092	Jack Screw RS232 Conn	1
⑮	102889	Binding Head Thumbscrew	1
Not Shown	320093	Flathead Screw	10
Not Shown	859939	#8 Washer, Low Thermal	28
Not Shown	850334	8-32 Nut, Low Thermal	24
Not Shown	1640305	Nylock Nut 6-32	5
Not Shown	1618621	Line Cord, 3 COND	1
Not Shown	4181286	7526A Manual CD-Rom	1
Not Shown	4218030	7526A <i>Getting Started</i>	1
△ To ensure safety, use exact replacement only.			

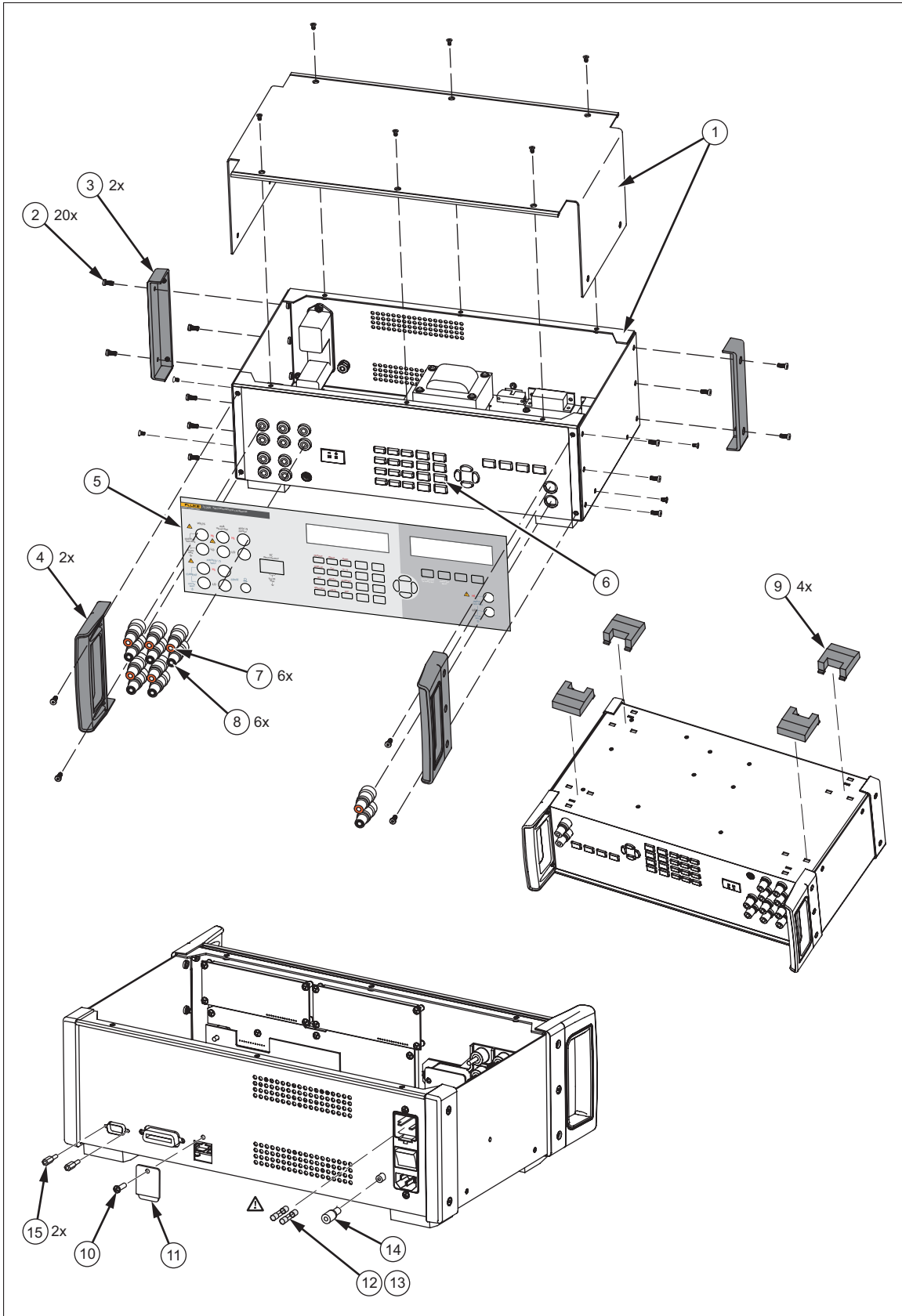

Figure 18. User-Replaceable Parts

gxm027.eps

Accessories

Accessories for the product are shown in Table 12. To get parts and accessories, see the “Contact Fluke Calibration” section.

Table 12. Accessories

Fluke Part Number	Description
1622027	Fluke Y7526A Rack Mount Kit
946470	RS43, RS232 Null Modem Cable
7526A-CASE	Carrying Case
1618621	120 V Line Cord (US Plug)
769422	240 V Line Cord (Schuko Plug)
658641	240 V Line Cord (Australian Plug)
769448	240 V Line Cord (Swiss Plug)
769455	240 V Line Cord (UK Plug)

