

7526A

Precision Process Calibrator

Getting Started

LIMITED WARRANTY AND LIMITATION OF LIABILITY

Each Fluke product is warranted to be free from defects in material and workmanship under normal use and service. The warranty period is one year and begins on the date of shipment. Parts, product repairs, and services are warranted for 90 days. This warranty extends only to the original buyer or end-user customer of a Fluke authorized reseller, and does not apply to fuses, disposable batteries, or to any product which, in Fluke's opinion, has been misused, altered, neglected, contaminated, or damaged by accident or abnormal conditions of operation or handling. Fluke warrants that software will operate substantially in accordance with its functional specifications for 90 days and that it has been properly recorded on non-defective media. Fluke does not warrant that software will be error free or operate without interruption.

Fluke authorized resellers shall extend this warranty on new and unused products to end-user customers only but have no authority to extend a greater or different warranty on behalf of Fluke. Warranty support is available only if product is purchased through a Fluke authorized sales outlet or Buyer has paid the applicable international price. Fluke reserves the right to invoice Buyer for importation costs of repair/replacement parts when product purchased in one country is submitted for repair in another country.

Fluke's warranty obligation is limited, at Fluke's option, to refund of the purchase price, free of charge repair, or replacement of a defective product which is returned to a Fluke authorized service center within the warranty period.

To obtain warranty service, contact your nearest Fluke authorized service center to obtain return authorization information, then send the product to that service center, with a description of the difficulty, postage and insurance prepaid (FOB Destination). Fluke assumes no risk for damage in transit. Following warranty repair, the product will be returned to Buyer, transportation prepaid (FOB Destination). If Fluke determines that failure was caused by neglect, misuse, contamination, alteration, accident, or abnormal condition of operation or handling, including overvoltage failures caused by use outside the product's specified rating, or normal wear and tear of mechanical components, Fluke will provide an estimate of repair costs and obtain authorization before commencing the work. Following repair, the product will be returned to the Buyer transportation prepaid and the Buyer will be billed for the repair and return transportation charges (FOB Shipping Point).

THIS WARRANTY IS BUYER'S SOLE AND EXCLUSIVE REMEDY AND IS IN LIEU OF ALL OTHER WARRANTIES, EXPRESS OR IMPLIED, INCLUDING BUT NOT LIMITED TO ANY IMPLIED WARRANTY OF MERCHANTABILITY OR FITNESS FOR A PARTICULAR PURPOSE. FLUKE SHALL NOT BE LIABLE FOR ANY SPECIAL, INDIRECT, INCIDENTAL, OR CONSEQUENTIAL DAMAGES OR LOSSES, INCLUDING LOSS OF DATA, ARISING FROM ANY CAUSE OR THEORY.

Since some countries or states do not allow limitation of the term of an implied warranty, or exclusion or limitation of incidental or consequential damages, the limitations and exclusions of this warranty may not apply to every buyer. If any provision of this Warranty is held invalid or unenforceable by a court or other decision-maker of competent jurisdiction, such holding will not affect the validity or enforceability of any other provision.

Fluke Corporation
P.O. Box 9090
Everett, WA 98206-9090
U.S.A.

Fluke Europe B.V.
P.O. Box 1186
5602 BD Eindhoven
The Netherlands

Table of Contents

Title	Page
Introduction.....	1
Contact Fluke Calibration	1
Safety Information	2
Unpack the Product.....	3
Standard Equipment.....	4
Options and Accessories	4
Product Description	5
Front Panel Overview	5
Primary Input/Output Terminals	6
Primary Input/Output Display and Controls.....	7
Isolated Input Display, Controls, and Terminals	10
Rear Panel.....	11
Display Layouts.....	12
Error Messages	15
Getting Started	15
Specifications.....	16
General Specifications	16
DC Voltage Specifications, Output	17
DC Voltage Specifications, Isolated Input	17
DC Current Specifications, Output.....	17
DC Current Specifications, Isolated Input.....	17
Resistance Specifications, Output	18
Resistance Specifications, Input	18
Thermocouple Specification, Output and Input	19
RTD and Thermistor Specification, Output	20
RTD and Thermistor Specification, Input	21
Pressure Measurement Specifications	22
Switch Test Specifications, Isolated Input	22

List of Tables

Table	Title	Page
1.	Symbols.....	3
2.	Error Messages.....	15
3.	Line Voltage Settings.....	15

List of Figures

Figure	Title	Page
1.	Front Panel	5
2.	Primary Input/Output Terminals	6
3.	Primary Input/Output Display and Controls	7
4.	Isolated Input Display, Controls, and Terminals.....	10
5.	Rear Panel	11
6.	Primary Voltage and Current Display	12
7.	Primary Thermocouple and RTD Display	13
8.	Primary and Isolated Pressure Display.....	14
9.	Isolated Voltage and Current Display	14

Introduction

The Fluke 7526A Precision Process Calibrator (the “Product” or “Calibrator”) is an accurate, full-featured temperature, pressure, and DC calibrator. The Calibrator is meant for research and development, manufacturing, and calibration lab procedures. The Product operation is easy and you will quickly understand its operations and features.

Some time-saving features let you:

- Save, recall, and automatically move through setpoints for each output range
- Record user-defined RTD curves
- Remotely interface with the Product

For complete use instructions, see the Users Manual found on the product CD-ROM.

Contact Fluke Calibration

To contact Fluke Calibration, call one of the subsequent telephone numbers:

- Technical Support USA: 1-877-355-3225
- Calibration/Repair USA: 1-877-355-3225
- Canada: 1-800-36-FLUKE (1-800-363-5853)
- Europe: +31-40-2675-200
- Japan: +81-3-6714-3114
- Singapore: +65-6799-5566
- China: +86-400-810-3435
- Brazil: +55-11-3759-7600
- Anywhere in the world: +1-425-446-6110

To see product information and download the latest manual supplements, visit Fluke Calibration’s website at www.flukecal.com.

To register your product, visit <http://flukecal.com/register-product>.

Safety Information

A **Warning** identifies conditions and procedures that are dangerous to the user; A **Caution** identifies conditions and procedures that could cause Product damage, equipment under test damage, or permanent loss of data.













Warnings

To prevent possible electrical shock, fire, or personal injury:

- Read all safety information before you use the Product.
- Carefully read all instructions.
- Use the Product only as specified, or the protection supplied by the Product can be compromised.
- Use this Product indoors only.
- Examine the case before you use the Product. Look for cracks or missing plastic. Carefully look at the insulation around the terminals.
- Use only the mains power cord and connector approved for the voltage and plug configuration in your country and rated for the Product.
- Replace the mains power cord if the insulation is damaged or if the insulation shows signs of wear.
- Make sure the ground conductor in the mains power cord is connected to a protective earth ground. Disruption of the protective earth could put voltage on the chassis that could cause death.
- Do not put the Product where access to the mains power cord is blocked.
- Do not touch voltages > 30 V ac rms, 42 V ac peak, or 60 V dc.
- Use only cables with correct voltage ratings.
- Do not apply more than the rated voltage, between the terminals or between each terminal and earth ground.
- Do not use the Product around explosive gas, vapor, or in damp or wet environments.
- Remove all probes, test leads, and accessories that are not necessary for the measurement.
- Do not use the Product if it operates incorrectly.
- Do not use and disable the Product if it is damaged.

Table 1 shows the symbols used on the Product and in this manual.

Table 1. Symbols

Symbol	Definition	Symbol	Definition
	Risk of Danger. Important information. See Manual.		This product complies with the WEEE Directive (2002/96/EC) marking requirements. The affixed label indicates that you must not discard this electrical/electronic product in domestic household waste. Product Category: With reference to the equipment types in the WEEE Directive Annex I, this product is classed as category 9 "Monitoring and Control Instrumentation" product. Do not dispose of this product as unsorted municipal waste. Go to Fluke's website for recycling information.
	Hazardous voltage. Risk of electric shock.		Fuse
	AC (Alternating Current)		Protective Earth Ground
	Earth ground		Conforms to European Union directives.
	AC (Alternating Current) and DC (Direct Current)		DC (Direct Current)
	This product has been tested to the requirements of CAN/CSA-C22.2 No. 61010-1, third edition.		Pressure

Unpack the Product

When you receive the Product, examine the container and equipment for signs of damage. Note indications of damage while in transit. Immediately report damage to the shipping agent.

Note

The carrier will not honor claims unless all shipment material is kept for their inspection.

After you examine and remove the contents, keep the package material and carton in the case that shipment is necessary.

Remove the Package List and make sure that all of the shown equipment is received. If there are questions about the shipment, contact Fluke. See the "Contact Fluke Calibration" section.

Standard Equipment

Make sure the basic Calibrator package is complete. It includes:

- The Calibrator
- Users Manual CD-ROM
- Getting Started
- AC Mains Cord
- Thermocouple Shorting Jumper
- NIST Traceable Calibration Report
- USB to Serial Adapter Cable

Options and Accessories

For more information about these accessories and their prices, contact your Fluke representative.

- 5520A-525A Leads kit
- Y7526A Rack Mount kit
- Fluke 700 and 525A-P series pressure modules
- MET/CAL with 7526A Function Select Code (FSC)
- MET/CAL 7526A calibration procedure

Product Description

This section is a general description of the Product.

Front Panel Overview

Figure 1 shows the layout of the front panel. Each of the three primary divisions is given in the subsequent sections.

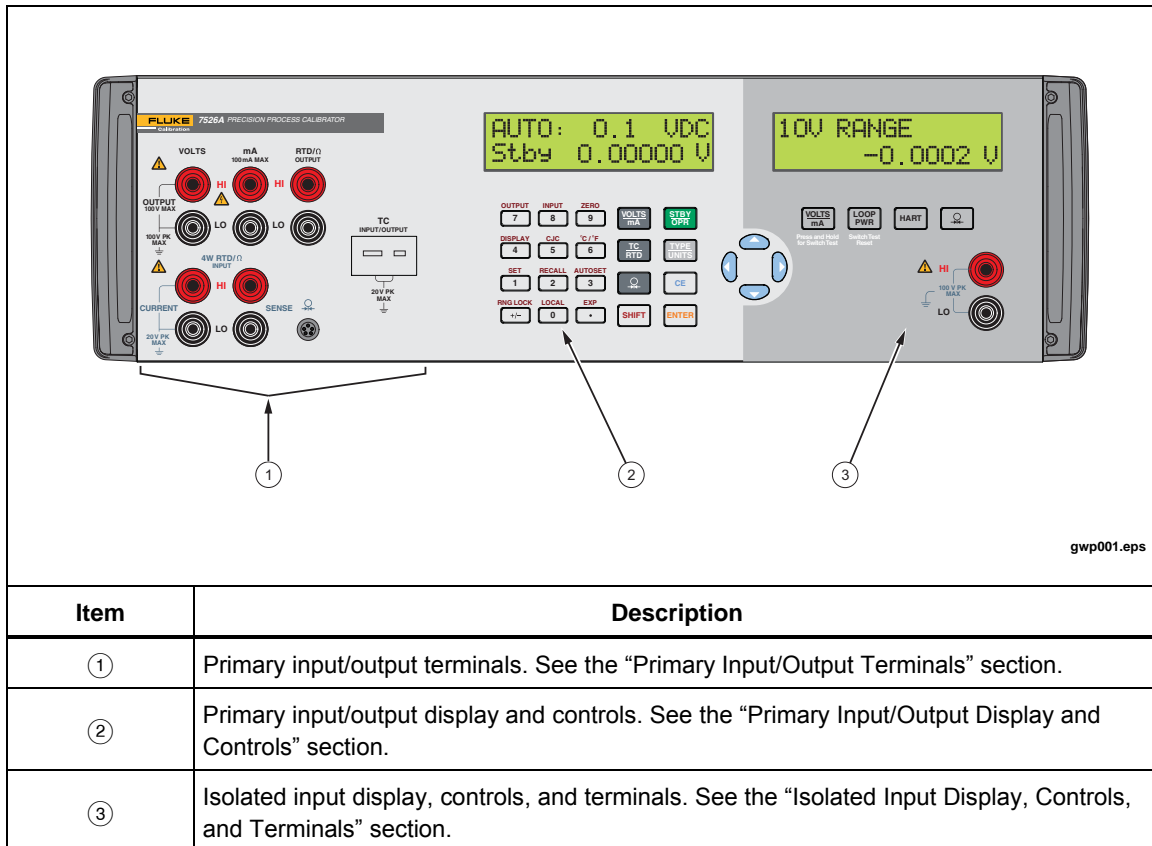
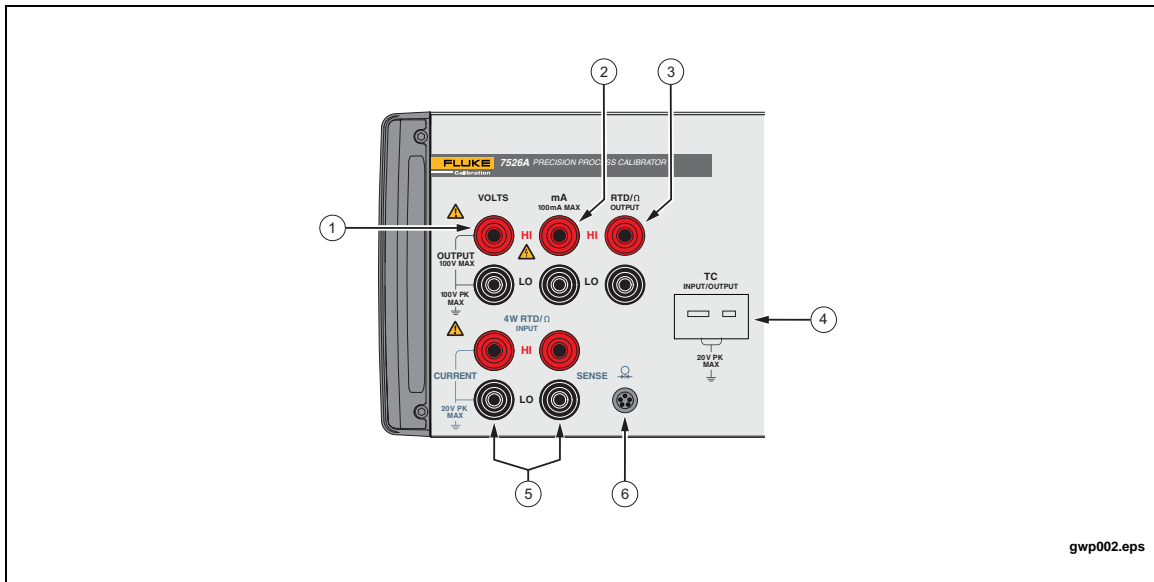

Figure 1. Front Panel

Primary Input/Output Terminals

Figure 2 shows the primary input/output terminals.



Item	Description
①	VOLTS ^[1,2] – DC voltage output terminals
②	mA ^[1,2] – DC current output terminals
③	RTD/Ω OUTPUT ^[1,2] – Two-wire RTD and ohms output terminals
④	TC INPUT/OUTPUT - Thermocouple input and output terminals. These terminals accept a miniature polarized thermocouple plug with flat in-line blades distanced 7.9 mm (0.312 in.) center to center.
⑤	4W RTD/Ω INPUT ^[1,3] – Four-wire RTD and ohms input terminals
⑥	☉ Pressure module input connector
[1]	These terminal binding posts are made of a special copper alloy to decrease thermal EMFs. Discreet wires or standard banana plugs can be used. The HI/LO pairs are distanced for standard dual banana plugs.
[2]	⚠⚠ Warning: To prevent possible electrical shock, fire, or personal injury, do not exceed a maximum of 100 V peak to chassis ground.
[3]	⚠⚠ Warning: To prevent possible electrical shock, fire, or personal injury, do not exceed a maximum of 20 V peak to chassis ground.

Figure 2. Primary Input/Output Terminals

Primary Input/Output Display and Controls

Figure 3 shows the primary input/output display and controls.

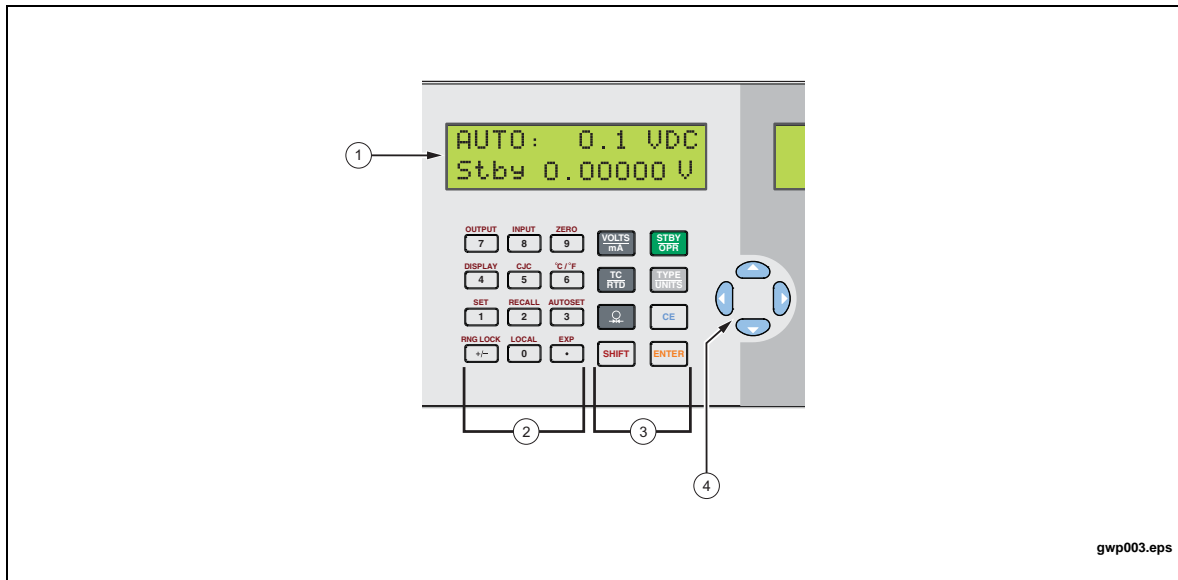

Item	Description	
①	<p>Display: A two-line, 16-character display that gives all visual user feedback for the primary output and input operations. See the “Display Layout” and “Error Messages” section of the Users Manual for more information.</p>	
②	<p>Numeric and Secondary Function Keys: Output value data entry keys. Secondary function selection per the text printed above the numeric key. Push SHIFT and then the numeric key to select the function.</p>	
	<p>SHIFT OUTPUT 7</p>	<p>Change RTD/Ohms or Thermocouple to output mode.</p>
	<p>SHIFT INPUT 8</p>	<p>Change RTD/Ohms or Thermocouple to input mode.</p>
	<p>SHIFT ZERO 9</p>	<p>Zero the input for Pressure, Thermocouple millivolts, or RTD ohms.</p>
	<p>SHIFT SETUP 4</p>	<p>Adjust the LCD Contrast, LCD Backlight, and Remote Interface Configuration as given in “LCD and Remote Interface Setup Procedures” in Chapter 5 of the Users Manual.</p>
<p>SHIFT CJC 5</p>	<p>Select internal or external cold junction compensation for Thermocouple temperature measurements. When external compensation is selected, XCJC is shown at the start of the second line.</p>	

Figure 3. Primary Input/Output Display and Controls



















Item	Description	
②	Numeric and Secondary Function Keys: Output value data entry keys. Secondary function selection per the text printed above the numeric key. Push  and then the numeric key to select the function.	
	 °C/°F 	Select Celsius or Fahrenheit units for RTD and Thermocouple temperature measurements.
	 SET 	Set a new value for a preset output setpoint as given in “Output Setpoints” in Chapter 3 of the Users Manual.
	 RECALL 	Recall a preset output setpoint as given in “Output Setpoints” in Chapter 3 of the Users Manual.
	 AUTOSET 	Start automatic stepping of preset output setpoints as given in “Output Setpoints” in Chapter 3 of the Users Manual.
	 RNG LOCK 	Select Auto-range or Range Lock for voltage output.
	 LOCAL 	Push to regain local control of the Product after the remote command REMOTE is received. In this case, all keys but this one are ignored. When the remote command LOCKOUT is received, all keys are ignored. This includes this key. The remote command LOCAL must be received to regain local control.
 EXP 	Push during entry of a RTD custom curve coefficient to start entry of the exponent.	
③	Function Keys	
		Select dc voltage or current output mode, and toggle between them.
		Select Thermocouple or RTD/Ohms input/output mode, and toggle between them.
		Select Pressure input mode.
	In Thermocouple mode, move through the thermocouple types, this includes millivolts. In RTD/Ohms mode, move through the RTD types, this includes ohms in Pressure mode, move through the pressure units.	

Figure 3. Primary Input/Output Display and Controls (cont.)











		Function Keys
③		For all but Thermocouple output modes, toggle between Standby and Operate modes. In Standby mode, changes to the output value in the display is not applied to the terminals until you select the Operate mode. In Operate mode, each change to the output value in the display is applied to the terminals immediately. Voltages more than 30 V are not applied to the terminals and the mode automatically reverts to Standby for your safety.
		Changes the Product output or parameter to the numeric value typed into the keypad.
		Erases a partial keypad entry and reverts the Product output or parameter to its last known value.
		Prepares for selection of a secondary function with the numeric keypad. The secondary function is shown above each numeric key. The display changes to SHIFT ENABLED until a numeric key is pushed. To cancel the selection, push  again.
④	Cursor Controls	<p>Push  or  to put the cursor below the digit in an output value that is to be increased or decreased.</p> <p>Push  to increment the digit in the output value where the cursor is.</p> <p>Push  to decrement the digit in the output value where the cursor is.</p> <p>The  and  keys are also used to adjust LCD Contrast level, LCD Backlight level, and Remote Interface Configuration selections as given in “LCD and Remote Interface Setup Procedure” in Chapter 5 of the Users Manual.</p>

Figure 3. Primary Input/Output Display and Controls (cont.)

Isolated Input Display, Controls, and Terminals

Figure 4 shows the isolated input display, controls, and terminals.



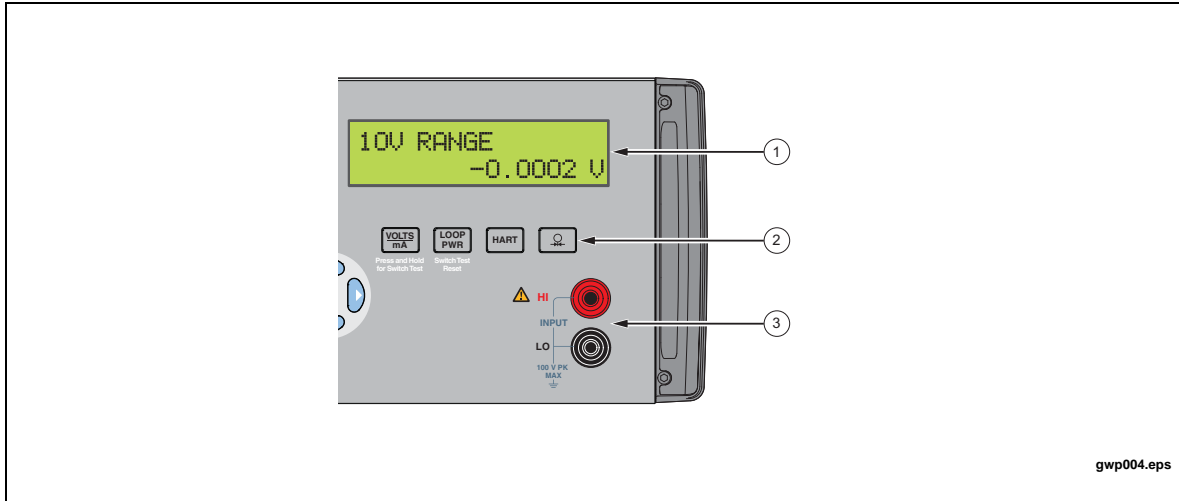



Item	Name	Description
①	Display	A two-line, 16-character display gives all visual user feedback for the isolated input operations. See the “Display Layouts” section of the Users Manual for layout information, and the “Error Messages” section of the Users Manual for possible error messages.
Function Keys		
②		<p>This key is used for multiple functions. In normal operation it is used to move through the 50 mA, 10 V and 100 V ranges.</p> <p>If held for 3 seconds it will change the Product into or out of switctest mode. In switctest recall mode it will move through the stored switch test data.</p>
		<p>When you use 24 mA mode to verify a two-wire loop powered transmitter, disconnect it from its wires and push . This turns on an internal 24 V power supply in series with the current measurement circuit. Push the key again to turn off the 24 V supply. In all switch test modes, push this key to start or stop a test.</p>
		<p>When you use 50 mA mode to verify a HART configuration device, push this key to turn on an internal 250 Ω resistor in series. Push the key again to turn off the resistor. Note that when you turn on this resistor, the maximum load-driving functionality drops from 1000 Ω at 20 mA to 750 Ω at 20 mA.</p>

Figure 4. Isolated Input Display, Controls, and Terminals

Item	Name	Description
②		Selects Pressure input mode. Subsequent pushes of this key cycle through the pressure units. Pressure input mode uses the pressure module connector on the primary input/output side. Each side can use pressure mode at the same time and can be set to show the same pressure measurement in different units if necessary.
③	Input Terminals ^[1,2]	Common input terminals for dc voltage and current.

[1] These terminal binding posts are made of a special copper alloy to decrease thermal EMF's. Discreet wires or standard banana plugs can be used, and the HI/LO pairs are distanced for standard dual banana plugs.

[2] **⚠️⚠️ Warning: To prevent possible electrical shock, fire, or personal injury Do not exceed a maximum of 100 V peak to chassis ground.**

Figure 4. Isolated Input Display, Controls, and Terminals (cont.)

Rear Panel

Figure 5 shows the rear-panel layout.

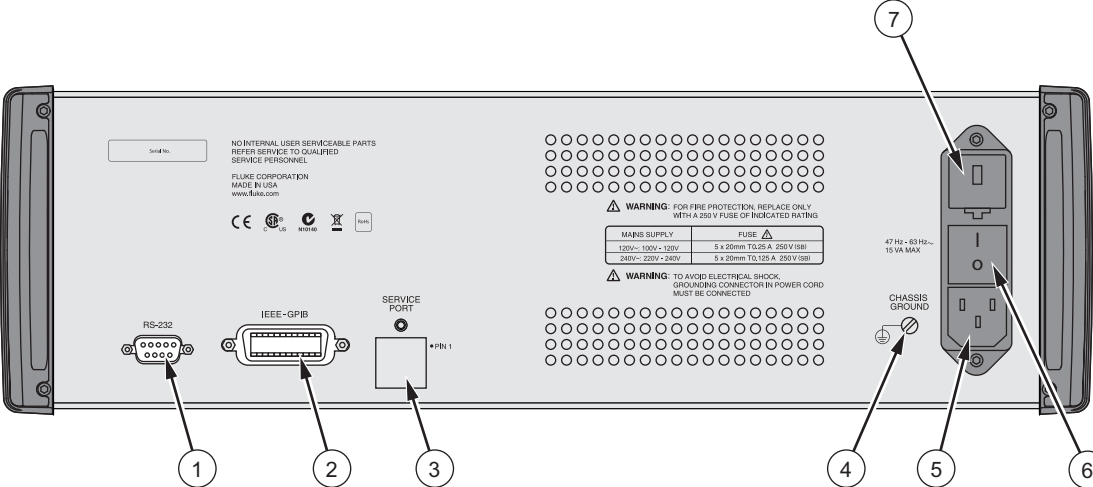

The diagram shows the rear panel of the Precision Process Calibrator with the following components labeled:

- ① RS-232 9-pin connector
- ② IEEE-GPIB connector
- ③ Service port
- ④ Chassis ground terminal
- ⑤ Standard IEC AC power inlet
- ⑥ Main power on/off switch
- ⑦ Power line voltage selector and fuse compartment

Additional text on the panel includes: "NO INTERNAL USER SERVICEABLE PARTS. REFER SERVICE TO QUALIFIED SERVICE PERSONNEL.", "FLUKE CORPORATION MADE IN USA www.fluke.com", and a fuse table:

MAIN SUPPLY	FUSE
120V~ 100V - 120V	5 x 20mm TQ, 25 A, 250V (58)
240V~ 220V - 240V	5 x 20mm TQ, 125 A, 250V (58)

Warnings: "FOR FIRE PROTECTION, REPLACE ONLY WITH A 250 V FUSE OF INDICATED RATING." and "TO AVOID ELECTRICAL SHOCK, GROUNDING CONNECTOR IN POWER CORD MUST BE CONNECTED."

gwp05.eps

Item	Description
①	RS-232 9-pin connector for remote control of the Product with a computer serial interface.
②	GPIB IEEE 488.2 connector for remote control of the Product with a GPIB bus.
③	Service port to update the Product firmware.
④	Chassis ground terminal internally connected to the ground prong of the AC power inlet.
⑤	Standard IEC AC power inlet for 120/240 V ac.
⑥	Main power on/off switch.
⑦	Power line voltage selector and fuse compartment. See "Maintenance" in Chapter 7 of the Users Manual for instructions to change the line voltage selector and fuses.

Figure 5. Rear Panel

Display Layouts

Figure 6 shows the primary voltage and current display.

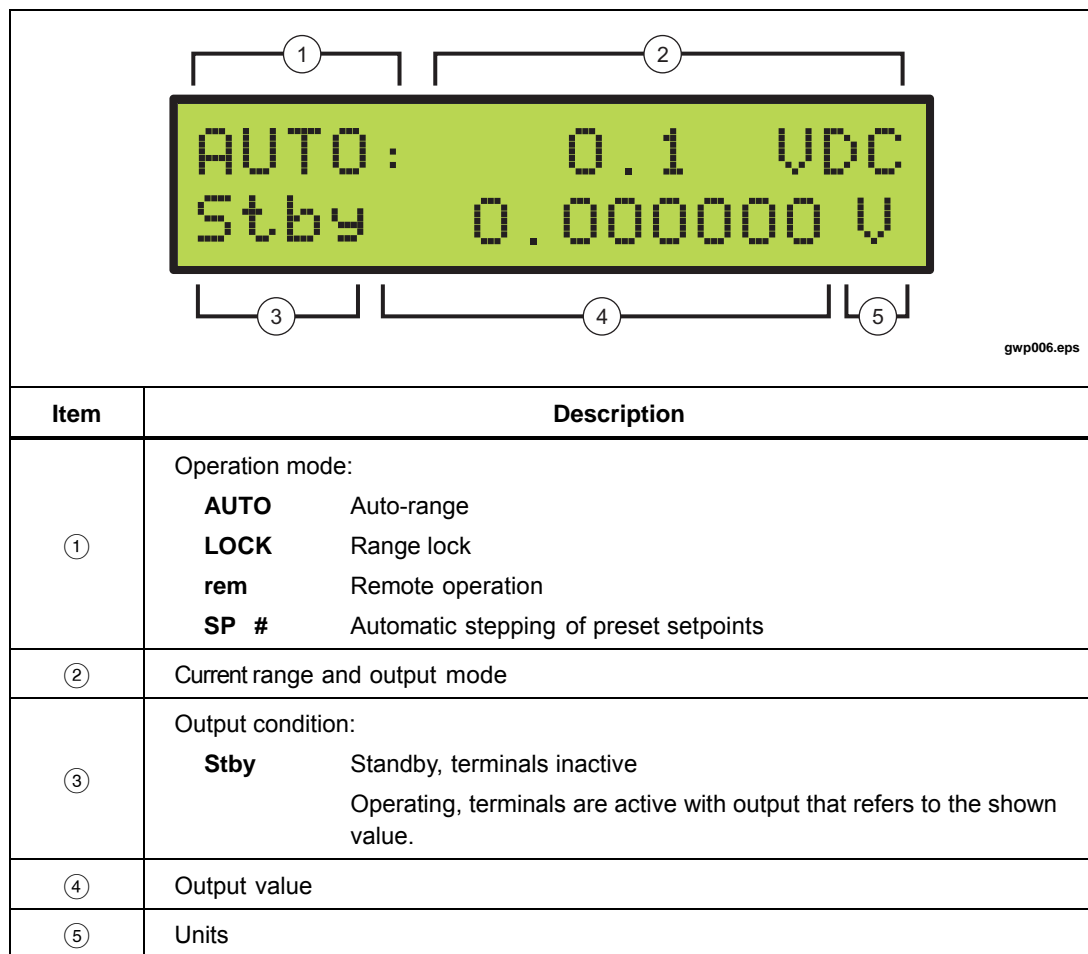

Figure 6. Primary Voltage and Current Display

Figure 7 shows the primary thermocouple and RTD display.

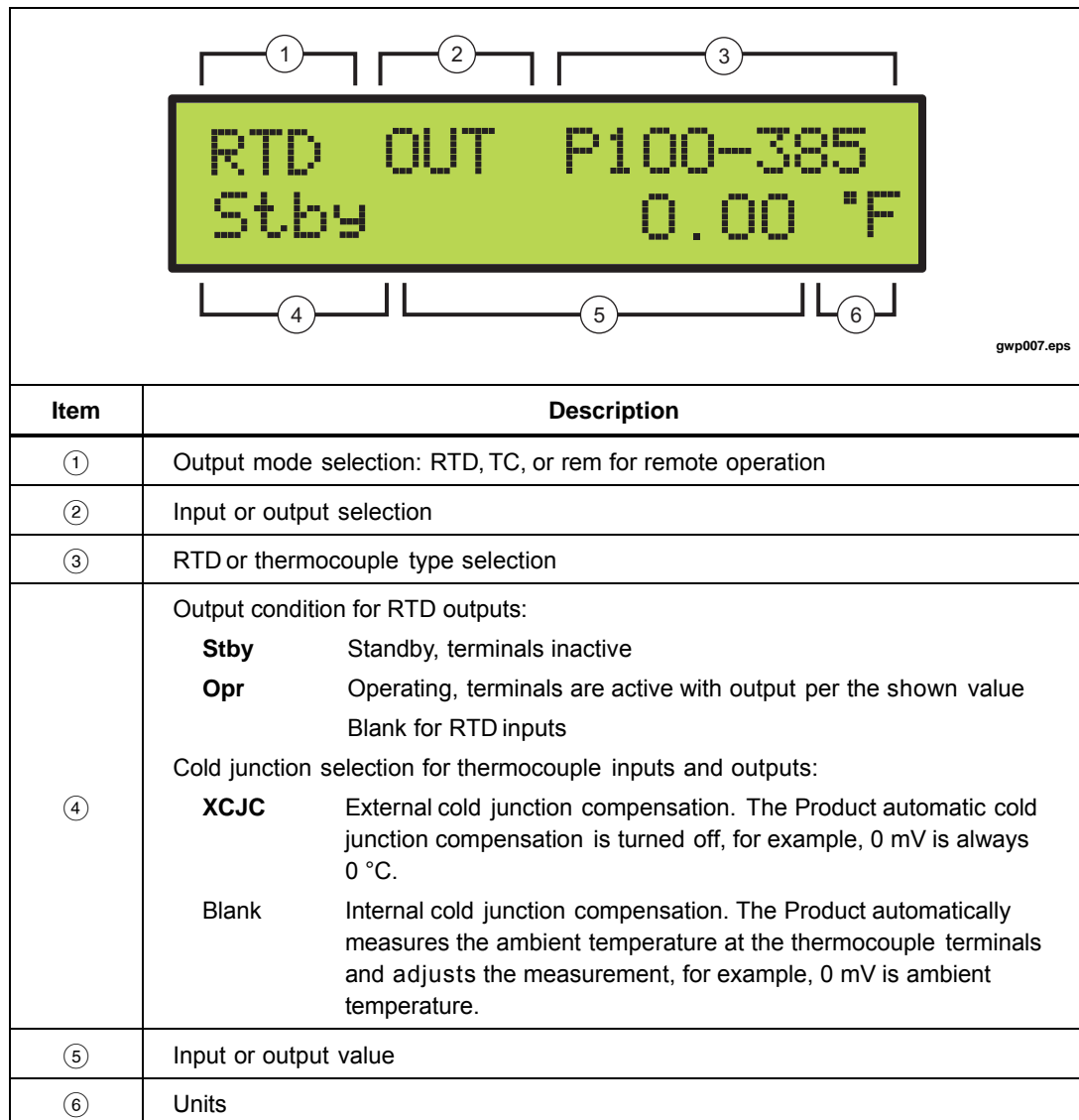

Figure 7. Primary Thermocouple and RTD Display

Figure 8 shows the primary and isolated pressure display.

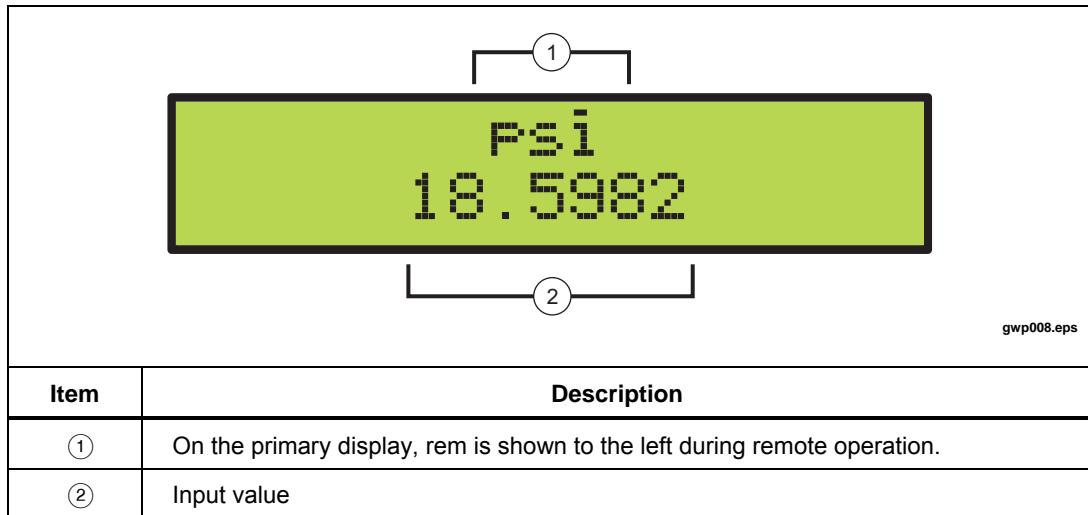

Figure 8. Primary and Isolated Pressure Display

Figure 9 shows the isolated voltage and current display.

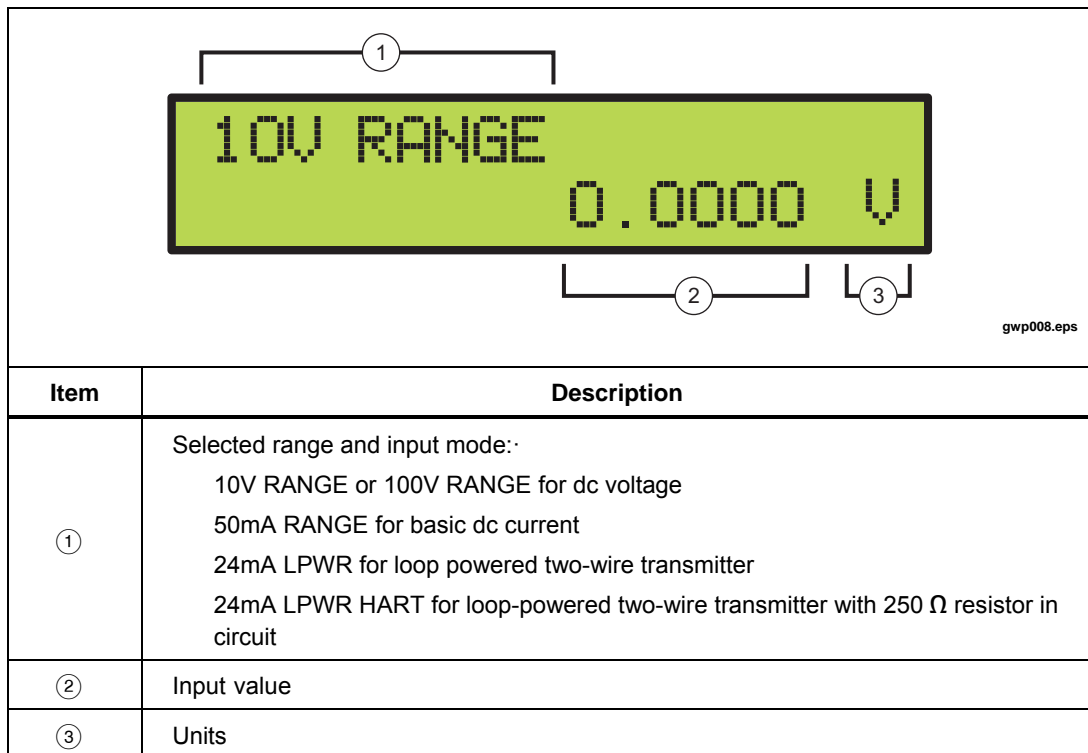

Figure 9. Isolated Voltage and Current Display

Error Messages

Table 2 shows the error messages that can appear on the displays.

Table 2. Error Messages

Message	Description
OVER RANGE	The numeric keypad value is larger than the range of the output mode selected.
OVER LOAD	For dc voltage output mode, the current necessary to make the output is larger than the Product specifications. For dc current mode, the resistance of the circuit is larger than the Product specifications.
OL	For input modes, the measured value is larger than the top limit of the selected input mode range. For output modes, when the range is locked, the current automatically recalled preset setpoint is larger than the maximum limit of the locked range. The output is set to zero for the time of this setpoint.
-OL	For input modes, the measured value is less than the lower limit of the selected input mode range.

Getting Started

After you unpack and learn the layout and general operation of the Product, it can be set up for operation.

Follow the subsequent steps to set up the Product:

1. Before you connect the power cord to the rear connector, make sure that the line voltage selector is in the correct position for your location. The Product is shipped from the factory with the line voltage set for the country of purchase. To make sure the line voltage is correctly set, examine the indicator on the power line voltage selector and fuse compartment cover.
2. See Table 3 to set the correct line voltage.

Table 3. Line Voltage Settings

Line Voltage (50/60Hz)	Selector Position
100 V ac to 120 V ac	120 V ac position
220 V ac to 240 V ac	240 V ac position

3. If the line voltage is not correctly set, follow the instructions in “Changing the Line Voltage” in Chapter 7 of the Users Manual.
4. When the line voltage is correctly set, make sure that the power switch is off and connect the ac power cord to the Product. See the “Rear Panel” section of this manual.
5. Turn on the Product with the rear panel rocker switch. The Product must power up in a few seconds. It briefly shows the model number and firmware version in the primary display before it changes to the correct input/output display.

Note

If a correct power-up display does not occur in 30 seconds, turn off the power. Power on the unit after a few seconds. If the problem continues, report the problem to Fluke immediately.

Warmup time is two times the time since its last warmup, to a maximum of 30 minutes. To keep the product stable, it is best to keep the Product on all the time.

Specifications

General Specifications

Warm-up Time	Twice the time since last warmed up, to a maximum of 30 minutes
Settling Time	Less than 5 seconds for all functions and ranges except as noted
Standard Interfaces	RS-232 IEEE-488 (GPIB)
Temperature Performance	
Operating	0 °C to 50 °C
Calibration (tcal)	18 °C to 28 °C
Storage	-20 °C to 70 °C
Electromagnetic Compatibility	CE: Conforms to EN61326; operation in controlled EM environments
Temperature Coefficient	Temperature coefficient for temperatures outside tcal 5 °C is 10 % of the 90-day specification (or 1 year if applicable) per °C
Relative Humidity	
Operating	<80 % to 30 °C <70 % to 40 °C <40 % to 50 °C
Altitude	
Operating	3,000 m (9,800 ft) maximum
Non-operating	12,200 m (40,000 ft) maximum
Safety	EN/IEC 61010-1:2010 3 rd Edition, UL 61010-1:2012, CAN/CSA 22.2 No. 61010-1-12
Analog Low Isolation	20 V
Line Power Line Voltage (selectable)	
120 V~	100 V to 120 V
240 V~	220 V to 240 V
Line Frequency	47 to 63 Hz
Line Voltage Variation	±10 % about setting
Power Consumption	15 VA maximum
Dimensions	
Height	14.6 cm (5.75 inch)
Width	44.5 cm (17.5 inch)
Depth	29.8 cm (11.75 inch) overall
Weight (without options)	4.24 kg (9.35 lb)

DC Voltage Specifications, Output

Ranges ^[1]	Absolute Uncertainty, tcal $\pm 5^{\circ}\text{C}$, $\pm(\text{ppm of output} + \mu\text{V})$				Stability	Resolution	Maximum Burden ^[2]
	90 Days		1 Year		24 hours, $\pm 1^{\circ}\text{C}$ $\pm(\text{ppm of output} + \mu\text{V})$		
0 mV to 100.000 mV	25	3	30	3	5 ppm + 2 μV	1 μV	10 mA
0 V to 1.00000 V	25	10	30	10	4 ppm + 10 μV	10 μV	10 mA
0 V to 10.0000 V	25	100	30	100	4 ppm + 100 μV	100 μV	10 mA
0 V to 100.000 V	25	1 mV	30	1 mV	5 ppm + 1 mV	1 mV	1 mA
TC Output and Input							
-10 to 75.000 mV	25	2 μV	30	2 μV	5 ppm + 2 μV	1 μV	10 Ω
[1] All outputs are positive only, unless otherwise noted. [2] Remote sensing is not provided. Output resistance is $< 1 \Omega$							

Noise		
Ranges	Bandwidth 0.1 to 10 Hz p-p $\pm(\text{ppm of output} + \mu\text{V})$	Bandwidth 10 Hz to 10 kHz rms μV
0 mV to 100.000 mV	1 μV	6 μV
0 V to 1.00000 V	10 μV	60 μV
0 V to 10.0000 V	100 μV	600 μV
0 V to 100.000 V	10 ppm+1 mV	20 mV

DC Voltage Specifications, Isolated Input

Ranges	Absolute Uncertainty, tcal $\pm 5^{\circ}\text{C}$, $\pm(\text{ppm of reading} + \text{mV})$		Resolution
0 V to 10.0000 V	50	0.2	100 μV
0 V to 100.000 V	50	2.0	1 mV

DC Current Specifications, Output

Ranges ^[1]	Absolute Uncertainty, tcal $\pm 5^{\circ}\text{C}$, $\pm(\text{ppm of output} + \mu\text{A})$				Resolution	Maximum Compliance Voltage	Maximum Inductive Load
	90 Days		1 Year				
0 mA to 100.000 mA	40 ^[2]	1	50 ^[2]	1	1 μA	12 V	100 mH
[1] All outputs are positive only. [2] For line voltages less than 95 V (± 100 ppm of reading)							

Ranges	Noise	
	Bandwidth 0.1 to 10 Hz p-p	Bandwidth 10 Hz to 10 kHz rms μV
0 mA to 100.000 mA	2000 nA	20 μA

DC Current Specifications, Isolated Input

Ranges	Absolute Uncertainty, tcal $\pm 5^{\circ}\text{C}$, $\pm(\text{ppm of reading} + \mu\text{A})$		Resolution
0 mA to 50.0000 mA	100	1	0.1 μA
0 mA to 24.0000 mA (Loop Power) ^{[1][2]}	100	1	0.1 μA
[1] Loop Power: 24 V $\pm 10\%$ [2] HART Resistor: 250 $\Omega \pm 3\%$			

Resistance Specifications, Output

Ranges	Absolute Uncertainty, tcal ± 5 °C, \pm Ohms		Resolution	Nominal Current ^[1]
	90 Days	1 Year		
5 Ω to 400.000 Ω	0.012	0.015	0.001 Ω	1 to 3 mA
5 k Ω to 4.00000 k Ω	0.25	0.3	0.01 Ω	100 μ A to 1 mA
<p>[1] For currents lower than shown, the specification becomes New Spec. = Stated Spec. x Imin/Iactual. For example, a 500 μA stimulus that measures 100 Ω has a specification of: 0.015 Ω x 1 mA/500 μA=0.03 Ω</p>				

Resistance Specifications, Input

Ranges	Absolute Uncertainty, tcal ± 5 °C \pm (ppm of reading + Ω)		Resolution	Stimulus Current
	90 Days	1 Year		
0 Ω to 400.000 Ω	± 20 ppm + 0.0035 Ω	± 20 ppm + 0.004 Ω	0.001 Ω	1 mA
0 k Ω to 4.00000 k Ω	± 20 ppm + 0.035 Ω	± 20 ppm + 0.04 Ω	0.01 Ω	0.1 mA

Thermocouple Specification, Output and Input

TC Type	Range (°C)		Absolute Uncertainty, tcal ±5 °C, ±(°C) ^[1]	
			Output/Input	
	Minimum	Maximum	90 days	1 Year
B	600 °C	800 °C	0.35 °C	0.35 °C
	800 °C	1550 °C	0.28 °C	0.28 °C
	1550 °C	1820 °C	0.21 °C	0.22 °C
C	0 °C	1000 °C	0.15 °C	0.16 °C
	1000 °C	1800 °C	0.22 °C	0.23 °C
	1800 °C	2000 °C	0.24 °C	0.26 °C
	2000 °C	2316 °C	0.32 °C	0.35 °C
E	-250 °C	-200 °C	0.24 °C	0.25 °C
	-200 °C	-100 °C	0.10 °C	0.12 °C
	-100 °C	0 °C	0.07 °C	0.09 °C
	0 °C	600 °C	0.06 °C	0.08 °C
	600 °C	1000 °C	0.08 °C	0.10 °C
J	-210 °C	-100 °C	0.13 °C	0.14 °C
	-100 °C	800 °C	0.07 °C	0.09 °C
	800 °C	1200 °C	0.08 °C	0.10 °C
K	-250 °C	-200 °C	0.45 °C	0.46 °C
	-200 °C	-100 °C	0.15 °C	0.16 °C
	-100 °C	500 °C	0.08 °C	0.10 °C
	500 °C	800 °C	0.09 °C	0.10 °C
	800 °C	1372 °C	0.11 °C	0.13 °C
L	-200 °C	-100 °C	0.08 °C	0.10 °C
	-100 °C	900 °C	0.07 °C	0.09 °C
N	-250 °C	-200 °C	0.72 °C	0.73 °C
	-200 °C	-100 °C	0.22 °C	0.23 °C
	-100 °C	0 °C	0.11 °C	0.12 °C
	0 °C	100 °C	0.09 °C	0.11 °C
	100 °C	800 °C	0.08 °C	0.10 °C
	800 °C	1300 °C	0.10 °C	0.12 °C
R	-50 °C	-25 °C	0.54 °C	0.55 °C
	-25 °C	0 °C	0.44 °C	0.45 °C
	0 °C	100 °C	0.38 °C	0.39 °C
	100 °C	400 °C	0.27 °C	0.28 °C
	400 °C	600 °C	0.21 °C	0.22 °C
	600 °C	1000 °C	0.19 °C	0.21 °C
	1000 °C	1600 °C	0.18 °C	0.19 °C
	1600 °C	1767 °C	0.21 °C	0.23 °C
S	-50 °C	-25 °C	0.51 °C	0.51 °C
	-25 °C	0 °C	0.43 °C	0.43 °C
	0 °C	100 °C	0.37 °C	0.38 °C
	100 °C	400 °C	0.28 °C	0.29 °C
	400 °C	600 °C	0.22 °C	0.23 °C
	600 °C	1000 °C	0.21 °C	0.22 °C
	1000 °C	1600 °C	0.20 °C	0.22 °C
	1600 °C	1767 °C	0.24 °C	0.26 °C

TC Type	Range (°C)		Absolute Uncertainty, tcal ±5 °C, ±(°C) ^[1]	
	Minimum	Maximum	Output/Input	
			90 days	1 Year
T	-250 °C	-200 °C	0.34 °C	0.35 °C
	-200 °C	-100 °C	0.14 °C	0.16 °C
	-100 °C	0 °C	0.09 °C	0.11 °C
	0 °C	200 °C	0.07 °C	0.09 °C
	200 °C	400 °C	0.06 °C	0.09 °C
U	-200 °C	0 °C	0.15 °C	0.16 °C
	0 °C	200 °C	0.08 °C	0.10 °C
	200 °C	600 °C	0.07 °C	0.10 °C
XK	-200 °C	-100 °C	0.10 °C	0.11 °C
	-100 °C	0 °C	0.07 °C	0.09 °C
	0 °C	600 °C	0.06 °C	0.08 °C
	600 °C	800 °C	0.07 °C	0.09 °C
BP	0 °C	200 °C	0.17 °C	0.18 °C
	200 °C	600 °C	0.14 °C	0.16 °C
	600 °C	800 °C	0.15 °C	0.17 °C
	800 °C	1600 °C	0.22 °C	0.23 °C
	1600 °C	2000 °C	0.26 °C	0.28 °C
	2000 °C	2500 °C	0.38 °C	0.40 °C

[1] Does not include thermocouple wire error.
 Type B, E, J, K, N, R, S and T are based on ITS-90
 Type L and U are based on DIN 43710-1985
 Type C is based on ASTM standard E 988-96
 Type XK and BP are based on GOST R 8.585-2001

RTD and Thermistor Specification, Output

RTD Types	Range °C		Absolute Uncertainty, tcal ±5 °C ±(°C) ^[1]	
	Minimum	1 Year	90 Days	1 Year
Pt 385, 100 Ω	-200 °C	-800 °C	0.04 °C	0.05 °C
Pt 3926, 100 Ω	-200 °C	630 °C	0.04 °C	0.05 °C
Pt 3916, 100 Ω	-200 °C	630 °C	0.04 °C	0.05 °C
Pt 385, 200 Ω	-200 °C	400 °C	0.35 °C	0.40 °C
	400 °C	630 °C	0.42 °C	0.50 °C
Pt 385, 500 Ω	-200 °C	630 °C	0.15 °C	0.17 °C
Pt 385, 1000 Ω	-200 °C	630 °C	0.07 °C	0.09 °C
Ni 120, 120 Ω	-80 °C	260 °C	0.02 °C	0.02 °C
Cu 427, 10 Ω ^[2]	-100 °C	260 °C	0.30 °C	0.38 °C
YSI 400	15 °C	50 °C	0.005 °C	0.007 °C

[1] 2-wire output
 [2] Based on MINCO Application Aid No. 18

RTD and Thermistor Specification, Input

RTD Type	Range (°C)		Absolute Uncertainty, tcal ±5 °C, ±(°C) ^[1]	
			Output/Input	
	Minimum	Maximum	90 Days	1 Year
Pt 385, 100 Ω	-200 °C	-80 °C	0.012 °C	0.013 °C
	-80 °C	100 °C	0.018 °C	0.020 °C
	100 °C	300 °C	0.022 °C	0.024 °C
	300 °C	400 °C	0.025 °C	0.026 °C
	400 °C	630 °C	0.031 °C	0.033 °C
	630 °C	800 °C	0.037 °C	0.038 °C
Pt 3926, 100 Ω	-200 °C	-80 °C	0.012 °C	0.013 °C
	-80 °C	0 °C	0.014 °C	0.015 °C
	0 °C	100 °C	0.016 °C	0.017 °C
	100 °C	300 °C	0.022 °C	0.022 °C
	200 °C	400 °C	0.022 °C	0.026 °C
	400 °C	630 °C	0.024 °C	0.032 °C
Pt 3916, 100 Ω	-200 °C	-190 °C	0.009 °C	0.010 °C
	-190 °C	-80 °C	0.012 °C	0.013 °C
	-80 °C	0 °C	0.014 °C	0.015 °C
	0 °C	100 °C	0.016 °C	0.017 °C
	100 °C	300 °C	0.021 °C	0.022 °C
	300 °C	400 °C	0.024 °C	0.026 °C
	400 °C	600 °C	0.030 °C	0.031 °C
	600 °C	630 °C	0.031 °C	0.033 °C
Pt 385, 200 Ω	-200 °C	-80 °C	0.047 °C	0.053 °C
	-80 °C	0 °C	0.050 °C	0.056 °C
	0 °C	100 °C	0.053 °C	0.060 °C
	100 °C	260 °C	0.054 °C	0.060 °C
	260 °C	300 °C	0.062 °C	0.069 °C
	300 °C	400 °C	0.064 °C	0.071 °C
	400 °C	630 °C	0.079 °C	0.088 °C
	-80 °C		0.031 °C	
Pt 385, 500 Ω	-200 °C	0 °C	0.023 °C	0.025 °C
	0 °C	100 °C	0.026 °C	0.028 °C
	100 °C	300 °C	0.031 °C	0.034 °C
	300 °C	400 °C	0.035 °C	0.038 °C
	400 °C	630 °C	0.041 °C	0.045 °C
Pt 385, 1000 Ω	-200 °C	0 °C	0.014 °C	0.015 °C
	0 °C	100 °C	0.017 °C	0.018 °C
	100 °C	300 °C	0.022 °C	0.024 °C
	300 °C	400 °C	0.024 °C	0.026 °C
	400 °C	630 °C	0.031 °C	0.033 °C
Ni 120, 120 Ω	-80 °C	260 °C	0.008 °C	0.009 °C
Cu 427, 10 Ω ^[2]	-100 °C	260 °C	0.097 °C	0.110 °C
YSI 400	15 °C	50 °C	0.005 °C	0.007 °C
SPRT	-200 °C	660 °C	0.05 °C	0.06 °C

[1] 4-wire mode. Uncertainties shown do not include probe uncertainties.

[2] Based on MINCO Application Aid No. 18.

Pressure Measurement Specifications

The Calibrator can accept the Fluke 700 or 525A-P Series pressure modules. Pressure modules connect directly into the front panel Lemo connector with the Calibrator firmware auto-detecting the type and value of the module you connect.

Range	Accuracy and Resolution	Units
Determined by the pressure module	Determined by the pressure module	PSI (pounds per square inch)
		in H2O 4 °C (inches of water at 4 degrees Celsius)
		in H2O 20 °C (inches of water at 20 degrees Celsius)
		in H2O 60 °C (inches of water at 60 degrees Fahrenheit)
		cm H2O 4 °C (centimeters of water at 4 degrees Celsius)
		cm H2O 20 °C (centimeters of water at 20 degrees Celsius)
		mm H2O 4 °C (millimeters of water at 4 degrees Celsius)
		mm H2O 20 °C (millimeters of water at 20 degrees Celsius)
		BAR (bars)
		mBAR (millibars)
		kPa (kilopascals)
		MPa (megapascals)
		in HG 0 °C (inches of mercury at 0 degrees Celsius)
		mm HG 0 °C (millimeters of mercury at 0 degrees Celsius)
		kg/cm2 (kilograms per square centimeter)

Switch Test Specifications, Isolated Input

Contact Closure Resistance	<1 kΩ
Excitation Current	27 mA Max

