

Thermal imaging terminology—explained

Palette—The palette is the color scheme used to display a thermal image. Whether editing or analyzing, the objective is to select the palette that best identifies and communicates the problem.

Palette Options (six of 16 available, varies by model)

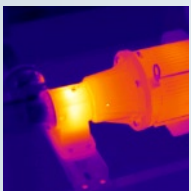

Ironbow

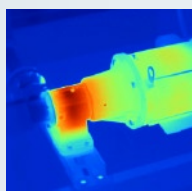

Blue-red

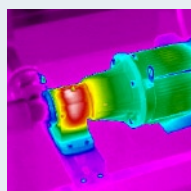

High contrast



Amber

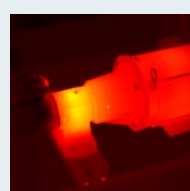

Hot metal

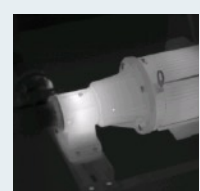

Grey

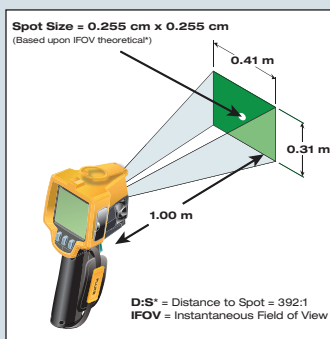

Check your FOV at www.fluke.com/fov

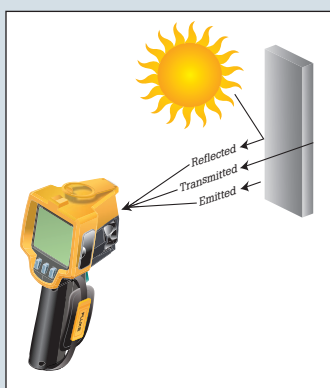

Download an emissivity chart at www.fluke.com/emissivity

Sensor size—Similar to digital cameras, the sensor size describes the number of pixels, or measurement points, of a thermal imager. A sensor size of 160 x 120 captures and displays more than 19,000 measurement points with each image, while a 320 x 240 sensor captures four times as many.

Radiometric—A fully radiometric thermal imager captures not just an image, but the temperature data for each measurement point within the image. This allows for greater flexibility in subsequent reporting and analysis.

Field of view (FOV)—The field of view of a thermal imager is determined by its lens, and defines the area the imager sees at a given moment. The combination of sensor size, lens, and distance to the measured object will determine the smallest surface area discernible by your imager. An FOV calculator at www.fluke.com/fov can easily help you calculate the measurement surface area at various distances to your target

Thermal sensitivity—Also referred to as NETD (noise equivalent temperature difference), the thermal sensitivity identifies the smallest temperature difference that can be measured by the thermal imager. A highly sensitive imager will have a low NETD and can reveal greater thermal detail in your image.

Emissivity—All objects emit infrared energy, but the level of emission varies depending on the object's surface. Emissivity is measured on a scale of 0.0 – 1.0, and must be matched to the material and surface condition to produce accurate temperature measurements from your imager. Fortunately, many applications require only qualitative inspections and don't require adjusting for emissivity. Visit www.fluke.com/emissivity for a table showing emissivity measurements for common surfaces.

Span—The span is the temperature range displayed with the selected palette. A span that is set too broadly will fail to show subtle temperature gradients within a captured image. An optimized span will reveal additional detail by displaying more shades of the palette on the problem area(s).