

Fluke IRR1-SOL

Irradiance Meter

Users Manual

Introduction

The Fluke IRR1-SOL Irradiance Meter (the Meter) provides digital read-outs related to photovoltaic (PV) panels. Measures and reads:

- Solar irradiation (W/m^2) on the surface of a photovoltaic (PV) panel
- Temperature ($^{\circ}F$ or $^{\circ}C$) on the surface of a photovoltaic (PV) panel
- Inclination (degrees) of a photovoltaic (PV) panel
- Cardinal degrees with the compass function

The read-outs provided by the Meter help determine optimum positioning of the photovoltaic (PV) panel for best performance.

Contact Fluke

Fluke Corporation operates worldwide. For local contact information, go to our website: www.fluke.com

To register your product, view, print, or download the latest manual or manual supplement, go to our website.

Fluke Corporation
P.O. Box 9090
Everett, WA 98206-9090
+1-425-446-5500
fluke-info@fluke.com

Kit Components

The product contains the following items:

- 1 FLK-IRR1-SOL/001 Solar Irradiance Meter
- 1 FLK-80PR-IRR External Temperature Probe with Suction Cup
- 1 C250 Carrying Case with Shoulder Strap
- 4 AA Alkaline Batteries
- 1 User Manual

5237649, September 2020







© 2020 Fluke Corporation. All rights reserved.

Specifications are subject to change without notice.

All product names are trademarks of their respective companies.

Fluke Corporation	Fluke Europe B.V.
P.O. Box 9090	P.O. Box 1186
Everett, WA 98206-9090	5602 BD Eindhoven
U.S.A.	The Netherlands

Symbols

Symbol	Description
	WARNING. RISK OF DANGER.
	Consult user documentation.
	Battery or battery compartment.
	Conforms to relevant South Korean EMC Standards.
	Conforms to relevant Australian standards.
	Conforms to European Union directives.
	This product complies with the WEEE Directive marking requirements. The affixed label indicates that you must not discard this electrical/electronic product in domestic household waste. Product Category: With reference to the equipment types in the WEEE Directive Annex I, this product is classed as category 9 "Monitoring and Control Instrumentation" product. Do not dispose of this product as unsorted municipal waste.

Safety Information

A **Warning** identifies hazardous conditions and procedures that are dangerous to the user. A **Caution** identifies conditions and procedures that can cause damage to the Product or the equipment under test.

Warning

To prevent personal injury and damage to the Product:

- Read the entire users manual before using the Meter.
- Use the Meter only as described in the Users Manual otherwise the protection provided by the equipment may be impaired.
- Inspect the Meter before use. Do not use it if it appears damaged.
- Do not use the Meter around explosive gas, vapor, and/or in damp or wet environments that exceeds IP40.
- The Meter contains no user-serviceable parts. Do not open the instrument.
- Use only AA batteries, properly installed in the Meter case, to power the Meter (see Battery Replacement).
- To avoid false readings, replace the batteries as soon as the low battery indicator appears.
- Remove the batteries if the Meter is not used for an extended period of time, or if stored in temperatures above 140 °F (60 °C). If the batteries are not removed, battery leakage can damage the Meter.
- Have the Meter serviced only by qualified service personnel.

Product Overview



1	ON/OFF Button	10	Battery Level Indicator
2	Angle Reset Button * Use function to measure angle difference between solar panel and surface	11	Compass Function Indicator
3	Function key for Irradiance, Temperature, Compass and Angle measurements	12	Irradiance Units and Function Indicator
4	Integrated Temperature Sensor for panel's surface measurement	13	Angle Function Indicator
5	External Temperature Probe Socket	14	Temperature Units Indicator (Celsius / Fahrenheit)
6	Photovoltaic Irradiance Sensor	15	Angle Reset Indicator
7	Hold Button to hold measurement on the display *Push button for 2 seconds to enable Temperature Units Change mode	16	External Temperature Probe Indicator
8	Temperature Units Switch Button (Celsius / Fahrenheit)	17	Integrated Temperature Sensor Indicator
9	Hold Indicator		

Operation

Power ON/OFF



Change Function Screens

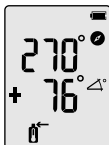

Change Temperature Units

Units
Press 2 sec



Connect the External Temperature Probe

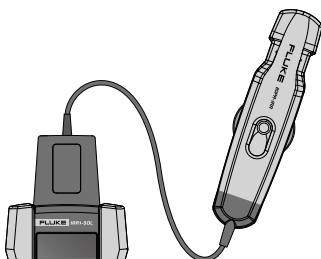
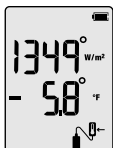

Reset Inclination

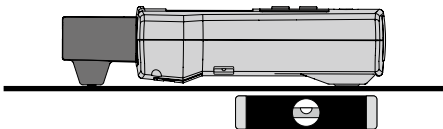

Press 2 sec



Hold Function

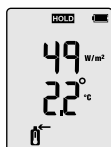

Measuring Temperature and Irradiance

Irradiance and Internal Sensor Temperature Measurements

The Meter can measure irradiance and temperature by simply placing the meter directly onto the PV panel. The internal, embedded conductive sensor in the back of the Meter will automatically take the temperature reading.

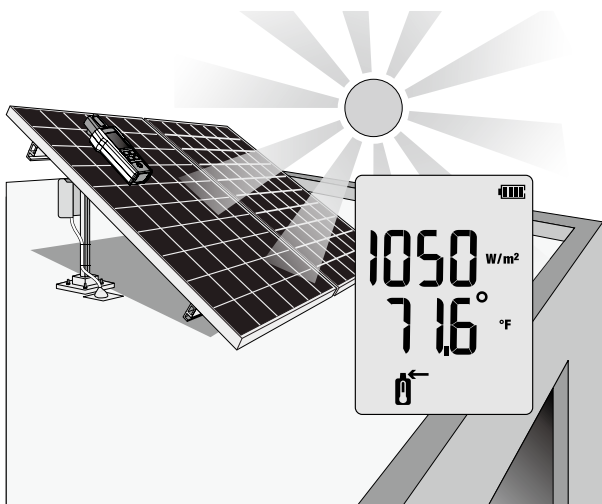
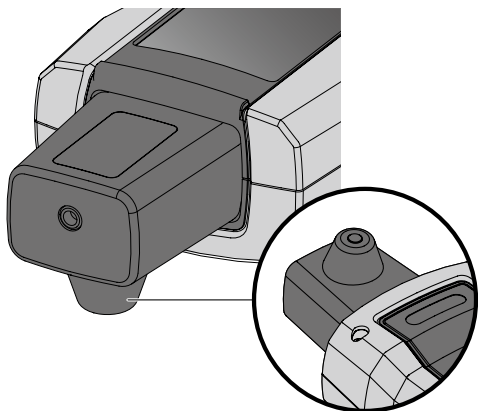

Temperature can also be taken through the external temperature probe.

Connecting the External Temperature Probe

Attach the temperature probe to the top of the Meter. The screen automatically shows the  icon once connected. The icon indicates that the temperature is now being read by the external probe. Place the Meter on or beside the PV panel and connect the suction cup to the underside of the PV panel.

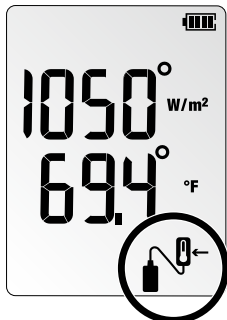
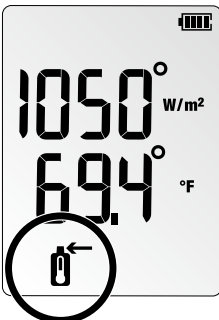
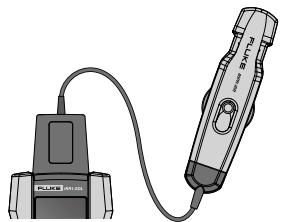
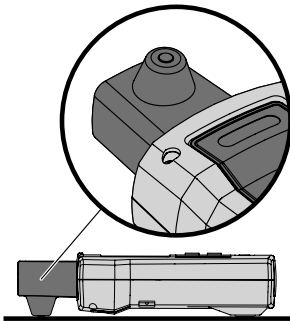
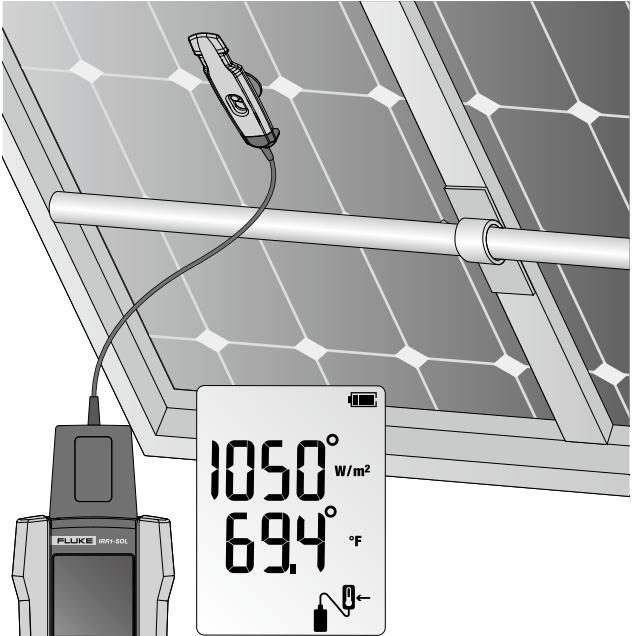

Measuring Inclination and Cardinal Direction

Place the Meter directly onto the PV panel to get accurate tilt.

For surfaces of rooftops with inclinations different than 0°, push the ZERO button  for 2 seconds to reset the angle and measure the true inclination of a solar panel.

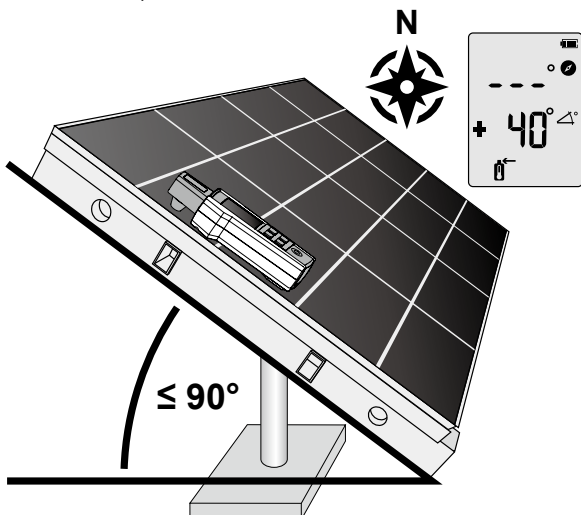

The compass measurement will require a two-step process for accurate cardinal direction.

Step 1: Perform irradiance, temperature and inclination measurements with meter placed on and aligned with the PV panel. The compass function will show “---” when the tilt angle is above 20 degrees. At a tilt angle of <20 degrees any compass reading shown will be inaccurate due to the influence by surrounding metal objects.

Step 2: Perform the compass measurement away from the PV panel by holding the meter or placing meter on a horizontal surface (0 to 20 degrees tilt) pointing the tip of the meter in the direction that the PV panel faces. Keep away from any metal objects.

Note

The compass will reference magnetic north. The compass reading will be unreliable if the meter is placed on or near objects containing metal (including solar panels, metal roofs, concrete surfaces with rebar, etc).

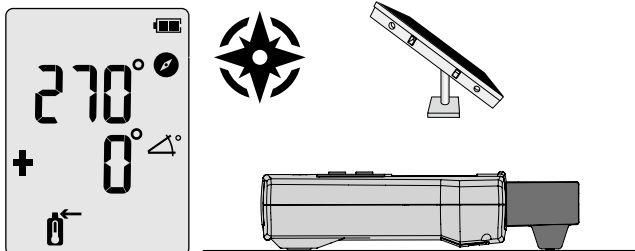

Maintenance

Battery Replacement

The battery compartment on the back of the Meter makes it easy to change the batteries. Use four (4) AA 1.5 V alkaline batteries.

Note: Batteries are not pre-installed in the meter.

1. Make sure that the meter is turned off.
2. Use a screw driver to unscrew the captive screw.
3. Remove the battery cover.
4. Install batteries.
5. Replace the battery cover and secure it with the provided screw.

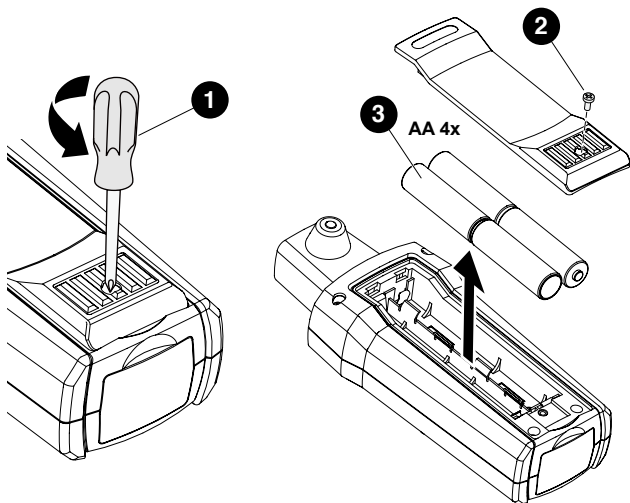

Cleaning

Periodically wipe the case with a damp cloth and mild detergent.

⚠ Caution

To prevent damage to the Meter:

- The Meter contains no user-serviceable parts. To avoid injury, or damage to the Meter, do not open the case.
- To avoid damaging the Meter, do not use abrasives or solvents to clean the Meter case.

Storage

During longer periods of non-use (>60 days), remove and store the battery separately.

Service and Parts

Only a qualified technician should service the Meter. For service information, contact your nearest Fluke dealer or service center.

Specifications

Irradiance

Measuring range0 to 1400 W/m²

Resolution1 W/m²

Measuring Accuracy.....±(5 % + 5 Digit)

Temperature Measurement

Measuring range (°C).....-30 °C to 100 °C (-22 °F to 212 °F)

Resolution0.1 °C (0.2 °F / 1 °F @ > 100 °F)

Measuring Accuracy..... $\pm 1^{\circ}\text{C}$ ($\pm 2^{\circ}\text{F}$) @ -10°C to 75°C (14°F to 167°F),
 $\pm 2^{\circ}\text{C}$ ($\pm 4^{\circ}\text{F}$) @ -30°C to -10°C (-22°F to
 14°F) and 75°C to 100°C (167°F to 212°F)

Note: Temperature measurement response time: ~30 sec.

Inclination Angle

Measuring range -90° to $+90^{\circ}$
Resolution 0.1°
Measuring Accuracy..... $\pm 1.5^{\circ}$ @ -50° to $+50^{\circ}$,
 $\pm 2.5^{\circ}$ @ -85° to -50° and $+50^{\circ}$ to $+85^{\circ}$,
 $\pm 3.5^{\circ}$ @ -90° to -85° and $+85^{\circ}$ to $+90^{\circ}$

Compass

Measuring range 0° to 360°
Resolution 1°
Measuring Accuracy..... $\pm 7^{\circ}$

Note:

- Measurements valid for device inclination between -20° and $+20^{\circ}$ to horizontal. Outside that range on LCD will be shown "----".
- Result is referred to magnetic north.

Operating Temperature

Operating temperaturesIRR1-SOL: -20°C to 50°C , humidity <80%,
noncondensing
80PR-IRR: -30°C to 100°C
Storage temperature -30°C to 60°C (humidity <80%)
Altitude0 m to max. 2000 m

Electromagnetic Compatibility (EMC)

International

IEC 61326-1: Portable Electromagnetic Environment

CISPR 11: Group 1, Class A

Group 1: Equipment has intentionally generated and/or uses conductively-coupled radio frequency energy that is necessary for the internal function of the equipment itself.

Class A: Equipment is suitable for use in all establishments other than domestic and those directly connected to a low voltage power supply network that supplies buildings used for domestic purposes. There may be potential difficulties in ensuring electromagnetic compatibility in other environments due to conducted and radiated disturbances.

Caution: This equipment is not intended for use in residential environments and may not provide adequate protection to radio reception in such environments.

Korea (KCC)

Class A Equipment (Industrial Broadcasting & Communication Equipment)

Class A: Equipment meets requirements for industrial electromagnetic wave equipment and the seller or user should take notice of it. This equipment is intended for use in business environments and not to be used in homes.

USA (FCC)

47 CFR 15 subpart B. This product is considered an exempt device per clause 15.103.

Protection

IP Protection.....IP40

Power Supply & Battery Life

Batteries4 AA Alkaline Batteries
Battery Life (typical)50 hours (>9000 readings)
Auto Power Off30 minutes

Dimensions

L x W x H.....150 x 80 x 35 mm
(5.90 x 3.14 x 1.37 in)
Weight.....231g (0.5lb)