

# **1662/1663/1664 FC**

## Electrical Installation Tester

## Users Manual

October 2015, Rev. 1, 4/16

© 2015-2016 Fluke Corporation. All rights reserved.

Specifications are subject to change without notice.

All product names are trademarks of their respective companies.

## LIMITED WARRANTY AND LIMITATION OF LIABILITY

Each Fluke product is warranted to be free from defects in material and workmanship under normal use and service. The warranty period is three years and begins on the date of shipment. Parts, product repairs, and services are warranted for 90 days. This warranty extends only to the original buyer or end-user customer of a Fluke authorized reseller, and does not apply to fuses, disposable batteries, or to any product which, in Fluke's opinion, has been misused, altered, neglected, contaminated, or damaged by accident or abnormal conditions of operation or handling. Fluke warrants that software will operate substantially in accordance with its functional specifications for 90 days and that it has been properly recorded on non-defective media. Fluke does not warrant that software will be error free or operate without interruption.

Fluke authorized resellers shall extend this warranty on new and unused products to end-user customers only but have no authority to extend a greater or different warranty on behalf of Fluke. Warranty support is available only if product is purchased through a Fluke authorized sales outlet or Buyer has paid the applicable international price. Fluke reserves the right to invoice Buyer for importation costs of repair/replacement parts when product purchased in one country is submitted for repair in another country.

Fluke's warranty obligation is limited, at Fluke's option, to refund of the purchase price, free of charge repair, or replacement of a defective product which is returned to a Fluke authorized service center within the warranty period.

To obtain warranty service, contact your nearest Fluke authorized service center to obtain return authorization information, then send the product to that service center, with a description of the difficulty, postage and insurance prepaid (FOB Destination). Fluke assumes no risk for damage in transit. Following warranty repair, the product will be returned to Buyer, transportation prepaid (FOB Destination). If Fluke determines that failure was caused by neglect, misuse, contamination, alteration, accident, or abnormal condition of operation or handling, including overvoltage failures caused by use outside the product's specified rating, or normal wear and tear of mechanical components, Fluke will provide an estimate of repair costs and obtain authorization before commencing the work. Following repair, the product will be returned to the Buyer transportation prepaid and the Buyer will be billed for the repair and return transportation charges (FOB Shipping Point).

THIS WARRANTY IS BUYER'S SOLE AND EXCLUSIVE REMEDY AND IS IN LIEU OF ALL OTHER WARRANTIES, EXPRESS OR IMPLIED, INCLUDING BUT NOT LIMITED TO ANY IMPLIED WARRANTY OF MERCHANTABILITY OR FITNESS FOR A PARTICULAR PURPOSE. FLUKE SHALL NOT BE LIABLE FOR ANY SPECIAL, INDIRECT, INCIDENTAL OR CONSEQUENTIAL DAMAGES OR LOSSES, INCLUDING LOSS OF DATA, ARISING FROM ANY CAUSE OR THEORY.

Since some countries or states do not allow limitation of the term of an implied warranty, or exclusion or limitation of incidental or consequential damages, the limitations and exclusions of this warranty may not apply to every buyer. If any provision of this Warranty is held invalid or unenforceable by a court or other decision-maker of competent jurisdiction, such holding will not affect the validity or enforceability of any other provision.

Fluke Corporation  
P.O. Box 9090  
Everett, WA 98206-9090  
U.S.A.

Fluke Europe B.V.  
P.O. Box 1186  
5602 BD Eindhoven  
The Netherlands

# ***Table of Contents***

<b>Title</b>	<b>Page</b>
Introduction .....	1
How to Contact Fluke .....	1
Safety .....	2
Features and Accessories .....	5
Operation .....	8
Safety Features .....	8
Touch Pad .....	8
Live Circuit Detection .....	8
Earth Resistance Measurement .....	8
Safety Pretest .....	8
Mains Wiring Indicator .....	9
Quick Start .....	9
How to Use the Rotary Dial .....	9
Push Buttons .....	11
Display .....	13
Input Terminals .....	17
Error Codes .....	18
Power-On Options .....	20
How to Zero the Test Leads .....	22
Safety Pretest for Insulation Resistance Measurements .....	26
Measurements .....	28
Volts and Frequency Measurements .....	28
Insulation Resistance Measurements .....	29
Continuity Measurement .....	32
Loop/Line Impedance Measurements .....	34
Loop Impedance (Line to Protective Earth L-PE) .....	34
Loop Impedance (High-Current Trip Mode) .....	37
Loop Impedance in IT System Measurement .....	39
Line Impedance .....	39
RCD Tripping Time Measurements .....	42
Custom RCD Setting – Var mode .....	46
RCD Tripping Time in Auto mode .....	46
RCD Tripping Current Measurements .....	48
RCD Tests in IT Systems .....	52
Phase Rotation Tests .....	54
Earth Resistance Measurements .....	55

Applications .....	57
How to Test a Mains Socket and Ring Installation .....	57
Earth Resistance Test by Loop Method .....	58
Zmax .....	59
Auto Start .....	60
Loop Impedance Test with 10 mA RCD .....	60
Auto Test Sequence (1664 FC).....	61
Memory Mode .....	63
Store a Measurement.....	65
Recall a Measurement .....	65
Clear Memory.....	66
Memory Error Message.....	66
Download Test Results .....	67
Fluke Connect Wireless System .....	68
Maintenance .....	69
How to Test the Fuse .....	70
How to Test the Battery.....	70
Battery Replacement.....	70
Specifications.....	73
General Specifications .....	73
Maximum Display Values .....	75
Electrical Measurement Specifications.....	80
Operating Ranges and Uncertainties per EN 61557 .....	88
Operating Uncertainties per EN 61557.....	89

# List of Tables

<b>Table</b>	<b>Title</b>	<b>Page</b>
1.	Symbols .....	4
2.	Features .....	5
3.	Standard Accessories .....	6
4.	Country-Specific Mains Cords .....	7
5.	Rotary Dial .....	10
6.	Push Buttons .....	11
7.	Display Features .....	13
8.	Input Terminals.....	17
9.	Error Codes .....	18
10.	Power-On Options.....	20
11.	Volts Display/Dial and Terminal Settings.....	28
12.	Insulation Resistance Display/Dial and Terminal Settings.....	30
13.	Continuity Zero Display/Dial and Terminal Settings .....	33
14.	Loop/Line Impedance/Dial and Terminal Settings .....	35
15.	Line Impedance Test Display Dial and Terminal Settings .....	40
16.	RCD Tripping Time Display/Dial and Terminal Settings .....	44
17.	RCD Tripping Current/Dial and Terminal Settings.....	49
18.	Earth Resistance Display/Dial and Terminal Settings .....	56
19.	Auto Test Settings .....	62
20.	Replacement Parts.....	69



# *List of Figures*

<b>Figure</b>	<b>Title</b>	<b>Page</b>
1.	Lead Swapping Modes .....	22
2.	Zero Display .....	24
3.	Country-Specific Zero Adapter Configurations .....	25
4.	Connection for Safety Pretest .....	26
5.	Display for Safety Pretest.....	27
6.	Loop Impedance Test in IT System.....	39
7.	3-Phase System Measurement .....	42
8.	Connection for RCD Test on IT Electrical Systems .....	52
9.	Single Test Lead Configuration .....	53
10.	Phase Rotation Test Connection.....	54
11.	Phase Rotation Display .....	54
12.	Earth Resistance Test Connection .....	55
13.	3-Wire Connection for Earth Resistance Loop Test .....	58
14.	2-Wire Connection for Earth Resistance Loop Test (High-Current Trip Mode) .....	59
15.	Memory Mode .....	64
16.	IR Serial Cable Attachment .....	67
17.	Battery Replacement.....	72





## ***Introduction***

The Fluke 166X Series (the Tester or Product) are battery-powered electrical installation testers. This manual applies to all 1662, 1663, and 1664 FC models. All figures show the Model 1664 FC.

These Testers measure and test:

- Voltage and Frequency
- Insulation Resistance (EN61557-2)
- Continuity (EN61557-4)
- Loop/Line Resistance (EN61557-3)
- Residual Current Devices (RCD) Tripping Time (EN61557-6)
- RCD Tripping Current (EN61557-6)
- Phase Rotation (EN61557-7) *1663 and 1664 FC only*
- Earth Resistance (EN61557-5)

## ***How to Contact Fluke***

To contact Fluke, call one of the following telephone numbers:

- Technical Support USA: 1-800-44-FLUKE (1-800-443-5853)
- Calibration/Repair USA: 1-888-99-FLUKE (1-888-993-5853)
- United Kingdom: +44 1603 256600
- Germany, Austria, Switzerland: +49 (0)69 / 2 22 22-0210
- Canada: 1-800-36-FLUKE (1-800-363-5853)
- Europe: +31 402-675-200
- Japan: +81-3-6714-3144
- Singapore: +65-6799-5566
- Anywhere in the world: +1-425-446-5500

Or, visit Fluke's website at [www.fluke.com](http://www.fluke.com).

To register your product, visit <http://register.fluke.com>.

To view, print, or download the latest manual supplement, visit <http://us.fluke.com/usen/support/manuals>.

## Safety

See Table 1 for a list of symbols used on the Product and in this manual.

A **Warning** identifies hazardous conditions and procedures that are dangerous to the user.

A **Caution** identifies conditions and procedures that can cause damage to the Product or the equipment under test.













### Warnings

To prevent possible electrical shock, fire, or personal injury:

- Use the Product only as specified, or the protection supplied by the Product can be compromised.
- Carefully read all instructions.
- Read all safety information before you use the Product.
- Do not use the Product around explosive gas, vapor, or in damp or wet environments.
- Comply with local and national safety codes. Use personal protective equipment (approved rubber gloves, face protection, and flame-resistant clothes) to prevent shock and arc blast injury where hazardous live conductors are exposed.
- Do not use the Product in distribution systems with voltages >550 V.
- Use Product-approved measurement category (CAT), voltage, and amperage rated accessories (probes, test leads, and adapters) for all measurements.
- The battery door must be closed and locked before you operate the Product.
- Examine the case before you use the Product. Look for cracks or missing plastic. Carefully look at the insulation around the terminals.
- Do not use test leads if they are damaged. Examine the test leads for damaged insulation and measure a known voltage.
- Do not touch voltages >30 V ac rms, 42 V ac peak, or 60 V dc.

- Use the correct terminals, function, and range for measurements.
- Do not apply more than the rated voltage between the terminals or between each terminal and earth ground.
- Do not exceed the Measurement Category (CAT) rating of the lowest rated individual component of a Product, probe, or accessory.
- Keep fingers behind the finger guards on the probes.
- Measure a known voltage first to make sure that the Product operates correctly.
- Replace the batteries when the low battery indicator shows to prevent incorrect measurements.
- Remove all probes, test leads, and accessories before the battery door is opened.
- Be sure that the battery polarity is correct to prevent battery leakage.
- Repair the Product before use if the battery leaks.
- Have an approved technician repair the Product.
- Use only specified replacement parts.
- Replace a blown fuse with exact replacement only for continued protection against arc flash.
- Do not operate the Product with covers removed or the case open. Hazardous voltage exposure is possible.
- Disable the Product if it is damaged.
- Do not use the Product if it is damaged.
- Remove the input signals before you clean the Product.
- Use only current probes, test leads, and adapters supplied with the Product.
- Remove test leads from the Product before the case is opened.
- Do not use in CAT III or CAT IV environments without the protective cap installed. The protective cap decreases the possibility of arc flash caused by short circuits.

**Table 1. Symbols**

Symbol	Description
	WARNING. RISK OF DANGER.
	WARNING. HAZARDOUS VOLTAGE. Risk of electric shock.
	Consult user documentation.
	Fuse
	Double Insulated
	Earth
	WARNING. Do not apply >550 Volts.
	Battery Status
<b>CAT III</b>	Measurement Category III is applicable to test and measuring circuits connected to the distribution part of the building's low-voltage MAINS installation.
<b>CAT IV</b>	Measurement Category IV is applicable to test and measuring circuits connected at the source of the building's low-voltage MAINS installation.
	Conforms to European Union directives.
	Certified by CSA Group to North American safety standards.
	Conforms to relevant Australian EMC standards.
	Certified by TÜV SÜD Product Service.
	This product complies with the WEEE Directive marking requirements. The affixed label indicates that you must not discard this electrical/electronic product in domestic household waste. Product Category: With reference to the equipment types in the WEEE Directive Annex I, this product is classed as category 9 "Monitoring and Control Instrumentation" product. Do not dispose of this product as unsorted municipal waste.

## Features and Accessories

Table 2 is a list of features by model number.

**Table 2. Features**

Measurement Function	1662	1663	1664 FC
Voltage & Frequency	●	●	●
Wiring polarity checker	●	●	●
Insulation Resistance	●	●	●
Insulation safety pretest			●
Continuity & Resistance with auto polarity swap	●	●	●
Continuity & Resistance with 10 mA	●	●	●
Continuity & Resistance, choose input terminals with (F).		●	●
Zmax memory		●	●
Loop & Line Resistance	●	●	●
Loop & Line Resistance–mΩ resolution			●
Prospective Earth Fault Current (PEFC/I <sub>k</sub> ) Prospective Short-Circuit current (PSC/I <sub>k</sub> )	●	●	●
RCD tripping time	●	●	●
RCD tripping level (ramp test)	●	●	●
RCD variable current	●	●	●
Automatic RCD test sequence	●	●	●
Test pulse current sensitive RCDs (Type A)	●	●	●
Test smooth dc sensitive RCDs (Type B)		●	●
Earth Resistance		●	●
Phase Rotation Indicator	●	●	●
Auto test sequence			●
<b>Other Features</b>			
Self-test	●	●	●
Illuminated Display	●	●	●
Fluke Connect™ Wireless System			●
<b>Memory, Interface</b>			
Memory and Computer Interface	●	●	●
Fluke DMS Software (optional accessory)	●	●	●
Fluke FVF Software (optional accessory)	●	●	●
Fluke Connect™ smartphone app			●
<b>Included Accessories</b>			
Hard case	●	●	●
Remote control probe	●	●	●
Zero Adapter	●	●	●

The Product is delivered with the items listed in Table 3. If the Product is damaged or an item is missing, contact the place of purchase immediately.

**Table 3. Standard Accessories**

Description	1662 EU	1663/1664 FC EU	1662 UK	1663/1664 FC UK	Part Number
TP165X Test Probe with Remote Test Button	•	•	•	•	2107742
Country-Specific Mains Test Cord	•	•	•	•	See Table 4
TL-L1, Test Lead, Red	•	•			2044945
TL-L2, Test Lead Green	•	•			2044950
TL-L3, Test Lead Blue	•	•			2044961
Probe, Test, Banana Jack, 4 mm Tip, Red	•	•			2099044
Probe, Test, Banana Jack, 4 mm Tip, Green	•	•			2065297
Probe, Test, Banana Jack, 4 mm Tip, Blue	•	•			2068904
102-406-003, Probe cap,GS-38 Red	•	•			1942029
102-406-002, Probe cap,GS-38 Green	•	•			2065304
102-406-004, Probe cap,GS-38 Blue	•	•			2068919

**Table 3. Standard Accessories (cont.)**

Description	1662 EU	1663/1664 FC EU	1662 UK	1663/1664 FC UK	Part Number
AC285-5001,175-276-013 AC285 Large alligator clip, Red	•	•			2041727
AC285-5001-02,175-276-012 AC285 Large alligator clip, Green	•	•			2068133
AC285-5001-03,175-276-0114 AC285 Large alligator clip, Blue	•	•			2068265
Fused Probe Set, Red/Blue/Green with Lantern Spring, Cap, and Tip Cover			•	•	3989868
CD ROM, Users Manual	•	•	•	•	4477435
Quick Reference Guide	•	•	•	•	4477545
Tool Box (Hard Case with foam insert)	•	•	•	•	4688513
Carrying Strap, Padded	•	•	•	•	4502043
Fluke Zero Adapter	•	•	•	•	3301338

Table 4 is a list of the country-specific mains cords.

**Table 4. Country-Specific Mains Cords**

Mains Cord	Plug Type	Part Number
British	BS1363	4601070
Schuko	CEE 7/7	4601081
Denmark	AFSNIT 107-2-DI	4601129
Australia/New Zealand	AS 3112	4601118
Switzerland	SEV 1011	4601107
Italy	CEI 23-16/III	4601096
USA	NEMA 5-15	4601134



## Operation

The Product is easy to use. The rotary dial clearly indicates the selected function. Push buttons help you to quickly modify the test settings. The large display with backlight shows the test results in clear symbols on a one-level menu.

## Safety Features

Safety and performance are two of the most critical requirements for any electrical system. Good quality insulation, a properly working grounding system, and active protection assure the safety of people, electrical systems and buildings. These factors protect them against electrocution, fire, and other equipment damage.

## Touch Pad

The  button is surrounded by a touch pad (see Table 6). The touch pad measures the potential between the operator and the PE terminal on the Tester. If the touch pad potential exceeds 100 V, the  symbol above the touch pad is lit, the PE annunciator in the display is lit, and the beeper sounds.

## Live Circuit Detection

For continuity and insulation resistance measurements, the Product inhibits the test if the terminal voltage detected is >30 volts ac/dc before the test starts. The beeper sounds continuously if this voltage is present.

## Earth Resistance Measurement



The Product inhibits the test if >10 volts is detected between the test rods. More information about Earth Resistance measurements is on page 55.

## Safety Pretest

The 1664 FC model includes a Safety Pretest feature that detects any appliances connected to the circuit under test. The Safety Pretest gives you a warning before you start a test and prevents damage to appliances from the test voltage. More information about Safety Pretest is on page 26.



### ***Mains Wiring Indicator***

Icons (, , ) indicate if L-PE or L-N terminals are reversed. Instrument operation is inhibited and an error code is generated if the input voltage is not between 100 V and 500 V. The UK Loop and RCD tests are inhibited if the L-PE or the L-N terminals are reversed.

When a high voltage is measured between two wires,  shows on the display. See *How to Test a Mains Socket and Ring Installation* for more information.

### ***Quick Start***

This section is information that introduces you to the controls and inputs of the Tester. You will also find information about functions that apply globally as you use the Tester.

### ***How to Use the Rotary Dial***

Use the rotary dial (see Table 5) to select the test type.

Table 5. Rotary Dial

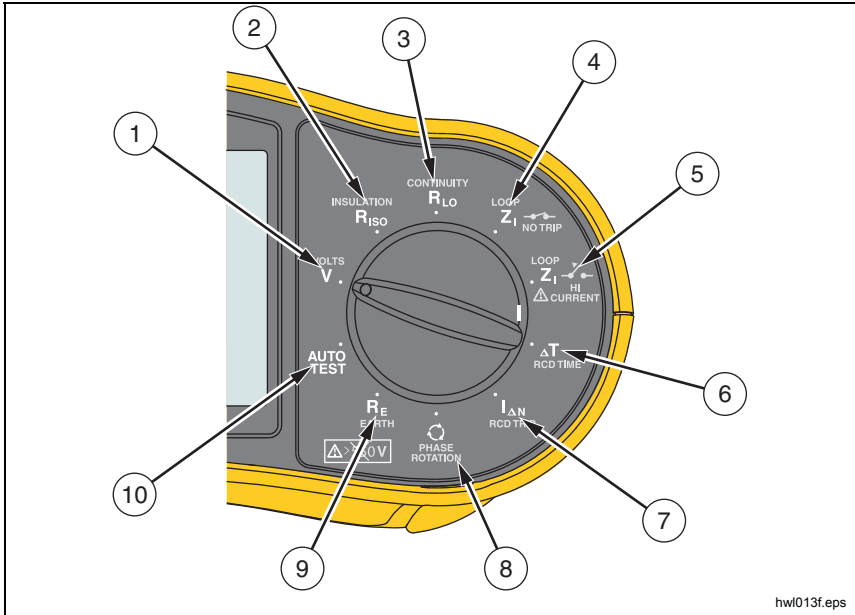

hwf013f.eps

Item	Symbol	Measurement Function
①	V	Volts
②	R <sub>ISO</sub>	Insulation resistance
③	R <sub>LO</sub>	Continuity
④	Z <sub>I</sub> NO TRIP	Loop/line impedance — No trip mode
⑤	LOOP Z <sub>I</sub> HI CURRENT	Loop/line impedance — High-current trip mode
⑥	ΔT Δ	RCD tripping time
⑦	I <sub>ΔN</sub> Δ	RCD tripping level
⑧	↻	Phase rotation
⑨	R <sub>E</sub>	Earth resistance (1663 and 1664 FC only)
⑩	AUTO TEST	Auto Test (1664 FC only)

## Push Buttons

Use the push buttons (Table 6) to control operation of the Tester, select test results to view, and scroll through selected test results.



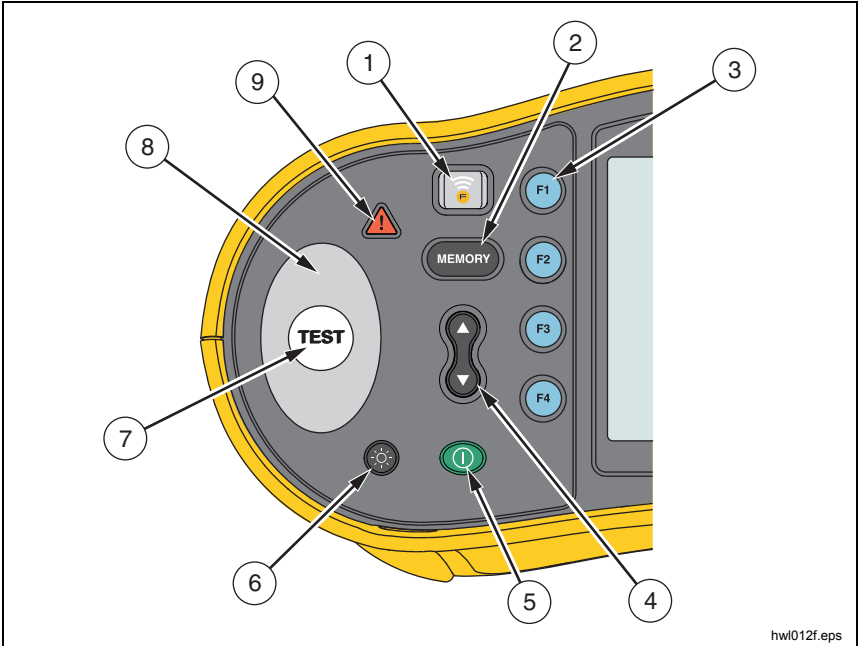

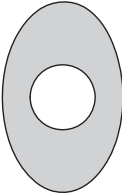



**Table 6. Push Buttons**



hw1012f.eps

Item	Push Button	Description
①		1664 FC only – Turn on the radio for Fluke Connect. Press  for >1 s to turn off the radio.
②		Go to/exit Memory mode.
③		Adjust function settings. See specific test instructions for more information.

**Table 6. Push Buttons (cont.)**

No.	Push Button	Description
④		Use the up/down button to select features on the display. See specific test instructions for more information.
⑤		Turn on and turn off the Tester. The Tester turns off automatically when inactive for >10 minutes.
⑥		Turn on and turn off the backlight.
⑦		Starts the selected test.
⑧		<p>Touch Pad. The  button is surrounded by a touch pad. Always contact the touch pad before .</p> <p>The touch pad measures the potential between the operator and the Tester's PE terminal, except in phase rotation.</p>
⑨		<p>Voltage warning. If the touch pad potential is &gt;100 V, the  symbol above the touch pad illuminates, the PE annunciator in the display is lit, and the beeper sounds. RCD and Loop tests will be inhibited. Not valid when measuring phase rotation.</p>

## Display

Table 7 is a list of the display features.



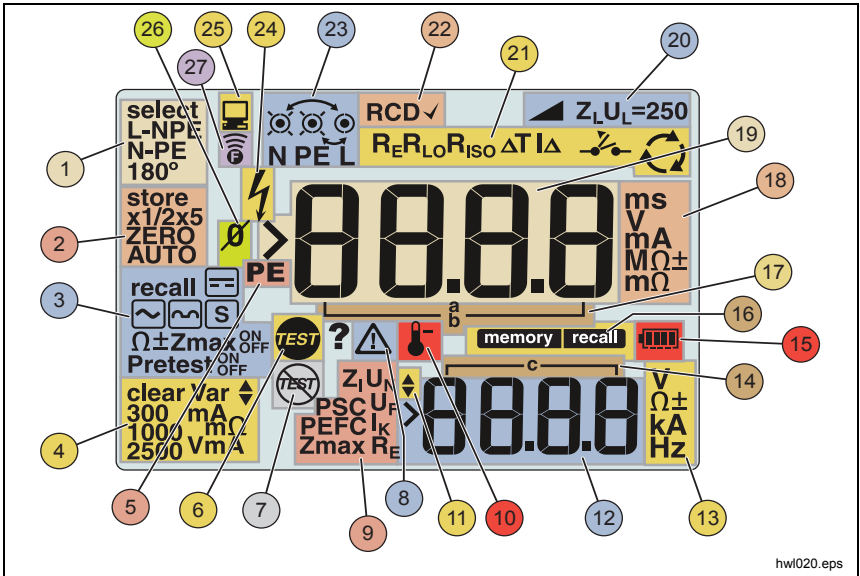

Table 7. Display Features



hw1020.eps

Item	Annunciator	Definition
①	F1 settings	Function varies. See specific test instructions for more information.
②	F2 settings	Function varies. See specific test instructions for more information.
③	F3 settings	Function varies. See specific test instructions for more information.
④	F4 settings	Function varies. See specific test instructions for more information.
⑤	<b>PE</b>	Illuminates only when the touch pad is touched to indicate that the PE input carries a high voltage (>100 V).
⑥	<b>TEST</b>	Turns on when you press the Test button. Turns off when the test is complete.

Table 7. Display Features (cont.)

Item	Annunciator	Definition
7		Safety Pretest has detected a connected appliance and stopped the test. See <i>Insulation Resistance Measurements</i> for more information.
8		Risk of danger. Appears when an error occurs. Test is disabled. See Table 9 for a list and explanation of possible error codes.
9	<p>Name of the secondary measurement function:</p> <p><b>Z<sub>I</sub></b></p> <p><b>U<sub>N</sub></b></p> <p><b>PSC</b></p> <p><b>U<sub>F</sub></b></p> <p><b>PEFC</b></p> <p><b>I<sub>K</sub></b></p> <p><b>Z<sub>max</sub></b></p> <p><b>R<sub>E</sub></b></p>	<p>Line impedance (line to neutral).</p> <p>Test voltage for insulation test.</p> <p>Prospective Short Circuit. Calculated from measured voltage and impedance when reading line to neutral.</p> <p>Fault voltage. Measures neutral to earth.</p> <p>Prospective Earth Fault Current. Calculated from voltage and loop impedance that is measured line to protective earth.</p> <p>In combination with the PSC or PEFC symbol, indicates a short circuit current.</p> <p>Recorded maximum value of chosen loop test.</p> <p>Earth resistance</p>
10		Appears when the Tester is overheated. The Loop test and RCD functions are inhibited when the Tester is overheated.
11		More results are available. Use  to scroll through the results.

**Table 7. Display Features (cont.)**











Item	Annunciator	Definition
⑫	> 88.8.8	Secondary display. A test can return more than one result or return a computed value based on the test result. See specific test instructions for more information.
⑬	V Ω± kA Hz	Measurement units for Secondary display.
⑭	┌ c ─┐	Memory locations. See <i>Memory Mode</i> for detailed information on how to use the memory locations.
⑮		Battery status. See <i>How to Test the Battery and Battery Replacement</i> sections for additional information on batteries and power management.
⑯	<b>memory</b>  <b>recall</b>	Shows when you press  .  Shows when you press  and look at stored data.
⑰	┌ a ─┐ b	Memory locations. See <i>Memory Mode</i> for detailed information on how to use the memory locations.
⑱	ms mV mA MΩ± mΩ	Measurement units for primary display.
⑲	> 88.8.8	Primary display.
⑳	▲ Z <sub>L</sub> U <sub>L</sub> =250	Indicates the preset fault voltage limit. The default setting is 50 V. Some locations require the fault voltage be set to 25 V, as specified by local electrical codes.

Table 7. Display Features (cont.)

Item	Annunciator	Definition
21	R <sub>E</sub> R <sub>Lo</sub> R <sub>Iso</sub> ΔT I <sub>Δ</sub> 	Indicates the selected rotary dial setting. The measurement value in the primary display also corresponds to the dial setting.
22	RCD ✓	Indicates that the measured trip current (trip current test) or the measured trip time (trip time test) meets the appropriate RCD standard. For more information, see the <i>RCD Tripping Time</i> table in the <i>Specifications</i> section of this manual.
23	○/●	Terminal indicator symbol (○). A terminal indicator symbol with a dot (●) in the center indicates the terminal is required for the selected function. The terminals are: <ul style="list-style-type: none"> <li>• L (Line)</li> <li>• PE (Protective Earth)</li> <li>• N (Neutral)</li> </ul>
		Arrows above or below the terminal indicator symbol indicate reversed polarity. Check the connection or check the wiring to correct.
		An "X" through the terminal indicator symbol indicates that the wire, test lead, and/or installation wire are broken.
24		High voltage present.
25		Data exchange with PC in process.
26		Appears when the leads are successfully zeroed. After the zeroing procedure, the icon illuminates to indicate that the zero value is stored for the selected input terminals. Only used for continuity or loop tests.
27		Radio is turned on. If  blinks steadily, 1664 FC is searching to connect. If it blinks at 5 s intervals, 1664 FC is connected to the Fluke Connect app. For more information about Fluke Connect, see page 68.



## Input Terminals

Table 8 shows the input terminals.

### ⚠️⚠️ Warning

**To prevent possible electrical shock, fire, or personal injury, do not use test leads in CAT III or CAT IV environments without the protective cap installed. The protective cap decreases the exposed probe metal to <4 mm. This decreases the possibility of arc flash from short circuits.**

**Table 8. Input Terminals**

Item	Description
①	IR Port
②	L/L1/H (Line)
③	PE/L2/E (Protective Earth)
④	N/L3/S (Neutral)

hw021f.eps

The IR (infrared) port allows you to connect the Tester to a computer and download the test data with a Fluke PC software product. With the software, you can collect, organize, and display the test data in a format that meets your needs. See *Download Test Results* for additional information on using the IR port.

## Error Codes

Various error conditions are detected by the Tester and are indicated with , **Err**, and an error code on the primary display. See Table 9. These error conditions disable or stop the test.

**Table 9. Error Codes**





apx032f.eps

Error Condition	Code	Solution
Self-Test Fails	1	Return the Tester to a Fluke Service Center. Secondary display shows additional code: 1: Unable to communicate with Analog board 2: Analog board operating variables errors 4: Fuse 1 error 8: Fuse 3 error (display shows FUSE) 16: Analog board ID does not match expected value 32: Digital flash CRC fault 64: Analog flash CRC fault
Over-Temp	2	Wait while the Tester cools down.











**Table 9. Error Codes (cont.)**

<b>Error Condition</b>	<b>Code</b>	<b>Solution</b>
Fault Voltage	4	Check the voltage between N and PE. RCD, socket test, $U_L$ is exceeded. Loop test no trip >10 V.
Excessive Noise	5	Turn off all appliances (Loop, RCD measurements) or move the earth stakes (earth measurement).
Excessive Probe Resistance	6	Put the stakes deeper into the soil. Tamp down the soil directly around the stakes. Pour water around the stakes but not at the earth ground under test.
Data Memory	9	The data memory is inconsistent. Download and save all data to a PC and clear all memory in the Tester. If the error persists, return the Tester to a Fluke Service Center.











## Power-On Options

To select a power-on option, press  and the function push button simultaneously and then release . See Table 10 for a description of the options. Power-on options are retained when the Tester is turned off.

**Table 10. Power-On Options**

Push Button	Power-On Option	Description
 	Firmware Version	Turn on the Tester and press  for >3 s. The firmware version shows when you release  .
 	IT mode toggle	In IT mode, a loop test or an RCD test is allowed even if the voltage N-PE is higher than 25 V / 50 V. The default setting is IT OFF.
 	Line and Neutral Swap mode toggle	<p>Configure the Tester to operate in L-n mode or L-n n-L mode, see Figure 1.</p> <ul style="list-style-type: none"> <li>In L-n mode, the L and N phase conductors must NEVER be reversed. This is a requirement in the UK and other regions. The  icon appears on the display to indicate that the system L and N conductors are swapped and the test is inhibited. Investigate and rectify the cause of this system fault before you continue. L-n mode also changes the RCD x1/2 trip time duration to 2000 ms. for UK requirement.</li> <li>In L-n n-L mode, the unit allows the L and N phase conductors to be swapped and tests will continue.</li> </ul> <p style="text-align: center;"><i>Note</i></p> <p><i>In locations where polarized plugs and outlets are used, a swapped lead icon () may indicate that the outlet was wired incorrectly. Correct this problem before you continue with any tests.</i></p> <p>The default setting in the UK is L-n. Elsewhere, the default setting is L-n n-L.</p>

**Table 10. Power-On Options (cont.)**

Push Button	Power-On Option	Description
 	Fault voltage limit	Toggles the fault voltage between 25 V and 50 V. The default setting is 50 V.
 	Serial Number	Primary display shows the initial four digits and the secondary display shows the next three digits.
 	Continuity beeper	Turn on and turn off the beeper. The default setting is bEEP on.
 	Auto Start	Automatic test start toggle. Simultaneously press  and the <b>UP</b> cursor. When turned on, the unit starts an RCD or loop test if mains voltage is detected. You do not need to press  . The default setting is AUST oFF.
	0 Hz/128 Hz	No Trip Loop test measurement frequency toggle. Simultaneously press  and the <b>DOWN</b> cursor. Use 0 Hz if the RCD under test has high impedance with the higher frequency. The default setting is 128 Hz.  <i>Note</i> <i>0 Hz is not available in the Auto Test Sequence.</i>

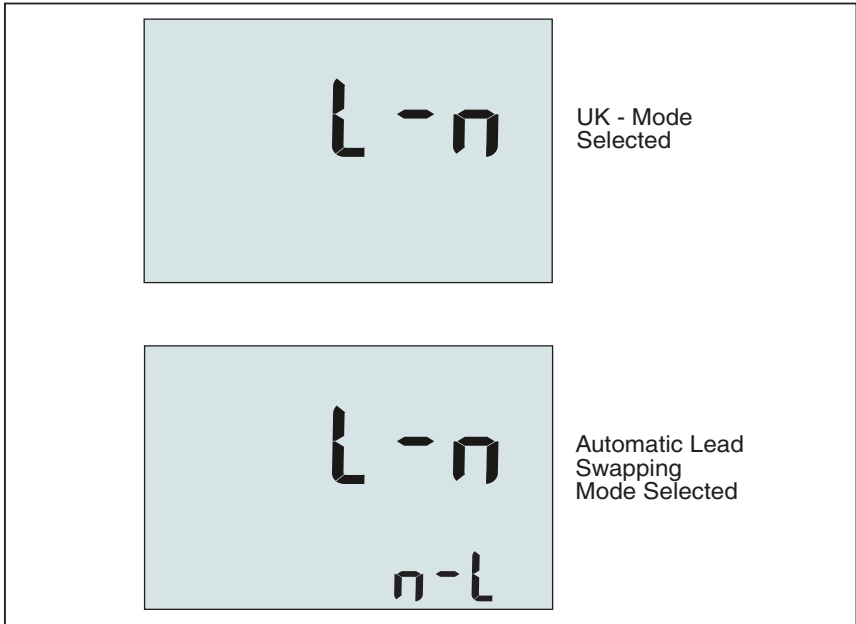

apx026f.eps

Figure 1. Lead Swapping Modes

### *How to Zero the Test Leads*



#### **⚠⚠ Warning**

**To prevent possible electrical shock, fire, or personal injury, do not use in CAT III or CAT IV environments without the protective cap installed. The protective cap decreases the exposed probe metal to <4 mm. This decreases the possibility of arc flash from short circuits.**

Test leads have a small amount of inherent resistance that can affect a measurement. Before you do continuity or loop impedance tests, use the zero adapter to compensate for, or zero, the test leads or the mains cord. See Figure 2 and Figure 3 for more information about the zero adapter.

The Tester maintains a separate zero value for each continuity range and loop impedance tests. A unique zero is stored for each lead combination in each function that allows the zero mode. The  $\text{Ø}$  annunciator indicates when a zero value is stored for the selected lead combination. For each continuity range, zeros are valid for both polarities.

To zero:

1. Turn the rotary dial to the  $z_1$  ,  $z_1$  , or **R<sub>LO</sub>** position.
2. For R<sub>LO</sub>, use  $\text{F4}$  to select 10 mA or 250 mA range. A separate zero value is retained for each range.
3. Connect the mains line cord (or the test leads) to the Tester and the zero adapter. You can zero two or three test leads in the R<sub>LO</sub> function.
4. Press and hold  $\text{F2}$  for 2 seconds to 6 seconds until the  $\text{Ø}$  annunciator and the offset value show in the primary display. The beeper sounds with each completed zero value.

The Tester measures the lead resistance, stores the value, and subtracts it from readings. The resistance value is retained when the power is turned off. If the Tester is the same function with the same test leads or mains cord, you do not need to repeat the zero operation.

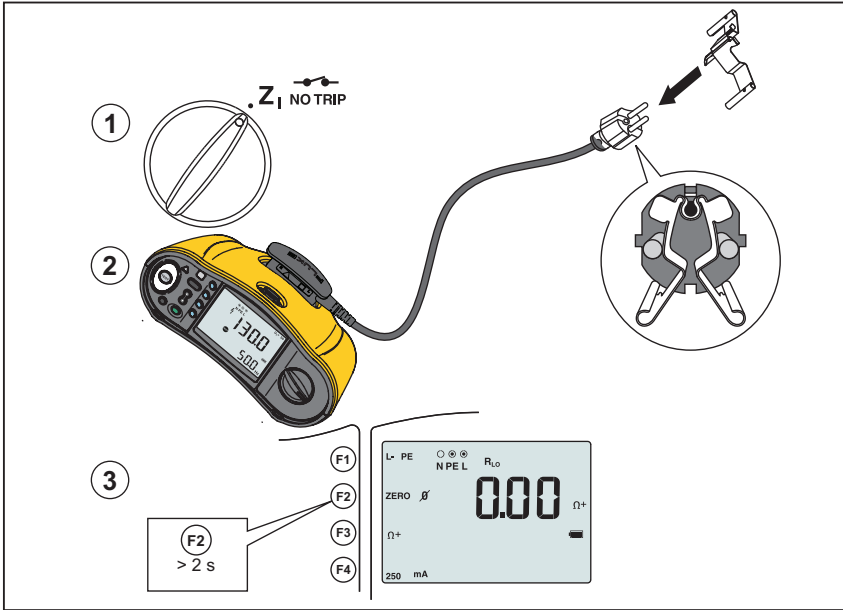

hw1058.eps

Figure 2. Zero Display

5. If the display reads  $>3.0 \Omega$ :
- For a Loop ( $Z_1$ ) test, check that all 3 leads are connected.
  - For a Continuity ( $R_{LO}$ ) test, check that all 3 leads are connected.
  - To zero 2 leads in the  $R_{LO}$  function, use **F1** to select the shorted leads and confirm **Ø** annunciator shows.
  - Check for damaged leads.

If the tester battery voltage is too low, the display shows **Lo BATT** and the Tester will not zero.



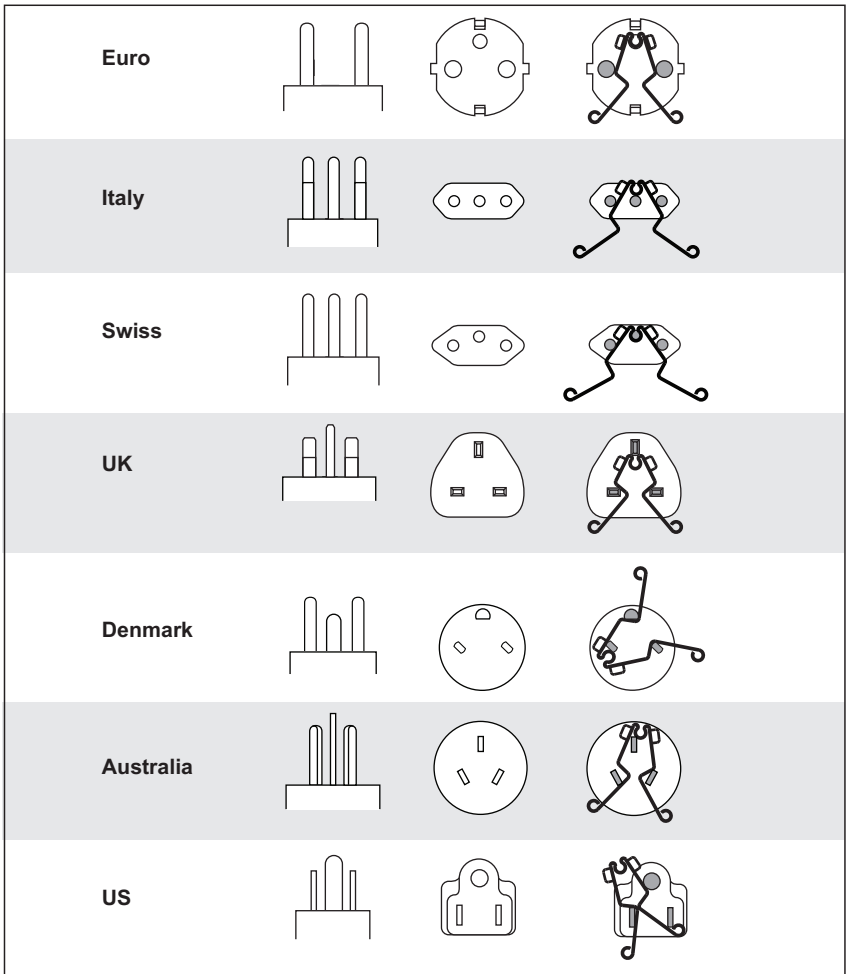

f03.eps

**Figure 3. Country-Specific Zero Adapter Configurations**

*Note*

*Be sure the batteries are in good charge condition before you zero the test leads.*

## Safety Pretest for Insulation Resistance Measurements

The 1664 FC model includes the Safety Pretest feature that detects any appliances connected to the circuit under test. Safety Pretest gives you a warning before you start a test and prevents damage to appliances from the test voltage.

To use Safety Pretest, the Tester must be connected to the phase (L terminal), neutral (N terminal) and protective earth line (PE terminal). See Figure 4. The Tester shows all three black dots in the terminal indicator annunciator to guide you. If you use the mains test cord at a mains socket, this condition is always true when the mains socket is wired correctly.

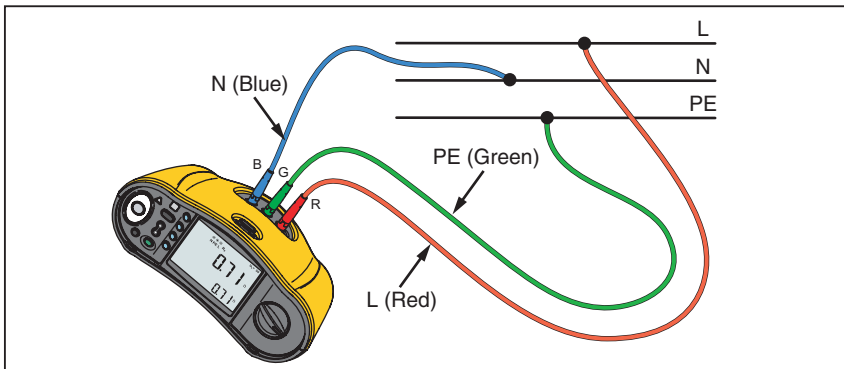
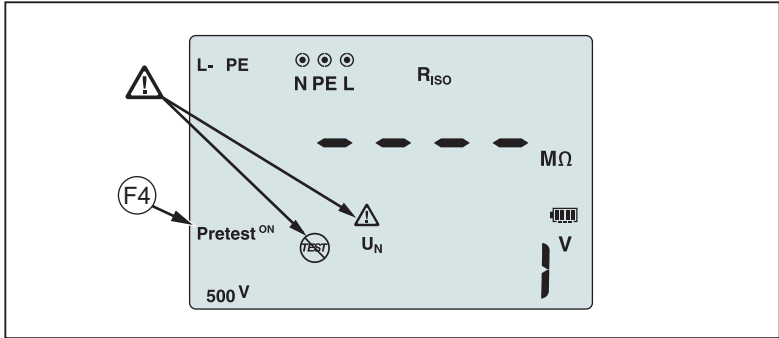

Figure 4. Connection for Safety Pretest

### ⚠ Caution

Safety Pretest works reliably only when you have connected the L terminal to the phase, the N terminal to the neutral line, and the PE terminal to the PE line.

If the Tester detects that an appliance is connected, it will stop the insulation test and show the screen in Figure 5.



hw1054.eps

**Figure 5. Display for Safety Pretest**

To continue an insulation test and override the warning, press  $\text{F3}$  to turn off the pretest.

**⚠ Caution**

**If you override the Safety Pretest warning and continue, the test voltage can damage any connected appliance.**

To restart the pretest, press  $\text{F3}$  again to turn on the pretest.

## Measurements

These Testers measure and test:

- Voltage and Frequency
- Insulation Resistance (EN61557-2)
- Continuity (EN61557-4)
- Loop/Line Resistance (EN61557-3)
- Residual Current Devices (RCD) Tripping Time (EN61557-6)
- RCD Tripping Current (EN61557-6)
- Phase Rotation (EN61557-7) 1663 and 1664 FC only
- Earth Resistance (EN61557-5)

## Volts and Frequency Measurements

To measure voltage and frequency:

1. Turn the rotary dial to the V position. See Table 11.

Table 11. Volts Display/Dial and Terminal Settings

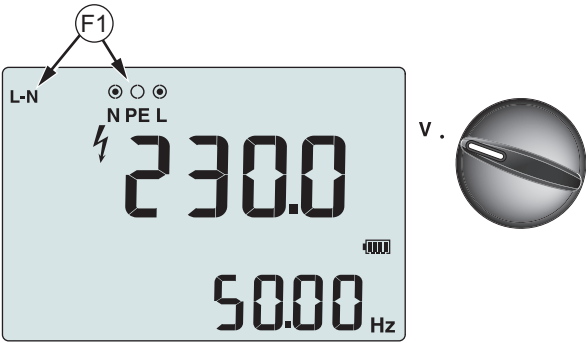

hwi002.eps

Push Button	Action	1664 FC	1663	1662
F1	Input select:  N PE L · N PE L · N PE L	•	•	•
F3	Display the battery level in the secondary display	•	•	•

2. Select any pair (red, blue, or green) of terminals for this test. You can use test leads or the mains test cord when you measure ac voltage.
  - The primary display shows the ac voltage. The Tester reads ac voltage up to 500 V. Press  $\text{F1}$  to toggle the voltage reading between L-PE, L-N, and N-PE.
  - The secondary display shows mains frequency.

*Note*

*The displayed voltages are valid only if the selected test leads (including installation wires) are connected and not broken.*

3. Press and hold  $\text{F9}$  for the battery level. The primary display shows **BATT**. The secondary display shows the battery voltage.

## **Insulation Resistance Measurements**

### **Warning**

**To prevent electric shock, measurements should only be done on de-energized circuits.**

To measure insulation resistance:

1. Turn the rotary dial to the  $R_{ISO}$  position. See Table 12.

Table 12. Insulation Resistance Display/Dial and Terminal Settings

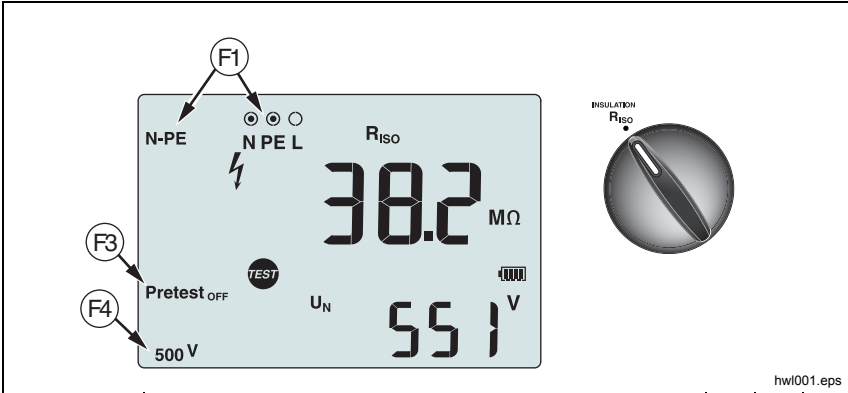

hw001.eps

Push Button	Action			
		1664 FC	1663	1662
F1	Input select: <input checked="" type="radio"/> <input type="radio"/> <input checked="" type="radio"/> <input type="radio"/> <input checked="" type="radio"/> <input checked="" type="radio"/> <input checked="" type="radio"/> <input type="radio"/> <input type="radio"/> N PE L · N PE L, N PE L	•		
	Input select: <input type="radio"/> <input checked="" type="radio"/> <input checked="" type="radio"/> N PE L		•	•
F3	Turn on or turn off the Safety Pretest	•		
F4	Select test voltage: 50, 100, 250, 500, or 1000 V	•	•	
	Select test voltage: 100, 250, 500, or 1000 V			•
TEST	Start the selected test	•	•	•

2. 1664 FC: Choose the test lead pair to use with (F1) and use the appropriate terminals for this test. You can also use the mains test cord.  
1662/1663: Use the L and PE (red and green) terminals for this test.
3. Use (F4) to select the test voltage. Most insulation tests are done at 500 V, but always observe any local test requirements.
4. 1664 FC: Activate Safety Pretest with (F3).

**⚠ Caution**

**Safety Pretest works reliably only when you have connected the L terminal to the phase, the N terminal to the neutral line, and the PE terminal to the PE line.**

5. Press and hold (TEST) until the reading settles and the Tester beeps:
  - The primary display shows the insulation resistance.
  - The secondary display shows the actual test voltage.

Tests are inhibited if voltage is detected in the line.

*Note*

*For normal insulation with high resistance, the output voltage ( $U_A$ ) should always be equal to or higher than the programmed voltage. If not, check the Tester connections, leads, and fuses. If insulation resistance is low, the test voltage is automatically reduced to limit the test current to a safe level.*

## Continuity Measurement

A continuity test is used to verify the integrity of connections with a high-resolution resistance measurement. This is important when you check Protective Earth connections. Measurements may be adversely affected by impedances or parallel circuits or transient currents.

### Note

*If electrical circuits are laid out in a ring, Fluke recommends that you make an end-to-end check of the ring at the electrical panel.*

### Warning

**To prevent possible electrical shock, fire, or personal injury, measurements should only be done on de-energized circuits.**

To measure continuity:

1. Turn the rotary dial to the  $R_{LO}$  position. See Table 13.
2. 1663/1664 FC: Choose the test lead pair to use with  $\text{F1}$  and use the appropriate terminals for this test.  
1662: Use the L and PE (red and green) terminals for this test.

This option is for tests at the ring installation or to verify the connection between protective earth and neutral at a mains socket. To avoid tripping the RCD, use the 10 mA test current.

3. Choose the test current polarity with  $\text{F3}$ .  
The + is positive current. The – is negative current. The  $\pm$  option makes a measurement with both polarities. The average between the positive and negative result shows in the primary display. If you choose the  $\pm$  option for polarity, the positive result shows in the secondary display. Press  $\text{F8}$  to toggle between the positive and negative intermediate result.
4. Choose the maximum test current with  $\text{F4}$ . To not trip an RCD, use the 10 mA setting for a ring installation test that includes the neutral or phase wire.



5. If not already done, zero the test leads. For more information, see *How to Zero the Test Leads*.  
If the tester battery voltage is too low, the display shows **Lo BATT** and the Tester will not zero.
6. Press and hold **TEST** until the reading settles. If the continuity beeper is turned on, the Tester beeps repeatedly for measured values  $<2 \Omega$ . For measured values  $>2 \Omega$ , the Tester does not beep.

**Table 13. Continuity Zero Display/Dial and Terminal Settings**

hw003.eps

Push Button	Action	1664 FC	1663	1662
F1	Input select: <input type="radio"/> <input type="radio"/> <input type="radio"/> <input type="radio"/> <input type="radio"/> <input type="radio"/> <input type="radio"/> <input type="radio"/> <input type="radio"/> <input type="radio"/> N PE L, N PE L, N PE L	•	•	
	Input select: <input type="radio"/> <input type="radio"/> <input type="radio"/> N PE L			•
F2	Zero the test lead resistance offset	•	•	•
F3	Select the test current polarity	•	•	•
F4	Select the maximum test current: 10 mA or 250 mA	•	•	•
TEST	Start the selected test	•	•	•

If a circuit is live, the test is inhibited and the ac voltage appears in the secondary display.

## Loop/Line Impedance Measurements

### Loop Impedance (Line to Protective Earth L-PE)

Loop impedance is source impedance measured between Line (L) and Protective Earth (PE). You can determine the Prospective Earth Fault Current (PEFC). PEFC is the current that could potentially flow if the phase conductor is shorted to the protective earth conductor. The Tester calculates the PEFC as the measured mains voltage divided by the loop impedance. The loop impedance function applies a test current that flows to earth. If RCDs are present in the circuit, they may trip. To avoid tripping, use the  $Z_{I, \text{NO TRIP}}$  function on the rotary dial. The no trip test applies a special test that prevents RCDs in the system from tripping. If you are certain no RCDs are in the circuit, you can use the  $Z_I$  High-Current function for a faster, less noisy test.

#### Note

*If the L and N terminals are reversed, the Tester will auto-swap them internally and continue the test. This condition is indicated by arrows above or below the terminal indicator symbol ( $\text{L} \rightleftarrows \text{N}$ ).  
If the Tester is configured for UK operation, L and N will not auto-swap and the test stops.*

#### Tips:

- Use the  $Z_{I, \text{NO TRIP}}$  position for loop measurements.
- Preload conditions can cause the RCD to trip.
- An RCD with a nominal fault current of 10 mA will trip.
- To test loop impedance in a circuit with a 10 mA RCD, see the Applications section.

To measure loop impedance no trip mode for L-PE:

1. Turn the rotary dial to the  $Z_1$  NO TRIP position. See Table 14.

**Table 14. Loop/Line Impedance/Dial and Terminal Settings**

hw/006.eps

Push Button	Action	1664 FC	1663	1662
(F1)	Input select: $\odot \circ \odot \odot \odot \odot$ N PE L, N PE L	•	•	•
(F2)	Zero the test lead resistance offset	•	•	•
(F3)	Turn on or turn off Zmax	•	•	
TEST	Start the selected test	•	•	•

2. Press (F1) to select L-PE. The display shows the  $Z_L$  and  $\text{---}$  indicators.

3. Connect and zero the test leads or mains line cord. More information about how to zero the test leads is on page 22.
4. With 1663 and 1664 FC models, press **F3** to toggle the Zmax monitor. If Zmax is turned on, consecutive measurements are compared. The secondary display shows the maximum  $Z_L$  (or  $Z_I$  if F1 = L-N) value until Zmax is turned off.
5. Connect all three leads to the L, PE, and N of the system under test or plug the mains test cord into the socket under test.
6. Touch the touch pad and watch the front panel for the **⚠** warning. See *Safety Features* for more information.
7. Press and release **TEST**. If Auto Start (Power-on option: **Ⓞ** + up **⏴**) is turned on, the test starts automatically as soon as the mains voltage is detected and the required test leads are connected.
8. Wait for the test to complete. The primary display shows the loop impedance.  
The Prospective Earth Fault Current appears in amperes or kiloamperes in the secondary display.
9. Press the down **⏵** to display Zmax if it is turned on. Press the down **⏵** several times to show the PSC, Zmax,  $Z_L$ , and  $R_E$  values.
10. Press the down **⏵** again to display the  $Z_I$  value.

This test will take several seconds to complete. If you disconnect the mains while the test is active, the test automatically stops.



*Note*

*Errors may occur due to a preload on the circuit under test. If the measurement is too noisy, Err 5 shows on the display. (The measured value accuracy is degraded by the noise). Press **⏴** to show the measurement. Press **⏴** to return to the Err 5 display. If the Tester shows 0.00  $\Omega$ , consider that no perfect circuit exists. Check for correct lead connection to instrument, leads are zeroed, and fuse is good.*

## Loop Impedance (High-Current Trip Mode)





To measure loop impedance—high-current trip mode:

If no RCDs are present in the system under test, you can use the high-current Line Earth (L-PE) loop impedance test.

1. Turn the rotary dial to the  $Z_L$   position. The  shows on the display to indicate that high-current trip mode is selected.
2. Connect the leads to the L and PE (red and green) terminals of the Tester.
3. Press  $F1$  to select L-PE or L-N.
4. 1664 FC only, press  $F4$  to select between  $\Omega$  and  $m\Omega$  resolution for the test results. The  $m\Omega$  resolution test takes between 30 seconds and 60 seconds to complete.
5. Zero the test leads. For a Loop ( $Z_L$ ) test, check that all 3 leads are shorted.
6. More information about how to zero the test leads is on page 22.
6. For 1663 and 1664 FC only, press  $F3$  to toggle the Zmax monitor.

If Zmax is turned on, consecutive measurements are compared. The secondary display shows the maximum  $Z_L$  (or  $Z_N$  if F1 = L-N) value until Zmax is turned off. The Zmax value is saved when you save the test result. If you change the location fields a, b, or c before you save, the actual test result is the new Zmax. The Tester retains the Zmax value between the  $Z_L$  No Trip and  $Z_L$  Hi Current tests.

7. Connect the leads to the L and PE of the system under test or connect the mains test cord to the socket under test.
8. Touch the touch pad and watch the front panel for the  warning.

9. Press and release . If Auto Start (Power-on option:  + up ) is turned on, the test starts automatically as soon as the mains voltage is detected and the required test leads are connected.
10. Wait for the test to complete. The primary display shows the loop impedance.  
  
The Prospective Earth Fault Current (PEFC) appears in amperes or kiloamperes in the secondary display.
11. If Zmax is turned on, press the down  to show the Zmax value in the secondary display.

** Warning**

**To prevent possible electrical shock, fire, or personal injury, ensure there are no RCDs present. The display symbol  indicates the high-current loop mode. Any RCDs in the system will trip.**

*Note*

*The Tester may show a test result even if the RCD is tripped if the trip time is >10 ms. Because of the short measurement, the test result does not meet the published specification. If the Tester shows 0.00  $\Omega$ , consider that no perfect circuit exists. Check for correct lead connection to instrument, leads are zeroed, and fuse is good.*

## Loop Impedance in IT System Measurement

To measure the loop impedance at the mains socket, put the Tester in IT mode (Power On option:  $\text{F1}$  +  $\text{F2}$ ). In the IT mode, the Tester accepts any voltage between N and PE, but loop test with the High-current trip mode only. See Figure 6.

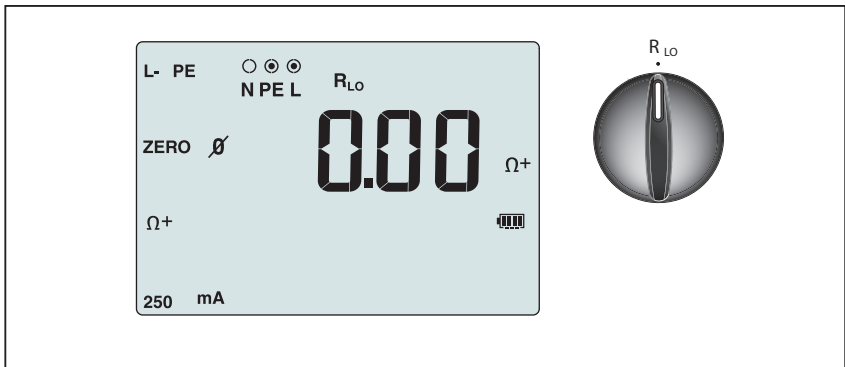

Figure 6. Loop Impedance Test in IT System

## Line Impedance

Line impedance is source impedance measured between Line conductors or Line and Neutral. This function allows these tests:

- Line to Neutral loop impedance.
- Line to Line impedance in 3-phase systems.
- L-PE loop measurement. This is a high-current, 2-wire loop measurement. It cannot be used on circuits protected by RCDs because it will cause them to trip.
- Prospective Short Circuit Current (PSC). PSC is the current that can potentially flow if the phase conductor is shorted to the neutral conductor or another phase conductor. The Tester calculates the PSC current as the measured mains voltage divided by the line impedance.

To measure line impedance:

1. Turn the rotary dial to the  $Z_{\Delta \text{TRIP}}$  HI CURRENT position. See Table 15.
2. Connect the red lead to the L (red) and the blue lead to the N (blue) terminals of the Tester.
3. Press  $\text{F1}$  to select L-N.

4. 1664 FC only, press (F4) to select between  $\Omega$  and  $m\Omega$  resolution for the test results. The  $m\Omega$  resolution test takes between 30 seconds and 60 seconds to complete.
5. Zero the test leads. More information about how to zero the test leads is on page 22.

**Table 15. Line Impedance Test Display Dial and Terminal Settings**

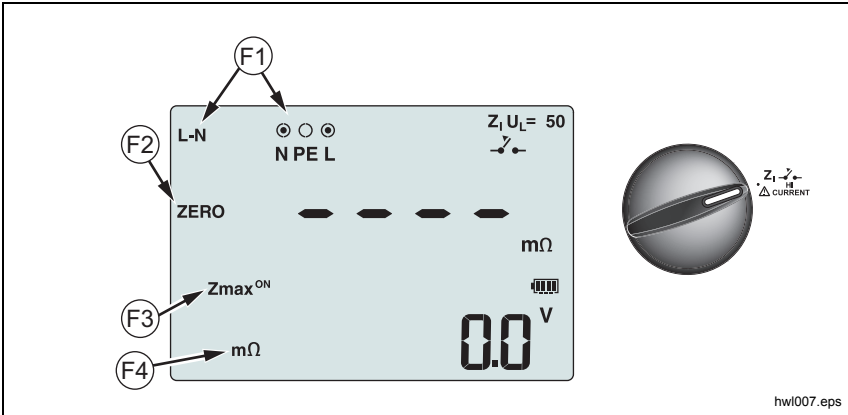

Push Button	Action	1664 FC	1663	1662
(F1)	Input select: $\odot \circ \odot \circ \odot \odot$ N PE L · N PE L	•	•	•
(F2)	Zero the test lead resistance offset	•	•	•
(F3)	Turn on or turn off Zmax	•	•	
(F4)	Select loop impedance test accuracy: $\Omega$ , $m\Omega$ (high-current trip mode only)	•		
(TEST)	Start the selected test	•	•	•





6. Press (F3) to toggle the Zmax monitor.



If Zmax is turned on, consecutive measurements are compared. The secondary display shows the maximum  $Z_L$  (or  $Z_I$  if F1 = L-N) value until Zmax is turned off. The Zmax value is saved when you save the test result. If you change the location fields a, b, or c before you save, the actual test result is the new Zmax.

*Note*

*RCDs in the system will trip if you use L-PE.*

7. Connect the leads in a single-phase test to the system live and neutral. To measure line-to-line impedance in a 3-phase system, connect the leads to two phases.
8. Press and release . If Auto Start (Power-on option:  + up ) is turned on, the test starts automatically as soon as the mains voltage is detected and the required test leads are connected.  
Wait for the test to complete.
  - The primary display shows the line impedance.
  - The secondary display shows the Prospective Short Circuit Current (PSC).
9. If Zmax is turned on, press the down  to show the Zmax value in the secondary display.

Use the connection shown in Figure 7 for a 3-phase 500 V system measurement.

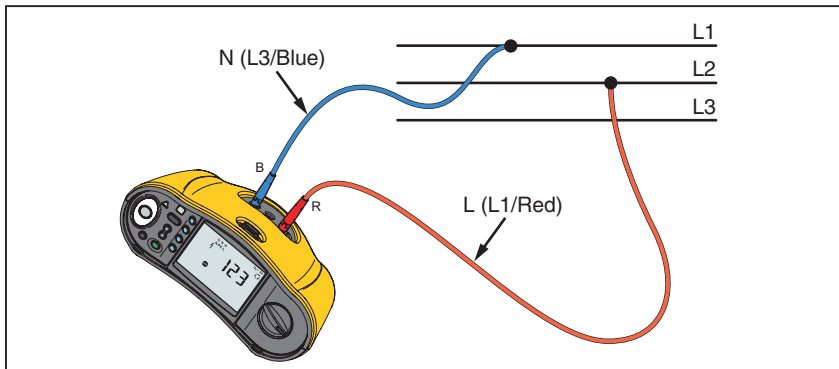

hwf025.eps

Figure 7. 3-Phase System Measurement

## RCD Tripping Time Measurements



In this test, a calibrated fault current is induced into the circuit to cause the RCD to trip. The meter measures and shows the time required for the RCD to trip. You can do this test with test leads or the mains cord. The test is done with a live circuit.

You can use the Tester to do the RCD tripping time test in Auto Start, which makes it easier for one person to do the test. If the RCD has a special nominal current setting other than the standard options, 10, 30, 100, 300, and 500, or 1000 mA, you can use a custom setting with the Var mode.

### Note

*When you make trip time measurements for any type of RCD, the Tester first determines if the actual test will cause a fault voltage exceeding the limit (25 V or 50 V). If yes, Err4 shows on the display.*

*To avoid having an inaccurate trip time for S type (time delay) RCDs, a 30 second delay is activated between the pretest and the actual test. This RCD type needs a delay because it contains RC circuits that are required to settle before applying the full test.*

RCD type B, B+ () or S-type B, B+ () are actually two RCDs, one with type A/AC behavior and one with type B. The type B RCD is correctly tested only with the trip current (ramp) test. For trip time measurements, even with type B selected, the ac part of the RCD might cause the tripping because of the initial step of the test current. Fluke recommends that you do a trip current test with type B and a test with type A/AC waveform.

**  Warning**

**To prevent possible electrical shock, fire, or personal injury:**

- **Test the connection between the N-conductor and earth before you start the test. A voltage between the N-conductor and earth may influence the test.**
- **Leakage currents in the circuit that follow the residual current protection device may influence measurements.**
- **The displayed fault voltage relates to the rated residual current of the RCD.**
- **Potential fields of other earthing installations may influence the measurement.**
- **Equipment (motors, capacitors) connected downstream of the RCD may cause considerable extension of the tripping time.**

*Note*

*If the L and N terminals are reversed, the Tester will automatically swap them internally and continue tests. If the Tester is configured for UK operation, tests will stop and you will need to determine why the L and N are swapped. This condition is indicated by arrows above the terminal indicator symbol (.*

*Type A and type B RCDs do not have the 1000 mA option available. Type B RCDs do not have the Var option available. When testing under a condition that would trip an RCD, but does not (for example, reading is >310 ms), check the connections, leads and fuses.*

To measure RCD tripping time:

1. Turn the rotary dial to the  $\Delta T$  position. See Table 16.



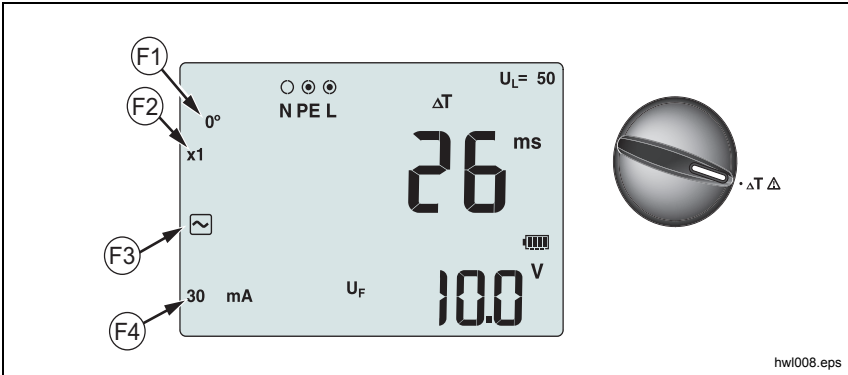

**Table 16. RCD Tripping Time Display/Dial and Terminal Settings**





Push Button	Action	hwl008.eps		
		1664 FC	1663	1662
F1	Select RCD test polarity: 0° or 180°	•	•	•
F2	RCD current multiplier: x1/2, x1, x5, or Auto	•	•	•
F3	Select RCD	•	•	•
F4	RCD current setting: 10 mA, 30 mA, 100 mA, 300 mA, 500 mA or Var	•	•	•
TEST	Start the selected test	•	•	•

- Press **F4** to select the RCD current setting (10, 30, 100, 300, 500, or 1000 mA).
- Press **F2** to select a test current multiplier (x ½, x 1, x 5, or Auto). Normally you will use x 1 for this test.

4. Press **F3** to select the RCD test-current waveform:

-  – AC current to test type AC (standard AC RCD) and type A (pulse-DC sensitive RCD)
-  – Half-wave current to test type A (pulse-DC sensitive RCD)
-  **S** – Delayed response to test S-type AC (time delayed AC RCD)
-  **S** – Delayed response to S-type A (time delayed pulse-DC sensitive RCD)

**1664 FC/1663**

-  – Smooth-DC current to test type B RCD
-  **S** – Delayed response to S-type B (time delayed smooth-DC current RCD)



*Note*

*For type F, G, K or R RCDs, choose type A (half-wave current). The symbol **RCD** ✓ is not triggered on the short delay of 10 ms of the G, K, and R types. These types need a trip time of at least 10 ms.*

*Type B+ RCDs are tested with type B smooth dc-current.*



5. Press **F1** to select the test current phase, 0 ° or 180 °. RCDs should be tested with both phase settings, as their response time can vary significantly.

*Note*



*For RCD type B () or S-type B ( **S**), you must test with both phase settings.*

6. At a minimum, connect the leads to L and PE of the system under test, or plug the mains test cord into the socket under test.

*Note*

*For RCD type B () or S-type B ( **S**) all three test leads are required.*

7. Press and release .

If Auto Start (Power-on option:  + up ) is turned on, the test starts automatically as soon as the mains voltage is detected and the required test leads are connected.

8. Wait for the test to complete.
  - The primary display shows the trip time.
  - The secondary display shows the fault voltage (voltage drop on PE wire) related to the rated residual current.
  - If the trip time meets the appropriate standard of the RCD, the **RCD** ✓ indicator shows. For more information, see the *RCD Tripping Time* table in the *Specifications* section of this manual.

### *Custom RCD Setting – Var mode*

To measure RCD tripping time for a custom RCD setting – Var mode:

1. Turn the rotary dial to the  $\Delta T$  (or  $I_{\Delta N}$  for Tripping Current measurement) position.
2. Press (F4) to select the Var current rating. The current custom setting shows on the primary display. Use (0) to adjust the value.
3. Press (F2) to select a test current multiplier. Normally you will use x 1/2 or x 1 for this test.
4. Repeat steps 4 through 7 listed in the RCD tripping time measurement procedure.
5. To view the nominal setting used for the test, press (0).

#### *Note*

*The maximum setting for type A RCDs is 700 mA. Var mode is not available for type B RCDs.*

### *RCD Tripping Time in Auto mode*

To measure RCD tripping time in Auto mode:

1. Plug the Tester into the outlet.
2. Turn the rotary dial to the  $\Delta T$  position.
3. Press (F4) to select the RCD current rating (10 mA, 30 mA, or 100 mA).
4. Press (F2) to select Auto mode.

5. Press **F3** to select the RCD test-current waveform.
6. At a minimum, connect the leads to L and PE of the system under test, or plug the mains test cord into the socket under test.

*Note*

*For RCD type B (**F3**) or S-type B (**F3** **S**) all three test leads are required.*

7. Press and release **TEST**. If Auto Start (Power-on option: **Ⓞ** + up **↕**) is turned on, the test starts automatically as soon as the mains voltage is detected and the required test leads are connected.

The Tester supplies ½x the rated RCD current for 310 ms or 510 ms (2000 ms in the UK). If the RCD trips, the test terminates. If the RCD does not trip, the Tester reverses phase and repeats the test. The test terminates if the RCD Trips.



If the RCD does not trip, the Tester restores the initial phase setting and supplies 1x the rated RCD current. The RCD should trip and the test results appear in the primary display.

8. Reset the RCD.
9. The Tester reverses phases and repeats the 1x test. The RCD should trip and the test results appear in the primary display.
10. Reset the RCD.
11. The Tester restores the initial phase setting and supplies 5x the rated RCD current for up to 50 ms. The RCD should trip and the test results appear in the primary display.
12. Reset the RCD.
13. The Tester reverses phase and repeats the 5x test. The RCD should trip and the test results appear in the primary display.
14. Reset the RCD.
  - You can use the **↕** arrow buttons to review test results. The first result shown is the last measurement taken, the 5x current test. Press the down arrow button **↕** to move backward to the first test at ½x the rated current.
  - If the trip time meets the appropriate standard of the RCD, the RCD ✓ indicator shows. For more information, see *RCD Tripping Time* table in *Specifications* section.
15. Test results are in temporary memory. If you want to store all test results, press **MEMORY** and proceed as described in the *Memory Mode* section of this manual.

## RCD Tripping Current Measurements

This test measures the RCD tripping current as you apply a test current and then gradually increase the current until the RCD trips. You can use the test leads or mains test cord for this test.



### Note

For RCD type B () or S-type B ( ) all three test leads are required.

### Warning

To prevent possible electrical shock, fire, or personal injury:

- **Test the connection between the N-conductor and earth before you start the test. A voltage between the N-conductor and earth may influence the test.**
- **Leakage currents in the circuit that follow the residual current protection device may influence measurements.**
- **The displayed fault voltage relates to the rated residual current of the RCD.**
- **Potential fields of other earthing installations may influence the measurement.**

If the L and N terminals are reversed, the Tester will automatically swap them internally and continue tests. If the Tester is configured for UK operation, tests stop and you will need to determine why the L and N are swapped. This condition is indicated by arrows above the terminal indicator symbol ( ).



To measure RCD tripping current:

1. Turn the rotary dial to the  $I_{\Delta N}$  position. See Table 17.



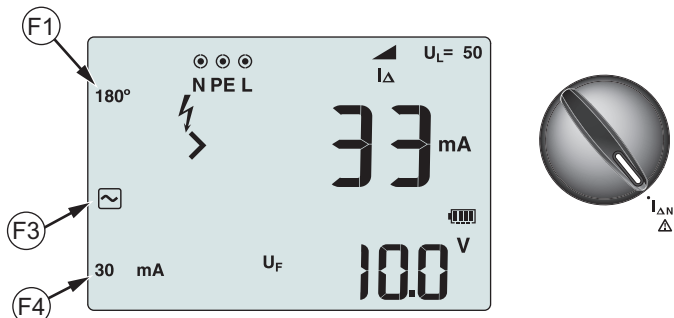

**Table 17. RCD Tripping Current/Dial and Terminal Settings**





hw1009.eps

Push Button	Action	1664 FC	1663	1662
(F1)	Select RCD test polarity: 0° or 180°	•	•	•
(F3)	Select RCD	•	•	•
(F4)	RCD current setting: 10 mA, 30 mA, 100 mA, 300 mA, 500 mA, 1000 mA, or Var	•	•	•
(TEST)	Start the selected test	•	•	•

2. Press (F4) to select the RCD current rating (10, 30, 100, 300, 500, 1000 mA). If the RCD has a special nominal current setting other than the standard options, you can use a custom setting with the Var mode.

3. Press **F3** to select the RCD test-current waveform:
-  – AC current to test type AC (standard AC RCD) and type A (pulse-DC sensitive RCD)
  -  – Half-wave current to test type A (pulse-DC sensitive RCD)
  -  **S** – Delayed response to test S-type AC (time delayed AC RCD)
  -  **S** – Delayed response to S-type A (time delayed pulse-DC sensitive RCD)

**1664 FC/1663:**



-  – Smooth-DC current to test type B RCD
-  **S** – Delayed response to S-type B (time delayed smooth-DC current RCD)

*Note*

*For type F, G, K or R RCDs, choose type A (half-wave current). The symbol **RCD** ✓ does not consider the short delay of 10 ms of the G, K and R types. These types need a trip time of at least 10 ms.*



4. Press **F1** to select the test current phase, 0 ° or 180 °. RCDs should be tested with both phase settings, as their response time can vary significantly.

*Note*

*For RCD type B () or S-type B ( **S**), you must test with both phase settings.*

5. At a minimum, connect the leads to L and PE of the system under test, or plug the mains test cord into the socket under test.

*Note*

*For RCD type B () or S-type B ( **S**) all three test leads are required.*

6. Press and release . If Auto Start is turned on (Power-on option 'Up'), the test starts automatically as soon as the mains voltage is detected and the required test leads are connected.

Wait for the test to complete.

- The primary display shows the RCD trip current.
- The secondary display shows the fault voltage (voltage drop on PE wire) related to the rated residual current.
- For type A and type AC waveforms, press down  to display the trip time.
- If the trip current and the trip time (Type A / AC RCDs only) meets the appropriate standard of the RCD, **RCD** ✓ shows on the display. For more information, see the *RCD Tripping Time* table in the *Specifications* section.

To measure RCD tripping current for a custom RCD setting - Var mode, see page 46.

## RCD Tests in IT Systems

RCD tests at locations with IT systems requires a special test procedure because the Protective Earth connection is grounded locally and is not tied directly to the power system.

The test is done at the electrical panel with probes. See Figure 8 for the connections used in this test.

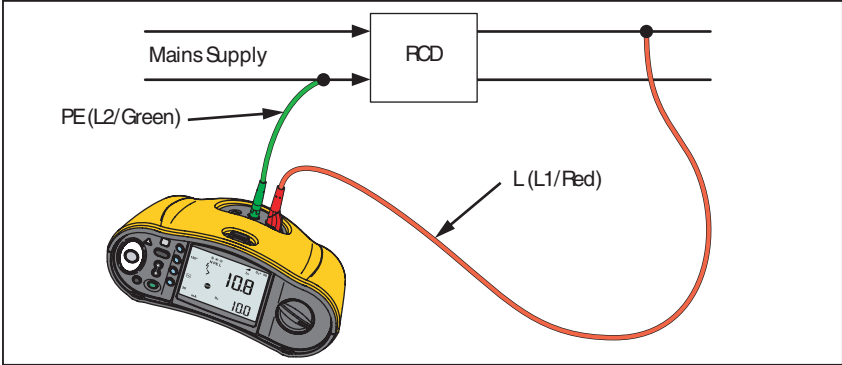

hw023.eps

Figure 8. Connection for RCD Test on IT Electrical Systems

The test current flows through the upper side of the RCD, into the L terminal, and returns through the PE terminal.

To test an RCD at the mains socket, put the Tester into the IT mode (Power-on option: ① + ②). In this mode the Tester accepts any voltage between N and PE. The precondition for trip time and current measurements is that the resistance of the earth ground system is low enough to allow the test current flow.

If RCD does not trip, use the single test lead configuration. See Figure 9.

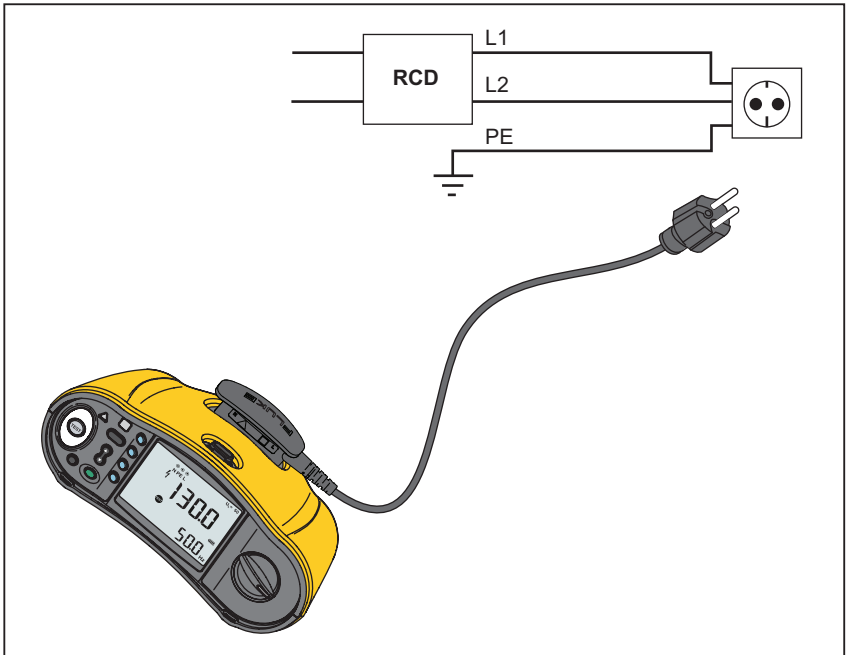

hw1053.eps

**Figure 9. Single Test Lead Configuration**

## Phase Rotation Tests

Use the connection shown in Figure 10 for a phase rotation test connection.

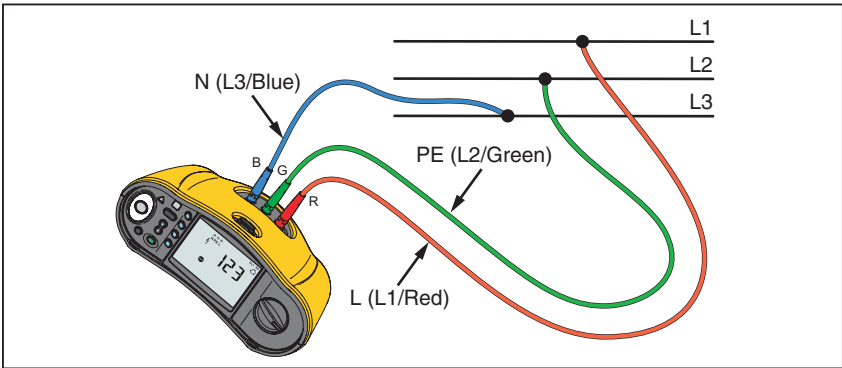



Figure 10. Phase Rotation Test Connection

hw1022.eps

To do a phase rotation test:

1. Turn the rotary dial to the  position. See Figure 11.

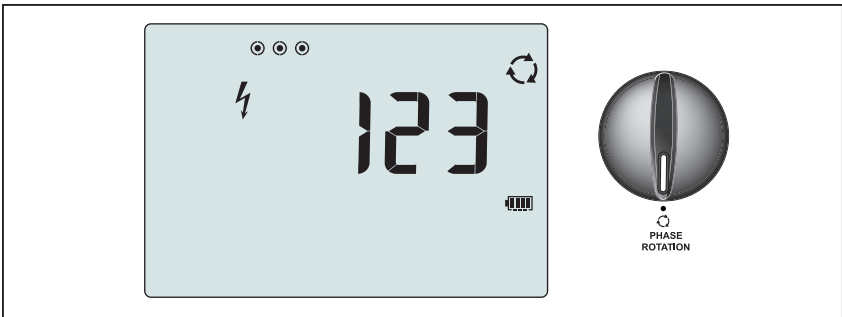

Figure 11. Phase Rotation Display

hw1011.eps

2. The primary display shows:
  - 123 for correct phase rotation.
  - 321 for reversed phase rotation.
  - Dashes (---) when insufficient voltage is sensed.

## **Earth Resistance Measurements (1663 and 1664 FC)**

The earth resistance test is a 3-wire test that has two test stakes and the earth electrode under test. This test requires an accessory stake kit. Connect as shown in Figure 12.

- Best accuracy is achieved with the middle stake at 62 % of the distance to the far stake. The stakes should be in a straight line and wires separated to avoid mutual coupling.
- Disconnect the earth electrode under test from the electrical system as you do the test. Do not measure Earth resistance on a live system.

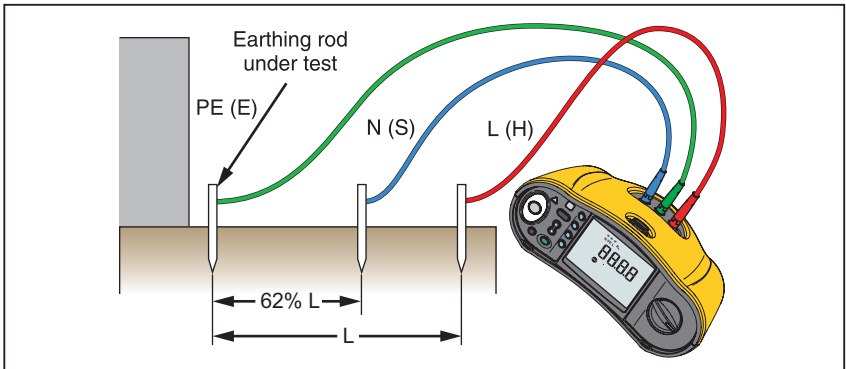



hw1014.eps



**Figure 12. Earth Resistance Test Connection**

**To measure earth resistance:**

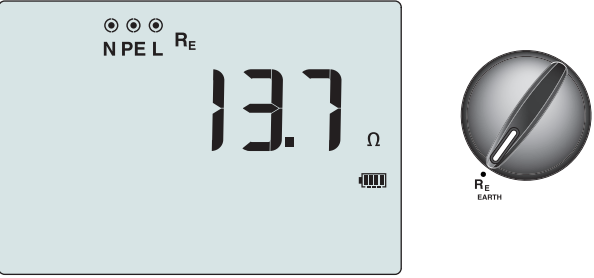
1. Turn the rotary dial to the  $R_E$  position. See Table 18.

**Table 18. Earth Resistance Display/Dial and Terminal Settings**

				
hw1010.eps				
Push Button	Action	1664 FC	1663	1662
	Start the selected test	•	•	

2. Press and release . Wait for the test to complete.
  - The primary display shows the earth resistance reading.
  - Voltage detected between the test rods shows in the secondary display. If >10 V, the test is inhibited.
  - If the measurement is too noisy, **Err 5** shows on the display. (The measured value accuracy is degraded by the noise). Press  to show the measurement. Press  to return to the **Err 5** display.
  - If the probe resistance is too high, **Err 6** shows. Probe resistance may be reduced if you push the test stakes further into the earth or apply water to the earth around the test stakes.



## **Applications**

This section outlines a few practical setups to make tests faster and more efficient.



### **How to Test a Mains Socket and Ring Installation**

The mains socket test checks that the mains voltage is present, the frequency is 50 Hz/60 Hz, and the wiring of the mains socket is correct.

For a valid socket test:

- connect all test leads (phase, neutral, and protective earth) to the mains socket
- the mains line cord provides a quick connection to the socket
- always contact the touch pad around the test button

When a high voltage is measured between two wires, ⚡ shows on the display:

- If the PE wire is live and you contact the touch pad, the  above the touch pad is lit, the PE annunciator in the display is lit, and the beeper sounds.
- If the L and N terminals are reversed, the Tester shows an arrow above the terminal indicator symbol. The Tester automatically reverses these internally and allows the test. When configured for UK operation, the Tester inhibits the test.
- If the L and PE terminals are reversed, the Tester shows an arrow below the terminal indicator symbol and inhibits the test.
- If the N, PE, or installation wire is open or broken, the Tester shows the terminal as a crossed circle. The test can start if the wire is not required for this test.
- If the trip time meets the appropriate standard of the RCD, the **RCD**  indicator shows. For more information, see the *RCD Tripping Time* table in the *Specifications* section of this manual.

## Earth Resistance Test by Loop Method

You can also use the Tester to measure the earth resistance component of the total loop resistance. Check your local regulations to determine if this method is acceptable in your area. You can use three leads or the mains test cord to do this test. Use the connection shown in Figure 13 when you make a 3-wire connection for earth resistance loop test. Zero the test leads before the test (see page 22).

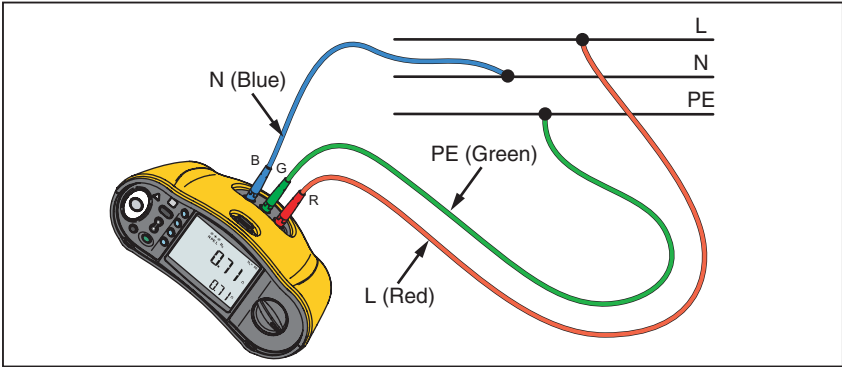

hw024.eps

**Figure 13. 3-Wire Connection for Earth Resistance Loop Test (No Trip Mode)**

If necessary to meet local regulations, you can measure the earth resistance with the high-current trip mode. To measure loop impedance with the high-current trip mode, see page 37. Any RCD will trip during this test. The test result will include the resistance of the phase wire and this might be neglected for higher RE resistances. Use the connection shown in Figure 14 when you make a 2-wire connection for earth resistance loop test.

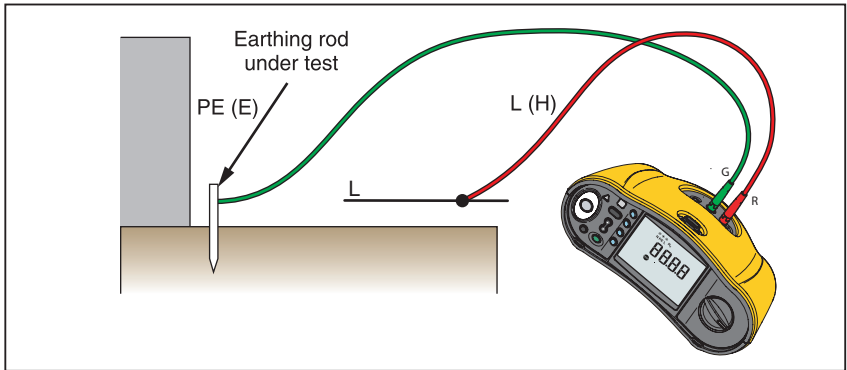

Figure 14. 2-Wire Connection for Earth Resistance Loop Test (High-Current Trip Mode)

## Zmax

Zmax compares multiple line/loop impedances and retains the maximum impedance. Sockets on a circuit can be tested consecutively and the maximum impedance value retained and stored to memory.

There are two types of Zmax values: Zmax (L-PE) and Z<sub>L</sub> Zmax (L-N). The input selection determines which Zmax value is in use:

- Z<sub>L</sub> No Trip
  - L-N: Z<sub>L</sub> Zmax is in use
  - L-PE: both Z<sub>L</sub> Zmax and Zmax are in use
- Z<sub>L</sub> Hi Current
  - L-N: Z<sub>L</sub> Zmax is in use
  - L-PE: Zmax is in use

The Zmax values are retained when you switch between Z<sub>L</sub> No Trip and Z<sub>L</sub> Hi Current. Zmax values are saved with the test result to memory. If you change the location fields a, b, or c before you save, the actual test result is the new Zmax.

## **Auto Start**

Auto Start enables faster testing and is a power-up option. When the Tester detects mains voltage in the loop/line or RCD tests, the test starts automatically without pushing .

## **Loop Impedance Test with 10 mA RCD**

For a Loop impedance measurement in a 10 mA RCD circuit, the tripping time RCD test is recommended. Use a nominal test current of 10 mA and the factor  $\times \frac{1}{2}$  for this test.

If the fault voltage is  $<25$  V or 50 V, dependent on the local requirement, the loop is good. To calculate the loop impedance, divide the fault voltage by 10 mA (Loop impedance = fault voltage  $\times$  100).

## **Auto Test Sequence (1664 FC)**

The 1664 FC includes the Auto Test feature. Auto Test allows you to start multiple tests with one press of :

- Line test (L-N)
- NoTrip Loop test (L-PE)
- RCD test:
  - Ramp test (type A or type AC, 30 mA, 100 mA, 300 mA)
  - or-
  - Auto RCD test (type A or type AC, 30 mA, 100 mA)
- Insulation tests:
  - L-PE, 50 V to 1000 V
  - L-N, 50 V to 1000 V
  - N-PE, 50 V to 1000 V

The Tester starts with the Line/Loop test, then it tests the RCD. After the RCD has tripped, it proceeds with insulation tests. The insulation Safety Pretest and the Zmax are always active.

This test sequence is intended to be done at a mains socket with the mains test cord at circuits that are protected by an RCD with a nominal fault current of  $\geq 30$  mA.

### *Note*

*The automatic test sequence will trip an RCD. Because an insulation test is part of the sequence, make sure that no appliances are connected to the circuit under test.*



*If the L and N terminals are reversed, the Tester will auto-swap them internally and continue the tests. If the Tester is configured in L-n mode (no auto lead swap), tests are stopped. This condition is indicated by arrows above the terminal indicator symbol (.*

To start an Auto Test:

1. Turn the rotary dial to the AUTO TEST position. See Table 19.
2. Connect the mains test cord to the Tester.

3. Before you do a loop impedance test, zero the test leads with (F2). More information about how to zero the test leads is on page 22.
4. Plug the mains test cord into the socket under test.
5. Press (F3) to select the RCD type and test type.
6. Select the nominal RCD fault current with (F4).

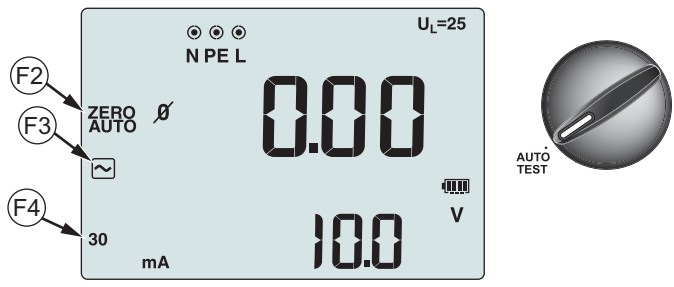
**Table 19. Auto Test Settings**



				
<small>hw1057.eps</small>				
Push Button	Action	1664 FC	1663	1662
(F2)	Zero the test lead resistance offset	●		
(F3)	AUTO setting: AC (Ramp), A (Ramp), AC Auto, or A Auto	●		
(F4)	RCD current setting: 30 mA, 100 mA, or 300 mA* *300 mA available for ramp test only	●		
	Select the appropriate insulation test voltage: 50 V, 100 V, 250 V, 500 V, and 1000 V	●		
(TEST)	Start the Auto Test sequence	●		

7. Use  to select the insulation test voltage.
8. Press and release (TEST).

The primary display shows the Loop impedance  $Z_L$  or the Line impedance  $Z_L$ . The secondary display shows the PEFC or the PFC ( $I_k$ ). The RCD will trip and the Tester shows the trip current, and then the trip time. The insulation tests start and you see the results when each test is done. The beeper sounds with each completed test.

*Note*

*You cannot override the Safety Pretest warning because the insulation Safety Pretest is active. If the insulation Safety Pretest detects a connected appliance, the test sequence stops.*



9. When the test is done, reset the RCD.
10. Use  to review test results. The first result shown is the last measurement taken, the insulation N-PE test. Press the down arrow  to move backward to the first test, the Line test.

Test results are in temporary memory. If you want to store the test results, press . For more information, see *Memory Mode*.

## **Memory Mode**

You can store up to 3000 measurements on the Tester. The information stored for each measurement consists of the test function and all user selectable test conditions.

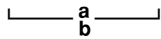
The location identifier includes a location set number (a), location subset number (b), and location ID number (c). You can store multiple measurements to the same memory location (a, b, c) and view later with the Tester or a software program such as Fluke DMS Software. With DMS you have additional tools to apply custom labels to these memory locations. See the *DMS Software User Manual* for more information.

- |  |  |
|--|--|
|   | Use the location set field (a) to indicate a location such as a room or electrical panel number. |
|  | Use the location subset field (b) for circuit number.  |
|  | Use the location ID field (c) for a socket or place number.                                      |

To enter Memory mode:

1. Press  to enter Memory mode. See Figure 15.

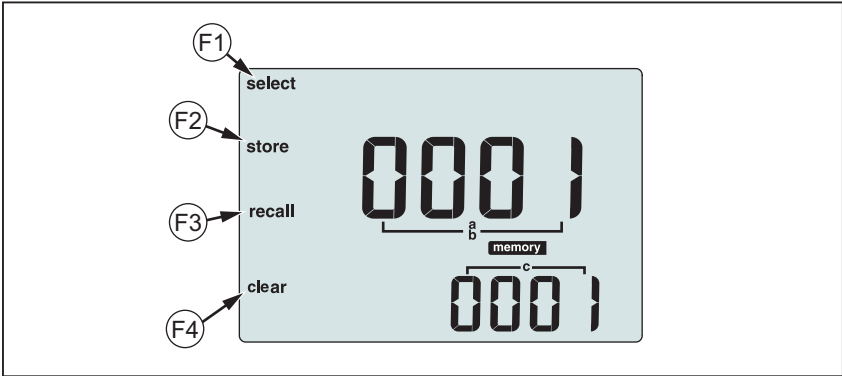

hw1056.eps

Figure 15. Memory Mode

The display changes to a memory mode display. In Memory mode, the **memory** icon appears on the display. When you go to Memory mode the first time, the primary numeric display shows the location set number (a) and a digit that blinks. The location set number is changed one digit at a time. Use  $\uparrow$  to change the digit that blinks. Press (F1) to activate the next digit.

2. To change the location subset number, press (F1) until the location subset number (b) shows on the display. Each digit can be individually changed with  $\uparrow$ . The location subset number starts to blink. To enable the location subset number to be changed, press  $\uparrow$ . The location set number starts to blink. Press (F1) several times to change the location ID number.
3. Press the down arrow button ( $\downarrow$ ) to decrement the number or press the up arrow button ( $\uparrow$ ) to increment the number. To accelerate the increment or decrement function, press and hold the up or down  $\uparrow$ .

*Note*

*To store test results, the number can be set to any value. To recall stored test results, the number can be set to used values only.*



## Store a Measurement

To store a measurement:



1. Press **MEMORY** to enter Memory mode.
2. Press **F1** and use the arrow button () to set the location identity.
3. Press **F2** to save the test results.
  - The test results are saved, the Tester will automatically exit Memory mode and the display will revert back to the previous test mode.
  - If memory is full, FULL will appear on the primary display. Press **MEMORY** to exit Memory mode.

### Note

**ERR9** in the primary display indicates a data problem. See Table 9 for more information.

## Recall a Measurement

To recall a measurement:

1. Press **MEMORY** to enter the Memory mode.
2. Press **F3** to enter the Recall mode.
3. Use **F1** and  to set the location identity. Only memory locations with stored measurements will show on the display. All fields show as dashes if no test result is stored.
4. Press **F3** to recall the test result. The Tester display will revert to the Test mode used for the recalled test results. Also, the **memory** and **recall** icons remain on the display to indicate that the Tester is in Memory Recall mode.
5. Press  to step through multiple tests that are saved at the selected location identifier. Only the main result for each test is shown, for example  $Z_L$  for loop test, but no  $Z_{max}$ .
6. When multiple results are saved as part of a single test, press **F1** to step through the results of that test.
7. Press **F4** to clear the test result. The primary display shows **Clr?**. Press **F4** again to clear the recalled location.
8. Press **F3** to toggle between the location ID screen and the recalled test result screen to check the recalled location ID or to select more test results to recall.
9. Press **MEMORY** to exit Memory mode at any time.

## Clear Memory

To clear all memory:

1. Press **MEMORY** to enter Memory mode.
2. Press **F4**. The primary display shows **Clr**. The secondary display shows **LAST**.
3. Press **F3** to enable clear all memory. The display shows **Clr All?**
4. Press **F4** to confirm clear all memory. All memory is cleared and the Tester returns to the measurement mode.

To delete (clear) the last valid stored result:

1. Press **MEMORY** to enter Memory mode.
2. Press **F4**. The primary display shows **Clr**. The secondary display shows **LAST**.
3. Press **F4** to delete the last valid stored result. The Tester returns to the measurement mode.

## Memory Error Message

To ensure data security, each data record has a CRC checksum. If the checksum is wrong, **ERR9** (inconsistent data) shows on the display at startup or when you go to the Memory mode.

To continue:

- Download all data from the Tester memory.
- Clear the Tester memory (may take up to 2 minutes).
- If **ERR9** occurs again, return the Tester to a Fluke Service Center.

## Download Test Results

To download test results:

1. Connect the IR serial cable to the serial port on the PC and the IR port on the Tester. See Figure 16.

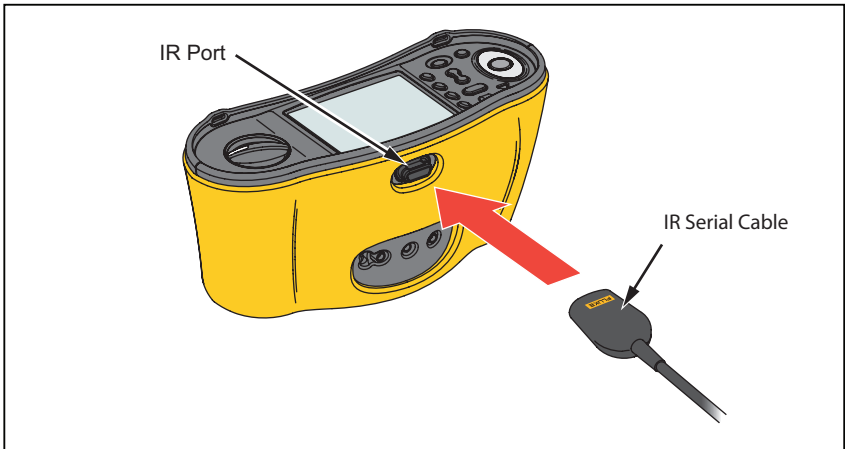

hw1031.eps

**Figure 16. IR Serial Cable Attachment**

2. Start the Fluke PC software program.
3. Press **Ⓞ** to turn on the Tester.
4. Refer to the software documentation for complete instructions on how to set the date/time stamp and upload data from the Tester.

### *Note*

*The 1664 FC allows you to upload data wirelessly to a smartphone with the Fluke Connect™ app, share data with others, and e-mail the data to your office. See Fluke Connect Wireless System for more information.*





## **Fluke Connect Wireless System**

The 1664 FC supports the Fluke Connect™ Wireless System (may not be available in all regions). Fluke Connect™ is a system that wirelessly connects your Fluke test tools with an app on your smartphone. It enables you to see test results from your Tester on your smartphone screen and share these results with your team.

You can also download the saved test results to a smartphone and send the data package by email.

The Fluke Connect app works with the iPhone and Android Phone. The app is available for download from the Apple App Store and Google Play.

How to access Fluke Connect:

1. Push  on the Tester. The display shows .
2. On your smartphone, enable Bluetooth.
3. Go to the Fluke Connect app and select 1664 FC from the list.
4. You will see the Tester's screen on your smartphone. When the Tester is connected to the app,  will blink every 5 seconds.
5. To turn off the wireless system on your Tester, press  for >1 second.  disappears.

Go to [www.flukeconnect.com](http://www.flukeconnect.com) for more information about how to use the app.

## **Maintenance**

### **⚠⚠ Warnings**

To prevent possible electrical shock, fire, or personal injury:

- **Be sure that the battery polarity is correct to prevent battery leakage.**
- **Repair the Product before use if the battery leaks.**
- **Have an approved technician repair the Product.**
- **Use only specified replacement parts.**
- **Replace a blown fuse with exact replacement only for continued protection against arc flash.**
- **Do not operate the Product with covers removed or the case open. Hazardous voltage exposure is possible.**
- **Remove the input signals before you clean the Product.**

Periodically wipe the case with a damp cloth and mild detergent. Do not use abrasives or solvents.

Dirt or moisture in the terminals can affect readings.

To clean the terminals:

1. Turn the meter off and remove all test leads.
2. Shake out any dirt that may be in the terminals.
3. Moisten a clean cotton swab with alcohol and clean the inside of each terminal.

Table 20 is a list of replaceable parts for the Tester.

**Table 20. Replacement Parts**

Description	Part Number
⚠ Fuse, 11 A, 1000 V 10.3 x 25.4 mm for Fused Probe	803293
⚠ Fuse, 3.15 A, 500 V 6.35 x 32 mm for 166X Tester	2030852

## How to Test the Fuse

To manually check the fuse:

1. Turn the rotary dial to the **R<sub>LO</sub>** dial setting.
2. Select the input as L-PE.
3. Short the L-PE leads.
4. Press and hold .
5. If the fuse is bad, FUSE will appear on the display to indicate the Tester is damaged and needs repair. Contact Fluke Service for repair (see *How to Contact Fluke*).

## How to Test the Battery

Battery voltage is continuously monitored by the Tester and shows the current capacity in 25 % increments. If the voltage falls below 6.0 V (1.0 V/cell), the battery icon shows 0 % to indicate minimal battery life is available.

To test:

1. Turn the rotary dial to **V**.
2. Press and hold .

The battery voltage shows in the secondary display.

### **Warning**

**To prevent possible electric shock or personal injury due to false readings:**

- **Replace the batteries as soon as the  empty battery icon appears.**
- **Be sure that the battery polarity is correct. A reversed battery can cause leakage.**

## Battery Replacement

Replace the batteries with six AA batteries. Alkaline batteries are supplied with the Tester. You can also use 1.2 V NiMH batteries. Due to the nature of these NiMH batteries, the battery symbol on the Tester display may indicate a lower power level even when batteries are fully charged.

**⚠⚠ Warning**

**To prevent possible electrical shock, fire, or personal injury:**

- **Remove the test leads and any input signals before you replace the battery.**
- **Install ONLY specified replacement fuses with the amperage, voltage, and speed ratings shown in the Specifications section of this manual.**

**To replace the batteries** (see Figure 17):

1. Press  to turn off the Tester.
2. Remove the test leads from the terminals.
3. To remove the battery door, use a standard-blade screwdriver to turn the battery door screws (3) one-quarter turn counterclockwise.
4. Press the release latch and slide the battery holder out of the Tester.
5. Replace the batteries.
6. Replace the battery holder and the battery door.
7. Turn the battery door screws one-quarter turn clockwise to fasten the door.

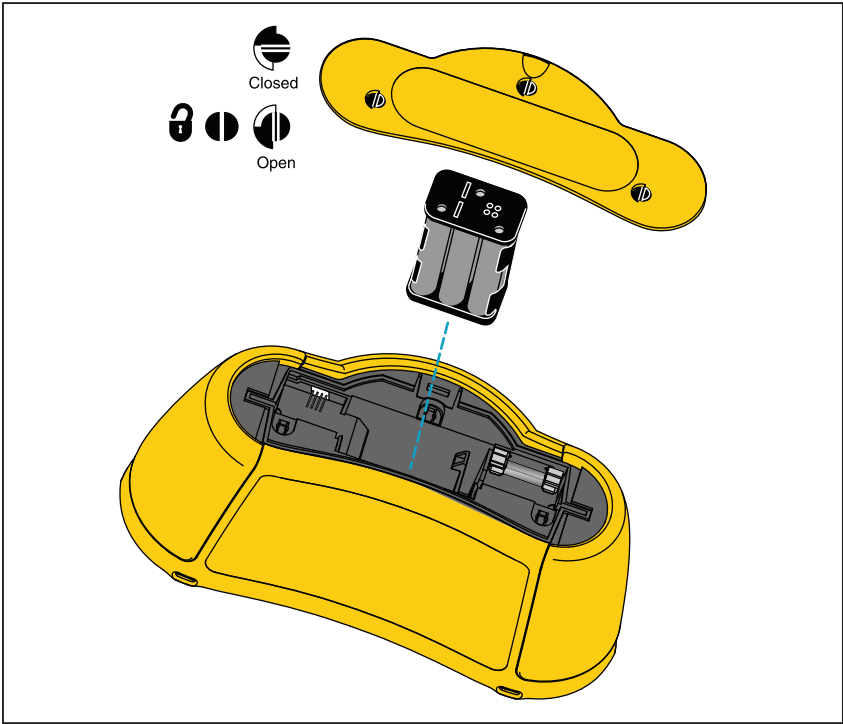

hw1028.eps

Figure 17. Battery Replacement



## **Specifications**

### **General Specifications**

Size .....	10.0 cm (L) x 25.0 cm (W) x 12.5 cm (H)
Weight (with batteries) .....	1.3 kg
Battery .....	6 x AA Alkaline IEC LR6 Usable with 1.2 V NiMH batteries (not included)
Battery life (typical) .....	200 hours idling
Fuse .....	T3.15 A, 500 V, IR: 1500 A
Operating Temperature .....	-10 °C to +40 °C
Storage Temperature .....	-10 °C to +60 °C (limited by battery specification) -40 °C for 100 hr
Relative Humidity .....	80 % 10 °C to 35 °C 70 % 35 °C to 40 °C
Altitude	
Operating .....	2 000 m
Storage .....	12 000 m
Vibration .....	MIL-PRF-28800F: Class 2
Ingress Protection .....	IEC 60529: IP 40
Safety	
IEC 61010-1 .....	Pollution Degree 2
IEC 61010-2-030 .....	300 V CAT IV, 500 V CAT III
Maximum voltage between any terminal and earth ground .....	500 V
IEC 61010-031 (Accessories)	
TP165X Remote Probe with cap .....	CAT IV 600 V, CAT III 1000 V, 10 A
TP165X Remote Probe without cap .....	CAT II 1000 V, 10 A
TL-L1, TL-L2, TL-L3 Test Leads .....	CAT IV 600 V, CAT III 1000 V, 10 A
Test Probes with cap .....	CAT IV 600 V, CAT III 1000 V, 10 A
Test Probes without cap .....	CAT II 1000 V, 10 A
AC285 Alligator Clip .....	CAT IV 600 V, CAT III 1000 V, 10 A
Country-Specific Mains Cord .....	CAT II 250 V, 1000 V dc

Electromagnetic Compatibility (EMC)

International.....IEC 61326-1: Portable

CISPR 11: Group 1, Class A

*Group 1: Equipment has intentionally generated and/or uses conductively-coupled radio frequency energy that is necessary for the internal function of the equipment itself.*

*Class A: Equipment is suitable for use in all establishments other than domestic and those directly connected to a low-voltage power supply network that supplies buildings used for domestic purposes. There may be potential difficulties in ensuring electromagnetic compatibility in other environments due to conducted and radiated disturbances.*

Wireless Radio with Adapter

Frequency Range.....2402 MHz to 2480 MHz

Output Power .....<10 mW

Performance.....EN61557-1, EN61557-2, EN61557-3,  
EN61557-4, EN61557-5, EN61557-6,  
EN61557-7, EN61557-10

## Maximum Display Values

The following tables can be used for the determination of maximum or minimum display values considering maximum instrument operating uncertainty per EN61557-1, 5.2.4.

### Insulation Resistance ( $R_{ISO}$ )

50 V		100 V		250 V		500 V		1000 V	
Limit Value	Maximum Display Value	Limit Value	Maximum Display Value	Limit Value	Maximum Display Value	Limit Value	Maximum Display Value	Limit Value	Maximum Display Value
1	1.12	1	1.12	1	1.3	1	1.3	1	1.3
2	2.22	2	2.22	2	2.4	2	2.4	2	2.4
3	3.32	3	3.32	3	3.5	3	3.5	3	3.5
4	4.42	4	4.42	4	4.6	4	4.6	4	4.6
5	5.52	5	5.52	5	5.7	5	5.7	5	5.7
6	6.62	6	6.62	6	6.8	6	6.8	6	6.8
7	7.72	7	7.72	7	7.9	7	7.9	7	7.9
8	8.82	8	8.82	8	9.0	8	9.0	8	9.0
9	9.92	9	9.92	9	10.1	9	10.1	9	10.1
10	11.02	10	11.02	10	11.2	10	11.2	10	11.2
20	22.02	20	22.02	20	22.2	20	22.2	20	22.2
30	33.02	30	33.2	30	33.2	30	33.2	30	33.2
40	44.02	40	44.2	40	44.2	40	44.2	40	44.2
50	55.02	50	55.2	50	55.2	50	55.2	50	55.2
-	-	60	66.2	60	66.2	60	66.2	60	66.2
-	-	70	77.2	70	77.2	70	77.2	70	77.2
-	-	80	88.2	80	88.2	80	88.2	80	88.2
-	-	90	99.2	90	99.2	90	99.2	90	99.2
-	-	100	110.2	100	110.2	100	110.2	100	110.2
-	-	-	-	200	220.2	200	220.2	200	220.2
-	-	-	-	-	-	300	347	300	345
-	-	-	-	-	-	400	462	400	460
-	-	-	-	-	-	500	577	500	575
-	-	-	-	-	-	-	-	600	690
-	-	-	-	-	-	-	-	700	805
-	-	-	-	-	-	-	-	800	920
-	-	-	-	-	-	-	-	900	1035
-	-	-	-	-	-	-	-	1000	1150

## Continuity (R<sub>Lo</sub>)

Limit Value	Maximum Display Value	Limit Value	Maximum Display Value
0.2	0.16	3	2.68
0.3	0.25	4	3.58
0.4	0.34	5	4.48
0.5	0.43	6	5.38
0.6	0.52	7	6.28
0.7	0.61	8	7.18
0.8	0.7	9	8.08
0.9	0.79	10	8.98
1	0.88	20	17.98
2	1.78	30	26.8

## Loop Tests ( $Z_l$ )

Loop $Z_l$ Hi Current		Loop $Z_l$ No Trip		Loop $Z_l$		Loop $R_E$	
Limit Value	Maximum Display Value	Limit Value	Maximum Display Value	Limit Value	Maximum Display Value	Limit Value	Maximum Display Value
0.20	0.14	-	-	3	2.53	3	2.72
0.30	0.23	-	-	4	3.38	4	3.62
0.40	0.32	0.40	0.28	5	4.23	5	4.52
0.50	0.41	0.50	0.37	6	5.08	6	5.42
0.60	0.50	0.60	0.45	7	5.93	7	6.32
0.70	0.59	0.70	0.54	8	6.78	8	7.22
0.80	0.68	0.80	0.62	9	7.63	9	8.12
0.90	0.77	0.90	0.71	10	8.48	10	9.02
1.00	0.86	1.00	0.79	20	16.98	20	18.02
1.10	0.95	1.10	0.88	30	25.3	30	27.2
1.20	1.04	1.20	0.96	40	33.8	40	36.2
1.30	1.13	1.30	1.05	50	42.3	50	45.2
1.40	1.22	1.40	1.13	60	50.8	60	54.2
1.50	1.31	1.50	1.22	70	59.3	70	63.2
1.60	1.40	1.60	1.30	80	67.8	80	72.2
1.70	1.49	1.70	1.39	90	76.3	90	81.2
1.80	1.58	1.80	1.47	100	84.8	100	90.2
1.90	1.67	1.90	1.56	200	169.8	200	180.2
2.00	1.76	2.00	1.64	300	253	300	272
-	-	-	-	400	338	400	362
-	-	-	-	500	423	500	452
-	-	-	-	600	508	600	542
-	-	-	-	700	593	700	632
-	-	-	-	800	678	800	722
-	-	-	-	900	763	900	812
-	-	-	-	1000	848	1000	902

**RCD/FI Tests ( $\Delta T$ ,  $I_{\Delta N}$ )**

RCD/FI Time		RCD/FI Current	
Limit Value	Maximum Display Value	Limit Value	Maximum Display Value
20	18.1	0.5	0.43
30	27.1	0.6	0.52
40	36.1	0.7	0.61
50	45.1	0.8	0.7
60	54.1	0.9	0.79
70	63.1	1	0.88
80	72.1	2	1.78
90	81.1	3	2.68
100	90.1	4	3.58
200	180.1	5	4.48
300	271	6	5.38
400	361	7	6.28
500	451	8	7.18
600	541	9	8.08
700	631	10	8.98
800	721	20	17.98
900	811	30	26.8
1000	901	40	35.8
2000	1801	50	44.8
-	-	60	53.8
-	-	70	62.8
-	-	80	71.8
-	-	90	80.8
-	-	100	89.8
-	-	200	179.8
-	-	300	268
-	-	400	358
-	-	500	448

## Earth Tests ( $R_E$ )

<b>Limit Value</b>	<b>Maximum Display Value</b>	<b>Limit Value</b>	<b>Maximum Display Value</b>
10	8.8	200	179.8
20	17.8	300	268.0
30	26.8	400	358.0
40	35.8	500	448.0
50	44.8	600	538.0
60	53.8	700	628.0
70	62.8	800	718.0
80	71.8	900	808.0
90	80.8	1000	898.0
100	89.8	2000	1798.0

## Electrical Measurement Specifications

The accuracy specification is defined as  $\pm(\% \text{ reading} + \text{digit counts})$  at 23 °C  $\pm 5$  °C,  $\leq 80$  % RH. Between -10 °C and 18 °C and between 28 °C and 40 °C, accuracy specifications may degrade by 0.1 x (accuracy specification) per °C. The calibration cycle is 1 year.

### AC Voltage Measurement (V)

Range	Resolution	Accuracy 45 Hz – 66 Hz	Input Impedance	Overload Protection
500 V	0.1 V	0.8 % + 3	320 k $\Omega$	550 V rms

### Insulation Resistance Measurement ( $R_{ISO}$ )

Test Voltages		Accuracy of Test Voltage (at rated test current)
Model 1662	Model 1663 Model 1664	
100-250-500-1000 V	50-100-250-500-1000 V	+10 %, -0 %

Test Voltage	Insulation Resistance Range	Resolution	Test Current	Accuracy
50 V	10 k $\Omega$ to 50 M $\Omega$	0.01 M $\Omega$	1 mA @ 50 k $\Omega$	$\pm(3 \% + 3 \text{ digits})$
100 V	100 k $\Omega$ to 20 M $\Omega$	0.01 M $\Omega$	1 mA @ 100 k $\Omega$	$\pm(3 \% + 3 \text{ digits})$
	20 M $\Omega$ to 100 M $\Omega$	0.1 M $\Omega$		$\pm(3 \% + 3 \text{ digits})$
250 V	10 k $\Omega$ to 20 M $\Omega$	0.01 M $\Omega$	1 mA @ 250 k $\Omega$	$\pm(1.5 \% + 3 \text{ digits})$
	20 M $\Omega$ to 200 M $\Omega$	0.1 M $\Omega$		$\pm(1.5 \% + 3 \text{ digits})$
500 V	10 k $\Omega$ to 20 M $\Omega$	0.01 M $\Omega$	1 mA @ 500 k $\Omega$	$\pm(1.5 \% + 3 \text{ digits})$
	20 M $\Omega$ to 200 M $\Omega$	0.1 M $\Omega$		$\pm(1.5 \% + 3 \text{ digits})$
	200 M $\Omega$ to 500 M $\Omega$	1 M $\Omega$		$\pm 10 \%$
1000 V	100 k $\Omega$ to 200 M $\Omega$	0.1 M $\Omega$	1 mA @ 1 M $\Omega$	$\pm(1.5 \% + 3 \text{ digits})$
	200 M $\Omega$ to 1000 M $\Omega$	1 M $\Omega$		$\pm 10 \%$

Note: The number of insulation tests with a new set of batteries is >2000.



<b>Auto Discharge</b>	Discharge time constant <0.5 second for C = 1 $\mu$ F or less.
<b>Live Circuit Detection</b>	Inhibits test if terminal voltage >30 V prior to initiation of test.
<b>Maximum Capacitive Load</b>	Operable with up the 5 $\mu$ F load.

<b>Insulation Safety Pretest</b>	Connections from the Tester to L, N, and PE are required.
----------------------------------	---

## Continuity Testing ( $R_{LO}$ )

Range (Autoranging)	Resolution	Open Circuit Voltage	Accuracy
20 $\Omega$	0.01 $\Omega$	>4 V	$\pm(1.5 \% + 3 \text{ digits})^{[1]}$
200 $\Omega$	0.1 $\Omega$	>4 V	$\pm(1.5 \% + 3 \text{ digits})$
2000 $\Omega$	1 $\Omega$	>4 V	$\pm(1.5 \% + 3 \text{ digits})$

[1] For 10 mA, add 3 digits.  
Note: The number of 250 mA @ 1  $\Omega$  continuity tests with a set of new batteries is >1500.

Range Setting	Display Range	Test Current <sup>[1]</sup>
250 mA	0.2 $\Omega$ to 2.0 $\Omega$	250 mA
	2 $\Omega$ to 160 $\Omega$	250 mA to 50 mA
	160 $\Omega$ to 800 $\Omega$	10 mA
	800 $\Omega$ to 2000 $\Omega$	2 mA
10 mA	0 $\Omega$ to 800 $\Omega$	10 mA
	800 $\Omega$ to 2000 $\Omega$	2 mA

[1] All test currents  $\pm 10\%$ .

<b>Test Probe Zeroing</b>	Press <b>ZERO</b> to zero the test probe. Can subtract up to 3 $\Omega$ of lead resistance. Error message for >3 $\Omega$ .
<b>Live Circuit Detection</b>	Inhibits test if terminal voltage >10 V ac detected prior to initiation of test.

## Mains Wiring Indicator

Icons (🔌, 🔌, 🔌, 🔌) indicate if L-PE or L-N terminals are reversed. Loop and RCD tests are inhibited and an error code is generated if the input voltage is not between 100 V and 500 V. The UK Loop and RCD tests are inhibited if the L-PE or the L-N terminals are reversed.

## Loop and Line Impedance ( $Z_I$ No Trip and Hi Current)

<b>Mains Input Voltage Range</b>	100 - 500 V ac (45/66 Hz)
<b>Input Connection (soft key selection)</b>	Loop Impedance: phase to earth
	Line impedance: phase to neutral
<b>Limit on Consecutive Tests</b>	Automatic shutdown when the temperature of internal components is too hot.
<b>Maximum Test Current @ 400 V</b>	20 A sinusoidal for 10 ms
<b>Maximum Test Current @ 230 V</b>	12 A sinusoidal for 10 ms

Range	Resolution	Accuracy <sup>[1]</sup>
10 $\Omega$ <sup>[3]</sup>	0.001 $\Omega$	Hi Current m $\Omega$ mode: $\pm(2\% + 15 \text{ digits})$
20 $\Omega$	0.01 $\Omega$	No Trip mode: $\pm(3\% + 6 \text{ digits})$
		Hi Current mode: $\pm(2\% + 4 \text{ digits})$
200 $\Omega$	0.1 $\Omega$	No Trip mode: $\pm(3\%)$
		Hi Current mode: $\pm(2\%)$
2000 $\Omega$	1 $\Omega$	$\pm 6\%$ <sup>[2]</sup>
Notes		
[1] Valid for resistance of neutral circuit <20 $\Omega$ and up to a system phase angle of 30 °. Test leads must be zeroed before testing.		
[2] Valid for mains voltage >200 V.		
[3] 1664 FC only.		

## Prospective Earth Fault Current (PEFC) Prospective Short Circuit Current (PSC)

<b>Computation</b>	Prospective Earth Fault Current (PEFC/ $I_k$ ) or Prospective Short Circuit Current (PSC/ $I_k$ ) determined by dividing measured mains voltage by measured loop (L-PE) resistance or line (L-N) resistance, respectively.	
<b>Range</b>	0 kA to 50 kA	
<b>Resolution and Units</b>	Resolution	Units
	$I_k < 1000$ A	1 A
	$I_k > 1000$ A	0.1 kA
<b>Accuracy</b>	Determined by accuracy of loop resistance and mains voltage measurements.	

## RCD Testing

### RCD Types Tested

Limit on consecutive tests: Automatic shutdown for RCD tests when the temperature of internal components is too hot.

RCD Type <sup>[6]</sup>		Model 1662	Model 1663	Model 1664
AC <sup>[1]</sup>	G <sup>[2]</sup>	●	●	●
AC	S <sup>[3]</sup>	●	●	●
A <sup>[4]</sup>	G	●	●	●
A	S	●	●	●
B <sup>[5]</sup>	G		●	●
B	S		●	●

[1] AC – Responds to ac  
 [2] G – General, no delay  
 [3] S – Time delay  
 [4] A – Responds to pulsed signal  
 [5] B – Responds to smooth dc  
 [6] RCD test inhibited for V >265 ac  
 RCD tests permitted only if the selected current, multiplied by earthing resistance, is <50 V.

### Test Signals

RCD Type	Test Signal Description
AC (sinusoidal)	The waveform is a sinewave starting at zero crossing, polarity determined by phase selection (0 ° phase starts with low to high zero crossing, 180 ° phase starts with high to low zero crossing). The magnitude of the test current is $I_{\Delta n} \times \text{Multiplier}$ for all tests.
A (half wave)	The waveform is a half wave rectified sinewave starting at zero, polarity determined by phase selection (0 ° phase starts with low to high zero crossing, 180 ° phase starts with high to low zero crossing). The magnitude of the test current is $2.0 \times I_{\Delta n} \text{ (rms)} \times \text{Multiplier}$ for all tests for $I_{\Delta n} = 0.01\text{A}$ . The magnitude of the test current is $1.4 \times I_{\Delta n} \text{ (rms)} \times \text{Multiplier}$ for all tests for all other $I_{\Delta n}$ ratings.
B (DC)	This is a smooth dc current according to EN61557-6 Annex A

## RCD Tripping Indicator

The RCD ✓ symbol switches on as a “good test” indicator when testing the RCD trip time or RCD trip current if the trip time meets the following conditions:

RCD Type	$I_{\Delta N}$	Trip Time Limits
G	x 1	Less than 300 ms
S	x 1	Between 130 ms and 500 ms
G	x 5	Less than 40 ms
S	x 5	Between 50 ms and 150 ms

## RCD Tripping Time ( $\Delta T$ )

Test Function	RCD Current Selection						
	10 mA	30 mA	100 mA <sup>[1]</sup>	300 mA <sup>[1]</sup>	500 mA <sup>[1]</sup>	1000 mA <sup>[2]</sup>	Var <sup>[3]</sup>
x ½, 1	●	●	●	●	●	●	●
x 5	●	●	●				
Ramp	●	●	●	●	●	●	●
Auto	●	●	●				

Mains voltage 100 V – 265 V ac, 45/66 Hz  
 [1] Type B RCDs require mains voltage range of 195 V – 265 V.  
 [2] Type AC RCDs only.  
 [3] Type A RCDs are limited to 700 mA, not available for Type B RCDs.

Current Multiplier	RCD Type <sup>[1]</sup>	Measurement Range		Trip Time Accuracy
		Europe	UK	
x ½	G	310 ms	2000 ms	±(1 % Reading + 1 ms)
x ½	S	510 ms	2000 ms	±(1 % Reading + 1 ms)
x 1	G	310 ms	310 ms	±(1 % Reading + 1 ms)
x 1	S	510 ms	510 ms	±(1 % Reading + 1 ms)
x 5	G	50 ms	50 ms	±(1 % Reading + 1 ms)
x 5	S	160 ms	160 ms	±(1 % Reading + 1 ms)

[1] G – General, no delay / S – Time delay

## RCD Tripping Current ( $I_{\Delta N}$ ) Measurement/Ramp Test

Current Range	Step Size	Dwell Time		Measurement Accuracy
		Type G	Type S	
30 % to 110 % of RCD rated current <sup>[1]</sup>	10 % of $I_{\Delta N}$ <sup>[2]</sup>	300 ms/step	500 ms/step	±5 %
<p>[1] 30 % to 150 % for Type A <math>I_{\Delta N} &gt; 10</math> mA            30 % to 210 % for Type A <math>I_{\Delta N} = 10</math> mA            20 % to 210 % for Type B  <b>Specified trip current ranges (EN 61008-1):</b>            50 % to 100 % for Type AC            35 % to 140 % for Type A (&gt;10 mA)            35 % to 200 % for Type A (≤10 mA)            50 % to 200 % for Type B</p> <p>[2] 5 % for Type B</p>				

## Phase Sequence Test

<b>Icon</b>	 icon. Phase Sequence indicator is active.
<b>Display of Phase Sequence</b>	Displays "1-2-3" in digital display field for correct sequence. Displays "3-2-1" for incorrect phase. Dashes in place of a number indicate a valid determination could not be made.
<b>Mains Input Voltage Range (phase-to-phase)</b>	185 V to 500 V

## Earth Resistance Test ( $R_E$ )

Models 1663 and 1664 only.

Range	Resolution	Accuracy
200 $\Omega$	0.1 $\Omega$	$\pm(2\% + 5 \text{ digits})$
2000 $\Omega$	1 $\Omega$	$\pm(3.5\% + 10 \text{ digits})$

Range: $R_E + R_{\text{PROBE}}$ <sup>[1]</sup>	Test Current
2200 $\Omega$	3.5 mA
16000 $\Omega$	500 $\mu\text{A}$
52000 $\Omega$	150 $\mu\text{A}$
[1] Without external voltages	

Frequency	Output Voltage
128 Hz	25 V

<b>Live Circuit Detection</b>	Inhibits test if terminal voltage $>10 \text{ V ac}$ is detected prior to start of test.
-------------------------------	--

## Auto Test Sequence

Models 1664 FC only.

Meets the specifications of the individual tests.

**Operating Ranges and Uncertainties per EN 61557**

Function	Display Range	EN 61557 Measurement Range Operating Uncertainty	Nominal Values
V EN 61557-1	0.0 V ac – 500 V ac	50 V ac – 500 V ac $\pm(2\% + 2 \text{ dgt})$	$U_N = 230/400 \text{ V ac}$ $f = 50/60 \text{ Hz}$
R <sub>LO</sub> EN 61557-4	0.00 $\Omega$ - 2000 $\Omega$	0.2 $\Omega$ - 2000 $\Omega$ $\pm(10\% + 2 \text{ dgt})$	4.0 V dc $<U_Q < 24 \text{ V dc}$ $R_{LO} \leq 2.00 \Omega$ $I_N \geq 200 \text{ mA}$
R <sub>ISO</sub> EN 61557-2	0.00 M $\Omega$ - 1000 M $\Omega$	1 M $\Omega$ - 200 M $\Omega$ $\pm(10\% + 2 \text{ dgt})$ 200 M $\Omega$ - 1000 M $\Omega$ $\pm(15\% + 2 \text{ dgt})$	$U_N = 50 / 100 / 250 / 500 / 1000 \text{ V dc}$ $I_N = 1.0 \text{ mA}$
Z <sub>I</sub> EN 61557-3	Z <sub>I</sub> (No Trip) 0.00 $\Omega$ - 2000 $\Omega$	0.4 $\Omega$ - 2000 $\Omega$ $\pm(15\% + 6 \text{ dgt})$	$U_N = 230/400 \text{ V ac}$ $f = 50/60 \text{ Hz}$ $I_K = 0 \text{ A} - 10.0 \text{ kA}$
	Z <sub>I</sub> (Hi Current) 0.00 $\Omega$ - 2000 $\Omega$	0.2 $\Omega$ - 200 $\Omega$ $\pm(10\% + 4 \text{ dgt})$	
	Z <sub>I</sub> (Hi Current, Hi Res) 0 m $\Omega$ - 9999 m $\Omega$	100 m $\Omega$ - 9999 m $\Omega$ $\pm(8\% + 20 \text{ dgt})$	
	R <sub>E</sub> 0.00 $\Omega$ - 2000 $\Omega$	10 $\Omega$ - 1000 $\Omega$ $\pm(10\% + 2 \text{ dgt})$	
$\Delta T$ , I $\Delta N$ EN 61557-6	$\Delta T$ 0.0 ms – 2000 ms	25 ms – 2000 ms $\pm(10\% + 1 \text{ dgt})$	$\Delta T @ 10 / 30 / 100 / 300 / 500 / 1000 / \text{Var mA}$
	I $\Delta N$ 3 mA – 550 mA (VAR 3 mA – 700 mA)	3 mA – 550 mA $\pm(10\% + 1 \text{ dgt})$	I $\Delta N = 10 / 30 / 100 / 300 / 500 / \text{Var mA}$
R <sub>E</sub> EN 61557-5	0.0 $\Omega$ - 2000 $\Omega$	10 $\Omega$ - 2000 $\Omega$ $\pm(10\% + 2 \text{ dgt})$	$f = 128 \text{ Hz}$
Phase EN 61557-7			1 : 2 : 3
Note: dgt = digits			



## Operating Uncertainties per EN 61557

The Operating Uncertainty shows the maximum possible uncertainty when all influence factors E1-E10 are counted.

	Volts	$R_{Lo}$ EN 61557-4	$R_{ISO}$ EN 61557-2	$Z_I$ EN 61557-3	$\Delta T$ EN 61557-6	$I_{\Delta N}$ EN 61557-6	$R_E$ EN 61557-5
Intrinsic Uncertainty A	0.80 %	1.50 %	10.00 %	6.00 %	1.00 %	5.00 %	3.50 %

Influence Quantity	Volts	$R_{Lo}$ EN 61557-4	$R_{ISO}$ EN 61557-2	$Z_I$ EN 61557-3	$\Delta T$ EN 61557-6	$I_{\Delta N}$ EN 61557-6	$R_E$ EN 61557-5
E1 - Position	0.00 %	0.00 %	0.00 %	0.00 %	0.00 %	0.00 %	0.00 %
E2 - Supply Voltage	0.50 %	3.00 %	3.00 %	3.00 %	3.00 %	2.75 %	2.00 %
E3 - Temperature	0.50 %	3.00 %	3.00 %	3.00 %	3.00 %	2.25 %	1.50 %
E4 - Series Interferences Voltage	-	-	-	-	-	-	2.00 %
E5 - Resistance of the probes and auxiliary earth electrodes	-	-	-	-	-	-	4.60 %
E6.2 - System phase angle	-	-	-	1.00 %	-	-	-
E7 - System frequency	0.50 %	-	-	2.50 %	-	-	0.00 %
E8 - System voltage	-	-	-	2.50 %	2.50 %	2.50 %	0.00 %
E9 - Harmonics	-	-	-	2.00 %	-	-	-
E10 - D.C. Quantity	-	-	-	2.50 %	-	-	-

