

323/324/325

Clamp Meter

Calibration Manual

LIMITED WARRANTY AND LIMITATION OF LIABILITY

Each Fluke product is warranted to be free from defects in material and workmanship under normal use and service. The warranty period is two years and begins on the date of shipment. Parts, product repairs, and services are warranted for 90 days. This warranty extends only to the original buyer or end-user customer of a Fluke authorized reseller, and does not apply to fuses, disposable batteries, or to any product which, in Fluke's opinion, has been misused, altered, neglected, contaminated, or damaged by accident or abnormal conditions of operation or handling. Fluke warrants that software will operate substantially in accordance with its functional specifications for 90 days and that it has been properly recorded on non-defective media. Fluke does not warrant that software will be error free or operate without interruption.

Fluke authorized resellers shall extend this warranty on new and unused products to end-user customers only but have no authority to extend a greater or different warranty on behalf of Fluke. Warranty support is available only if product is purchased through a Fluke authorized sales outlet or Buyer has paid the applicable international price. Fluke reserves the right to invoice Buyer for importation costs of repair/replacement parts when product purchased in one country is submitted for repair in another country.

Fluke's warranty obligation is limited, at Fluke's option, to refund of the purchase price, free of charge repair, or replacement of a defective product which is returned to a Fluke authorized service center within the warranty period.

To obtain warranty service, contact your nearest Fluke authorized service center to obtain return authorization information, then send the product to that service center, with a description of the difficulty, postage and insurance prepaid (FOB Destination). Fluke assumes no risk for damage in transit. Following warranty repair, the product will be returned to Buyer, transportation prepaid (FOB Destination). If Fluke determines that failure was caused by neglect, misuse, contamination, alteration, accident, or abnormal condition of operation or handling, including overvoltage failures caused by use outside the product's specified rating, or normal wear and tear of mechanical components, Fluke will provide an estimate of repair costs and obtain authorization before commencing the work. Following repair, the product will be returned to the Buyer transportation prepaid and the Buyer will be billed for the repair and return transportation charges (FOB Shipping Point).

THIS WARRANTY IS BUYER'S SOLE AND EXCLUSIVE REMEDY AND IS IN LIEU OF ALL OTHER WARRANTIES, EXPRESS OR IMPLIED, INCLUDING BUT NOT LIMITED TO ANY IMPLIED WARRANTY OF MERCHANTABILITY OR FITNESS FOR A PARTICULAR PURPOSE. FLUKE SHALL NOT BE LIABLE FOR ANY SPECIAL, INDIRECT, INCIDENTAL OR CONSEQUENTIAL DAMAGES OR LOSSES, INCLUDING LOSS OF DATA, ARISING FROM ANY CAUSE OR THEORY.

Since some countries or states do not allow limitation of the term of an implied warranty, or exclusion or limitation of incidental or consequential damages, the limitations and exclusions of this warranty may not apply to every buyer. If any provision of this Warranty is held invalid or unenforceable by a court or other decision-maker of competent jurisdiction, such holding will not affect the validity or enforceability of any other provision.

Fluke Corporation
P.O. Box 9090
Everett, WA 98206-9090
U.S.A.

Fluke Europe B.V.
P.O. Box 1186
5602 BD Eindhoven
The Netherlands

Table of Contents

Title	Page
Introduction.....	1
Contact Fluke.....	1
Safety Information.....	2
Specifications.....	5
Electrical Specifications.....	5
Mechanical Specifications.....	6
Environmental Specifications.....	6
Maintenance.....	7
Clean the Product.....	7
Battery Replacement.....	7
User-Replaceable Parts.....	8
Required Equipment.....	8
Performance Tests.....	9
Test the Display.....	9
Firmware Version and Model Number.....	10
Backlight (324 and 325).....	10
Button Test.....	10
Temperature, Volts, Ohms, Frequency, and Capacitance.....	11
Current.....	12
Calibration Adjustment.....	15
Temperature Zero Procedure (324 and 325).....	19

List of Tables

Table	Title	Page
1.	Symbols.....	4
2.	User-Replaceable Parts	8
3.	Required Equipment.....	8
4.	Performance Tests	13
5.	Calibration Adjustment	17

List of Figures

Figure	Title	Page
1.	Clamp Jaw (325 is Shown).....	3
2.	Battery Replacement	8
3.	Display Segments (324 and 325 Display is Shown)	9
4.	Temperature, Volts, Ohms, Frequency, and Capacitance Performance Test Connections	11
5.	AC Current Test Connections	12
6.	Short the CAL Keypad.....	16

Introduction

The Fluke 323/324/325 Clamp Meters (the Product) measure ac and dc voltage, ac current, resistance, and continuity. The 324 and 325 can also measure capacitance and contact temperature. The 325 can also measure dc current and frequency. Note that the 325 is shown in all of the illustrations. For temperature measurement, you must use the included K-type thermocouple.

Warning

Read "Safety Information" before you use the Product.

Contact Fluke

To contact Fluke, call one of the following telephone numbers:

- Technical Support USA: 1-800-44-FLUKE (1-800-443-5853)
- Calibration/Repair USA: 1-888-99-FLUKE (1-888-993-5853)
- Canada: 1-800-36-FLUKE (1-800-363-5853)
- Europe: +31 402-675-200
- Japan: +81-3-6714-3114
- Singapore: +65-738-5655
- Anywhere in the world: +1-425-446-5500

Or, visit Fluke's website at www.fluke.com.

To register your product, visit <http://register.fluke.com>.

To see, print, or download the latest manual supplement, visit <http://us.fluke.com/usen/support/manuals>.

Safety Information

A **Warning** identifies conditions and procedures that are dangerous to the user. A **Caution** identifies conditions and procedures that could cause Product damage, equipment under test damage, or permanent loss of data.

Table 1 shows the symbols used on the Product and in this manual.

Warning

To prevent possible electrical shock, fire, or personal injury:

- Use the Product only as specified, or the protection supplied by the Product can be compromised.
- Use only correct measurement category (CAT), voltage, and amperage rated probes, test leads, and adapters for the measurement.
- Do not touch voltages > 30 V ac rms, 42 V ac peak, or 60 V dc.
- Carefully read all instructions.
- Hold the Product behind the tactile barrier. See Figure 1, item ①.
- Do not exceed the Measurement Category (CAT) rating of the lowest rated individual component of a Product, probe, or accessory.
- Do not measure current while the test leads are in the input jacks.
- Do not use the Product around explosive gas, vapor, or in damp or wet environments.
- Limit operation to the specified measurement category, voltage, or amperage ratings.
- Do not work alone.
- Do not apply more than the rated voltage, between the terminals or between each terminal and earth ground.
- Comply with local and national safety codes. Use personal protective equipment (approved rubber gloves, face protection, and flame-resistant clothes) to prevent shock and arc blast injury where hazardous live conductors are exposed.
- Replace the batteries when the low battery indicator shows to prevent incorrect measurements.
- The battery door must be closed and locked before you operate the Product.
- Measure a known voltage first to make sure that the Product operates correctly.
- Remove all probes, test leads, and accessories that are not necessary for the measurement.
- Only use probes, test leads, and accessories that have the same measurement category and voltage rating as the Product.
- Keep fingers behind the finger guards on the probes.

- Connect the common test lead before the live test lead and remove the live test lead before the common test lead.
- Remove all probes, test leads, and accessories before the battery door is opened.
- Do not use and disable the Product if it is damaged.
- Do not use the Product if it operates incorrectly.
- Do not use test leads if they are damaged. Examine the test leads for damaged insulation, exposed metal. Check test lead continuity.
- Before each use, examine the Product. Look for cracks or missing pieces of the clamp housing. Also look for loose or weakened components. Carefully examine the insulation around the jaws. See Figure 1, item ②.
- Examine the case before you use the Product. Look for cracks or missing plastic. Carefully look at the insulation around the terminals.
- Read all safety information before you use the Product.
- Remove batteries to prevent battery leakage and damage to the Product if it is not used for an extended period.
- Remove the batteries if the Product is not used for an extended period of time, or if stored in temperatures above 50 °C. If the batteries are not removed, battery leakage can damage the Product.

⚠ Caution

To prevent possible damage to the Product or to equipment under test, use a thermocouple rated for the temperatures to be measured. The Product is rated for -10.0 °C to +400.0 °C and 14 °F to 752 °F. The included type-K thermocouple is rated to 260 °C.

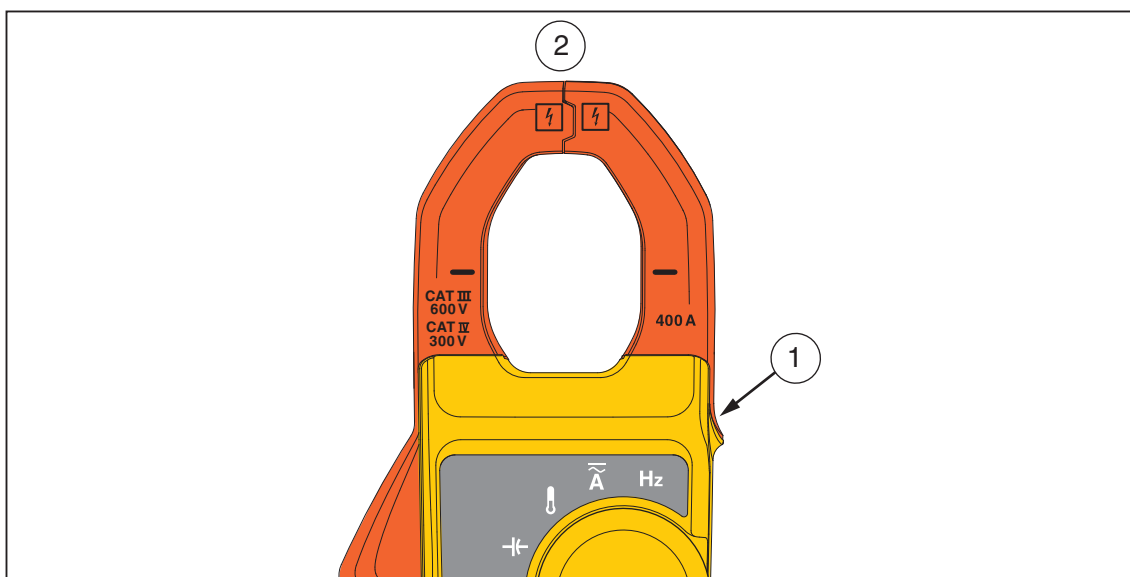

















Figure 1. Clamp Jaw (325 is Shown)

hfk002.eps

Table 1. Symbols

Symbol	Meaning	Symbol	Meaning
	Hazardous voltage. Risk of electric shock.		Risk of Danger. Important information. See Manual.
	AC (Alternating Current)		DC (Direct Current)
	AC and DC Current		Earth Terminal
	Double insulated		Battery
	Application to or removal from hazardous, live conductors is permitted.		Conforms to European Union directives.
	Conforms to relevant Australian EMC standards.		Inspected and licensed by TÜV Product Services.
	This product has been tested to the requirements of CAN/CSA-C22.2 No. 61010-1, second edition, including Amendment 1, or a later version of the same standard incorporating the same level of testing requirements.		Conforms to European Union directives.
CAT II	Measurement category II is applicable to test and measuring circuits connected directly to utilization points of low voltage mains installation.	CAT III	Measurement Category III is applicable to test and measuring circuits connected to the distribution part of the building's low-voltage MAINS installation.
CAT IV	Measurement Category IV is applicable to test and measuring circuits connected at the source of the building's low-voltage MAINS installation.		<p>This product complies with the WEEE Directive (2002/96/EC) marking requirements. The affixed label indicates that you must not discard this electrical/electronic product in domestic household waste. Product Category: With reference to the equipment types in the WEEE Directive Annex I, this product is classed as category 9 "Monitoring and Control Instrumentation" product. Do not dispose of this product as unsorted municipal waste. Go to Fluke's website for recycling information.</p> <p><i>Note</i></p> <p><i>This product complies with the Regulation for the Administration of the Recovery and Disposal of Waste Electrical and Electronic Products (China).</i></p>

Note

The Measurement Category (CAT) and voltage rating of combinations of test probes, test probe accessories, current clamp accessories, and the Product is the LOWEST rating of individual components.

Specifications

Electrical Specifications

AC Current (Jaw)

Range	
323.....	400.0 A
324, 325.....	(40.00, 400.0) A
Resolution	
323.....	0.1 A
324, 325.....	(0.01, 0.1) A
Accuracy	
323, 325.....	2.0 % ±5 digits (45 - 65 Hz)
	2.5 % ±5 digits (65 - 400 Hz)
324.....	1.5 % ±5 digits (45 Hz to 400 Hz)
	Note: Add 2 % for position sensitivity

DC Current with Jaw (325)

Range	(40.00, 400.0) A
Resolution	(0.01, 0.1) A
Accuracy	2.0 % ± 5 digits

AC Voltage

Range	600.0 V
Resolution	0.1 V
Accuracy (45 – 400 Hz)	1.5 % ± 5 digits

DC Voltage

Range	600.0 V
Resolution	0.1 V
Accuracy	1 % ± 5 digits

Resistance

Range	
323, 324.....	(400.0, 4000) Ω
325.....	(400.0, 4000, 40000) Ω
Resolution	(0.1, 1, 10) Ω
Accuracy	1 % ±5 digits
Continuity Beeper	
323.....	≤70 Ω
324/325.....	≤30 Ω

Capacitance (324, 325)

Range	(100.0, 1000) μF
Resolution	(0.1, 1) μF
Accuracy	1 % ±4 digits

Frequency (325)

Range	5.0 to 500.0 Hz
Resolution	0.1 Hz
Accuracy	0.5 % ±4 digits
Trigger Level	5 to 10 Hz, ≥10 A
	10 to 100 Hz, ≥5 A
	100 to 500 Hz, ≥10 A

Maintenance

Clean the Product

⚠ Caution

To prevent possible damage to the Product or to equipment under test, do not use abrasive cleaners. They will damage the case.

Regularly wipe the case with a damp cloth and weak detergent.

To clean the Product Jaw:

1. Examine the jaw-mating surface to make sure it is clean. If there is unwanted material (including rust), jaw closure will not be correct and there will be measurement errors.
2. Open the jaws and clean the clamp metal ends with a non-flammable oil and cloth.

Battery Replacement

⚠⚠ Warning

To prevent possible explosion, fire, or personal injury, replace the batteries when the low battery indicator (🔋) shows to prevent incorrect measurements.

⚠ Caution

To prevent possible damage to the Product or to equipment under test:

- **Remove batteries to prevent battery leakage and damage to the Product if it is not used for an extended period.**
- **Be sure that the battery polarity is correct to prevent battery leakage.**

To change the batteries, see Figure 2:

1. Make sure the Product is off.
2. Turn over the Product to access the battery compartment door screw.
3. Use a flat-head screwdriver to loosen the battery compartment door screw and lift off the battery compartment door.
4. Replace the two AAA batteries. Make sure to use the correct polarity when you put the batteries into the battery compartment door.
5. Reattach the battery compartment door.
6. Tighten the battery compartment door screw.

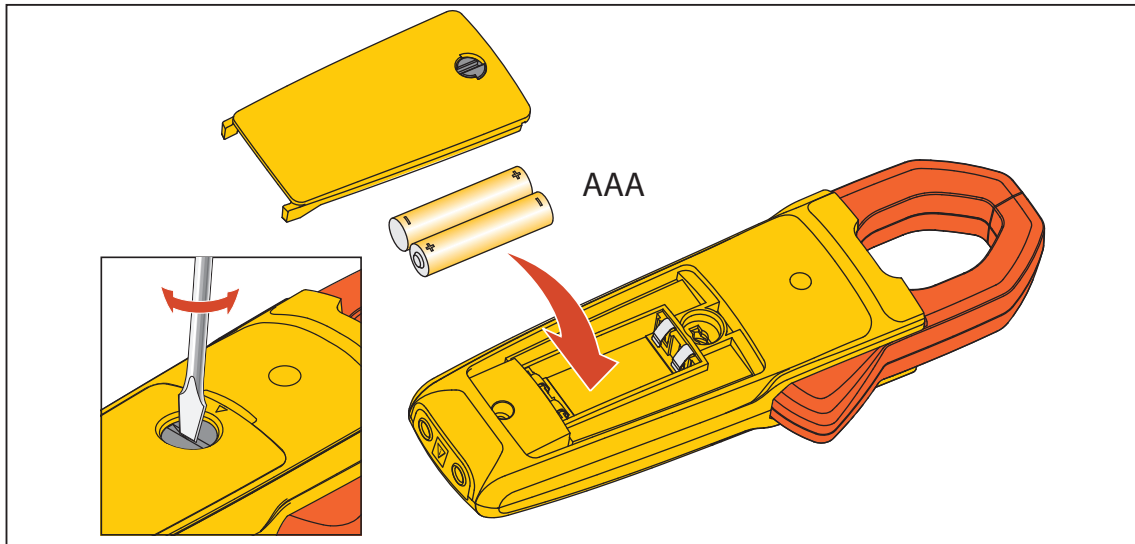

Figure 2. Battery Replacement

hfj007.eps

User-Replaceable Parts

User-replaceable parts are shown in Table 2.

Table 2. User-Replaceable Parts

Fluke Part Number	Description	Qty
3986568	FLUKE-CAP-2001,TL7X PROBE CAP,BLACK	1
3986579	FLUKE-CAP-2001-01,TL7X PROBE CAP,FLUKE RED	1
2838018	BATTERY 1.5V LR03 ALKALINE AAA	2
4146344	BATTERY DOOR	1
4166286	SOFT CASE BLACK/YELLOW VINYL	1
4045153	323/324/325 USERS MANUAL	1
1997234	THERMOCOUPLE ASSEMBLY K-TYPE BEADED MOLDED DUAL BANANA PLUG COILED BULK	1

Required Equipment

The equipment in Table 3 is necessary for the performance tests and calibration adjustment.

Table 3. Required Equipment

Equipment	Required Characteristics	Recommended Model
Calibrator	4.5-digit resolution	Fluke 5520A Calibrator or Equivalent
Wired coil	50 turns	5500A/COIL

Performance Tests

⚠⚠ Warning

To prevent possible electrical shock, fire, or personal injury, do not go through the performance test procedures unless the Product is fully assembled.

The performance tests verify the full operation of the Product and measure the accuracy of each function against Product specifications. If the Product fails a part of the test, calibration adjustment and/or repair is necessary. See “Calibration Adjustment”.

Before you do the performance tests:

1. Make sure that you have the necessary equipment. See Table 3.
2. Make sure the Product batteries are good and replace them if necessary. See “Battery Replacement”.
3. Warm up the Calibrator as necessary. Refer to its specifications.
4. Let the temperature of the UUT (unit under test) become stable to room temperature.

Test the Display

To verify that all segments of the display function:

1. With the Product off, push and hold any of the buttons.
2. Turn the rotary switch on while you hold down the button. All of the display segments are shown. See Figure 3.

If segments of the display are missing, repair is necessary. See “Contact Fluke”.

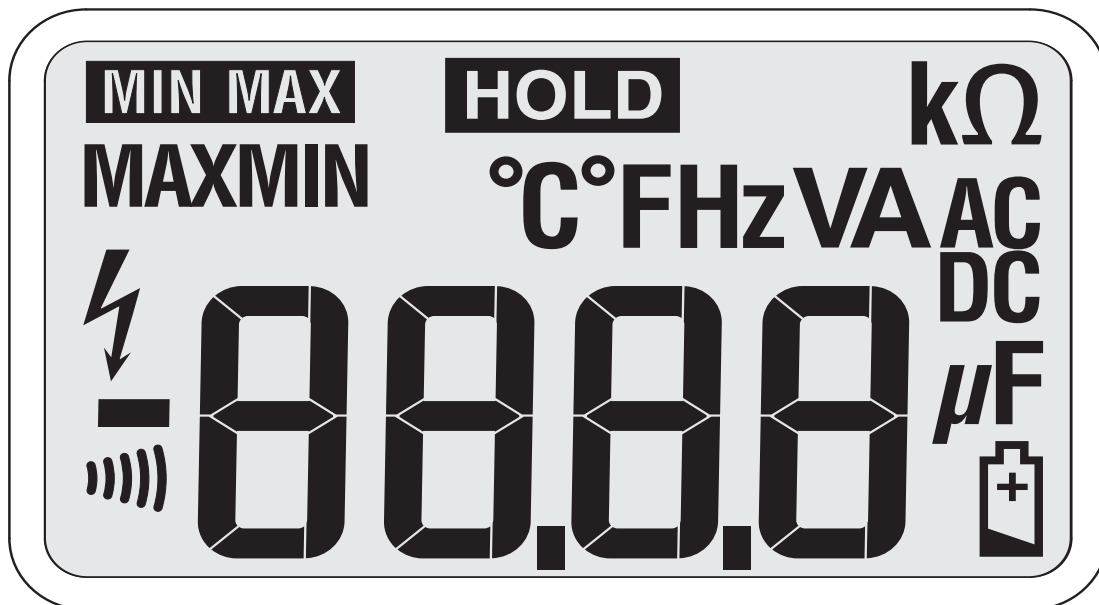

Figure 3. Display Segments (324 and 325 Display is Shown)

hfk001.eps

Firmware Version and Model Number

To see the Product firmware version and model number:

323:



1. Turn on the Product with the HOLD button held down.
2. After the display segments are shown, release the HOLD button.
3. The Product shows:
 - “**POFF**” for the auto-power off function
 - “**r003**” or the current firmware version
 - “**F323**” (Fluke 323)

324/325:

1. Turn on the Product.
2. The display shows:
“**F32X**” (Fluke 324 or Fluke 325)
 1. Turn on the Product with the F/C button held down.
 2. After the display segments are shown, release the F/C button.
 3. The display shows:
“**r0.52**” or the current firmware version

Backlight (324 and 325)

To verify that the backlight functions:

1. With the Product on, push . The backlight will come on.
2. Push  again to turn the backlight off.
3. If the backlight does not function correctly, repair is necessary. See “Contact Fluke”.

Button Test

To verify that the buttons function, turn on the Product and push each button separately. Each button push causes the Product to beep and the display to change. For the 324 and 325, note that the Product beeps twice if the Product is in the wrong mode for the pushed button. If the buttons do nothing, repair is necessary. See “Contact Fluke”.

Temperature, Volts, Ohms, Frequency, and Capacitance

To do the temperature, volts, ohms, and capacitance performance tests:

1. Connect the Calibrator NORMAL output and ground to the Product. See Figure 4 for the connections.
2. Apply the values shown in Table 4.

If the Product shows indications outside of the limits shown in Table 4, calibration adjustment is necessary. See “Calibration Adjustment”.

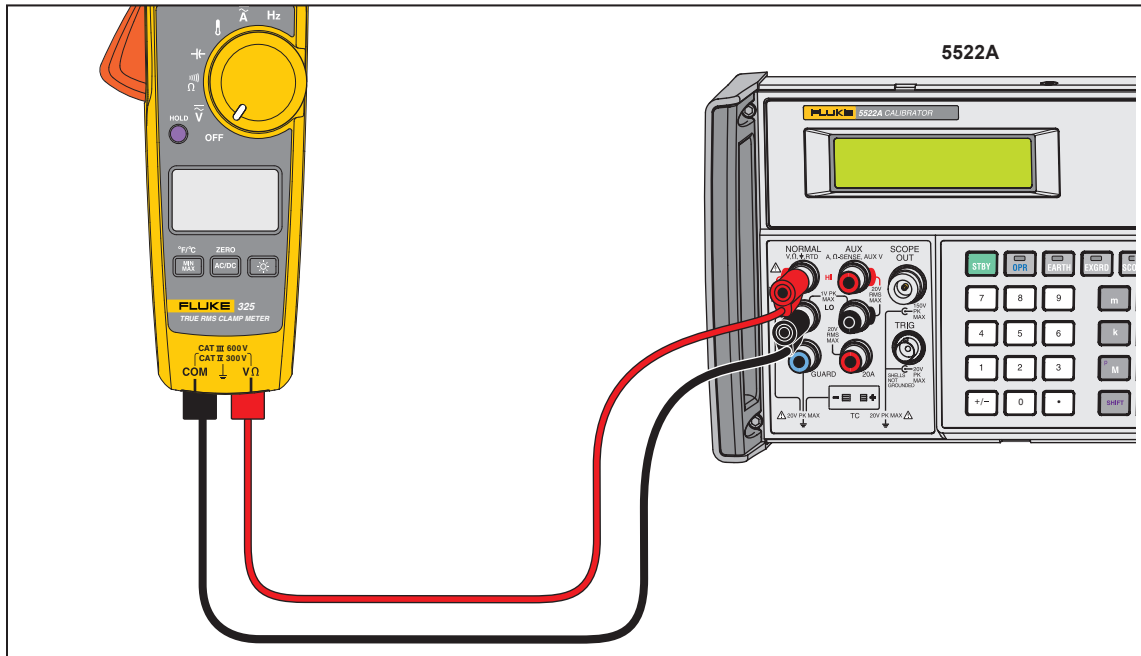

hfk07.eps

Figure 4. Temperature, Volts, Ohms, Frequency, and Capacitance Performance Test Connections

Current

To do the current tests:

1. Connect the Calibrator current output and ground to the 50-Turn Coil. See Figure 5.
2. Turn the Product to the necessary current mode.
3. Apply the input level for each step shown in Table 4.
4. Compare the indication on the Product display with the UUT reading limits in Table 4.
5. If the Product shows indications outside of the limits shown in Table 4, calibration adjustment is necessary. See “Calibration Adjustment”.

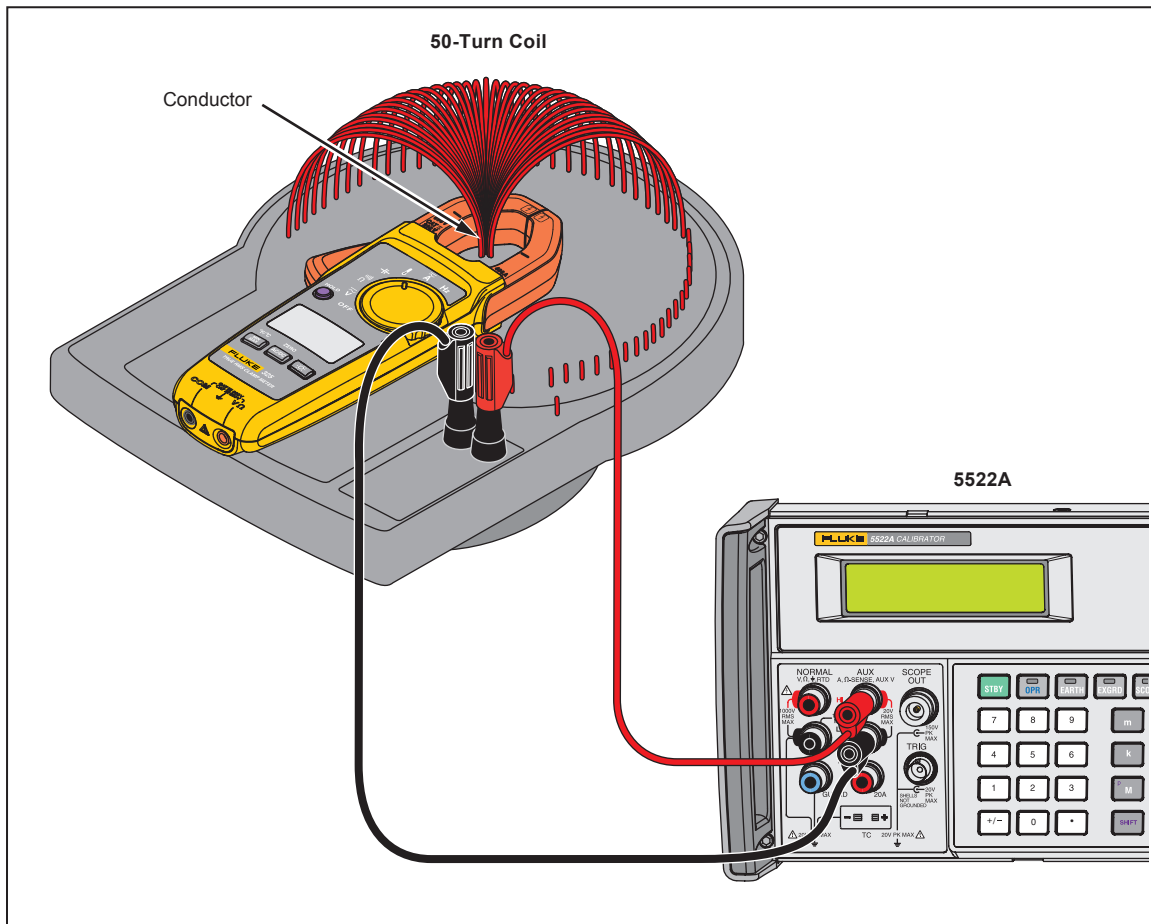

Figure 5. AC Current Test Connections

hfk025.eps

Table 4. Performance Tests

Test (Switch Position)	Calibrator Output	323	324	325	Meter Reading Limit	
					Low	High
Temperature	-5 °C	N/A	X	X	-5.8 °C	-4.2 °C
	0 °C	N/A	X	X	-0.8 °C	0.8 °C
	100 °C	N/A	X	X	98.2 °C	101.8 °C
	400 °C	N/A	X	X	395.2 °C	404.8 °C
AC Volts	10 V @ 50 Hz	X	X	X	9.3 V	10.7 V
	500 V @ 50 Hz	N/A	X	X	492.0V	508.0 V
	500 V @ 500 Hz	N/A	X	X	492.0V	508.0 V
	600 V @ 50 Hz	X	N/A	N/A	590.5 V	609.5 V
	600 V @ 400 Hz	X	N/A	N/A	590.5 V	609.5 V
DC Volts	-600 V	X	N/A	N/A	-606.5	-593.5 V
	-500 V	N/A	X	X	-505.5 V	-494.5 V
	10 V	X	X	X	9.4 V	10.6 V
	500 V	N/A	X	X	494.5 V	505.5 V
	600 V	X	N/A	N/A	593.5 V	606.5 V
Ohms	0 Ω	X	N/A	N/A	0.0 Ω	0.5 Ω
	10 Ω	X	X	X	9.4 Ω	10.6 Ω
	300 Ω	N/A	X	X	296.5 Ω	303.5 Ω
	350 Ω	X	N/A	N/A	346.0 Ω	354.0 Ω
	1000 Ω	N/A	X	X	985 Ω	1015 Ω
	3000 Ω	N/A	X	X	2965 Ω	3035 Ω
	3500 Ω	X	N/A	N/A	3460 Ω	3540 Ω
	10K Ω	N/A	X	X	9.85 KΩ	10.15 KΩ
	30K Ω	N/A	X	X	34.65 KΩ	30.35 Ω
Capacitance	10 μF	N/A	X	X	9.5 μF	10.5 μF
	500 μF	N/A	X	X	491 μF	509 μF
	900 μF	N/A	X	X	887 μF	913 μF
Frequency	0.2 A, 5 Hz	N/A	N/A	X	4.7 Hz	5.3 Hz
	0.2 A, 50 Hz	N/A	N/A	X	49.6 Hz	50.4 Hz
	0.2 A, 500 Hz	N/A	N/A	X	497.5 Hz	501.5 Hz

Table 4. Performance Tests (cont.)

Test (Switch Position)	Calibrator Output	323	324	325	Meter Reading Limit	
					Low	High
AC Amps (with 50- Turn Coil)	0.12 A @ 50 Hz	X	N/A	N/A	5.4 A	6.6 A
	0.48 A @ 150 Hz	X	N/A	N/A	22.9 A	25.1A
	4.2 A @ 50Hz	X	N/A	N/A	205.3 A	214.7 A
	7.8 A @ 50 Hz	X	N/A	N/A	381.7 A	398.3 A
	7.8 A @ 150 Hz	X	N/A	N/A	379.7 A	400.3 A
	7.8 A @ 400 Hz	X	N/A	N/A	379.7 A	400.3 A
	0.004 A @ 50 Hz	N/A	X	N/A	0.15 A	0.25 A
	0.2 A @ 50 Hz	N/A	X	N/A	9.80 A	10.20 A
	0.6 A @ 50 Hz	N/A	X	N/A	29.50 A	30.50 A
	2 A @ 50 Hz	N/A	X	N/A	97.5 A	102.5 A
	6 A @ 50 Hz	N/A	X	N/A	293.5 A	306.5 A
	0.2 A @ 50 Hz	N/A	N/A	X	9.75 A	10.25 A
	0.6 A @ 50 Hz	N/A	N/A	X	29.35 A	30.65 A
	2 A @ 50 Hz	N/A	N/A	X	98.0 A	102.0 A
	6 A @ 50 Hz	N/A	N/A	X	295.0A	305.0 A
DC Amps (with 50- Turn Coil)	0.2 A	N/A	N/A	X	9.75 A	10.25 A
	0.6 A	N/A	N/A	X	29.35 A	30.65 A
	2 A	N/A	N/A	X	97.5 A	102.5 A
	6 A	N/A	N/A	X	293.5 A	306.5 A

Calibration Adjustment

The Product features closed-case calibration adjustment and uses known reference sources. The Product measures the applied reference source, calculates correction factors, and stores the correction factors in nonvolatile memory.

Should the Product fail any of the performance tests, do the calibration adjustment procedure.

To do the calibration adjustment:

1. Remove the Product battery door. See “Battery Replacement”.
2. Apply 3.0 V across the battery contacts on the pca. Note the polarity that is shown in Figure 6.
3. Turn the rotary switch to the function that you will adjust.
4. Remove the calibration seal.
5. Short across the CAL keypad on the pca and then remove the short. See Figure 6. This puts the Product into calibration mode.
6. When “C-1.2” is shown on the Product display, apply the correct input signals from the Calibrator to the Product as shown in Table 5. After confirmation, the Product goes to the subsequent calibration step.
7. After each step, push the HOLD button to confirm the calibration step and go to the next step. Set the Calibrator to Standby after you complete adjustment of each function.

Notes

For 323, if any calibration point is missing “Err” is shown on the display.

After you push the HOLD button, wait until the calibration step number advances before you change the calibrator source. Some adjustment steps can take several seconds to execute before the Product goes to the subsequent step.

8. When calibration adjustment is complete, remove the 3.0 V supply. The Product will automatically exit calibration mode.
9. Replace the batteries and battery door.

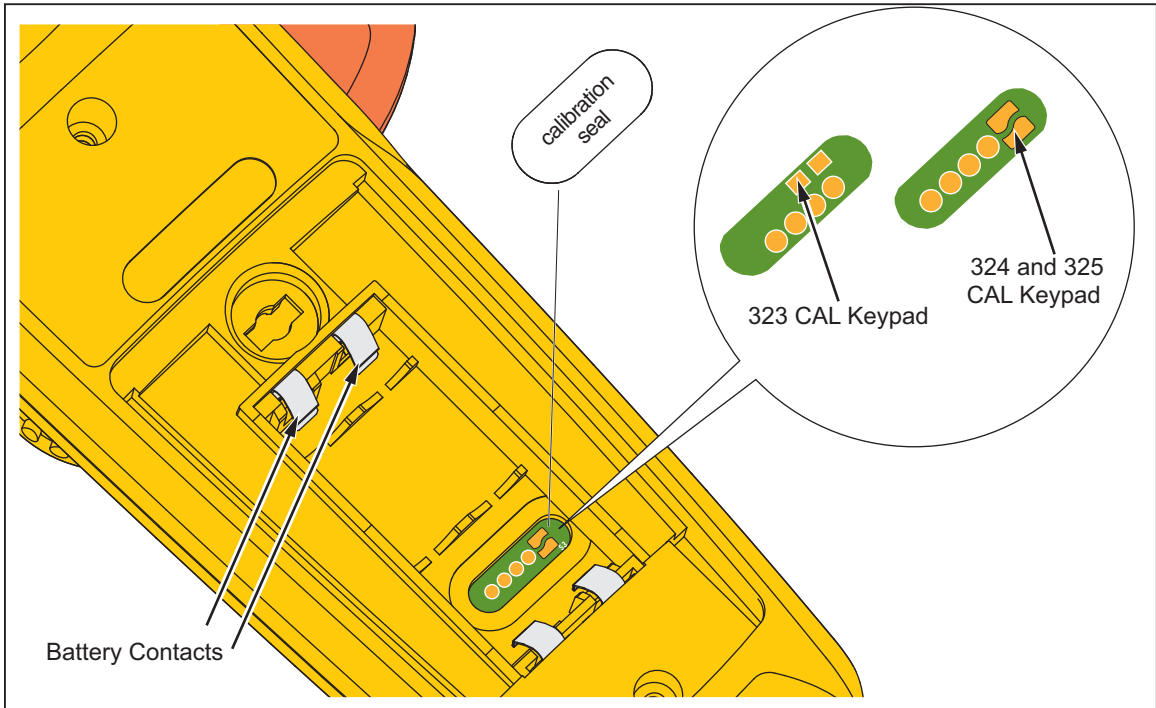

Figure 6. Short the CAL Keypad

hfk03.eps

Table 5. Calibration Adjustment

Test (Switch Position)	LCD Reading	Calibrator Output
323		
AC Volts	C-1.1	1.05 V, 50 Hz
	C-1.2	40 V, 50 Hz
	C-1.3	10 V, 50 Hz
	C-1.4	300 V, 50 Hz
DC Volts	C-2.2	400 V
Ohms	C-3.1	400 Ω
	C-3.2	4000 Ω
AC Amps (with 50-Turn Coil)	C-4.1	0.019 A, 50 Hz
	C-4.2	0.42 A, 50 Hz
	C-4.3	1.026 A, 50 Hz
	C-4.4	6 A, 50 Hz
[1] 324 and 325		
Temperature	C-21	0 V
	C-22	0.02 V
	C-23	0.02 V
AC Volts	C-00	600 V, 50 Hz
	C-01	600 V, 100 Hz
	C-02	600 V, 200 Hz
	C-03	600 V, 300 Hz
	C-04	600 V, 400 Hz
DC Volts	C-05	0 V
	C-06	600 V
	C-07	0 V
	C-08	0.5 V
Ohms	C-09	0 Ω
	C-10	400 Ω
	C-11	440 Ω
	C-12	4000 Ω
	C-13 (325 only)	4400 Ω
	C-14 (325 only)	40000 Ω
<p>[1] At each function, after all calibration points is adjusted, the display shows “Save” after the last calibration point. Push HOLD to save the calibration data.</p>		

Table 8. Calibration Adjustment (cont.)

Test (Switch Position)	LCD Reading	Calibrator Output
324 and 325		
Capacitance	C-15	0.1 μ F
	C-16	0.5 μ F
	C-17	1.5 μ F
	C-18	110 μ F
	C-19	500 μ F
	C-20	1000 μ F
324		
AC Amps (with 50-Turn Coil)	C-24	0.8 A, 50 Hz
	C-25	0.8 A, 100 Hz
	C-26	0.8 A, 200 Hz
	C-27	0.8 A, 300 Hz
	C-28	0.8 A, 400 Hz
	C-29	8 A, 50 Hz
325		
AC Amps (with 50-Turn Coil)	C-24	0 A
	C-25	0.02 A, 50 Hz
	C-26	0.8 A, 50 Hz
	C-27	0.8 A, 100 Hz
	C-28	0.8 A, 200 Hz
	C-29	0.8 A, 300 Hz
	C-30	0.8 A, 400 Hz
	C-31	8 A, 50 Hz
DC Amps (with 50-Turn Coil)	C-32	0 A
	C-33	0.02 A
	C-34	0.8 A
	C-35	0.88 A
	C-36	8 A

Temperature Zero Procedure (324 and 325)

1. Turn off the Product and wait 20 minutes.
2. Connect a K-type thermocouple connector from the Calibrator to the Product.
3. After 20 minutes, with the Product still connected to the 3.0 V, turn on the Product and short across the CAL keypad on the pca. See Figure 6.
4. Turn the Product rotary switch to temperature.
5. Push  twice until “C-23” shows on the Product display.
6. Apply 0 °C from the Calibrator.
7. Push the HOLD button to confirm C-23.
8. Push the HOLD button to save the calibration data.

The calibration adjustment procedure is complete.

