

FLUKE®

3561 FC/3502 FC

Vibration Sensor/Gateway

Getting Started Manual

PN 5020149

July 2018

©2018 Fluke Corporation. All rights reserved. Specifications are subject to change without notice. All product names are trademarks of their respective companies.

LIMITED WARRANTY AND LIMITATION OF LIABILITY

This Fluke product will be free from defects in material and workmanship for two years from the date of purchase. This warranty does not cover fuses, disposable batteries, or damage from accident, neglect, misuse, alteration, contamination, or abnormal conditions of operation or handling. Resellers are not authorized to extend any other warranty on Fluke's behalf. To obtain service during the warranty period, contact your nearest Fluke authorized service center to obtain return authorization information, then send the product to that Service Center with a description of the problem.

THIS WARRANTY IS YOUR ONLY REMEDY. NO OTHER WARRANTIES, SUCH AS FITNESS FOR A PARTICULAR PURPOSE, ARE EXPRESSED OR IMPLIED. FLUKE IS NOT LIABLE FOR ANY SPECIAL, INDIRECT, INCIDENTAL OR CONSEQUENTIAL DAMAGES OR LOSSES, ARISING FROM ANY CAUSE OR THEORY. Since some states or countries do not allow the exclusion or limitation of an implied warranty or of incidental or consequential damages, this limitation of liability may not apply to you.

11/99

Fluke Corporation
P.O. Box 9090
Everett, WA 98206-9090
U.S.A.

Fluke Europe B.V.
P.O. Box 1186
5602 BD Eindhoven
The Netherlands

Visit Fluke's website at www.fluke.com

To register your product, visit <http://register.fluke.com>

To view, print, or download the latest manual supplement, visit <http://us.fluke.com/usen/support/manuals>

Contents

Introduction	3
Before you install	4
Step 1: Watch the setup video	4
Step 2: Choose the connectivity option	4
Step 3: Setup the network	5
Step 4: Determine asset information	6
Step 5: Record the asset information	10
In-app Setup	11
Step 6: Download and install Fluke Connect	11
Step 7: Complete the in-app setup	12
Sensor Installation	14
Step 8: Select the Sensor location	14
Step 9: Confirm the Sensor and Gateway connection	15
Step 10: Mount the Sensors	16
Step 11: Monitor assets remotely	16
Specifications	17









A **Warning** identifies conditions and procedures that are dangerous to the user. Symbols used on the Product and in this manual are explained in Table 1.

Warning

To prevent possible electrical shock, fire, or personal injury and for safe operation of the Product:

- Read all safety information before you use the Product.
- Use the Product only as specified, or the protection supplied by the product can be compromised.
- Do not use the Product if it operates incorrectly.
- Carefully read all instructions.
- Use this Product indoors only.
- Have an approved technician repair the Product
- Disable the Product if it is damaged.
- Do not use in wet location (Gateway only)

Table 1. Symbols

Symbol	Explanation
	Consult User Documentation.
	WARNING. RISK OF DANGER.
	Conforms to European Union directives.
	Conforms to relevant Australian Safety and EMC standards.
	Certified by Underwriters Laboratories to North American safety standards.
	Indoor use only. (Gateway)
	Double Insulated (Gateway)
	This product complies with the WEEE Directive marking requirements. The affixed label indicates that you must not discard this electrical/electronic product in domestic household waste. Product Category: With reference to the equipment types in the WEEE Directive Annex I, this product is classed as category 9 "Monitoring and Control Instrumentation" product. Do not dispose of this product as unsorted municipal waste.

Introduction

The Product comprises a Fluke 3561 FC Vibration Sensor (the Sensor) and 3502 FC Gateway (the Gateway). Use the Product to monitor vibration trends remotely through the Fluke Connect® app.

Unpack the Product

Carefully unpack all items from the box. See Table 2.

Table 2: Inside the box

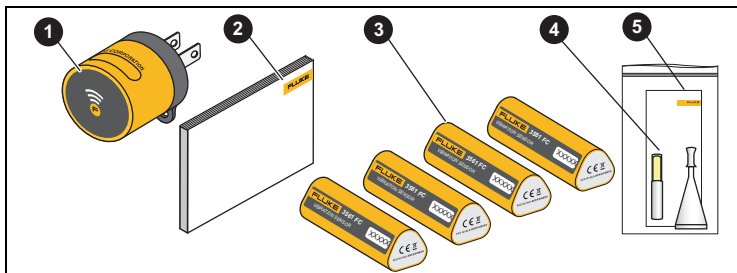

Item	Description Starter/Expansion kits
1	3502 FC Gateway (In Starter Kit only)
2	Getting Started Manual
3	3561 FC Vibration Sensors (4)
4	Epoxy (2)
5	Epoxy application instructions
Not pictured	Software subscription enabled for Sensors (1 year / 3 year)
	Description Gateway
1	3502 FC Gateway
2	Getting Started Manual

Before you install



Important: For a successful setup, follow the sequence in these instructions.

Step 1: Watch the setup video

To see the system setup and installation, watch the video

<http://www.fluke.com/quickstart>



From the Quick Start page, select **3561 FC Vibration Sensor**.

Step 2: Choose the connectivity option

Option 1: WiFi connectivity must be available (2.4 GHz) at the installation location.

OR

Option 2: Use mobile router/hotspot for connectivity. For example: Verizon Jetpack MiFi, Cradlepoint.



Call 425-200-0800 for more information.

Step 3: Setup the network

Note

Skip this step if you are using mobile router/hotspot for connectivity.

For this step, you will need support from your IT team.

1. Obtain the WiFi network name and password.
2. Make sure your network complies with these requirements:
 - WLAN Standards: 802.11 g/n GHz
 - Upload speed: 1Mbps (Sustained)
 - Internet HTTP Proxy: Disabled
 - Supported Authentication Protocols: WEP, WPA



For a comprehensive list of requirements, see *Network Configuration Requirement for the FC Vibration Sensor* at www.fluke.com/quickstart

Step 4: Determine asset information

Collect information on the asset (equipment) where you are installing the Sensor. Including:

- **Determine the assets**

Assets are the equipment being monitored. For example, Chilled Water Pump 2A.

- **Define an asset group**

An asset group is the location (building/plant/floor/production line/room) where the asset is located. Use asset groups to set the asset hierarchy. For example, Boiler Room.

- **Select the test points**

The Test Point is a specific location on the asset. For example, Motor Bearing 1.

- **Record the Sensor ID**

The Sensor ID is the last 5 digits of the unique serial number on the Sensor.

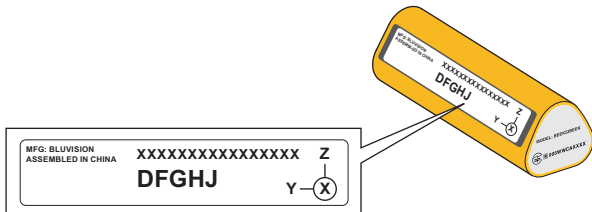

- **Determine the Machine Category**

Machine category is a critical piece of information required to screen the health of your assets. Choose 1 of the 37 machine categories shown in Table 3.

Table 3: Machine Categories

Pumps	
Machine Category	Description
1	Vertical pump (12' to 20' from grade to top of motor)
2	Vertical pump (8' to 12' from grade to top of motor)
3	Vertical pump (5' to 8' from grade to top of motor)
4	Vertical pump (0' to 5' from grade to top of motor)
5	Horizontal centrifugal end suction pump (direct coupled)
6	Horizontal centrifugal double suction pump (direct coupled)
7	Boiler feed pump (turbine or motor driven)
8	Positive displacement horizontal piston pump (under load)
9	Positive displacement horizontal gear pump (under load)

Fans

Machine Category	Description
10	Belt-driven fan (1800 to 3600 RPM)
11	Belt-driven fan (600 to 1799 RPM)
12	General direct drive fan (direct coupled)
13	Shaft-mounted integral fan (extended motor shaft)
14	Axial flow fan (belt or direct drive)
15	Large forced draft fan (fluid film bearings)
16	Large induced draft fan (fluid film bearings)
17	Vacuum blower (belt or direct drive)

Compressor

18	Reciprocating chiller (open motor and compressor)
19	Reciprocating chiller (hermetic motor and compressor)
20	Centrifugal chiller (hermetic or open motor)
21	Reciprocating air compressor
22	Rotary screw air compressor
23	Centrifugal air compressor with or without gearbox
24	Centrifugal air compressor—internal gear (axial measurement)
25	Centrifugal air compressor—internal gear (radial measurement)

Blower	
Machine Category	Description
26	Lobe-type rotary blower (belt or direct drive)
27	Multi-stage centrifugal blower (direct drive)
Cooling Tower Drives	
28	Long, hollow shaft (motor)
29	Belt-drive (motor and fan – all arrangements)
30	Direct drive (motor and fan – all arrangements)
Generic Gearbox	
31	Single Stage gearbox
Machine Tools	
32	Machine tool motor
33	Machine tool gearbox input
34	Machine tool gearbox output
35	Machine tool spindle – roughing operations
36	Machine tool spindle – machine finishing
37	Machine tool spindle – critical finishing

Step 5: Record the asset information

Create an asset information table. For example, see Table 4.

Table 4: Asset Information

Asset Group	Asset	Test Point	Sensor ID	Machine Category
Boiler room	Chilled Water Pump A	Pump bearing 4	DFGHJ	7. Boiler feed pump
Boiler room	Chilled Water Pump A	Pump bearing 3	45T1S	7. Boiler feed pump

In-app Setup



Important: Complete all steps in this section before you install the Sensor on the asset.

Step 6: Download and install Fluke Connect

Sign up or sign into the Fluke Connect app.

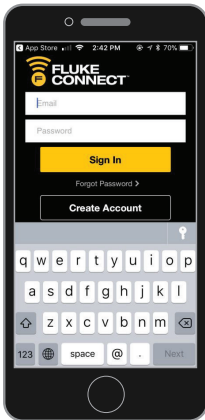

Step 7: Complete the in-app setup

1. Start the in-app setup on your phone.
2. Log into the Fluke Connect app.
3. On the Home screen, tap **Setup Logging or Monitoring**.
4. Follow the in-app instructions to complete the setup.



Important:

- On your mobile phone, turn on **Bluetooth**.
- While connecting the **Gateway** on the app, hold the phone within 4 in (10 cm) from the **Gateway** and follow the prompts.



- While setting up the Sensors on the app, hold the phone within 4 in (10 cm) from the Sensor.
- During the in-app setup, the maximum distance between the Gateway and the Sensor must be ≤ 5 ft (1.5 m).

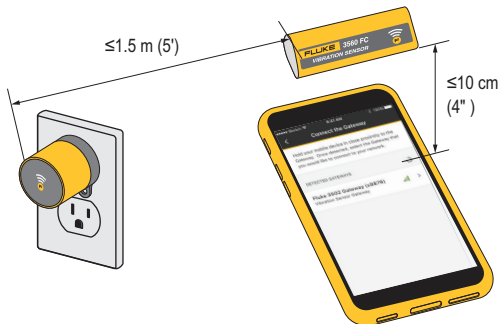

For step-by-step guide on in-app setup, go to:

<http://www.fluke.com/quickstart>



Choose **3561 FC Vibration Sensor** and download *Step by step in-app setup guide*.



Important: Do not begin the physical installation of the Sensors until the data starts to stream on the graph.

Sensor Installation



Important: After completing in-app setup process, wait for a few minutes until the data appears in the session details page.

Step 8: Select the Sensor location

Clean the asset by removing chipped paint, dust, and grease from the surface.

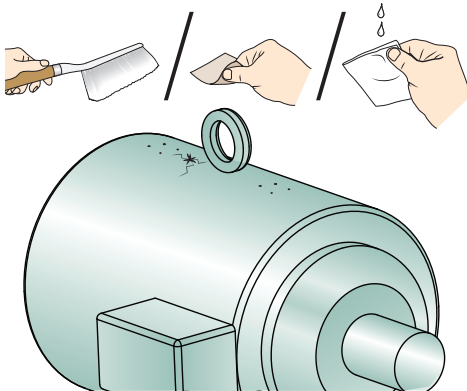

Step 9: Confirm the Sensor and Gateway connection

The Bluetooth range between the Gateway and Sensors is 65 m (213 ft) line-of-sight. However, this **range is affected by metal and concrete** around the Sensors and Gateway. Fluke recommends these steps to make sure there is good connectivity between Sensors and the Gateway.

1. Temporarily place the Sensors on the asset test points. (Do not install them yet.)
2. In the app, make sure you see the alert: *Sensor is now connected*.
3. Monitor the the app for several minutes. Look for the alert: *Sensor has lost connection*.
 - o If you do not receive the alert the position is good.
 - o If you receive the alert, reposition the Gateway closer to the Sensor. Monitor the app again.
4. When the Sensor remains connected for at least 5 minutes without losing the connection, use epoxy to install the Sensor.

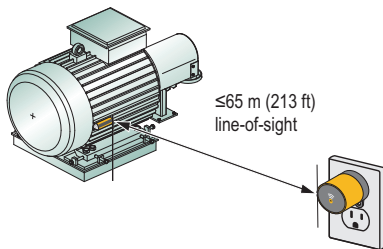

Step 10: Mount the Sensors

Use the epoxy provided in the package to mount the Sensor on the asset test point. Refer to the *Epoxy Application Instructions* for mounting the Sensors.

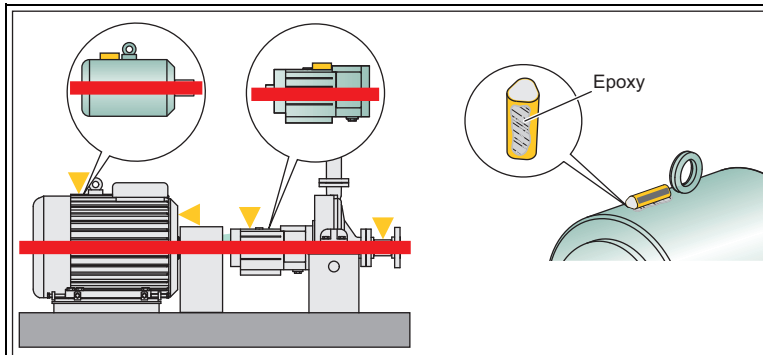

Mount the Sensor on solid metal of bearing(s) of the machine. Do not mount on thin covers, motor fins, electrical boxes, couplings, or belts. Refer to the *Deployment Planning Guide* on the Quick Start page.

Step 11: Monitor assets remotely

You are now ready to remotely view vibration trends, alerts, and alarms from your Sensors.

Specifications

Safety IEC 60950

Sensor

Sensitivity

Range ± 32 g

Frequency Range 10 Hz to 1000 Hz

Sampling Rate 25 600 Hz

Temperature

Operating -30 °C to +80 °C (-20 °F to +176 °F)

Storage -30 °C to +80 °C (-20 °F to +176 °F)

Trending Range Displays temperature trends between -30 °C and +80 °C (-20 °F and +176 °F)

Relative Humidity 10 % to 95 % non-condensing

Altitude

Operating 2000 m

Storage 12 000 m

Size 2.42 in x 0.95 in (61.5 mm x 24 mm)

Weight 1.4 oz (28 g)

Power

Battery Type 3.6 V, 2400 mAh Lithium

Battery Life 3 years typical

Bluetooth

Type Low Energy 4.1

Range 65 m, line-of-sight (during a session)

Frequency Range 2405 MHz to 2480 MHz

Output Power <10 mW

IP Rating IP67

Gateway

Temperature

Operating Range -25 °C to +65 °C (-13 °F to +149 °F)

Storage -25 °C to +65 °C (-22 °F to +149 °F)

Relative Humidity 10 % to 95 % non-condensing

Altitude

Operating 2000 m

Storage 12 000 m

Size 2.26 in x 1.55 in x 1.82 in
(57.3 mm x 39.3 mm x 46.1 mm)

Weight 1.2 oz (35 g)

Power

AC Input 100 V ac to 240 V ac, 50/60 Hz

Bluetooth

Type Low Energy 4.1

Frequency Range 2405 MHz to 2480 MHz

Output Power <10 mW

Antenna -3 dBm Single Antenna, Omni Directional

WiFi

Type 802.11 b/g/n

Frequency Band 2.4 GHz ISM Band

Frequency Range 2412 MHz to 2462 MHz

Output Power <100 mW

Security WEP/WPA/WPA2

Antenna 0 dBm Single Antenna, Omni Directional

Signal Strength Less than -65 to -70 dBm