

**FLUKE®**

# **64 Max**

IR Thermometer  
Instructions

PN 4861406  
January 2017

© 2017 Fluke Corporation. All rights reserved. Specifications are subject to change without notice.  
All product names are trademarks of their respective companies.

## Introduction

The Fluke 64 Max IR Thermometer (the Product) can determine the surface temperature by measuring the amount of infrared energy radiated by the target's surface.

### Warning

**Read all safety information before you use the Product.**



**3-Year Limited Warranty. See the Users Manual for the full warranty.**

Go to [www.fluke.com](http://www.fluke.com) to read the Users Manual and find more information about the Product. To register your product, visit <http://register.fluke.com>. To see, print, or download the latest manual supplement, visit <http://us.fluke.com/user/support/manuals>.

## Safety Information

A **Warning** identifies conditions and procedures that are dangerous to the user. A **Caution** identifies conditions and procedures that can cause damage to the Product or the equipment under test.

### Warning

**To prevent eye damage and personal injury:**

- **Read all safety Information before you use the Product.**
- **Do not use the Product if it operates incorrectly.**
- **Use the Product only as specified, or the protection supplied by the Product can be compromised.**

- **Before you use the Product, inspect the case. Do not use the Product if it appears damaged. Look for cracks or missing plastic.**
- **See emissivity information for actual temperatures. Reflective objects result in lower than actual temperature measurements. These objects pose a burn hazard.**
- **Do not look directly into the laser with optical tools (for example, binoculars, telescopes, microscopes). Optical tools can focus the laser and be dangerous to the eye.**
- **Do not look into the laser. Do not point laser directly at persons or animals or indirectly off reflective surfaces.**
- **Replace the batteries when the low battery indicator shows to prevent incorrect measurements.**
- **Do not use the Product around explosive gas, vapor, or in damp or wet environments.**
- **Use the Product only as specified or hazardous laser radiation exposure can occur.**

**⚠ Caution**







- **To avoid damage to the Product, do not leave the thermometer on or near objects of high temperature.**

## 64 Max

### Instructions

Table 1 lists the symbols used on the Product and in this manual.

**Table 1. Symbols**

Symbol	Meaning	Symbol	Meaning
	WARNING. RISK OF DANGER.		Warning. Laser.
	Consult user documentation.		Conforms to European Union directives.
	Conforms to relevant Australian EMC standards.		
	<p>Indicates a Class 2 laser. DO NOT STARE INTO BEAM. The following text may appear with the symbol on the product label: "IEC/EN 60825-1 Complies with 21 CFR 1040.10 and 1040.11 except for deviations pursuant to Laser Notice 50, dated June 24, 2007." In addition, the following pattern on the label will indicate wavelength and optical power:  <math>\lambda = xxxnm, x.xx\text{mW}</math></p>		
	<p>This product complies with the WEEE Directive marking requirements. The affixed label indicates that you must not discard this electrical/electronic product in domestic household waste. Product Category: With reference to the equipment types in the WEEE Directive Annex I, this product is classed as category 9 "Monitoring and Control Instrumentation" product. Do not dispose of this product as unsorted municipal waste.</p>		

**Table 2. Nominal Surface Emissivity**

<b>Material</b>	<b>Value</b>	<b>Material</b>	<b>Value</b>
Default****	0.95	Glass	0.85
Aluminum*	0.30	Iron*	0.70
Asbestos	0.95	Lead*	0.50
Asphalt	0.95	Oil	0.94
Brass*	0.50	Paint	0.93
Ceramic	0.95	Plastic**	0.95
Concrete	0.95	Rubber	0.95
Copper*	0.60	Sand	0.90
Food-Frozen	0.90	Steel*	0.80
Food-Hot	0.93	Water	0.93
		Wood	0.94
* Oxidized ** Opaque, over 20 mils *** Natural **** Factory Setting			

## **Specifications**

Temperature Range	-30 °C to +600 °C
Accuracy (Calibration geometry with ambient temperature 23 °C ±2 °C)	≥0 °C: ±1 °C or ±1 % of reading, whichever is greater ≥ -10 °C to <0 °C: ±2 °C < -10 °C: ±3 °C
Response Time (95 %)	<500 ms (95 % of reading)
Spectral Response	8 microns to 14 microns
Emissivity	0.10 to 1.00
Temperature Coefficient	±0.1 °C/°C or ±0.1 %/°C of reading (whichever is greater)
Optical Resolution	20:1 (calculated at 90 % energy)
Display Resolution	0.1 °C
Repeatability (% of reading)	±0.5 % of reading or ±0.5 °C, whichever is greater
Power	1 AA IEC LR06 Battery
Battery Life	30 hours with laser and backlight on

## IR Thermometer Specifications

Weight	255 g
Size	175 x 85 x 75 mm
Operating Temperature	0 °C to 50 °C
Storage Temperature	-20 °C to +60 °C, (without battery)
Operating Humidity	Non Condensing ( $\leq 10$ °C) $\leq 90$ % RH (at 10 °C to 30 °C) $\leq 75$ % RH (at 30 °C to 40 °C) $\leq 45$ % RH (at 40 °C to 50 °C)
Operating Altitude	2000 meters above mean sea level
Storage Altitude	12 000 meters above mean sea level

### Safety

General	IEC 61010-1: Pollution Degree 2
Laser	IEC 60825-1: Class 2, 650 nm, <1 mW
Ingress Protection	IEC 60529: IP54

## 64 Max

### Instructions

---

#### **Electromagnetic Compatibility**

International ..... IEC 61326-1: Portable; IEC 61326-2-2; CISPR 11: Group 1, Class A

*Group 1: Equipment has intentionally generated and/or uses conductively-coupled radio frequency energy that is necessary for the internal function of the equipment itself.*

*Class A: Equipment is suitable for use in all establishments other than domestic and those directly connected to a low-voltage power supply network that supplies buildings used for domestic purposes. There may be potential difficulties in ensuring electromagnetic compatibility in other environments due to conducted and radiated disturbances.*

*Caution: This equipment is not intended for use in residential environments and may not provide adequate protection to radio reception in such environments.*

Korea (KCC) ..... Class A Equipment (Industrial Broadcasting & Communication Equipment)

*Class A: Equipment meets requirements for industrial electromagnetic wave equipment and the seller or user should take notice of it. This equipment is intended for use in business environments and not to be used in homes.*

USA (FCC) ..... 47 CFR 15 subpart B. This product is considered an exempt device per clause 15.103.



## Overview

To turn on the Product, pull the trigger.

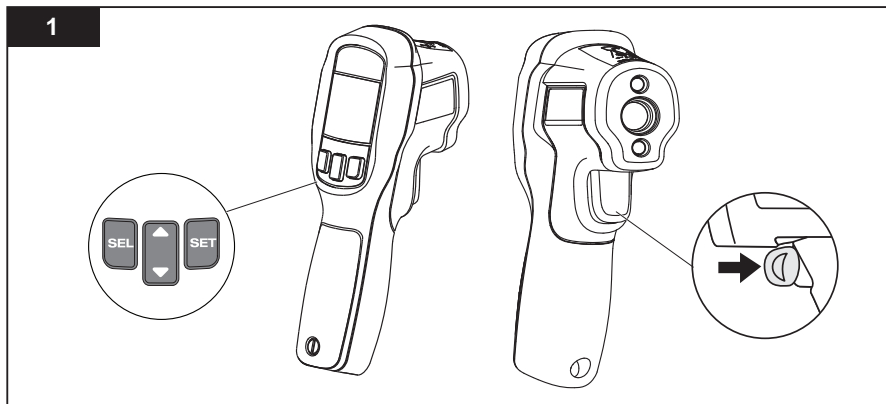

iba02.eps

# 64 Max

## Instructions

2

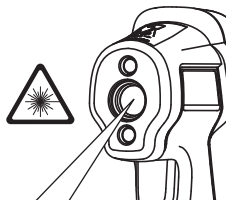

A dark grey safety label with white text and symbols. It includes a general warning triangle, a laser warning triangle, the text "LASER 2", a prohibition symbol for laser use, and an information icon. Below these are technical specifications and regulatory marks.

$\lambda = 650 \text{ nm}, <1\text{mW}, \text{IEC/EN } 60825\text{-}1$   
 $\text{and } 21 \text{ CFR } 1040.10, 1040.11$

CE, RoHS, and WEEE symbols are also present.

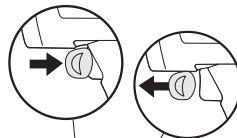

A digital LCD display showing various status indicators and numerical values. The display is divided into several sections:

- Top row: **HI** (with a battery icon), **SCAN**, **EMS** (with a value of **8.88**).
- Second row: **LO** (with a battery icon), **HOLD** (with a battery icon), **8.88**.
- Third row: **TRIG** (with a lock icon), **888.8** (with a temperature icon), **°C**.
- Fourth row: **AUTO**, **CAPTURE**, **ALARM**, **MEM**, **MAX**, **MIN**, **DATE**, **TIME**, **DIFF**, **AVG**.
- Fifth row: **REC**, **INTERVAL**.
- Sixth row: **88** (with a sun icon), **88:88** (with a clock icon), **am**.
- Seventh row: **88-88-88**, **88:88** (with a clock icon), **pm**.

iba01.eps



# 64 Max

## Instructions

**7**

**8**

**9**

**Max/Min/Avg/Diff**

Setting	Value (°F)
MAX	90
MIN	68
AVG	76
DIFF	22

iba15.eps

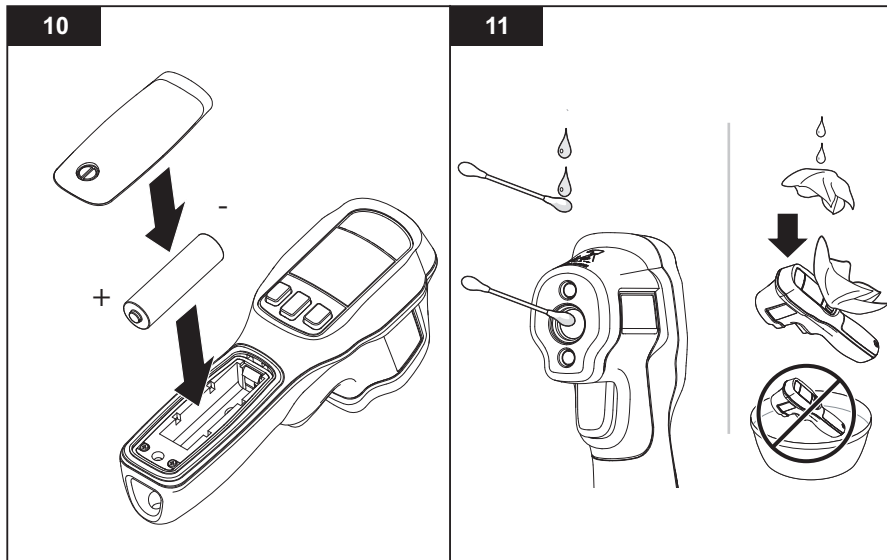

gtt13.eps

## 64 Max Instructions

12

D:S = 20:1

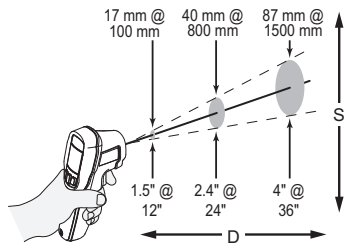

13

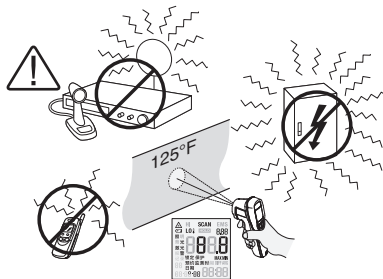

iba17.eps

14

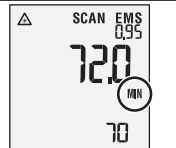
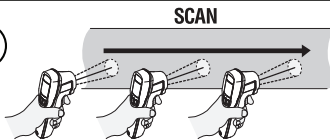
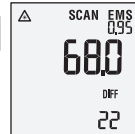
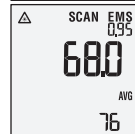
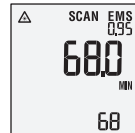
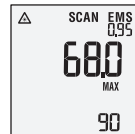
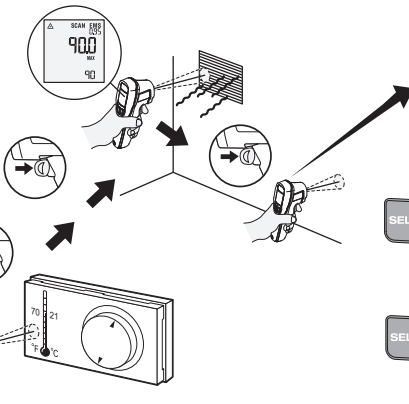
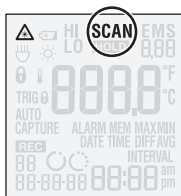

15

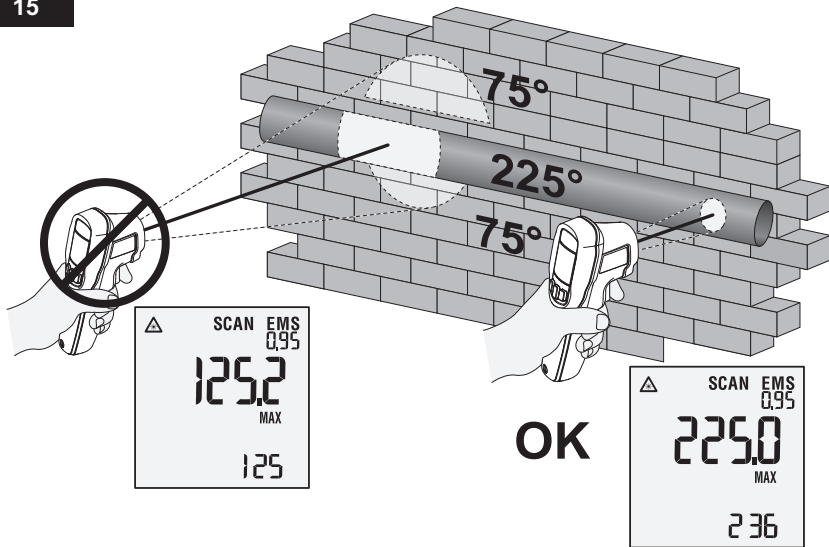

gtt04.eps