

FLUKE®

700G Series

Pressure Gauge

Users Manual

LIMITED WARRANTY AND LIMITATION OF LIABILITY

This Fluke product will be free from defects in material and workmanship for three years from the date of purchase. This warranty does not cover fuses, disposable batteries, or damage from accident, neglect, misuse, alteration, contamination, or abnormal conditions of operation or handling. Resellers are not authorized to extend any other warranty on Fluke's behalf. To obtain service during the warranty period, contact your nearest Fluke authorized service center to obtain return authorization information, then send the product to that Service Center with a description of the problem.

THIS WARRANTY IS YOUR ONLY REMEDY. NO OTHER WARRANTIES, SUCH AS FITNESS FOR A PARTICULAR PURPOSE, ARE EXPRESSED OR IMPLIED. FLUKE IS NOT LIABLE FOR ANY SPECIAL, INDIRECT, INCIDENTAL OR CONSEQUENTIAL DAMAGES OR LOSSES, ARISING FROM ANY CAUSE OR THEORY. Since some states or countries do not allow the exclusion or limitation of an implied warranty or of incidental or consequential damages, this limitation of liability may not apply to you.

Fluke Corporation
P.O. Box 9090
Everett, WA 98206-9090
U.S.A.

Fluke Europe B.V.
P.O. Box 1186
5602 BD Eindhoven
The Netherlands

Table of Contents

Title	Page
Introduction	1
How to Contact Fluke	1
Standard Equipment.....	2
Safety Information	2
Hazard Location Information/Approvals.....	3
Special Conditions for Safe Use	3
Symbols.....	4
Display and Buttons	5
Operation	6
How to Setup the Product.....	6
Engineering Units	6
Set Auto Off	7
Show Battery Voltage	7
Display Actual Temperature	7

Set Damping	7
Set Sample Rate	7
Set TARE	7
Function Lock	8
Supervisory Mode	8
Available Pressure Ranges	8
How to Set a Custom Engineering Unit or Scale	9
Battery Life	9
Maintenance	9
How to Clean the Product	9
How to Change the Batteries	10
Accessories	11
RS-232 Interface	11
Specifications	12
Available Input Ranges	12
Accuracy	12
Media Compatibility	12
Environmental	12
Mechanical Specifications	13
PI Ranges and Resolution	14

List of Tables

Table	Title	Page
1.	Symbols.....	4
2.	Display and Buttons	5

List of Figures

Figure	Title	Page
1.	The Product.....	5
2.	Change the Batteries.....	10

Introduction

The 700G Series Pressure Gauges (the Product) are high-accuracy digital pressure test gauges. Accurate to 0.05 % FS, the Products can be used as a calibration reference, or in any application where high-accuracy pressure measurement is required.

The Product features user-configurable functions that include:

- Sampling rate
- Tare
- Damping
- Auto off
- Min Max

When the Product is configured, you can lock its settings and use password protection to prevent configuration changes.

How to Contact Fluke

To contact Fluke, call one of the following telephone numbers:

- Technical Support USA: 1-800-44-FLUKE (1-800-443-5853)
- Calibration/Repair USA: 1-888-99-FLUKE (1-888-993-5853)
- Canada: 1-800-36-FLUKE (1-800-363-5853)
- Europe: +31 402-675-200
- Japan: +81-3-6714-3114
- Singapore: +65-738-5655
- Anywhere in the world: +1-425-446-5500

Or, visit Fluke's website at www.fluke.com.

To register your product, visit <http://register.fluke.com>.

To view, print, or download the latest manual supplement, visit <http://us.fluke.com/usen/support/manuals>.

Standard Equipment

The Product ships with:

- Protective Cover
- Three AA Batteries (installed)
- NPT/metric Adapter

Safety Information

A **Warning** identifies conditions and procedures that are dangerous to the user. A **Caution** identifies conditions and procedures that can cause damage to the Product or the equipment under test.

⚠⚠ Warning

To prevent possible electrical shock, fire, or personal injury:

- **Use the Product only as specified, or the protection supplied by the Product can be compromised.**
- **The battery door must be closed and locked before you operate the Product.**
- **Replace the batteries when the low battery indicator (🔋) shows to prevent incorrect measurements.**
- **Do not use and disable the Product if it is damaged.**

- **Read all safety Information before you use the Product.**
- **Do not use the Product in damp or wet environments.**

⚠ Caution

To avoid possible damage to Product or to equipment under test:

- **If the display reads “OL” the range limit is exceeded and the pressure source must immediately be removed.**
- **Do not exceed the maximum torque allowed. Maximum torque allowed is 13,5 Nm = 10 ftlbs.**

Hazard Location Information/Approvals

Ex Hazardous Areas

An Ex-hazardous area as used in this manual refers to an area made hazardous by the potential presence of flammable or explosive vapors. These areas are also referred to as hazardous locations, see NFPA 70 Article 500.



® LR110460
Class I, Div. 2, Groups A-D



II 3 G Ex nA IIB T6
KEMA 06ATEX0014 X
Ta=-10 °C... +55 °C

Special Conditions for Safe Use

Misuse

If the Product is exposed to overpressure or sudden physical shock (such as being dropped) examine it for any damage that can cause a safety concern. If necessary, return the Product for evaluation to Fluke. Refer to the How to Contact Fluke section.

⚠ Warning









To prevent possible fire, or personal injury:

- **Do not use the Product with flammable substances.**
- **The Product is intended for installation only in locations providing adequate protection against the entry of solid foreign objects or water capable of impairing safety.**

Symbols

Symbols used on the Product and in this manual are explained in Table 1.

Table 1. Symbols

Symbol	Meaning	Symbol	Meaning
	Risk of danger. Important information. See manual.		Conforms to European Union directives.
	Hazardous voltage. Risk of electrical shock.		Conforms to relevant North American Safety Standards.
	Pressure		Do not dispose of this product as unsorted municipal waste. Go to Fluke's website for recycling information.
	Conforms to relevant Australian standards.		Conforms to ATEX requirements

Display and Buttons

The Display and Buttons are shown in Figure 1. The Buttons are explained in Table 2.

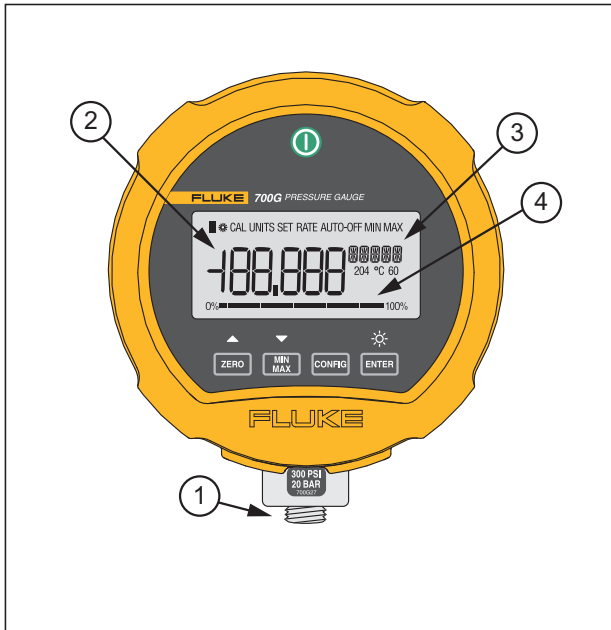



gsn001.eps

Figure 1. The Product

Table 2. Display and Buttons

Item	Function
	Push to turn the Product on. Push again to turn it off.
	Zeros the display. In Configure Mode, push the button to move forward through the menus.
	<p>MIN MAX records minimum and maximum pressure values and saves them in memory. Push to show maximum (MAX) indication. Push again to show minimum (MIN) indication. After 2 seconds, the gauge goes back to live operation.</p> <p>To clear the MIN MAX memory values, push and hold for 2 seconds until CLR is shown.</p> <p>In Configure Mode, push (▼) to move backward through the menus.</p>

Table 2. Display and Buttons (Cont)

Item	Function
	Push to go to setup and configuration menus.
	Push to make a selection. When the Product is not in Configuration mode, push to turn on the backlight. Push again to turn off the backlight.
①	NPT Connector
②	Pressure Display
③	Engineering Units
④	Bargraph

Operation

The subsequent sections tell you how to operate the Product. Push ① to turn on the Product.



The analog bar graph at the bottom of the display shows the applied-pressure level relative to the full range of the gauge.

Note



If you record a Tare value, the pressure shown is not the actual pressure applied.

How to Setup the Product

Before you use the product, it is necessary to configure it for your application. Push  to go to the Setup menu.

Each time  is pushed, the display goes to the subsequent function. Push ▲ or ▼ to change the parameter value. When a parameter is set, push  to exit the configuration menu or  to move to the next parameter.

Engineering Units

The Product's default engineering unit shows psi. To change this, push ▲ and ▼ to move through the 23 standard engineering units plus one custom unit/scale. When the necessary unit shows, push  or . Pressure now shows in the chosen engineering units. See the Specifications section for a list of available engineering units. See the Supervisory Mode section for instructions to set up custom units.

Set Auto Off

Auto Off can be set in 1-minute increments from 1 to 30 minutes or you can turn off the function for continuous Product operation. The Product is configured for 30 minutes. Push ▲ and ▼ to set the necessary interval. The “off” position is at the low end of the selections, less than 1 minute.

Show Battery Voltage

Actual battery voltage and a percent-of-life bargraph show the battery charge. No adjustments are made in this parameter.

Display Actual Temperature

The Product is temperature compensated This parameter shows the temperature measured by the internal sensor. Push ▲ or ▼ to show degrees F or C.

Set Damping

Selections are “on” ▲ and “off” ▼. Damping smooths readings from pulsating pressure sources.

Set Sample Rate

This function finds how often pressure is sampled and the display is updated. Selections are 0.5, 1, 3, and 10 samples/second. Note that 10/second gives the fastest response time.

Set Tare

Use this function to set a constant offset value which is then subtracted from the measured pressure. For example, if a tare is set at 30 psi, and the measured pressure is 37 psi, 7 psi is shown.

A pressure of 27 psi is shown as -3 psi.

Push ▲ and ▼ to set the tare value. The value, is based on the engineering units and resolution selected for display. Tare value can be set to the maximum range of the gauge.

For safety, the bar graph always shows the actual pressure based on the full range of the gauge regardless of the tare position. This is done to make sure that even with a “0” reading pressure is being applied to the gauge.

Function Lock

When set, access to each of the settable parameters above can be turned “off” to prevent unauthorized configuration changes. This is done with password protection in Supervisory mode. Push **ENTER** to access Supervisory mode or **CONFIG** to go back to normal operation.

Supervisory Mode

If necessary, each user-configurable parameter can be edited when you receive the Product. Some parameters are locked and must be unlocked to configure them. Use Supervisory mode to do this.

When you are in the Configure menu, and **FUnC LOCK** is shown, it means that there are locked parameters.

To disable function lock:

1. Push **▼** **ENTER** . **0 PWRD** is then shown.
2. The password “101” is required to unlock Supervisory mode. Push **▲** to put in the password entry. Hold **▲** or **▼** down to move faster through the selections by a factor of 10. When you stop the counter, push **▲** and **▼** again to move forward or backward by a factor of 1. The password is factory set and cannot be changed.
3. Push **ENTER** .

From this point each parameter can be locked or unlocked. Push **▲** and **▼** to select **UnLOC** or **LOC** for

each parameter. To move to the next parameter, push **CONFIG** .

You can access, lock, or unlock these functions:

- Zero function (enable/disable)
- Set pressure units (enable/disable)
- Auto shutdown adjustment (enable/disable)
- Damping settings (enable/disable)
- Sample rate setting (enable/disable)
- Tare setting (enable/disable)
- Custom engineering units (set scale factor)

When a function is locked, it cannot be accessed or changed from its current condition until you go to Supervisory Mode and unlock it.

Available Pressure Ranges

Available pressure ranges are listed in the Specifications section.

How to Set a Custom Engineering Unit or Scale

The last menu selection in Supervisory mode is **SET FACTR**. You can set a multiplier factor from 0.001 to 100 to make a custom scale. The set factor is multiplied by the psi measured and the result is shown.

Example: 40 psi is the equivalent of 1000 lbs of product in a tank. You want to show the product weight with a 100 psi gauge. If you set a factor of 25, 40 psi pressure would show as 1000 (40 x 25). The engineering unit shown is **Cust** (custom).

Battery Life

Battery life is approximately 1500 hours (60 days) of continuous operation with the backlight off. With intermittent operation, batteries could last a year or more. When the battery voltage is low, the low-battery icon (🔋) shows on the top left of the display. To replace the batteries, see the How to Change the Batteries section.

Maintenance

How to Clean the Product

Clean the Product with a soft cloth dampened with water or water and weak soap.

⚠ Caution

To prevent possible damage to the Product, do not use solvents or abrasive cleansers.

⚠ Caution

For safe operation and maintenance of the product:

- **Repair the Product before use if the battery leaks.**
- **Remove batteries to prevent battery leakage and damage to the Product if it is not used for an extended period.**
- **Be sure that the battery polarity is correct to prevent battery leakage.**
- **Have an approved technician repair the Product.**

How to Change the Batteries

⚠⚠ Warning

To prevent possible electrical shock, fire, or personal injury, batteries must only be changed in an area known to be non-hazardous. Explosion hazard.

To change the batteries, see Figure 2:

1. Use a Phillips screwdriver to loosen the captive screw on the battery door.
2. Remove the battery door.
3. Replace the three AA batteries.
4. Install the battery door again.
5. Tighten the captive screw.

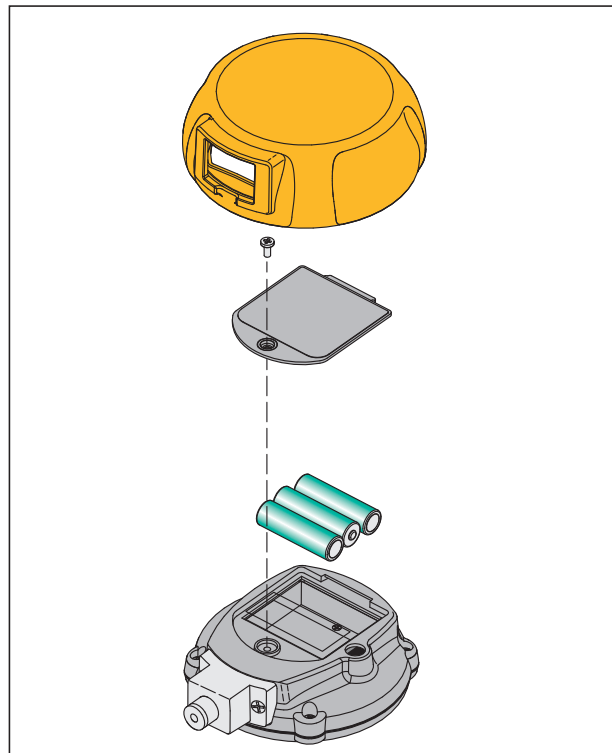

gsn002.eps

Figure 2. Change the Batteries

Accessories

RS-232 Interface

The Product includes an RS-232 interface. Remove the Product holster and the input jack is on the back of the Product. You can use serial communication to configure and calibrate the Product and move measurement data from the Product to a PC. An RS-232/USB cable is sold separately and includes *700G/TRACK Software*. For specifications on the interface, see the Specifications section.

Warning

To prevent possible electrical shock, fire, or personal injury, do not use the RS-232 interface in hazardous areas.

Specifications

Available Input Ranges

See PI Ranges and Resolution for available ranges in psi plus equivalent ranges and resolution for all engineering units.

Accuracy



Positive Pressure.....	±0.05 % FS
Vacuum	±0.1 % FS
Temperature Compensation	15 °C to 35 °C (59 °F to 95 °F) to rated accuracy

Note: For temperatures from -10 °C to 15 °C and 35 °C to 55 °C, add .003 % FS/°C

Media Compatibility

15, 30 psi	any clean dry non-corrosive gas
100, 300, 1000 psi	any liquids or gases compatible with 316 stainless steel
Above 1000 psi	any non-flammable, non-toxic, non-explosive, non-oxidizing liquid or gas compatible with 316 stainless steel.

Environmental

Operating Temperature	-10 °C to +55 °C (14 °F to 131 °F)
Storage	-20 °C to +70 °C (-4 °F to +158 °F)
Humidity	10 % to 95 % RH Non-condensing
Pollution Degree	2
Agency Approvals.....	CE,  ,  , 

Mechanical Specifications

Dimensions 11.4 x 12.7 (cm), depth = 3.7 cm
(4.5 x 5 (in), depth= 1.5 in)

Pressure

Connection ¼ in NPT Male
Housing Cast ZNAl

Display

5-1/2 Digits, 16.53 mm (0.65 in) high
20-Segment bar graph, 0 to 100 %

Power

Battery three size AA alkaline batteries
Battery Life 1,500 hours without backlight (continuous on),
2,000 hours at slow sample rate

PI Ranges and Resolution

Model Number		700G04	700G05	700G06	700G27	700G07	700G08	700G29	700G30	700G31
Pressure Range		15	30	100	300	500	1000	3000	5000	10000
Vacuum Range		-14	-14	-12	-12	-12	-14	-14	-14	-14
Burst Pressure		500	500	1000	2000	2000	10000	10000	10000	15000
Proof Pressure		60	60	200	600	1000	2000	6000	10000	15000
Engineering Unit	Factor									
psi	1	15.000	30.000	100.00	300.00	500.00	1000.0	3000.0	5000.0	10000
bar	0.06894757	1.0342	2.0684	6.8948	20.684	34.474	68.948	206.84	344.74	689.48
mbar	68.94757	1034.2	2068.4	6894.8	20684	34474	68948	*	*	*
kPa	6.894757	103.42	206.84	689.48	2068.4	3447.4	6894.8	20684	34474	68948
Mpa	0.006894757	0.1034	0.2068	0.6895	2.0684	3.4474	6.8948	20.684	34.474	68.948

**Pressure Gauge
Specifications**

kg/cm2	0.07030697	1.0546	2.1092	7.0307	21.092	35.153	70.307	210.92	351.53	703.07
mmHg @ 0°C	51.71507	775.73	1551.5	5171.5	15515	25858	51715	*	*	*
inHg @ 0°C	2.03603	30.540	61.081	203.60	610.81	1018.0	2036.0	6108.1	10180	20360
cmH2O @ 4°C	70.3089	1054.6	2109.3	7030.9	21093	35154	70309	*	*	*
cmH2O @ 20°C	70.4336	1056.5	2113.0	7043.4	21130	35217	70434	*	*	*
mmH2O @ 4°C	703.089	10546	21093	70309	*	*	*	*	*	*
mmH2O @ 20°C	704.336	10565	21130	70434	*	*	*	*	*	*
mH2O @ 4°C	0.703089	10.546	21.093	70.309	210.93	351.54	703.09	2109.3	3515.4	7030.9
mH2O @ 20°C	0.704336	10.565	21.130	70.434	211.30	352.17	704.34	2113.0	3521.7	7043.4
inH2O @ 4°C	27.68067	415.21	830.42	2768.1	8304.2	13840	27681	83042	*	*
inH2O @ 20°C	27.72977	415.95	831.89	2773.0	8318.9	13865	27730	83189	*	*
inH2O @ 60°F	27.70759	415.61	831.23	2770.8	8312.3	13854	27708	83123	*	*

700G Series
Users Manual

ftH ₂ O @ 4°C	2.306726	34.601	69.202	230.67	692.02	1153.4	2306.7	6920.2	11534	23067
ftH ₂ O @ 20°C	2.310814	34.662	69.324	231.08	693.24	1155.4	2310.8	6932.4	11554	23108
ftH ₂ O @ 60°F	2.308966	34.634	69.269	230.90	692.69	1154.5	2309.0	6926.9	11545	23090
ft Sea Water	2.24719101	33.708	67.416	224.72	674.16	1123.6	2247.2	6741.6	11236	22472
m Sea Water	0.68494382	10.274	20.548	68.494	205.48	342.47	684.94	2054.8	3424.7	6849.4
Torr	51.71507	775.73	1551.5	5171.5	15515	25858	51715	*	*	*