

789/787B

ProcessMeter™

Calibration Manual

LIMITED WARRANTY AND LIMITATION OF LIABILITY

Each Fluke product is warranted to be free from defects in material and workmanship under normal use and service. The warranty period is three years and begins on the date of shipment. Parts, product repairs, and services are warranted for 90 days. This warranty extends only to the original buyer or end-user customer of a Fluke authorized reseller, and does not apply to fuses, disposable batteries, or to any product which, in Fluke's opinion, has been misused, altered, neglected, contaminated, or damaged by accident or abnormal conditions of operation or handling. Fluke warrants that software will operate substantially in accordance with its functional specifications for 90 days and that it has been properly recorded on non-defective media. Fluke does not warrant that software will be error free or operate without interruption.

Fluke authorized resellers shall extend this warranty on new and unused products to end-user customers only but have no authority to extend a greater or different warranty on behalf of Fluke. Warranty support is available only if product is purchased through a Fluke authorized sales outlet or Buyer has paid the applicable international price. Fluke reserves the right to invoice Buyer for importation costs of repair/replacement parts when product purchased in one country is submitted for repair in another country.

Fluke's warranty obligation is limited, at Fluke's option, to refund of the purchase price, free of charge repair, or replacement of a defective product which is returned to a Fluke authorized service center within the warranty period.

To obtain warranty service, contact your nearest Fluke authorized service center to obtain return authorization information, then send the product to that service center, with a description of the difficulty, postage and insurance prepaid (FOB Destination). Fluke assumes no risk for damage in transit. Following warranty repair, the product will be returned to Buyer, transportation prepaid (FOB Destination). If Fluke determines that failure was caused by neglect, misuse, contamination, alteration, accident, or abnormal condition of operation or handling, including overvoltage failures caused by use outside the product's specified rating, or normal wear and tear of mechanical components, Fluke will provide an estimate of repair costs and obtain authorization before commencing the work. Following repair, the product will be returned to the Buyer transportation prepaid and the Buyer will be billed for the repair and return transportation charges (FOB Shipping Point).

THIS WARRANTY IS BUYER'S SOLE AND EXCLUSIVE REMEDY AND IS IN LIEU OF ALL OTHER WARRANTIES, EXPRESS OR IMPLIED, INCLUDING BUT NOT LIMITED TO ANY IMPLIED WARRANTY OF MERCHANTABILITY OR FITNESS FOR A PARTICULAR PURPOSE. FLUKE SHALL NOT BE LIABLE FOR ANY SPECIAL, INDIRECT, INCIDENTAL OR CONSEQUENTIAL DAMAGES OR LOSSES, INCLUDING LOSS OF DATA, ARISING FROM ANY CAUSE OR THEORY.

Since some countries or states do not allow limitation of the term of an implied warranty, or exclusion or limitation of incidental or consequential damages, the limitations and exclusions of this warranty may not apply to every buyer. If any provision of this Warranty is held invalid or unenforceable by a court or other decision-maker of competent jurisdiction, such holding will not affect the validity or enforceability of any other provision.

Fluke Corporation
P.O. Box 9090
Everett, WA 98206-9090
U.S.A.

Fluke Europe B.V.
P.O. Box 1186
5602 BD Eindhoven
The Netherlands

Table of Contents

Title	Page
Introduction	1
How to Contact Fluke	1
Safety Information	2
Specifications	5
Required Equipment	9
Basic Maintenance	10
How to Clean	10
Battery Replacement	10
Battery Life	11
Check and Replace Fuses	12
Performance Verification	12
Preparation	13
Loop Power Test (789 only)	14
Current Sourcing Test	15
Current Measurement Test	16
Diode Function Test	17
Continuity Function Test	19
Resistance Measurement Test	20
DC Millivolts Measurement Test	22
DC Volts Measurement Tests	23
AC Volts Measurement Test	24
Frequency Measurement Test	25
Calibration Adjustment	26
Preparation	26
Procedure for Models with Firmware Version <2.0	27
AC Voltage Adjustment	27
Frequency Adjustment	28
DC Voltage Adjustment	29
DC Millivolts Adjustment	29
Ohms Adjustment	30
Diode Adjustment	30
Milliamps DC Adjustment	31
Amps DC Adjustment	31
Amps AC Adjustment	32
Milliamps Output Adjustment	32
Procedure for Models with Firmware Version ≥ 2.0	33
Calibration Adjustment Counter	33
Calibration Adjustment Password	33
How to Change the Password	33

How to Restore the Default Password	35
Meter Keys Used in the Calibration Steps	36
Calibration Adjustment	36
Replacement Parts and Accessories	38

Introduction

⚠⚠ Warning

The information provided in this manual is for the use of qualified personnel only. Do not perform the calibration verification tests or calibration procedures described in this manual unless you are qualified to do so.

⚠ Caution

The ProcessMeter™ contains parts that can be damaged by static discharge. Follow the standard practices for handling static sensitive devices.

The *Calibration Manual* for the 789/787B ProcessMeter (Meter, Product, or UUT) provides the following information:

- Precautions and Safety information
- Specifications
- Basic maintenance (cleaning, replacing the batteries and fuses)
- Calibration verification test procedures
- Calibration adjustment procedures
- Accessories and replaceable parts

All illustrations in this manual show the 789. For complete operating instructions, refer to the *789/787B ProcessMeter Users Manual* (provided on CD-ROM with the Product).

How to Contact Fluke

To contact Fluke, call one of the following telephone numbers:

- Technical Support USA: 1-800-44-FLUKE (1-800-443-5853)
- Calibration/Repair USA: 1-888-99-FLUKE (1-888-993-5853)
- Canada: 1-800-36-FLUKE (1-800-363-5853)
- Europe: +31 402-675-200
- Japan: +81-3-6714-3114
- Singapore: +65-6799-5566
- Anywhere in the world: +1-425-446-5500

Or, visit Fluke's website at www.fluke.com.

To register your product, visit <http://register.fluke.com>.

To view, print, or download the latest manual supplement, visit <http://us.fluke.com/usen/support/manuals>.

Safety Information

A **Warning** identifies conditions and procedures that are dangerous to the user. A **Caution** identifies conditions and procedures that can cause damage to the Product or the equipment under test.

International symbols used on the Meter and in this manual are explained in Table 1.

Warning

To prevent possible electrical shock, fire, or personal injury:

- Read all safety information before you use the Product.
- Carefully read all instructions.
- Do not alter the Product and use only as specified, or the protection supplied by the Product can be compromised.
- Remove the batteries if the Product is not used for an extended period of time, or if stored in temperatures above 50 °C. If the batteries are not removed, battery leakage can damage the Product.
- The battery door must be closed and locked before you operate the Product.
- Replace the batteries when the low battery indicator shows to prevent incorrect measurements.
- Comply with local and national safety codes. Use personal protective equipment (approved rubber gloves, face protection, and flame-resistant clothes) to prevent shock and arc blast injury where hazardous live conductors are exposed.
- Do not apply more than the rated voltage, between the terminals or between each terminal and earth ground.
- Do not work alone.
- Limit operation to the specified measurement category, voltage, or amperage ratings.
- Use Product-approved measurement category (CAT), voltage, and amperage rated accessories (probes, test leads, and adapters) for all measurements.
- Measure a known voltage first to make sure that the Product operates correctly.
- Use the correct terminals, function, and range for measurements.
- Do not touch voltages >30 V ac rms, 42 V ac peak, or 60 V dc.
- Do not use the Product around explosive gas, vapor, or in damp or wet environments.
- Do not use the Product if it operates incorrectly.
- Examine the case before you use the Product. Look for cracks or missing plastic. Carefully look at the insulation around the terminals.
- Do not use test leads if they are damaged. Examine the test leads for damaged insulation, exposed metal, or if the wear indicator shows. Check test lead continuity.
- Keep fingers behind the finger guards on the probes.
- Only use probes, test leads, and accessories that have the same measurement category, voltage, and amperage ratings as the Product.















- Remove all probes, test leads, and accessories before the battery door is opened.
- Remove all probes, test leads, and accessories that are not necessary for the measurement.
- Do not exceed the Measurement Category (CAT) rating of the lowest rated individual component of a Product, probe, or accessory.
- Do not use test leads if they are damaged. Examine the test leads for damaged insulation and measure a known voltage.
- Do not use a current measurement as an indication that a circuit is safe to touch. A voltage measurement is necessary to know if a circuit is hazardous.
- Do not use the Product if it is altered or damaged.
- Do not use in CAT III or CAT IV environments without the protective cap installed on test probes. The protective cap decreases the exposed probe metal to <4 mm. This decreases the possibility of arc flash from short circuits.

⚠ Caution

To prevent damage to the Product or the test equipment:

- Disconnect the power and discharge all high voltage capacitors before testing resistance, diodes, or continuity.
- Use the proper terminals, switch setting, and range for the measurement or sourcing applications.

Table 1. International Symbols

Symbol	Description	Symbol	Description
	WARNING. RISK OF DANGER.		WARNING. HAZARDOUS VOLTAGE. Risk of electric shock.
	Consult user documentation.		Conforms to relevant South Korean EMC Standards
	Conforms to European Union directives	IR	Minimum fuse interrupt rating.
	Certified by CSA Group to North American safety standards.		Conforms to relevant Australian Safety and EMC standards.
	AC (Alternating Current)		Earth
	DC (Direct Current)		Fuse
	Battery		Double Insulated
CAT II	Measurement Category II is applicable to test and measuring circuits connected directly to utilization points (socket outlets and similar points) of the low-voltage MAINS installation.		
CAT III	Measurement Category III is applicable to test and measuring circuits connected to the distribution part of the building's low-voltage MAINS installation.		
CAT IV	Measurement Category IV is applicable to test and measuring circuits connected at the source of the building's low-voltage MAINS installation.		
	This product complies with the WEEE Directive marking requirements. The affixed label indicates that you must not discard this electrical/electronic product in domestic household waste. Product Category: With reference to the equipment types in the WEEE Directive Annex I, this product is classed as category 9 "Monitoring and Control Instrumentation" product. Do not dispose of this product as unsorted municipal waste.		

Specifications

- All specifications apply from +18 °C to +28 °C unless stated otherwise.
- All specifications assume a 5-minute warm-up period.
- The standard specification interval is 1 year.

Note

“Counts” refers to the number of increments or decrements of the least significant digit.

DC Volts Measurement

Range (V dc)	Resolution	Accuracy, ±(% of Reading + Counts)
4.000	0.001 V	0.1 % + 1
40.00	0.01 V	0.1 % + 1
400.0	0.1 V	0.1 % + 1
1000	1 V	0.1 % + 1

Input impedance: 10 MΩ (nominal), <100 pF
Normal mode rejection ratio: >60 dB at 50 Hz or 60 Hz
Common mode rejection ratio: >120 dB at dc, 50 Hz, or 60 Hz
Overvoltage protection: 1000 V

DC Millivolts Measurement

Range (mV dc)	Resolution	Accuracy, ±(% of Reading + Counts)
400.0	0.1 mV	0.1 % + 2

AC Volts Measurement

Range (ac)	Resolution	Accuracy, ±(% of Reading + Counts)		
		50 Hz to 60 Hz	45 Hz to 200 Hz	200 Hz to 500 Hz
400.0 mV	0.1 mV	0.7 % + 4	1.2 % + 4	7.0 % + 4
4.000 V	0.001 V	0.7 % + 2	1.2 % + 4	7.0 % + 4
40.00 V	0.01 V	0.7 % + 2	1.2 % + 4	7.0 % + 4
400.0 V	0.1 V	0.7 % + 2	1.2 % + 4	7.0 % + 4
1000 V	1 V	0.7 % + 2	1.2 % + 4	7.0 % + 4

Specifications are valid from 5 % to 100 % of amplitude range.
AC conversion: true rms
Maximum crest factor: 3 (between 50 and 60 Hz)
For non-sinusoidal waveforms, add ±(2 % reading + 2 % f.s.) typical
Input impedance: 10 MΩ (nominal), <100 pF, ac-coupled
Common mode rejection ratio: >60 dB at dc, 50 Hz, or 60 Hz

AC Current Measurement

Range 45 Hz to 2 kHz	Resolution	Accuracy, ±(% of Reading + Counts)	Typical Burden Voltage
1.000 A (Note)	0.001 A	1 % + 2	1.5 V/A
<i>Note: 440 mA continuous, 1 A 30 seconds maximum</i>			
<i>Specifications are valid from 5 % to 100 % of amplitude range. AC conversion: true rms Maximum crest factor: 3 (between 50 and 60 Hz) For non-sinusoidal waveforms, add ±(2 % reading + 2 % f.s.) typical Overload protection 440 mA, 1000 V fast-blow fuse</i>			

DC Current Measurement

Range	Resolution	Accuracy ±(% of Reading + Counts)	Typical Burden Voltage
30.000 mA	0.001 mA	0.05 % + 2	14 mV/mA
1.000 A (Note)	0.001 A	0.2 % + 2	1.5 V/A
<i>Note: 440 mA continuous, 1 A 30 seconds maximum</i>			
<i>Overload protection: 440 mA, 1000 V fast-blow fuse</i>			

Ohms Measurement

Range	Resolution	Measurement Current	Accuracy ±(% of Reading + Counts)
400.0 Ω	0.1 Ω	310 μA	0.2 % + 2
4.000 kΩ	0.001 kΩ	31 μA	0.2 % + 1
40.00 kΩ	0.01 kΩ	2.5 μA	0.2 % + 1
400.0 kΩ	0.1 kΩ	250 nA	0.2 % + 1
4.000 MΩ	0.001 MΩ	250 nA	0.35 % + 3
40.00 MΩ	0.01 MΩ	125 nA	2.5 % + 3
<i>Overload protection: 1000 V Open circuit voltage: <3.9 V</i>			

Frequency Counter Accuracy

Range	Resolution	Accuracy ±(% of Reading + Counts)
199.99 Hz	0.01 Hz	0.005 % + 1
1999.9 Hz	0.1 Hz	0.005 % + 1
19.999 kHz	0.001 kHz	0.005 % + 1
<i>Display updates 3 times/second at >10 Hz</i>		

Frequency Counter Sensitivity

Input Range	Minimum Sensitivity (rms Sinewave) 5 Hz to 5 kHz*	
	AC	DC (approximate trigger level 5 % of full scale)
400 mV	150 mV (50 Hz to 5 kHz)	150 mV
4 V	1 V	1 V
40 V	4 V	4 V
400 V	40 V	40 V
1000 V	400 V	400 V

**Usable 0.5 Hz to 20 kHz with reduced sensitivity.
10⁶ VHz max*

Diode Test and Continuity Test

- Diode test indication Displays voltage drop across device, 2.0 V full scale. Nominal test current 0.3 mA at 0.6 V. Accuracy $\pm(2\% + 1 \text{ count})$.
- Continuity test indication Continuous audible tone for test resistance $<100 \Omega$
- Open circuit voltage 2.9 V
- Short circuit current 310 μA typical
- Overload protection 1000 V rms

Loop Power Supply Voltage 24 V, Short Circuit protected

DC Current Output

Source mode:

- Span 0 mA or 4 mA to 20 mA, with overrange to 24 mA
- Accuracy 0.05 % of span
- Compliance voltage 28 V with battery voltage $>4.5 \text{ V}$

Simulate Mode

- Span 0 mA or 4 mA to 20 mA, with overrange to 24 mA
- Accuracy 0.05 % of span
- Loop voltage 24 V nominal, 48 V maximum, 15 V minimum
- Compliance voltage 21 V for 24 V supply
- Burden voltage $<3 \text{ V}$

General Specifications

Maximum Voltage between any Terminal and Earth Ground	1000 V
Fuse Protection for mA inputs	0.44 A, 1000 V IR 10 kA
Power	
Battery Type	IEC LR6 (AA Alkaline)
Quantity	4
Temperature	
Operating	-20 °C to +55 °C
Storage	-40 °C to +60 °C
Altitude	
Operating	≤2000 m
Storage	≤12 000 m
Frequency Overload Protection	10 ⁶ V Hz max
Temperature coefficient	
Measurements	0.05 x specified accuracy per °C for temperatures <18 °C or >28 °C
Source	0.1 x specified accuracy per °C for temperatures <18 °C or >28 °C
Relative humidity	95 % up to 30 °C, 75 % up to 40 °C, 45 % up to 50 °C, and 35 % up to 55 °C
Vibration	Random 2g, 5 to 500 Hz
Shock	1 meter drop test
Size	10.0 cm X 20.3 cm X 5.0 cm (3.94 in X 8.00 in X 1.97 in)
Weight	610 g (1.6 lb)
Safety	
General	IEC 61010-1: Pollution Degree 2
Measurement	IEC 61010-2-033: CAT IV 600 V / CAT III 1000 V
Electromagnetic Compatibility (EMC)	Accuracy for all ProcessMeter functions is not specified in RF field >3 V/m
International	IEC 61326-1: Portable Electromagnetic Environment; IEC 61326-2-2 CISPR 11: Group 1, Class A
	<i>Group 1: Equipment has intentionally generated and/or uses conductively-coupled radio frequency energy that is necessary for the internal function of the equipment itself.</i>
	<i>Class A: Equipment is suitable for use in all establishments other than domestic and those directly connected to a low-voltage power supply network that supplies buildings used for domestic purposes. There may be potential difficulties in ensuring electromagnetic compatibility in other environments due to conducted and radiated disturbances.</i>
	<i>Caution: This equipment is not intended for use in residential environments and may not provide adequate protection to radio reception in such environments.</i>
	<i>Emissions that exceed the levels required by CISPR 11 can occur when the equipment is connected to a test object.</i>
Korea (KCC)	Class A Equipment (Industrial Broadcasting & Communication Equipment)
	<i>Class A: Equipment meets requirements for industrial electromagnetic wave equipment and the seller or user should take notice of it. This equipment is intended for use in business environments and not to be used in homes.</i>
USA (FCC)	47 CFR 15 subpart B. This product is considered an exempt device per clause 15.103.

Required Equipment

Equipment and software required to perform the procedures in this manual are identified in Table 2.

If the recommended equipment model is not available, in some cases other equipment can be substituted as long as it meets the specifications indicated.

⚠⚠ Warning

To avoid safety hazards and equipment damage during the calibration procedure, use the specified calibration equipment listed in Table 2. Using unspecified equipment can jeopardize the calibration verification test and pose safety hazards.

Note

Unless otherwise indicated, all connection diagrams for the calibration verification tests in this manual showing a calibrator or digital multimeter use a Fluke 5522A calibrator, Fluke 8508A Reference Multimeter, Keysight 3458A DMM, or equivalent.

If you are using a different calibrator or DMM, make the connections appropriate for that instrument.

Table 2. Required Equipment and Software

Equipment	Minimum Specifications	Recommended Model
Calibration Source	No Substitute	Fluke Model 5522A or equivalent
Digital Multimeter	No Substitute	Fluke 8508A, Keysight 3458A
Test Leads, low leakage, RG-58/U type	Leakage resistance > than $1.0 \times 10^{13} \Omega$ at 45 °C and 75 % relative humidity	Fluke 5440A-7002 Low Thermal Test Leads
1-k Ω shunt	1 k Ω , 1 %, 2 watts, Low TC is preferable	---

Basic Maintenance

How to Clean

⚠⚠ Warning

To prevent electrical shock or damage, never allow water inside the case of the ProcessMeter.

If the ProcessMeter requires cleaning, wipe it down with a cloth that is lightly dampened with water or a mild detergent.

⚠ Caution

Do not use aromatic hydrocarbons, chlorinated solvents, or methanol-based fluids when wiping down the ProcessMeter. To avoid damaging the case, never apply solvents to the case of the ProcessMeter.

Battery Replacement

⚠ Warning

For safe operation and maintenance, repair the Product before use if the battery leaks.

To replace the batteries, see Figure 1:

1. Remove the test leads and turn the Meter OFF.
2. With a standard blade hand screwdriver, turn each battery door screw counterclockwise so that the slot is parallel with the screw picture molded into the case.
3. Lift off the battery door.
4. Remove the batteries.
5. Replace with four new AA alkaline batteries.
6. Reinstall the battery door and tighten screws.

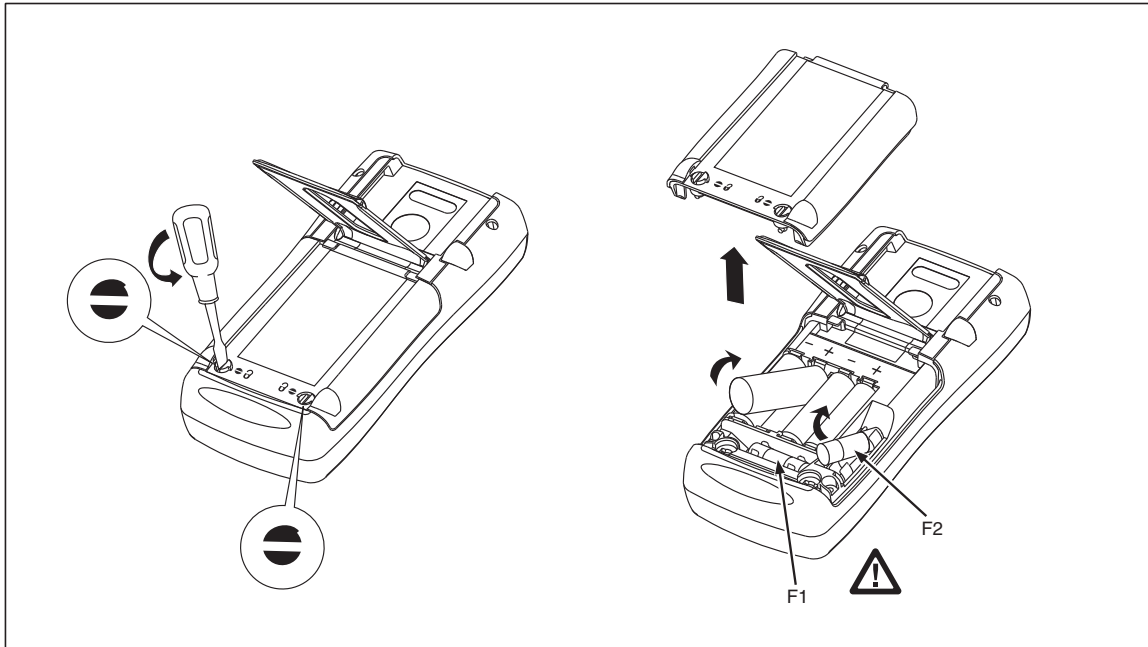

Figure 1. Replacing the Batteries and Fuses

anw037.eps

Battery Life

⚠⚠ Warning

To prevent possible electrical shock, fire, or personal injury, replace the batteries when the low battery indicator shows.

The ProcessMeter is powered by four AA alkaline batteries.

Table 3 shows typical alkaline battery life. To preserve battery life:

- Use current simulation instead of sourcing when possible.
- Avoid using the backlight.
- Do not disable the automatic power-off feature.
- Turn the ProcessMeter off when not in use.

Table 3. Typical Alkaline Battery Life

ProcessMeter Operation	Hours
Measuring any parameter	140
Simulating Current	140
Sourcing 12 mA into 500 Ω	10

Check and Replace Fuses

Warning

To prevent possible electrical shock, fire, or personal injury, use only the specified replacement fuses.

Both current input jacks are fused with separate 440 mA fuses. To determine if a fuse is blown:

1. Turn the rotary function switch to $\frac{mA}{A}$.
2. Plug the black test lead into COM, and the red test lead into the $A\approx$ input.
3. Using an ohmmeter, check the resistance between the ProcessMeter test leads. If the resistance is about 1 Ω , the fuse is good. An open reading means that fuse F2 is blown.
4. Move red test lead to $mA\approx$.
5. Using an ohmmeter, check the resistance between the ProcessMeter test leads. If the resistance is about 14 Ω , the fuse is good. An open means that fuse F1 is blown.

If a fuse is blown, replace it as follows. Refer to Figure 1 as necessary:

1. Remove the test leads from the ProcessMeter and turn the ProcessMeter OFF.
2. With a standard blade hand screwdriver, turn each battery compartment door screw counterclockwise so that the slot is parallel with the screw picture molded into the case.
3. Remove either fuse by gently prying one end loose, then sliding the fuse out of its bracket.
4. Replace the blown fuse(s).
5. Replace the battery compartment door. Secure the door by turning the screws one-quarter turn clockwise.

Performance Verification

Warning

To prevent electrical shock:

- **Only qualified personnel should perform calibration verification tests that use high voltages.**
- **Always place the calibrator in the Standby (STBY) mode between tests and before handling the test connections or test cables.**

Calibration verification tests confirm the complete functionality of the ProcessMeter and check the accuracy of each ProcessMeter function against its specifications. If the ProcessMeter fails any calibration verification test, it needs calibration adjustment or repair.

The ProcessMeter's performance and accuracy are specified for one year after calibration at operating temperatures of +18 °C to +28 °C (64 °F to 82 °F), in relative humidity to 90 %. The specifications assume the ProcessMeter has been warmed up for 5 minutes before use.

To perform the calibration verification tests, it is not necessary to open the case; no adjustments are necessary. Merely make the required connections, source the

designated values, and determine if the reading on the ProcessMeter or the multimeter falls within the acceptable range indicated.

These calibration verification test procedures assume that the person performing the tests has read the *789/787B Users Manual*, knows how to select functions and ranges on the ProcessMeter, and knows how to operate the required equipment.

Note

Calibration verification tests for the ProcessMeter can be performed manually, or they can be computer-automated (using Fluke's MET/CAL® Calibration Software). This document provides the procedures necessary to perform the calibration verification test manually.

Preparation

Note

Throughout the calibration verification tests, "UUT" (unit under test) refers to the ProcessMeter; the word "multimeter" is reserved for the digital multimeter identified in the required equipment listed in Table 2.

Unless otherwise indicated, all connection diagrams for the calibration verification tests in this manual showing a calibrator or digital multimeter use a Fluke 5522A calibrator or 8508A.

If using a different calibrator or DMM make the connections appropriate for your instrument.

To prepare the UUT for the calibration verification tests:

1. Make sure that the required equipment is available (see Table 2).
2. Make sure that the fuses in the UUT are intact. See "Checking and Replacing a Fuse" earlier in this manual.
3. Make sure the UUT has fresh batteries. See "Replacing the Batteries" earlier in this manual.
4. Warm up the calibrator and multimeter as required by their specifications.
5. Remove all input cables from the front of the UUT.
6. Make sure that the UUT is in a stable ambient temperature between 18 °C and 28 °C (64.4 °F and 82.4 °F) and that it has been warmed up for 5 minutes.

Loop Power Test (789 only)

1. Enable the dc volts autorange function of the multimeter.
2. Turn the rotary knob of the UUT to **LOOP POWER**.
3. Measure the open circuit voltage of the UUT and verify it is $>29.2\text{ V}$ and $<32\text{ V}$.
4. Press \bigcirc (BLUE) on the UUT to enable the $250\ \Omega$ HART resistor.
5. Repeat step 3.
6. Disable the $250\ \Omega$ HART resistor by pressing \bigcirc (BLUE).
7. Connect the $1\text{-k}\Omega$ shunt across **SOURCE +** and **SOURCE -** of the UUT.
8. Measure the loaded down voltage and verify it is $>23.8\text{ V}$ and $<32\text{ V}$, see Figure 2.
9. Remove the $1\text{-k}\Omega$ shunt.
10. Disconnect the UUT from the multimeter and turn the UUT off.
11. Select the dc current function on the multimeter and set it to the 1-amp range (a $0.1\ \Omega$ shunt is used in the 1-amp range).
12. Connect the current input terminals of the multimeter to the **SOURCE +** and **SOURCE -** terminals of the UUT.
13. Turn the rotary knob of the UUT to **LOOP POWER**.
14. Verify the short circuit current is $>24\text{ mA}$ and $<35\text{ mA}$.

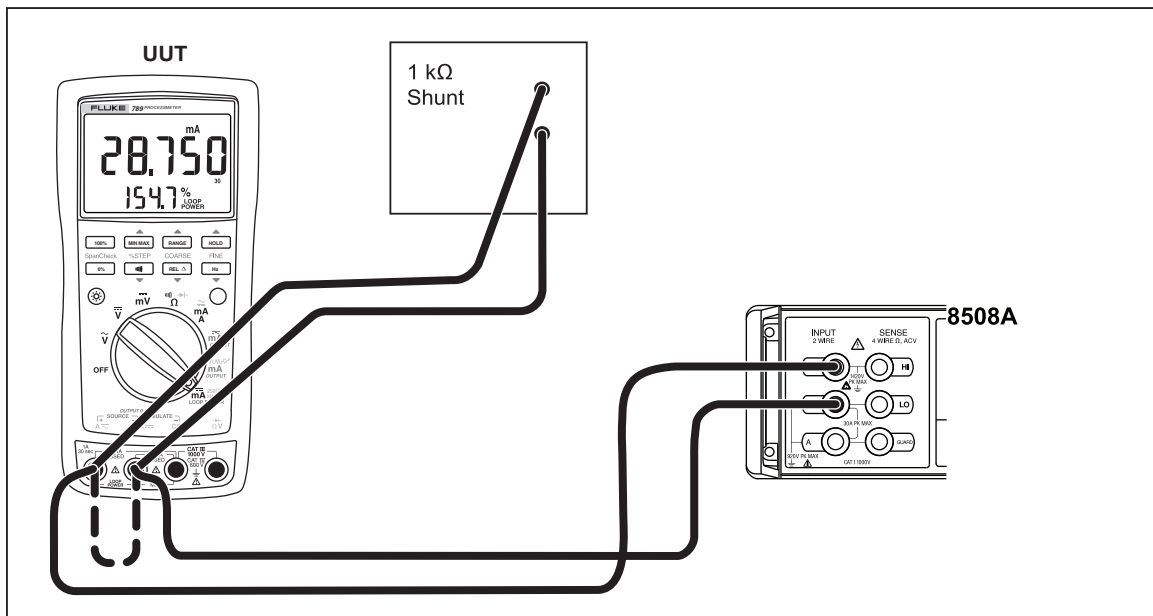

Figure 2. Verifying Loop Power

adm006F.EPS

Current Sourcing Test

1. Put the calibrator in **Standby** (STBY) mode.
2. Connect the **SOURCE + (A $\overline{\sim}$)** and **– (mA $\overline{\sim}$)** terminals on the UUT to the current terminals on the multimeter as shown in Figure 3.
3. Put the multimeter in the dc mA mode and manually select the 100 mA range. (Do not allow the multimeter to autorange.)
4. Turn the UUT rotary switch in the **OUTPUT mA $\overline{\sim}$** position.
5. Use the **SpanCheck**, **%STEP** and **COARSE** keys on the UUT to apply the values shown in Table 4 and compare the readings on the multimeter to the acceptable readings shown.

Table 4. Current Sourcing Test

789 Range	789 Output Current	Minimum Acceptable Multimeter Reading	Maximum Acceptable Multimeter Reading
No Range Switching	4.000 mA	3.990 mA	4.010 mA
No Range Switching	12.000 mA	11.990 mA	12.010 mA
No Range Switching	20.000 mA	19.990 mA	20.010 mA

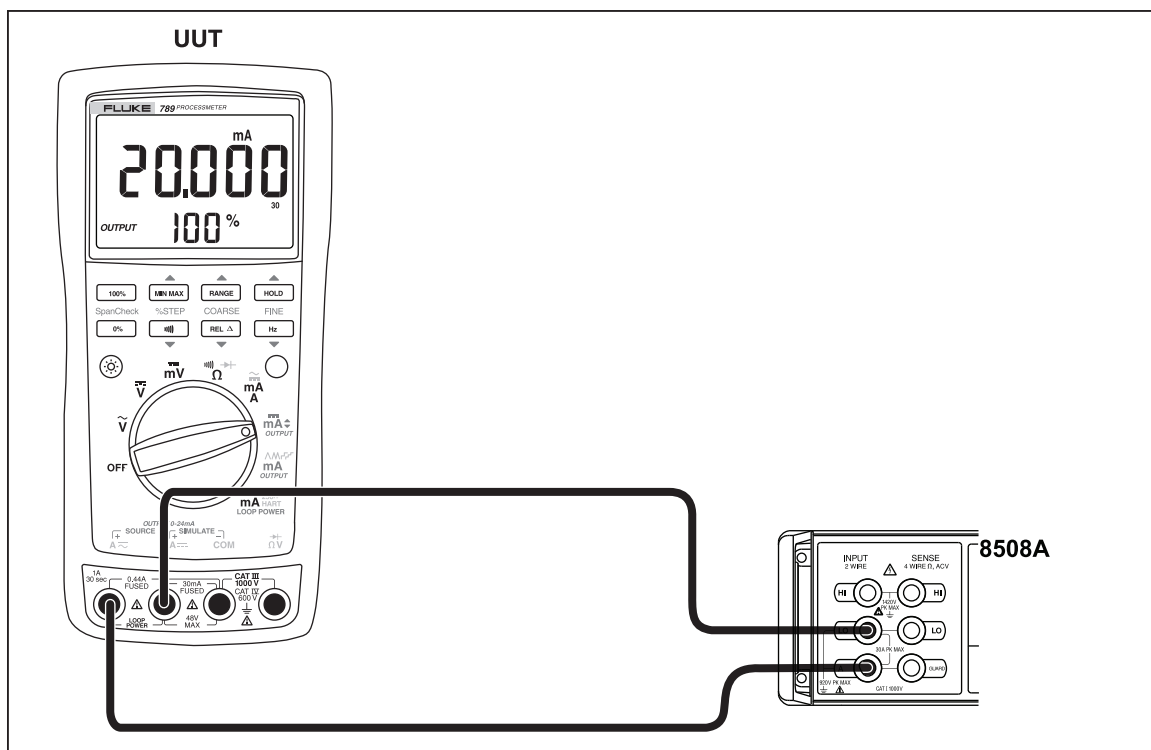

Figure 3. Current Sourcing Connections Using the HP 3458A

adm001F.EPS

Current Measurement Test

1. Put the calibrator in **Standby** (STBY) mode.
2. Put the UUT rotary switch in the $\overset{\sim}{\text{mA}}$ position.
3. Connect the calibrator to the **COM** and $\overset{\sim}{\text{mA}}$ terminals on the UUT as shown in Figure 4.
4. Apply the values from the calibrator shown in Table 5 and compare the readings on the UUT to the acceptable readings shown.
5. Connect the calibrator to the **COM** and **A $\overset{\sim}$** terminals on the UUT.
6. Apply the values from the calibrator shown in Table 6 and compare the readings on the UUT to the acceptable readings shown.
7. Press \bigcirc (BLUE) on the UUT to toggle to ac amps.
8. Apply the values from the calibrator shown in Table 7 and compare the readings on the UUT to the acceptable readings shown.

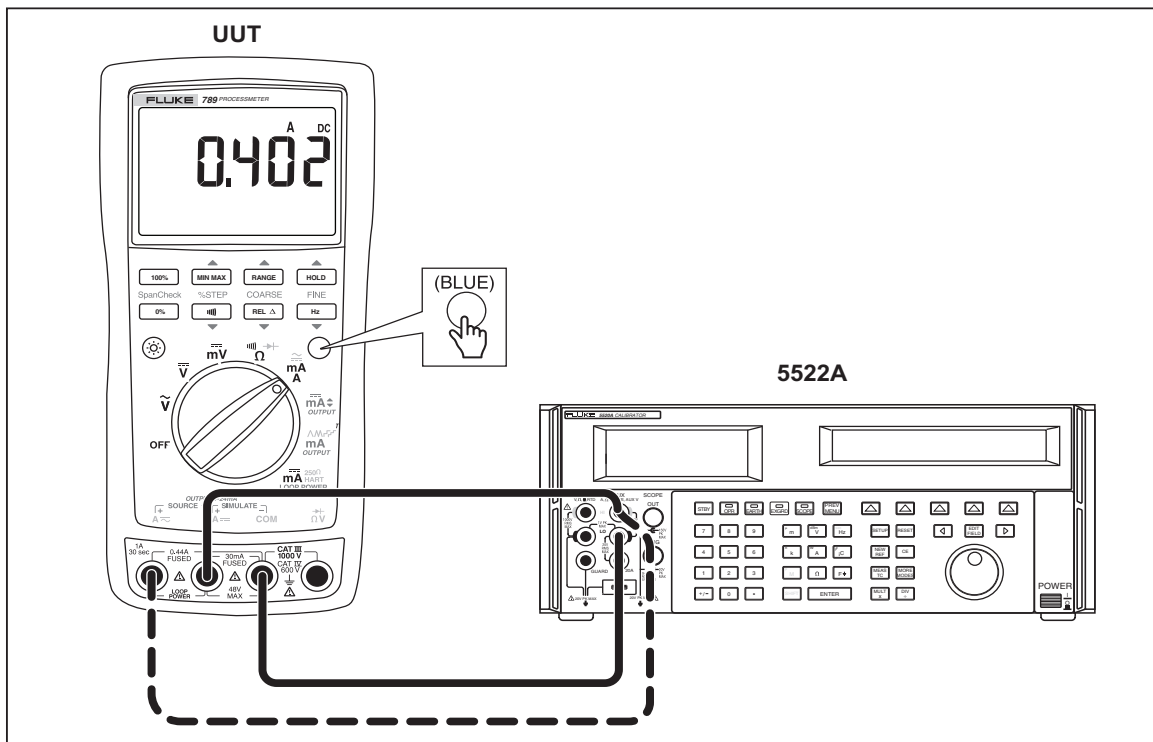

Figure 4. Current Measurement Test Connections

adm003F.EPS

Table 5. DC mA Test

789 Range	Calibrator DC Current	Minimum Acceptable Reading	Maximum Acceptable Reading
No Range Switching	4.000 mA	3.996 mA	4.004 mA
No Range Switching	12.000 mA	11.992 mA	12.008 mA
No Range Switching	20.000 mA	19.988 mA	20.012 mA

Table 6. DC Amp Test

789 Range	Calibrator DC Current	Minimum Acceptable Reading	Maximum Acceptable Reading
No Range Switching	0.100 A	0.098 A	0.102 A
No Range Switching	0.400 A	0.397 A	0.403 A

Table 7. AC Amp Test

789 Range	Calibrator AC Current and Frequency	Minimum Acceptable Reading	Maximum Acceptable Reading
No Range Switching	0.100 A @ 60 Hz	0.097 A	0.103 A
No Range Switching	0.400 A @ 60 Hz	0.394 A	0.406 A

Diode Function Test

1. Put the calibrator in **Standby** (STBY) mode.
2. Turn the UUT rotary switch in the $\Omega \rightarrow$ position.
3. Press \bigcirc (BLUE) to select diode test (\rightarrow).
4. Connect the calibrator to the **COM** and $\Omega \rightarrow$ terminals on the UUT as shown in Figure 5.
5. Apply 2.0 V dc from the calibrator.
6. The UUT should read between 1.959 V and 2.041 V.
7. Put the calibrator in **Standby** (STBY) mode; then disconnect the calibrator from the UUT.
8. Put the multimeter in the dc mA (autorange) function.
9. Connect the current terminals of the multimeter to the **COM** and $\Omega \rightarrow$ terminals on the UUT.

The multimeter should read close to 0.3 mA. (There is no tolerance specification for this current. This test just makes sure that the diode test current source is operating.)

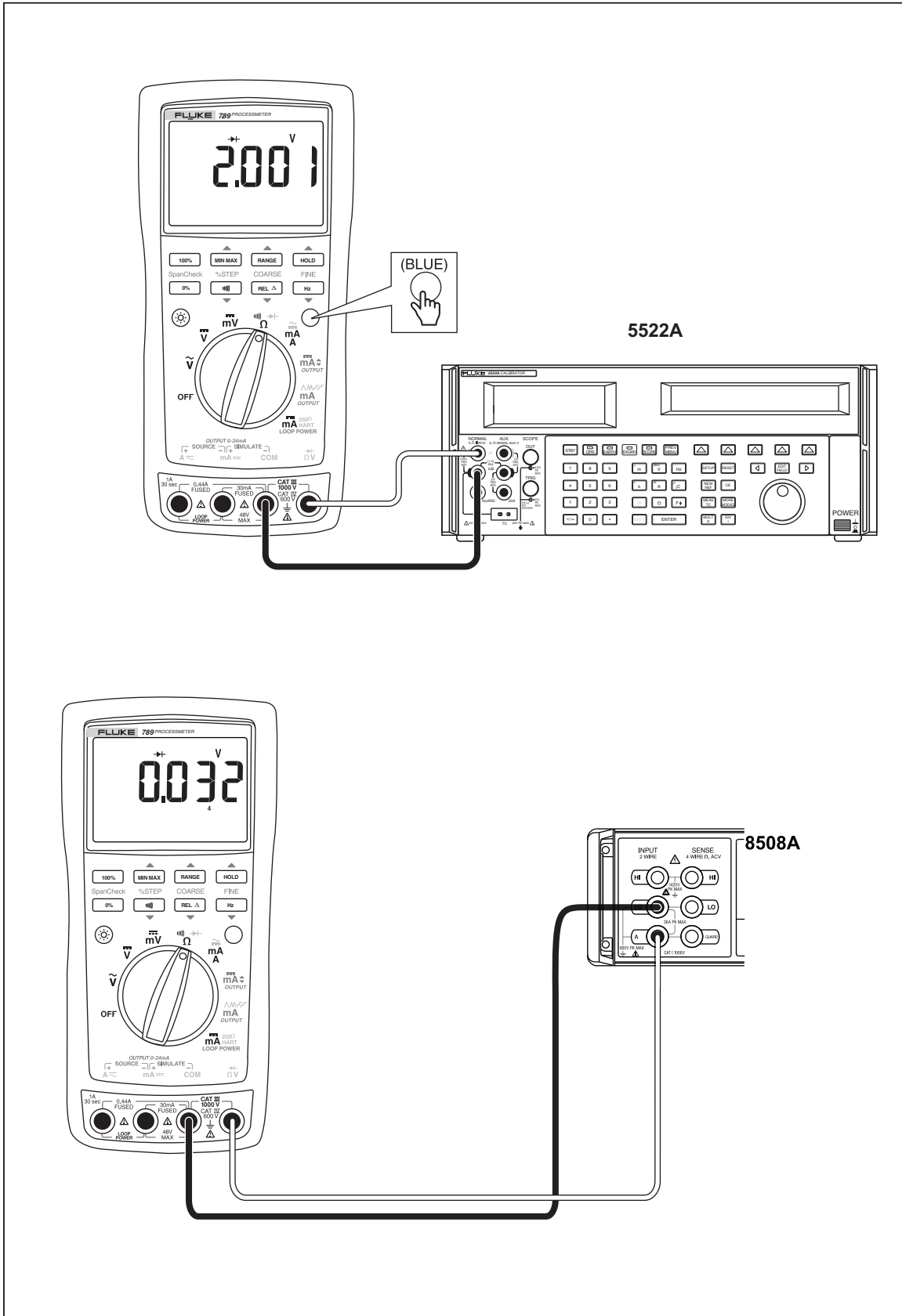



Figure 5. Diode Test Connections

adm007F.EPS

Continuity Function Test

1. Put the calibrator in **Standby** (STBY) mode, and turn the UUT rotary switch to the Ω position.
2. Connect the calibrator to the **COM** and Ω terminals on the UUT as shown in Figure 6.
3. Press  (continuity beeper) on the UUT to select the continuity test.
4. Using the calibrator, apply a resistance output of $260 \pm 20 \Omega$. The beeper should stay off.
5. Using the calibrator, apply a resistance output of $100 \pm 10 \Omega$. The beeper should turn on.

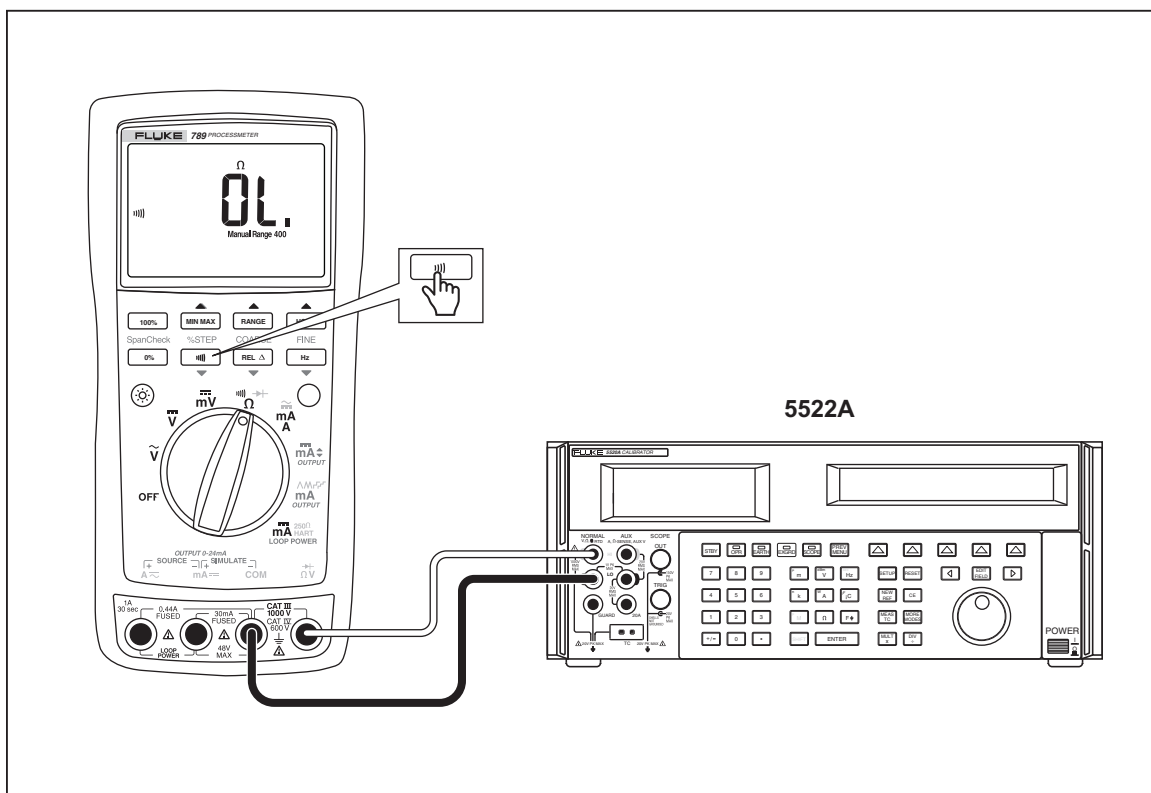

Figure 6. Continuity Test Connections

adm008F.EPS

Resistance Measurement Test

1. Put the calibrator in **Standby** (STBY) mode.
2. Put the UUT rotary switch in the Ω position.
3. Connect the **OUTPUT** and **SENSE** leads of the calibrator to the UUT as shown by the solid and dotted lines in Figure 7.
4. Apply the calibrator resistance values in Table 8 in the UUT 400 Ω to 40 k Ω range. Compare the readings on the UUT to the acceptable readings shown.
5. Change the connections to the UUT. Using the Fluke 5440A-7002 low thermal leads, connect the calibrator to the UUT as shown by the solid lines in Figure 7.
6. Apply the rest of the calibrator resistance values in Table 8 (400 k Ω range and above). Compare the readings on the UUT to the acceptable readings shown.

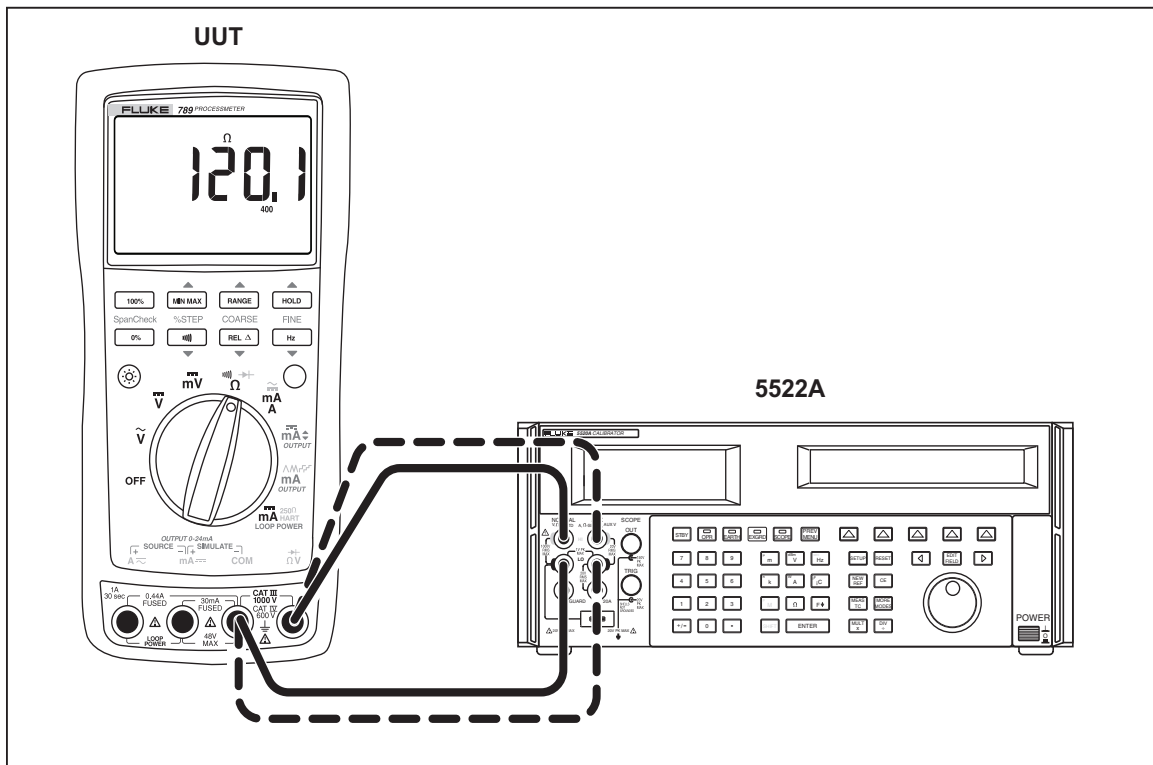

Figure 7. Resistance Measurement Test Connections

adm004F.EPS

Table 8. Resistance Measurement Test

Range	Calibrator Resistance	Calibrator Compensation Mode	Minimum Reading	Maximum Reading
400 Ω	120 Ω	2-Wire	119.6 Ω	120.4 Ω
400 Ω	300 Ω	2-Wire	299.2 Ω	300.8 Ω
4 kΩ	1.2 kΩ	2-Wire	1.197 kΩ	1.203 kΩ
4 kΩ	3 kΩ	2-Wire	2.993 kΩ	3.007 kΩ
40 kΩ	12 kΩ	2-Wire	11.97 kΩ	12.03 kΩ
40 kΩ	30 kΩ	2-Wire	29.93 kΩ	30.07 kΩ
400 kΩ	120 kΩ	OFF	119.7 kΩ	120.3 kΩ
400 kΩ	200 kΩ	OFF	199.5 kΩ	200.5 kΩ
400 kΩ	300 kΩ	OFF	299.3 kΩ	300.7 kΩ
4 MΩ	1.2 MΩ	OFF	1.193 MΩ	1.207 MΩ
4 MΩ	3.0 MΩ	OFF	2.986 MΩ	3.014 MΩ
40 MΩ	12 MΩ	OFF	11.67 MΩ	12.33 MΩ
40 MΩ	30 MΩ	OFF	29.22 MΩ	30.78 MΩ

DC Millivolts Measurement Test

1. Put the calibrator in **Standby** (STBY) mode.
2. Put the UUT rotary switch in the $\overline{\text{mV}}$ position.
3. Connect the calibrator to the **COM** and $\overline{\text{mV}}$ terminals on the UUT as shown in Figure 8.
4. Apply the values from the calibrator shown in Table 9 and compare the readings on the UUT to the acceptable readings shown.

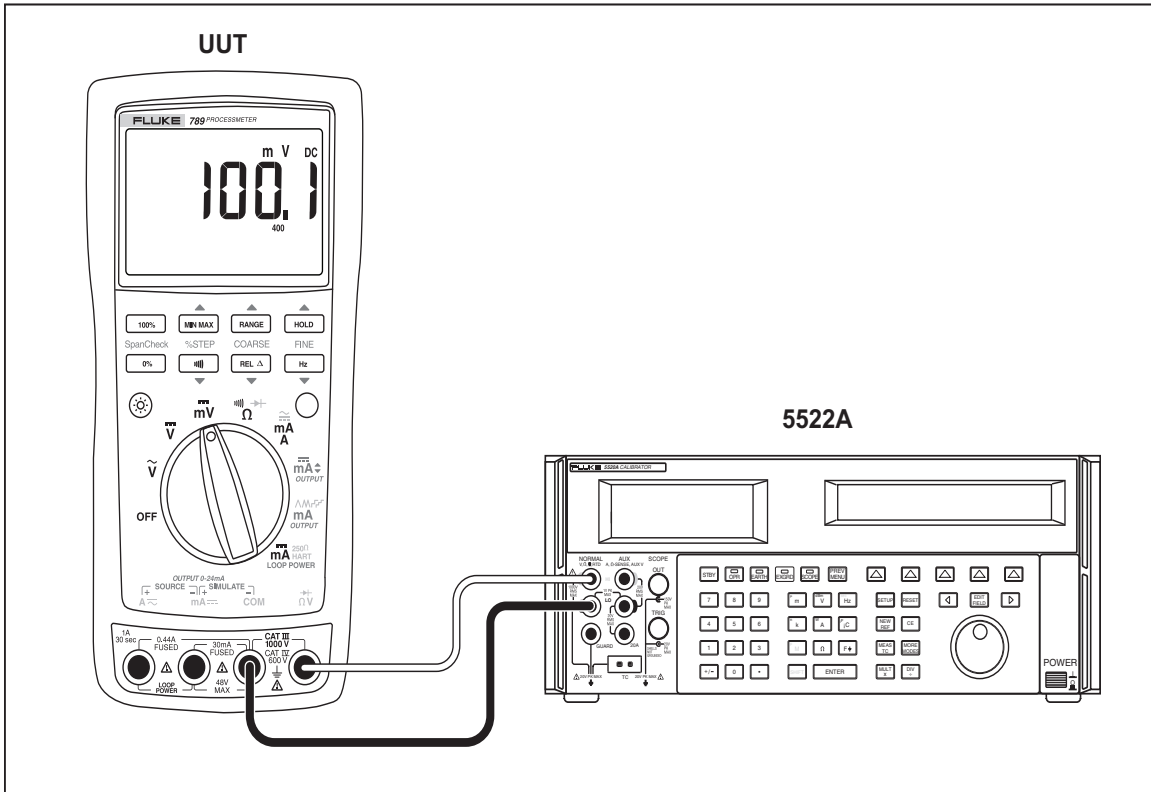

Figure 8. DC mV Measurement Test Connections

adm005F.EPS

Table 9. DC mV Test

Range	Calibrator DC Voltage	Minimum Reading	Maximum Reading
No Range Switching	100 mV	99.7 mV	100.3 mV
No Range Switching	300 mV	299.5 mV	300.5 mV

DC Volts Measurement Tests

⚠⚠ Warning

To prevent possible electrical shock, fire, or personal injury:

- Some of the calibration verification tests involve the use of high voltages and should be performed by qualified personnel only.
 - Always place the calibrator in the Standby (STBY) mode between tests and before handling the test connections or test cables.
1. Put the calibrator in **Standby** (STBY) mode.
 2. Put the UUT rotary switch in the \bar{V} position; select the autoranging mode.
 3. Connect the calibrator to the **COM** and \bar{V} terminals on the UUT as shown in Figure 9.
 4. Apply the values from the calibrator shown in Table 10 and compare the readings on the UUT to the acceptable readings shown.

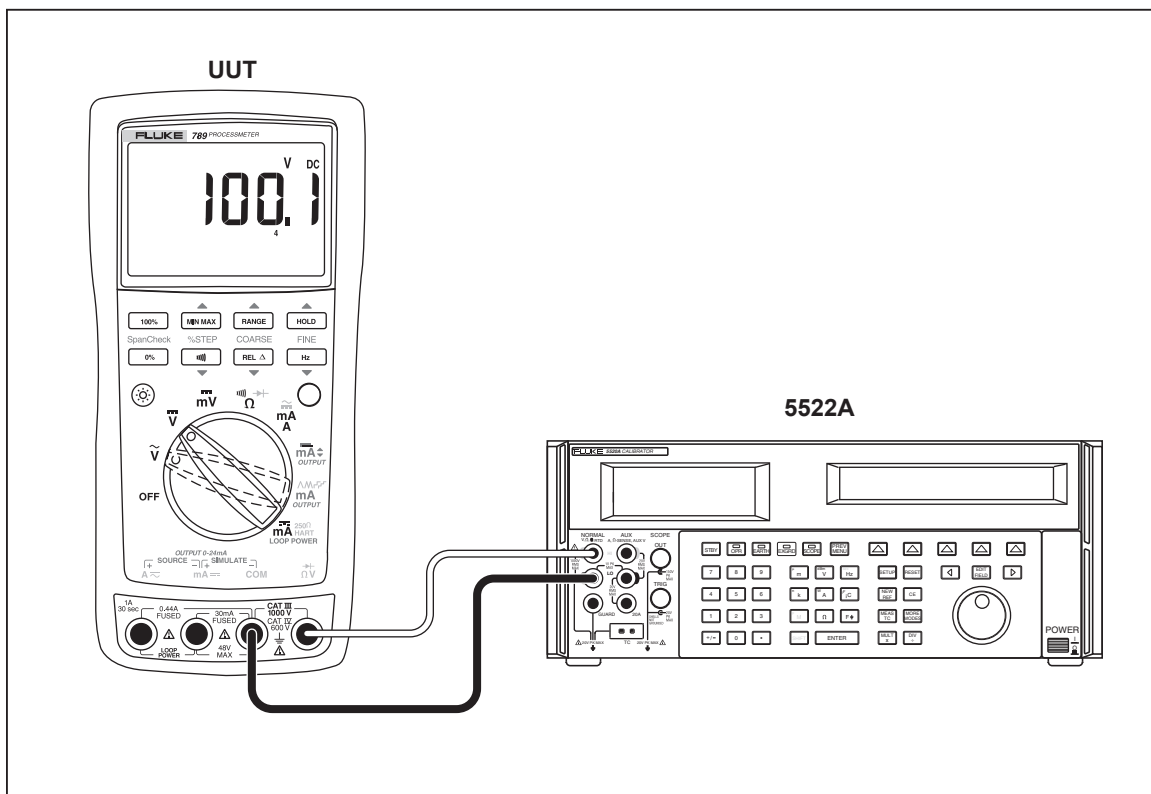

Figure 9. AC/DC Voltage Measurement Test Connections

adm009F.EPS

Table 10. DC Volts Test

Range	Calibrator DC Voltage	Minimum Reading	Maximum Reading
4 V dc	1 V	0.998 V	1.002 V
4 V dc	3 V	2.996 V	3.004 V
40 V dc	10 V	9.98 V	10.02 V
40 V dc	30 V	29.96 V	30.04 V
400 V dc	100 V	99.8 V	100.2 V
400 V dc	300 V	299.6 V	300.4 V
1000 V dc	100 V	99	101
1000 V dc	800 V	798	802

AC Volts Measurement Test

⚠⚠ Warning

To prevent possible electrical shock, fire, or personal injury:

- Some of the calibration verification tests involve the use of high voltages and should be performed by qualified personnel only.
 - Always place the calibrator in the Standby (STBY) mode between tests and before handling the test connections or test cables.
1. Put the calibrator in **Standby** (STBY) mode.
 2. Put the UUT rotary switch in the \tilde{V} position.
 3. Connect the calibrator to the **COM** and ΩV terminals on the UUT as shown in Figure 9.
 4. Apply the values from the calibrator shown in Table 11 and compare the readings on the UUT to the acceptable readings shown.

Table 11. AC Volts Test

Range	Calibrator Voltage and Frequency	Minimum Acceptable Reading	Maximum Acceptable Reading
400 mV ac	100 mV @ 60 Hz	98.9 mV	101.1 mV
400 mV ac	300 mV @ 60 Hz	297.5 mV	302.5 mV
4 V ac	1 V @ 60 Hz	0.991 V	1.009 V
4 V ac	2 V @ 60 Hz	1.984 V	2.016 V
4 V ac	3 V @ 60 Hz	2.977 V	3.023 V
40 V ac	10 V @ 60 Hz	9.91 V	10.09 V
40 V ac	30 V @ 60 Hz	29.77 V	30.23 V
400 V ac	100 V @ 60 Hz	99.1 V	100.9 V
400 V ac	300 V @ 60 Hz	297.7 V	302.3 V
1000 V ac	100 V @ 60 Hz	97	103
1000 V ac	800 V @ 60 Hz	792	808

Frequency Measurement Test

1. Put the calibrator in **Standby** (STBY) mode.
2. Put the UUT rotary switch in the \tilde{V} (ac volts) position.
3. Press to toggle to the frequency measurement function.
4. Connect the calibrator to the **COM** and ΩV terminals on the UUT as shown in Figure 10.
5. Apply the values from the calibrator shown in Table 12 and compare the readings on the UUT to the acceptable readings shown. Press to select the voltage range.

Table 12. Frequency Measurement Test

UUT		Calibrator Voltage and Frequency	Minimum Acceptable Reading	Maximum Acceptable Reading
Range	Voltage			
199.99 Hz	400 mV	150 mV @ 100 Hz	99.98 Hz	100.02 Hz
1999.9 Hz	4 V	1 V @ 1000 Hz	999.8 Hz	1000.2 Hz
19.999 kHz	40 V	4 V @ 10 kHz	9.998 kHz	10.002 kHz

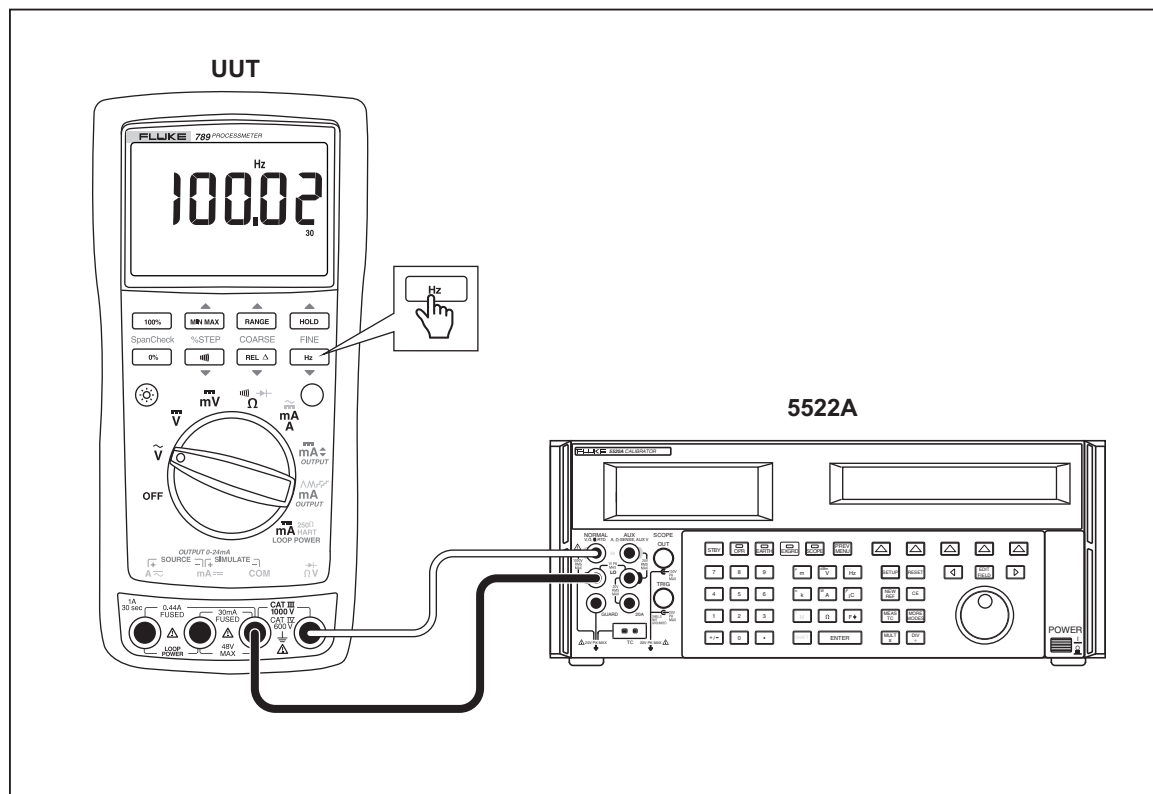

Figure 10. Frequency Measurement Test Connections

adm010F.EPS

Calibration Adjustment

The following sections comprise the Calibration Adjustment Procedure. The procedure is meant to bring the UUT back into specification following repair of the UUT or when the UUT fails the Performance Test. The required equipment is listed earlier in Table 2.

Calibrate the ProcessMeter once a year to ensure that it performs according to its specifications.

Preparation

⚠⚠ Warning

To prevent possible electric shock, fire, or personal injury:

- **Do not use the ProcessMeter if it looks damaged.**
- **Inspect the ProcessMeter for damage, especially around the input terminals. Inspect the test leads and test connections for damaged insulation or exposed metal.**
- **Look for cracks, missing plastic or damaged insulation. If damage is detected, do not continue; contact Fluke to have the ProcessMeter serviced.**
- **Make sure that the battery compartment door on the ProcessMeter is closed and latched before using it.**
- **Check the test leads for continuity. Replace damaged test leads as necessary.**
- **Do not use the ProcessMeter if it appears to operate abnormally. Protection designed into the ProcessMeter might be impaired. If in doubt, have the ProcessMeter serviced.**
- **To avoid electrical shock, always place the calibrator in the Standby (STBY) mode between tests and before handling the test connections or test cables.**
- **Some of the calibration adjustment procedures involve the use of high voltages and should be performed by qualified personnel only.**

Note

The calibration adjustment procedures assume that the person performing them knows how to use the ProcessMeter and the required equipment. Do not attempt to calibrate the ProcessMeter unless you are qualified to do so.

Calibration adjustment should be performed in an RF field <1 V/m such as a laboratory environment.

To prepare for calibration adjustment, do the following:

1. Make sure that you have the required equipment available (see Table 2).
2. Make sure that both fuses in the UUT are intact. See *Check and Replace Fuses* earlier in this manual.
3. Turn on and warm up the calibrator as required by its specifications.
4. Remove all input cables from the front of the UUT.
5. Make sure that the UUT is in an ambient temperature between 18 °C and 28 °C (64.4 °F and 82.4 °F).

Procedure for Models with Firmware Version <2.0

AC Voltage Adjustment

Connect the ProcessMeter to the volt/ohm output of the 5522A calibrator.

1. Turn the UUT switch to \tilde{V} .
2. The calibration button is located on the backside of the ProcessMeter, under the Calibration Seal. Use a small probe to break the seal.
3. Press and hold the Calibration Button for approximately 2 seconds. The unit will beep (see Figure 11).

Note

Pressing the Calibration Button puts the ProcessMeter into and out of calibration mode. The ProcessMeter will remain in calibration mode until the unit is turned off or the calibration button is pressed a second time.

CAL appears in the bottom display when the ProcessMeter is in calibration mode.

4. Apply the voltages listed below as prompted by the ProcessMeter.
5. Press after each sourced value appears. Do not alter the sourced value while the display reads **Busy**.

Applied voltages:

- 4 mV @ 60 Hz
- 40 mV @ 60 Hz
- 400 mV @ 60 Hz
- 4 V @ 60 Hz
- 40 V @ 60 Hz
- 400 V @ 60 Hz
- 1000 V @ 60 Hz

6. When **Store** is displayed, press to store the calibration value.

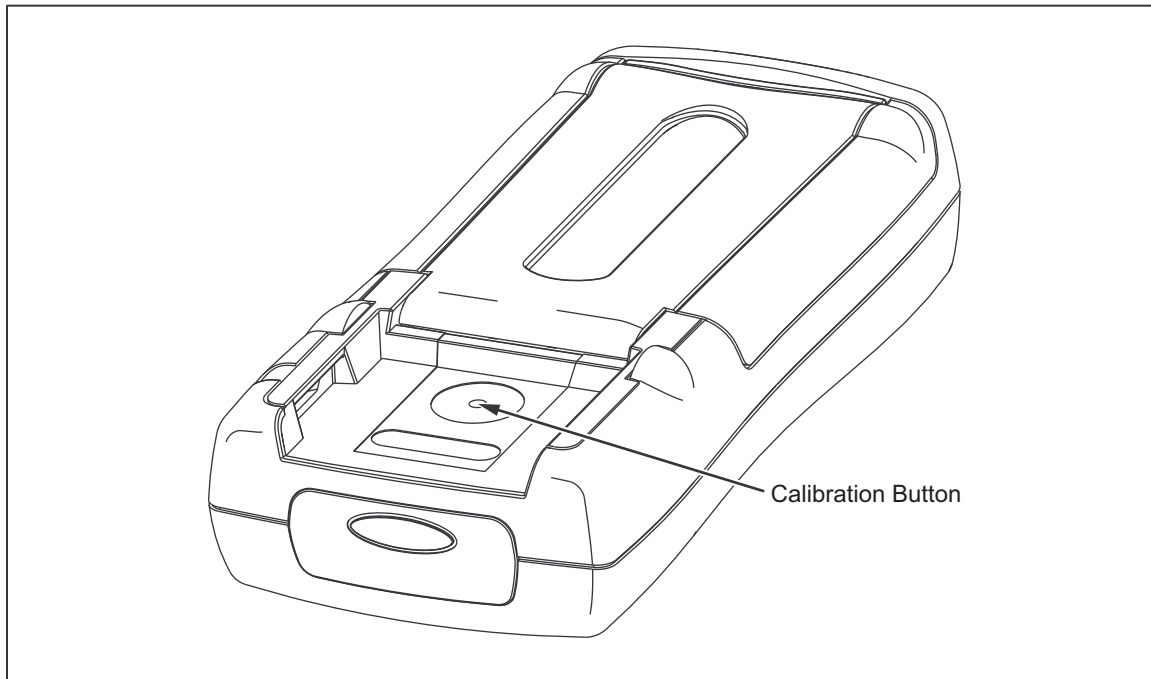

Figure 11. Calibration Button Access

aa04f.eps

Frequency Adjustment

1. Connect the ProcessMeter to the volt/ohm output of the 5522A calibrator.
2. Turn the UUT's switch to \tilde{v} .
3. Push .
4. Press and hold the Calibration Button for approximately 2 seconds. The unit will beep (see Figure 11).

Note

Press the Calibration Button to put the ProcessMeter into and out of calibration mode. The ProcessMeter remains in calibration mode until the unit is turned off or the calibration button is pressed a second time.

CAL appears in the bottom display when the ProcessMeter is in calibration mode.

5. Apply 4 V @ 5000 Hz.
6. Press after the sourced value appears. Do not alter the sourced value while the display reads **Busy**.
7. When **Store** displays, press to store the calibration value.

DC Voltage Adjustment

1. Connect the ProcessMeter to the volt/ohm output of the 5522A calibrator.
2. Turn the UUT's switch to \bar{V} .
3. Press and hold the Calibration Button for approximately 2 seconds. The unit will beep (see Figure 11).

Note

Pressing the Calibration Button puts the ProcessMeter into and out of calibration mode. The ProcessMeter will remain in calibration mode until the unit is turned off or the calibration button is pressed a second time.

CAL appears in the bottom display when the ProcessMeter is in calibration mode.

4. Press after each sourced value appears. Do not alter the sourced value while the display reads **Busy**.

Applied voltages:

- 0 V
- 4 V
- 40 V
- 400 V
- 1000 V

5. When **Store** is displayed, press to store the calibration value.

DC Millivolts Adjustment

1. Connect the ProcessMeter to the volt/ohm output of the 5522A calibrator.
2. Turn the UUT's switch to \bar{mV} .
3. Press and hold the Calibration Button for approximately 2 seconds. The unit will beep (see Figure 11).

Note

Pressing the Calibration Button puts the ProcessMeter into and out of calibration mode. The ProcessMeter will remain in calibration mode until the unit is turned off or the calibration button is pressed a second time.

CAL appears in the bottom display when the ProcessMeter is in calibration mode.

4. Apply 0 V. Press after the sourced value appears. Do not alter the sourced value while the display reads **Busy**.
5. Apply 400 mV. Press after the sourced value appears. Do not alter the sourced value while the display reads **Busy**.
6. When **Store** is displayed, press to store the calibration value.

Ohms Adjustment

1. Connect the ProcessMeter to the volt/ohm output of the 5522A calibrator.
2. Turn the UUT's switch to Ω .
3. Press and hold the Calibration Button for approximately 2 seconds. The unit will beep (see Figure 11).

Note

Pressing the Calibration Button puts the ProcessMeter into and out of calibration mode. The ProcessMeter will remain in calibration mode until the unit is turned off or the calibration button is pressed a second time.

CAL appears in the bottom display when the ProcessMeter is in calibration mode.

4. Apply the resistances listed below. Press after each sourced value appears. Do not alter the sourced value while the display reads **Busy**.

Applied resistances:

- 0 Ω
 - 400 Ω
 - 4 k Ω
 - 40 k Ω
 - 400 k Ω
 - 4 M Ω
 - 40 M Ω
5. When **Store** is displayed, press to store the calibration value.

Diode Adjustment

1. Connect the ProcessMeter to the volt/ohm output of the 5522A calibrator.
2. Turn the UUT's switch to Ω .
3. Press \bigcirc (BLUE) to enter the diode function.
4. Press and hold the Calibration Button for approximately 2 seconds. The unit will beep (see Figure 11).

Note

Pressing the Calibration Button puts the ProcessMeter into and out of calibration mode. The ProcessMeter will remain in calibration mode until the unit is turned off or the calibration button is pressed a second time.

CAL appears in the bottom display when the ProcessMeter is in calibration mode.

Before applying 0 V dc, the 5522A must be range locked in the 3.3 V range. Impedance of 330 mV range changes the 0 V point.

5. Apply 0 V dc. Press after the sourced value appears. Do not alter the sourced value while the display reads **Busy**.
6. Apply 1 V dc. Press after the sourced value appears. Do not alter the sourced value while the display reads **Busy**.
7. When **Store** is displayed, press to store the calibration value.

Milliamps DC Adjustment

1. Connect the ProcessMeter to the mA output of the 5522A calibrator.
2. Turn the UUT's switch to $\tilde{\text{mA}}$. Make sure the test leads are in the **mA** and **COM** inputs.
3. Press and hold the Calibration Button for approximately 2 seconds. The unit will beep (see Figure 11).

Note

Pressing the Calibration Button puts the ProcessMeter into and out of calibration mode. The ProcessMeter will remain in calibration mode until the unit is turned off or the calibration button is pressed a second time.

CAL appears in the bottom display when the ProcessMeter is in calibration mode.

4. Apply 0 mA dc. Press after the sourced value appears. Do not alter the sourced value while the display reads **Busy**.
5. Apply 30 mA dc. Press after the sourced value appears. Do not alter the sourced value while the display reads **Busy**.
6. When **Store** is displayed, press to store the calibration value.

Amps DC Adjustment

1. Connect the ProcessMeter to the A output of the 5522A calibrator.
2. Turn the UUT's switch to $\tilde{\text{A}}$. Make sure the test leads are in the **A** and **COM** jacks.
3. Press and hold the Calibration Button for 2 seconds (see Figure 11). The unit will beep.
4. Apply 0 A dc. Press after the reading stabilizes.
5. Apply 1 A dc. Press after the reading stabilizes.

Caution

**Remove 1 A from UUT promptly after storing calibration constant.
Fuse will blow after 30 seconds.**

6. Press to store calibration constants.

Amps AC Adjustment

1. Connect the ProcessMeter to the A output of the 5522A calibrator.
2. Turn the UUT's switch to $\frac{\approx}{A}$.
3. Press \bigcirc (BLUE) to enter the A ac function.
4. Press and hold the Calibration Button for 2 seconds (see Figure 11). The unit will beep.
5. Apply 0.05 A ac @ 60 Hz. Press after the reading stabilizes.
6. Apply 1 A ac. Press after the reading stabilizes.
7. Press to store calibration constants.

Caution

**Remove 1 A from UUT promptly after storing calibration constant.
Fuse will blow after 30 seconds.**

Milliamps Output Adjustment

1. Connect the ProcessMeter A output to the Digital Multimeter input.
2. UUT will output approximately 4 mA. Use the fine and coarse adjustments on the UUT to get a 4.000 mA reading on the Digital Multimeter.
3. Press after 4.000 mA reading is reached on the Digital Multimeter.
4. UUT will output approximately 20 mA. Use the fine and coarse adjustments on the UUT to get a 20.000 on the Digital Multimeter.
5. Press after 20.000 mA reading is reached on the Digital Multimeter.
6. Press to store calibration constants.

Procedure for Models with Firmware Version ≥2.0

Calibration Adjustment Counter

The Meter contains a calibration adjustment counter. The counter is incremented each time a Calibration Adjustment Procedure is completed. The value in the counter can be recorded and used to show that no adjustments have been made during a calibration cycle.

Use the following steps to view the calibration counter on the UUT.

1. While holding down **HOLD** on the UUT, turn the rotary switch from **OFF** to $\Omega \rightarrow +$. The UUT should display $\square\square\square$. Release **HOLD**.
2. Press **HOLD** once to see the calibration counter. For example, $n000$.
3. Turn the rotary switch to **OFF**.

Calibration Adjustment Password

To start the Calibration Adjustment Procedure, the correct four-digit password must be entered. The password can be changed or reset to the default as described in following paragraphs. The default password is 1234.

How to Change the Password

1. While holding down **HOLD** on the UUT, turn the rotary switch from **OFF** to $\Omega \rightarrow +$. The UUT displays $\square\square\square$. Release **HOLD**.
2. Press **HOLD** once to see the calibration counter.
3. Press **HOLD** again to start the password entry. The UUT displays $????$.

The following keys represent the digit indicated below when entering or changing the password:

100% = 1	MIN MAX = 2	RANGE = 3	HOLD = 4
0% = 5	 = 6	REL Δ = 7	Hz = 8
⊕ = 9	○ = 0		

4. Press the four keys to enter the old password. If changing the password for the first time, enter 100% (1), MIN MAX (2), RANGE (3), and HOLD (4).
5. Press RANGE to change the password:
 - The UUT displays $----$ if the old password is correct.
 - If the password is not correct, the UUT emits a double beep, displays $????$ and the password must be entered again. Repeat step 4.
6. Press the four keys representing the new password.
7. Press **HOLD** to store the new password.



Static Awareness



Semiconductors and integrated circuits can be damaged by electrostatic discharge during handling. This notice explains how to minimize damage to these components.

1. Understand the problem.
2. Learn the guidelines for proper handling.
3. Use the proper procedures, packaging, and bench techniques.

Follow these practices to minimize damage to static sensitive parts.

Warning

To prevent electric shock or personal injury. De-energize the product and all active circuits before opening a product enclosure, touching or handling any PCBs or components.

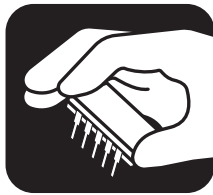

- Minimize handling.
- Handle static-sensitive parts by non-conductive edges.
- Do not slide static-sensitive components over any surface.
- When removing plug-in assemblies, handle only by non-conductive edges.
- Never touch open-edge connectors except at a static-free work station.

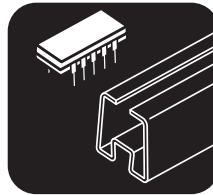





- Keep parts in the original containers until ready for use.
- Use static shielding containers for handling and transport.
- Avoid plastic, vinyl, and Styrofoam® in the work area.



- Handle static-sensitive parts only at a static-free work station.
- Put shorting strips on the edge of the connector to help protect installed static-sensitive parts.
- Use anti-static type solder extraction tools only.
- Use grounded-tip soldering irons only.







Meter Keys Used in the Calibration Steps

The Meter keys behave as follows when performing the Calibration Adjustment Procedure. This may be of help determining why a calibration step is not accepted and for determining the input value without referring to Table 6.

-  Press and hold to show the measured value. The measurement value is not calibrated so it may not match the input value. This is normal.
-  Press and hold to display the required input amplitude.
-  Press and hold to display the frequency of the required input.
-  Store the calibration value and advance to the next step. This key is also used to exit the calibration mode after the calibration-adjustment sequence is complete.
-  Press to adjust the Source mA to the target.

Calibration Adjustment

Use the following steps to make calibration adjustments to the UUT. Complete the adjustment procedure before turning the UUT off; otherwise, the new calibration constants will not be saved.

1. While holding down , turn the rotary switch from **OFF** to Ω . The UUT displays $\Gamma \Delta$. Release .
2. Press  once to see the calibration counter, for example, $n000$.
3. Press  again to start the password entry. The UUT displays $????$.
4. Press four keys to enter the password.
5. Press  to go to the first calibration step. The UUT displays 000 if the password is correct. If the password is not correct, the UUT emits a double beep, displays $????$ and the password must be entered again. Repeat step 4.
6. Apply the input value listed for each calibration adjustment step in Table 13. For each step, position the rotary switch and apply the input to the terminals as indicated in the table.
7. After each input value is applied, press  to accept the value and proceed to the next step ($000?$ and so forth).

Note

Press  and wait until the step number advances before changing the calibrator source or turning the rotary switch. If the rotary switch is not in the correct position, or if the measured value is not within the anticipated range of the input value, the UUT emits a double beep and will not continue to the next step. Some adjustment steps take longer to execute than others (10 to 15 seconds). For these steps, the UUT will beep when the step is complete. Not all steps have this feature.

8. After the final step, the display shows End to indicate that the calibration adjustment is complete. Press  to go to meter mode.

Note

Set the calibrator to Standby prior to changing the function switch position and/or after completing adjustment of each function. If the calibration adjustment procedure is not completed correctly, the UUT will not operate correctly.

⚠ Caution

Remove 1 A from UUT promptly after storing calibration constant. Fuse will blow after 30 seconds.

Table 13. Calibration Adjustment Steps for Models with Firmware Version >2.0

Input Terminal	Step	Input Value	Function
V/COM	1	400 mV ac, 60 Hz	V ac
	2	4 V ac, 60 Hz	V ac
	3	40 V ac, 60 Hz	V ac
	4	400 V ac, 60 Hz	V ac
	5	4 V dc	V dc
	6	40 V dc	V dc
	7	400 V dc	V dc
	8	400 mV dc	mV dc
	9	40 mV dc	mV dc
	10	400 Ω	Ω
	11	4 kΩ	Ω
	12	40 kΩ	Ω
	13	400 kΩ	Ω
	14	4 MΩ	Ω
	15	0 MΩ	Ω
	16	40 MΩ	Ω
	mA/COM	17	4 V dc
18		0 mA dc	mA
A/COM	19	30 mA dc	mA
	20	1 A dc	A
	21	1 A ac, 60 Hz	A
A/mA	22	1 A ac, 2 kHz	A
	23	No input, 0 % (4 mA) output, measure output current with HP3458	mA source
	24	No input, 100 % (20 mA) output, measure output current with HP3458	mA source

Replacement Parts and Accessories

⚠⚠ Warning

To prevent possible electrical shock, fire, or personal injury use only:

- Use only specified replacement fuses.
- Use only specified replacement parts.

Replacement parts and some accessories are shown in Figure 13 and listed in Table 14. Many more DMM accessories are available from Fluke. For a catalog, contact the nearest Fluke distributor.

To find out how to order parts or accessories use the telephone numbers or addresses shown in "Contacting Fluke."

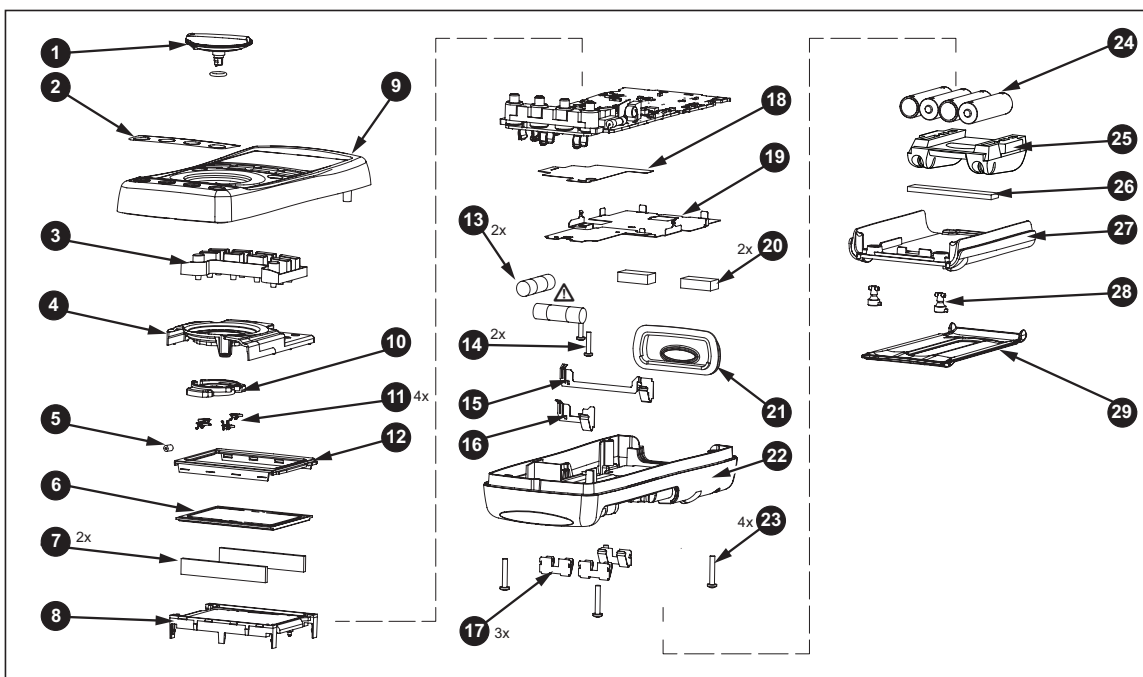

anw038.eps

Figure 13. Replacement Parts

Table 14. Replacement Parts

Item Number	Description	Fluke PN for 789 <V2	Fluke PN for 789 ≥V2	Fluke PN for 787B	Quantity
1	Knob Assembly with o-ring	658440		4772670	1
2	Decal, Top Case	1623923		4772201	1
3	Keypad	1622951			1
4	Top Shield	1622924	4772681		1
5	Top Shield Contact	674853			1
6	LCD Display	1883431			1
7	LCD Connectors, Elastomeric	1641965			2
8	Backlight/Bracket	1622960	4756199		1
9	Top Case with Lens Protector	1622855		4772197	2
10	Contact Housing	1622913			1
11	RSOB Contact	1567683			4
12	Mask	1622881		4772655	1
13	⚠ Fuse, 440 mA, 1000 V fast-blow	943121			2
14	PCB Screw	832220			2
15	Battery Contact, Negative	658382			1
16	Battery Contact, Positive	666438			1
17	Battery Contacts Dual	666435			3
18	Bottom Insulator	NA	4811256		1
19	Bottom Shield	1675171	4811263		1
20	Shock Absorber	878983			1
21	IR Lens	658697			1
22	Bottom Case	659042	4772662		1
23	Case Screws	1558745			4
24	Battery, 1.5 V, 0-15 mA, AA Alkaline	376756			4
25	Accessory Mount with Probe Holders	658424			1
26	Shock Absorber	674850			1
27	Access Door, Battery/Fuse	1622870			1
28	Fasteners, Battery/Fuse Access Door	948609			2
29	Tilt-Stand	659026			1
-	Test Leads	variable ^[1]			1 (set of 2)
-	Alligator Clips	variable ^[1]			1 (set of 2)

[1] See www.fluke.com for more information about the test leads and alligator clips available for your region.

