

FLUKE®

820-2

Stroboscope

Users Manual

September 2014

© 2014 Fluke Corporation. All rights reserved. Specifications are subject to change without notice. All product names are trademarks of their respective companies.

LIMITED WARRANTY AND LIMITATION OF LIABILITY

This Fluke product will be free from defects in material and workmanship for two years from the date of purchase. This warranty does not cover fuses, disposable batteries, or damage from accident, neglect, misuse, alteration, contamination, or abnormal conditions of operation or handling. Resellers are not authorized to extend any other warranty on Fluke's behalf. To obtain service during the warranty period, contact your nearest Fluke authorized service center to obtain return authorization information, then send the product to that Service Center with a description of the problem.

THIS WARRANTY IS YOUR ONLY REMEDY. NO OTHER WARRANTIES, SUCH AS FITNESS FOR A PARTICULAR PURPOSE, ARE EXPRESSED OR IMPLIED. FLUKE IS NOT LIABLE FOR ANY SPECIAL, INDIRECT, INCIDENTAL OR CONSEQUENTIAL DAMAGES OR LOSSES, ARISING FROM ANY CAUSE OR THEORY. Since some states or countries do not allow the exclusion or limitation of an implied warranty or of incidental or consequential damages, this limitation of liability may not apply to you.

Fluke Corporation
P.O. Box 9090
Everett, WA 98206-9090
U.S.A.

Fluke Europe B.V.
P.O. Box 1186
5602 BD Eindhoven
The Netherlands

Table of Contents

Title	Page
Introduction	1
How to Contact Fluke.....	1
Safety	2
Symbols	3
Standard Equipment	4
Features.....	5
Auto Off	8
Low-Battery Indicator	8
Product Use	9
Default Settings	9
Setup Menu	10
Range.....	10
External Trigger.....	11
Maintenance	11
How to Clean the Product	12
How to Change the Batteries	12
Specifications.....	14
Mechanical Specifications	14
Environmental Specifications	14
Miscellaneous Specifications	16

List of Tables

Table	Title	Page
1.	Symbols	3
2.	The Product	6
3.	Display	7

List of Figures

Figure	Title	Page
1.	The Product	5
2.	External Trigger Connector Polarity	11
3.	Battery Replacement	13

Introduction

The 820-2 Stroboscope (the Product) uses an adjustable LED strobe light to show the movement of mechanical parts. The frequency range is 30 flashes per minute (FPM) to 300,000 FPM.

How to Contact Fluke

To contact Fluke, call one of the following telephone numbers:

- Technical Support USA: 1-800-44-FLUKE (1-800-443-5853)
- Calibration/Repair USA: 1-888-99-FLUKE (1-888-993-5853)
- Canada: 1-800-36-FLUKE (1-800-363-5853)
- Europe: +31 402-675-200
- Japan: +81-3-6714-3114
- Singapore: +65-6799-5566
- Anywhere in the world: +1-425-446-5500

Go to www.fluke.com to register your product, download manuals, and find more information.

To view, print, or download the latest manual supplement, visit <http://us.fluke.com/usen/support/manuals>.

Safety

A **Warning** identifies conditions and procedures that are dangerous to the user.

Warning







To prevent possible personal injury:

- Read all safety information before you use the Product.
- Carefully read all instructions.
- Use the Product only as specified, or the protection supplied by the Product can be compromised.
- Do not touch the moving target object when you use the Product. In stroboscopic light, object movement can appear still or slowed.
- Do not use the Product around explosive gas, vapor, or in damp or wet environments.
- Do not use the Product around personnel that are susceptible to epileptic seizures.
- Do not use the Product if it is damaged.

Symbols

Symbols used in the manual or on the Product are shown in Table 1.

Table 1. Symbols

Symbol	Definition
	Risk of danger. Important information. See manual.
	Battery
	Conforms to relevant Australian EMC standards.
	Conforms to European Union directives.
	Conforms to relevant South Korean EMC Standards.
	This product complies with the WEEE Directive (2002/96/EC) marking requirements. The affixed label indicates that you must not discard this electrical/electronic product in domestic household waste. Product Category: With reference to the equipment types in the WEEE Directive Annex I, this product is classed as category 9 "Monitoring and Control Instrumentation" product. Do not dispose of this product as unsorted municipal waste. Go to Fluke's website for recycling information.

Standard Equipment

If an item below is missing or damaged, contact Fluke. The Product comes with:

- Quick Reference Guide
- Safety Information
- International Registration Card
- Statement of Quality
- Hard Case
- AA Batteries (3)
- External Trigger Input Connector

Features

Figure 1, Table 2, and Table 3 show the Product.

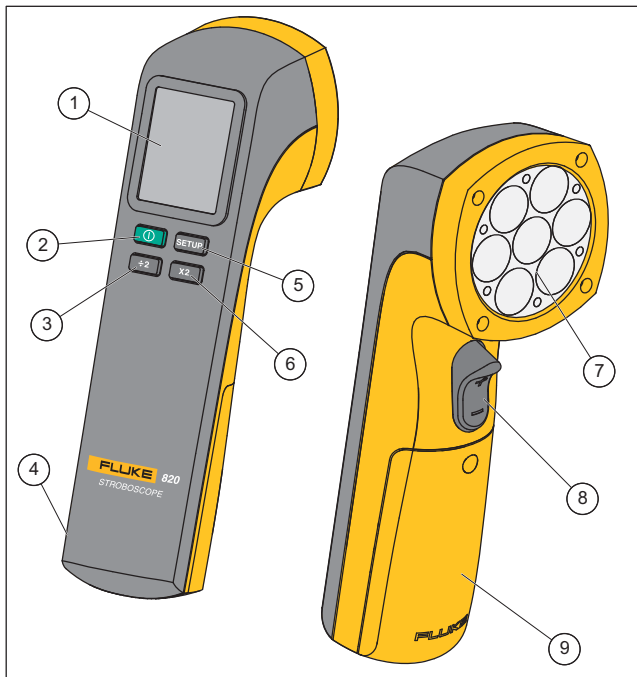

gsh01.eps

Figure 1. The Product

Table 2. The Product









Item	Description
①	Display
②	Power Button- Push  to turn on the Product. Push and hold  for 2 seconds to turn off the Product.
③	Push  to divide the current set value by two. The scroll speed increases when  is continuously held down.
④	External trigger connection
⑤	Setup- Push  to move between different settings and modes.
⑥	Push  to double the current set value. Speed of the scroll increases when this button is held down.
⑦	LED strobe
⑧	Push the trigger () up to increase the current set value. Push  down to decrease the current set value. Speed increases when  is held down.
⑨	Battery compartment

Table 3. Display



gsh02.eps

Item	Description
①	Adjustable pulse width in microseconds (μs). Adjustment is accessed in the Setup Menu.
②	Adjustable pulse width in degrees. Adjustment is accessed in the Setup Menu.
③	Primary display. Six digits with decimal.
④	Set external trigger edge to 0 for positive and 1 for negative. Adjustment is accessed in the Setup Menu.
⑤	External trigger input is connected.
⑥	Set the external trigger pulse divider from 1 to 255. Adjustment is accessed in the Setup Menu.

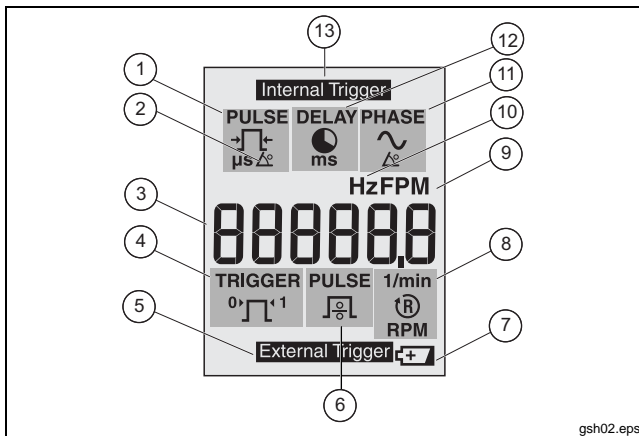
Table 3. Display (cont.)

Item	Description	Item	Description
⑦	Low battery. Replace the battery.	⑧	1/min or RPM for external trigger input.
⑨	Flashes per minute (FPM), default at power up.	⑩	Flashes per second. Adjustment is accessed in the Setup Menu.
⑪	Pulse delay in degrees (Phase degree). Adjustment is accessed in the Setup Menu.	⑫	Pulse delay in milliseconds (ms). Adjustment is accessed in the Setup Menu.
⑬	Internal trigger		

Auto Off

To conserve battery power, the Product turns off after 15 minutes of non-use.

Low-Battery Indicator

The low-battery indicator is shown when the battery is low. When the low-battery indicator shows () , change the batteries.

Product Use

The subsequent sections tell you how to use the Product.

Push **①** to turn on the Product. Push and hold **①** for 2 seconds to turn off the Product.

Default Settings

To set the Product to the default settings, push and hold **x2** and **÷2**.

The default settings are:

- 1000 FPM
- 16.7 Hz
- 333 Pulse μ s
- 2.0 Pulse deg
- 0 Delay ms
- 0 Phase deg
- External pulse divider = 1
- External trigger edge = 0 (positive)

Setup Menu

When you push **SETUP**, the display shows the Setup menu. From the Setup menu, you can change these parameters:

- **Hz** setting – Adjust the flashes per seconds in Hz.
- Pulse width in μs ($\frac{\mu\text{s}}{\mu\text{s}}$) – Adjust the flash intensity in microseconds of pulse width.
- Pulse width in degrees ($\frac{\mu\text{s}}{\mu\text{s}^\circ}$) – Adjust the flash intensity in degrees of flash rate.
- Delay in ms ($\frac{\text{ms}}{\text{ms}}$) – Adjust the delay time in milliseconds between internal trigger and flash. Precise adjustments of the observation position can be made with this setting.
- Phase degree ($\frac{\mu\text{s}}{\mu\text{s}^\circ}$) – Adjust the degrees of phase shift between internal trigger and flash. Precise adjustments of the observation position can be made with this setting.
- External trigger pulse divider ($\frac{\text{ms}}{\text{ms}}$) – Set the external trigger divider, to adjust the flash rate.
- External trigger edge ($0^{\circ}\text{1}^{\circ}$) – Set the external trigger edge to either positive (0) or negative (1).

Push **÷2**, **x2**, and $\frac{\text{ms}}{\text{ms}}$ to make adjustments to each parameter. Push **SETUP** to change parameters and to enter and exit the Setup menu.

Range

When the external trigger is >5 kHz, **-OL-** shows on the display. When the external trigger is <0.5 Hz, **-UL-** shows on the display.

External Trigger

Use the External Trigger Input Connector for outside trigger sources. When the Connector is plugged into the Product (see Figure 1, item ④) the Product displays **External Trigger**. Table 3 shows what options are available when an external trigger is used. For Connector polarity information, see Figure 2.

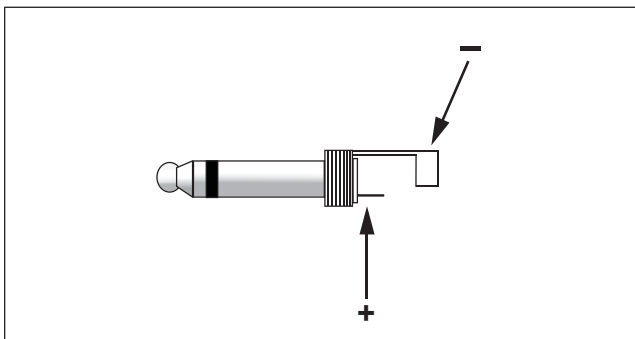

Figure 2. External Trigger Connector Polarity

gsh04.eps

Maintenance

⚠ Caution

The Product contains no user-serviceable parts. To prevent damage to the Product, do not open the case. For service, see “How to Contact Fluke”.

How to Clean the Product

Regularly clean the case with a damp cloth and mild detergent.

⚠ Caution

To prevent damage to the Product, do not use abrasives or solvents to clean the Product case.

How to Change the Batteries

The Product is energized by three AA (LR6) batteries. When the low battery symbol shows on the display () , replace the batteries. See Figure 3.

⚠ Caution

To prevent damage to the Product:

- **Be sure that the battery polarity is correct to prevent battery leakage.**
- **Remove batteries to prevent battery leakage and damage to the Product if it is not used for an extended period.**

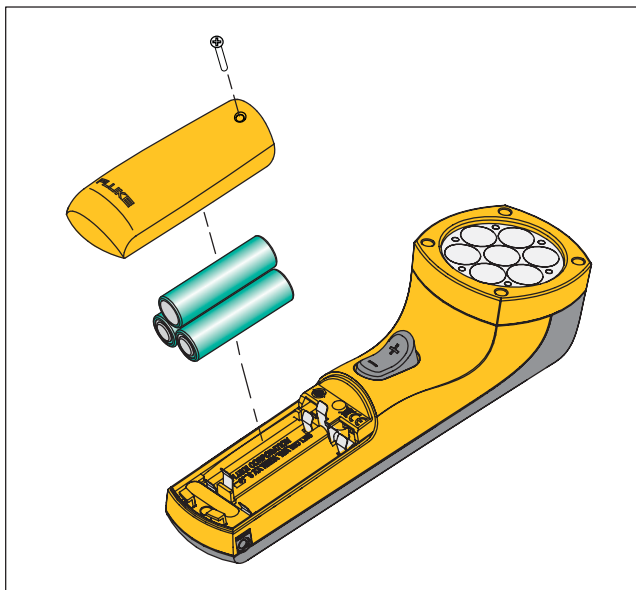

gsh03.eps

Figure 3. Battery Replacement

Specifications

Mechanical Specifications

Size (H x W x L)5.71 cm x 6.09 cm x 19.05 cm
(2.25 in x 2.4 in x 7.5 in)

Weight.....0.24 kg (0.53 lb)

Environmental Specifications

Operating Temperature.....0 °C to +45 °C (+32 °F to +113 °F)

Storage Temperature.....-10 °C to +50 °C (+14 °F to +122 °F)

Operating HumidityNon-condensing, < +50 °F (< +10 °C)

90 %RH, +10 °C to +30 °C
(+50 °F to +86 °F)

75 %RH, +30 °C to +40 °C
(+86 °F to +104 °F)

45 %RH, +40 °C to +50 °C
(+104 °F to +122 °F)

(Without Condensation)

Absorption/Corrosion.....+30 °C (+86 °F), 95 %RH, 5 days

Product functions normally

Operating Altitude2,000 m

Storage Altitude 12,000 m

Vibration.....MIL-PRF-28800F Class 2

Safety IEC 61010-1:Pollution Degree 2

Electromagnetic

Environment IEC 61326-1:Industrial

Group 1 ISM equipment: group 1 contains all ISM equipment in which there is intentionally generated and/or used conductively coupled radio-frequency energy which is necessary for the internal functioning of the equipment itself.

Class A equipment is suitable for use in non-domestic locations and/or directly connected to a low-voltage power supply network. Class A equipment may have potential difficulties in ensuring electromagnetic compatibility in other environments, due to conducted as well as radiated disturbances.

Electromagnetic

Compatibility Applies to use in Korea only.

Class A Equipment (Industrial
Broadcasting & Communication
Equipment)^[1]

- [1] This product meets requirements for industrial (Class A) electromagnetic wave equipment and the seller or user should take notice of it. This Equipment is intended for use in business environments and is not to be used in homes.

Miscellaneous Specifications

Battery Type.....3 x AA Alkaline LR6

Flash Frequency

Range30 FPM to 300,000 FPM
0.5 Hz to 5000 Hz

Accuracy0.02 %

Resolution30 FPM to 999 FPM = 0.1
1000 FPM to 300,000 FPM = 1
0.5 Hz to 999 Hz = 0.1
1000 Hz to 5000 Hz = 1

Frequency SettingFPM or Hz

Flash Pulse

DurationAdjustable in μ s or degrees

DelayAdjustable in ms or degrees

Light

ColorApprox. 6500 K

Emission Output4800 lx @ 6000 FPM
30 cm (11.9 in) at 3°

External Trigger

MethodConnector to externally control trigger

Frequency Range0.5 Hz to 5000 Hz

High Level3 V to 32 V

Low Level<1 V

Minimum Pulse Width ...50 μ s Connection