

# **1736/1738**

Power Logger

## Calibration Manual

## LIMITED WARRANTY AND LIMITATION OF LIABILITY

Each Fluke product is warranted to be free from defects in material and workmanship under normal use and service. The warranty period is two years and begins on the date of shipment. Parts, product repairs, and services are warranted for 90 days. This warranty extends only to the original buyer or end-user customer of a Fluke authorized reseller, and does not apply to fuses, disposable batteries, or to any product which, in Fluke's opinion, has been misused, altered, neglected, contaminated, or damaged by accident or abnormal conditions of operation or handling. Fluke warrants that software will operate substantially in accordance with its functional specifications for 90 days and that it has been properly recorded on non-defective media. Fluke does not warrant that software will be error free or operate without interruption.

Fluke authorized resellers shall extend this warranty on new and unused products to end-user customers only but have no authority to extend a greater or different warranty on behalf of Fluke. Warranty support is available only if product is purchased through a Fluke authorized sales outlet or Buyer has paid the applicable international price. Fluke reserves the right to invoice Buyer for importation costs of repair/replacement parts when product purchased in one country is submitted for repair in another country.

Fluke's warranty obligation is limited, at Fluke's option, to refund of the purchase price, free of charge repair, or replacement of a defective product which is returned to a Fluke authorized service center within the warranty period.

To obtain warranty service, contact your nearest Fluke authorized service center to obtain return authorization information, then send the product to that service center, with a description of the difficulty, postage and insurance prepaid (FOB Destination). Fluke assumes no risk for damage in transit. Following warranty repair, the product will be returned to Buyer, transportation prepaid (FOB Destination). If Fluke determines that failure was caused by neglect, misuse, contamination, alteration, accident, or abnormal condition of operation or handling, including overvoltage failures caused by use outside the product's specified rating, or normal wear and tear of mechanical components, Fluke will provide an estimate of repair costs and obtain authorization before commencing the work. Following repair, the product will be returned to the Buyer transportation prepaid and the Buyer will be billed for the repair and return transportation charges (FOB Shipping Point).

THIS WARRANTY IS BUYER'S SOLE AND EXCLUSIVE REMEDY AND IS IN LIEU OF ALL OTHER WARRANTIES, EXPRESS OR IMPLIED, INCLUDING BUT NOT LIMITED TO ANY IMPLIED WARRANTY OF MERCHANTABILITY OR FITNESS FOR A PARTICULAR PURPOSE. FLUKE SHALL NOT BE LIABLE FOR ANY SPECIAL, INDIRECT, INCIDENTAL OR CONSEQUENTIAL DAMAGES OR LOSSES, INCLUDING LOSS OF DATA, ARISING FROM ANY CAUSE OR THEORY.

Since some countries or states do not allow limitation of the term of an implied warranty, or exclusion or limitation of incidental or consequential damages, the limitations and exclusions of this warranty may not apply to every buyer. If any provision of this Warranty is held invalid or unenforceable by a court or other decision-maker of competent jurisdiction, such holding will not affect the validity or enforceability of any other provision..

Fluke Corporation  
P.O. Box 9090  
Everett, WA 98206-9090  
U.S.A.

Fluke Europe B.V.  
P.O. Box 1186  
5602 BD Eindhoven  
The Netherlands

# Table of Contents

Title	Page
Introduction . . . . .	1
How to Contact Fluke . . . . .	1
Safety Information . . . . .	2
Specifications . . . . .	5
General Specifications . . . . .	5
Environmental Specifications . . . . .	5
Electrical Specifications . . . . .	6
Maintenance . . . . .	10
How to Clean . . . . .	10
Battery Replacement . . . . .	10
Replacement Parts . . . . .	11
Setup . . . . .	12
Required Equipment . . . . .	12
Equipment Assembly . . . . .	13
173x Calibration Cable Assembly . . . . .	13
173x AUX Input Calibration Cable . . . . .	14
Verification Box Assembly . . . . .	16
System Requirements . . . . .	17
USB Communication . . . . .	17
How to Use the Spreadsheet . . . . .	18
Basic Instrument Setup for all Verifications . . . . .	22
Accuracy Verification Procedure . . . . .	23
Voltage Measurement . . . . .	23
Current Measurement . . . . .	24
AUX Input Check . . . . .	25
Optional Verification for Flexi or Clamp (Combined Logger and Probe Specifications) . . . . .	25
173x Auxiliary Input Adapter Verification . . . . .	28
Calibration Adjust Procedure . . . . .	29



# ***List of Tables***

<b>Table</b>	<b>Title</b>	<b>Page</b>
1.	Symbols . . . . .	4
2.	Replacement Parts . . . . .	11
3.	Required Equipment . . . . .	12
4.	173x Calibration Cables, Voltage-to-Current-Input . . . . .	13
5.	173x AUX Input Calibration Cable . . . . .	14
6.	1730 Verification Box . . . . .	16
7.	Dashboard in Excel Worksheet . . . . .	19
8.	Phasor in Excel Worksheet . . . . .	20
9.	Calibration and Verification in Excel Worksheet . . . . .	21
10.	Voltage Verification . . . . .	23
11.	Flexi Current Probe Input Verification . . . . .	24
12.	AUX Input Verification . . . . .	25
13.	Clamp Current Probe Input Verification with 5500A/COIL . . . . .	26
14.	Clamp Current Probe Input Verification with 52120A Coil . . . . .	27
15.	173x AUX Adapter Pin-out . . . . .	28
16.	173x AUX Voltage Divider Input . . . . .	28
17.	AUX Input Verification . . . . .	29



## Introduction

### **⚠⚠ Warning**

**To avoid electric shock or personal injury, do not perform the calibration verification tests or calibration procedures described in this manual unless you are qualified to do so. The information provided in this manual is for the use of qualified personnel only.**

The *1736/1738 Power Logger Calibration Manual* provides all the information necessary to perform basic maintenance and make calibration adjustments.

For complete operating instructions, refer to the *1736/1738 Power Logger Users Manual* on the USB drive provided with your product or at [www.fluke.com](http://www.fluke.com).

## How to Contact Fluke

To contact Fluke, call one of the following telephone numbers:

- Technical Support USA: 1-800-44-FLUKE (1-800-443-5853)
- Calibration/Repair USA: 1-888-99-FLUKE (1-888-993-5853)
- Canada: 1-800-36-FLUKE (1-800-363-5853)
- Europe: +31 402-675-200
- Japan: +81-3-6714-3114
- Singapore: +65-6799-5566
- Anywhere in the world: +1-425-446-5500

Or, visit Fluke's website at [www.fluke.com](http://www.fluke.com).

To register your product, visit <http://register.fluke.com>.

To view, print, or download the latest manual supplement, visit <http://us.fluke.com/usen/support/manuals>.

## Safety Information

A **Warning** identifies hazardous conditions and procedures that are dangerous to the user. A **Caution** identifies conditions and procedures that can cause damage to the Product or the equipment under test.

### Warning

To prevent possible electrical shock, fire, or personal injury:













- Read all safety information before you use the Product.
- Use the Product only as specified, or the protection supplied by the Product can be compromised.
- Comply with local and national safety codes. Use personal protective equipment (approved rubber gloves, face protection, and flame-resistant clothes) to prevent shock and arc blast injury where hazardous live conductors are exposed.
- Examine the case before you use the Product. Look for cracks or missing plastic. Carefully look at the insulation around the terminals.
- Replace the mains power cord if the insulation is damaged or if the insulation shows signs of wear.
- Use Product-approved measurement category (CAT), voltage, and amperage rated accessories (probes, test leads, and adapters) for all measurements.
- Do not use test leads if they are damaged. Examine the test leads for damaged insulation and measure a known voltage.
- Do not use the Product if it is damaged.
- The battery door must be closed and locked before you operate the Product.
- Do not work alone.



- **Use this Product indoors only.**
- **Do not use the Product around explosive gas, vapor, or in damp or wet environments.**
- **Use only the external mains power supply included with the Product.**
- **Do not exceed the Measurement Category (CAT) rating of the lowest rated individual component of a Product, probe, or accessory.**
- **Keep fingers behind the finger guards on the probes.**
- **Do not use a current measurement as an indication that a circuit is safe to touch. A voltage measurement is necessary to know if a circuit is hazardous.**
- **Do not touch voltages >30 V ac rms, 42 V ac peak, or 60 V dc.**
- **Do not apply more than the rated voltage, between the terminals or between each terminal and earth ground.**
- **Measure a known voltage first to make sure that the Product operates correctly.**
- **De-energize the circuit or wear personal protective equipment in compliance with local requirements before you apply or remove the flexible current probe.**
- **Remove all probes, test leads, and accessories before the battery door is opened.**
- **Do not use USB accessories when the Product is installed in environment with wires or exposed metal parts with hazardous live voltage such as in cabinets.**
- **Do not operate the touch screen with sharp objects**
- **Do not use the Product if the protection film on the touch panel is damaged.**
- **Do not touch the metal parts of one test lead when the other is still connected to hazardous voltage.**

Symbols used on the Product and in this manual are explained in Table 1.

**Table 1. Symbols**

Symbol	Description
	Consult user documentation.
	WARNING. RISK OF DANGER.
	WARNING. HAZARDOUS VOLTAGE. Risk of electric shock.
	Earth
	Battery
	Conforms to relevant South Korean EMC standards.
	Conforms to relevant Australian EMC standards.
	Certified by CSA Group to North American safety standards.
	Conforms to European Union directives.
	Double Insulated
<b>CAT II</b>	Measurement Category II is applicable to test and measuring circuits connected directly to utilization points (socket outlets and similar points) of the low-voltage MAINS installation.
<b>CAT III</b>	Measurement Category III is applicable to test and measuring circuits connected to the distribution part of the building's low-voltage MAINS installation.
<b>CAT IV</b>	Measurement Category IV is applicable to test and measuring circuits connected at the source of the building's low-voltage MAINS installation.
 Li-ion	This product contains a Lithium-ion battery. Do not mix with the solid waste stream. Spent batteries should be disposed of by a qualified recycler or hazardous materials handler per local regulations. Contact your authorized Fluke Service Center for recycling information.
	This product complies with the WEEE Directive marking requirements. The affixed label indicates that you must not discard this electrical/electronic product in domestic household waste. Product Category: With reference to the equipment types in the WEEE Directive Annex I, this product is classed as category 9 "Monitoring and Control Instrumentation" product. Do not dispose of this product as unsorted municipal waste.

## Specifications

### General Specifications

**Color LCD Display** ..... 4.3-inch active matrix color TFT, 480 pixels x 272 pixels, resistive touch panel

**Power/Charging/LED Indicator**

#### Warranty

1736/1738 and Power Supply ..... 2 years (battery not included)

Accessories ..... 1 year

**Calibration Cycle** ..... 2 years

#### Dimensions

1736/1738 ..... 19.8 cm x 16.7 cm x 5.5 cm (7.8 in x 6.6 in x 2.2 in)

Power Supply ..... 13.0 cm x 13.0 cm x 4.5 cm (5.1 in x 5.1 in x 1.8 in)

1736/1738 with power supply attached ..... 19.8 cm x 16.7 cm x 9 cm (7.8 in x 6.6 in x 4.0 in)

#### Weight

1736/1738 ..... 1.1 kg (2.5 lb)

Power Supply ..... 400 g (0.9 lb)

**Tamper Protection** ..... Kensington lock

### Environmental Specifications

**Operating Temperature** ..... -10 °C to 50 °C (14 °F to 122 °F)

**Storage Temperature** ..... -20 °C to 60 °C (-4 °F to 140 °F), with battery: -20 °C to 50 °C (-4 °F to 122 °F)

**Operating Humidity** ..... <10 °C (<50 °F) non condensing

10 °C to 30 °C (50 °F to 86 °F) ≤95 %

30 °C to 40 °C (86 °F to 104 °F) ≤75 %

40 °C to 50 °C (104 °F to 122 °F) ≤45 %

**Operating Altitude** ..... 2000 m (up to 4000 m derate to 1000 V CAT II/600 V CAT III/300 V CAT IV)

**Storage Altitude** ..... 12 000 m

**IP Rating** ..... IEC 60529:IP50, in connected condition with protection caps in place

**Vibration** ..... MIL-T-28800E, Type 3, Class III, Style B

#### Safety

IEC 61010-1

IEC Mains Input ..... Overvoltage Category II, Pollution Degree 2

Voltage Terminals ..... Overvoltage Category IV, Pollution Degree 2

IEC 61010-2-033 ..... CAT IV 600 V / CAT III 1000 V

#### Electromagnetic Compatibility (EMC)

International ..... IEC 61326-1: Industrial

CISPR 11: Group 1, Class A

*Group 1: Equipment has intentionally generated and/or uses conductively-coupled radio frequency energy that is necessary for the internal function of the equipment itself.*

*Class A: Equipment is suitable for use in all establishments other than domestic and those directly connected to a low-voltage power supply network that supplies buildings used for domestic purposes. There may be potential difficulties in ensuring electromagnetic compatibility in other environments due to conducted and radiated disturbances.*

*Emissions that exceed the levels required by CISPR 11 can occur when the equipment is connected to a test object.*

Korea (KCC) ..... Class A Equipment (Industrial Broadcasting & Communication Equipment)

*Class A: Equipment meets requirements for industrial electromagnetic wave equipment and the seller or user should take notice of it. This equipment is intended for use in business environments and not to be used in homes.*

USA (FCC) ..... 47 CFR 15 subpart B. This product is considered an exempt device per clause 15.103.

**Wireless Radio with Adapter**

Frequency Range	2412 MHz to 2462 MHz
Output Power	<100 mW

**Electrical Specifications**

**Power Supply**

Voltage Range	nominal 100 V to 500 V (85 V min to 550 V max) using safety plug input
Mains Power	nominal 100 V to 240 V (85 V min to 265 V max) using IEC 60320 C7 input
Power consumption	Maximum 50 VA (max. 15 VA when powered using IEC 60320 input)
Standby Power	<0.3 W only when powered using IEC 60320 input
Efficiency	≥68.2 % (in accordance with energy efficiency regulations)
Mains Frequency	50/60 Hz ±15 %
Battery Power	Li-ion 3.7 V, 9.25 Wh, customer-replaceable
On-Battery Runtime	Up to 4 hr (up to 5.5 hr in energy saving mode)
Charging Time	<6 hr

**Voltage Inputs**

Number of Inputs	4 (3 phases and neutral)
Maximum Input Voltage	1000 V <sub>rms</sub> (1700 V <sub>pk</sub> ) phase to neutral
Input Impedance	10 MΩ each phase to neutral
Bandwidth	42.5 Hz to 3.5 kHz
Scaling	1:1, variable

**Current Inputs**

Number of Inputs	4, mode selected automatically for attached sensor
Current Sensor Output Voltage	
Clamp	500 mV <sub>rms</sub> / 50 mV <sub>rms</sub> ; CF 2.8
Rogowski Coil	150 mV <sub>rms</sub> / 15 mV <sub>rms</sub> at 50 Hz, 180 mV <sub>rms</sub> / 18 mV <sub>rms</sub> at 60 Hz; CF 4; all at nominal probe range
Range	1 A to 150 A / 10 A to 1500 A with iFlex1500-12 3 A to 300 A / 30 A to 3000 A with iFlex3000-24 6 A to 600 A / 60 A to 6000 A with iFlex6000-36 40 mA to 4 A / 0.4 A to 40 A with 40 A clamp i40s-EL
Bandwidth	42.5 Hz to 3.5 kHz
Scaling	1:1, variable

**Auxiliary Inputs**

**Wired Connection**

Number of Inputs	2
Input Range	0 V dc to ± 10 V dc

**Wireless Connection (requires WiFi/BLE adapter USB1 FC)**

Number of Inputs	2
Supported Modules	Fluke Connect 3000 series
Acquisition	1 reading/s
Scale factor	Format: mx + b (Gain and offset) user configurable
Displayed units	User configurable (up to 8 characters, for example °C, psi, or m/s)

**Data Acquisition**

Resolution	16-bit synchronous sampling
Sampling Frequency	10.24 kHz at 50/60 Hz, synchronized to mains frequency
Input Signal Frequency	50/60 Hz (42.5 Hz to 69 Hz)
Wiring Configurations	1-Φ, 1-Φ IT, Split phase, 3-Φ wye, 3-Φ wye IT, 3-Φ wye balanced, 3-Φ delta, 3-Φ Aron/Blondel (2-element delta), 3-Φ delta open leg, 3-Φ high leg delta, 3-Φ delta balanced. Currents only (load studies)
Data Storage	Internal flash memory (not user replaceable)
Memory Size	Typical 10 logging sessions of 8 weeks with 1-minute intervals and 100 events The number of possible logging sessions and logging period depends on user requirements.

**Basic Interval**

Measured Parameter	Voltage, Current, Aux, Frequency, THD V, THD A, Power, Power Factor, fundamental Power, DPF, Energy
Averaging Interval	User selectable: 1 sec, 5 sec, 10 sec, 30 sec, 1 min, 5 min, 10 min, 15 min, 30 min
Total Harmonic Distortion	THD for voltage and current is calculated on 25 harmonics
Averaging time min/max values	
Voltage	Full cycle RMS (20 ms at 50 Hz, 16.7 ms at 60 Hz)
Current	Half cycle RMS (10 ms at 50 Hz, 8.3 ms at 60 Hz)
Aux, Power	200 ms

**Demand Interval (Energy Meter Mode)**

Measured Parameter	Energy (Wh, varh, VAh), PF, Maximum Demand, Cost of Energy
Averaging Interval	User selectable: 5 min, 10 min, 15 min, 20 min, 30 min, off

**Power Quality Measurements**

Measured Parameter	Voltage, Frequency, Unbalance, Voltage Harmonics, THD V, Current Harmonics, THD A, and TDD (requires IEEE 519/Report license)
Averaging Interval	10 min
Individual Harmonics	2 <sup>nd</sup> ... 50 <sup>th</sup>
Total Harmonic Distortion	Calculated on 50 harmonics
Events	Voltage: Dips, Swells, Interruptions Current: Inrush Current
Triggered Recordings	1738 or 1736 with 1736/Upgrade license Half cycle RMS of Voltage and Current Waveform of Voltage and Current

**Standards Compliance**

Harmonics	IEC 61000-4-7: Class 1 IEEE 519 (short time harmonics, requires IEEE 519/Report license)
Power Quality	IEC 61000-4-30 Class S, IEC62586-1 (PQI-S device)
Power	IEEE 1459
Power Quality Compliance	1738 or 1736 with 1736/Upgrade license EN50160 (for measured parameters)

**Interfaces**

USB-A	File transfer via USB Flash Drive, Firmware updates, max. supply current: 120 mA
WiFi	
Supported modes	Direct connection and connection to infrastructure (requires WiFi-Infrastructure license)
Security	WPA2-AES with pre-shared key
Bluetooth	read auxiliary measurement data from Fluke Connect 3000 series modules (requires WiFi/BLE adapter USB1 FC)
USB-mini	Data download device to PC
Extension port	Accessories

Accuracy at Reference Conditions

Parameter		Range	Maximum Resolution	Intrinsic Accuracy at Reference Conditions (% of Reading + % of Range)	
Voltage		1000 V	0.1 V	$\pm(0.2\% + 0.01\%)$	
Current	Direct Input	Rogowski Mode	15 mV	0.01 mV	$\pm(0.3\% + 0.02\%)$
			150 mV	0.1 mV	$\pm(0.3\% + 0.02\%)$
		Clamp Mode	50 mV	0.01 mV	$\pm(0.2\% + 0.02\%)$
			500 mV	0.1 mV	$\pm(0.2\% + 0.02\%)$
	1500 A Flex	150 A	0.01 A	$\pm(1\% + 0.02\%)$	
		1500 A	0.1 A	$\pm(1\% + 0.02\%)$	
	3000 A Flexi	300 A	1 A	$\pm(1\% + 0.03\%)$	
		3000 A	10 A	$\pm(1\% + 0.03\%)$	
	6000 A Flexi	600 A	1 A	$\pm(1.5\% + 0.03\%)$	
		6000 A	10 A	$\pm(1.5\% + 0.03\%)$	
	40 A	4 A	1 mA	$\pm(0.7\% + 0.02\%)$	
		40 A	10 mA	$\pm(0.7\% + 0.02\%)$	
Frequency		42.5 Hz to 69 Hz	0.01 Hz	$\pm 0.1\%$	
Aux Input		10 Vdc	0.1 mV	$\pm(0.2\% + 0.02\%)$	
Voltage Min/Max		1000 V	0.1 V	$\pm(1\% + 0.1\%)$	
Current Min/Max		defined by accessory	defined by accessory	$\pm(5\% + 0.2\%)$	
THD on Voltage		1000 %	0.1 %	$\pm(2.5\% + 0.05\%)$	
THD on Current		1000 %	0.1 %	$\pm(2.5\% + 0.05\%)$	
Voltage Harmonic 2 to 50		1000 %	0.1 %	$\pm(2.5\% + 0.05\%)$	
Unbalance		100 %	0.1 %	$\pm 0.15\%$	

Power/Energy					
Parameter	Direct Input <sup>[1]</sup>	iFlex1500-12	iFlex3000-24	iFlex6000-36	i40S-EL
		Clamp: 50 mV/500 mV Rogowski: 15 mV/150 mV	150 A/1500 A	300 A/3000 A	600/6000 A
Power Range W, VA, var	Clamp: 50 W/500 W Rogowski: 15 W/150 W	150 kW/1.5 MW	300 kW/3 MW	600 kW/6 MW	4 kW/40 kW
Max. Resolution W, VA, var	0.1 W	0.01 kW/0.10 kW	1 kW/10 kW	1 kW/10 kW	1 W/10 W
Max. Resolution PF, DPF	0.01				
Phase (Voltage to Current) <sup>[1]</sup>	±0.2 °	±0.28 °			±1 °

[1] Only for calibration laboratories

Intrinsic Uncertainty ±(% of measurement value + % of power range)						
Parameter	Influence Quantity	Direct Input <sup>[1]</sup>	iFlex1500-12	iFlex3000-24	iFlex6000-36	i40S-EL
			Clamp: 50 mV/500 mV Rogowski: 15 mV/150 mV	150 A/1500 A	300 A/3000 A	600/6000 A
Active Power P Active Energy E <sub>a</sub>	PF ≥ 0.99	0.5 % + 0.005 %	1.2 % + 0.005 %	1.2 % + 0.0075 %	1.7 % + 0.0075 %	1.2 % + 0.005 %
	0.1 ≤ PF < 0.99	$\left(0.5 + \frac{\sqrt{1-PF^2}}{3 \times PF}\right) \% + 0.005 \%$	$\left(1.2 + \frac{\sqrt{1-PF^2}}{2 \times PF}\right) \% + 0.005 \%$	$\left(1.2 + \frac{\sqrt{1-PF^2}}{2 \times PF}\right) \% + 0.0075 \%$	$\left(1.7 + \frac{\sqrt{1-PF^2}}{2 \times PF}\right) \% + 0.0075 \%$	$\left(1.2 + 1.7 \times \frac{\sqrt{1-PF^2}}{PF}\right) \% + 0.005 \%$
Apparent Power S Apparent Energy E <sub>ap</sub>	0 ≤ PF ≤ 1	0.5 % + 0.005 %	1.2 % + 0.005 %	1.2 % + 0.0075 %	1.7 % + 0.0075 %	1.2 % + 0.005 %
Reactive Power Q Reactive Energy E <sub>r</sub>	0 ≤ PF ≤ 1	2.5 % of measured apparent power/energy				
Power Factor PF Displacement Power Factor DPF/cosφ	-	Reading ± 0.025				
Additional uncertainty (% of power high-range)	V <sub>P-N</sub> > 250 V	0.015 %	0.015 %	0.0225 %	0.0225 %	0.015 %

[1] Only for calibration laboratories  
**Reference Conditions:**  
 Environmental: 23 °C ± 5 °C, instrument operating for at least 30 minutes, no external electrical/magnetic field, RH < 65 %  
 Input conditions: Cosφ/PF=1, Sinusoidal signal f=50/60 Hz, power supply 120 V/230 V ± 10 %  
 Current and power specifications: Input voltage 1 ph: 120 V/230 V or 3 ph wye/delta: 230 V/400 V  
 Input current > 10 % of current range  
 Primary conductor of clamps or Rogowski coil in center position  
 Temperature Coefficient: Add 0.1 x specified accuracy for each degree C above 28 °C or below 18 °C

**Example:**

Measurement at 120 V/16 A using an iFlex1500-12 in low range. Power Factor is 0.8.

**Active power uncertainty  $\sigma_p$ :**

$$\sigma_p = \pm \left( \left( \left( 1.2 + \frac{\sqrt{1-0.8^2}}{2 \times 0.8} \right) + 0.005 \% \times P_{Range} \right) \right) = \pm (1.575 \% + 0.005 \% \times 1000 \text{ V} \times 150 \text{ A}) = \pm (1.575 \% + 7.5 \text{ W})$$

The uncertainty in W is  $\pm (1.575 \% \times 120 \text{ V} \times 16 \text{ A} \times 0.8 + 7.5 \text{ W}) = \pm 31.7 \text{ W}$

**Apparent power uncertainty  $\sigma_s$ :**

$$\sigma_s = \pm (1.2 \% + 0.005 \% \times S_{Range}) = \pm (1.2 \% + 0.005 \% \times 1000 \text{ V} \times 150 \text{ A}) = \pm (1.2 \% + 7.5 \text{ VA})$$

The uncertainty in VA is  $\pm (1.2 \% \times 120 \text{ V} \times 16 \text{ A} + 7.5 \text{ VA}) = \pm 30.54 \text{ VA}$

**Reactive/non-active power uncertainty  $\sigma_Q$ :**

$$\sigma_Q = \pm (2.5 \% \times S) = \pm (2.5 \% \times 120 \text{ V} \times 16 \text{ A}) = \pm 48 \text{ var}$$

In case of a measured voltage that is >250 V, the additional error is calculated with:

$$Adder = 0.015 \% \times S_{High Range} = 0.015 \% \times 1000 \text{ V} \times 1500 \text{ A} = 225 \text{ W/VA/var}$$

## Maintenance

If the Logger is used appropriately it does not require special maintenance or repair. Maintenance work may be executed only by trained and qualified personnel. This work may only be done at a company related service center within the guarantee period. See [www.fluke.com](http://www.fluke.com) for locations and contact information of Fluke Service Centers worldwide.

### Warning

To prevent possible electrical shock, fire, or personal injury:

- Do not operate the Product with covers removed or the case open. Hazardous voltage exposure is possible.
- Remove the input signals before you clean the Product.
- Use only specified replacement parts.
- Have an approved technician repair the Product.

## How to Clean

### Caution

To avoid damage, do not use abrasives or solvents on this instrument.

If the Logger is dirty, wipe it off carefully with a damp cloth (without cleaning agents). Mild soap may be used.

## Battery Replacement

The Logger has an internal rechargeable Lithium-ion battery.

To replace the battery:

1. Remove the Power Supply.
2. Unscrew the four screws and remove the battery door.
3. Replace the battery.
4. Fasten the battery door.

### Caution

To prevent damage to the Product, use only original Fluke batteries.



**Replacement Parts**

Replacement parts and accessories are listed in Table 2. To order parts and accessories, see *How to Contact Fluke*.

**Table 2. Replacement Parts**

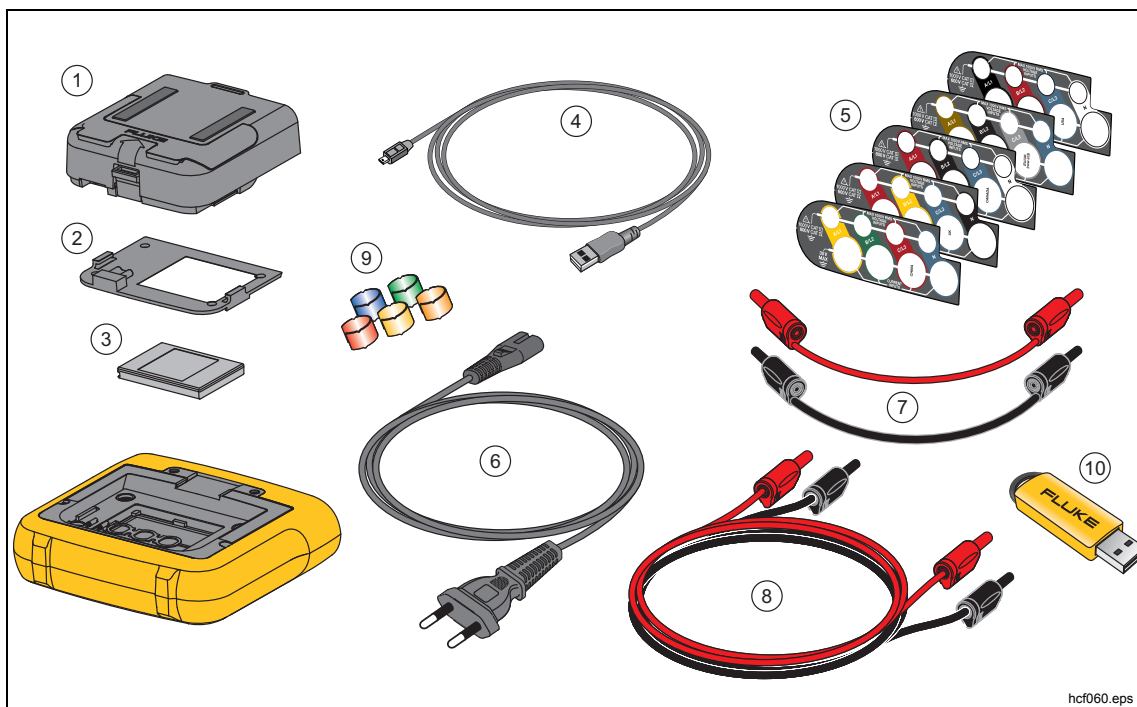

hcf060.eps

Ref.	Description	Qty.	Fluke Part or Model Number
①	Power Supply	1	4743446
②	Battery Door	1	4388072
③	Battery Pack, Li ion 3.7 V 2500 mAh	1	4146702
④	USB Cable	1	1671807
⑤	Input Decal, country specific (US, Canada, Europe/UK, UK/old, China)	1	varies
⑥	Line Cord, country specific (N. American, Europe, UK, Australia, Japan, India/S. Africa, Brazil)	1	varies
⑦	Test Leads 0.1 m Red/Black, 1000 V CAT III	1 set	4715389
⑧	Test Leads 1.5 m Red/Black, 1000 V CAT III	1 set	4715392
⑨	Color-coded Wire Clips	1 set	4394925
⑩	USB Flash Drive (includes User Manuals and installer for PC software)	1	NA

## Setup

Before you start the verification procedures or make calibration adjustments, refer to this section for the equipment, system, and setup requirements.

### Required Equipment

See Table 3 for a list of requirements for the verification tests and calibration adjustment of the Logger.

**Table 3. Required Equipment**

Equipment	Model	Notes	Used on:	
			Verification Tests	Calibration Adjustment
Calibrator	5522A	5520A is also supported	X	X
Cable Assembly	3PHVL-1730	Voltage Test Lead 3-Phase+N	X	X
173x AUX Input Calibration Cable <sup>[1]</sup>	NA		X	X
173x Calibration Cables – Voltage-to-Current Input Cable Assembly <sup>[1]</sup>	NA	Qty. 4 required	X	X
173x Verification Box <sup>[1]</sup>	NA		optional	X
USB cable	type A-to-mini B		X	X
DMM	8846A	for AUX Adapter verification	X	
Coil	5500A/COIL Optional: 52120A with Coils	for Flexi verification	X	
Coil	NA	5 turns	X	
Banana-to-Pin Adapter	Pomona Electronics 4690	for AUX Adapter verification	X	
[1] The 173x calibration cables and verification box are not available from Fluke. See <i>Equipment Assembly</i> for information on how to make these items.				

## Equipment Assembly

The 173x calibration cables and verification box are not available from Fluke. If you plan to calibrate your Product rather than send it to a Fluke Service Center, use the assembly instructions that follow.

### 173x Calibration Cable Assembly

See Table 4 for instructions on how to make the calibration cables.

#### **⚠ Caution**

**Cable must be marked with “max. 30 V to earth.” Any voltage-, category-, or current-ratings on safety plugs must be removed.**

**Table 4. 173x Calibration Cables, Voltage-to-Current-Input**

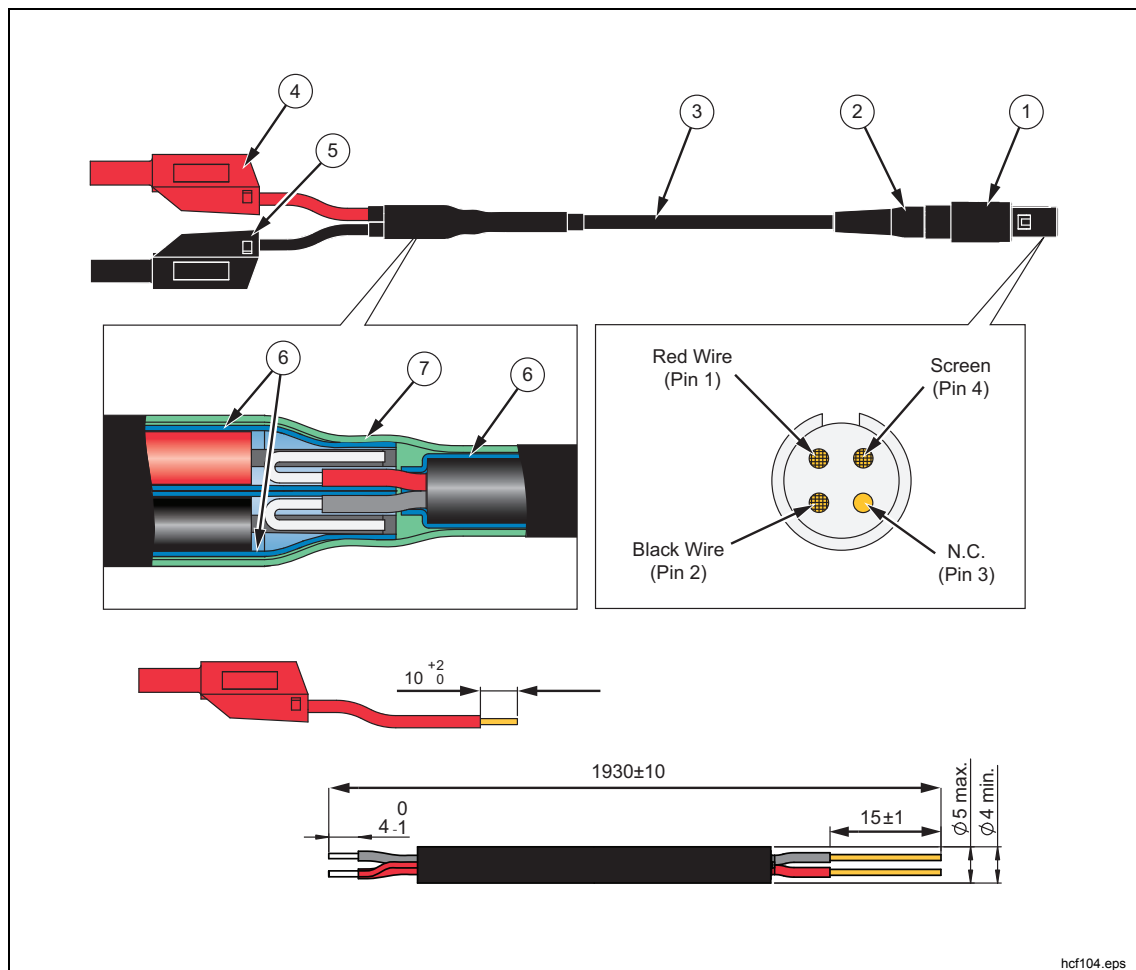

hcf104.eps

Item	Description	Part Number/Info	QTY
①	Straight Plug, IP50, 4-Pole	ODU: S21M08-P04MJG0-528S	1
②	Cable Bend Relief	ODU: 701-023208965-040	1
③	Signal-Cable, 2x AWG 22-24, shielded	Ø4-5 mm (Fluke equiv. # 3803634)	1
④	Test Lead with 4 mm Safety Plug, stackable	red	1
⑤	Test Lead with 4 mm Safety Plug, stackable	black	1
⑥	Heat Shrink Tubing, 2:1	Ø=4.8 mm (3/16"); L=35 mm	3
⑦	Heat Shrink Tubing, 3:1, adhesive	Ø=12 mm (1/2"); L=60 mm	1

### 173x AUX Input Calibration Cable

See Table 5 and Figure 1 for instructions on how to make the calibration cable.

 **Caution**

**Cable must be marked with “max. 30 V to earth.” Any voltage-, category-, or current-ratings on safety plugs must be removed.**

**Table 5. 173x AUX Input Calibration Cable**

Item	Description	Part Number/Info	QTY
①	Binder: Series 620 - Male Cordset, 4-pole, 2 m	Binder: 79 9241 020 04	1
②	Test Lead 0,75 mm <sup>2</sup> /w 4mm Banana Plug, stackable	red	2
③	Test Lead 0,75 mm <sup>2</sup> /w 4mm Banana Plug, stackable	black	2
④	Shrink tube Ø 5-6 mm, black, thin wall, 3:1	L = 30 mm	4
⑤	Shrink tube Ø 8-10 mm, transparent, thin wall, 2:1	L = 45 mm	2
⑥	Shrink tube Ø10-12 mm, black, thin wall, adhesive, 3:1	L = 30135	1
⑦	Shrink tube Ø12-14 mm, black, thin wall, 3:1	L = 110 mm	1

Figure 1. 173x AUX Input Calibration Cable

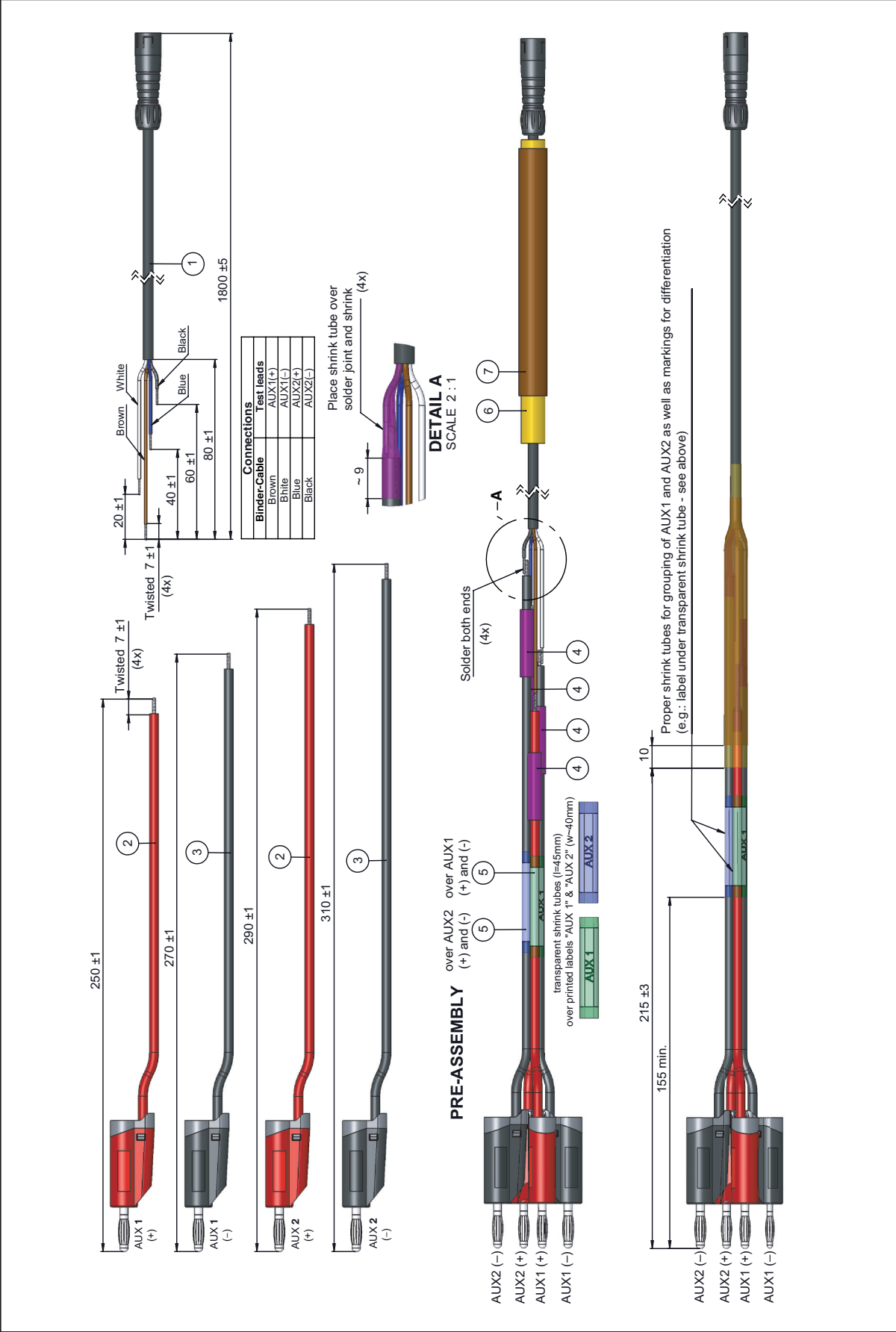

### Verification Box Assembly

This Verification Box provides more accurate voltages than a direct connection to the 5520A. The 5520A uses a divider with a 50  $\Omega$  output impedance when sourcing <330 mV. Due to variations in the Logger input impedance, the actual applied voltage is less than the programmed voltage. Using an external divider where the parallel resistance is  $\sim 30 \Omega$  allows calculation of the applied voltage with confidence that the Logger input loading will not significantly impact the applied voltage.

Fluke recommends using a verification box that has a divider with 30  $\Omega$  across the Logger input and 10 k $\Omega$  in series with high side of the input. See Table 6 for instructions on how to make the verification box.

**Table 6. 1730 Verification Box**

Item	Description	Part Number/Info	Fluke Part Number	QTY
①	Multi-Contact Box: MA 524	Type: XKH-4/19/A Order-No.: 66.9045-33	NA	1
②	Resistor, Metal Foil 10 k $\Omega$ , $\pm 0.1 \%$ , 0.6 W, $\pm 4.5$ PPM	Red Plug/Red Socket	2114858	1
③	Resistor, 30 $\Omega$ , 1W, 1% 20 PPM	Red Socket/Black Socket + Bridge Black Plug/Socket	1757740	1

## **System Requirements**

The system requirements for this verification procedure are:

- WinXP 32-bit, Windows 7 32/64-bit, Windows 8 32/64-bit, Windows 10 32/64-bit
- Monitor, 1280 x 1024 (@4:3) or 1440 x 900 (@16:10), wide-screen (16:10) at higher resolution recommended
- USB 2.0 port
- RS232 port or USB-to-RS232 converter to control the calibrator (optional)
- Microsoft Excel 2010 32-bit software or higher (versions below 2010 not tested)
- Fluke Energy Analyze software

## **USB Communication**

Some of the range changes in the verification require remote commands to set the range. To communicate between the PC and the Logger, the 173x driver must be installed. This driver is installed when the Fluke Energy Analyze (FEA) software is installed.

To find the COM port:

1. Make sure the instrument is powered and connected with the PC.
2. On the PC keyboard, press **Windows** key and type **-R**.
3. Type **devmgmt.msc** and press **ENTER**.
4. Go to **Ports (COM & LPT)** and double-click to open the sub-tree.
5. Find **Fluke 173x Power/Energy Loggers**. The port number is shown in parenthesis after this text, for example, COM6.

A detailed description of the spreadsheet is found in the *How to Use the Spreadsheet* section.

## How to Use the Spreadsheet

The Excel workbook, *Fluke173x-ExcelTool\_Vx.xx.xlsm*, (ExcelTool-available at [www.fluke.com](http://www.fluke.com)), communicates with the Logger using remote commands through the USB ports. The Excel file supports both the 5520A and 5522A Calibrators.

### Note

*The Excel file uses macros. Make sure execution of macros is enabled on your PC. Make sure that Fluke Energy Analyze is closed when using the Excel program. After closing Energy Analyze, disconnect and reconnect the USB cable or turn off and turn on the instrument to reset the communication protocol in the instrument.*

You must know which COM port the Logger uses to communicate.

To find the COM port:

1. Make sure the instrument is powered and connected with the PC.
2. On the PC keyboard, press **Windows** key and type **-R**.
3. Type **devmgmt.msc** and press **ENTER**.
4. Go to Ports (COM & LPT) and double-click to open the sub-tree.
5. Find **Fluke 173x Power/Energy Loggers**. The port number is shown in parenthesis after this phrase, for example, COM6.

The workbook contains sheets for various tasks:

- **Dashboard** – Live measurement parameters, set current input range/mode, COM port configuration
- **Phasor** – Displays a phasor diagram
- **Calibration & Verification** – Procedures to perform the calibration and verification



Dashboard

The Dashboard sheet provides all parameters at a glance that are available with the Meter and Power buttons on the instrument plus the phase angles and calculated Neutral current  $I_N$ . You can configure phase mapping, invert current inputs, and set the hardware range/mode of the current inputs, as well as configure the used COM port in the dashboard. These settings are used also in all other sheets. See Table 7.

Table 7. Dashboard in Excel Worksheet

The screenshot shows the 'Meter (3-ph WYE)' dashboard. It includes sections for Voltage, Current, THD Voltage, THD Current, Voltage Unbalance, Frequency, and Power (3-ph WYE). Callouts 1-7 point to: 1) Start/Update/Reset buttons; 2) Update button; 3) Reset button; 4) COM Port dropdown; 5) Voltage Map and Current Map controls; 6) Range dropdown; 7) Mode dropdown.

Item	Description
①	Start live data read-out. The readings are refreshed every 1 s. Use the same button to stop live updates. During the live updates only the Dashboard and Phasor sheets are accessible.
②	One time live data update.
③	Resets phase mapping and inverted current inputs to default.
④	Selected COM port. Click on the text to get a list of available COM ports. See page 17 for instructions on how to identify the port used by the Logger.
⑤	Phase mapping and inverting current inputs.
⑥	Configure Range as AUTO, High, or Low. Different from the Measurement configuration dialog on the instrument, the settings High and Low can be configured without a connected sensor.
⑦	Configure the current input for Rogowski coils (Flexi coils) or Clamps. When set to AUTO, the attached accessory determines the configuration.

hcf100.eps

Phasor

The Phasor sheet provides live data read-out as a phasor diagram. See Table 8.

Table 8. Phasor in Excel Worksheet

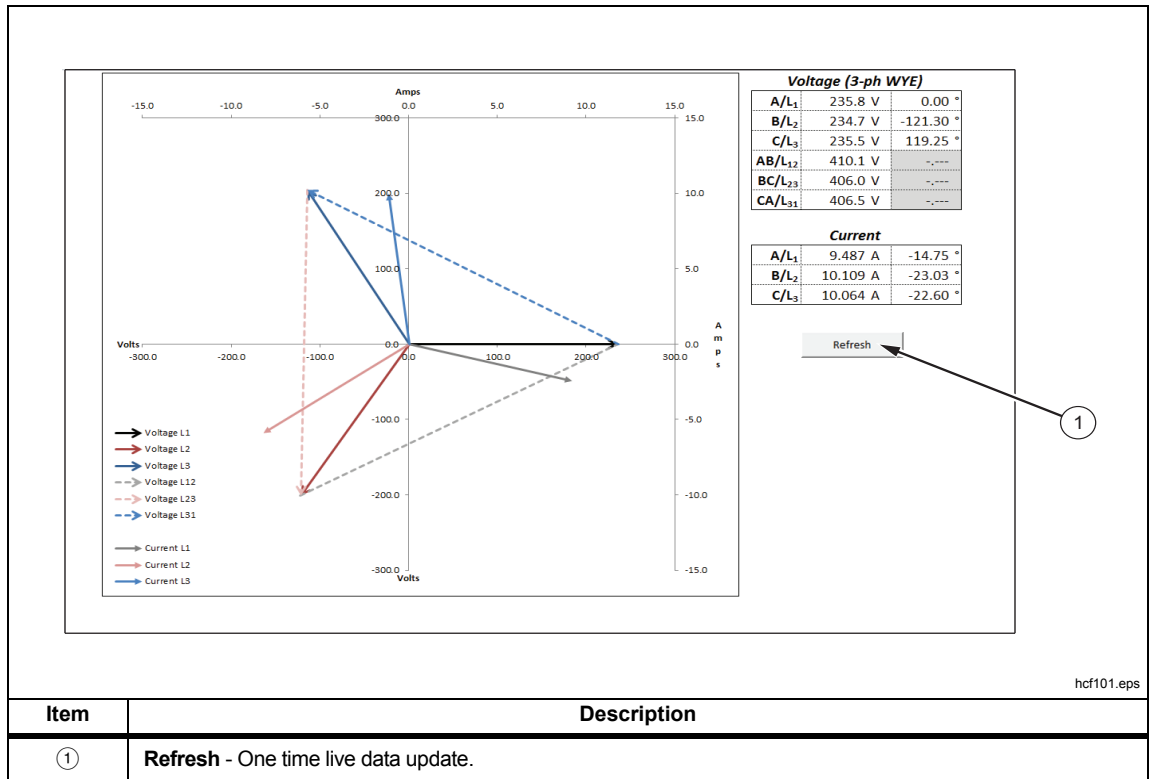

hcf101.eps

Item	Description
①	Refresh - One time live data update.

Calibration and Verification

The Calibration and Verification sheet are the built-in procedures. See Table 9.

Table 9. Calibration and Verification in Excel Worksheet

Item	Description																																																																																
1																																																																																	
	<table border="1"> <thead> <tr> <th>Lower Limit</th> <th>Phase Deviation (°)</th> </tr> </thead> <tbody> <tr><td>0.994</td><td>-0.014°</td></tr> <tr><td>0.994</td><td>-0.023°</td></tr> <tr><td>0.994</td><td>-0.010°</td></tr> <tr><td>0.994</td><td>-0.019°</td></tr> <tr><td>9.967</td><td>-0.041°</td></tr> <tr><td>9.967</td><td>-0.047°</td></tr> <tr><td>9.967</td><td>-0.046°</td></tr> <tr><td>9.967</td><td>-0.050°</td></tr> <tr><td>14.952</td><td>-0.034°</td></tr> <tr><td>14.952</td><td>-0.043°</td></tr> <tr><td>14.952</td><td>-0.041°</td></tr> <tr><td>14.952</td><td>-0.045°</td></tr> <tr><td>3.94</td><td>-0.030°</td></tr> <tr><td>3.94</td><td>-0.023°</td></tr> <tr><td>3.94</td><td>-0.027°</td></tr> <tr><td>3.94</td><td>-0.025°</td></tr> <tr><td>99.67</td><td>-0.045°</td></tr> <tr><td>99.67</td><td>-0.043°</td></tr> <tr><td>99.67</td><td>-0.041°</td></tr> <tr><td>99.67</td><td>-0.043°</td></tr> <tr><td>149.52</td><td>-0.019°</td></tr> <tr><td>149.52</td><td>-0.017°</td></tr> <tr><td>149.52</td><td>-0.017°</td></tr> <tr><td>4.98</td><td>-0.021°</td></tr> <tr><td>4.98</td><td>-0.022°</td></tr> <tr><td>4.98</td><td>-0.018°</td></tr> <tr><td>4.98</td><td>-0.018°</td></tr> <tr><td>4.98</td><td>-0.019°</td></tr> <tr><td>9.97</td><td>-0.029°</td></tr> <tr><td>9.97</td><td>-0.033°</td></tr> <tr><td>9.97</td><td>-0.031°</td></tr> <tr><td>9.97</td><td>-0.032°</td></tr> <tr><td>49.89</td><td>-0.036°</td></tr> <tr><td>49.89</td><td>-0.037°</td></tr> <tr><td>49.89</td><td>-0.037°</td></tr> <tr><td>49.89</td><td>-0.038°</td></tr> <tr><td>49.8</td><td>-0.018°</td></tr> <tr><td>49.8</td><td>-0.015°</td></tr> <tr><td>49.8</td><td>-0.013°</td></tr> </tbody> </table>	Lower Limit	Phase Deviation (°)	0.994	-0.014°	0.994	-0.023°	0.994	-0.010°	0.994	-0.019°	9.967	-0.041°	9.967	-0.047°	9.967	-0.046°	9.967	-0.050°	14.952	-0.034°	14.952	-0.043°	14.952	-0.041°	14.952	-0.045°	3.94	-0.030°	3.94	-0.023°	3.94	-0.027°	3.94	-0.025°	99.67	-0.045°	99.67	-0.043°	99.67	-0.041°	99.67	-0.043°	149.52	-0.019°	149.52	-0.017°	149.52	-0.017°	4.98	-0.021°	4.98	-0.022°	4.98	-0.018°	4.98	-0.018°	4.98	-0.019°	9.97	-0.029°	9.97	-0.033°	9.97	-0.031°	9.97	-0.032°	49.89	-0.036°	49.89	-0.037°	49.89	-0.037°	49.89	-0.038°	49.8	-0.018°	49.8	-0.015°	49.8	-0.013°
Lower Limit	Phase Deviation (°)																																																																																
0.994	-0.014°																																																																																
0.994	-0.023°																																																																																
0.994	-0.010°																																																																																
0.994	-0.019°																																																																																
9.967	-0.041°																																																																																
9.967	-0.047°																																																																																
9.967	-0.046°																																																																																
9.967	-0.050°																																																																																
14.952	-0.034°																																																																																
14.952	-0.043°																																																																																
14.952	-0.041°																																																																																
14.952	-0.045°																																																																																
3.94	-0.030°																																																																																
3.94	-0.023°																																																																																
3.94	-0.027°																																																																																
3.94	-0.025°																																																																																
99.67	-0.045°																																																																																
99.67	-0.043°																																																																																
99.67	-0.041°																																																																																
99.67	-0.043°																																																																																
149.52	-0.019°																																																																																
149.52	-0.017°																																																																																
149.52	-0.017°																																																																																
4.98	-0.021°																																																																																
4.98	-0.022°																																																																																
4.98	-0.018°																																																																																
4.98	-0.018°																																																																																
4.98	-0.019°																																																																																
9.97	-0.029°																																																																																
9.97	-0.033°																																																																																
9.97	-0.031°																																																																																
9.97	-0.032°																																																																																
49.89	-0.036°																																																																																
49.89	-0.037°																																																																																
49.89	-0.037°																																																																																
49.89	-0.038°																																																																																
49.8	-0.018°																																																																																
49.8	-0.015°																																																																																
49.8	-0.013°																																																																																

hcf102.eps

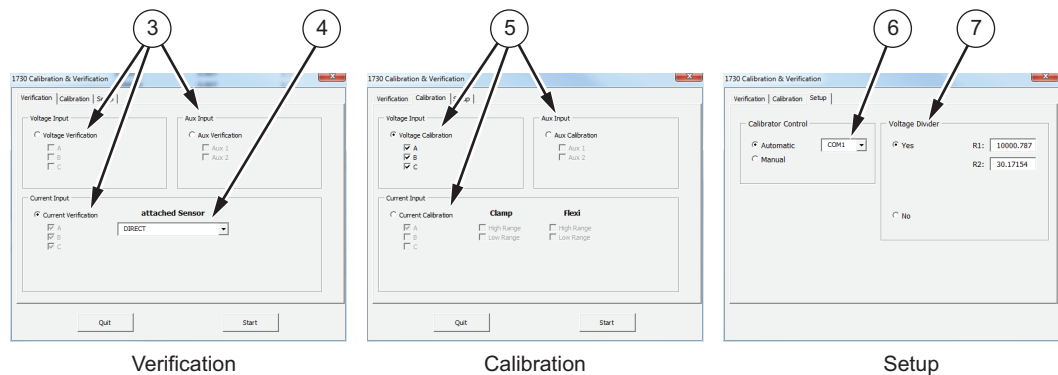

hcf103.eps

1	Start button – When the selection window 2 has been closed with Quit, click the Start button again to open.
2	Selection window – Click on Verification, Calibration, and Setup to select the action. Close the window with Quit. Open again with Start 1.
3	Verification items – Select Voltage Input, AUX Input or Current Input to verify. For a Logger verification, all three items must be verified sequentially. Make sure the sensor selector (4) is set to DIRECT for the Logger verification. A specific order is not required.

**Table 9. Calibration and Verification in Excel Worksheet (cont.)**

Item	Description
④	Sensor selector – select items from the list for a verification of the accessory. Use DIRECT for the Fluke Logger verification.
⑤	Calibration items – Select Voltage, AUX Input or Current input for calibration. For a Logger calibration all three items need to be calibrated sequentially. A specific order is not required.
⑥	Calibrator Control setup – When the calibrator is connected to the PC using a RS232 cable select <i>Automatic</i> to control the calibrator. Use the drop-down list box to configure the COM port. Otherwise select <i>Manual</i> .
⑦	Voltage Divider setup – Configure the resistor values, R1 and R2, of the voltage divider for current verification. Store the Excel workbook to keep the applied values for future use.
Supported Calibrators: Fluke 5520A and 5522A  Calibrator settings: Baud rate: 9600 Data bits: 8 Stop bit: 1 Parity: None Stall:           XON/XOFF EOL: CR/LF	

**Basic Instrument Setup for all Verifications**

The *Fluke173x-ExcelTool\_Vxxx* (ExcelTool) has built-in procedures to verify and adjust the Logger. The Verification uses an external divider. This divider, (see *Verification Box Assembly*) provides more accurate voltages than a direct connection to the 5520A. The 5520A uses a divider with a 50 Ω output impedance when sourcing <330 mV. Due to variations in the Logger input impedance, the actual applied voltage is less than the programmed voltage. Using an external divider where the parallel resistance is ~30 Ω allows calculation of the applied voltage with confidence that the Logger input loading will not significantly impact the applied voltage.

The ExcelTool calculates the voltage that should be applied based on the values entered in the setup screen.

1. Apply power to the Logger using the power supply and line cord.
2. Turn on the Logger.
3. Connect the Logger USB to the PC and start a communication program. See *USB Communication*.
4. Select Measurement Setup as **no voltage transformers used**.

## Accuracy Verification Procedure

The procedure verifies the Power Logger accuracy at ambient temperature 23 °C ±2 K (intrinsic error).

A complete accuracy verification of the Fluke 173x consists of:

- Voltage Measurement
- Current Measurement
- AUX Measurement
- Optional Flexi or Current Clamp Verification

### Voltage Measurement

1. Select the setup (see *Basic Instrument Setup for all Verifications* on page 22).
2. Connect the VL1730 "N" lead to the calibrator NORMAL LO.
3. The Logger must be on battery power with ≥50 % charge.
4. Connect the calibrator NORMAL V output to the VL1730 L1+L2+L3 leads.
5. Sequentially set the calibrator to the voltages indicated in Table 10 and check that the Logger reading is between the limits.
6. Do this for all ranges indicated in Table 10:
  - set the calibrator to supply a 57.0 Hz sine wave for all voltages
  - wait until each reading has stabilized

The spreadsheet is the first choice for readings. Readings will have more resolution from the spreadsheet.

7. Push  to select the Power Logger voltage display.

**Table 10. Voltage Verification**

Nominal Voltage (Range)	Calibrator voltage (57 Hz sine wave)	Minimum Reading ± (1% + 0.1%)	Maximum Reading
1000	10	9.9	10.1
1000	100	99.7	100.3
1000	500	498.9	501.1
1000	1000	998	1002

8. When you are done, set the calibrator to Standby.

## Current Measurement

Fluke recommends using a divider with 30  $\Omega$  across the Logger input and 10 k $\Omega$  in series with high side of the input:

- Fluke PN 2114858 (10 k)
- Fluke PN 1757740 (30  $\Omega$ ) – see Table 6 for the recommended assembly of this divider. Best practice is to measure the resistor values at time of use.

### Caution

**Be careful when you set the calibrator output voltages. High voltages applied to the current input will damage the Logger.**

1. Connect the Voltage-to-Current Input Cable Assembly to the Power Logger current probe input. See Table 4.
2. Connect the VL1730 "N" lead to the calibrator AUX LO.
3. Connect the calibrator AUX HI output to the VL1730 L1+L2+L3 leads.
4. Stack the calibration cables, PN4293284, together: red to red and black to black.
5. Plug the attenuator into the calibrator Normal HI and LO.
6. Connect the stacked calibration cables, PN4293284, to the attenuator. Connect the black leads to NORMAL LO.
7. For all ranges in Table 11, set the calibrator to the voltages indicated in the given order. Check that the values are between the limits.

**Table 11. Flexi Current Probe Input Verification**

Range	Calibrator output <sup>[1]</sup> (57 Hz sine wave, 5V out AUX)	Nominal Reading	Logger Reading Limits
Direct Flexi Low	1.000 mV	1.000 mV	0.994...1.006
	10.000 mV	10.000 mV	9.967...10.033
	15.000 mV	15.000 mV	14.952...15.048
Direct Flexi High	10.00 mV	10.00 mV	9.94...10.06
	100.00 mV	100.00 mV	99.67...100.33
	150.00 mV	150.00 mV	149.52...150.48
Direct Clamp Low	5.00 mV	5.00 mV	4.98...5.02
	10.00 mV	10.00 mV	9.97...10.03
	50.00 mV	50.00 mV	49.89...50.11
Direct Clamp High	50.0 mV	50.0 mV	49.8...50.2
	100.0 mV	100.0 mV	99.7...100.3
	500.0 mV	500.0 mV	498.9...501.1
[1] Calibrator Output Impedance and Logger loading will effect actual voltage being applied. Use of divider and Spreadsheet described above recommended			

8. When you are finished, set the calibrator to Standby.

### AUX Input Check

1. Connect 173x AUX input calibration cable to the Logger AUX inputs.
2. Stack the two red banana plugs together and connect them to the calibrator Normal HI.
3. Stack the two black banana plugs together and connect them to the calibrator Normal LO.
4. For all the voltages in Table 12, set the calibrator and check that the values are between the limits.

**Table 12. AUX Input Verification**

Calibrator Out DC Volts	Lower Limit Vdc	Upper Limit Vdc
-10.0000	-9.9790	-10.0210
-5.0000	-4.9890	-5.0110
-1.0000	-0.9970	-1.0030
-0.5000	-0.4980	-0.5020
-0.1000	-0.0988	-0.1012
-0.0100	-0.00898	-0.01102
0.0100	0.01102	0.00898
0.1000	0.1012	0.0988
0.5000	0.5020	0.4980
1.0000	1.0030	0.9970
5.0000	5.0110	4.9890
10.0000	10.0210	9.9790

5. Set the calibrator to Standby.

### Optional Verification for Flexi or Clamp (Combined Logger and Probe Specifications)

This feature of the spreadsheet checks the Logger combined with current probes. These tests use the 552x and the 5500 Coil, or the 52120A Coil as an option. The Test Uncertainty Ratios (TUR) is typically <2:1. This system can only source 1000 A, consequently, this test will not be made at full-scale of the Flexi probes.

To connect the customer current probes to the Logger:

1. Connect the VL1730 "N" lead to the calibrator NORMAL LO.
2. Connect the calibrator NORMAL V output to the VL1730 L1+L2+L3 leads.
3. Connect the calibrator AUX jacks:
  - For the 5500 Coil verification (see Table 13) connect the 5500 coil to the calibrator and the black jack to AUX LO. For a i40S-EL clamp, connect a 5-turn coil to the calibrator. Connect the red jack to either the AUX jack when <3 A is requested or the 20 A jack when >3 A is requested.
  - For the 52120A Coil verification (see Table 14) connect calibrator AUX HI and LO to the 52120A INPUT HI and LO.
4. Connect the current probes under test:
  - For the 5500 Coil verification through the 5500 Coil with arrows pointing up for the correct phase match.
  - Pass the Flexi, or clamp under test through a single loop, or 3 KA coil, or 6 KA coil, with arrows pointing up for the correct phase match as indicated in the table.
5. The spreadsheet Verification tab has an Attached Sensor drop-down list box to select the probe that is connected.

6. Set the calibrator to source 100 V @ 57 Hz and the appropriate currents for the current probe under test.
  - For the 5500 Coil verification (see Table 13) when the 20 A jack column is “No” when the AUX HI connections should be used; “Yes” when 20 A connection is required. The calibrator switches to the Standby mode when the jack requirement changes.
  - For the 52120A Coil verification (see Table 14) source the voltages listed in the table on the AUX jack, maintaining the 100 V @ 57 Hz out the Normal jacks.

**Table 13. Clamp Current Probe Input Verification with 5500A/COIL**

Type/Range	20 A Jack	5520A current	Applied Signal	Upper Limit	Lower Limit
i40S-EL, Clamp 40A HIGH	No	0.08 A	0.4 A	0.4108	0.3892
i40S-EL, Clamp 40A HIGH	No	0.8 A	4 A	4.036	3.964
i40S-EL, Clamp 40A HIGH	Yes	8 A	40 A	40.288	39.712
i40S-EL, Clamp 40A LOW	No	0.008 A	0.04 A	0.04108	0.03892
i40S-EL, Clamp 40A LOW	No	0.08 A	0.4 A	0.4036	0.3964
i40S-EL, Clamp 40A LOW	No	0.8 A	4 A	4.0288	3.9712
iFlex1500-12, Flexi 1500A HIGH	Yes	20 A	1000 A	1010.3	989.7
iFlex1500-12, Flexi 1500A HIGH	Yes	10 A	500 A	505.3	494.7
iFlex1500-12, Flexi 1500A HIGH	No	2 A	100 A	101.3	98.7
iFlex1500-12, Flexi 1500A LOW	No	2 A	100 A	101.03	98.97
iFlex1500-12, Flexi 1500A LOW	No	0.2 A	10 A	10.13	9.87
iFlex1500-12, Flexi 1500A LOW	No	0.02 A	1 A	1.04	0.96
iFlex3000-24, Flexi 3000A HIGH	Yes	20 A	1000 A	1010.6	989.4
iFlex3000-24, Flexi 3000A HIGH	Yes	10 A	500 A	505.6	494.4
iFlex3000-24, Flexi 3000A HIGH	No	2 A	100 A	101.6	98.4
iFlex3000-24, Flexi 3000A LOW	No	2 A	100 A	101.06	98.94
iFlex3000-24, Flexi 3000A LOW	No	0.2 A	10 A	10.16	9.84
iFlex3000-24, Flexi 3000A LOW	No	0.02 A	1 A	1.07	0.93
iFlex6000-36, Flexi 6000A HIGH	Yes	20 A	1000 A	1016.8	983.2
iFlex6000-36, Flexi 6000A HIGH	Yes	10 A	500 A	509.3	490.7
iFlex6000-36, Flexi 6000A HIGH	No	2 A	100 A	103.3	96.7
iFlex6000-36, Flexi 6000A LOW	No	2 A	100 A	101.68	98.32
iFlex6000-36, Flexi 6000A LOW	No	0.2 A	10 A	10.33	9.67
iFlex6000-36, Flexi 6000A LOW	No	0.02 A	1 A	1.195	0.805



**Table 14. Clamp Current Probe Input Verification with 52120A Coil**

Type/Range	52120A Range	5520A Voltage	Applied Signal	Upper Limit	Lower Limit
i40S-EL, Clamp 40A HIGH	2 A	0.4 V	0.4 A	0.4108	0.3892
i40S-EL, Clamp 40A HIGH	20 A	0.4 V	4 A	4.036	3.964
i40S-EL, Clamp 40A HIGH	120 A	0.4 V	40 A	40.288	39.712
i40S-EL, Clamp 40A LOW	2 A	0.04 V	0.04 A	0.04108	0.03892
i40S-EL, Clamp 40A LOW	2 A	0.4 V	0.4 A	0.4036	0.3964
i40S-EL, Clamp 40A LOW	20 A	0.4 V	4 A	4.0288	3.9712
iFlex1500-12, Flexi 1500A HIGH	120 A + 3 KA COIL <sup>[1]</sup>	0.6 V	1500 A	1015.3	1484.7
iFlex1500-12, Flexi 1500A HIGH	120 A + 3 KA COIL <sup>[1]</sup>	0.32 V	800 A	808.3	791.7
iFlex1500-12, Flexi 1500A HIGH	120 A	1 V	100 A	101.3	98.7
iFlex1500-12, Flexi 1500A LOW	120 A	1.1 V	110 A	111.04	108.6
iFlex1500-12, Flexi 1500A LOW	120 A	0.6 V	60 A	60.9	59.1
iFlex1500-12, Flexi 1500A LOW	2 A	1 V	1 A	1.04	0.96
iFlex3000-24, Flexi 3000A HIGH	120 A + 3 KA COIL <sup>[1]</sup>	1 V	2500 A	2525.9	2474.1
iFlex3000-24, Flexi 3000A HIGH	120 A + 3 KA COIL <sup>[1]</sup>	0.48 V	1200 A	1212.9	1187.1
iFlex3000-24, Flexi 3000A HIGH	120 A	1 V	110 A	101.6	98.4
iFlex3000-24, Flexi 3000A LOW	120 A + 3 KA COIL <sup>[1]</sup>	0.1 V	250 A	253.4	246.6
iFlex3000-24, Flexi 3000A LOW	120 A	1.1 V	110 A	112.0	108.0
iFlex3000-24, Flexi 3000A LOW	2 A	1 V	1 A	1.07	0.93
iFlex6000-36, Flexi 6000A HIGH	120 A + 6 KA COIL <sup>[1]</sup>	1.1 V	5500 A	5584.3	5415.7
iFlex6000-36, Flexi 6000A HIGH	120 A + 6 KA COIL <sup>[1]</sup>	0.5 V	2500 A	2539.3	2460.7
iFlex6000-36, Flexi 6000A HIGH	120 A	1 V	100 A	103.3	96.7
iFlex6000-36, Flexi 6000A LOW	120 A + 6 KA COIL <sup>[1]</sup>	0.11 V	550 A	560.1	540.0
iFlex6000-36, Flexi 6000A LOW	120 A	1.1 V	110 A	113.5	106.6
iFlex6000-36, Flexi 6000A LOW	2 A	1 V	1 A	1.20	0.80
[1] Steps that use coils are for performance check only due to the low TUR (Test Uncertainty Ratio).					

7. When you are done, set the calibrator to Standby.

## 173x Auxiliary Inut Adapter Verification

The Auxiliary Input Adapter has a 1000:1 divider that can be verified with a calibrator and an 8846A. To connect to the Connector pins, use a banana-to-pin adapter (Pomona Electronics 4690 is recommended). See Table 15 and Table 16.

**Table 15. 173x AUX Adapter Pin-out**

Pin	Signal
1	AUX 1 +
2	AUX 1 -
3	AUX 2 +
4	AUX 2 -

**Table 16. 173x AUX Voltage Divider Input**

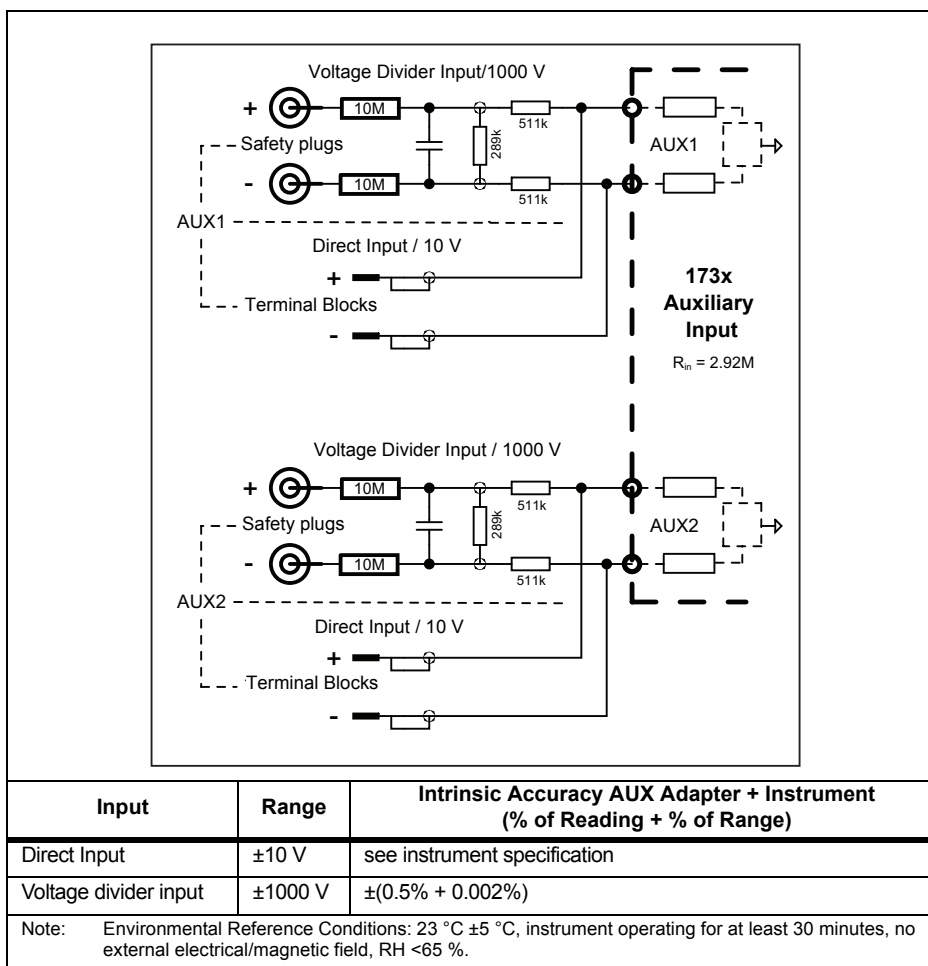

1. Connect the 4-pin connectors AUX 1 + (pin 1) to the 8846A INPUT HI.
2. Connect the 4-pin connectors AUX 1 – (pin 2) to the 8846A INPUT LO.
3. Connect the 173x AUX Adapter box AUX 1 + and AUX 2 + to the calibrator Normal HI
4. Connect the 173x AUX Adapter box AUX 1 – and AUX 2 – to the calibrator Normal LO.
5. Set the 8846A to DC V.
6. Apply the voltages in Table 17.
7. Verify that the AUX 1 readings are between the limits.

8. After the values are checked for AUX 1, move the 4-pin connectors leads to AUX 2; Pin 3 to the 8846A INPUT HI; pin 4 connected to the 8846A INPUT LO.
9. Apply the voltages in Table 17. Verify that the AUX 2 readings are between the limits.

**Table 17. AUX Input Verification**

Calibrator Out DC Volts Vdc	Lower Limit Vdc	Upper Limit Vdc
300.000	2.9848	3.0152
600.000	5.9698	6.0302
990.000	9.8503	909497

10. When finished, set the calibrator to Standby.

### Calibration Adjust Procedure

This procedure adjusts the Logger accuracy at ambient temperature  $23\text{ }^{\circ}\text{C} \pm 2\text{ K}$  (intrinsic error).

The required equipment and cables for calibrating the Product are listed in Table 3. See *USB Communication* for instructions on how to set up the PC.

#### ⚠⚠ Warning

**To avoid electrical shock, personal injury, or fire:**

- **Do not perform the calibration procedures or calibration verification tests described in this manual unless you are qualified to do so.**
- **Repairs or servicing should be performed only by qualified personnel.**

The spreadsheet contains an automated adjust in the *Calibration & Verification* worksheet. When used, it provides connection instructions, can control the calibrator to apply the required voltage, and then will calculate and store the new calibration factors.

When this worksheet is active, the selection box should pop up. If not, click the **Start** button on the upper right of the worksheet.

In the Setup tab, only the calibrator control needs to be set (the Voltage divider is not used in the 173x Adjust).

Select the Calibration tab of the 173x Calibration & Verification pop-up. Choose Voltage, AUX, or Current calibration and check the boxes to select items for adjustment.

1. When selection is complete, click **Start**.
2. Follow the instructions provided in the automated procedure.

When the 173x Calibration & Verification popup box shows again, the calibration factors have been calculated and stored in the Logger .

This concludes the calibration.

