

QRG

FLUKE

True
RMS

T6-1000 PRO Electrical Tester with FieldSense Technology

See Safety Information

Go to www.fluke.com to register your product and find more information, or download this Quick Reference Guide in other languages. General Safety Information is in the printed Safety Information document that ships with the Product. More specific safety information is listed where applicable. Complete specifications are at www.fluke.com.

17.8 mm (0.7 in)

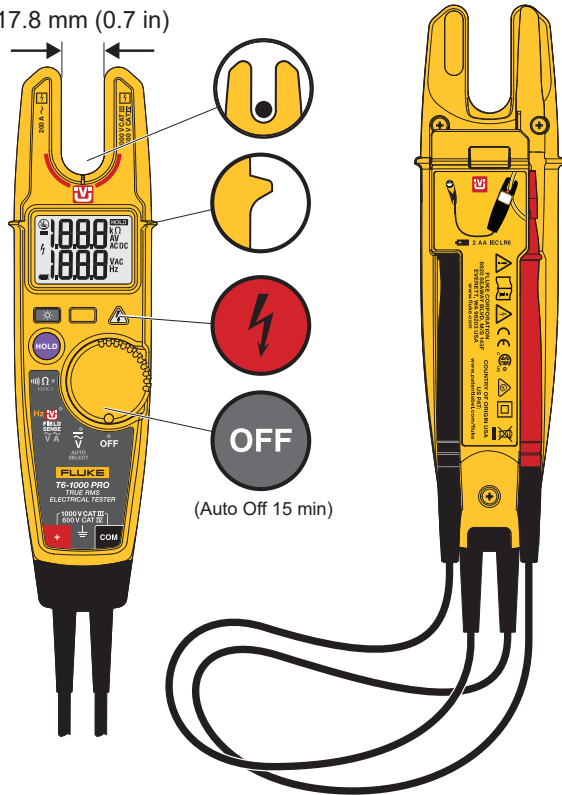

(Auto Off 15 min)

Symbols

	Hazardous voltage ≥ 30 V.
	Test with fork and ground probe or alligator clip.
	Battery full charge.
	Battery low. Replace.
	Back light
	Test with probes.
	No earth ground connection.



Wire Position

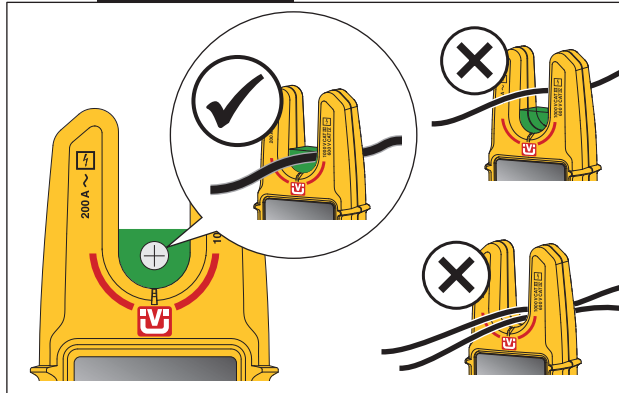

Finger Guard

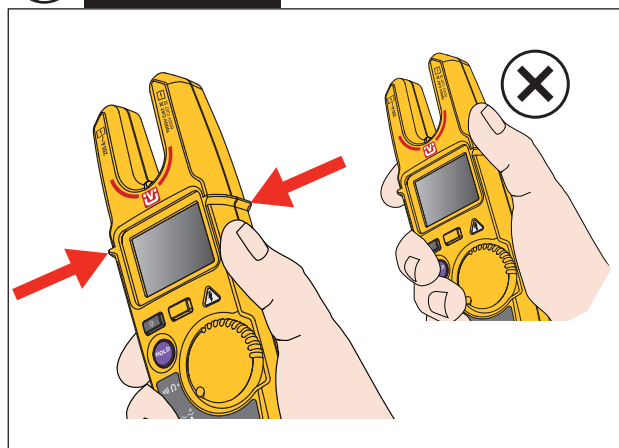

1

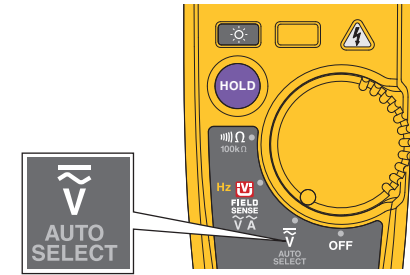

2A

\tilde{V} (AC)

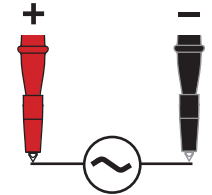

2B

\bar{V} (DC)

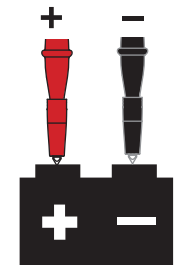

HOLD

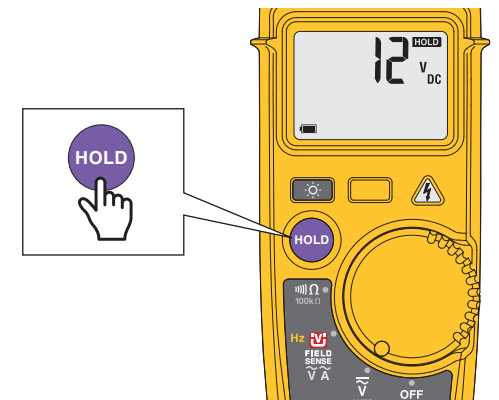

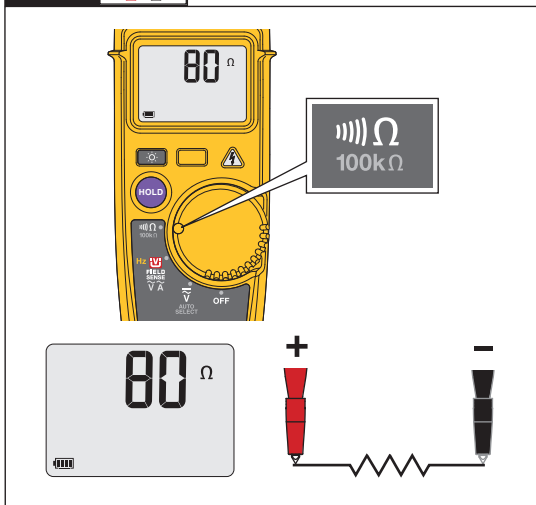
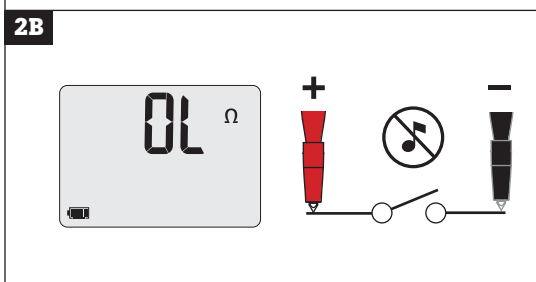
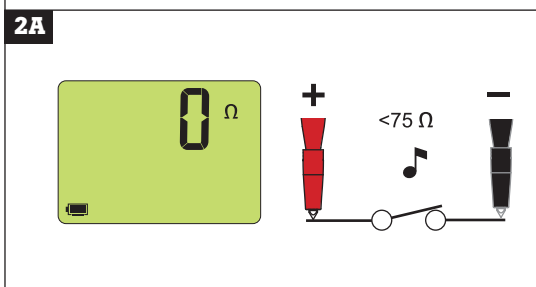
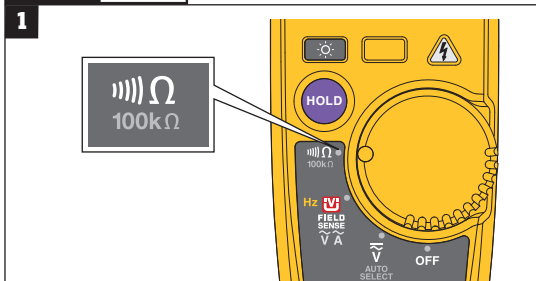
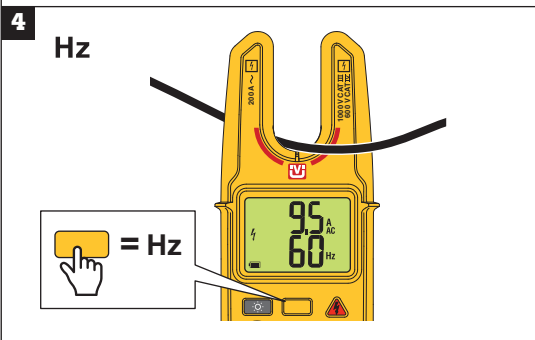
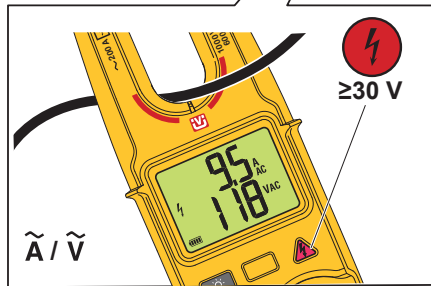
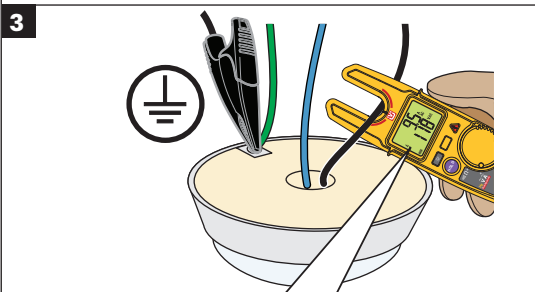
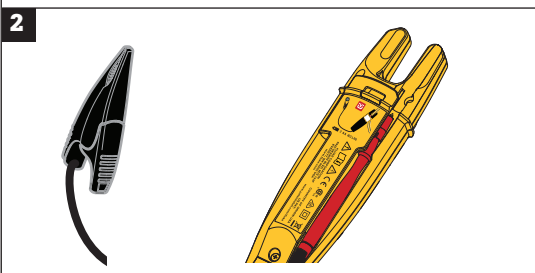
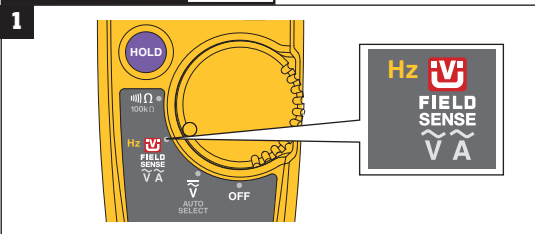

Lead Replacement

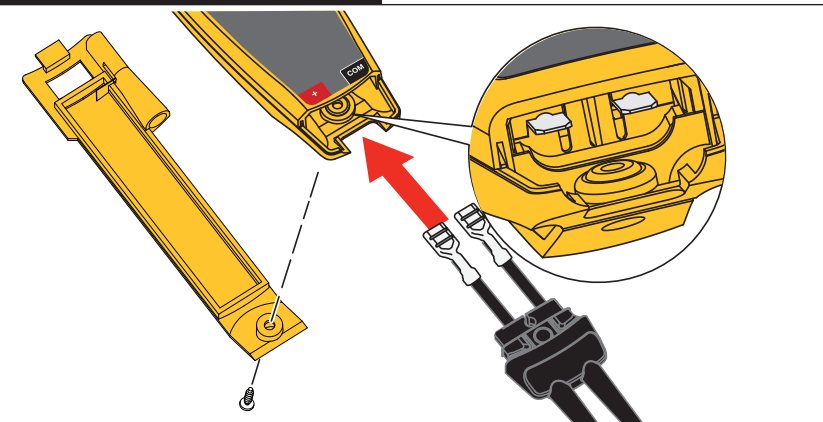

Replacement Parts

Test Lead Assembly (T5-RLS) Replace only with Fluke double-insulated leads.	PN 4462973
TP1 Single Probe, Flat-Tip, Red	PN 648128
TP1 Single Probe, Flat-Tip, Black	PN 648102
TP38 Single Probe, Round-Tip, Red	PN 1276841
TP38 Single Probe, Round-Tip, Black	PN 1276852
Battery Door	PN 5132103
Battery Door Screw	PN 1618578
AC285 Alligator Clip	PN 1610159
H-T6 Belt Holster	PN 4910585

