

TiS10, TiS20, TiS40, TiS45 TiS50, TiS55, TiS60, TiS65

Performance Series Thermal Imagers

Users Manual

July 2015

© 2015 Fluke Corporation. All rights reserved. Specifications are subject to change without notice.

All product names are trademarks of their respective companies.

LIMITED WARRANTY AND LIMITATION OF LIABILITY

Each Fluke product is warranted to be free from defects in material and workmanship under normal use and service. The warranty period is two years and begins on the date of shipment. Parts, product repairs, and services are warranted for 90 days. This warranty extends only to the original buyer or end-user customer of a Fluke authorized reseller, and does not apply to fuses, disposable batteries, or to any product which, in Fluke's opinion, has been misused, altered, neglected, contaminated, or damaged by accident or abnormal conditions of operation or handling. Fluke warrants that software will operate substantially in accordance with its functional specifications for 90 days and that it has been properly recorded on non-defective media. Fluke does not warrant that software will be error free or operate without interruption.

Fluke authorized resellers shall extend this warranty on new and unused products to end-user customers only but have no authority to extend a greater or different warranty on behalf of Fluke. Warranty support is available only if product is purchased through a Fluke authorized sales outlet or Buyer has paid the applicable international price. Fluke reserves the right to invoice Buyer for importation costs of repair/replacement parts when product purchased in one country is submitted for repair in another country.

Fluke's warranty obligation is limited, at Fluke's option, to refund of the purchase price, free of charge repair, or replacement of a defective product which is returned to a Fluke authorized service center within the warranty period.

To obtain warranty service, contact your nearest Fluke authorized service center to obtain return authorization information, then send the product to that service center, with a description of the difficulty, postage and insurance prepaid (FOB Destination). Fluke assumes no risk for damage in transit. Following warranty repair, the product will be returned to Buyer, transportation prepaid (FOB Destination). If Fluke determines that failure was caused by neglect, misuse, contamination, alteration, accident, or abnormal condition of operation or handling, including overvoltage failures caused by use outside the product's specified rating, or normal wear and tear of mechanical components, Fluke will provide an estimate of repair costs and obtain authorization before commencing the work. Following repair, the product will be returned to the Buyer transportation prepaid and the Buyer will be billed for the repair and return transportation charges (FOB Shipping Point).

THIS WARRANTY IS BUYER'S SOLE AND EXCLUSIVE REMEDY AND IS IN LIEU OF ALL OTHER WARRANTIES, EXPRESS OR IMPLIED, INCLUDING BUT NOT LIMITED TO ANY IMPLIED WARRANTY OF MERCHANTABILITY OR FITNESS FOR A PARTICULAR PURPOSE. FLUKE SHALL NOT BE LIABLE FOR ANY SPECIAL, INDIRECT, INCIDENTAL, OR CONSEQUENTIAL DAMAGES OR LOSSES, INCLUDING LOSS OF DATA, ARISING FROM ANY CAUSE OR THEORY.

Since some countries or states do not allow limitation of the term of an implied warranty, or exclusion or limitation of incidental or consequential damages, the limitations and exclusions of this warranty may not apply to every buyer. If any provision of this Warranty is held invalid or unenforceable by a court or other decision-maker of competent jurisdiction, such holding will not affect the validity or enforceability of any other provision.

Fluke Corporation
P.O. Box 9090
Everett, WA 98206-9090
U.S.A.

Fluke Europe B.V.
P.O. Box 1186
5602 BD Eindhoven
The Netherlands

11/99

To register your product online, visit <http://register.fluke.com>.

Table of Contents

Title	Page
Introduction	1
How to Contact Fluke	2
Safety Information.....	2
Operation in Extreme Conditions	3
Radio Frequency Data	3
Accessories	5
SmartView® Software	5
Before You Start	6
Battery	6
Two-Bay Battery Charger Base.....	6
On-Imager AC Power Socket.....	7
Optional 12 V Vehicle Charger.....	7
Features and Controls	8
Power On and Off	10
Controls for Image Capture.....	10
Laser Pointer.....	10
Control Buttons	11
Memory	11
How to Use the Menus.....	12
Image Capture	12

IR-PhotoNotes™	12
Voice Annotation (Recording)	13
Listen to a Voice Annotation (Recording).....	14
Edit Captured Infrared Image.....	14
Save Captured Infrared Image.....	14
Micro SD Memory Card	15
Temperature Measurement	15
Menus.....	16
Measurement Menu	16
Range.....	16
Emissivity Adjustment	18
Background (Reflected Background Temperature Compensation)	19
Transmission/Transmittance Adjustment	19
Spot Temperatures.....	20
User-Definable Spot Markers	20
Center Box	21
Image Menu	22
Palettes	22
IR-Fusion® Technology	23
Color Alarms	24
Display Graphics Presentation	26
Logo	26
Camera Menu	27
Backlight.....	27
Video	27
Auto Capture	28
Memory Menu	29
Review Image Files	29
Edit Image Files.....	29
Delete Image Files	29
Settings Menu	30
Units	30
File Format	30
Auto Off.....	31

Localization	31
Language	32
Wireless Connectivity	32
Image Storage	33
Fluke Connect™ Wireless System	33
Advanced Settings	35
Filename Prefix	35
Reset Filename	35
Factory Defaults	35
Imager Information	35
Adjust Parallax	36
Maintenance	36
How to Clean the Case	36
Lens Care	36
Battery Care	37
General Specifications	38
Detailed Specifications	39

List of Tables

Table	Title	Page
1.	Symbols	4
2.	Accessories	5
3.	Features and Controls	8
4.	Palettes	22
5.	IR-Fusion Modes by Model	23

List of Figures

Figure	Title	Page
1.	Laser Warning	2
2.	Level and Span Settings	17

Introduction

The Fluke TiS10, TiS20, TiS40, TiS45, TiS50, TiS55, TiS60, and TiS65 Thermal Imagers (the Product or Imager) are handheld, infrared imaging cameras for use in multiple applications. These applications include equipment troubleshooting, preventive and predictive maintenance, building diagnostics, and research and development.

Productivity Features

- Voice Annotation/Reviewable playback on Imager (requires Bluetooth headset)
- IR-PhotoNotes™
- Fluke Connect™ / WiFi connectivity
- Streaming video

Image Presentation

- Standard Palettes and Ultra Contrast™ Palettes (availability varies by model)

IR-Fusion® Technology

- Automatically aligned (parallax corrected) visual and infrared
- Picture-In-Picture (PIP) infrared
- Full screen infrared
- AutoBlend™ mode
- Full screen visible
- Color alarms (temperature alarms) for user-selectable high temperature and low temperature (availability varies by model)

How to Contact Fluke

To contact Fluke, call one of the following telephone numbers:

- USA: 1-800-760-4523
- Canada: 1-800-36-FLUKE (1-800-363-5853)
- Europe: +31 402-675-200
- Japan: +81-3-6714-3114
- Singapore: +65-6799-5566
- Anywhere in the world: +1-425-446-5500

Or, visit Fluke's website at www.fluke.com.

To register your Product, visit <http://register.fluke.com>.

To view, print, or download the latest manual supplement, visit <http://us.fluke.com/usen/support/manuals>.

To download SmartView® software visit www.fluke.com/smartviewdownload.

To download the Fluke Connect™ app, go to iTunes or Google play and download Fluke Connect.

Safety Information

A **Warning** identifies conditions and procedures that are dangerous to the user. A **Caution** identifies conditions and procedures that can cause damage to the Product or the equipment under test.

Warning

To prevent eye damage and personal injury:

- **Do not look into the laser. Do not point the laser directly at persons or animals or indirectly off reflective surfaces.**
- **Do not open the Product. The laser beam is dangerous to eyes. Have the Product repaired only through an approved technical site.**

Additional laser warning information is on the inside of the lens cover, see Figure 1.



hwj010.eps

Figure 1. Laser Warning

⚠ Warning

To prevent personal injury:

- Read all safety information before you use the Product.
- Carefully read all instructions.
- Use the Product only as specified, or the protection supplied by the Product can be compromised.
- Replace the batteries when the low battery indicator shows to prevent incorrect measurements.
- Do not use the Product if it operates incorrectly.
- Do not use the Product if it is damaged.
- See emissivity information for actual temperatures. Reflective objects result in lower than actual temperature measurements. These objects pose a burn hazard.
- Do not use the Product around explosive gas, vapor, or in damp or wet environments.

⚠ Caution

To prevent damage to the camera, do not point directly at the sun or other intense light sources.

Operation in Extreme Conditions

Storage and/or continual operation of the Imager in extreme ambient temperature conditions can result in temporary interruption of operation. If this occurs, let the Imager stabilize (cool down or warm up) before you resume operation.













Radio Frequency Data

The Imager ships with the radio disabled. See *Wireless Connectivity* for instructions on how to enable the radio. See *Imager Information* for instructions on how to access digital copies of the radio licenses on the Imager.

For more information, go to www.fluke.com and search for Radio Frequency Data for Class A.

Table 1 is a list of symbols used on the Imager and in this manual.

Table 1. Symbols

Symbol	Description	Symbol	Description
	Risk of Danger. Important information. See manual.		WARNING. LASER RADIATION. Risk of eye damage.
	Connected to ac power. Battery removed.		Battery status. Battery charging when animated.
	On/Off Symbol		Conforms to European Union directives.
	Japan Quality Association		Certified by CSA Group to North American safety standards.
	Conforms to relevant South Korean EMC standards.		Conforms to relevant Australian EMC standards.
	This Product contains a lithium-ion battery. Do not mix with the solid waste stream. Spent batteries should be disposed of by a qualified recycler or hazardous materials handler per local regulations. Contact your authorized Fluke Service Center for recycling information.		
	This product complies with the WEEE Directive marking requirements. The affixed label indicates that you must not discard this electrical/electronic product in domestic household waste. Product Category: With reference to the equipment types in the WEEE Directive Annex I, this product is classed as category 9 "Monitoring and Control Instrumentation" product. Do not dispose of this product as unsorted municipal waste.		

Accessories

Table 2 is a list of the accessories available for the Imager.

Table 2. Accessories

Model	Description	Part Number
FLK-TI-SBP3	Smart Battery Pack	3440365
FLK-TI-SBC3B	Charging Base/Power Supply with Adapters	4354922
TI-CAR CHARGER	12 V Vehicle Charger Adapter	3039779
FLK-TI-TRIPOD3	Tripod Mounting Accessory	4335389
FLK-Bluetooth	Bluetooth Headset	4603258
BOOK-ITP	Introduction to Thermography Principles	3413459

SmartView® Software

SmartView® software is supplied with the Imager and is available for free download at www.fluke.com/smartviewdownload. This software is intended for Fluke Imagers and contains features to analyze images, organize data and information, and make professional reports. SmartView allows audio annotations and photos from the IR-PhotoNotes™ annotation system

to be reviewed on a PC. SmartView is used to export IR and visible images as .jpeg, .jpg, .jpe, .jfif, .bmp, .gif, .dib, .png, .tif, or .tiff formatted files.

SmartView Mobile Software is also available for flexibility away from your PC or in the field.

Before You Start

Carefully unpack the items in the shipment box:

Item	TiS10, TiS20	TiS40	TiS45	TiS50, TiS55	TiS60, TiS65
Two-Bay Battery Charge Base					●
Lithium-ion Smart Battery	●	●	●	●	● x2
Hard Carrying Case		●	●	●	●
Soft Case	●	●	●	●	●
Micro SD Card and Adapter			●	●	●
AC Power Supply with Mains Adapters	●	●	●	●	●
Mini USB-to-USB Cable	●	●	●	●	●
Quick Reference Guide	●	●	●	●	●
Safety Information	●	●	●	●	●
Users Manual, SmartView® Software (on USB Drive)	●	●	●	●	●

Fluke recommends the removable memory card that is supplied with the Imager or available from Fluke. Fluke does not warrant the use or reliability of aftermarket memory cards of different brands or capacities.

To request a printed manual, email Fluke at TPubs@fluke.com. Specify the product name and language preference in the subject line.

Battery

Before you use the Imager for the first time, charge the battery for a minimum of 2.5 hours. The battery status shows on the four-segment charge indicator.

Warning

To prevent personal injury, do not put battery cells and battery packs near heat or fire. Do not put in sunlight.

Note

New batteries are not fully charged. Two to ten charge/discharge cycles are necessary before the battery charges to its maximum capacity.

To charge the battery, use one of the options that follow:

Two-Bay Battery Charger Base



1. Connect the ac power supply to the ac wall outlet and connect the dc output to the charger base.
2. Put one or two smart batteries into bays of charger base.
3. Charge batteries until charge indicators show “full.”
4. Remove smart batteries and disconnect the power supply when batteries are fully charged.

On-Imager AC Power Socket

1. Connect the ac power adapter into an ac wall outlet and connect the dc output to the Imager's external power socket.  flashes on the display while the battery charges with the ac power adapter.
2. Charge until the charge indicator on the display does not flash.
3. Disconnect ac power adapter when the smart battery is fully charged.

Note

Make sure that the Imager is near room temperature before you connect it to the charger. See the charging temperature specification. Do not charge in hot or cold areas. When you charge the battery in extreme temperatures, battery capacity may be decreased.

 shows in the lower left-hand corner of the display when the Imager is connected to external power and the battery is removed. When the Imager's power is off and the ac power adapter is connected,  flashes in the center of the display to show that the battery charge is in process.

Keep the Imager attached to the charger until the  icon shows a full charge. If you remove the Imager from the charger before a full charge shows, it may have a reduced run-time.

Note

When the battery is connected to ac power or the unit is in video mode, the Sleep Mode/Auto Off feature is disabled automatically.

Optional 12 V Vehicle Charger

1. Connect the 12 V adapter into the 12 V accessory socket of the vehicle.
2. Connect the output to the external power socket of the Imager.
3. Charge until the indicator until the  icon shows a full charge on the screen.
4. Disconnect the 12 V adapter and Imager when battery is fully charged.

⚠ Caution

To prevent damage to the Imager, remove the Imager from the 12 V vehicle charger before you start or jump start the vehicle.

Features and Controls

Table 3 shows the Imager features and controls.

Table 3. Features and Controls

Item	Description
①	Arrow Buttons
②	Function Buttons (F1, F2, and F3)
③	Display
④	Memory View Button
⑤	Power On/Off Calibration-On-Demand
⑥	Hand Strap Anchor
⑦	USB Cable Connection
⑧	Removable Micro SD Memory Card Slot
⑨	AC Adapter/External Power Socket

Table 3. Features and Controls (cont.)

Item	Description
⑩	Retractable Lens Cover
⑪	Infrared Camera Lens
⑫	Visual Light Camera Lens
⑬	Laser Pointer (Models TiS45, TiS50, TiS55, TiS60, TiS65)
⑭	Secondary Trigger
⑮	Primary Trigger
⑯	Manual Focus Control (Models TiS45, TiS55, TiS65)
⑰	Lithium-ion Smart Battery
⑱	AC Power Supply with Mains Adapters
⑲	2-Bay Battery Charge Base

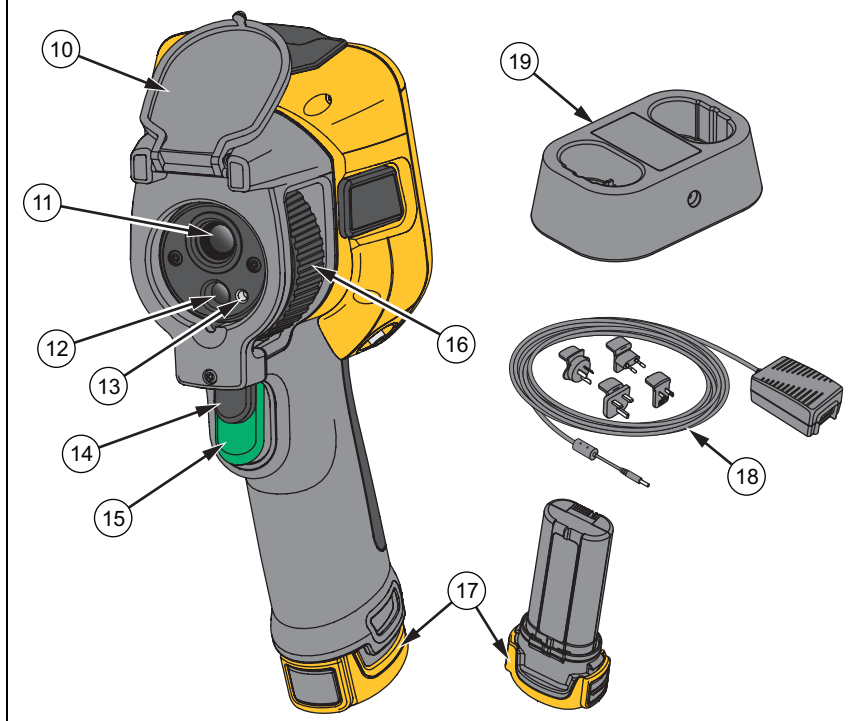

hxx002.eps

Power On and Off

To turn on or turn off the Imager, push and hold  for >3 seconds. The Imager has Power Save and Auto Off features. For more information about how to set these features, see *Settings Menu*.

Note

All thermal imagers need sufficient warm-up time for the most accurate temperature measurements and best image quality. This time can often vary by model and by environmental conditions. Although most imagers are fully warmed up in 3-5 minutes, it is always best to wait a minimum of 10 minutes if the most accurate temperature measurement is important to your application. When you move the Imager between environments with large differences in ambient temperature, more adjustment time can be required.

The Imager includes a calibration on-demand feature that causes a calibration event to occur when you press  once briefly during operation. This feature provides the best accuracy and avoids disruption of a timing-sensitive image capture by the next automatic calibration.

Controls for Image Capture

The two-part trigger is located in the standard trigger position for a pistol-grip device. The larger, green trigger is the primary trigger. The smaller, black trigger is the secondary trigger.

In normal operation (video is off), the function of the primary trigger is to capture a thermal image for possible storage to memory by the user. When video is on, the primary trigger is the start/stop for video recording.

The secondary trigger operates the laser on supported models.

Laser Pointer

The TiS45, TiS50, TiS55, TiS60, and TiS65 models include a laser pointer. The laser pointer is a sighting aid and is offset from the infrared camera. As a result, it may not always represent the exact center of the infrared or visible image.

The laser dot does not appear on an infrared-only image, but does on visible-only or AutoBlend images. The laser dot cannot be seen in the visible channel of the IR-Fusion image if obscured by the center point marker graphic.

Pull the secondary trigger to turn on laser pointer, release the secondary trigger to turn off the laser pointer.

Control Buttons

The function and cursor buttons are the primary controls. These buttons move the cursor through the menu structure to set the features.

Controls and Adjustments





- User-selectable temperature scale
- Language/localization selection
- Time and date settings
- Emissivity selection
- Reflected background temperature compensation
- Transmission correction
- User-selectable hot spot and cold spot, and center point on the image
- Expand/contract measurement box with MIN-AVG-MAX
- Color alarms
- User-selectable backlight setting
- Graphic information display (selectable)

In general, push:

 to set the change and go back to the live view.

 to set the change and go back to the previous menu.

 to cancel the change and go back to the live view.

    to move the cursor and highlight an option.

In live Manual Mode, the arrow buttons are always active to adjust Level and Span.

Memory

Push  to go directly to the preview images of stored files. See page 29 for more information about the Memory feature.

Warning

To prevent eye damage and personal injury, do not look into the laser. Do not point the laser directly at persons or animals or indirectly off reflective surfaces.

The laser warning symbol () shows in the Header zone of the display when the laser is turned on and you pull the secondary trigger.

How to Use the Menu

The menu, coupled with the function buttons and arrow buttons, are the access point for:

- Thermal image display
- Camera features
- Measurement
- Advanced functions
- Memory review
- Settings for date, time, language, units, file format
- Information about the Imager

To open the primary menu, push **F2**. The primary menu shows these secondary menus: Measurement, Image, Camera, Memory, and Settings. The text labels on the bottom edge of the screen correspond to the **F1**, **F2**, **F3** buttons. You can use the buttons for these functions:

- Push **F2** to open the primary menu.
- Push **▲ ▼ ◀ ▶** to cycle through the secondary menus. Each secondary menu lists an options menu.
- Push **▲ ▼ ◀ ▶** to cycle through the options.

The primary and secondary menus close 10 seconds after the last push of a function button. The option selection menu stays open until you make the selection, go up a menu level, or cancel the action.

Image Capture

Point the Imager at the target object. Make sure that the object is in focus. Pull and release the primary trigger. This will capture and freeze the image. To cancel the captured image, pull the primary trigger again or **F3** to return to the Live view.

Depending on the selected file format settings, the Imager shows the captured image and a menu bar. The menu bar lets you save the image, edit some image settings, and add voice annotation or IR-PhotoNotes™ digital photos. To change the file format, see *File Format* on page 30.

IR-PhotoNotes™

Depending on the model, use the IR-PhotoNotes™ photo annotation system to capture and add up to three visible (digital) images of various objects:

Model:	# of images:
TiS60, TiS65	3
TiS50, TiS55	1
TiS40, TiS45, TiS10, TiS20	feature not available

You can include text or other information that is related to the analysis and reporting of the infrared image. Examples of possible annotations include motor name plates, printed information or warning signs, larger views of the environment or room, and related equipment or objects. Up to three images can be captured with the visible image that is stored in addition to the aligned infrared and visible images used in IR-Fusion® technology. These visible images are only available in the .is2 file format and are

stored in the file so you do not need to collate multiple files at a later time.

To add photos using the IR-PhotoNotes annotation system:

1. With an infrared image in the buffer, push **F2** to open the **EDIT IMAGE** menu.
2. Push **▲/▼** to highlight **IR-PhotoNotes**.
3. Push **F1** to enter the Picture mode.
4. Focus the Imager on the object and push the Image Capture button.
5. Push **F2** when done.
6. Push the Image Capture button to capture additional pictures.
7. Push **F1** save the pictures with the image.



Voice Annotation (Recording)

A Bluetooth headset (sold separately) is required and the radio must be enabled for voice (audio) recording. This feature may not be available in all regions. (Not available on the TiS10 and TiS20 models.)

To record:

1. With an infrared image in the buffer, push **F2** to open the **EDIT IMAGE** menu.
2. Push **▲/▼** to highlight **Add Audio**.
3. Push **F1** to record up to 60 seconds of audio. The display updates to show the recorded time.
4. Push **F1** to pause the recorder.
5. Push **F2** when done.
6. Push **F1** to review the audio file or **F2** to save the audio with the image.

Voice annotation is only available in the .is2 file format and is stored in the file so you do not need to collate multiple files at a later time.

Listen to a Voice Annotation (Recording)

The  icon identifies each file that has a voice annotation. The voice (audio) recording replays through a Bluetooth headset or when you use SmartView software.

To play back:





1. Do the steps in the *Review Image Files* section on page 29 to see the image on the display.
2. Push **F1**.
3. Push **F1** to set **Audio**.
4. Push **F1** to listen to the audio.
5. Push **F1** again to pause the audio.

Edit Captured Infrared Image

Before you save a file, use the Imager to edit or modify the image. You can add IR-PhotoNotes (not available on all models), voice annotation, and text annotation as well as change the palette and IR Fusion mode.

A Bluetooth headset is required and the radio must be enabled for voice (audio) annotation. This feature may not be available in all regions.

To edit:

1. With an image in the buffer, push **F2** to open the EDIT IMAGE menu.
2. Push / to highlight **Edit Image**.
3. Push  to open the EDIT IMAGE menu.
4. Push / to highlight an option.
5. Push **F1** to save the changes with the file.

Save Captured Infrared Image

To save an image as a data file:

1. Focus on the object of interest or inspection area.
2. Pull the trigger to capture the image. The image is now in the buffer and you can save or edit.
3. Push **F1** to save the image as a file and go back to the live view.

Micro SD Memory Card

To eject a Micro SD memory card, push in on the exposed edge of the card and then release. The card should pop partially out after you release it. Carefully pull the card out of the slot.

To insert the Micro SD memory card, push the card in until it catches.

The Micro SD memory card includes an SD adapter for insertion into a PC or multi-function card reader.

For information about how to save data, see page 14. For information about how to view or erase a stored image, see page 29.

Temperature Measurement

All objects radiate infrared energy. The quantity of energy radiated is based on the actual surface temperature and the surface emissivity of the object. The Imager senses the infrared energy from the surface of the object and uses this data to calculate an estimated temperature value. Many common objects and materials such as painted metal, wood, water, skin, and cloth are very good at radiating energy and it is easy to get relatively accurate measurements. For surfaces that are good at radiating energy (high emissivity), the emissivity factor is $\geq 90\%$ (or 0.90). This simplification does not work well on shiny surfaces or unpainted metals as they have an emissivity of < 0.60 . These materials are not good at radiating energy and are classified as low emissivity. To more accurately measure materials with a low emissivity, an emissivity correction is necessary. Adjustment to the emissivity setting will usually allow the Imager to calculate a more accurate estimate of the actual temperature.

⚠ Warning

To prevent personal injury, see emissivity information for actual temperatures. Reflective objects result in lower than actual temperature measurements. These objects pose a burn hazard.

More information is available on emissivity at <http://www.fluke.com/emissivity> and <http://www.fluke.com/emissivityexplanation>. Fluke recommends the study of this topic to get the most accurate temperature measurements.

Menus

The menus are the access points for thermal image display, camera features, memory setup, and settings for date, time, language, units, file format, and Imager information.

Measurement Menu

The Measurement Menu has settings for the calculation and display of radiometric temperature measurement data related to the thermal images. These settings include the Temperature Range selection, Level/Span adjustment, Emissivity, Background, Transmission, Spot Temperatures, Center Box, and Markers.

Range

Range (level and span) is set to automatically adjust or is set for manual adjustment. To choose between automatic or manual level and span, do the following:

1. Push **F2**.
2. Push **▲/▼** to highlight **Measurement**.
3. Push **F1** or **▶** to view the menu.
4. Push **▲/▼** to highlight **Set Level/Span**.
5. Push **F1** or **▶** to view the menu.
6. Push **▲/▼** to toggle between the Auto and Manual ranging.
7. Push **F1** to set.

8. Push:

- **F1** to set the change and go back to the live view.
- **F2** or **◀** to set the change and go back to the previous menu.
- **F3** to cancel the change and go back to the live view.

Fast Auto/Manual Range Toggle

When NOT in a menu mode, push **F1** for 3 seconds to toggle between Auto Range and Manual Range.

Fast Auto Rescale

When in Manual Range and NOT in a menu mode, push **F3** for $<1/2$ second to automatically rescale the level and span range for objects in the thermal field of view. This feature operates the Imager in a semi-automatic mode if manual fine re-adjustment of level and span with the arrow buttons is not necessary. Rescaling can be done as often, or as little, as needed.



Note

The Imager always powers up in the same Range mode, Auto or Manual, as when it was powered down.

Level for Manual Operation Mode

When put into manual ranging, the level setting moves the thermal span up or down within the total temperature range. See Figure 2. In the live manual mode, the arrow buttons are always available to adjust the level and span.

To set the level:

1. Push  to move the range to a higher temperature level.
2. Push  to move the range to a lower temperature level.

While you adjust the manual level, the scale along the right side of the display shows the thermal span as it moves to different levels within the total range.

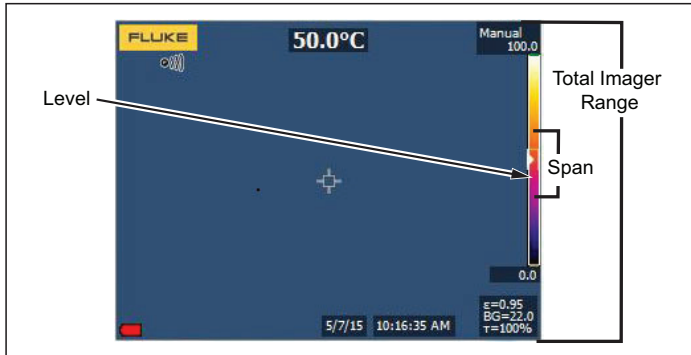



hxx003.eps

Figure 2. Level and Span Settings

Temperature Span for Manual Operation Mode

When in manual mode, the span setting contracts or expands in a selected palette in a temperature range within the total range. See Figure 2. In the live manual mode, the arrow buttons are always available to adjust the level and span.

To adjust the temperature span:

1. Push  to increase or widen the temperature span.
2. Push  to decrease or narrow the temperature span.

While you adjust the manual span, the scale along the right side of the display shows the thermal span increasing or decreasing in size.

Emissivity Adjustment

The correct emissivity values are important for the Imager to make the most accurate temperature measurement calculations. Emissivity of a surface can have a large effect on the apparent temperatures that the Imager observes. Understanding the emissivity of the surface being inspected can, but not always, allow you to obtain more accurate temperature measurements.

Note

Surfaces with an emissivity of <0.60 make reliable and consistent determination of actual temperatures problematic. The lower the emissivity, the more potential error is associated with the Imager's temperature measurement calculations. This is also true even when adjustments to the emissivity and reflected background adjustments are performed properly.



Emissivity is set directly as a value, or from a list of emissivity values for some common materials.

Note

*If the Display is set to **Display All**, you see the information about current emissivity as $\epsilon = x.xx$.*

Adjust by Number



To set the emissivity value:

1. Go to **Measurement > Emissivity > Adjust Number**.
2. Push / to change the value.

A custom emissivity value is indicated when any value not in the standard emissivity table is selected.

Select by Table

To select from a list of common materials:

1. Go to **Measurement > Emissivity > Select Table**.
2. Push / to highlight the material.
3. Push  to select the material.

If you set a value that is <0.60,  shows on the Imager display with this caution:

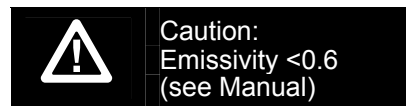



Push  to clear the message.

Background (Reflected Background Temperature Compensation)

Compensation for reflected background temperature is set in the Background tab. Very hot objects or very cold objects can affect the apparent temperature and measurement accuracy of the target or object of interest, especially when surface emissivity is low. Adjustment of the reflected background temperature can make the temperature measurement better in many situations. For more information, see page 18.

To adjust the background temperature:

1. Go to **Measurement > Background**.
2. Push / to change the value.
3. Push **F1** or **F2** when done.



Note

If the Display is set to **Display All**, you see the information about current reflected background temperature as **BG = xx.x**.

Transmission/Transmittance Adjustment (TiS45, TiS55, TiS65 only)

When you do infrared inspections through infrared-transparent windows (IR windows), not all of the infrared energy emitted from the objects of interest is transmitted through the optical material in the window. If the transmission percentage of the window is known, you can adjust this percentage in the Imager or in the SmartView[®] software. Adjustment of the transmission correction can make the accuracy of the temperature measurement better in many situations.

To adjust the transmission percentage:

1. Go to **Measurement > Transmission**.
2. Push / to adjust the percentage between 1 % and 100 %.

If you set a value that is <30 %,  shows on the Imager display with this caution:

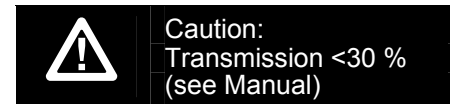

3. Push **F1** to clear the message.
4. Push **F1** or **F2** when done.

Note

If Display Information is set to **Display All**, you see the information about current transmission correction as **τ = xx**.

Spot Temperatures

The Spot Temperatures are floating HI and LO temperature indicators that move on the display as the temperature measurements of the image fluctuate.

To turn on/off the hot and cold spot indicators:

1. Go to **Measurement > Spot Temp.**
2. Push / to highlight **ON** or **OFF**.
3. Push or to set the new value.

User-Definable Spot Markers

Depending on your model, up to three adjustable, fixed-temperature spot markers are available on the display.

Model:	available spot markers:
TiS10, TiS20	0
TiS40, TiS45	1
TiS50, TiS55	2
TiS60, TiS65	3

You can use these markers to highlight a region before you save the image. The marker selection is set as All Off, One Marker, Two Markers, or Three Markers.

To set a Marker:

1. Push .
2. Push / to highlight **Measurement**.
3. Push or to view the menu.
4. Push / to highlight **Markers**.
5. Push or to view the menu.
6. Push the / to highlight the function between **All Off**, **One Marker**, **Two Markers**, and **Three Markers**.
7. Push or to set the marker option and go to the "Move Marker" display. You will see the Move Marker icon and the labels on the function buttons change to **Done**, **Next**, and **Cancel**.

To change the Marker position on the display:

1. Push to move the Marker location on the image.
2. Push to highlight the next marker. Do Step 1 again.
3. Do Step 2 for a third marker.
4. Push when done.

Center Box

For models TiS50, TiS55, TiS60, and TiS65, the Center Box feature is an adjustable temperature measurement zone (box) that you can center on the infrared image. This zone (box) expands and contracts to different levels within the infrared image. The zone lets the user see an approximate maximum (MAX), average (AVG), and minimum (MIN) temperature measurement in that area. When in AUTO Level and Span mode, the Imager automatically sets the level and span according to the infrared scene within the parameters of the Center Box.

To enable or disable the Center Box feature:

1. Push **F2**.
2. Push **▲/▼** to highlight **Measurement**.
3. Push **F1** or **▶** to view the menu.
4. Push **▲/▼** to highlight **Center Box**.
5. Push **F1** or **▶** to view the menu.
6. Push **▲/▼** to toggle the function ON or OFF.

To set the size of the Center Box when enabled:

1. Push **▲/▼** to highlight **Set Size**.
2. Push **F1** or **▶** to view the display.
3. Push **▶** to increase the size of the Center Box.
4. Push **◀** to reduce the size of the Center Box.
5. When satisfied with the size of the Center Box, push:
 - **F2** to set the change and go back to the previous menu.
 - **F3** to cancel the change and go back to the live view.

Image Menu

The Image menu has controls for different features used in the presentation of the infrared image on the Imager's LCD and some saved image files.

Note

Data saved as .is2 or .is3 formats can easily be modified within SmartView software. Still images saved in .bmp or .jpg format, as well as video saved in .avi format will retain image settings at the time of capture and save.

Palettes

The Palette menu lets you change the false-color presentation of the infrared images on the display (availability varies by model). Some palettes are more suitable for specific applications and can be set as required. Two different palette presentation modes are available, see Table 4. The Standard Palettes offer an equal, linear presentation of colors that allow for best presentation of detail. The Ultra Contrast™ Palettes offer a weighted presentation of colors. These palettes work best in situations with high thermal contrast for extra color contrast between the high temperatures and low temperatures.

Table 4. Palettes

Model	TiS10	TiS20	TiS40, TiS45	TiS50, TiS55	TiS60, TiS65
Standard Palettes					
Grayscale	●	●	●	●	●
Grayscale Inverted			●	●	●
Blue-Red	●	●	●	●	●
High Contrast		●	●	●	●
Hot Metal		●	●	●	●
Ironbow	●	●	●	●	●
Amber		●	●	●	●
Amber Inverted				●	●
Ultra Contrast™ Palettes					
Grayscale					●
Grayscale Inverted					●
Blue-Red					●
High Contrast					●
Hot Metal					●
Ironbow					●
Amber					●
Amber Inverted					●

To set a palette:

1. Push **F2**.
2. Push **▲/▼** to highlight **Image**.
3. Push **F1** or **▶** to view the menu.
4. Push **▲/▼** to highlight **Palette**.
5. Push **F1** or **▶** to view the menu.
6. Push **▲/▼** to highlight **Standard** or **Ultra Contrast**.
7. Push **▲/▼** to select a palette.
8. Push:
 - **F1** to set the change and go back to the live view.
 - **F2** or **◀** to set the change and go back to the previous menu.
 - **F3** to cancel the change and go back to the live view.

IR-Fusion® Technology

IR-Fusion® technology makes it easier to understand, analyze, and communicate infrared images through the use of an aligned visible image and infrared image. The Imager automatically captures a visible image with every infrared image to show you precisely where a potential problem might be, and then allows you to more effectively communicate it to others.

IR-Fusion has different modes that vary by model, see Table 5. (IR-Fusion is not available with the TiS10 model.)

Table 5. IR-Fusion Modes by Model

Auto Blending Level	TiS10	TiS20	TiS40, TiS45	TiS50, TiS55	TiS60, TiS65
0, 100	●				
3 presets 0, 50, 100		●			
5 presets 0, 25, 50, 75, 100			●	●	●
Picture-in-Picture (PIP) 25, 50, 75, 100			●	●	●

To set the IR-Fusion mode:

1. Push **F2**.
2. Push **▲/▼** to highlight **Image**.
3. Push **F1** or **▶** to view the menu.
4. Push **▲/▼** to highlight **IR-Fusion**.
5. Push **F1** or **▶** to view the menu.
6. Push **▲/▼** to highlight an option.
7. Push:
 - **F1** to set the change and go back to the live view.
 - **F2** or **◀** to set the change and go back to the previous menu.
 - **F3** to cancel the change and go back to the live view.

Color Alarms

The Imager has apparent temperature color alarms. The type of available alarm depends on the model.

Model:	Hi-Lo Alarm:	Isotherm Alarm:
TiS60, TiS65, TiS50, TiS55	yes	yes
TiS40, TiS45	yes	not available
TiS10, TiS20	not available	not available

The high-temperature color alarm shows a full visible image and only shows infrared information on objects or areas that are above the set apparent temperature alarm

level. The low-temperature (or dew point) color alarm shows a full visible image and only shows infrared information on objects or areas that are below the set apparent temperature (or set dew point) color alarm level. The user must manually determine and set these parameters.

Note









The Imager does not sense ambient or surface dew point level automatically. To use the low-temperature color alarm function as a dew point color alarm, manual determination and input of surface dew point temperature will yield the best results. Depending on the situation, the colors presented may help identify areas of concern with possible dew point condensation.

To view the Color Alarm menu:

1. Push **F2**.
2. Push **▲/▼** to highlight **Image**.
3. Push **F1** or **▶** to view the menu.
4. Push **▲/▼** to highlight **Color Alarm**.
5. Push **F1** or **▶** to view the menu.





Set High-Temperature Color Alarm

To set a high-temperature color alarm:





1. From the **Color Alarm** menu, push / to highlight the option: **Set High Alarm**.
2. Push  to open the Color Alarm menu.
3. Push / to adjust the temperature setting.
4. Push:
 -  to set the change and go back to the live view.
 -  or  to set change and go back to the previous menu.
 -  to cancel the change and go back to the live view

Set Low-Temperature/Dew Point Color Alarm

To set a low-temperature/dew point color alarm:

1. From the **Color Alarm** menu, push / to highlight **Set Low Alarm**.
2. Push  to open the Color Alarm menu.
3. Push / to adjust the temperature setting.







4. Push:

-  to set the change and go back to the live view.
-  or  to set the change and go back to the previous menu.
-  to cancel the change and go back to the live view.

Outside/Inside Alarm

If you set values for the high-temperature color alarm and a low-temperature color alarm, the Imager will have the options for inside or outside isotherm color alarms.

To set an outside/inside isotherm color alarm:

1. From the **Color Alarm** menu, push / to highlight **Outside** or **Inside**.
2. Push:
 -  to set the change and go back to the live view.
 -  or  to set the change and go back to the previous menu.
 -  to cancel the change and go back to the live view

Display Graphics Presentation

The options for how you view the on-screen graphics are in the Display menu. These options are Display All, Details and Scale, Scale Only, and Image Only.

1. Push **F2**.
2. Push **▲/▼** to highlight **Image**.
3. Push **F1** or **▶** to view the menu.
4. Push **▲/▼** to highlight **Display**.
5. Push **F1** or **▶** to view the menu.
6. Push **▲/▼** to highlight an option.
7. Push:
 - **F1** to set the change and go back to the live view.
 - **F2** or **◀** to set the change and go back to the previous menu.
 - **F3** to cancel the change and go back to the live view.

Note

Features that have ON/OFF controls must be turned on and turned off with those controls.

Logo

A Fluke logo shows on the display and captured images. You can choose to turn on or turn off the logo:

1. Go to **Image > Logo**.
2. Push **▲/▼** to highlight on or off.
3. Push **F1** to set.

With SmartView software you can upload a custom logo to the Imager from your PC through the USB connection.

Camera Menu

The Camera menu has controls and options for secondary camera features such as auto focus, backlight level, and laser pointer.

Backlight

The backlight level control is set to low, medium, and high. To set the backlight:

1. Push **F2**.
2. Push **▲/▼** to highlight **Camera**.
3. Push **F1** or **▶** to view the menu.
4. Push **▲/▼** to highlight **Backlight**.
5. Push **F1** or **▶** to view the menu.
6. Push **▲/▼** to highlight an option.
7. Push:
 - **F1** to set the change and go back to the live view.
 - **F2** or **◀** to set the change and go back to the previous menu.
 - **F3** to cancel the change and go back to the live view.

Video

The TiS60 and TiS65 Imagers can record infrared and IR-Fusion™ to the SD card or internal memory in .is3 or .avi format.

To record:

1. Go to **Camera > Video**.
2. Push **▲/▼** to select **Video/Audio** or **Video ONLY**.

A Bluetooth headset is required and the radio must be enabled for voice (audio) recording. This feature may not be available in all regions.
3. Push **▲/▼** to select **Record Video** to enable the recording mode.

The **||** icon shows on the display to identify the start recording mode.
4. Push and release the Image Capture button to start recording.

The **REC** icon shows on the display while recording is in process.
5. Push and release the Image Capture button to stop recording.

Auto Capture

The Auto Capture feature allows you to set the Imager to capture and save an infrared image, or series of images, automatically. Image capture can be triggered manually or with an “apparent temperature” trigger. The temperature trigger is set to start when a value is above or below a set limit. Regardless of how the capture starts, you can set the interval for when successive images are captured and saved. You also can set the number of images that are captured and saved. The upper limit on how many images is dependent on the amount of storage memory available.

To set and operate the Auto Capture feature:

1. Go to **Camera > Auto Capture**.
2. Push **F1** to start the capture sequence.

In the Auto Capture sub-menu, you will see these options:

- **Start Capture:** Executes the Auto Capture settings in camera memory.
- **Interval:** Push **▲**/**▼** to select the number of hours, minutes, or seconds as an interval between images.
- **Image Count:** Push **▲**/**▼** to manually select a number of images. Or, push the **Maximum Memory** button to select the option that will continue capturing and saving images until the chosen storage memory is filled or battery power is depleted.
- **Manual Trigger:** When Manual Trigger is selected, push **F1** to start the automatic capture of a series of images.
- **Temp Trigger:** Select **Temp Trigger** and then select **Set Temp Trigger** to open the adjustment menu.

Note

The minimum interval available can be affected by the file type and visible light camera settings chosen by the user. Some combinations create larger file sizes that take longer to capture and save and create a higher minimum interval compared to others.

Memory Menu

The Memory Menu allows you to review captured images, audio and text annotations, and IR-PhotoNotes™. Files in memory are shown in a large preview format. You can scroll through long lists and open a full-size image.

Change the setting for visible and thermal image and then view all images in the same format.



An icon shows to indicate any additional items saved with the infrared image or IR-Fusion technology image:

 IR-PhotoNotes photos

 Voice annotation

Review Image Files

To view stored images on the memory card:





1. Go to .
2. Push  to highlight the preview image of the file for review.
3. Push  to review the file.

Edit Image Files



SmartView® software and the Fluke Connect™ app allow you to edit .is2 image files that are stored in memory.

Delete Image Files

To erase one image from the memory card:

1. Push .
2. Push  to highlight the preview image of the file to delete.
3. Push  to open the **Delete** menu.
4. Highlight **Selected Image** and push . The Imager prompts you to continue or cancel.
5. Push  again to delete the file.

To erase all the images from memory:



1. Go to **Memory**.
2. Push .
3. Highlight **All Images** and push . The Imager prompts you to continue or cancel.
4. Push  to delete all files in memory.

Settings Menu

The Settings menu has adjustments for user preferences such as units of temperature measurement, file format of stored data, “save to” location choice, auto off settings, WiFi and Bluetooth settings, date, time, localization, and language. This menu also has a section that displays information about the Imager such as model number, serial number, and firmware versions. Certificates and licenses are available from this menu.

Units



To change the temperature units:

1. Go to **Settings > Units**.
2. Push / to highlight an option.
3. Push  to set an option.

File Format

Data can be saved to the internal memory or a micro SD memory card in different file formats. Image format selections are .bmp, .jpg, and .is2. These selections remain valid when you turn the Imager off or on.

To change the file format:

1. Go to **Settings > File Format**.
2. Push / to highlight an option.
3. Push  to set the option.

Images saved in the .is2 file format have the consolidation of all data into a single file and are more flexible for analysis and modification in the included SmartView software. This file format consolidates the infrared image, radiometric temperature data, visible image, voice annotation, and photos from the IR-PhotoNotes™ photo annotation system into one location.

For situations where a smaller file size with maximum resolution is needed and modification is not, choose the .bmp file format. For the smallest file size where modification is not needed and image quality and resolution are not as important, choose the .jpg file format.

The .bmp and .jpg files can be emailed and then opened on most PC and MAC systems without special software. These formats do not allow full analysis capabilities or modification.

The .is2 file format can be emailed and then opened with SmartView and Fluke Connect Software. This format has the maximum versatility. Visit the Fluke website or contact Fluke to find out how to download SmartView analysis and reporting software at no charge.





Auto Off

The Auto Off timer is user-defined separately for the LCD and power.

Note

Auto Off is automatically disabled when the Imager is connected to ac power.

To set the Auto Off feature:

1. Go to **Settings > Auto Off**.
2. Push / to highlight **LCD Time Out** or **Power Off**.
3. Push / to set the timer between 1 minute and 120 minutes.
4. Push  to set.

Localization











The Imager has several settings for localization:

- Date
- Time
- Language
- Decimal Separator

Date





The date can be displayed in one of two formats: **MM/DD/YY** or **DD/MM/YY**.





To set the date:

1. Go to **Settings > Date**.
2. Push / to highlight the date format.
3. Push  to set a new format.
4. Push / to highlight **Set Date**.
5. Push  to open the Set Date menu.
6. Push / to select highlight day, month, or year.
7. Push / to change the settings.
8. Push  to set the date and exit the menu.

Time



To set the time:

1. Go to **Settings > Time**.
Time displays in two different formats: 24 hour or 12 hour. To set the time format:
2. Push / to highlight time format.
3. Push  to select.
4. Highlight **Set Time**.
5. Push  to open the Set Time menu.

6. Push  /  to highlight hours or minutes.
The 12 hour format has a selection to set the time as AM or PM.
7. Push  or  to change the setting.
8. Push  to set the change.

Language

To change the display to a different language:

1. Go to **Settings > Language**.
2. Push  or  to highlight the setting.
3. Push  to set a new language.



Wireless Connectivity

The Imager is equipped with WiFi, Bluetooth, and Bluetooth Low Energy wireless connectivity options. Wireless connectivity enhances your ability to work more efficiently and better communicate results. The Imager ships with the radio disabled. For first-time use, you must enable the radio to use wireless connectivity.

To enable the radio:

1. Connect the Imager to a PC with internet access and Fluke SmartView software.
SmartView detects that the radio is disabled in the Imager and prompts you to register at www.fluke.com and enable the radio.

2. When you opt in, SmartView opens up a browser window to the Fluke registration web page. The web page provides the Imager serial number, choice of radio, and UI language.
3. Type the registration information into the web page. The server checks if the radio can be enabled for this address. If yes, a passphrase is provided to paste into SmartView.

SmartView validates that the passphrase is correct and then enables the radio in the Imager.



Bluetooth®

Bluetooth® technology is available to connect a wireless headset to the Imager. When on,  shows on the display (upper left corner).



WiFi™ Hotspot

Note

WiFi is for indoor use only in Kuwait, Chile, and United Arab Emirates.

You can wirelessly send a picture from the Imager to a PC, an iPhone, and an iPad through the WiFi connection. A transferred image can be viewed with Fluke Connect™ or SmartView Analysis and Reporting software if installed in the device.

WiFi™ Network

Infrastructure WiFi is a wireless local area network (WLAN) that links your Imager to other wireless devices using its radio and providing a connection through an access point to the wider Internet. This gives you the ability to move around within a local coverage area and still be connected to the network.

To turn on the WiFi Network feature:









1. Go to **Settings > Wireless > WiFi > WiFi Network**.
2. Push / to highlight **ON**.
3. Push **Select** to scan for available networks within range of the camera.
4. Push / to select a network.
5. Push  to connect/disconnect.
6. Enter a password if you are prompted.

Image Storage

The storage setting allows you to choose to save images to the internal memory or micro SD memory card.

1. Go to **Settings > Image Storage**.
2. Push  or  to change the setting.
3. Push  to select the new storage setting.

Fluke Connect™ Wireless System

The Imager supports the Fluke Connect™ Wireless System (may not be available in all regions). Fluke Connect™ is a system that wirelessly connects your Fluke test tools with an app on your smartphone or tablet. It can show images from your infrared camera on your smartphone or tablet screen, save images to Fluke Cloud™ storage, and share images with your team.

More information about how to enable the Imager radio is on page 32.

Fluke Connect App

The Fluke Connect app works with Apple and Android mobile products. The app is available for download from the Apple App Store and Google play.

How to access Fluke Connect:

1. Turn on the Imager.
2. On your smartphone, go to **Settings > Wi-Fi**.
3. Select the Wi-Fi network that begins with "Fluke...". This selection can vary according to how your WiFi Hotspot/SSID is configured.
4. Go to the Fluke Connect App and select "Thermal Imager" from the list.

You are now able to take images on the Imager.

5. Push the Image Capture button on the Imager to capture the image. The image is now in the buffer and you can save or edit.

6. Push **F1** to save the image and view the image on the phone app.

Go to www.flukeconnect.com for more information about how to use the app.

Fluke Connect Tools

To discover an Imager with Fluke Connect:

1. Turn on the Imager.
2. On the Imager, go to **Menu > Fluke Connect**.
3. Push **▲/▼** or **On** to select.
The Imager starts to scan and presents a list with the ID and name of available tools found within the 20 m distance. You can expect several minutes in delay before the scan is complete.
4. Push **▲/▼** to select a tool name.
5. Push **F1** (Done) to select the tool.
The labels change to include an Edit function. By default, the Imager shows and saves the data for the selected tools.

Fluke Cloud™ Storage

To upload images to the Fluke Cloud™ storage:

1. Turn on the Imager and connect to a WiFi network (see *WiFi Network* on page 29).
2. When the Imager is connected to a WiFi network, go to **Settings > Wi-Fi > Sign In**.

3. Enter a Fluke Connect user ID with the onscreen keyboard. If you have previously logged in, the history drop down box at the top of the keyboard shows a list of previously used IDs.

4. Enter the password with the onscreen keyboard.

All .is2, .jpg, and .bmp images automatically upload to the Fluke Cloud™ storage when you save the image after capture. Screen icons show you the progress:

 = image upload in progress

 = image upload done

 = error

To turn off the upload feature:

1. Go to **Settings > Wi-Fi > Sign Out**.
2. Or, turn off the WiFi network.

To edit the selection:

1. Push **▲/▼** to highlight the tool name.
2. Push **F1** to open the Edit menu. The Edit menu gives you a choice to display the measurement data and/or save it to the SD memory card.

The display updates to show the wireless icon and live measurement for each selected wireless tool.

Advanced Settings

Filename Prefix

The default filename starts with IR_. You have the option to change this prefix to a different 3-character name with the keyboard.

Reset Filename

You can reset the file number to 00001.

Factory Defaults

Erases all user-set preferences and restores all of the factory default settings.

Imager Information

You can access information about the version, certifications, and licenses for the Imager from the Settings Menu.

This includes:

- Model
- Camera serial number
- Refresh rate
- Engine serial number
- Firmware version
- FPGA #

To show the Imager Info:

1. Go to **Settings > Advanced > Imager Info**.
2. Push **▲/▼** to scroll through the menu.
3. Push:
 - **F1** to set the change and go back to the live view.
 - **F2** or **◀** to set the change and go back to the previous menu.
 - **F3** to cancel the change and go back to the live view.

To display the electronic certifications:

1. Go to **Settings > Advanced > Imager Info**.
2. Push **▲/▼** to highlight **Certificates**.
3. Push **F1** to view the information screen with the Imager certifications.
4. Push **F1** to close the information screen.

To show the license information:

1. Go to **Settings > Advanced > Imager Info**.
2. Push **▲/▼** to highlight **Licenses**.

3. Push **F1** to view the information screen with a list of Open Source Software Licenses.
4. Push **▲/▼** to scroll to a specific license.
5. Push **F1** to view the information screen with the specific license agreement.
6. Push **F1** to close the information screen.

Adjust Parallax

You can fine-tune the parallax adjustment to precisely align the image.

1. Go to **Settings > Advanced > Adjust Parallax**.
2. Follow the on-screen prompts to adjust.

Maintenance

The Imager does not require maintenance.

⚠⚠ Warning

To prevent eye damage and personal injury, do not open the Product. The laser beam is dangerous to eyes. Have the Product repaired only through an approved technical site.

How to Clean the Case

Clean the case with a damp cloth and a weak soap solution. Do not use abrasives, isopropyl alcohol, or solvents to clean the case or lens/window.

Lens Care

⚠ Caution

To prevent damage to the infrared lens:

- **Carefully clean the infrared lens. The lens has a delicate anti-reflective coating.**
- **Do not clean too vigorously as this can damage the anti-reflective coating.**

For lens care you will need a cleansing liquid such as a commercial lens cleaning liquid with alcohol, ethyl alcohol, or isopropyl alcohol and a lint-free cloth or tissue. A pressurized air can is used to remove loose particulates.

To clean the lens:

1. Blow off particulates from the lens surface with pressurized air can or dry nitrogen-ion gun if available.
2. Soak the lint-free cloth in the alcohol liquid.
3. Squeeze the cloth to remove excess liquid or dab on dry cloth.
4. Wipe the lens surface in one circular motion and discard the cloth.
5. Use a new cloth with liquid if you need to repeat the procedure.

Battery Care

⚠ Warning

To prevent personal injury and for safe operation of the Product:

- **Do not put battery cells and battery packs near heat or fire. Do not put in sunlight.**
- **Do not disassemble or crush battery cells and battery packs.**
- **Remove batteries to prevent battery leakage and damage to the Product if it is not used for an extended period.**
- **Connect the battery charger to the mains power outlet before the Product or battery.**
- **Use only Fluke approved power adapters to charge the battery.**
- **Keep cells and battery packs clean and dry. Clean dirty connectors with a dry, clean cloth.**

⚠ Caution

To prevent damage, do not expose Product to heat sources or high-temperature environments such as an unattended vehicle in the sun.

To get the best performance from the lithium-ion battery:

- Do not store the battery on the charger for more than 24 hours.
- Charge the Imager for a two-hour minimum at three-month intervals for maximum battery life.
- The battery will discharge in about three months if installed in the Imager and powered off. It will discharge in about six months if stored disconnected from the Imager.
- Batteries stored for long periods will need two to ten charging cycles for full capacity.
- Always operate in the specified temperature range.
- Do not store the batteries in extreme cold environments.
- Do not attempt to charge the batteries in extreme cold environments.
- These guidelines apply whether you charge the battery with external power or the charger base.

⌚ ⚠ Caution

Do not incinerate the Product and/or battery.

General Specifications

Temperature

Operating	-10 °C to +50 °C (14 °F to 122 °F)
Storage	-20 °C to +50 °C (-4 °F to +122 °F)

Relative Humidity 10 % to 95 % non-condensing

Altitude

Operating	2,000 m (6,562 ft)
Storage	12,000 m (39,370 ft)

Display 8.9 cm (3.5 in) diagonal landscape color VGA (320 x 240) LCD with backlight

Software SmartView® full analysis and reporting software available for free download at www.fluke.com

Power

Batteries.....	SBP3 Lithium-ion rechargeable smart battery pack
Battery Life.....	4 hours continuous use (assumes 50 % brightness of LCD)
Battery Charge Time.....	2.5 hours to full charge
AC Battery Charge.....	Ti SBC3B Two Bay Battery Charger (100 V ac to 240 V ac, 50/60 Hz) or in-Imager charging. Optional 12 V automotive charging adapter.
AC Operation.....	AC operation with power supply: 100 V ac– 240 V ac, 50/60 Hz, ac mains adapters included
Power Save	User-selectable Sleep and Power Off modes

Safety Standards Mains IEC 61010-1, Overvoltage Category II, Pollution Degree 2
IEC 60825-1, Class 2, <1 mW

Electromagnetic Compatibility (EMC)

International	IEC 61326-1: Basic Electromagnetic Environment CISPR 11: Group 1, Class A
---------------------	--

Group 1: Equipment has intentionally generated and/or uses conductively-coupled radio frequency energy that is necessary for the internal function of the equipment itself.

Class A: Equipment is suitable for use in all establishments other than domestic and those directly connected to a low-voltage power supply network that supplies buildings used for domestic purposes. There may be potential difficulties in ensuring electromagnetic compatibility in other environments due to conducted and radiated disturbances.

Emissions that exceed the levels required by CISPR 11 can occur when the equipment is connected to a test object.

Korea (KCC)	Class A Equipment (Industrial Broadcasting & Communication Equipment) <i>Class A: Equipment meets requirements for industrial electromagnetic wave equipment and the seller or user should take notice of it. This equipment is intended for use in business environments and not to be used in homes.</i>
USA (FCC)	47 CFR 15 subpart B. This product is considered an exempt device per clause 15.103.

Vibration	2 G, IEC 68-2-6
Shock	25 G, IEC 68-2-29
Drop	2 m (6.5 ft) with standard lens
Size (H x W x L)	26.7 cm x 10.1 cm x 14.5 cm (10.5 in x 4.0 in x 5.7 in)
Weight (includes battery)	
TiS10, TiS20, TiS40, TiS50, TiS60	0.72 kg (1.6 lb)
TiS45, TiS55, TiS65	0.77 kg (1.7 lb)
Enclosure Rating	IP54
Warranty	2 years
Calibration Cycle	2 years (assumes normal operation and normal aging)
Supported Languages	Czech, Dutch, English, Finnish, French, German, Hungarian, Italian, Japanese, Korean, Polish, Portuguese, Russian, Simplified Chinese, Spanish, Swedish, Traditional Chinese, and Turkish

Detailed Specifications

Temperature Measurements

Temperature Range (not calibrated below -10 °C)	
TiS10	-20 °C to +250 °C (-4 °F to +482 °F)
TiS20, TiS40, TiS45	-20 °C to +350 °C (-4 °F to +662 °F)
TiS50, TiS55	-20 °C to +450 °C (-4 °F to +842 °F)
TiS60, TiS65	-20 °C to +550 °C (-4 °F to +1022 °F)
Accuracy	±2 °C or 2 % (whichever is greater) at 25 °C ambient
On-screen emissivity correction	1 % to 100 %
On-screen reflected background temperature compensation	yes, default is 22 °C
On-screen transmission correction	
TiS45, TiS55, TiS65 (manual focus)	1 % to 100 %

Imaging Performance

IFOV (spatial resolution) Distance to Spot	
TiS10	7.8 mRad, D:S 137:1
TiS20	5.2 mRad, D:S 206:1
TiS40, TiS45	3.9 mRad, D:S 275:1
TiS50, TiS55	2.8 mRad, D:S 377:1
TiS60, TiS65	2.4 mRad, D:S 446:1
Field of View	35.7° x 26.8°
Image Capture Frequency	9 Hz or 30 Hz refresh rate
Detector Type	Focal Plane Array, uncooled microbolometer
Thermal Sensitivity (NETD)	
TiS10	≤150 mK
TiS20	≤100 mK
TiS40, TiS45	≤90 mK
TiS50, TiS55, TiS60, TiS65	≤80 mK
Total pixels	
TiS10	80 x 60
TiS20	120 x 90
TiS40, TiS45	160 x 120
TiS50, TiS55	220 x 165
TiS60, TiS65	260 x 195
Infrared spectral band	7.5 μm to 14 μm (long wave)

Visual (Visible Light) Camera

Type	Industrial performance 5.0 megapixel
Minimum parallax alignment with standard IR lens	~60 cm (~24 in)

Focus Mechanism

Fixed Focus	TiS10, TiS20, TiS40, TiS50, TiS60
Manual Focus	TiS45, TiS55, TiS65

Level and Span

- Smooth Auto-Scaling and Manual scaling of level and span
- Fast auto setting/switching between manual and auto modes
- Fast auto rescale in manual mode
- Minimum Span (in manual mode)..... 2.5 °C
- Minimum span (in auto mode)..... 5.0 °C

Image and Data Storage

- File Formats..... BMP, JPG, IS2, IS3, AVI (No analysis software required for .bmp and .jpg files)
- Export File Formats with SmartView® Software JPEG, JPG, JPE, JFIF, BMP, GIF, DIB, PNG, TIF, TIFF
- Memory Review Preview image navigation and review selection
- Video Recording (TiS60, TiS65)
 - Standard, Non-Radiometric Viewable through Smart View software, Windows Media Player, QuickTime, and on Imager. H.264 MPEG encoding AVI will also allow voice recording in addition to captured video. Video functions to include: record, stop, rewind, fast forward, pause/play. Maximum recording time = minimum of ten minutes @ 30 Hz (requires class 10 micro SD).
 - Radiometric Viewable on Imager and with SmartView software in proprietary .is3 format. Supports voice recording in addition to captured video. Video functions to include: stop, rewind, fast forward, pause/play. Maximum recording time = minimum of ten minutes @ 9 Hz.
- Storage Medium
 - Micro SD Memory Card Includes ≥4 GB memory card to store at least 2000 fully radiometric (.is2) IR and linked visual images each with 60 seconds voice annotations or 5000 basic (.bmp or .jpg) images
 - Internal on-board flash memory..... 4 GB available for storage
 - USB direct download with USB-to-PC cable connection
 - USB accessory connection

Note

The addition of IR-PhotoNotes or other saved items can vary the total number of images that can be stored on the SD memory card.

