

# **TiX520, TiX560**

Expert Series Thermal Imager

**Users Manual**

February 2015

© 2015 Fluke Corporation. All rights reserved. Specifications are subject to change without notice.

All product names are trademarks of their respective companies.

## LIMITED WARRANTY AND LIMITATION OF LIABILITY

Each Fluke product is warranted to be free from defects in material and workmanship under normal use and service. The warranty period is two years and begins on the date of shipment. Parts, product repairs, and services are warranted for 90 days. This warranty extends only to the original buyer or end-user customer of a Fluke authorized reseller, and does not apply to fuses, disposable batteries, or to any product which, in Fluke's opinion, has been misused, altered, neglected, contaminated, or damaged by accident or abnormal conditions of operation or handling. Fluke warrants that software will operate substantially in accordance with its functional specifications for 90 days and that it has been properly recorded on non-defective media. Fluke does not warrant that software will be error free or operate without interruption.

Fluke authorized resellers shall extend this warranty on new and unused products to end-user customers only but have no authority to extend a greater or different warranty on behalf of Fluke. Warranty support is available only if product is purchased through a Fluke authorized sales outlet or Buyer has paid the applicable international price. Fluke reserves the right to invoice Buyer for importation costs of repair/replacement parts when product purchased in one country is submitted for repair in another country.

Fluke's warranty obligation is limited, at Fluke's option, to refund of the purchase price, free of charge repair, or replacement of a defective product which is returned to a Fluke authorized service center within the warranty period.

To obtain warranty service, contact your nearest Fluke authorized service center to obtain return authorization information, then send the product to that service center, with a description of the difficulty, postage and insurance prepaid (FOB Destination). Fluke assumes no risk for damage in transit. Following warranty repair, the product will be returned to Buyer, transportation prepaid (FOB Destination). If Fluke determines that failure was caused by neglect, misuse, contamination, alteration, accident, or abnormal condition of operation or handling, including overvoltage failures caused by use outside the product's specified rating, or normal wear and tear of mechanical components, Fluke will provide an estimate of repair costs and obtain authorization before commencing the work. Following repair, the product will be returned to the Buyer transportation prepaid and the Buyer will be billed for the repair and return transportation charges (FOB Shipping Point).

THIS WARRANTY IS BUYER'S SOLE AND EXCLUSIVE REMEDY AND IS IN LIEU OF ALL OTHER WARRANTIES, EXPRESS OR IMPLIED, INCLUDING BUT NOT LIMITED TO ANY IMPLIED WARRANTY OF MERCHANTABILITY OR FITNESS FOR A PARTICULAR PURPOSE. FLUKE SHALL NOT BE LIABLE FOR ANY SPECIAL, INDIRECT, INCIDENTAL, OR CONSEQUENTIAL DAMAGES OR LOSSES, INCLUDING LOSS OF DATA, ARISING FROM ANY CAUSE OR THEORY.

Since some countries or states do not allow limitation of the term of an implied warranty, or exclusion or limitation of incidental or consequential damages, the limitations and exclusions of this warranty may not apply to every buyer. If any provision of this Warranty is held invalid or unenforceable by a court or other decision-maker of competent jurisdiction, such holding will not affect the validity or enforceability of any other provision.

Fluke Corporation  
P.O. Box 9090  
Everett, WA 98206-9090  
U.S.A.

Fluke Europe B.V.  
P.O. Box 1186  
5602 BD Eindhoven  
The Netherlands

11/99

To register your product online, visit <http://register.fluke.com>.

# Table of Contents

| Title                                 | Page |
|---------------------------------------|------|
| Introduction .....                    | 1    |
| How to Contact Fluke .....            | 2    |
| Safety Information.....               | 2    |
| Operation in Extreme Conditions ..... | 3    |
| Radio Frequency Data .....            | 3    |
| Accessories .....                     | 5    |
| Before You Start .....                | 6    |
| Battery .....                         | 7    |
| Two-Bay Battery Charger Base.....     | 7    |
| On-Imager AC Power Socket.....        | 7    |
| Optional 12 V Vehicle Charger.....    | 8    |
| Features and Controls .....           | 10   |
| Power On and Off .....                | 11   |
| Focus .....                           | 11   |
| Image Capture Button.....             | 12   |
| Control Buttons .....                 | 12   |
| Touch Screen.....                     | 15   |
| How to Use the Menus.....             | 16   |
| Neck Strap .....                      | 16   |
| Image Capture.....                    | 17   |

|  |    |
|--|----|
| IR-PhotoNotes™ .....   | 17 |
| Voice Annotation (Recording) .....                               | 18 |
| Listen to a Voice Annotation (Recording).....                    | 18 |
| Edit Captured Infrared Image.....                                | 18 |
| Save Captured Infrared Image.....                                | 19 |
| Micro SD Memory Card .....                                       | 19 |
| Temperature Measurement .....                                    | 19 |
| SmartView® Software .....  | 20 |
| Menus.....   | 20 |
| Measurement Menu .....   | 20 |
| Range.....   | 20 |
| Level/Span .....   | 21 |
| Emissivity Adjustment .....                                      | 22 |
| Background (Reflected Background Temperature Compensation) ..... | 23 |
| Transmission/Transmittance Adjustment .....                      | 24 |
| Spot Temperatures.....   | 24 |
| Center Box .....   | 24 |
| Markers .....  | 25 |
| Image Menu .....   | 26 |
| Palette .....  | 26 |
| IR-Fusion® Technology .....                                      | 27 |
| Color Alarms .....   | 27 |
| Display Graphics Presentation .....                              | 28 |
| Logo .....   | 29 |
| Distance .....   | 29 |
| Camera Menu .....  | 29 |
| Auto Focus .....   | 29 |
| Backlight.....   | 30 |
| Video .....  | 30 |
| HDMI .....   | 31 |
| Auto Capture .....   | 31 |
| Wireless Connectivity.....                                       | 32 |
| Memory Menu .....  | 33 |
| Review Image Files .....   | 33 |

|                                      |    |
|--------------------------------------|----|
| Edit Image Files .....               | 33 |
| Delete Image Files .....             | 33 |
| Settings Menu .....                  | 34 |
| Units .....                          | 34 |
| File Format .....                    | 34 |
| Auto Off .....                       | 35 |
| Localization .....                   | 35 |
| Image Storage .....                  | 36 |
| Advanced Settings .....              | 36 |
| Fluke Connect™ Wireless System ..... | 38 |
| Fluke Connect App .....              | 38 |
| Fluke Connect Tools .....            | 38 |
| Remote Control .....                 | 39 |
| Maintenance .....                    | 39 |
| How to Clean the Case .....          | 40 |
| Battery Care .....                   | 40 |
| General Specifications .....         | 41 |
| Detailed Specifications .....        | 43 |



## ***List of Tables***

| <b>Table</b> | <b>Title</b>                  | <b>Page</b> |
|--------------|-------------------------------|-------------|
| 1.           | Symbols .....                 | 4           |
| 2.           | Accessories .....             | 5           |
| 3.           | Bottom Panel .....            | 9           |
| 4.           | Features .....                | 10          |
| 5.           | Controls .....                | 13          |
| 6.           | Touch Targets.....            | 15          |
| 7.           | Level and Span Settings ..... | 22          |
| 8.           | Palettes.....                 | 26          |





## ***List of Figures***

| <b>Figure</b> | <b>Title</b>                  | <b>Page</b> |
|---------------|-------------------------------|-------------|
| 1.            | Laser Warning .....           | 2           |
| 2.            | Add-On Lens Installation..... | 6           |
| 3.            | Adjustable Neck Strap .....   | 16          |



## **Introduction**

The Fluke TiX520 and TiX560 Expert Series Thermal Imagers (the Product or Imager) are handheld, infrared imaging cameras for use in multiple applications. These applications include equipment troubleshooting, preventive and predictive maintenance, building diagnostics, and research and development.

The lens is able to swivel 180° independently from the display to take measurements in hard-to-reach areas. With wireless connectivity, you have several options for how to manage and share these measurements.

### **Productivity Features**

- Voice Annotation/Reviewable playback on Imager (requires Bluetooth headset)
- IR-PhotoNotes™
- Fluke Connect™ / WIFI connectivity
- Streaming video
- Remote control and operation

### **Image Presentation**

- Standard Palettes: Red, Grayscale, Inverted Grayscale, High Contrast, Amber, Inverted Amber, Hot Metal, Ironbow
- Ultra Contrast™ Palettes: Blue-Red Ultra, Grayscale Ultra, Inverted Grayscale Ultra, High Contrast Ultra, Amber Ultra, Inverted Amber Ultra, Hot Metal Ultra, Ironbow Ultra
- Image Sharpening mode
- Filter mode for improved NETD

### **IR-Fusion® Technology**

- Automatically aligned (parallax corrected) visual and infrared
- Picture-In-Picture (PIP) infrared
- Full screen infrared
- AutoBlend™ mode with continuous AutoBlend feature (TiX560 only)
- Full screen visible
- Color alarms (temperature alarms) for high temperature and low temperature (user selectable)

## How to Contact Fluke

To contact Fluke, call one of the following telephone numbers:

- USA: 1-800-760-4523
- Canada: 1-800-36-FLUKE (1-800-363-5853)
- Europe: +31 402-675-200
- Japan: +81-3-6714-3114
- Singapore: +65-6799-5566
- Anywhere in the world: +1-425-446-5500

Or, visit Fluke's website at [www.fluke.com](http://www.fluke.com).

To register your Product, visit <http://register.fluke.com>.

To view, print, or download the latest manual supplement, visit <http://us.fluke.com/usen/support/manuals>.

To download SmartView® software visit [www.fluke.com/smartviewdownload](http://www.fluke.com/smartviewdownload).

To download the Fluke Connect™ app, go to iTunes or Google play and download Fluke Connect.

## Safety Information

A **Warning** identifies conditions and procedures that are dangerous to the user. A **Caution** identifies conditions and procedures that can cause damage to the Product or the equipment under test.

### Warning

To prevent eye damage and personal injury:

- **Do not look into the laser. Do not point the laser directly at persons or animals or indirectly off reflective surfaces.**
- **Do not open the Product. The laser beam is dangerous to eyes. Have the Product repaired only through an approved technical site.**

Additional laser warning information is on the inside of the Product swivel, see Figure 1.



hwj010.eps

Figure 1. Laser Warning

**⚠ Warning**

To prevent personal injury:

- **Read all safety information before you use the Product.**
- **Carefully read all instructions.**
- **Use the Product only as specified, or the protection supplied by the Product can be compromised.**
- **Replace the batteries when the low battery indicator shows to prevent incorrect measurements.**
- **Do not use the Product if it operates incorrectly.**
- **Do not use the Product if it is damaged.**
- **See emissivity information for actual temperatures. Reflective objects result in lower than actual temperature measurements. These objects pose a burn hazard.**
- **Do not use the Product around explosive gas, vapor, or in damp or wet environments.**

**Operation in Extreme Conditions**













Storage and/or continual operation of the Imager in extreme ambient temperature conditions can result in temporary interruption of operation. If this occurs, let the Imager stabilize (cool down or warm up) before you resume operation.

**Radio Frequency Data**

The Imager ships with the radio disabled. See *Wireless Connectivity* for instructions on how to enable the radio. See *Imager Information* for instructions on how to access digital copies of the radio licenses on the Imager.

Table 1 is a list of symbols used on the Imager and in this manual.

**Table 1. Symbols**

| Symbol  | Description  | Symbol  | Description   |
|---|--|---|---|
|  | Important information. See manual.   |  | Warning. Laser.   |
|  | Connected to ac power. Battery removed.  |  | Battery status. Battery charging when animated.                                 |
|  | On/Off symbol  |  | Conforms to requirements of European Union and European Free Trade Association. |
|  | Conforms to relevant Australian standards.   |  | Conforms to relevant North American Safety Standards.                           |
|  | Conforms to relevant South Korean EMC standards.   |  | Japan Quality Association   |
|  | This Product contains a lithium-ion battery. Do not mix with the solid waste stream. Spent batteries should be disposed of by a qualified recycler or hazardous materials handler per local regulations. Contact your authorized Fluke Service Center for recycling information.   |   |   |
|  | This product complies with the WEEE Directive (2002/96/EC) marking requirements. The affixed label indicates that you must not discard this electrical/electronic product in domestic household waste. Product Category: With reference to the equipment types in the WEEE Directive Annex I, this product is classed as category 9 “Monitoring and Control Instrumentation” product. Do not dispose of this product as unsorted municipal waste. Go to Fluke’s website for recycling information. |   |   |

## Accessories

Table 2 is a list of the accessories available for the Imager.

**Table 2. Accessories**

| Model            | Description                              | Part Number |
|------------------|--|-------------|
| FLK-TI-SBP4      | Smart Battery Pack                       | 4597142     |
| FLK-TI-SBC3B     | Charging Base/Power Supply with Adapters | 4354922     |
| TI-CAR CHARGER   | 12 V Vehicle Charger Adapter             | 3039779     |
| FLUKE-TIX5xx     | Neck Strap                               | 4574715     |
| FLUKE-TIX5xx     | Hand Strap                               | 4574703     |
| FLK-Bluetooth    | Bluetooth Headset                        | 4603258     |
| FLK-HDMI Cable   | HDMI Cable                               | 4388596     |
| FLK-HDMI Adapter | HDMI Adapter                             | 4613365     |
| BOOK-ITP         | Introduction to Thermography Principles  | 3413459     |
| FLK-LENS/TELE2   | 2X Telephoto Infrared Lens               | 4335377     |
| FLK-LENS/WIDE2   | Wide-Angle Infrared Lens                 | 4335361     |
| FLK-LENS/4XTELE2 | 4X Telephoto Infrared Lens               | 4607058     |
| FLK-LENS/25MAC2  | 25-Micron Macro Infrared Lens            | 4607064     |

Optional telephoto and wide-angle lenses expand the flexibility and allow more applications for your infrared inspection work. See Figure 2 for information about how to install a lens.

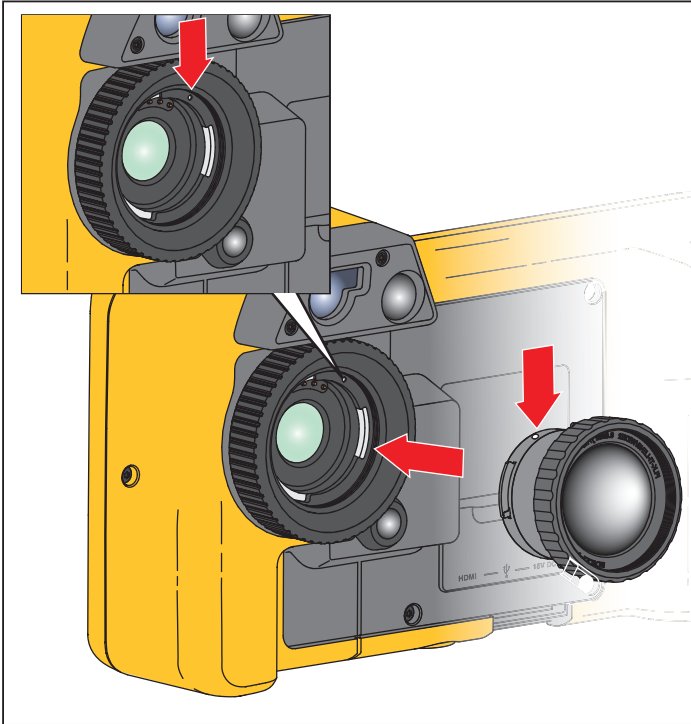

**Figure 2. Add-On Lens Installation**

## **Before You Start**

Carefully unpack the items in the shipment box:

- Thermal Imager
- AC Power Supply with Mains Adapters
- Two-Bay Battery Charge Base
- 2 Lithium-ion Smart Batteries
- Hard Carrying Case
- USB-to-PC Cable
- HDMI Video Cable
- Removable Memory Card
- Hard Transport Case
- Adjustable Hand Strap (left-hand or right-hand use)
- Adjustable Neck Strap
- Quick Reference Guide
- Users Manual/SmartView<sup>®</sup> Software (on USB Drive)
- Warranty Registration Card

Fluke recommends the removable memory card that is supplied with the Imager or available from Fluke. Fluke does not warrant the use or reliability of aftermarket memory cards of different brands or capacities.

To request a printed manual, email Fluke at [TPubs@fluke.com](mailto:TPubs@fluke.com). Specify the product name and language preference in the subject line.



## **Battery**

Before you use the Imager for the first time, charge the battery for a minimum of 2.5 hours. The battery status shows on the five-segment charge indicator.

### **⚠ Warning**

**To prevent personal injury, do not put battery cells and battery packs near heat or fire. Do not put in sunlight.**

### *Note*

*New batteries are not fully charged. Two to ten charge/discharge cycles are necessary before the battery charges to its maximum capacity.*

To charge the battery, use one of the options that follow:

## **Two-Bay Battery Charger Base**



1. Connect the ac power supply to the ac wall outlet and connect the dc output to the charger base.
2. Put one or two smart batteries into bays of charger base.
3. Charge batteries until charge indicators show “full.”
4. Remove smart batteries and disconnect the power supply when batteries are fully charged.

## **On-Imager AC Power Socket**

1. Connect the ac power adapter into an ac wall outlet and connect the dc output to the Imager’s ac power socket.  flashes on the display while the battery charges with the ac power adapter.
2. Charge until the charge indicator on the display does not flash.
3. Disconnect ac power adapter when the smart battery is fully charged.

*Note*

*Make sure that the Imager is near room temperature before you connect it to the charger. See the charging temperature specification. Do not charge in hot or cold areas. When you charge the battery in extreme temperatures, battery capacity may be decreased.*

 shows in the lower left-hand corner of the display when the Imager is connected to ac power and the battery is removed. When the Imager's power is off and the ac power adapter is connected,  flashes in the center of the display to show that the battery charge is in process.

Keep the Imager attached to the charger until the  icon shows a full charge. If you remove the Imager from the charger before a full charge shows, it may have a reduced run-time.

*Note*

*When the battery is connected to ac power or the unit is in video mode, the Sleep Mode/Auto Off feature is disabled automatically.*

**Optional 12 V Vehicle Charger**

1. Connect the 12 V adapter into the 12 V accessory socket of the vehicle.
2. Connect the output to the ac power socket of the Imager.
3. Charge until the indicator until the  icon shows a full charge on the screen.
4. Disconnect the 12 V adapter and Imager when battery is fully charged.

** Caution**

**To prevent damage to the Imager, remove it from the 12 V vehicle charger before you start or jump start the vehicle.**

Table 3 shows the location of the battery and interfaces.

**Table 3. Bottom Panel**

| Item | Description                             |
|------|---|
| ①    | Smart Battery Port                      |
| ②    | Lithium-ion Smart Battery               |
| ③    | Anchor for Neck Strap                   |
| ④    | SD Memory Card Slot                     |
| ⑤    | Tripod Mount                            |
| ⑥    | 2-Bay Battery Charging Base             |
| ⑦    | AC Power Adapter with Universal Adapter |

## Features and Controls

Table 4 shows the Imager features.

**Table 4. Features**

| Item | Description                       |
|------|-----------------------------------|
| ①    | Infrared Camera Lens              |
| ②    | Focus Control                     |
| ③    | Laser Distance Finder             |
| ④    | Visual Camera and Lens            |
| ⑤    | Laser Distance Finder Button      |
| ⑥    | Image Capture Button              |
| ⑦    | Hand Strap Anchor                 |
| ⑧    | AC Adapter/Charger Input Terminal |
| ⑨    | USB-to-PC Cable Connection        |
| ⑩    | USB Accessory Connection          |
| ⑪    | HDMI Video Connection             |
| ⑫    | LED Light                         |

## **Power On and Off**

To turn on or turn off the Imager, push and hold **I** for two seconds. The Imager has Power Save and Auto Off features. For more information about how to set these features, see *Settings Menu*.

### *Note*

*All thermal imagers need sufficient warm-up time for the most accurate temperature measurements and best image quality. This time can often vary by model and by environmental conditions. Although most imagers are fully warmed up in 3-5 minutes, it is always best to wait a minimum of 10 minutes if the most accurate temperature measurement is important to your application. When you move the Imager between environments with large differences in ambient temperature, more adjustment time can be required.*

## **Focus**

The Imager uses the LaserSharp™ Auto Focus System and an advanced manual focus system. Correct focus is important in all imaging applications. Correct focus makes sure that the infrared energy is correctly directed onto the pixels of the detector. Without correct focus, the thermal image can be blurry and the radiometric data may be inaccurate. Out-of-focus infrared images are frequently unusable or of little value.

The Fluke LaserSharp Auto Focus System uses a precision-adjusted and aligned laser pointer to indicate the area of focus. To focus with the LaserSharp Auto Focus System, depress the large black button (see Table 4). Aim the laser pointer at the target. When satisfied with the location of the laser pointer, release the button. The system automatically focuses on the precise point where the laser was aimed.

### *Note*

- You can enable and disable the LaserSharp Auto Focus System.
- The laser pointer is aligned parallel to the infrared lens. If using AutoBlend Mode, the laser pointer dot will always be positioned just above the center point marker on the LCD. However, it is easier to use your eyes to locate the visible laser pointer on the target.

To focus with the advanced manual focus system, place finger on the electronically-driven focus wheel control and rotate the control until the target is in proper focus.

### *Note*

*The advanced manual focus can be used as a manual override of the LaserSharp™ Auto Focus System.*

### **Image Capture Button**

The large green button is the Image Capture Button (see Table 4). In normal operation, the function of the Image Capture Button is to capture a thermal image that you can save to memory.

### **Control Buttons**

The function and cursor buttons are the primary controls. These buttons move the cursor through the menu structure to set the features.

#### **Controls and Adjustments**





- User-selectable temperature scale
- Language/localization selection
- Time and date settings
- Emissivity selection
- Reflected background temperature compensation
- Transmission correction
- User-selectable hot spot and cold spot, and center point on the image
- Expand/contract measurement box with MIN-AVG-MAX
- Color alarms
- User-selectable backlight setting
- Graphic information display (selectable)
- Laser distance display

In general, push:

 to set the change and go back to the live view.

 to set the change and go back to the previous menu.









 to cancel the change and go back to the live view.

    to move the cursor and highlight an option.

In live Manual Mode, the arrow buttons are always active to adjust Level and Span.

Table 5 is an overview of the buttons and their actions.

**Table 5. Controls**

| Item | Button  | Description                   |
|------|---|-------------------------------|
| ①    | ---   | LCD Touch Screen              |
| ②    | ⏻   | Power On/Off                  |
| ③    |    | Function Buttons (F1, F2, F3) |
| ④    |    | Cursor Buttons                |
| ⑤    |    | Go to IR Fusion Menu          |
| ⑥    |    | Manual/Auto Level and Span    |
| ⑦    |    | Go to internal Image Memory   |
| ⑧    |    | LED Light                     |
| ⑨    |    | Zoom In/Zoom Out              |
| ⑩    |  | Fluke Connect™                |
| ⑪    |  | Rescale                       |

hwj001.eps

## IR-Fusion®

### TiX520

Push **IR FUSION** to go directly to the adjustment menu for IR-Fusion. See page 27 for more information about the IR-Fusion feature.

### TiX560

Push **IR FUSION** to open the scroll bar that adjusts the IR-Fusion mode. Use it to infinitely adjust the picture from Full IR mode to Full Visible mode.

## Auto/Manual Level and Span

Push and release **AUTO  
MANUAL** to set the Imager to Auto Range or Manual Range. The icon in the upper right-hand corner of the LCD screen identifies the setting as Auto or Manual.

## Memory

Push **MEMORY** to go directly to the preview images of stored files. See page 33 for more information about the Memory feature.

## LED Light

The LED Light illuminates darker work areas. Push **LED** to turn on and turn off the LED light at any time during operation.

## Zoom

### TiX520

Push **ZOOM** to set the zoom function between no zoom, 2x, and 4x.

### TiX560

Push **ZOOM** to set the zoom function between no zoom, 2x, 4x, and 8x.

## Fluke Connect

The Imager supports the Fluke Connect™ Wireless System (may not be available in all regions). Push **Fluke Connect** to go directly to the wireless setup menu. More information about Fluke Connect is on page 38.

## Rescale

Push and release **RESCALE** to automatically rescale the level and span for objects in the thermal field of view. This feature operates the Imager in a semi-automatic mode if manual fine re-adjustment of level and span with the arrow buttons is not necessary. Rescaling is done as often as needed.

### Note

*The Imager always powers up in the same Level and Span mode, Auto or Manual, as when it was powered down.*



## Touch Screen

The touch screen is a shortcut to the most often used adjustments: date, time, emissivity, palette, temperature degrees, level and span, AutoBlend level, and background temperature. With the touch screen, you interact directly with what is displayed. To change parameters or select functions and options, touch a target on the display with a finger.

The touch screen has a backlight for work in dimly lit spaces. To change the backlight intensity, see Camera Menu.

Table 6 shows the location of each touch target.

**Table 6. Touch Targets**

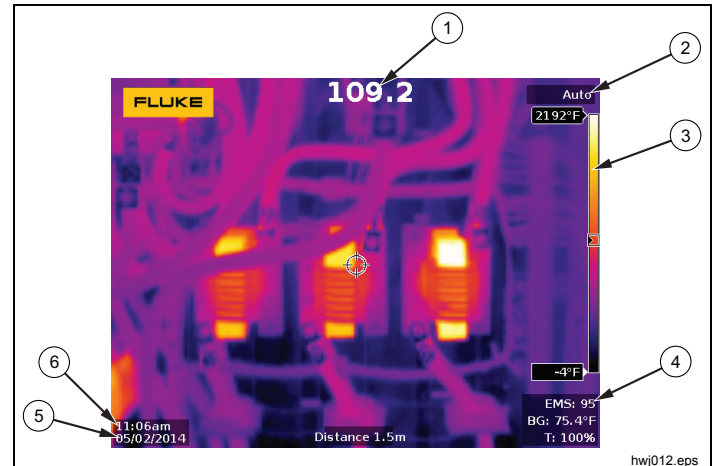

| Item | Description   |
|------|---|
| ①    | Go to Temperature Unit Adjustment menu  |
| ②    | Manual/Auto Toggle  |
| ③    | Go to Palette menu  |
| ④    | Go to Measurement menu for span/level, emissivity, and background temperature adjustments |
| ⑤    | Go to Date Adjustment menu  |
| ⑥    | Go to Time Adjustment menu  |

## How to Use the Menu

The menu, coupled with the three function button and arrow buttons, are the access point for:

- Thermal image display
- Camera features
- Measurement
- Advanced functions
- Memory review
- Settings for date, time, language, units, file format
- Information about the Imager

To open the primary menu, push **F2**. The primary menu shows five secondary menus for Measurement, Image, Camera, Memory, and Settings. The text labels on the right-hand edge of the touchscreen correspond to the **F1**, **F2**, **F3** buttons. You can use the buttons or the touch screen interchangeably for these functions.

Push **F2** to open the primary menu.

Push **▲ ▼ ▶ ◀** to cycle through the secondary menus. Each secondary menu lists an options menu.

Push **▲ ▼ ▶ ◀** to cycle through the options.

The primary, secondary, and option menus close 10 seconds after the last push of a function button. The option selection menu stays open until you make the selection, go up a menu level, or cancel the action.

## Neck Strap

The neck strap makes it easy to carry the Imager with you on the job and supports extended use of the Imager. It is simple to attach and adjust without any tools. See Figure 3.

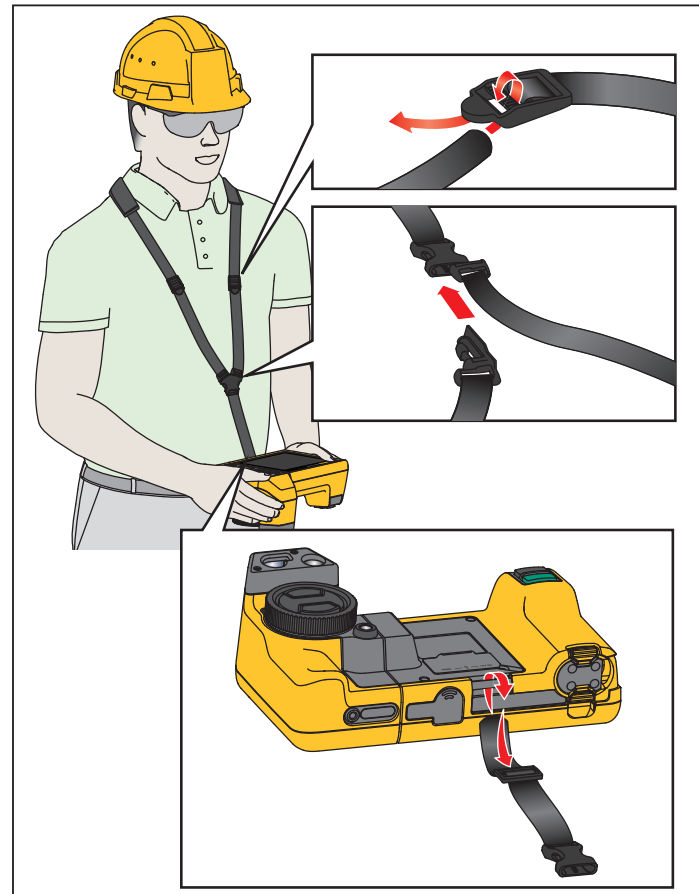

hwj003.eps

Figure 3. Adjustable Neck Strap

## **Image Capture**

Point the Imager at the target object. Focus on the object using the LaserSharp™ Auto Focus System or advanced manual focus (see page 11). Push and release the Image Capture (green) button. This will capture and freeze the image. The image is now in the memory buffer and you can choose to save or edit the image. Push **F1** to save the image or **F3** to cancel and return to the live view.

Depending on the selected file format settings, the Imager shows the captured image and a menu bar. The menu bar lets you save the image, edit some image settings, and add voice annotation or IR-PhotoNotes™ digital photos. To change the file format, see *File Format* on page 34.

## **IR-PhotoNotes™**

The IR-PhotoNotes™ photo annotation system allows you to capture and add up to five visible (digital) images of various objects, text, or other information that is related to the analysis and reporting of an infrared image. Examples of possible annotations include motor name plates, printed information or warning signs, larger views of the environment or room, and related equipment or objects.

Up to five images can be captured with the visible image that is stored in addition to the aligned infrared and visible images used in IR-Fusion® technology. These visible images are only available in the .is2 file format and are stored in the file so you do not need to collate multiple files at a later time.

To add photos using the IR-PhotoNotes annotation system:

1. With an infrared image in the buffer, push **F2** to open the **EDIT IMAGE** menu.
2. Push **▲**/**▼** to highlight **IR-PhotoNotes**.
3. Push **F1** to enter the Picture mode.
4. Focus the Imager on the object and push the Image Capture button.
5. Push **F2** when done.
6. Push the Image Capture button to capture additional pictures.
7. Push **F1** save the pictures with the image.



### Voice Annotation (Recording)

A Bluetooth headset is required and the radio must be enabled for voice (audio) recording. This feature may not be available in all regions.

To record:

1. With an infrared image in the buffer, push **F2** to open the **EDIT IMAGE** menu.
2. Push / to highlight **Add Audio**.
3. Push **F1** to record up to 60 seconds of audio. The display updates to show the recorded time.
4. Push **F1** to pause the recorder.
5. Push **F2** when done.
6. Push **F1** to review the audio file or **F2** to save the audio with the image.

Voice annotation is only available in the .is2 file format and is stored in the file so you do not need to collate multiple files at a later time.

### Listen to a Voice Annotation (Recording)

The icon identifies each file that has a voice annotation. The voice (audio) recording replays through a Bluetooth headset or when you use SmartView software.

To play back:

1. Do the steps in the *Review Image Files* section on page 33 to see the image on the display.
2. Push **F1**.
3. Push **F1** to set **Audio**.
4. Push **F1** to listen to the audio.
5. Push **F1** again to pause the audio.

### Edit Captured Infrared Image

Before and after you save a file, use the Imager to edit or modify the image. You can add IR-PhotoNotes, voice annotation, and text annotation as well as change the palette and IR Fusion mode.

A Bluetooth headset is required and the radio must be enabled for voice (audio) annotation. This feature may not be available in all regions.

To edit:

1. With an image in the buffer, go to **EDIT IMAGE > Edit Image**.
2. Push any arrow button to highlight an option or use the touch screen to select an option.
3. Push **F1** to save the changes with the file.

### **Save Captured Infrared Image**

To save an image as a data file:

1. Focus on the object of interest or inspection area.
2. Push the Image Capture button to capture the image. The image is now in the buffer and you can save or edit.
3. Push **F1** to save the image as a file and go back to the live view.

### **Micro SD Memory Card**

To eject a Micro SD memory card, push in on the exposed edge of the card and then release. The card should pop partially out after you release it. Carefully pull the card out of the slot.

To insert the Micro SD memory card, push the card in until it catches.

The Micro SD memory card includes an SD adapter for insertion into a PC or multi-function card reader.

For information about how to save data, see page 19. For information about how to view or erase a stored image, see page 33.

### **Temperature Measurement**

All objects radiate infrared energy. The quantity of energy radiated is based on the actual surface temperature and the surface emissivity of the object. The Imager senses the infrared energy from the surface of the object and uses this data to calculate an estimated temperature value. Many common objects and materials such as painted metal, wood, water, skin, and cloth are very good at radiating energy and it is easy to get relatively accurate measurements. For surfaces that are good at radiating energy (high emissivity), the emissivity factor is  $\geq 90\%$  (or 0.90). This simplification does not work well on shiny surfaces or unpainted metals as they have an emissivity of  $< 0.60$ . These materials are not good at radiating energy and are classified as low emissivity. To more accurately measure materials with a low emissivity, an emissivity correction is necessary. Adjustment to the emissivity setting will usually allow the Imager to calculate a more accurate estimate of the actual temperature.

#### **⚠ Warning**

**To prevent personal injury, see emissivity information for actual temperatures. Reflective objects result in lower than actual temperature measurements. These objects pose a burn hazard.**

More information is available on emissivity at <http://www.fluke.com/emissivity> and <http://www.fluke.com/emissivityexplanation>. We recommend the study of this topic to get the most accurate temperature measurements.

## **SmartView® Software**

SmartView® software is supplied with the Imager or and is available for free download at [www.fluke.com/smartviewdownload](http://www.fluke.com/smartviewdownload). This software is intended for Fluke Imagers and contains features to analyze images, organize data and information, and make professional reports. SmartView allows audio annotations and photos from the IR-PhotoNotes™ annotation system to be reviewed on a PC. SmartView is used to export IR and visible images as .jpeg, .jpg, .jpe, .jfif, .bmp, .gif, .dib, .png, .tif, or .tiff formatted files.

SmartView Mobile Software is also available for flexibility away from your PC or in the field.

## **Menus**



The menus are the access points for thermal image display, camera features, memory setup, and settings for date, time, language, units, file format, and Imager information.

### **Measurement Menu**

The Measurement Menu has settings for the calculation and display of radiometric temperature measurement data related to the thermal images. These settings include the Temperature Range selection, Level/Span adjustment, Emissivity, Background, Transmission, Spot Temperatures, Center Box, and Markers.





### **Range**





Preset measurement ranges and a Full Automatic Range are available on the Imager. To select the range:

1. Go to **Measurement > Range**.
2. Push / to select between the preset ranges or the full automatic range.
3. Push **F1** to set the range.

## Level/Span

Level and span are set for automatic or manual adjustment. To choose between automatic or manual level and span:

1. Push  or go to **Measurement > Set Level/Span**.
2. Push / to select between the **Auto** and **Manual** ranging or **Set Level/Span**.
3. Push  to set the new selection.



In manual mode the Set Level/Span control is active. Use / to adjust the level setting. Use / to adjust the span setting. See the section, *Detailed Specifications*, for more information about the minimum span.

In manual mode, level and span are also adjustable from the touch screen. Tap the left margin of the touch screen to reveal the temperature scale. Use your finger to adjust the setting. You can use two fingers (pinch) to adjust both the upper and lower settings at the same time.

## Temperature Level for Manual Operation Mode

When put into manual ranging, the level setting moves the thermal span up or down within the total temperature range. In the live manual mode, the arrow buttons are always available to adjust the level and span.

To set the level:

1. Push  to move the range to a higher temperature level.
2. Push  to move the range to a lower temperature level.

While you adjust the manual level, the scale along the right side of the display shows the thermal span as it moves to different levels within the total range. See Table 7.

## Temperature Span for Manual Operation Mode

When in manual mode, you can control the span setting to contract or expand in a selected palette in a temperature range within the total range. Use either the touch screen or the buttons to make adjustments to the settings. In the live manual mode, the arrow buttons are always available to adjust the level and span. See Table 7.

Table 7. Level and Span Settings

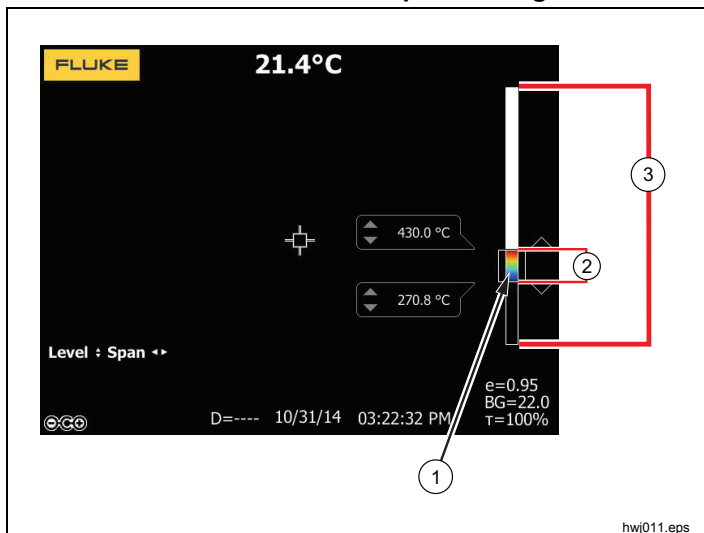

| Item | Description        |
|------|--------------------|
| ①    | Level              |
| ②    | Span               |
| ③    | Total Imager Range |

To adjust the temperature span:

1. Push or the touch screen to increase or widen the temperature span.
2. Push or the touch screen to decrease or narrow the temperature span.

While you adjust the manual span, the scale along the right side of the display shows the thermal span increasing or decreasing in size.

### Emissivity Adjustment

The correct emissivity values are important for the Imager to make the most accurate temperature measurement calculations. Emissivity of a surface can have a large effect on the apparent temperatures that the Imager observes. Understanding the emissivity of the surface being inspected can, but not always, allow you to obtain more accurate temperature measurements.

If you set a value that is  $<0.60$ , shows on the Imager display with this caution:

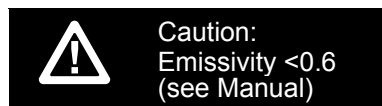



*Note*

Surfaces with an emissivity of <0.60 make reliable and consistent determination of actual temperatures problematic. The lower the emissivity, the more potential error is associated with the Imager's temperature measurement calculations. This is also true even when adjustments to the emissivity and reflected background adjustments are performed properly.



Emissivity is set directly as a value, or from a list of emissivity values for some common materials.

*Note*

If the Display is set to **Display All**, you see the information about current emissivity as  $\epsilon = \mathbf{x.xx}$ .

### Adjust by Number



To set the emissivity value:

1. Go to **Measurement > Emissivity > Adjust Number**.
2. Push / to change the value.

A custom emissivity value is indicated when any value not in the standard emissivity table is selected.

### Select by Table





To select from a list of common materials:

1. Go to **Measurement > Emissivity > Select Table**.
2. Push / to highlight the material.
3. Push  to select the material.

### Background (Reflected Background Temperature Compensation)

Compensation for reflected background temperature is set in the Background tab. Very hot objects or very cold objects can affect the apparent temperature and measurement accuracy of the target or object of interest, especially when surface emissivity is low. Adjustment of the reflected background temperature can make the temperature measurement better in many situations. For more information, see *Emissivity Adjustment*.

To adjust the background temperature:

1. Go to **Measurement > Background**.
2. Push / to change the value.
3. Push  or  when done.





*Note*

If the Display is set to **Display All**, you see the information about current reflected background temperature as **BG = xx.x**.

### Transmission/Transmittance Adjustment

When you do infrared inspections through infrared-transparent windows (IR windows), not all of the infrared energy emitted from the objects of interest is transmitted through the optical material in the window. If the transmission percentage of the window is known, you can adjust this percentage in the Imager or in the SmartView® software. Adjustment of the transmission correction can make the accuracy of the temperature measurement better in many situations.

To adjust the transmission percentage:

1. Go to **Measurement > Transmission**.
2. Push / to adjust the percentage between 10 % and 100 %.
3. Push  or  when done.





#### Note

*If Display Information is set to **Display All**, you see the information about current transmission correction as  $\tau = xx$ .*

### Spot Temperatures

The Spot Temperatures are floating HI and LO temperature indicators that move on the display as the temperature measurements of the image fluctuate.

To turn on/off the hot and cold spot indicators:

1. Go to **Measurement > Spot Temp**.
2. Push / to highlight **ON** or **OFF**.
3. Select **Hot** or **Cold**.
4. Push  or  to set the new value.



### Center Box

The Center Box feature is an adjustable temperature measurement zone (box) that you can center on the infrared image. This zone (box) expands and contracts to different levels within the infrared image. The zone lets the user see an approximate maximum (MAX), average (AVG), and minimum (MIN) temperature measurement in that area. When in AUTO Level and Span mode, the Imager automatically sets the level and span according the infrared scene within the parameters of the Center Box.









#### Note

*When using the Center Box, the level and span of the Imager is adjusted to the thermal scene within the Center Box.*

To enable or disable the Center Box feature:

1. Go to **Measurement > Center Box**.
2. Push / to highlight **ON** or **OFF**.
3. Push  to set the new value.



To set the size of the **Center Box** when enabled:

1. Push / to highlight **Set Size**.
2. Push  to go to the adjustment screen.
3. Push  to increase the size of the **Center Box**.
4. Push  to reduce the size of the **Center Box**.
5. When satisfied with the size of the **Center Box**, push:
  -  to set the change and exit the menus.
  -  to set the change and go back to the previous menu.
  -  to cancel the change and go back to the live view.







## Markers

Up to three adjustable, fixed-temperature spot markers are available on the display. You can use these markers to highlight a region before you save the image. The marker selection is set as All Off, One Marker, Two Markers, or Three Markers.

To set a Marker:

1. Go to **Measurement > Markers**.
2. Push the / to highlight the function between **All Off**, **One Marker**, **Two Markers**, and **Three Markers**.
3. Push  to set the marker option and go to the “Move Marker” display. You will see the Move Marker icon and the labels on the function buttons change to **Done**, **Next**, and **Cancel**.

To change the Marker position on the display:

1. Push     to move the Marker location on the image.
2. Push  to highlight the next marker. Do Step 1 again.
3. Do Step 2 for a third marker.
4. Push  when done.

## Image Menu

The Image menu has controls for different features used in the presentation of the infrared image on the Imager's LCD and some saved image files.

### Note

*Data saved as .is2 or .is3 formats can easily be modified within SmartView software. Still images saved in .bmp or .jpg format, as well as video saved in .avi format will retain image settings at the time of capture and save.*

## Palette

The Palette menu lets you change the false-color presentation of the infrared images on the display. Some palettes are more suitable for specific applications and can be set as required. Two different palette presentation modes are available, see Table 8. The Standard Palettes offer an equal, linear presentation of colors that allow for best presentation of detail. The Ultra Contrast™ Palettes offer a weighted presentation of colors. These palettes work best in situations with high thermal contrast for extra color contrast between the high temperatures and low temperatures.

Table 8. Palettes

| Standard Palettes  | Ultra Contrast™ Palettes |
|--------------------|--------------------------|
| Grayscale          | Grayscale Ultra          |
| Grayscale Inverted | Grayscale Inverted Ultra |
| Blue-Red           | Blue-Red Ultra           |
| High Contrast      | High Contrast Ultra      |
| Hot Metal          | Hot Metal Ultra          |
| Ironbow            | Ironbow Ultra            |
| Amber              | Amber Ultra              |
| Amber Inverted     | Amber Inverted Ultra     |

To switch between palettes:

1. Go to **Image > Palette > Standard or Ultra Contrast.**
2. Push / to highlight a palette.
3. Push  to set the new palette.

To change the palette color:



1. Go to **Image > Palette > Set Palette.**
2. Push / to highlight the palette color.
3. Push  to set the new palette color.

Saturation Colors is an option that you can choose as off, standard, red/blue, or white/black.

### **IR-Fusion® Technology**

IR-Fusion® technology makes it easier to understand, analyze, and communicate infrared images through the use of an aligned visible image and infrared image. The Imager automatically captures a visible image with every infrared image to show you precisely where a potential problem might be, and then allows you to more effectively communicate it to others.



IR-Fusion® technology has different modes:

| Icon  | TiX520   | TiX560                   |
|---|--|--------------------------|
|  | -Picture-in-Picture (PIP)<br>-AutoBlend<br>(min, mid, max) | Picture-in-Picture (PIP) |
|  | Full Screen AutoBlend<br>(min, mid, max)                   | Full Screen IR           |
|  | Visible  | NA                       |

*Note*

*The visible image and infrared image can be customized or separated in SmartView and SmartView Mobile Software when you use the .is2 file format.*

To set the IR-Fusion® technology mode:

1. Go to **Measurement > Image > IR-Fusion**.
2. Push / to highlight an option.
3. Push **F1**  to set the new option.

### **TiX560**

The TiX560 model has an adjustable IR Level.

Push **IR FUSION**  to open the scroll bar that adjusts the IR-Fusion mode. Use it to infinitely adjust the picture from Full IR mode to Full Visible mode.

### **Color Alarms**

The Imager has various apparent temperature color alarms. The high-temperature color alarm shows a full visible image and only shows infrared information on objects or areas that are above the set apparent temperature alarm level. The low-temperature (or dew point) color alarm shows a full visible image and only shows infrared information on objects or areas that are below the set apparent temperature (or set dew point) color alarm level. The user must manually determine and set these parameters.

#### Note

*The Imager does not sense ambient or surface dew point level automatically. To use the low-temperature color alarm function as a dew point color alarm, manual determination and input of surface dew point temperature will yield the best results. Depending on the situation, the colors presented may help identify areas of concern with possible dew point condensation.*

To view the Color Alarm menu:

1. Go to **Image > Color Alarm**.
2. Push **F1** to view the menu.

#### Set High-Temperature Color Alarm

To set a high-temperature color alarm:

1. Go to **Image > Color Alarm > Set High Alarm**.
2. Push **▲/▼** to adjust the temperature setting.
3. Push **F1** or **F2** set the new value.

#### Set Low-Temperature (or Dew Point) Color Alarm

To set a low-temperature/dew point color alarm:

1. Go to **Image > Color Alarm > Set Low Alarm**.
2. Push **▲/▼** to adjust the temperature setting.
3. Push **F1** or **F2** set a new value.

#### Outside/Inside Alarm

If you set values for the high-temperature color alarm and a low-temperature color alarm, the Imager will have the options for inside or outside color alarms.

To set an outside/inside color alarm:

1. Go to **Image > Color Alarm > Outside or Inside**.
2. Push:

**F1** to set the change and go back to the live view.

**F2** to set the change and go back to the previous menu.

**F3** to cancel the change and go back to the live view.

#### Display Graphics Presentation

The options for how you view the on-screen graphics are in the Display menu. These options are Display All, Details and Scale, Scale Only, and Image Only.

To set the display:



1. Go to **Image > Display**.
2. Push **▲/▼** to highlight an option.
3. Push **F1** or **F2** set a new option.

#### Note

*Features that have ON/OFF controls must be turned on and turned off with those controls.*

## Logo

A Fluke logo shows on the display and captured images. You can choose to turn on or turn off the logo:

1. Go to **Image > Logo**.
2. Push / to highlight on or off.
3. Push  to set.

With SmartView software you can upload a custom logo to the Imager from your PC through the USB connection.

## Distance

The Imager has a laser distance finder that measures, up to 30 meters, the distance from the Imager to a target. You can choose to show the distance on the display in imperial or metric units. The distance is saved to memory as part of the image.

### **Warning**

**To prevent eye damage and personal injury:**

- **Do not look into the laser. Do not point the laser directly at persons or animals or indirectly off reflective surfaces.**
- **Do not open the Product. The laser beam is dangerous to eyes. Have the Product repaired only through an approved technical site.**

To do a distance measurement:

1. Point the Imager at the target.
2. Push the Laser Distance Finder button.
3. Locate the red laser dot on the target.
4. Release the Laser Distance Finder button.

The distance measurement shows on the bottom of the display. The measurement shows as “- - -” when not able to take a measurement. If this is the case, steady the Imager and retake the measurement. Or, use a tripod. The Imager will show an error message for excessive laser movement due to an out of range distance.

## Camera Menu

The Camera menu has controls and options for secondary camera features such as auto focus, backlight level, and torch.

## Auto Focus



The laser pointer on the Imager is both a sighting aid and a part of the LaserSharp™ Auto Focus System. In addition, the advanced manual focus of the Imager works both when the auto focus system is enabled or disabled.

### **Warning**

**To prevent eye damage and personal injury, do not look into the laser. Do not point the laser directly at persons or animals or indirectly off reflective surfaces.**

The laser warning symbol () shows at the top of the display when you push the Laser Distance Finder button.



To turn on or turn off the LaserSharp Auto Focus System and the laser pointer:

1. Go to **Camera > Auto Focus**.
2. Push / to select on or off.
3.  to set the change and go back to the live view.

When the laser pointer is turned on, the Laser Distance Finder button is the control for the LaserSharp Auto Focus System. Point the Imager in the general direction of the object of interest. Push and hold the Laser Distance Finder button to locate the laser dot on the specific area of interest. Release the button. The auto focus system will quickly and accurately focus on the object.

### **Backlight**



The backlight level control is set to low, medium, and high. To set the backlight:

1. Go to **Camera > Backlight**.
2. Push / to highlight high, medium, or low.
3. Push  to set a new value.

### **Video**

The Imager can record infrared and IR-Fusion™ to the SD card or internal memory in .is3 or .avi format.

To record:

1. Go to **Camera > Video**.
2. Push / to select **Video/Audio** or **Video ONLY**. A Bluetooth headset is required and the radio must be enabled for voice (audio) recording. This feature may not be available in all regions.
3. Touch the **Record Video** target to enable the recording mode.

The  icon shows on the display to identify the start recording mode.

4. Push and release the Image Capture button to start recording.

The  icon shows on the display while recording is in process.

5. Push and release the Image Capture button to stop recording.



## HDMI

HDMI® (High-Definition Multimedia Interface) is a compact audio/video interface for transferring uncompressed data and compressed/uncompressed digital audio data from the Imager to a compatible HDMI device.

To set up:

1. Attach the included HDMI cable to the HDMI port on the Imager.
2. Connect the other end to an HDMI video device.





## Auto Capture

The Auto Capture feature allows you to set the Imager to capture and save an infrared image, or series of images, automatically. Image capture can be triggered manually or with an “apparent temperature” trigger. The temperature trigger is set to start when a value is above or below a set limit. Regardless of how the capture starts, you can set the interval for when successive images are captured and saved. You also can set the number of images that are captured and saved. The upper limit on number is dependent on the amount of storage memory available.

To set and operate the Auto Capture feature:

1. Go to **Camera > Auto Capture**.
2. Push **Start Capture** to start the capture sequence.

In the Auto Capture sub-menu, you will see these options:

- **Start Capture:** Executes the Auto Capture settings in camera memory.
- **Interval:** Set the hours, minutes, and seconds between individual image capture events. Push / to select the number of hours, minutes, or seconds as an interval between images.
- **Image Count:** Select the number of images that are captured in a sequence. Push / to manually select a number of images. Or, push the **Maximum Memory** button to select the option that will continue capturing and saving images until the chosen storage memory is filled or battery power is depleted.
- **Manual Trigger:** When Manual Trigger is selected, push **Start Capture** to start the automatic capture of a series of images.
- **Temp Trigger:** Select *Temp Trigger* and then select *Set Temp Trigger* to open the adjustment menu.

### Note

*The minimum interval available can be affected by the file type and visible light camera settings chosen by the user. Some combinations create larger file sizes which take longer to capture and save, creating a higher minimum interval compared to others.*



## Wireless Connectivity

The Imager is equipped with WiFi, Bluetooth, and Bluetooth Low Energy wireless connectivity options. Wireless connectivity enhances your ability to work more efficiently and better communicate results. The Imager ships with the radio disabled. For first-time use, you must enable the radio to use wireless connectivity.

To enable the radio:

1. Connect the Imager to a PC with internet access and Fluke SmartView software.  
  
SmartView detects that the radio is disabled in the Imager and prompts you to register at [www.fluke.com](http://www.fluke.com) and enable the radio.
2. When you opt in, SmartView opens up a browser window to the Fluke registration web page. The web page provides the Imager serial number, choice of radio, and UI language.
3. Type the registration information into the web page. The server checks if the radio can be enabled for this address. If yes, a passphrase is provided to paste into SmartView.

SmartView validates that the passphrase is correct and then enables the radio in the Imager.



## Bluetooth®

Bluetooth is available to connect a device such as a wireless headset. When on,  shows on the display (upper left corner).







## WiFi™ Hotspot

You can wirelessly send a picture from the Imager to a PC, an iPhone, and an iPad through the WiFi connection. A transferred image can be viewed with Fluke Connect™ or SmartView Analysis and Reporting software if installed in the device.

## WiFi™ Network

Infrastructure WiFi is a wireless local area network (WLAN) that links your Imager to other wireless devices using its radio and providing a connection through an access point to the wider Internet. This gives you the ability to move around within a local coverage area and still be connected to the network.

To turn on the WiFi Network feature:

1. Go to **Settings > Wireless > WiFi > WiFi Network**.
2. Push / to highlight **ON**.
3. Push **Select** to scan for available networks within range of the camera.
4. Push / to select a network.
5. Push **F1** to connect/disconnect.
6. Enter a password if you are prompted.

### **Memory Menu**

The Memory Menu allows you to review captured images, audio and text annotations, and IR-PhotoNotes™. Files in memory are shown in a large preview format. You can scroll through long lists with the touch screen and open a full-size image with a touch.

Change the setting for visible and thermal image and then view all images in the same format.

An icon shows to indicate any additional items saved with the infrared image or IR-Fusion technology image:



 IR-PhotoNotes photos

 Voice annotation

### **Review Image Files**

To view stored images on the memory card:

1. Go to **Memory**.



2. Push / to highlight the preview image of the file for review.
3. Push **F2** to review the file.

### **Edit Image Files**

You can make all the same adjustments to a file in memory as you can in real time, including IR-PhotoNotes™.

### **Delete Image Files**

To erase one image from the memory card:

1. Go to **Memory**.
2. Push / to highlight the preview image of the file to delete.
3. Push **F2** to open the **Delete** menu.
4. Highlight **Selected Image** and push **F1**. The Imager prompts you to continue or cancel.
5. Push **F1** again to delete the file.

To erase all the images from memory:



1. Go to **Memory**.
2. Push **F2**.
3. Highlight **All Images** and push **F1**. The Imager prompts you to continue or cancel.
4. Push **F1** to delete all files in memory.

## Settings Menu

The Settings menu has adjustments for user preferences such as units of temperature measurement, file format of stored data, “save to” location choice, auto off settings, WiFi and Bluetooth settings, date, time, localization, and language. This menu also has a section that displays information about the Imager such as model number, serial number, and firmware versions. Certificates and licenses are available from this menu.

### Units



To change the temperature units:

1. Go to **Settings > Units**.
2. Push / to highlight an option.
3. Push  to set an option.

### File Format

Data can be saved to the internal memory, micro SD memory card, or a USB flash memory device in different file formats. Image format selections are .bmp, .jpg, and .is2. These selections remain valid when you turn the Imager off or on.

To change the file format:

1. Go to **Settings > File Format**.
2. Push / to highlight an option.
3. Push  to set the option.

Images saved in the .is2 file format have the consolidation of all data into a single file and are more flexible for analysis and modification in the included SmartView software. This file format consolidates the infrared image, radiometric temperature data, visible image, voice annotation, and photos from the IR-PhotoNotes™ photo annotation system into one location.

For situations where a smaller file size with maximum resolution is needed and modification is not, choose the .bmp file format. For the smallest file size where modification is not needed and image quality and resolution are not as important, choose the .jpg file format.

The .bmp and .jpg files can be emailed and then opened on most PC and MAC systems without special software. These formats do not allow full analysis capabilities or modification.

The .is2 file format can be emailed and then opened with SmartView and Fluke Connect Software. This format has the maximum versatility. Visit the Fluke website or contact Fluke to find out how to download SmartView analysis and reporting software at no charge.



### Auto Off

The Auto Off timer is user-defined separately for the LCD and power.

#### Note

*Auto Off is automatically disabled when the Imager is connected to ac power.*

To set the Auto Off feature:

1. Go to **Settings > Auto Off**.
2. Push to highlight **LCD Time Out** or **Power Off**.
3. Push / to set the timer between 1 minute and 120 minutes.
4. Push to set.

### Localization

The Imager has several settings for localization:

- Date
- Time
- Language
- Decimal Separator

### Date

The date can be displayed in one of two formats:  
**MM/DD/YY** or **DD/MM/YY**.





To set the date:

1. Go to **Settings > Date**.
2. Push / to highlight the date format.
3. Push to set a new format.
4. Push / to highlight **Set Date**.
5. Push to open the Set Date menu.
6. Push / to select highlight day, month, or year.
7. Push / to change the settings.
8. Push to set the date and exit the menu.

### Time



To set the time:

1. Go to **Settings > Time**.  
Time displays in two different formats: 24 hour or 12 hour. To set the time format:
2. Push / to highlight time format.
3. Push to select.
4. Highlight **Set Time**.
5. Push to open the Set Time menu.

6. Push   to highlight hours or minutes.  
The 12 hour format has a selection to set the time as AM or PM.
7. Push  or  to change the setting.
8. Push  to set the change.

### Language

To change the display to a different language:

1. Go to **Settings > Language**.
2. Push  or  to highlight the setting.
3. Push  to set a new language.



### Decimal Separator

To make the decimal separator a period or comma:

1. Go to **Settings > Localization**.
2. Push  or  to highlight the setting.
3. Push  to set a new separator.

### Image Storage

The storage setting allows you to choose to save images to the internal memory, micro SD memory card, or USB flash memory.

1. Go to **Settings > Image Storage**.
2. Push  or  to change the setting.
3. Push  to select the new storage setting.

### Advanced Settings

#### Filename Prefix

The default filename starts with IR\_. You have the option to change this prefix to a different 3-character name with the touch screen keyboard.

#### Reset Filename

You can reset the file number to 00001.





#### Factory Defaults

Erases all user-set preferences and restores all of the factory default settings.





#### Imager Information

You can access information about the version, certifications, and licenses for the Imager from the Settings Menu.







To show the Imager Info:

1. Go to **Settings > Advanced > Imager Info**.
2. Push / to highlight **Version**.
3. Push  to view the information screen with model number, serial numbers, and firmware versions.
4. Push  to close the information screen.

To display the electronic certifications:

1. Go to **Settings > Advanced > Imager Info**.
2. Push / to highlight **Certificates**.
3. Push  to view the information screen with the Imager certifications.
4. Push  to close the information screen.

To show the license information:

1. Go to **Settings > Advanced > Imager Info**.
2. Push / to highlight **Licenses**.
3. Push  to view the information screen with a list of Open Source Software Licenses.
4. Push / to scroll to a specific license.
5. Touch the license name on the screen to view the information screen with the specific license agreement.
6. Push  to close the information screen.

### **Adjust Parallax**

With the use of optional add-on lenses, you can fine-tune the parallax adjustment to precisely align the image.

1. Go to **Settings > Advanced > Adjust Parallax**.
2. Follow the on-screen prompts to adjust.



### **Image Enhancement**

Image enhancement is available on the TiX560 with the Image Sharpening and SuperResolution modes.

Image Sharpening uses post-processing of the image to remove blurring from the image and improve image quality. This feature is most effective for work in the high temperature ranges. You can expect several seconds in delay when using this mode.

SuperResolution uses micro movements to produce an image that is 640 x 480 pixels using a 320 x 240 sensor. Results are viewable on the Imager after they are captured on the TiX560. The TiX520 requires SmartView software to view a SuperResolution image. Expect a 10-second delay for the Imager when using this mode.



To set:

1. Go to **Settings > Advanced > Enhancement**.
2. Push  or  or touch the target to change the setting.
3. Push  or touch **Done** to select the new setting.

### Filter Mode

Low, medium, and high filter levels are available to improve the useful sensitivity of the Imager and give you better images. For best results, hold the Imager steady as you do the inspection.

To set:

1. Go to **Settings > Advanced > Filter Mode**.
2. Push  or  or touch the target to change the setting.
3. Push  or touch **Done** to select the new setting.

### Fluke Connect™ Wireless System

The Imager supports the Fluke Connect™ Wireless System (may not be available in all regions). Fluke Connect™ is a system that wirelessly connects your Fluke test tools with an app on your smartphone or tablet. It can show images from your infrared camera on your smartphone or tablet screen, save images to the asset's EquipmentLog™ history in the Fluke Cloud™, and share images with your team.

### Fluke Connect App

The Fluke Connect app works with the Apple and Android products. The app is available for download from the Apple App Store and Google play.

How to access Fluke Connect:



1. Insert the Fluke Connect Wireless SD Card into the Imager.

2. Power on the Imager.
3. On your smartphone, go to **Settings > Wi-Fi**.
4. Select the Wi-Fi network that begins with "Fluke..".
5. Go to the Fluke Connect App and select "Thermal Imager" from the list.  
You are now able to take images on the Imager.
6. Push the Image Capture button on the Imager to capture the image. The image is now in the buffer and you can save or edit.
7. Push  to save the image and view the image on the phone app.

Go to [www.flukeconnect.com](http://www.flukeconnect.com) for more information about how to use the app.



### Fluke Connect Tools

To discover a Fluke Connect-supported tool:



1. If not already on, turn on each wireless tool and make sure the wireless feature is enabled. See the documentation of each tool for more information about how to use.
2. Turn on the Imager.
3. On the Imager, go to **Menu > Fluke Connect**.
4. Push / or touch **On** to select.  
The Fluke Connect button starts to flash. The Imager starts to scan and presents a list with the ID and name of available tools found within the 20 m distance. You



can expect several minutes in delay before the scan is complete.

5. Push / or touch the target to select a tool name.
6. Push  or touch **Done** to select the tool.  
The labels change to include an Edit function. By default, the Imager shows and saves the data for the selected tools.

To edit the selection:

1. Push / to highlight the tool name.
2. Push  or touch the **Edit** target. The Edit menu gives you a choice to display the measurement data and/or save it to the SD memory card.  
The display updates to show the wireless icon and live measurement for each selected wireless tool.

## **Remote Control**

You can view the display of the Imager with a PC that has SmartView software installed or the Fluke Connect mobile app. The TiX560 Imager has the additional ability so you can also remotely control the Imager with SmartView software or the Fluke Connect app.

To set up:

1. Attach the included USB cable to the USB port on the imager.
2. Connect the other end to a USB port on a PC.

3. In SmartView software, choose **Remote Display** from the drop down menu to begin live video streaming on the PC.

To remotely control and show the Imager's display:

1. If not installed, install the latest version of SmartView software on your PC.
2. Attach the included USB cable to the USB port on the Imager.
3. Connect the other end of the cable to a USB port on the PC.  appears in the SmartView workspace.
4. Select **Remote Display** from the drop down menu.

### **TiX560 only**

5. Use the buttons and touch screen on the UI the same as the physical Imager.
6. Follow the instructions in the software help files for additional information about the controls on the software UI.

## **Maintenance**

The Imager does not require maintenance.

### **Warning**

**To prevent eye damage and personal injury, do not open the Product. The laser beam is dangerous to eyes. Have the Product repaired only through an approved technical site.**

### **How to Clean the Case**

Clean the case with a damp cloth and a weak soap solution. Do not use abrasives, isopropyl alcohol, or solvents to clean the case or lens/window.

### **Battery Care**

#### **⚠ Warning**

**To prevent personal injury and for safe operation of the Product:**

- **Do not put battery cells and battery packs near heat or fire. Do not put in sunlight.**
- **Do not disassemble or crush battery cells and battery packs.**
- **Remove batteries to prevent battery leakage and damage to the Product if it is not used for an extended period.**
- **Connect the battery charger to the mains power outlet before the Product or battery.**
- **Use only Fluke approved power adapters to charge the battery.**
- **Keep cells and battery packs clean and dry. Clean dirty connectors with a dry, clean cloth.**

#### **⚠ Caution**

**To prevent damage, do not expose Product to heat sources or high-temperature environments such as an unattended vehicle in the sun.**

To get the best performance from the lithium-ion battery, use the guidelines that follow:

- Do not store the Imager on the charger for more than 24 hours as reduced battery life may result.
- Charge the Imager for a two-hour minimum at six-month intervals for maximum battery life. Without use, the battery will self-discharge in approximately six months. Batteries stored for long periods will need two to ten charging cycles for full capacity.
- Always operate in the specified temperature range.
- Do not store the batteries in extreme cold environments.
- Do not attempt to charge the batteries in extreme cold environments.

#### **⚠ Caution**

**Do not incinerate the Product and/or battery.**

## **General Specifications**

### **Temperature**

Operating..... -10 °C to +50 °C (14 °F to 122 °F)  
Storage..... -20 °C to +50 °C (-4 °F to +122 °F) without batteries

**Relative Humidity**..... 10 % to 95 % non-condensing

### **Altitude**

Operating..... 2,000 m (6,562 ft)  
Storage..... 12,000 m (39,370 ft)

**Display**..... 14.5 cm (5.7 in) diagonal landscape color VGA (640 x 480) LCD with backlight

**Software**..... SmartView<sup>®</sup> full analysis and reporting software available for free download at [www.fluke.com](http://www.fluke.com)

### **Power**

Batteries ..... 2 Lithium-ion rechargeable smart battery packs with 5-segment LED display to show charge level.  
Battery Life ..... 3 hours continuous use for each battery pack (assumes 50 % brightness of LCD)  
Battery Charge Time ..... 2.5 hours to full charge  
AC Battery Charge ..... Ti SBC3B Two Bay Battery Charger (110 V ac to 220 V ac, 50/60 Hz, included), or in-Imager charging. AC mains adapters included. Optional 12 V automotive charging adapter.  
AC Operation ..... AC operation with included power supply: 110 V ac– 220 V ac, 50/60 Hz, ac mains adapters included  
Power Save ..... User-selectable Sleep and Power Off modes

|  |  |
|--|--|
| <b>Safety Standards</b> .....              | IEC 61010-1, CAT None, Pollution Degree 2<br>IEC 60825-1, Class II, <1mW   |
| <b>Electromagnetic Compatibility (EMC)</b> |  |
| International .....                        | IEC 61326-1: Basic Electromagnetic Environment<br>CISPR 11: Group 1, Class A<br><br><i>Group 1: Equipment has intentionally generated and/or uses conductively-coupled radio frequency energy that is necessary for the internal function of the equipment itself.</i><br><br><i>Class A: Equipment is suitable for use in all establishments other than domestic and those directly connected to a low-voltage power supply network that supplies buildings used for domestic purposes. There may be potential difficulties in ensuring electromagnetic compatibility in other environments due to conducted and radiated disturbances.</i><br><br><i>Emissions that exceed the levels required by CISPR 11 can occur when the equipment is connected to a test object.</i> |
| Korea (KCC) .....                          | Class A Equipment (Industrial Broadcasting & Communication Equipment)<br><br><i>Class A: Equipment meets requirements for industrial electromagnetic wave equipment and the seller or user should take notice of it. This equipment is intended for use in business environments and not to be used in homes.</i>  |
| USA (FCC) .....                            | 47 CFR 15 subpart B. This product is considered an exempt device per clause 15.103.  |
| <b>Vibration</b> .....                     | 2.5 G, IEC 68-2-6  |
| <b>Shock</b> .....                         | 25 G, IEC 68-2-29  |
| <b>Drop</b> .....                          | 1 m (3.3 ft) with standard lens  |
| <b>Size (H x W x L)</b> .....              | 27.3 cm x 15.9 cm x 9.7 cm (10.8 in x 6.3 in x 3.8 in)   |
| <b>Weight (includes battery)</b> .....     | 1.54 kg (3.4 lb)   |
| <b>Enclosure Rating</b> .....              | IP54   |
| <b>Warranty</b> .....                      | 2 years  |
| <b>Calibration Cycle</b> .....             | 2 years (assumes normal operation and normal aging)  |
| <b>Supported Languages</b> .....           | Czech, Dutch, English, Finnish, French, German, Hungarian, Italian, Japanese, Korean, Polish, Portuguese, Russian, Simplified Chinese, Spanish, Swedish, Traditional Chinese, and Turkish  |

## **Detailed Specifications**

### **Temperature Measurements**

Temperature Range (not calibrated below -10 °C)

TiX520 ..... -20 °C to +850 °C (-4 °F to +1562 °F)

TiX560 ..... -20 °C to +1200 °C (-4 °F to +2192 °F)

Accuracy

Range 1, 2 ..... ±2 °C or 2 % (whichever is greater) at 25 °C ambient

Range 3 ..... ±4 °C or 2 % (whichever is greater) at 25 °C ambient

On-screen emissivity correction ..... 1 % to 100 %

On-screen reflected background

temperature compensation ..... yes

On-screen transmission correction ..... 1 % to 100 %

### **Imaging Performance**

Image Capture Frequency ..... 9 Hz or 60 Hz refresh rate

Detector Type ..... 320 X 240 Focal Plane Array, uncooled microbolometer

Thermal Sensitivity (NETD)

TiX520 ..... 50 mK (40 mK with Filter Mode)

TiX560 ..... 45 mK (30 mK with Filter Mode)

Total pixels ..... 76,800

Infrared spectral band ..... 8 μm to 14 μm (long wave)

### **Visual (Visible Light) Camera**

Type ..... Industrial performance 5.0 megapixel

Minimum parallax alignment

with standard IR lens ..... ~60 cm (~24 in)

**Infrared Lenses**

| Lens                     | Field of View  | Spatial Resolution (IFOV) | Minimum Focus Distance |
|--------------------------|--|---------------------------|------------------------|
| Standard IR Lens         | 24 ° x 18 °  | 1.31 mRad                 | 15 cm (6 in)           |
| Optional 2x Telephoto    | 12 ° x 9 °   | 1.05 mRad                 | 45 cm (18 in)          |
| Optional Wide-angle      | 48 ° x 36 °  | 4.19 mRad                 | 15 cm (6 in)           |
| Optional 4X Telephoto    | Go to <a href="http://www.fluke.com">www.fluke.com</a> for more information. |                           |                        |
| Optional 25-micron macro |  |                           |                        |

**Focus Mechanism**

- LaserSharp™ Auto Focus System ..... all models
- Advanced Manual Focus ..... all models
- Level and Span
  - Smooth Auto-Scaling and Manual scaling of level and span
  - Fast auto setting/switching between manual and auto modes
  - Fast auto rescale in manual mode
  - Minimum Span (in manual mode)..... 2.0 °C (3.6 °F)
  - Minimum span (in auto mode) ..... 3.0 °C (5.4 °F)

**Image and Data Storage**

|   |  |
|---|--|
| File Formats.....                                   | BMP, JPG, IS2, IS3, AVI (No analysis software required for .bmp and .jpg files)  |
| Export File Formats with SmartView® Software .....  | JPEG, JPG, JPE, JFIF, BMP, GIF, DIB, PNG, TIF, TIFF  |
| Memory Review.....                                  | Preview image navigation and review selection  |
| Video Recording                                     |  |
| Standard, Non-Radiometric.....                      | Viewable through Smart View software, Windows Media Player, Quicktime, and on Imager. H.264 MPEG encoding AVI will also allow voice recording in addition to captured video. Video functions to include: record, stop, rewind, fast forward, pause/play. Maximum recording time = minimum of ten minutes @ 30 Hz (requires class 10 micro SD). |
| Radiometric .....                                   | Viewable on Imager and with SmartView software in proprietary .is3 format. Supports voice recording in addition to captured video Video functions to include: stop, rewind, fast forward, pause/play. Maximum recording time = minimum of ten minutes @ 30 Hz.   |
| Storage Medium                                      |  |
| Micro SD Memory Card .....                          | Includes ≥4 GB memory card to store at least 2000 fully radiometric (.is2) IR and linked visual images each with 60 seconds voice annotations or 5000 basic (.bmp or .jpg) images  |
| Internal on-board flash memory.....                 | 4 GB available for storage   |
| USB direct download with USB-to-PC cable connection |  |
| USB accessory connection                            |  |

*Note*

*The addition of IR-PhotoNotes or other saved items can vary the total number of images that can be stored on the SD memory card.*

