

TiX640, TiX660, TiX1000

Thermal Imager

Users Manual

PN 4583397

September 2014

© 2014 Fluke Corporation. All rights reserved. Specifications are subject to change without notice.

All product names are trademarks of their respective companies.

LIMITED WARRANTY AND LIMITATION OF LIABILITY

This Fluke product will be free from defects in material and workmanship for two years from the date of purchase. This warranty does not cover fuses, disposable batteries, or damage from accident, neglect, misuse, alteration, contamination, or abnormal conditions of operation or handling. Resellers are not authorized to extend any other warranty on Fluke's behalf. To obtain service during the warranty period, contact your nearest Fluke authorized service center to obtain return authorization information, then send the product to that Service Center with a description of the problem.

THIS WARRANTY IS YOUR ONLY REMEDY. NO OTHER WARRANTIES, SUCH AS FITNESS FOR A PARTICULAR PURPOSE, ARE EXPRESSED OR IMPLIED. FLUKE IS NOT LIABLE FOR ANY SPECIAL, INDIRECT, INCIDENTAL OR CONSEQUENTIAL DAMAGES OR LOSSES, ARISING FROM ANY CAUSE OR THEORY. Since some states or countries do not allow the exclusion or limitation of an implied warranty or of incidental or consequential damages, this limitation of liability may not apply to you.

Fluke Corporation
P.O. Box 9090
Everett, WA 98206-9090
U.S.A.

Fluke Europe B.V.
P.O. Box 1186
5602 BD Eindhoven
The Netherlands

Table of Contents

Chapter	Title	Page
1	Before You Start	1-1
	Introduction	1-3
	How to Contact Fluke	1-4
	Safety Information	1-4
	Optional Accessories.....	1-8
	Technical Description	1-8
	Functional Principle	1-8
	Description of the Functional Units	1-8
	Lens	1-8
	Detector	1-10
	Detector Electronics.....	1-10
	Image Processing Electronics.....	1-10
	Optomechanics	1-11
	Controls	1-11
	Power Supply.....	1-11
	Interfaces	1-12
	Technical Data.....	1-12
	Unpacking and Control.....	1-14

Parts of the Thermal Imager	1-15
Quick Guide	1-17
Preparation	1-18
Start	1-18
Display	1-19
Setting the Focus	1-20
Setting the Temperature Range	1-20
Saving Images	1-23
Saving with "Check"	1-23
Quick Saving	1-23
Menu Functions	1-24
Shut-Down	1-24
Data Transmission to the Computer	1-25
Start-Up	1-25
Hand Strap	1-25
Tripod	1-25
Power Supply	1-25
Memory Card	1-25
Lens Replacement	1-26
Operation using the Gigabit Ethernet (GigE) Interface	1-26
Ethernet Cable and AC Adapter	1-27
AC Adapter Connection	1-27
Operation with Breakout Box	1-27
Trigger Function	1-29
SyncOut	1-29
2 Elements of the User Interface	2-1
Introduction	2-3
Button Functions	2-5
Image Elements	2-7

	Setting the Temperature Scale.....	2-9
	Focus	2-10
	LaserSharp® Auto Focus	2-10
	Permanent LaserSharp® Auto Focus.....	2-10
	EverSharp Multifocal Recording	2-10
	Spot Editor	2-11
	Saving	2-11
	Saving with Check.....	2-12
	Quick Saving	2-12
3	Display Menus	3-1
	Introduction	3-3
	Image Submenu	3-4
	Manual Submenu	3-5
	Mode Submenu	3-7
	Zoom Submenu	3-10
	Palette Submenu	3-11
	Elements Submenu	3-14
	Isotherms Submenu	3-15
	Filter Mode Submenu	3-17
	Format (Subwindowing) Submenu	3-17
	File Menu	3-18
	Directory Structure.....	3-18
	Load Submenu	3-18
	Save Submenu	3-21
	IR Photonotes Submenu	3-24
	Format SD Submenu.....	3-25
	Saving Format Submenu.....	3-25
	Measure Menu	3-27
	Spot Temperature Submenu	3-27

	Measurement Definitions Submenu	3-28
	Correction Submenu	3-32
	GPS Submenu	3-36
	Laser Submenu.....	3-36
	Settings Menu.....	3-37
	Calibration Submenu	3-37
	Extras Submenu	3-38
	Automatic Submenu.....	3-39
	Compensation Submenu	3-40
	Buttons Submenu	3-41
	Digital Alarm Output Submenu.....	3-44
	Configuration Submenu	3-45
	System Menu.....	3-47
	Display Submenu.....	3-48
	Regional Submenu	3-49
	Date and Time Submenu	3-49
	Menu Layout Submenu.....	3-50
	Menu Control Submenu	3-51
	Info Submenu.....	3-52
4	Maintenance.....	4-1
	Introduction	4-3
	How to Clean	4-3
	Calibration	4-3
	Environmental.....	4-3
	Service.....	4-4
	Battery	4-4

List of Tables

Table	Title	Page
1-1.	Symbols.....	1-7
1-2.	Thermography System with 1024 x 768 IR Pixel Resolution.....	1-9
1-3.	Thermal Imager Components.....	1-15
1-4.	Front View of Thermal Imager.....	1-16
1-5.	Control Locations.....	1-17
1-6.	Arrangement of the Image Elements.....	1-19
1-7.	Breakout Box.....	1-28
2-1.	Control Locations.....	2-4
2-2.	Shortcuts.....	2-5
2-3.	Image Elements.....	2-7
3-1.	Palettes.....	3-12
3-2.	Setting Selections.....	3-26
3-3.	Button Functions.....	3-42

List of Figures

Figure	Title	Page
1-1.	Lens Cover Laser Warning.....	1-5
1-2.	Ethernet Cable and AC Adapter	1-27
1-3.	AC Adapter.....	1-27

Chapter 1

Before You Start

Title	Page
Introduction	1-3
How to Contact Fluke	1-4
Safety Information	1-4
Optional Accessories.....	1-8
Technical Description	1-8
Functional Principle.....	1-8
Description of the Functional Units.....	1-8
Lens	1-8
Detector.....	1-10
Detector Electronics	1-10
Image Processing Electronics	1-10
Optomechanics	1-11
Controls	1-11
Power Supply	1-11
Interfaces.....	1-12
Technical Data	1-12

Unpacking and Control	1-14
Parts of the Thermal Imager	1-15
Quick Guide	1-17
Preparation	1-18
Start	1-18
Display	1-19
Setting the Focus	1-20
Setting the Temperature Range	1-20
Saving Images	1-23
Saving with "Check"	1-23
Quick Saving	1-23
Menu Functions	1-24
Shut-Down	1-24
Data Transmission to the Computer	1-25
Start-Up	1-25
Hand Strap	1-25
Tripod	1-25
Power Supply	1-25
Memory Card	1-25
Lens Replacement	1-26
Operation using the Gigabit Ethernet (GigE) Interface	1-26
Ethernet Cable and AC Adapter	1-27
AC Adapter Connection	1-27
Operation with Breakout Box	1-27
Trigger Function	1-29
SyncOut	1-29

Introduction

The TiX640, TiX660, and TiX1000 Thermal Imagers (the Product) are state-of-the-art thermography systems for precise, quick, and non-contact measurement of the surface temperature of objects.

These thermal imagers are designed for universal application and can be used both as a mobile and as a stationary device for measuring and storing temperature values. The compact and resilient design and a high degree of protection allow for industrial application even in unfavorable external conditions. The low weight of the device, as well as the long operating time of the rechargeable battery allow for efficient use in this.

High measurement accuracy, precision optics with extraordinary image quality, as well as the universal interface concept for digital real-time thermography data collection using GigE-Vision allow for using the thermal imager in a wide variety of applications.

The thermal imager is equipped with a digital color video camera in order to document the measuring situation on photos. Infrared (IR) and visual light images, as well as image sequences can be saved to SD and SDHC (Secure Digital High Capacity) cards. For the purposes of visualization, the thermography system is equipped with a swivel-mounted color thin film transistor (TFT) viewfinder and a pivot and swivel-mounted active color TFT display.

Diverse accessories and different software packages for pre- and post-processing of the recordings turn the product into a universal thermography system for a broad range of applications.

Typical fields of application of the thermography system are:

- thermographic inspection of electrical and mechanical systems
- optimization of components and assemblies
- material inspections
- control of process temperatures
- quality assurance
- building inspection and diagnostics
- research and development

How to Contact Fluke

To contact Fluke, call one of the following telephone numbers:

- Technical Support USA: 1-800-44-FLUKE (1-800-443-5853)
- Calibration/Repair USA: 1-888-99-FLUKE (1-888-993-5853)
- Canada: 1-800-36-FLUKE (1-800-363-5853)
- Europe: +31 402-675-200
- Japan: +81-3-6714-3114
- Singapore: +65-6799-5566
- Anywhere in the world: +1-425-446-5500

Go to www.fluke.com to register your product, download manuals, and find more information.

To view, print, or download the latest manual supplement, visit <http://us.fluke.com/usen/support/manuals>.

Safety Information

A **Warning** identifies conditions and procedures that are dangerous to the user. A **Caution** identifies conditions and procedures that can cause damage to the Product or the equipment under test.

Warning

To prevent eye damage and personal injury:

- **Do not look into the laser. Do not point laser directly at persons or animals or indirectly off reflective surfaces.**
- **Do not open the Product. The laser beam is dangerous to eyes. Have the Product repaired only through an approved technical site.**
- **Do not locate the laser beam so that it is at eye level when you install the thermography system.**

- **The Product is equipped with an LED light to illuminate the image. Avoid any direct eye contact and do not point the LED light at people, animals, or reflective surfaces.**

Additional laser warning information is on the case of the Product, see Figure 1.



hvh300.eps

Figure 1-1. Lens Cover Laser Warning

⚠ ⚠ Warning

To prevent possible electrical shock, fire, or personal injury:

- **Carefully read all instructions.**
 - **Read all safety information before you use the Product.**
 - **Use the Product only as specified or the protection supplied by the Product can be compromised.**
- **Do not use the Product around explosive gas, vapor, or in damp or wet environments.**
 - **Use this Product indoors only.**
 - **Examine the case before you use the Product. Look for cracks or missing plastic. Carefully look at the insulation around the terminals.**
 - **Do not use the Product if it is damaged.**
 - **Do not use the Product if it operates incorrectly.**

- Replace the batteries when the low battery indicator shows to prevent incorrect measurements.
- Remove the batteries if the Product is not used for an extended period of time, or if stored in temperatures above 50 °C. If the batteries are not removed, battery leakage can damage the Product.
- Batteries contain hazardous chemicals that can cause burns or explode. If exposure to chemicals occurs, clean with water and get medical aid.
- Do not disassemble the battery.
- Do not short the battery terminals together.
- Do not disassemble or crush battery cells and battery packs.

- Do not keep cells or batteries in a container where the terminals can be shorted.
- Do not put battery cells and battery packs near heat or fire. Do not put in sunlight.











⚠ Warning

For safe operation and maintenance of the Product:

- Repair the Product before use if the battery leaks.
- Be sure that the battery polarity is correct to prevent battery leakage.
- Use only Fluke approved power adapters to charge the battery.

Table 1-1 is a list of symbols used on the Imager and in this manual.

Table 1-1. Symbols

Symbol	Description	Symbol	Description
	Important information. See manual.		Warning. Laser.
	On/Off Symbol.		Battery status.
	Conforms to relevant South Korean EMC standards.		Battery charging when animated.
	Conforms to relevant Australian standards.		Conforms to relevant North American Safety Standards.
	Conforms to requirements of European Union and European Free Trade Association.		
	This Product contains a lithium-ion battery. Do not mix with the solid waste stream. Spent batteries should be disposed of by a qualified recycler or hazardous materials handler per local regulations. Contact your authorized Fluke Service Center for recycling information.		
	This product complies with the WEEE Directive (2002/96/EC) marking requirements. The affixed label indicates that you must not discard this electrical/electronic product in domestic household waste. Product Category: With reference to the equipment types in the WEEE Directive Annex I, this product is classed as category 9 "Monitoring and Control Instrumentation" product. Do not dispose of this product as unsorted municipal waste. Go to Fluke's website for recycling information.		

Optional Accessories

- ac adapter with 14-pin LEMO connector
- replacement lenses, macro attachments
- protective window for lenses, laser protection filter
- breakout box
- Bluetooth headset
- gigabit Ethernet card
- Ethernet cable with 8-pin LEMO connector
- device tripod

Technical Description

Functional Principle

The Product is a thermography system designed for the long-wave infrared spectral range (LWIR) of 7.5 μm to 14 μm . The lens reproduces the object scene to a microbolometer array with 1024 x 768 and/or 640 x 480 pixels. The electrical signal of the detector array is processed further by the internal electronics. In this, the electronics comprise all functions required for camera operation, such as actuation of the microbolometer array, A/D conversion, offset and gain correction, pixel correction, as well as actuation of the different interfaces.

Operation is optionally performed directly using the integrated keyboard (joystick, focus rocker switch, function buttons) or using optional interfaces. RS232, Ethernet (GigE Vision), or USB2.0 are available as interfaces. Specific software packages are required in order to use these interfaces.

Description of the Functional Units

Lens

The camera lens collects the IR radiation in the field of view emitted by the measuring object and reproduces this IR radiation on the detector array. Field of view (FOV) and resolution/measuring spot size (IFOV, Instantaneous Field of View) are determined at the same distance to the focal distance f of the used lens.

Table 1-2 is a list the optional lenses that are available:

Table 1-2. Thermography System Lenses

Model	Lens	Focal distance (mm)	Focus (m)	1024 x 768		640 x 480	
				IFOV (mrad)	FOV (°)	IFOV (mrad)	FOV (°)
FLK-Xlens/Sup-Wide	Super wide-angle lens	7.5	0.17	2.3	135.8 x 104.4	3.3	128.9 x 92.7
FLK-Xlens/Wide	Wide-angle lens	15	0.47	1.1	68.7 x 50.7	1.7	62.3 x 46.4
FLK-Xlens/Stan	Standard lens	30 0.72		0.6	32.4 x 24.7	0.8	30.9 x 23.1
FLK-Xlens/Tele	Telephoto lens	60	1.99	0.3	16.4 x 12.4	0.4	14.9 x 11.3
FLK-Xlen/SupTele	Super telephoto lens	120	6.58	0.1	8.1 x 6.2	0.2	7.5 x 5.7
Model	Lens	Focal distance (mm)	Focus (m)	IFOV (mrad)	Resolution (μm)	IFOV (mrad)	Resolution (μm)
FLK-Xlens/Macro1	Close-up 0.2x	for 30	137.4	85.5 x 63.2	81	78.1 x 57.9	119
FLK-Xlens/Macro2	Close-up 0.5x	for 30	47.4	34.3 x 25.3	32	31.3 x 23.2	47
FLK-Xlens/Macro3	Close-up 0.5x	for 60	100	35.1 x 26.5	35	32.3 x 24.4	50

Detector

The thermal imager is equipped with an uncooled microbolometer FPA detector (uncooled Focal Plane Array) with a resolution of (1024 x 768) or (640 x 480) IR pixels. The individual elements of the detector are microscopically small thin-film resistors on extremely thin diaphragms arranged a few micrometers above the silicon read-out circuit in an unsupported manner. The lens of the thermography system reproduces the thermal radiation from the scene onto these detector elements and these detector elements absorb this radiation. The temperature change of the detector elements results in signals that can be analyzed electronically, read-out line-by-line and column-by-column using a read-out circuit.

Use of an uncooled detector ensures the quick availability of the camera function at start-up (starting time <30 seconds) and a long mean time to failure (MTTF) in continuous operation.

Detector Electronics

Detector electronics supply the BIAS voltages and further actuation signals required for detector operation to ensure that the analog output signal of the detector is preprocessed and digitalized.

Image Processing Electronics

With the help of an FPGA (Field Programmable Gate Array) and up to two processors, real-time image processing with the following essential functions (depending on the equipment) is implemented:

- detector electronics interface
- gain and offset correction
- defect pixel treatment
- low-pass filtration
- zoom generator
- graphics overlay
- VIS/IR/graphics mixer
- GigE-Vision interface
- PC interfaces (Wi-Fi SD Card/USB2.0)
- video image interfaces (DVI-D, FBAS)

Optomechanics

With the help of an optomechanic assembly, the following functions are implemented:

- LaserSharp® Auto Focus
- measuring range switch-over (apertures)
- internal NUC (Non Uniformity Correction) with shutter

Furthermore, this assembly optionally comprises a module for hardware-based increase of the geometric resolution of the thermography system to 2048 x 1536 IR pixels (detector with 1024 x 768 pixels) and 1280 x 960 IR pixels (detector with 640 x 480 pixels) in SuperResolution mode.

Controls

The thermal imager is controlled by means of a focus rocker switch ◀▶ with center function for autofocus, the function buttons **A** Automatic, **T** Temperature, Start/Stop/Save, and the multi-function buttons **1** and **2** at the right top. On the backside of the camera, a power button **⏻** for right-thumb operation, a joystick **⬆** with center function (Enter), and the **C** button (Cancel) can be found. The controls of the thermal imager are arranged for single-hand operation with the right hand. Another multi-function button **M** can be found at the top of the handle. When carrying the camera on its handle, it can be operated using the thumb of your right hand.

Specific modes of camera operation and presettings can be configured using menus. Chapter 2 contains a detailed description of how to operate the thermography system, as well as a detailed description of the menu structure.

The thermal imager can be controlled remotely via the RS232 or GigE-Vision interfaces.

Power Supply

Optionally, an external 15 V ac adapter (accessories) or a rechargeable lithium-ion battery 7.2 V (accessories) can be used to supply the thermal imager with power.

The ac adapter is connected to the 14-pin (right-hand side) LEMO socket on the backside of the housing. The rechargeable battery is inserted vertically into the designated position on the backside of the thermography system (see Chapter 3).

Interfaces

The thermography system is equipped with the following interfaces:

- drive for SD/SDHC card (behind the cover on the left side of the camera, unfold the display)
- DVI-D (HDMI socket) behind the cover on the backside of the camera, composite video (LEMO 14-pin)
- 2 x digital E/A for external trigger input/trigger output (TTL level, LEMO 14-pin)
- 2 x analog output 0-5V (LEMO 14-pin)
- USB 2.0 (mini-AB, behind the cover on the backside of the camera)
- RS232 (LEMO 14-pin)
- GigE-Vision (LEMO 8-pin)

Simultaneously using several interfaces on the 14-pin LEMO socket is allowed for by means of a breakout box. The breakout box is also used for external power supply.

As an alternative to the digital high-resolution DVI-D image data on the HDMI socket, the analog image data (4:3 PAL/NTSC) is available as FBAS signal (composite) on the 14-pin LEMO socket. The HDMI socket can be used to connect screens processing a resolution of 1280 x 768 or 1280 x 800 in accordance with the VESA standard.

In connection with the provided software, the GigE-Vision interface allows for remotely controlling the thermography system, as well as for transmitting digital image information to a PC in real time.

Note

SmartView[®] software support for GigE-Vision is planned in 2015.

Technical Data

Spectral range	7.5 µm to 14 µm
Temperature measurement range	
TiX1000, TiX660	-40 °C to +1200 °C (-40 °F to +2192 °F) with high temperature option: up to 2000 °C (3632 °F)
TiX640	-40 °C to +1200 °C (-40 °F to +2192 °F)
Measurement accuracy	±1.5 K or ±1.5 %
Image resolution (pixels)	
TiX1000	1024 x 768 2048 x 1536 (SuperResolution)
TiX660	640 x 480 1280 x 960 (SuperResolution)
TiX640	640 x 480
Frame rate (@ max. image resolution)	
TiX1000	30 Hz
TiX660, TiX640	60 Hz

Field of view (FOV) standard 30 mm lens	
TiX1000	32.4° x 24.7°
TiX660, TiX640	30.9° x 23.1°
Thermal sensitivity [NETD]	
TiX1000	≤0.05 °C at 30 °C target temp (50 mK)
TiX660, TiX640	≤0.03 °C at 30 °C target temp (30 mK)
Digital zoom.....	up to 32x
A/D conversion	16-bit
Power supply	
External	12 V dc to 24 V dc
Battery	Standard lithium-ion video camera battery
Operating temperature	
with external power	-25 °C to +55 °C (-13 °F to +131 °F)
with battery power	-25 °C to +40 °C (-13 °F to +104 °F)
Storage temperature	-40 °C to +70 °C (-40 °F to +158 °F)
Operating altitude	<2000 m
Humidity	relative humidity 10 % to 95 %, non-condensing
Shock	Operational: 25G, IEC 68-2-29
Vibration	Operational: 25G, IEC 68-2-6
Protection class	IP54

Safety	meets IEC 60825-1: class 2
Electromagnetic Compatibility.....	meets IEC 61326-1: Portable
Applies to use in Korea only.	Class A Equipment (Industrial Broadcasting & Communication Equipment) ^[1]

[1] This product meets requirements for industrial (Class A) electromagnetic wave equipment and the seller or user should take notice of it. This equipment is intended for use in business environments and is not to be used in homes.

Dimensions with standard 30 mm lens	
TiX1000, TiX660	210 mm x 125 mm x 155 mm (8.25 in x 4.9 in x 6.1 in)
TiX640	206 mm x 125 mm x 139 mm (8.1 in x 4.9 in x 5.5 in)

Weight with standard 30 mm lens	
TiX1000, TiX660	1.95 kg (4.3 lb)
TiX640	1.4 kg (3.1 lb)

Display	Extra-large 5.6 in color TFT display, 1280 x 800 pixel resolution, Suitable for daylight operation
---------------	--

Viewfinder	
TiX1000, TiX660	Tilt-able LCoS color viewfinder display, 800 x 600 pixel resolution
TiX640	none

Digital visible light camera.....	up to 8 Megapixel resolution for image and video recording
-----------------------------------	--

Image/video storage.....	SDHC memory card
--------------------------	------------------

TiX640, TiX660, TiX1000

Users Manual

Interfaces

Supported in camera data ports (image transfer).....SD card, USB 2.0, video output DVI-D HDMI (GigE vision, RS232 available in 2015)

Supported in SmartView® softwareSD card (USB 2.0, GigE Vision, RS232 available in 2015)

Features:

- Fluke Connect® compatible
- AutoBlend™ mode
- LaserSharp® Auto Focus (TiX660, TiX1000 only)
- Auto Focus
- Manual Focus
- EverSharp multifocal recording
- SuperResolution
- Dynamic SuperResolution
- Laser pointer
- Laser distance meter (TiX660, TiX1000 only)
- GPS
- Text and voice annotation
- Audio
- Replaceable Smart Batteries with LED level indicator (2 with TiX660, TiX1000/1 with TiX640)
- SmartView® software compatible

Unpacking and Control

When you receive your thermal imager, check the components for completeness and integrity. Possible damages must be reported to the supplier immediately.

The thermal imager system is delivered in a transport box.

The basic package contains the following components:

- thermography camera with lens and 5.6" TFT display
- integrated digital color video camera
- depending on the equipment, Laser Distance Meter/laser pointer, GPS
- rechargeable lithium-ion battery NP-QM91D (Sony) (2 with TiX660, TiX1000/1 with TiX640)
- battery charger
- SDHC card
- card adapter for SD card
- protective lens cap
- shoulder strap
- users manual (go to www.fluke.com to download the users manual for this Product)
- safety information
- transport box/transport packaging
- ac adapter

Parts of the Thermal Imager

See Table 1-3 and Table 1-4 for a general overview of the thermal imager components.

Table 1-3. Thermal Imager Components

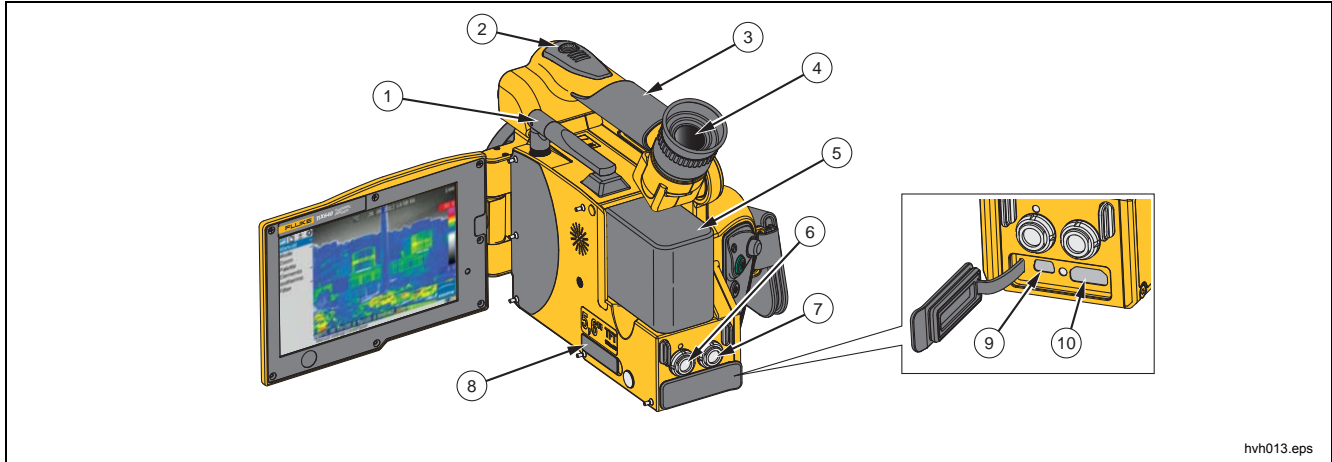

hvh013.eps

Item	Description	Item	Description
①	WLAN/Bluetooth	⑥	Connection for GigE-Vision, RS232
②	Multifunction button	⑦	Connection for power supply, trigger, FBAS
③	Handle	⑧	SD card slot
④	Color TFT viewfinder	⑨	USB port
⑤	Lithium-ion battery	⑩	DVI port

Table 1-4. Front View of Thermal Imager

Item	Description
①	Color Video Camera
②	Lens
③	Laser Range Finder
④	LED Video Light
⑤	Color TFT Display

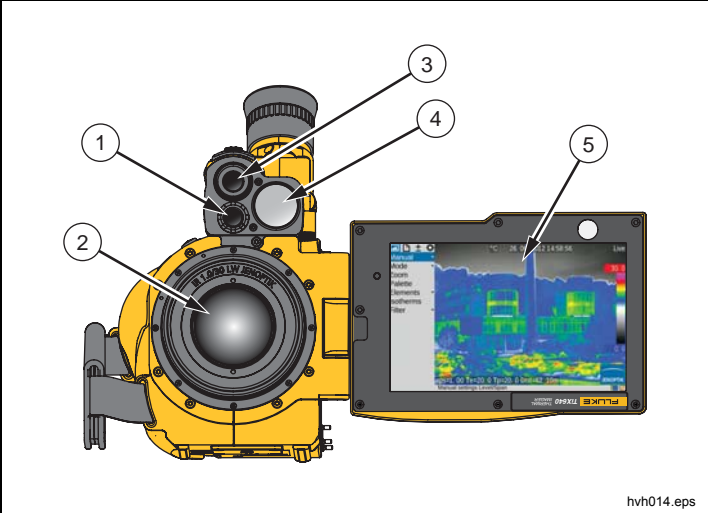

The image shows a front view of a yellow thermal imager. Five numbered callouts point to specific components: 1 points to the color video camera lens, 2 points to the main thermal imager lens, 3 points to the laser range finder, 4 points to the LED video light, and 5 points to the color TFT display screen. The display shows a thermal image of a building with a color scale from blue (cooler) to red (warmer). The device has a yellow body with a grey top section. The text 'hvH014.eps' is visible at the bottom right of the image area.

Quick Guide

Table 1-5 shows the location of the controls on your thermal imager. In order to achieve professional results, we recommend thoroughly reading the entire manual.

Table 1-5. Control Locations

Item	Description
①	Focus rocker switch with autofocus ◀▶
②	Temperature T
③	Auto A
④	Multifunction 2 2
⑤	Multifunction 1 1
⑥	Save S
⑦	Joystick ⬆⬇⬅➡
⑧	Power ⏻
⑨	Escape C
⑩	Power LED

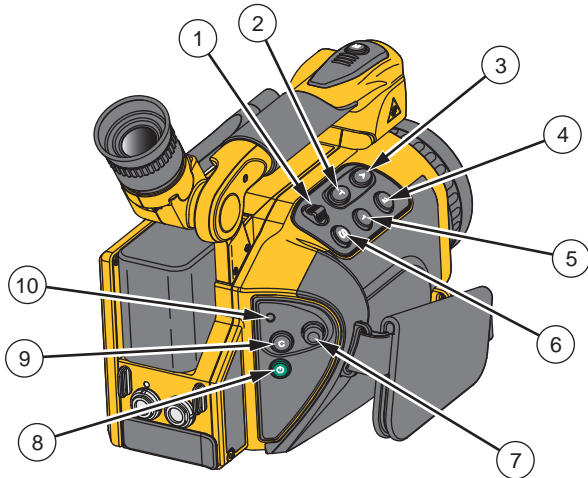

hvh015.eps

Note

All buttons can be used for multiple functions triggered either by:

- half or full pressing: **S** and **M** and/or
- short or long press: **A**, **T**, **1**, and **2**.

The button function can be changed by changing the settings in menu "Settings" → "Buttons".

Preparation

You will need the following equipment:

- thermal imager
- rechargeable lithium-ion battery or ac adapter with LEMO connector
- SmartView[®] software
- SD card
- card reader for SD-/SDHC cards

Start

To get started:

1. Provide for power supply by inserting the charged rechargeable lithium-ion battery or by connecting the ac adapter to the thermal imager (plug the 14-pin connector into the right LEMO socket with the red dot pointing to the top).
2. Remove the cover of the SD card slot, insert the SD card into the card slot, and replace the cover.
3. Remove the protective cap from the lens.
4. Push . The imager turns on and the Fluke logo displays during the boot process. At system initialization the power-on LED initially flashes green and then illuminates as steady green to indicate that the thermal imager is ready-to-operate in Live mode.

Display

Table 1-6 shows the location of the display elements.

Table 1-6. Arrangement of the Image Elements

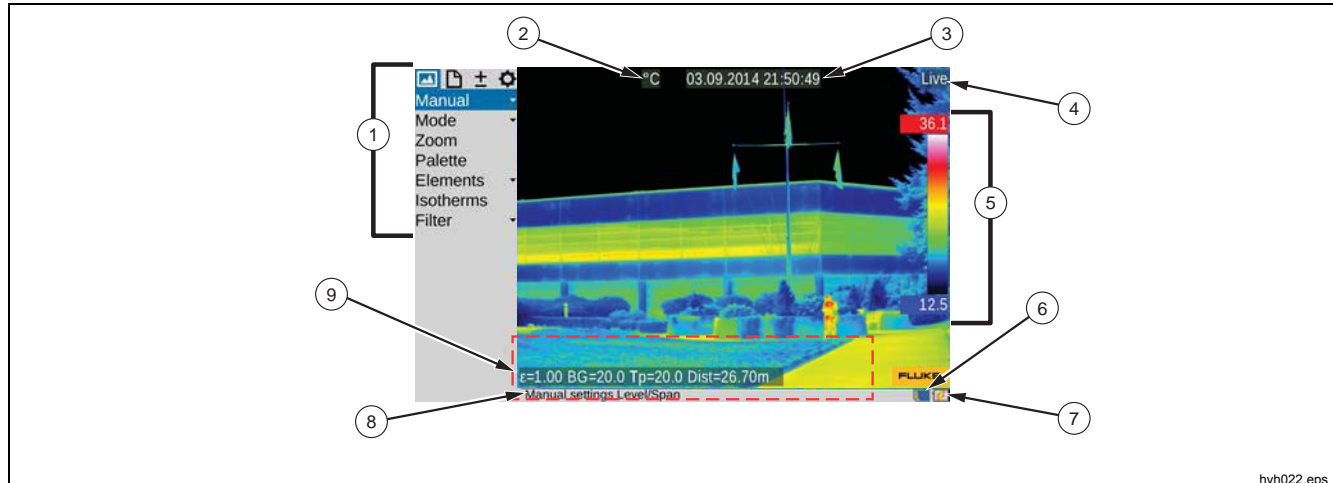

hvh022.eps

Item	Description	Item	Description
①	Camera menu	⑥	Rechargeable battery, SDHC card
②	Temperature unit	⑦	Status indications
③	Date/time	⑧	Help line
④	Camera status (mode)	⑨	System information field
⑤	Color scale with upper and lower limits		

Initially, you must select a motif with a contrasting scene (an active electrical device) and point the thermal imager towards this scene.

When using the viewfinder, fold the display to the side of the camera. The viewfinder is switched on by doing so. You must initially adapt the viewfinder to your eye using the diopter compensation. For this, the eyecup on the viewfinder is rotated. In order to find the ideal setting, you can use the sharpness of the letters initially.

Setting the Focus

Push ◀▶: middle button for autofocus or to the left or to the right in order to set the focus for longer or shorter distances to the measuring object. If the autofocus function is used, a rectangle will be displayed in the center of the screen. The distance setting is optimized taking the distance of the objects contained in the rectangle.

Setting the Temperature Range

Push the button **A** (shortly). The thermography system will automatically set a temperature scale of the false color image corresponding to the current scene:

The required temperature scale can also be set by means of the joystick . For this, select Menu "Image" → "Manual".

Depending on the selected input variant, the joystick  can be used in order to set the temperature level and the temperature range (Level/Range) or the upper and lower limits (Max/Min) and the values can be input numerically

as well. In this, the respective joystick and button functions are displayed to the left of the thermal image. The respective input dialog for numerical input is displayed in the center of the field of view:

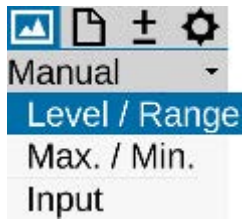

hvh030.jpg

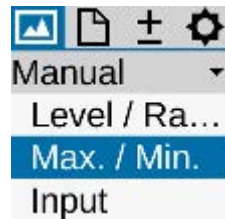

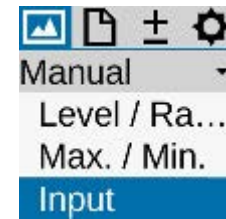

hvh031.jpg



hvh032.jpg

TiX640, TiX660, TiX1000

Users Manual

If the options Level/Range and Maximum/Minimum are set manually, the temperature scale can be adapted automatically once by shortly pushing the Enter  button. If the Enter  button is pushed longer, the scale is permanently adapted automatically. The AUTO mode

will then be displayed by **Auto** on the right side of the image above the color palette. The AUTO mode is terminated by any manual setting of Level/Range/Max/Min.



hvh033.jpg

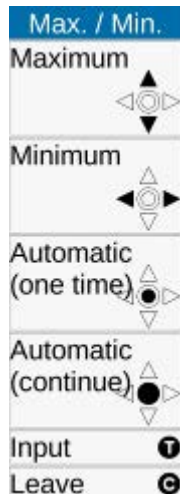

hvh034.jpg

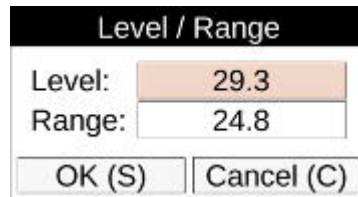

hvh036.jpg

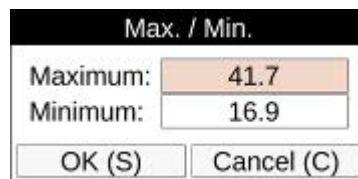



hvh035.jpg

Saving Images



In order to save the thermal image, the **S** button is required. The following variants are possible:

Saving with "Check"

1. Push the **S** button halfway down → the live image will be frozen: **Live** → **Freeze**.
 - The frozen image can initially be "checked" on the display or viewfinder.
 - If the image is not to be saved, push the **C** button: **Freeze** → **Live**.
2. Push the **S** button completely → the image is saved.

The process of writing the data is indicated by the changing color of the map symbol (in the line below the image, right-hand side):  → . When saving, the camera control automatically activates the Live mode: **Freeze** → **Live**.

Quick Saving

Immediately push the **S** button completely → image is saved immediately:  → , the camera control then automatically re-activates the Live mode: **Freeze** → **Live**.

Note

*Deviating from the factory setting described above, the **S** button can be used to trigger further functions such as shutter activation, autofocus, VIS-LED, Laser Distance Meter/laser pointer before saving the image.*

Menu Functions

The thermal imager offers a large number of analysis and automatic functions and can be configured individually for the respective use case. The settings and functions are selected in the camera menu, which is arranged at the left-hand side of the image area.

Use the joystick (↑, ↓, ←, →) to navigate the menu and select the functions using the Enter button.

The four main menus can be selected by means of tabs located on the upper margin of the menu and identified with the corresponding symbols:

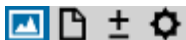

Image Menu



File Menu



Measure Menu

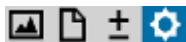

Settings Menu

Sub-menus can be opened by using the Enter button on the respective menu item, for example, push the **Manual** button in order to open the sub-menu for manually setting the temperature range.

Settings made can be accepted using the buttons Enter or **S** or discarded using the **C** button.

Shut-Down

Use **C** to open the shut-down dialog, and **S** or Enter to confirm the selection.

Data Transmission to the Computer

SmartView[®] software will enable the transmission of data via the optional GigE Vision (available in 2015).

Another data transmission method is to read out the SDHC card by means of a card reader.

Start-Up

Hand Strap

The thermal imager is designed as highly portable system for single-hand operation. Initially, adjust the hand strap attached to the handle piece as required. For this, open the loop of the hand strap and adjust the length of the belt strap in such a way that you can comfortably access the controls with your fingers. Then, close the hook and loop fastener of the loop.

Tripod

The thermography camera is equipped with a 1/4" photo thread (DIN 4503) on the bottom of the housing. In order to achieve rigid camera images, particularly for the SuperResolution mode, it is recommendable to fix the thermal imager to a tripod.

⚠ Caution

Observe the maximum penetration depth of the photo thread of 4.5 mm (DIN 4503).

Power Supply

When using a rechargeable battery, the battery must be placed on the adapter plate. Push down the rechargeable battery until it engages. In this, the rechargeable battery must be pushed slightly to the front towards the lens. In order to use the thermal imager, please only use the genuine SONY[®] rechargeable batteries NP-QM91D.

The ac adapter is connected to the 14-pin socket on the right-hand side of the backside of the thermography system.

Memory Card

The SD card slot is located on the left-hand side of the camera. In order to guarantee the degree of protection IP54, the slot is protected by a cover. Pull off the cover to insert a memory card and insert the SD card into the card slot. Please observe the proper orientation of the card (▲ to the top). Afterwards, the cover must be re-closed. This is the only way to ensure the complete degree of protection of the device.

Lens Replacement

Only replace the lenses in dry and low-dust conditions. When the lens is removed, the degree of protection IP 54 of the system is no longer guaranteed!

Position the thermal imager on a solid, level underground so that the lens is directed towards you. Rotate the lens on the thermography system counterclockwise as far as it will go and/or until the two red dots are aligned. Then, remove the lens to the front.

In order to attach the lens, the red marking spots on lens and camera must be aligned. In this position, the lens must be pressed slightly against the camera corpus and turned clockwise until the red dot of the lens is aligned with the white dot of the camera.

Operation using the Gigabit Ethernet (GigE) Interface

Please proceed as follows in order to connect the thermal imager to a PC/notebook. The accessories described are contained in the scope of delivery as an option.

- The Ethernet cable is used in order to establish a connection to the Ethernet interface of the PC (RJ45 connector).
- The 8-pin LEMO connector (blue mark) is connected to the left 8-pin LEMO socket (Figure 1-2, blue mark) on the camera.

⚠ Caution

Make sure you establish the connection to the correct LEMO socket. Plug the LEMO connector into the socket with the red dot directed to the top. Do not force the connector in.

Ethernet Cable and AC Adapter

The Ethernet cable is used in order to connect the thermography camera to the 8-pin LEMO socket (left-hand side, blue mark).

The 14-pin connector of the ac adapter is plugged into the right-hand side LEMO socket with the red mark pointing to the top. See Figure 1-2.

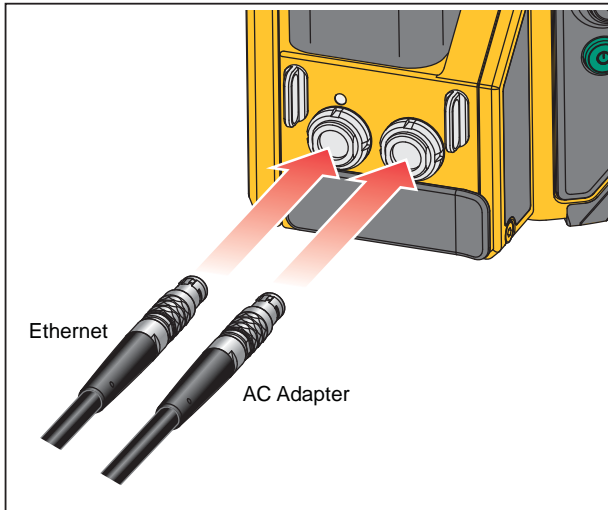

hvh057.eps

Figure 1-2. Ethernet Cable and AC Adapter

AC Adapter Connection

To operate while permanently connected to a notebook or PC, the power should be supplied using the ac adapter (see Figure 1-3) with the 14-pin LEMO connector on right-hand side socket.

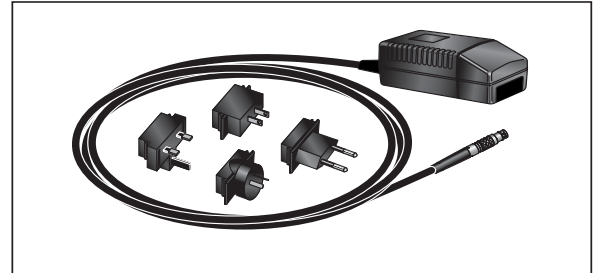

hvh058.eps

Figure 1-3. AC Adapter

When the ac adapter is connected, the camera is automatically supplied by the ac adapter and no longer by the rechargeable battery. However, the rechargeable battery is not charged at the same time.

Operation with Breakout Box

Using the breakout box will expand the connection options of the thermal imager, see Table 1-7. The interfaces 2 x analog output, 2 x trigger E/A, PAL/NTSC-FBAS, as well as the digital RS232 interface are accessible via the breakout box.

⚠ Caution

Follow the specified steps on how to establish the required connections.

1. Connect the thermography camera to the breakout box. For this, the 14-pin connecting cable of the breakout box must be used. It is connected to the right-hand side 14-pin LEMO socket on the backside of the thermal imager.
2. Connect the breakout box to the COM interface of the host computer with a commercially available cable.
3. Connect the supplied ac adapter to the breakout box.
4. Push the Power button  on the backside of the camera to turn on the thermography system.

Table 1-7. Breakout Box



Item	Description
①	Connecting cable for thermal imager
②	14-pin LEMO socket for ac adapter
③	Terminal strip
④	Trigger T1, T2 (configurable)
⑤	BNC video port (PAL/NTSC-FBAS)
⑥	Serial interface (RS232)

hvh061.eps

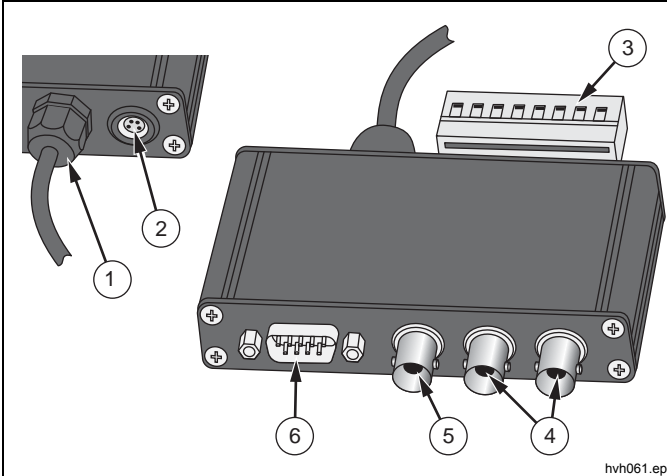
Trigger Function

Triggering uses the Ethernet to affect the 16-bit data transmission. The TTL/CMOS signal is forwarded to the thermal imager (right-hand side socket) using the BNC sockets marked T1 and T2 of the breakout box and from there using the connecting cable with 14-pin LEMO connector.

In order to connect the trigger signal sources to the breakout box, commercially available BNC cables may be used:

- T1 Trigger channel 1 is used by the software.
- T2 Trigger channel 2 is reserved for the SDK and further specific applications.

Note

The voltage level of the trigger signals from the thermal imager to the input and the output is 5 V TTL/CMOS.

The thermal imager reacts to a low-high trigger edge. The trigger event causes simultaneous marking in the heater of the following frame (IR image). Within the software, this mark is analyzed by the IRBGRAB.DLL implemented there and results in the corresponding data being saved. The minimum width of a trigger pulse should be 10 μ s in order to allow an unambiguous assignment to the current frame.

SyncOut

The frame rate of the thermal imager cannot be controlled from the outside. In order to synchronize other cameras and processes, and for active thermography applications, the Framesync signal of the thermal imager can be generated, however. The generation of the Framesync signal is activated by the corresponding software command. In the event of a low-high edge, the Framesync signal starts simultaneously with the recording of the first image line. The synchronization pulse has a length of approx. 600 μ s.

The trigger channels are configured using the application software online.

Chapter 2

Elements of the User Interface

Title	Page
Introduction	2-3
Button Functions	2-5
Image Elements	2-7
Setting the Temperature Scale.....	2-9
Focus	2-10
LaserSharp® Auto Focus.....	2-10
Permanent LaserSharp® Auto Focus	2-10
EverSharp Multifocal Recording.....	2-10
Saving	2-11
Saving with Check.....	2-12
Quick Saving	2-12

Introduction

The thermal imager has these controls (see Table 2-1):

- keyboard on the right top camera side (focus rocker switch ◀▶, buttons **S**, **T**, **A**, as well as **1** and **2**)
- keyboard on the right of the backside (ESC button **C** and power button **⏻**)
- multi-function joystick **⬆** with Enter function on the right of the backside
- multi-function button **M** on the top of the front camera handle

Note

All buttons can be used for multiple functions triggered either by:

- *half or full pressing:* **S** and **M** and/or
- *short or long pressing:* **A**, **T**, **1** and **2**.

Within the framework of the description of the camera functions, the letter **L** is attached to the symbol of the respective function button if a button must be pushed for a longer period of time.

Example:

Short press on the **T** button: **T**



Long press on the **T** button: **T**L

Short press on the **A** button: **A**

Long press on the **A** button: **A**L

The functions of the buttons **M**, **A**, **T**, **1** and **2** can be changed by setting the buttons (see *Chapter 3, Menus*). Furthermore, the function of the buttons depends on the current mode of operation and, depending on the aforementioned, is displayed in the menu and the help line at the lower margin of the screen.

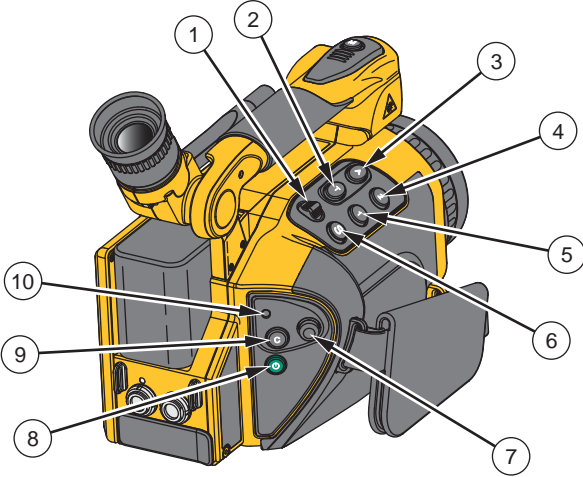
Table 2-1. Control Locations

	Item	Description
	①	Focus rocker switch with autofocus ◀▶
	②	Temperature T
	③	Auto A
	④	Multifunction 2 2
	⑤	Multifunction 1 1
	⑥	Save S
	⑦	Joystick 
	⑧	Power 
	⑨	Escape C
	⑩	Power LED

hvh015.eps

Button Functions

The functions are assigned (factory defaults) to the function buttons in such a way that functions required frequently can be executed quickly:

Table 2-2. Shortcuts

Button	Type	Function	Explanation
A	short	Auto Mode (Span)	Automatic adaptation temperature scale
	long	NUC	Non-uniformity correction (compensation)
C	long	Menu Level/Range	For manually setting Level/Range
T	short	Spot ON/OFF	If no AOI was created yet → create spot 1
	long	Spot editor	AOI settings
1	short	Laser ON/OFF	Mark and laser distance meter
	long	Max/Min ON/OFF	Global max/min measurement On/Off
2	short	IR ↔ Visual Light Image	Switch-over image mode
	long	Color ↔ SW	For manually setting Max/Min
M	halfway	LED ON/OFF	Photo lamp
	complete	FREEZE	Subsequent image saving possible using S

The function of the save button **S** when saving images is defined in the *Saving Format Submenu* (see *Chapter 3, Menus*).

The save button **S** can be used in order to immediately accept inputs in many menus. This function shortens the navigation and is activated by the factory, but can also be deactivated (see *Chapter 3, Menus*).

The multi-function joystick **⬆️⬇️⬅️⬆️** can be used to navigate and to select functions, to input using the arrow buttons **↑**, **↓**, **←**, **→**, as well as the function **⬆️⬇️⬅️⬆️** (Enter, push the center).

The focus rocker switch **⬅️➡️** can be used in order to manually focus the infrared image:
← change the focus to longer distance → push left
→ change the focus to shorter distance → push right

or to focus automatically:
⬅️➡️ center function of the focus rocker switch.

The Power button **⏻** is used to turn on the thermal imager. Initially, the status LED on the left-hand side above the **⏻** button will start to flash green and the logo of the camera manufacturer is displayed on the camera display. Upon successful system initialization, the status LED will be illuminated permanently green: the thermal imager is now ready to operate. The system start takes about 30 seconds.



hvh066.jpg

Use the power button **⏻** to turn off the thermal imager.

Image Elements

The image elements have the following functions:

Table 2-3. Image Elements

Image Element	Location	Function
Image	Central display area	Display of the current thermal image, visual light image or of a superimposition of both images, display of saved images
Menu	Left from screen area	Adjustment of the camera functions
Help	Lower screen area, left	Display of the current function
Logo	Lower right corner of the screen	Manufacturer's logo
Date, time	Screen center, upper edge of screen	Date and system time
Camera status	Upper right corner of the screen	Current mode of operation
Temperature scale	Right edge of the screen	Assignment of the colors/shades of gray of the image to the temperature range shown
Measured values table	Left screen area	Display of temperature values

Table 2-2. Image Elements (cont.)

<p>Status symbols</p>	<p>Lower screen area, right</p>	<p>Status indicators for:</p> <ul style="list-style-type: none"> • power supply (ac adapter/status rechargeable battery) • SDHC card • laser distance meter/laser pointer • photo LED <p>GPS reception</p>
<p>Information</p>	<p>Screen area bottom left 1st line 2nd line and 3rd line</p>	<p>Information indicators for</p> <ul style="list-style-type: none"> • GPS data: latitude, longitude, satellites • (global) emissivity eps • ambient temperature Te • path temperature Tp • relative humidity rH • distance Dist • calibration range Cal • lens information FOV • zoom z

In addition to the current temperature scene in false color representation, different image elements are used in order to show information about the camera status and operation. The displayed image elements can be changed and adapted with the individual requirements in the "Image" menu using the "Elements" menu item (see *Chapter 3, Menus*).

Along with the (normally always displayed) main image elements, further system messages are displayed depending on the current function, providing information about the system status and intended to facilitate operation, for example, autofocus, temperature indicators for isotherms, temperature alarm indicators, messages regarding critical status of the rechargeable battery, and "Please wait...".

The thermal imager can be operated both by the control directly attached to the camera and, depending on the equipment, remotely using GigE or RS232.

Setting the Temperature Scale

At system start (pushing the power button ) , the camera is in Live mode. This mode is shown on the right-hand side at the top of the screen: **Live**. In Live mode, the current scene is shown as a false color representation of the temperature distribution (IR image), as a video image (visible, visible light image), or as a superimposition of IR and visible light image (IR Fusion[®] technology). The temperature scale of the false color representation of the IR image can be set automatically or manually.

To automatically adapt the temperature scale to the current scene, push the **A** button. Factory setting for **A** button sets the scale to the highest (= upper limit) and lowest temperature (= lower limit) of the current scene. If the temperature scale was adapted before the focus was changed, the temperature should be re-adapted afterwards.

Observe the calibration range limit of the currently used measuring range. If the temperature of the current scene is outside of the set range, an appropriate calibration range must be selected (see *Chapter 3, Menus*).

The manual setting options for the ideal adjustment of the temperature scale are described in detail in *Chapter 3, Menus*.

Focus

Carefully setting the focus is important to achieve a precise temperature measurement with the thermography system.

Use the focus rocker switch ◀▶ to:

- Manual focus
 - o push the left side of the focus rocker switch in order to change the focus to longer distances and/or
 - o push the right side of the focus rocker switch in order to change the focus to shorter distances.
- Auto focus
 - o push the ◀▶ center function of the focus rocker switch.

Note

The zoom setting can be used to manually focus for measurements of small objects.

It is not necessary to change the visible light image focus.

LaserSharp® Auto Focus

To setup:

1. Go to **Laser** menu and select **LaserSharp Auto Focus**.
2. Push the center function of the focus rocker switch.

Permanent LaserSharp® Auto Focus

Go to the **Laser** menu and select **LaserSharp Auto Focus**.

Laser will continuously display and will automatically focus when the distance to target changes.

EverSharp Multifocal Recording

1. Go to the “Extras submenu” in the “Settings Menu”.
2. Select “EverSharp” within this menu

Once selected, the camera takes all images in the EverSharp mode.

Note

Images taken with EverSharp will be viewable in SmartView® software. Feature is supported in SmartView® starting in January 2015.

Spot Editor



By pushing the **T** button, a temperature measuring point is created in the center of the image. Pushing the **T** button with the spot turned on will turn off the measuring point.

The spot editor can be started by pushing the **T** button for a long period of time. The editor can be used to define measuring objects with different shapes and properties (Areas of Interest, AOIs), as well as to set the way the measuring objects are displayed. After having defined the AOIs, these regions and their measured values can be activated and deactivated using the **T** button. The particular description of the spot editor's function can be found in *Measurement Definitions* menu starting in *Chapter 3, Menus*.

Saving

Thermography images and photographic pictures are saved to the SC card inserted into the camera. The thermal imager supports commercially available SD and/or SDHC cards up to a capacity of 32GB. Depending on the detector format and the set memory format, up to 25,000 IR images can be saved to one SDHC card this way. Along with individual IR image, thermal image sequences can be saved as digital raw data and video sequences. The particular description of the camera settings for data storage can be found in *Chapter 3, Menus*.



Depending on the equipment, the thermography and video data can be transmitted using the optional interfaces GigE, USB, and WLAN so that transmitted data can also be stored on the used control units.

Before saving to the SD card, check that the SD card inserted into the camera has sufficient memory space available. The free memory space can be displayed in menu "Settings" → "System" → "Info" (see *System Submenu* in *Chapter 3, Menus*). A writable memory card is indicated by means of a blue card symbol  in the lower right area of the field of view. A non-writable or read-only memory card is indicated by means of a grayed-out card symbol .

Saving with Check



To check the image to be recorded before saving it, the Live mode should be stopped:

- Push the **S** button halfway down → the live image will be frozen: **Live** → **Freeze**.
 - The frozen image can initially be "checked" on the display or viewfinder.
 - If the image is not to be saved, push the **C** button: **Freeze** → **Live**.
 - Pushing the **S** button halfway down again in **Freeze** mode is ignored.
- Push the **S** button completely → the image is saved.

The process of writing the data is indicated by the changing color of the map symbol (in the line below the image, right-hand side):  → . Upon saving, the camera control automatically re-activates the Live mode: **Freeze** → **Live**.

Quick Saving

Using the thermal imager, you can immediately save images in the Live mode or directly from the motion:

- Immediately push the **S** button completely → image is saved immediately:  → , the camera control then automatically re-activates the Live mode: **Freeze** → **Live**.

Note

*Deviating from the factory setting described in Table 2-3, the **S** button can be used to trigger further functions such as shutter activation, autofocus, visible light image-LED, laser distance meter/laser pointer before saving the image.*

Chapter 3

Display Menus

Title	Page
Introduction	3-3
Image Submenu	3-4
Manual Submenu	3-5
Mode Submenu	3-7
Zoom Submenu	3-10
Palette Submenu	3-11
Elements Submenu	3-14
Isotherms Submenu	3-15
Filter Mode Submenu	3-17
Format (Subwindowing) Submenu	3-17
File Menu	3-17
Directory Structure	3-18
Load Submenu	3-18
Save Submenu	3-21
IR Photonotes Submenu	3-24
Format SD Submenu	3-25
Saving Format Submenu	3-25

Measure Menu.....	3-27
Spot Temperature Submenu	3-27
Measurement Definitions Submenu.....	3-28
Correction Submenu.....	3-32
GPS Submenu.....	3-36
Laser Submenu	3-36
Settings Menu.....	3-37
Calibration Submenu	3-37
Extras Submenu	3-38
Automatic Submenu	3-39
Compensation Submenu	3-40
Buttons Submenu	3-41
Digital Alarm Output Submenu	3-44
Configuration Submenu	3-45
System Menu.....	3-47
Display Submenu	3-48
Regional Submenu	3-49
Date and Time Submenu.....	3-49
Menu Layout Submenu	3-50
Menu Control Submenu.....	3-51
Info Submenu	3-52

Introduction

The main menu is designed to select and set the different functions of the thermal imager. It is arranged to the left of the image section.

The menu can be navigated using the joystick , settings are accepted using the joystick center button (Enter). The four main menus are located on the upper margin of the menu and can be selected by means of the corresponding symbols of the tabs:

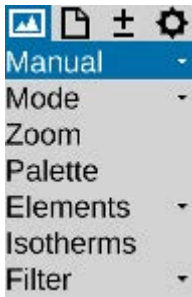

hvh078.jpg

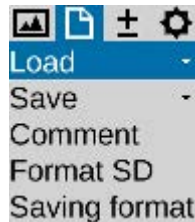



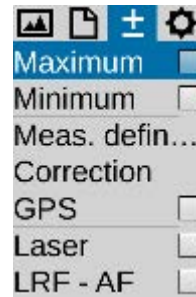





hvh079.jpg



hvh080.jpg



hvh081.jpg

Within the menus, the joystick  is used to navigate to the top  and/or to be bottom . The main menu can be switched using the buttons  and . Depending on the settings for "Menu control" made in the "Settings" menu in the "System" menu item at the "Menu control" function (see *System Menu* on page 3-47), the lower menu in each case can be accessed directly by pushing  from the very top and/or the upper menu in each case can be accessed directly by pushing  from the very bottom and/or "Image" can be selected directly by  from "Settings" and/or vice versa by .





Submenus can be opened by pushing the Enter button  on the respective menu item, for example, **Manual**  to open the submenu for manual temperature range setting. Changes performed to setting dialogs can be accepted using the joystick Enter button or  or can be discarded using .

Image Submenu

The Image menu constitutes a summary of the settings relevant for the representation of the thermal image.

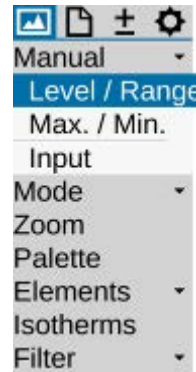

hvh083.jpg

Manual Submenu

The option of manually setting the temperature scale is a central function of each thermography camera. Therefore, this function is arranged in a quickly accessible menu in the left top area of the main menu of the thermal imager. Set the temperature scale to allow for a visual allocation of temperatures to the displayed scene by means of the false color representation of the thermal image. Maximum and minimum values of the currently set temperature range are indicated by the corresponding figures above and below the arranged color palette.

Different modes can be selected for manually setting the temperature range in the "Manual" menu item:

- Level/Range
- Max./Min.
- Input



hvh084.jpg

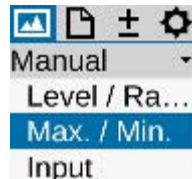

hvh085.jpg

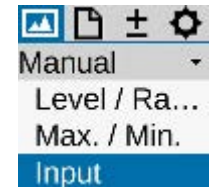

hvh086.jpg

TiX640, TiX660, TiX1000

Users Manual

Depending on the selected input variant, the joystick  can be used to set the temperature level and the temperature range (Level/Range) or the upper and lower limits (Max/Min) and the values can be input numerically as well. In this, the respective joystick and button

functions are displayed to the left of the thermal image instead of the menu after opening the function. The respective input dialog for numerical input is displayed in the center of the field of view:

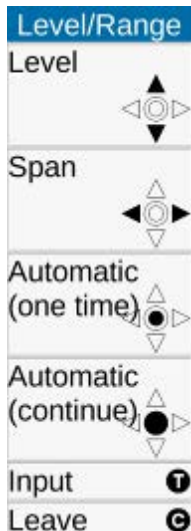

hvh087.jpg

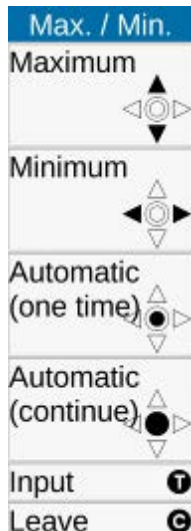

hvh088.jpg



hvh089.jpg



hvh090.jpg

Along with the option of manually setting the temperature scale, the temperature scale can be set once by pushing the joystick Enter button shortly, or permanently active, by pushing the joystick Enter button longer. The permanent setting of the temperature range, known as Auto Mode (Span), is indicated by **Auto** in the right top corner of the screen. The Auto Mode (Span) is deactivated by any manual change to the temperature scale or non-recurrent triggering of the Auto Mode (Span) function.

Note

*The setting menus Level/Range and Maximum/Minimum can be accessed directly by the button functions **Ⓞ** Long and **Ⓜ** Long, as set from the factory.*

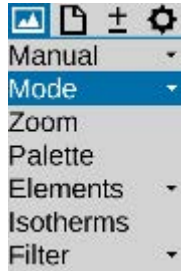

hvh092.jpg

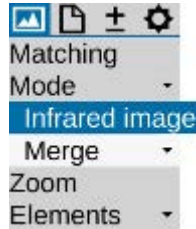

hvh093.jpg

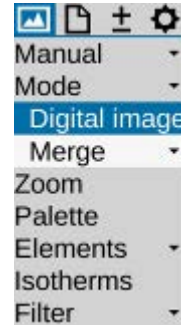

hvh094.jpg

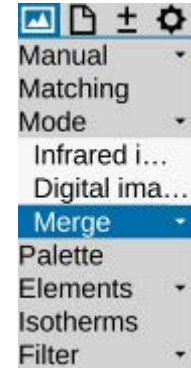

hvh095.jpg

Mode Submenu

In Live mode, the thermal imager displays thermal images (infrared images), video images (Digital images), or the superimposition of both (IR Fusion® technology). The options can be selected in the "Mode" menu, which must be dropped down for this. If an infrared image is currently displayed, you can switch to Digital image or IR Fusion®. From the Digital image mode you can switch to infrared image or IR Fusion®. From the IR Fusion® mode you can switch to infrared image or Digital image. The different representation variants in the IR Fusion® mode can be set after the submenu dropped down.

Infrared Image Mode

In the Infrared Image mode, the thermal image is shown in false color representation. Depending on the equipment, the live image displays (1024 x 768) or (640 x 480) IR pixels with the digital zoom switched off. While saving, the geometric resolution can be increased to (2048 x 1536) and/or (1280 x 960) IR pixels by means of the optomechanic MicroScan functions, SuperResolution and Dynamic SuperResolution. These modes must be activated in the "Settings" menu using the "Extras" menu item.

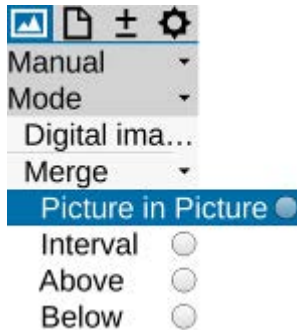

hvh096.jpg

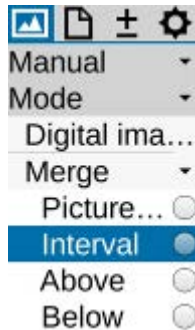

hvh097.jpg

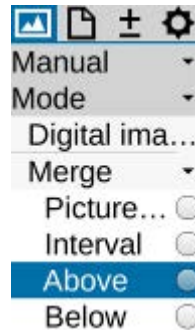

hvh098.jpg



hvh099.jpg

Digital image mode

In the Digital image mode, the camera-internal digital photo channel is operated in video mode and displayed with a geometric resolution of (1024 x 720) pixels. The option of saving photos with the available pixel resolution of (3264 x 2448) pixels (8 megapixels) is set in the "File" menu using the "Saving format" menu item (see *Saving Format Submenu* on page 3-25).

IR Fusion® Technology

In the IR Fusion® mode, 4 different modes can be selected. To select these options, the IR Fusion® submenu must be dropped down:

IR Fusion[®] with Autoblend[®] Technology (Picture-in-Picture)

In the Picture-in-Picture mode, a part of the infrared image is superimposed over the digital image, regardless of the temperature of the current scene. The size and the position of the displayed infrared section can be changed by using the joystick : higher using ↑, lower using ↓, wider using → and narrower using ←. The joystick Enter button can be used to toggle between the options Resize and Move. The merged image section can be moved to the top ↑, to the bottom ↓, to the right → and to the left ←

In the IR Fusion[®] with Autoblend[®] Technology mode, all temperatures of the current scene are displayed in the selected partial area in accordance with the set temperature scale. Cross-fading refers to the surface area. In the color alarm, high alarm, and low alarm modes, the displayed temperature range can be restricted: cross-fading depends on the temperature in the entire infrared image.

Color Alarm

In the Color Alarm mode, a (partial) temperature interval is defined within the set temperature range. Partial areas, the temperatures of which are within this interval, are displayed as an infrared image in false color representation. Partial areas, the temperatures of which are outside of this interval, are displayed as a digital image (visible light image).

Upper and lower limits of the superimposed temperature range are displayed to the left of the palette on top and at the bottom and can be changed by using the joystick :

- ↑ increase the temperature level of the IR Fusion[®] interval
- ↓ decrease the temperature level of the IR Fusion[®] interval
- increase the temperature interval
- ← decrease the temperature interval

High Alarm, Low Alarm

Just as in Interval, a (partial) temperature interval is defined in the High Alarm and Low Alarm modes, not only the upper and/or lower limits are defined for the partial areas at this point. For the Above option, all areas above, and for the Below option, all areas below the adjustable temperature limit are displayed. The upper limit for the Above option corresponds to the upper limit of the set total range. The lower limit for the Below option corresponds to the lower limit of the total range.

Continual Blend

In all IR Fusion[®] modes, the transparency of the continual blend area can be selected. The degree of continual blend (Alpha blending) can be set in the "Blending" submenu in an infinitely variable manner.

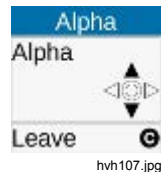

Zoom Submenu

Depending on the equipment, the thermal imager supports digital magnification of the infrared image and the Digital image (visible light image) up to 32-fold. The setting is made in the "Setting" menu using the "Zoom" menu item and is applicable to the currently displayed image in each case (infrared image or visible light image). A set magnification is indicated as the corresponding status symbol  to the right below the image. If the image was enlarged digitally, the enlarged section of the image (initially located in the center of the image) can be moved. By shortly pushing the joystick Enter button, you can toggle between the options enlargement (zoom) and Move. The function active in each case is indicated by blackened joystick symbols in the upper part of the menu. The zoom level and the position of the enlarged section of the image are indicated in the left bottom area of the total image. After the enlarged section of the image has been moved from the center of the image, the joystick Enter button must be pushed longer to center the section of the image.

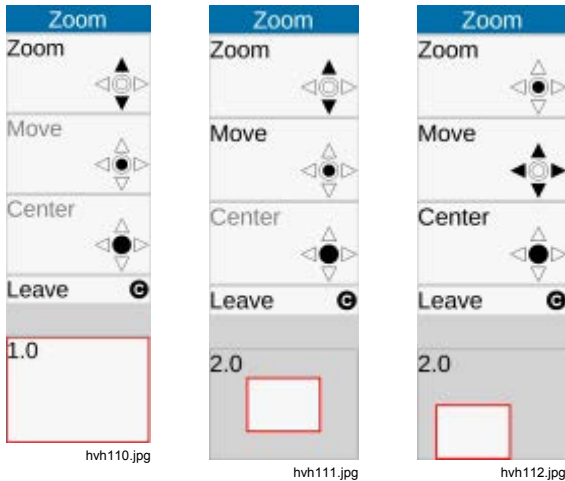

Regardless of any set digital magnification of the infrared or visible light images, the total image is always saved when saving digital raw data in the is3 format.















Palette Submenu

The current allocation of the individual colors/shades of gray of the false color representation to the corresponding temperatures is performed by using the palette shown on the right-hand side margin of the screen. In this, the maximum value of the image area above and its minimum value below the palette serve the purpose of orientation for the temperature level.

The "Image" → "Palette" menu item is used to open a dialog for selecting and setting predefined palettes, see Table 3-1.

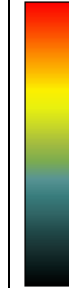

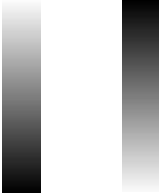
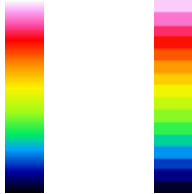
Table 3-1. Palettes

 <p>Rainbow</p>	 <p>Grayscale</p>	 <p>Ironbow</p>	 <p>Blue Red</p>	 <p>Marked</p>	 <p>High Contrast</p>	 <p>Steps</p>	 <p>Black Red</p>	 <p>Hot Metal</p>	 <p>Menthol</p>	 <p>Sepia</p>	 <p>Grayscale/ Rainbow</p>
 <p>Grayscale palette (left) and inverted representation (right)</p>				 <p>Palette containing 256 colors (left) and 16 colors (right)</p>				 <p>Grayscale/Rainbow palette with temperature-linear (left) and Ultra Contrast representation</p>			

The "Inverse" function can be used to invert the current palette. For example, if the grayscale palette is set, the low temperatures are indicated in darker colors when compared to the higher temperatures by default. If the "Inverse" function is activated for the grayscale palette, the representation is inverted: The low temperatures are now indicated in lighter colors and the higher temperatures are now indicated in darker colors.

The "16 steps" function can be used to set the representation of the palette from 256 color steps to 16 steps. Accordingly, only 16 temperature levels can be indicated instead of 256, which is why differentiations exceeding the 16 steps are no longer displayed on the screen. Therefore, the scene is "summarized" to 16 "classes" of the same temperature levels.

The "Logarithmic" function can be used to toggle the representation of the temperature values between a linear and a logarithmic curve. By default, a linear curve is selected to represent the temperatures. By activating this function, it is possible to use a more differentiated resolution for the low temperature range when compared to the high temperature range. The effects of the logarithmic representation are illustrated in Table 3-1.

On the left-hand side, the palette with temperature-linear representation is shown. On the right-hand side, the palette with logarithmic representation of the temperature is shown. The logarithmic representation is recommended for scenes with highly dynamic temperatures where, regardless of the huge difference between maximum and minimum temperature values, a differentiated representation is important in the lower temperature range. For instance, a printed circuit board with a "hot" component, in which along with T_{Max} , temperature differences in the lower area of the image are also interesting.

Whether the functions "Inverse", "16 steps", or "Logarithmic" are activated is indicated by a checkmark on the respective menu item. It is also possible to combine the three variants with each other.

Elements Submenu

The "Elements" menu item can be used to individually adapt the user interface by selecting the individual image elements. The menu comprises the two submenus "Elements" and "Hide". The "Elements" submenu can be used to open the "Image elements" dialog to individually select the image elements. The selection is made by setting the corresponding checkmark using the Enter button of the joystick. The dialog can also be navigated with the joystick . When selecting the "Hide" menu item, all image elements of the graphical user interface are hidden at once. If this function is activated, a checkmark will be shown on the right side of the "Hide" menu item.

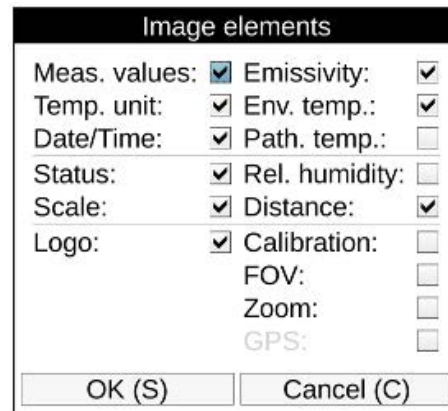
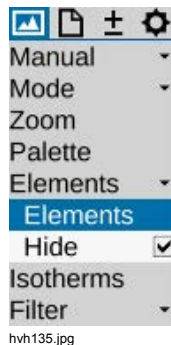

Isotherms Submenu

In the "Image" menu using the "Isotherms" menu item, the isotherms editor can be started and/or settings for already created isotherms can be made, or all isotherms can be shown or hidden simultaneously. The "Isotherms" function is used to show all image areas characterized by

the same temperature (in a defined temperature interval) with the same representation color and/or shade of gray. With the help of the isotherms editor, it is possible to create isotherms for differently sized temperature intervals. The temperature ranges are identified with different colors. The thermal imager supports a maximum of nine different isotherms.

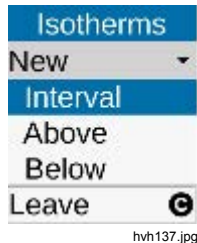

hvh137.jpg



hvh138.jpg



hvh139.jpg

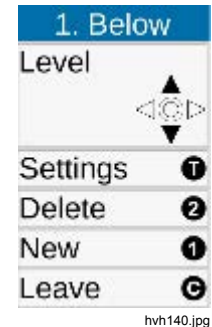

hvh140.jpg

TiX640, TiX660, TiX1000

Users Manual

Along with the definition of *Intervals* for isotherms, identifying temperatures over or under a certain limit is possible. At this point, temperatures above ("Above") and/or below ("Below") the limit value are identified with the same color. To define the isotherms "Above" and/or "Below", entering a limit value is required in each case, while two temperatures must be defined for "Interval". The temperature limits are set using the joystick and the setting is indicated in the selected mode to the left of the image.

Along with making the settings using the joystick, the limit values for each isotherm can be specified numerically in a

dialog. At this point, changing the color of the isotherm is also possible. The 15 "special colors" designed for the isotherms were selected in such a way that they can still be conceived as isotherm even when using a color palette. Regardless of the aforementioned and for the purposes of unambiguous allocation of the temperatures when using color isotherms, it is recommendable to use a grayscale palette and/or to use a color palette in the event of black, white, or gray isotherms.

The following colors can be selected for the isotherms:

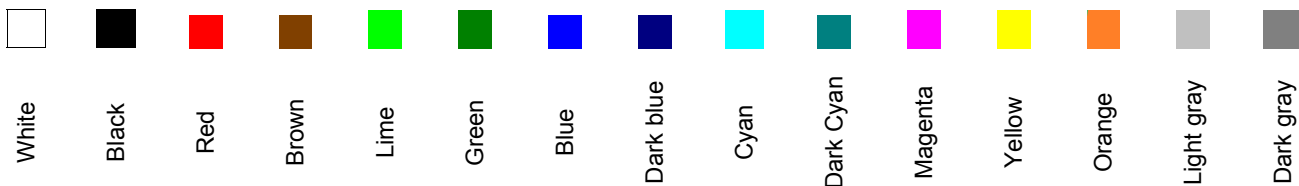

Filter Mode Submenu

With the Filter Mode menu item, a filter can be set for the representation of the thermal images. A first-order digital low-pass filter is used as a filter.



The submenu can be used to select from the four filter stages: "Off", "Weak", "Medium", and "Strong". Filtering reduces the noise in the image, significantly improving the image quality for scenes with low temperature gradient. The filter should be set to "Off" or "Weak" for objects in motion or for the documentation of quick temperature changes.

Format (Subwindowing) Submenu

Optionally, partial image modes can be selected for the thermal imager to increase the available frame rate. These can only be selected using the "Format" menu item. In the event of partial images, the number of transmitted pixels will be reduced. This function requires specific calibration of the camera for the corresponding partial modes. Due to the changed mode of operation of the detector in partial image mode (deviating cycle regime, shorter integration time), the thermal resolution and the measurement accuracy may deviate from the values applicable to standard operation. Depending on the model, a different number of partial image formats are available.

Note

This feature is an option. Fluke recommends that you order the feature at the time of purchase. Otherwise, you must return the imager to the manufacturer for installation.

File Menu

Those thermal imager functions that can be used to load IR images and photos, to make settings for contents and format individual images and image sequences to be saved are summarized in the "File" menu.

Directory Structure

Whenever it saves data to the SDHC card, the thermal imager initially automatically creates sub-directories, the names of which make sure that the required files can be found quickly even in the event of large amounts of data. Files are always saved to a sub-directory. The name of the sub-directory is generated taking the current date as a basis, for example on June 22, 2012 the first directory would be created with the name 120622AA. The maximum number of files that can be saved to a directory is limited to 100 in order to avoid the tedious search through long lists. Within one directory, the files are numbered consecutively, but can always be allocated to the respective directory on the basis of their basic name (2 letters + month + day, e.g. AA0622xx). Once a sub-directory is full (e.g. at file AA062299.is3), the next file will be saved to the directory 070622AB with the file name AB062200. Therefore, the filenames are numerated consecutively starting with 00 and up to 99 and, as opposed to the directory, are not equipped with any identification of the year in their names. This way, if the automatically generated directories and file names are completely exhausted, a maximum number of 26 x 26 x

100 = 67,600 files will have been saved to 676 directories.

Please note that a new sub-directory is created after every restart of the thermography system and subsequent data storage, as well as for every series measurement, regardless of the contents of directories already created beforehand. If additional data (visible light image, audio, screenshot) is saved as additional files, the number of possible thermal image files in one directory is reduced accordingly.

Load Submenu

The "Load" menu item can be used to load IR images and photos already saved to the SDHC card and to display these on the display and/or the viewfinder. The images to be displayed can be selected using the submenu items "Single file" or "Gallery".

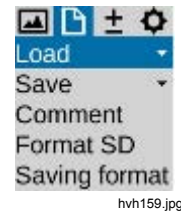

If the "Single file" submenu item is selected, the sub-directories and their contents contained on the SDHC card are initially displayed as lists. To navigate between directories and files, use . To navigate within the

directory lists and file lists, use the joystick Enter button. A directory can be opened using the joystick Enter button or navigating to the right. The file list of a sub-directory can be closed by navigating to the left. A file, in turn, is selected by using the joystick Enter button. On the right top, next to the file list, the preview image of the highlighted thermal image displays. On the right bottom, a photo displays (from is3 or jpg file). If the thermal image saved to the is3 contains further data, this is indicated by the following letters in the left upper corner of the preview image:

- V: photo, digital image (Visible)
- A: audio file
- S: image sequence, serial file

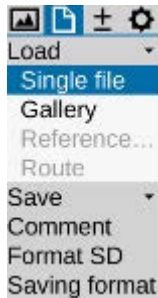

hvh163.jpg

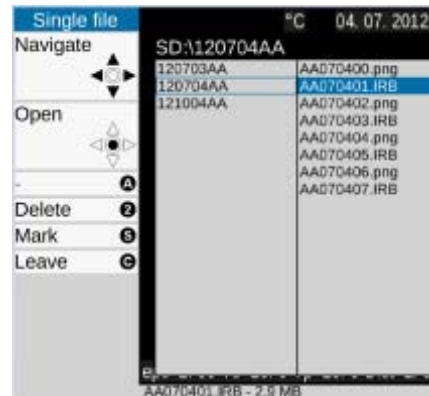

hvh164.jpg

The **S** button can be used to highlight files and directories. The **2** button can be used to delete files and directories. To avoid any accidental loss of data, the process of deleting files must be confirmed in a dialog:

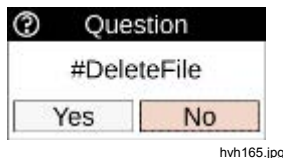

The file selected from the file list (highlighted blue) is displayed (large) by using the joystick Enter button. When the image is shown in its enlarged size, the right/left buttons **◀▶** can be used to navigate to the next and/or previous image in the file list. If a photo is saved in the is3 format, this photo is shown as a miniature version to the left of the thermal image. The **S** button can be used to toggle the display between thermal image and photo. A voice annotation contained in the is3 file can be played by using the **A** button. The loaded image can be deleted by using the **2** button. The display can be closed by using the **C** button.

The "Load Gallery" submenu function can be used to quickly find files from preview images.

After the function is started, the directories are shown as index cards, the contents of which can be opened and then displayed by preview images by using the joystick Enter button in each case. Within the gallery, the joystick  can be used for navigation purposes. In the event of more than 20 directories and/or files, it is possible to scroll out of the display area. In analogy to the single image display, the joystick Enter button must be pushed on the preview image to show the file in its enlarged size. The functions available at this point correspond to the functions of the single image display.

Save Submenu

Along with single image saving, the save button  of the thermal imager can be used to save the following, depending on the equipment:

- thermal image sequences with the maximum frame rate (real-time saving)
→ "Real time",
- series of single images (thermal image and photo)
→ "Autocapture"
- video sequences (thermal image, digital image, or IR Fusion[®]) as AVI
→ "Video".

The "Saving format" menu item can be used to set the data and formats to be saved (see *Saving Format Submenu* on page 3-25).

Real-time saving

The maximum writing speed possible for real-time saving depends on the detector and the geometric resolution, as well as on the properties of the used SDHC card.

Note

In order to achieve the maximum real-time saving frequency, we recommend using transcend-extreme-speed SDHC cards. Please check before starting real-time saving that sufficient memory space is available on the used SDHC card.

Real-time saving is started and terminated (immediately) by pushing the joystick Enter button in the "Real time" submenu. The following displays are shown with the real-time saving function executing (additionally to the live image).

- activated real-time saving function by checkmark in the menu
- red dot for currently executed saving, as well as the time elapsed since the start on the right side below the palette
- SDHC card symbol in the symbol line on the right side below the thermal image: yellow (permanent write access)

During real-time saving, only thermal images are stored in the is3 format. This way, it is possible to subsequently edit and correct the digital data of the sequence using the analysis software. Precise temporal allocation of the data is ensured by consecutive numbering of the single images within the sequence and by saving time stamps in the header.

Note

When (geometrically) allocating the thermal image sequence to a photo of the scene, it is recommendable to install the thermal imager on a tripod in a stationary manner and to save a photo before or after real-time saving in IR Fusion® mode.

Video saving

If the saved data of a serial measurement does not require any radiometric editing or if displaying the temperature by means of shown measuring objects and/or allocating the temperatures using the false color representation is sufficient, non-radiometric video can be performed (as an alternative to real-time saving of the digital raw data).

In this case, the currently displayed image area, including all selected image elements (for the setting, see *Elements Submenu* on page 3-14) are saved as a video sequence (AVI file) and can be displayed with generally available player software (media player). The menu (to the left of the image), as well as the help and status symbol lines (below the image) are not saved in the video. In analogy to real-time saving, non-radiometric video can be started and/or deactivated (immediately) by pushing the joystick Enter button in the "Video" submenu.

If the thermal imager is to be used as a "classic video camera" for real images ("visible"), the image mode must be set to "Digital image" in the "Settings" menu before starting the video recording (see *Mode Submenu* on page 3-7). It is furthermore possible to record videos in the "IR Fusion®" image mode upon corresponding previous selection. Since, taking the saved video data as a basis, no subsequent temperature correction for changed parameters (emissivity, ambient temperature, transmission, path temperature) is possible, these parameters should be set correctly before the recording

procedure begins. Furthermore, possibly required measurement definitions (measuring points or areas) should be defined before starting the measurement. These can also be created or changed during video recording, but they can no longer be changed in the saved video.

Autocapture

The "Autocapture" function is used for serial recording of slower changing temperatures and simultaneously saving thermal image and photo. The data and formats to be saved in turn are defined in the "Saving format" menu item (see page 3-25). The available saving speed is influenced by the settings made at this point, but also depends on the detector format and the properties of the used SDHC card, just like with real-time saving.



To start auto capture, the start time (date, time) and the saving interval and the number of IR images to be saved must be defined initially. As an alternative to "Interval" and "Count", the duration of series saving, otherwise calculated from the values for interval and number of images (Count), can also be defined. Depending on the selected saving format, the minimum time interval is shown. When opening the settings dialog using the joystick Enter button in the "Autocapture" submenu, date and time of the camera clock are accepted as start time. After having accepted all settings and after closing the dialog by clicking OK (or using the **S** button), series saving starts immediately. If a later start time is required or if recording is to be started on a different day, the date and the start time must be changed accordingly. Then, the dialog must also be closed by clicking OK (or using the **S** button) and the activated series measurement is indicated with a red dot below the palette. However, the first image is then only saved at the set point in time so that a value of "0/nnn" is shown below the palette. Series saving ends when the defined number of images is reached and/or the selected duration has elapsed, but can also be stopped by pushing the joystick Enter button in the "Autocapture" submenu. The dialog opening thereafter allows for aborting or continuing the current series measurement:





hvh174.jpg

IR Photonotes Submenu

IR images can be equipped with text annotation with the help of an editor to be opened in the "IR Photonotes[®]" menu item. These comments are saved to the header of the is3 file and are available during analysis using the software.



hvh175.jpg

There is a keyboard for entering alphanumeric characters, whereby this keyboard is shown by pushing the joystick Enter button in the text annotation line. The keyboard can simply be navigated with the joystick . Capital and lower-case letters are switched similarly to a computer keyboard. There is an additional keyboard page for numbers and selected special characters. A maximum of 50 characters can be entered. The number of the current character is indicated on the upper margin of the keyboard. The keyboard input is finished by pushing the  button, and then the input text annotation is accepted by clicking OK and/or by using the  button. The text annotation is also saved when saving the camera configuration (see *Configuration Submenu* on page 3-45).

Format SD Submenu

If all data saved to the SDHC card is to be deleted, this can be done by formatting the card. The corresponding function must be started in the "Format SD" menu item.

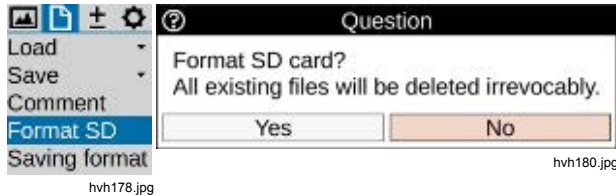

After having clicked the "Format SD" item, a dialog is displayed that must be confirmed by pushing the joystick Enter button to delete all data from the card and to re-format the card. After the card is formatted, all data is deleted irrevocably.

Note

This process cannot be undone.

Saving Format Submenu

Using the "Saving format" menu item, data to be saved in addition to the thermal image and its format can be selected, and furthermore settings to be made in connection with the process of saving can also be selected.

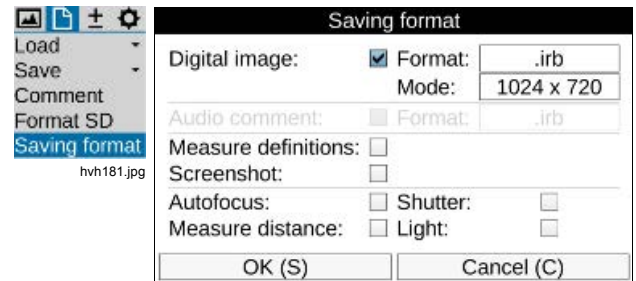

hvh182.jpg

Table 3-2 shows the selectable settings.

Table 3-2. Setting Selections

Setting	Selection	Format
Digital image	Saving the visual image synchronously with the thermal image	.is3—thermal image and photo in one file .jpg—photo in separate file 1,024 x 720 8 MP (3,264 x 2,448)
Voice annotation	Saving the audio files	.is3 —thermal image and audio in one file .wav—audio in separate file
Measurement definitions	Saving measurement definitions	.is3 (no selection possible)
Screenshot	Graphics file screenshot	.png (no selection possible)
Autofocus	Automatic focusing is performed before saving.	NA
Compensation	NUC (Non Uniformity Correction) is performed before saving.	NA
Light	The photo light is switched on before saving.	NA

Measure Menu

The "Measure" menu summarizes all temperature measurement functions.

In order that measured values are displayed, the corresponding setting in the "Image elements" menu must be activated (see *Elements Submenu* on page 3-14).

Spot Temperature Submenu

It is possible to display the (global) temperature maximum and/or temperature minimum within the thermal image by selecting the options "Maximum" and "Minimum". Position and value are consistently updated within the image. Regardless of the palette selected for false color representation, the maximum is red and the minimum is blue.

The spot temperature values are only displayed within the central image area where no other system indications are displayed. These indications are not contained in the thermal images saved digitally, but can be saved when saving the display as screenshot. With the help of the analysis software, it is possible to show the spot temperature values in the entire image area in the event of subsequent editing of the saved thermal images.

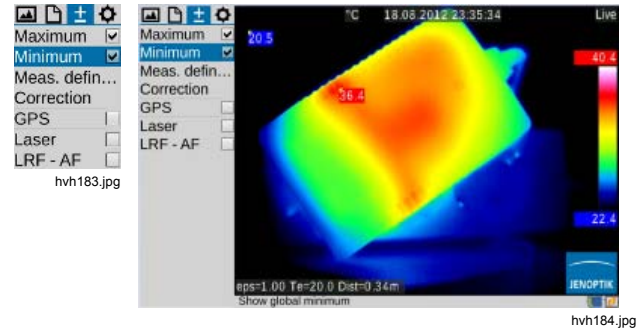

Measurement Definitions Submenu

The "Measurement definitions" menu item can be used to define differently shaped measuring objects (AOI, areas of interest). The thermal imager supports the simultaneous display of 8 different measurement regions (global and 7 partial AOIs), which the local spot temperature values can also be displayed for in each case, along with the average value.

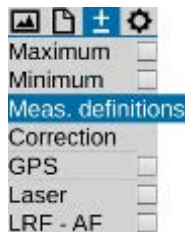

hvh185.jpg

The following shapes of the measuring objects can be selected:

- point (P)
- line (L)
- polygon line (PL)
- rectangle (R)
- ellipse
- polygon (PG)



In order to create a new AOI, you must initially open the "Editor" submenu and select the required format of the measuring object at "New".

Measuring point P

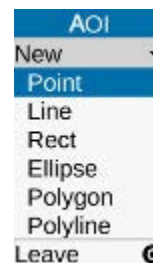
The shape of the AOI and the index of the measuring object active in each case are displayed in the left top of the editor menu.



hvh186.jpg

A measuring point is initially created in the center of the image and can be moved in the image area by using the joystick . The "active" point is identified with a red square in crosshairs as well as an identifier shaded in gray. After the position of the point is reached, exit the editor by pushing the  button: Thereafter, the red mark on the point is no longer visible.

Note

While the measuring objects are being moved, the measured value is not updated.

Line L

The position of the measuring line can be defined by moving one of the terminal points or by synchronously moving both terminal points simultaneously. The respective "active" point and/or both points are also marked in red. If the **1** button is pressed in the editor, the settings dialog for displaying the measured values is shown. For surface areas and lines, the spot temperature can be shown as values and as spot in the image, along with the average value. Furthermore, the identifier of the measuring object can be hidden and the (local) emissivity for the measuring object can be set. A further line can be created by pushing the **1** button without exiting the dialog. The current line can be deleted within the dialog by using the **2** button. The dialog is closed by pushing the **3** button.

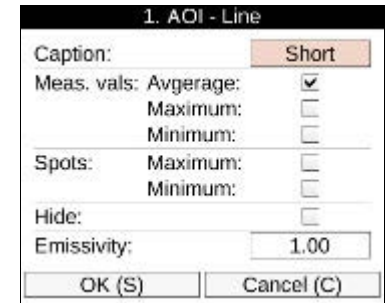
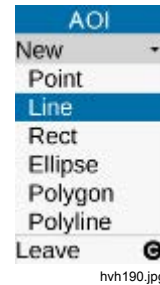

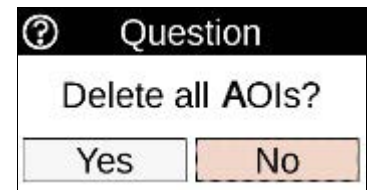

Along with the option of deleting individual AOIs in the respective editor by using the **2** button, all created AOIs can be deleted simultaneously using the corresponding dialog to be confirmed:



Rectangle R

A rectangle selected in the "Editor" submenu in the "New" menu item is initially displayed as a square in the center of the image. Height and width can be changed using the joystick. If the position of the rectangle is to be changed, initially push the joystick Enter button. The rectangle is then highlighted by a red dot in its center and can be moved using the joystick without any changes to its shape.

Ellipse E

The measuring object "Ellipse" selected in the "Editor" submenu in the "New" menu item is initially displayed as a circle in the center of the image. The shape can also be changed by using the joystick  (red mark on line) the position can be changed after pushing the Enter button (red mark in the center of the circle). Another ellipse can be created using the  button.

Polygon PG

The thermal imager supports polygon planes with a maximum of 11 points, the position of which can be defined freely. After having defined the position of a (first) point, a new point is created every time the Enter button is pressed longer, whereby this new point can be moved to its target position. Once more than one point is created, the Enter button can be pressed shortly to toggle between the points in a circulating manner, the position of which can still be changed in this case. When the third point is created, this third point is connected to the starting point defining a plane. The Enter button must be pressed longer to create the next point starting from the active point in a clockwise direction. When all points are highlighted, the polygon plane can be moved without any changes to its shape.

Note

Individual points of a polygon cannot be deleted, but their position can be changed.

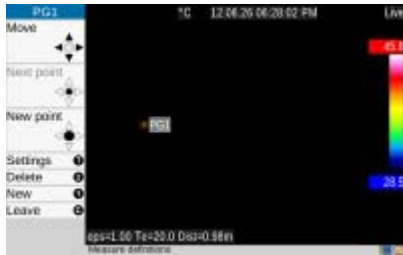

hvh202.jpg

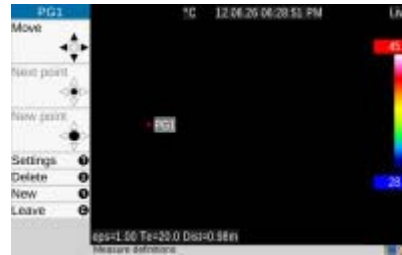

hvh203.jpg



hvh204.jpg



hvh205.jp



hvh206.jp

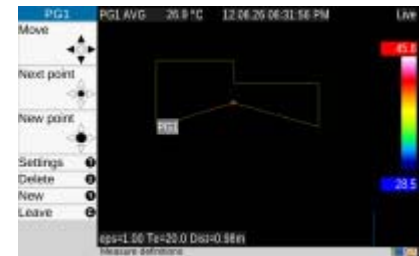

hvh207.jpg

Polyline PL

In analogy to the polygon (plane), a line can also be created with a maximum of 11 support points:

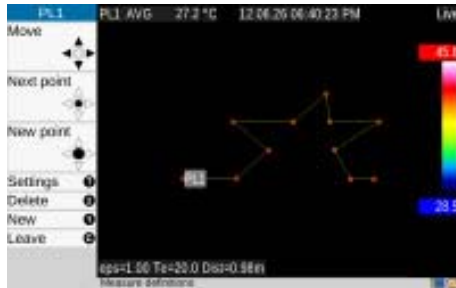

hvh210.jpg

Correction Submenu

The "Correction" menu item can be used to enter the correction parameters emissivity and ambient temperature, as well as path temperature, relative humidity, transmission, and distance in accordance with the current measuring situation. These values are stored with each thermal image and can be displayed and changed, if required, during subsequent editing of the IR images using the analysis software.

Taking into consideration the real measuring conditions, particularly the:

- surface properties of a measuring object and the temperature level of the environment
- transmission of the optical channel, path temperature, and distance

The parameters emissivity and ambient temperature, as well as path temperature, relative humidity, transmission, and distance allow for precise temperature measurement. To properly enter the respective correction parameters,

exact knowledge of the real properties of the measuring object, as well as of the ambient conditions and the measurement setup is required. The correction parameters are accepted globally for the entire image.

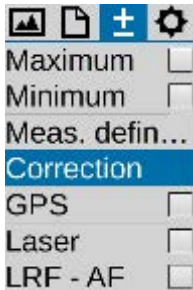

hvh211.jpg

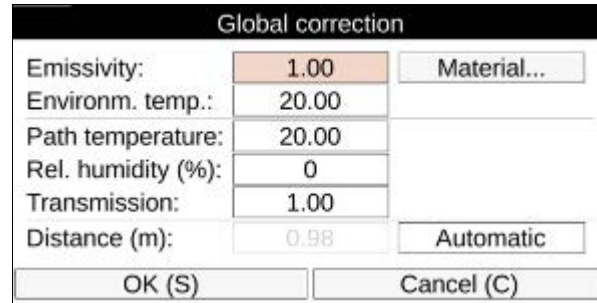

hvh212.jpg

Note

The thermal imager works with a wavelength range of 7.5 to 14 μm . The influence of the atmosphere on the measurement result can be neglected during the majority of the measurements in this range – therefore, the transmission degree is set to 1.00 at the factory. Only in the event of measurements over longer distances (over approx. 100m) and/or through additional window materials, gases, and fog, will the transmission decrease and the path temperature, the relative humidity and/or transmission (dew), and distance should be defined and taken into consideration.

The "Material" option provides an alphabetically sorted collection of the emissivity of different materials, within the framework of which the different surface conditions are partially taken into consideration. When material and condition (status) are selected, the emissivity of the selected material is accepted as global emissivity.

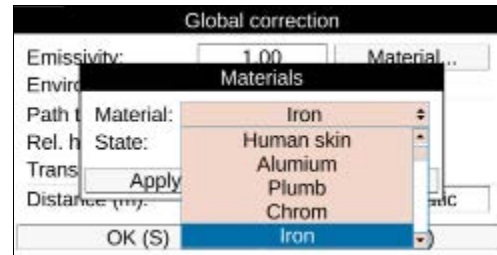

hvh214.jpg

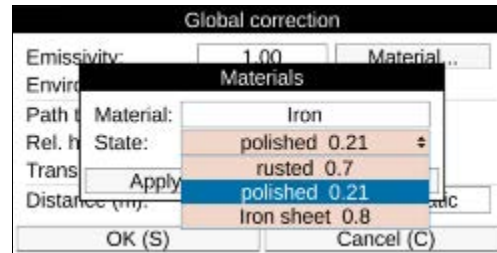

hvh215.jpg

Note

The factory setting of the emissivity is 1.00. Therefore, it is assumed that 100% of the measured radiation is emitted by the measuring object. The measuring object corresponds to the "ideal black-body emitter" and is non-reflective.

If the actual (lower) emissivity of the measuring object is to be taken into consideration, it is absolutely necessary to also determine the ambient temperature ("reflected temperature"), which must also be entered as a correction parameter. The ambient temperature frequently differs from the air temperature or even from the temperature of the camera.

Saving the distance is of particular importance for a number of measuring situations, for example, to be able to also perform geometric measurements within the IR images when analyzing the IR image. However, if "Manual" is the option selected for setting the distance, the distance input with the correction parameters is only saved within the IR image. This is suitable in the event of stationary measurement setups where the distance between camera and measuring object does not change

and can be determined easily. If the "Automatic" option is selected, the distance calculated from the process of adjusting the focus is displayed after each manual or automatic focusing and saved within the thermal image. The laser distance meter integrated into the thermal imager allows for precise distance measurement up to a distance of approx. 70m (see *Laser Submenu* on page 3-36). If the "Automatic" option is selected, the distance measured with the laser distance meter before the image was recorded is saved to the thermal image once the focus setting is changed afterwards.

Note

The distance entered for the correction parameters does not retroact on the focus.

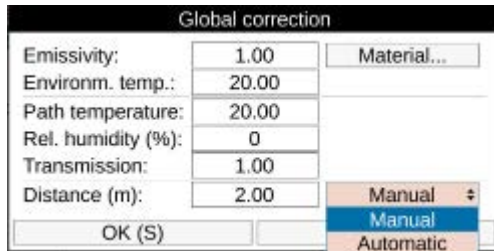

hvh217.jpg

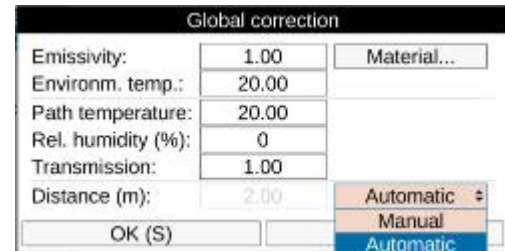

hvh218.jpg

GPS Submenu

The GPS receiver integrated into the thermal imager is activated in the "GPS" menu item. After having switched on the GPS receiver, the function of the GPS receiver is displayed on the right-hand side below the Fluke logo as a symbol. When the GPS receiver is activated, the display of the GPS data (latitude, longitude, satellites) can also be activated in the first information line in the "Image elements" menu (see *Elements Submenu* on page 3-14). When switching off the GPS receiver, the first information line is hidden automatically.



hvh219.jpg

Along with latitude, longitude, and the number of satellites, further GPS information is saved together with the thermal image: height, speed, and bearing.

Note

GPS functions work most effectively when outdoors. Allow up to 20 minutes for the imager to find satellites.

Laser Submenu

The laser distance meter integrated into the thermal imager allows for precise distance measurement depending on the target size, the angle, and the surface properties up to a distance of approx. 70m. Along with the activation in the "Laser" menu item, the laser distance meter can also be activated and deactivated directly by pushing the multi-function button ① (factory setting). When this function is activated, the yellow laser symbol will be displayed in the tool bar below the Fluke logo simultaneously with an acoustic signal (2x beep). The laser pointer, integrated depending on the equipment, is activated analogously.

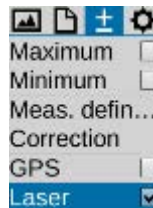

hvh220.jpg



hvh221.jpg

⚠⚠ Warning

To prevent eye damage and personal injury:

- **Do not look into the laser. Do not point laser directly at persons or animals or indirectly off reflective surfaces.**
- **Do not open the Product. The laser beam is dangerous to eyes. Have the Product repaired only through an approved technical site.**
- **Do not locate the laser beam so that it is at eye level when you install the thermography system.**

Settings Menu

The "Settings" menu contains functions for system and hardware setting regarding the thermal imager.



hvh222.jpg

Calibration Submenu

The thermal imager is calibrated to measure temperatures in the range of (-40...1,200) °C. Depending on the equipment, the total measuring range and the individual ranges of your device may deviate from this standard calibration. The actually available ranges can be found in the "Calibration" menu item:

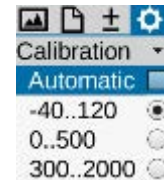

hvh223.jpg

Depending on the object temperature and the measurement assignment, the measuring ranges can be set manually or automatically. However, it must be ensured that the temperature of the current scene does not exceed the set range to avoid overloads within the IR image.

⚠ Caution

The thermal imager is equipped with a highly sensitive uncooled microbolometer detector. The object radiations occurring in thermographic practice do not induce any changes to the detector. However, overloads exceeding a black body radiation of 1,000°C in the measuring ranges 1 and 2, as well as 2,000°C in measuring range 3 may result in irrevocable damages and thus must be avoided.

Note

When using the thermal imager for mobile applications and in the event of a constantly changing scene, we recommend deactivating the automatic measuring range setting (factory setting).

Extras Submenu



The settings that can be selected in the "Extras" menu item activate the following functions:

- Premium A camera-internal compensation (NUC) is performed before each saving.
- Special Saving is performed with activated image filter.
- Super Resolution To save the image, the hardware-based microscan procedure is activated (recording procedure to increase the geometric resolution). The thermal image is scanned optically several times, whereby the geometric resolution from (1,024 x 768) to (2,048 x 1,536) and/or from (640 x 480) to (1,280 x 960) IR pixels is reached by shifting the

pixel allocation by half a pixel width in each case. To use the SuperResolution function, the thermography system must be positioned firmly (tripod) and this function is only suitable for measuring objects with a constant temperature.

- DRE "Dynamic SuperResolution™" – In addition to the activation of the SuperResolution function's hardware, the motions of the microscan mechanics and the measuring objects are used by means of specific software routines to increase the geometric resolution. This way, the function is also suitable for manual operation and moving objects.
- AVG The average value is determined before the image is saved.
- TBV A specific filter is used to save the image.
- EverSharp The camera will take all images using EverSharp mode.

Note

Images taken with EverSharp will be viewable in SmartView® software. Feature is supported in SmartView® starting in January 2015.

Automatic Submenu



The "Automatic" menu item can be used to select different variants for the automatic adaptation of the shown temperature range to the current scene. The automatic representation ("Off") activated by default can be substituted by the following variants:

- Level The temperature level of the representation range follows the global average value of the temperature. The width (range) of the set temperature range remains constant.
- Span "Auto Mode (Span)": with its upper and lower limits, the set representation range follows the maximum and/or minimum temperature values of the current scene. This function can also be activated by pushing the Enter

button in the setting menus
Level/Range and Max/Min longer (see
Manual Submenu on page 3-5).

- Minimum With its lower limit, the set representation range follows the minimum temperature value of the current scene. The upper limit of the shown temperature range remains constant.
- Maximum With its upper limit, the set representation range follows the maximum temperature value of the current scene. The lower limit of the shown temperature range remains constant.

The mode set in each case in the "Automatic" menu item is deactivated by every manual change to the temperature scale or when the Auto Mode (Span) function is triggered for the first time.

Compensation Submenu

In order to implement the specified measurement accuracy, the thermal imager performs an internal compensation (factory setting). In this, the optical channel is closed for a short period of time by means of a shutter. The shutter is part of the optomechanics. It is swiveled into the optical path for a short time as reference.

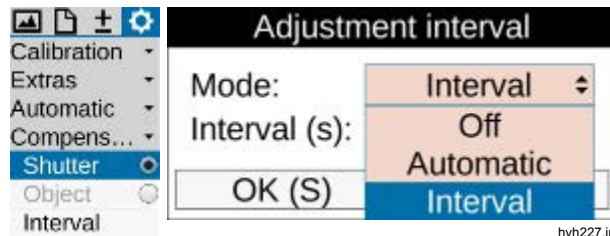

hvh226.jpg

hvh227.jpg

In the Shutter → Interval mode, the interval for an automatic compensation can be set. For this, the time after which an automatic compensation is to be performed must be entered in seconds. The limitations for the interval to be specified are between 5sec and approx. 16min (995sec). Once the entered value exceeds or falls below these limits it is adapted automatically. The recommended factory setting is 60s. Immediately after start-up of the thermal imager the shutter interval is adapted automatically by the internal camera control depending on the change of the device temperature over the course of the first 5 minutes. During this time, the time specified for the "Interval" option is ineffective.

When switching the compensation to the "Object" option, the function is referenced to the current scene. As a consequence, this results in a differential representation referring to the scene present at the moment of compensation. This way, it is possible to visualize very small changes in temperature even with comparatively high scene dynamics.

Buttons Submenu

The thermal imager can be adapted flexibly to different requirements by individually assigning functions to the control buttons. The button function can be specified in the "Buttons" menu item.



hvh228.jpg

Table 3-3 contains a summary of the different functions selectable for the different buttons. To identify the button function as set at the factory, the button symbols are assigned accordingly in the function column.

Table 3-3. Button Functions

Button	Function Short/long (M: halfway/completely)	Explanation
A	Range adaptation A	Temperature scale according to the scene
	Compensation A long	NUC (Non-Uniformity Correction)
	Compensation (long)	NUC Reset + NUC
	Compensation + range adaptation	NUC and temperature scale in accordance with the scene
	"Level/range" menu	For manually setting Level/range
	"Max/Min" menu	For manually setting Maximum/Minimum
1	Laser on/off 1	Laser distance meter/laser pointer on/off
	Light on/off M halfway	Photo light on/off
2	Real-time saving	Start/stop real-time saving
	Video saving	Start/stop video saving
C	Level/range menu C long	For manually setting Level/range

Table 3-3. Button Functions (cont.)

Lang	Max/Min menu 2 long	For manually setting Maximum/Minimum
M	Zoom menu	For setting the zoom
	Isotherms menu	For setting the isotherms
	Infrared/Digital image	Switch-over image mode infrared image – Digital image
	Isotherms on/off	Show/hide isotherms
	Minimum on/off	Show/hide global minimum
	Maximum on/off	Show/hide global maximum
	Minimum and Maximum on/off 1 long	Show/hide global Minimum and Maximum
	Switch-over palette	Next palette
	Invert palette	Invert palette
	Grayscale palette ←→color	Switch-over color - grayscale palette
Freeze image M completely	Stop the live image → Freeze	

TiX640, TiX660, TiX1000

Users Manual

The functions can be set in the corresponding input field for the respective button:

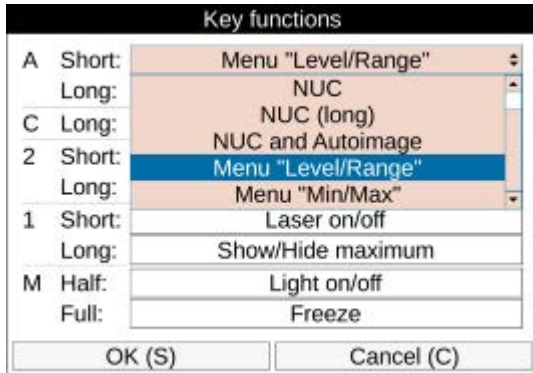

hvh234.jpg

It is possible to assign one function to several buttons at the same time.

Digital Alarm Output Submenu

The "Digital Alarm Output" menu item can be used to define conditions, the fulfillment of which will trigger the camera to perform actions.

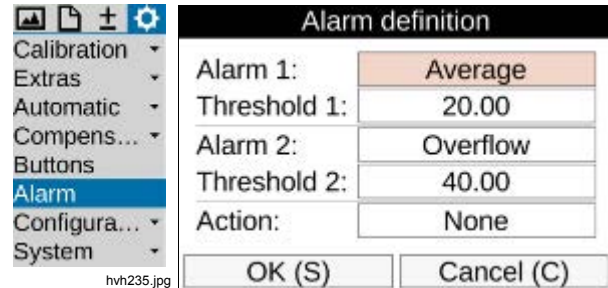

hvh235.jpg

hvh236.jpg

The activated digital alarm output function is indicated in the tool bar below the logo by means of a symbol:



(This indication is made regardless of whether an alarm condition is fulfilled)

Two temperature thresholds can be defined referring to the average value ("Average"), the maximum temperature value ("Upper limit"), or the minimum temperature value ("Lower limit") of all defined measuring objects. If no measuring object is defined, the temperature thresholds refer to the entire image. If at least one of the defined conditions is fulfilled, the following actions may be performed:

- Visualization Alarm indication and display of the fulfilled condition
- Save Image saving in accordance with the settings in "Saving format"
- COM Alarm indication via the RS232 interface
- Audio Output of an acoustic alarm signal
- Digital out 1 Alarm signal at digital output 1
- Digital out 2 Alarm signal at digital output 2

Configuration Submenu

You can save your individual device settings as device configuration in the thermal imager. This way, you can configure and, if required, reload user and/or application profiles matching different requirements. Additionally, you can define actions the camera is to perform when the system is started. These actions are also saved to the corresponding configuration.

The "Configuration" menu item contains the following submenus:

- Load
- Save
- Start
- Default Settings



hvh240.jpg

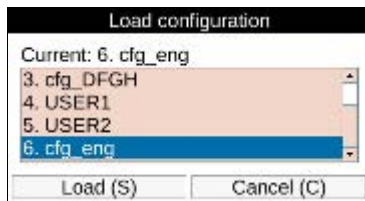

hvh241.jpg



hvh242.jpg

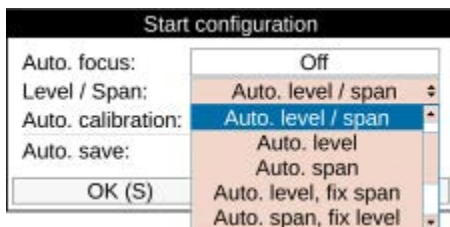

hvh243.jpg

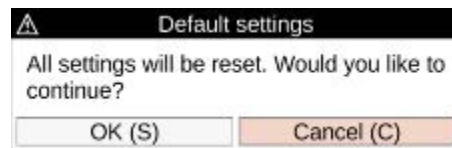

hvh244.jpg

As an alternative to a configuration name generated automatically consisting of a date and a time, e.g. cfg_20120622_1530, a name consisting of a maximum of 20 characters can be edited to save the configuration.

The following options can be selected in the start configuration for system start:

- Auto focus On/Off
- Level/span Auto level/range, auto level (range fix)
- Auto calibration On/Off
- Auto save On/Off

Note

When loading the factory settings, all previously made system settings will be undone. If settings must possibly be re-used at a later point in time, we recommend saving a user configuration beforehand.

System Menu

The "System" menu item contains the settings and information about the basic functions of the thermal imager. Along with the settings for language, date, and time, which as a rule must only be configured rarely, it is possible to set the brightness of the viewfinder and the display, to set the font size, as well as to make a number of further settings for representation and navigation within the menu, amongst other things.



hvh245.jpg

Note

After the system settings were adapted to the individual requirements, we recommend saving the settings in a user configuration.

Display Submenu

The "Display" submenu can be used to select the display settings for the thermal imager. In the standard configuration (factory settings) the display is switched from the display to the viewfinder when the display is folded to the camera housing (active display: automatic). However, you can fixedly set Display or viewfinder (Finder) as active display element.

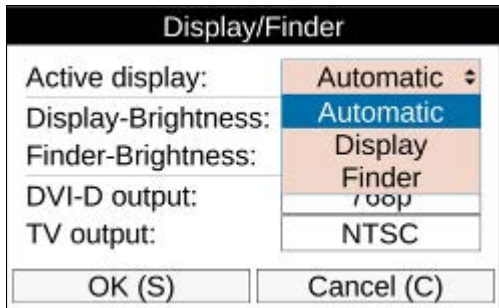

hvh246.jpg

The brightness values of display and viewfinder can be set independently using the levels "Bright", "Medium", and "Dimmed". When the ambient lighting conditions are "normal", the brightness setting "Medium" is absolutely sufficient for the display. In dark conditions, the setting "Dimmed" should be selected.

The DVI-D output can also be set, with the formats 768p and 800p being the available selection options. Regarding the FBAS interface (TV output), it is possible to toggle between the standards PAL and NTSC.

Regional Submenu

The "Regional" submenu can be used to set the language, the date format, the date separator, and the time format. Number and selection of the languages available in each case depend on the equipment. The units for the distance and for the temperature can also be set.

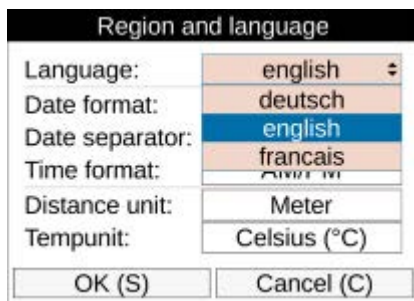

hvh247.jpg

Date and Time Submenu

Setting the date and the time corresponds to the procedure usual for PCs: we recommend entering the information in the corresponding dialogs on a per-line basis from the top to the bottom.



hvh248.jpg

Menu Layout Submenu

The "Menu layout" submenu is used to make the settings for the graphical user interface. The selection options for the font size comprise the 3 levels "Large", "Normal", and "Small". Particularly in the event of a large font size, a part of the text shown in the menus is no longer displayed completely, because the available space is insufficient.

However, when navigating to the corresponding menu item, this menu item is displayed completely even when it exceeds the menu width.

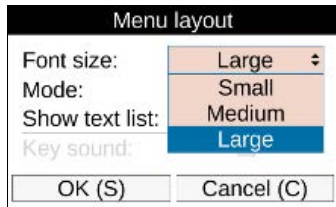

hvh249.jpg

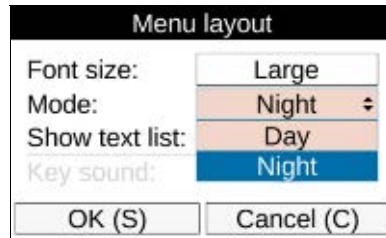

hvh250.jpg



hvh251.jpg

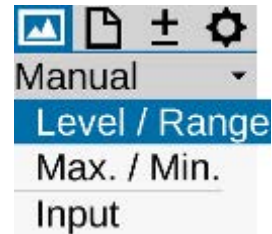

hvh252.jpg

Menu Control Submenu

The way the navigation in the camera menu is controlled can also be adapted to individual requirements. For quick navigation, the experienced user can set submenus to drop down automatically when a menu item is selected. This way, pushing the Enter button on the corresponding menu item, otherwise necessary, is no longer required. When exiting the menu item, the submenu will be closed automatically as well. When this function is activated, the speed of the submenu dropping down can also be set. Regarding the button response, the delay time can be selected in the three levels "Slow", "Medium", and "Fast". To accelerate the navigation within the menu, it is possible to navigate from the "Settings" menu directly to the "Image" menu using → and vice versa using ← (menu cycle "Horizontal"). It is furthermore possible to navigate from the lower menu line directly to the first menu line using ↓ and vice versa using ↑ (menu cycle "Vertical"). To combine both variants, you can select the "Allover" option in the menu cycle.

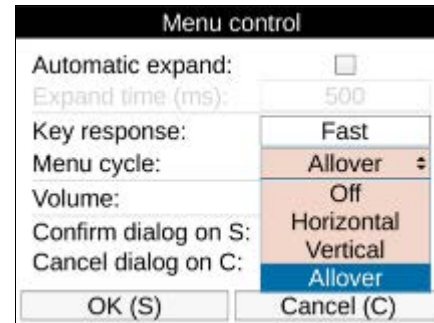

hvh253.jpg

In order to play voice annotations, as well as alarm and system signals, the volume can be set to the three levels "Quiet", "Normal", and "Loud".

By quickly accepting settings in dialogs by using the **S** button without having to navigate to the OK button, and by quickly aborting input operations using the **C** button, thermal imager operation can also be accelerated.

Info Submenu

The "Info" submenu contains the most important system information for hardware (camera) and system software (system). The SD card page can be used to show the already occupied and/or still available memory space of the SC card inserted into the device.

Chapter 4

Maintenance

Title	Page
Introduction	4-3
How to Clean.....	4-3
Calibration	4-3
Environmental	4-3
Service	4-4
Battery.....	4-4

Introduction

The possible maintenance work to be performed on the thermal imager is limited to the process of cleaning outer surfaces.

How to Clean

⚠ Caution

The optical surfaces of the lens are equipped with high-quality optical layers. Avoid any contact with these surfaces and protect these surfaces against dirt and damages. Therefore, position the related protective cap on the lens if the device is not in use.

If cleaning the optical surfaces is nevertheless required, please only use wood-free absorbent cotton or Professional Wipes Kleenex in combination with 96 % ethanol. Please contact the manufacturer in the event of strong contaminations.

⚠ Caution

When the lens is removed (lens change), the aperture of the camera housing must be protected against any kind of contact with the inner components. It must be ensured that no dirt can penetrate the inside of the camera. Interventions of any kind into the inside of the thermography camera are expressly prohibited.

Maintenance and repair work exceeding the actions and measures described within the framework of this user manual must only be performed by authorized skilled personnel. If this is not observed, the warranty and liability obligations of the manufacturer will be forfeit.

Calibration

The thermal imager system was calibrated very carefully to the official norm with the manufacturer, maintaining the measure connection in doing so.

We recommend having the calibration checked by the manufacturer or by another certified authority at intervals of two years. This check should be performed in combination with the general maintenance of the device with the manufacturer.

Environmental

The thermal imager is an optoelectronic device containing specific infrared lenses and electronic printed circuit boards. These components must be disposed of specifically when the device is at the end of its use.

The manufacturer offers to take back the thermal imager product from the customer in order to ensure that the device is disposed of in an environmentally friendly manner when it is at the end of its use.

In this case, see *How to Contact Fluke* for more information.

Service

According to the manufacturer's recommendation, the thermal imager system should be maintained by customer services at an interval of two years.

The manufacturer guarantees the implementation of the service on the thermal imager product.

Should you experience any failures or require the performance of technical maintenance works, please contact your dealer or customer services. See *How to Contact Fluke* for more information.

Battery

⚠⚠ Warning

To prevent possible electrical shock, fire, or personal injury:

- **Batteries contain hazardous chemicals that can cause burns or explode. If exposure to chemicals occurs, clean with water and get medical aid.**
- **Do not disassemble the battery.**
- **Do not short the battery terminals together.**
- **Do not disassemble or crush battery cells and battery packs.**

- **Do not keep cells or batteries in a container where the terminals can be shorted.**
- **Do not put battery cells and battery packs near heat or fire. Do not put in sunlight.**
- **Do not put battery cells and battery packs near heat or fire. Do not put in sunlight.**

⚠ Warning

For safe operation and maintenance of the Product:

- **Repair the Product before use if the battery leaks.**
- **Be sure that the battery polarity is correct to prevent battery leakage.**
- **Use only Fluke approved power adapters to charge the battery.**