

User Manual

Fotric 340 Series

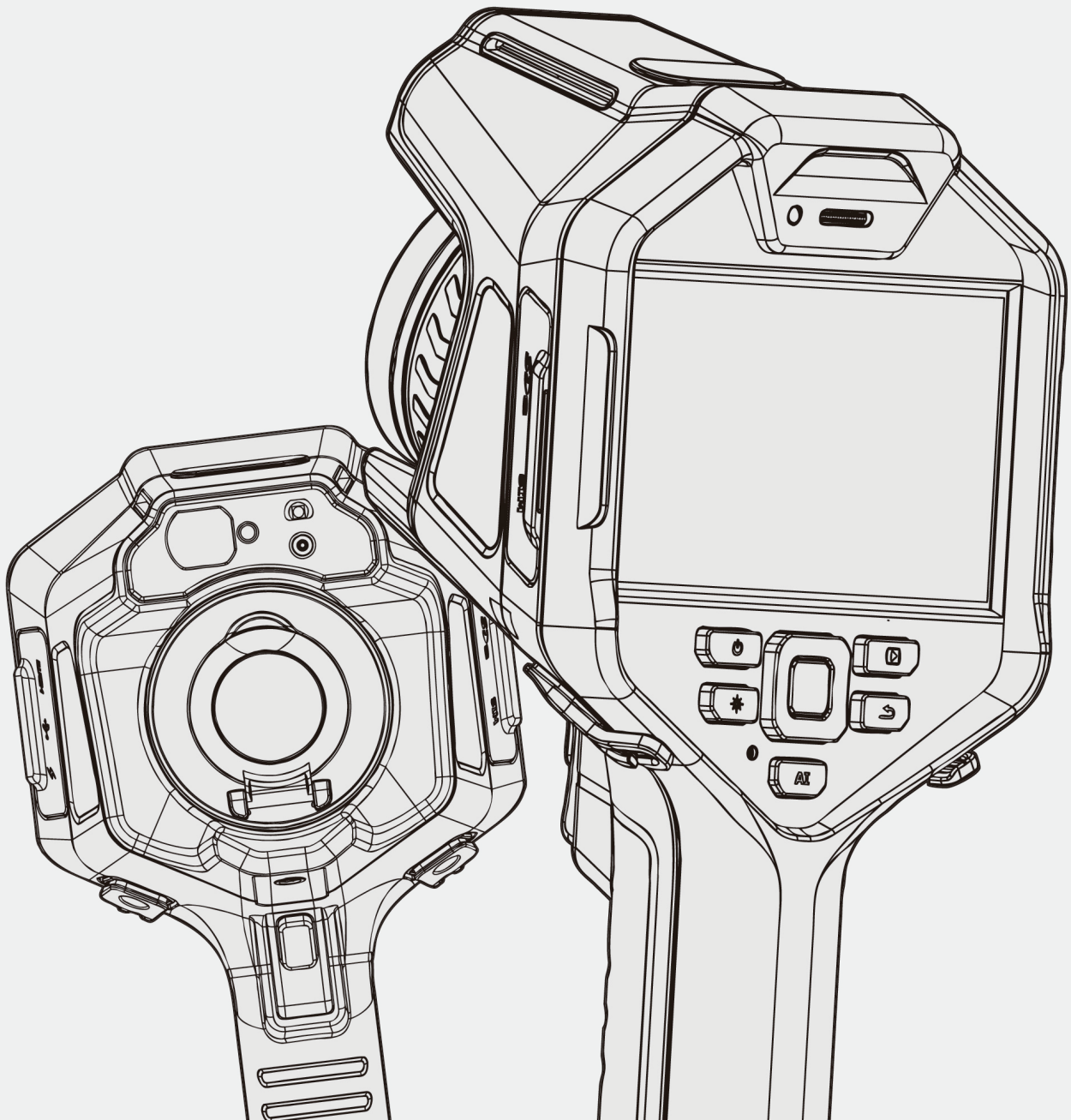

Contents

Legal Disclaimer

Legal Disclaimer	1
Usage Statistics	2
Copyright	2
Quality Assurance	2
Export Control	3

Contact FOTRIC

Safety Information

Definition	5
Important information	5

Product Configuration

1.1 Standard Configuration	7
1.2 Optional Lens	7

Components of the Thermal Imager

2.1 Front View	8
2.2 Rear View	9
2.3 Right View	10
2.4 Left View	11

Operation Guide

3.1 Charging the battery	12
3.2 Turning on and Turning off the Thermal Imager	13
3.3 Adjusting the Infrared Lens Manually	13

3.4 The TurboFocus System of the Infrared Thermal Imager (available for 340A series)	14
3.5 Continuous Autofocus (available for 340A series)	15
3.6 Changing the Lens of Thermal Imager	16
3.7 Transferring Data to A Computer with SD Card	17
3.8 Transferring Data to A Computer through USB Connection	18
3.9 Laser Distance Meter (available for 340A series)	18
3.10 Measuring Areas (available for 340A series)	19
3.11 Measuring Length (available for 340A series)	21
3.12 AI Programmable Key	22
3.13 Gallery	24
3.14 Calibration (NUC)	24

Main Interface

4.1. Main Menu	25
① Status Bar	25
② Measurement Result Table	26
③ Palette and Temperature Scale Display	26
④ Image Display	26
⑤ System Menu	27
⑥ Temperature Measurement Parameters	27
4.2 Swipe-down Menu	27
4.3 Digital Zoom of Real-Time Image	28
4.4 System Menu	29
4.5 Temperature Scale Mode	30
4.5.1 Auto Scale Mode	30
4.5.2 Manual Scale Mode	30
4.5.3 Touch-screen Scale mode	34
4.6 Measurement Parameter Settings	34
4.6.1 Setting Emissivity	35
4.6.2 Setting Reflection Temperature	36
4.6.3 Setting Ambient Temperature	37
4.6.4 Setting Relative Humidity	38
4.6.5 Setting Measurement Distance	39
4.6.6 Setting IR Window Compensation	40
4.6.7 Recommended Values	41

4.7 Image Mode	42
4.7.1 Thermal Image Mode	42
4.7.2 Digital Camera Mode	43
4.7.3 Picture-in-Picture Mode	43
4.7.4 T-DEF Mode	44
4.8 ROI Measurement Tool	45
4.8.1 Measurement of Area and Length (available for 340A series)	47
4.8.2 Select ROI	47
4.8.3 Settings of ROI	48
4.8.4 Delete ROI	49
4.8.5 The ROI Partial Emissivity Setting	50
4.8.6 ROI Display Setting	52
4.8.7 Temperature Difference Calculation	52
4.9 Sound Alarm	54
4.10 Palette	56
4.11 Color Alarm (Isotherm)	58
4.11.1 High Temperature Color Alarm	58
4.11.2 Low Temperature Color Alarm	59
4.11.3 Temperature Range Alarm	59

System Settings

5.1. Capture Mode	61
5.2 Video Recording	62
5.3 Time-lapse Capture	63
5.4 Connections	64
5.4.1 WLAN	64
5.4.2 Hotspot	65
5.4.3 Bluetooth device pair	66
5.4.4 WLAN-FTP Transfer	67
5.5 Temperature Measurement Range	68
5.6 Storage & Save Options	68
5.7 Device Set	70
5.7.1 Unit, Language, Time and Regional Settings	71
5.7.2 Focus Settings (available for 340 A series)	75
5.7.3 Display Set	75

5.7.4 Location	77
5.7.5 LED Lamp as Flash	77
5.7.6 Screen Off	78
5.7.7 Manual Mode Settings	78
5.7.8 Volume	79
5.7.9 Reset	80
5.7.10 Thermal Imager Information	80

Image Freeze Interface

6.1 Favorite	83
6.2 Voice Annotation	84
6.3 Text Annotation	85
6.3.1 Keyboard Input	85
6.4 Tag	86
6.4.1 Keyboard Input	87
6.4.2 QR Code Scan	87

Gallery

7.1 Favorites and Filters	90
7.2 Filter Tag	90
7.3 Opening Image and Video Files	91
7.4 Thermal Image File Analysis	91
7.4.1 Thermal Video File	93
7.5 Deleting An Image or Video File	94
7.6 Deleting Multiple Files	95

Maintenance of the Thermal Imager

8.1 Cleaning the Camera Shell, Cables and other Components	96
8.2 Cleaning the Infrared Lens	96
8.3 Cleaning the Uncooled Infrared Focal Plane Detector	97
8.4 Maintenance of Lithium Battery	97
8.5 Operation Guide on Update FOTRIC 340 App	98

Laser

9.1 General 103
9.2 Laser warning label 103
9.3 Laser rules and regulations..... 103

Appendix

Emissivity Table..... 104

Legal Disclaimer

Legal Disclaimer

Uncooled thermal imaging manufactured by FOTRIC are entitled to 1-, 2-warranty (varies on models) from the date of initial purchase and delivery. Warranty covers defects caused by materials and production processes, provided that such products are handled under normal storage, use, and repair conditions and in accordance with FOTRIC instructions.

Products not manufactured by FOTRIC but included in the system that FOTRIC sells to the original purchaser are covered by the specific supplier's warranty terms (if any) and FOTRIC is not liable for those products. This warranty is provided to the original purchaser and is not transferable. This warranty does not apply to any product that has been damaged by misuse, neglect, accident, or abnormal operating conditions. Consumable parts are not covered by this warranty.

Any defects in the products covered by this warranty must be reported and the product must not be used to prevent further damage. The purchaser must report any defects to FOTRIC immediately, otherwise this warranty will not apply.

If the product is proven defective in relation to materials or manufacturing after FOTRIC's inspection, it is up to the user whether it is to be repaired free of charge or replaced, provided that the product must be returned to FOTRIC within 3 months from above mentioned report date. FOTRIC has no obligation or liability for any defects other than those mentioned above. This product is exempt from any other warranties, expressed or implied. FOTRIC hereby disclaims any implied warranties of merchant-ability and applicability for a particular purpose. FOTRIC is not responsible for any direct, indirect, special, incidental or consequential loss or damage based on contract, civil, or any other legal theory. This warranty clause shall apply the relevant provisions of the laws of the People's Republic of China. Any dispute or claim arising out of or related to this warranty shall be finally settled through arbitration in accordance with the rules of the Shanghai

Pudong New District People's Court of the People's Republic of China. The place of arbitration shall be Shanghai.

Usage Statistics

FOTRIC reserves the right to collect anonymous usage statistics to help maintain and improve the quality of the software and services provided.

Copyright

No parts of this software (including source code) may be reproduced, transmitted, transcribed, or translated into any kind of language or computer language in any form or by electronic, electromagnetic, optical, manual ways, or any other means without the prior written permission of FOTRIC.

No parts of this document may be reproduced, photocopied, reprinted, translated, or transmitted to any readable electronic medium or machine without the prior written consent of FOTRIC.

The names and logos shown on the products herein are either registered trademarks or trademarks of FOTRIC and/or its affiliates. All other trademarks, trade names or company names referenced herein are for identification purposes only and are the property of their respective owners.

Quality Assurance

The quality management system for the development and production of these products in FOTRIC has been certified in accordance with the ISO 9001 standard.

FOTRIC is committed to a policy of continuous development, so we reserve the right to modify or improve any product without prior notice.

Export Control

Thermal imaging products are listed as export-controlled products by the U.S. Department of Commerce, United Nations Security Council (UNSC), and European Union (EU). This product contains a focal plane array and cannot be

used in controlled countries (such as North Korea, Iran, Syria, Cuba, Sudan, Russia, etc.), so please do not bring this product into or used in controlled countries. Any loss or liability arising from the above actions will be borne by you.

Contact FOTRIC

For latest product information, Please contact :

Telephone number:

U.S. : +1 (214) 235-4544

China : +86 (21) 6698 1992

E-mail :

info@fotric.com

Website:

www.fotric.com

Safety Information

This product complies with the restrictions for Class A digital equipment in Chapter 15 of the FCC Rules. These restrictions are designed to prevent harmful interference to civilian installations. If not installed and used in strict accordance with the instructions, this equipment will generate, use and emit radio frequency energy, which may cause harmful interference to radio communications.

Definition

! Warning > Represents a hazardous situation or behavior that could result in personal injury or death.

! Caution > Represents conditions or actions that could result in damage to the instrument or permanent loss of data.

! Notice > Represents useful information for users.

Important information

Please read before using the equipment :

! Warning > This is a class A product. In a domestic environment this product may cause radio interference in which case the user may be required to take adequate measures.

! Warning > Do not disassemble or do a modification to the battery of the thermal imager.

The battery contains safety and protection devices, which, if damage occurs, can cause the battery to become hot, or cause an explosion or an ignition.

If there is a leak from the battery and you get the fluid in your eyes, do not rub your eyes. Flush well with water and immediately get medical care. The battery

fluid can cause injury to your eyes if you do not do this.

! Warning > The thermal imager is equipped with a laser pointer. Do not look directly into the laser beam. The laser beam can cause eye irritation.

! Caution > The thermal imager uses a very sensitive thermal sensor, do not point the infrared camera (with or without the lens cover) at strong energy sources, for example, devices that cause laser radiation, or the sun. This can have an unwanted effect on the accuracy of the camera. It can also cause damage to the detector in the camera.

! Caution > Original packing box must be used during transportation. Please do not strongly hit the thermal imager during use and transportation.

! Caution > When storing the thermal imager, it is recommended to use the original packing box and place it in a cool and dry place, away from strong electromagnetic field.

! Caution > Please avoid oil and various chemical substances to contaminate or damage the surface of the lens. Please cover the lens with cap after use.

! Caution > Do not use the camera in temperatures higher than +50°C (+122°F), unless other information is specified in the user documentation or technical data. High temperatures can cause damage to the camera.

! Caution > In order to prevent potential risk of data loss, please copy (back up) the data to a computer periodically.

! Caution > Please do not open the thermal imager's shell or modify it without permission. Repair services can only be performed by authorized FOTRIC personnel.

! Notice > After the thermal imager is turned on, it may take about 15 minutes to warm up before accurate measurement.

! Notice > Every thermal imager's temperature correction has been performed before delivered from factory.

Product Configuration

1.1 Standard Configuration



- Main body of the Infrared Thermal Imager
- Lens
- Lens cap
- Rechargeable lithium batteries
- Desktop battery charger, Charger adapter
- USB Type-C to USB Interface cable
- Micro HDMI to HDMI Interface cable
- SD card
- SD card reader
- Accessories pack
- Documentations pack
- Soft portable bag
- Hard portable case

1.2 Optional Lens

- Wide-angle lens
- Telephoto lens
- Ultra-telephoto lens



Components of the Thermal Imager

2.1 Front View

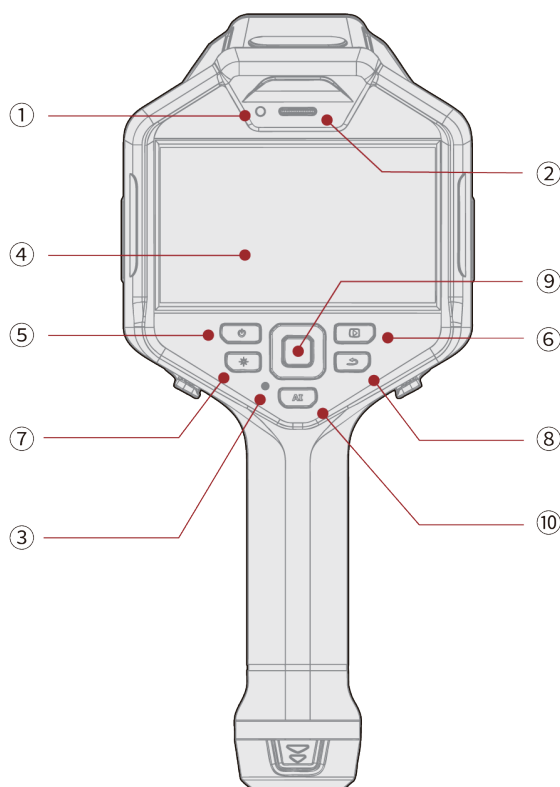

① Standby/charging LED indicator lamp

② Speaker

③ Microphone

④ Touch Screen

⑤ Power Button

⑥ Gallery Button

⑦ Laser Button

⑧ Back Button

⑨ Confirm Button, Up, Down, Left, Right direction keys

⑩ AI Programmable Key

2.2 Rear View

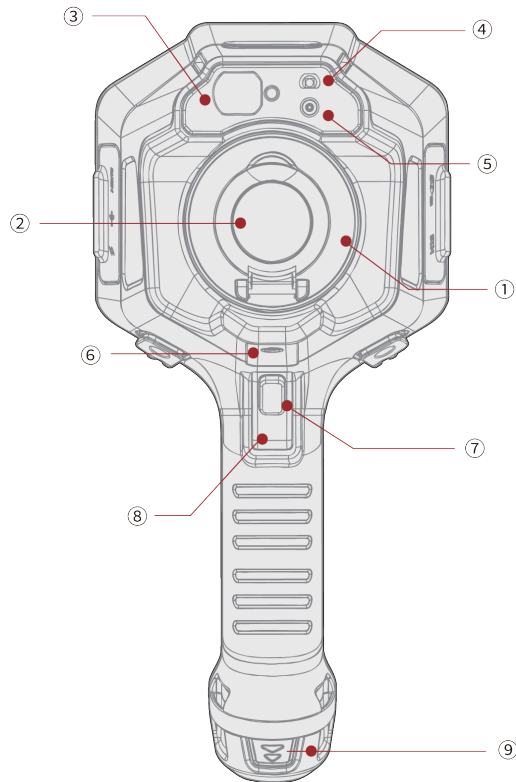

- ① Infrared Lens
- ② Lens Cap
- ③ Laser distance meter (available for 340A series)
- ④ LED Flash Lamp
- ⑤ Visual Light Digital Camera
- ⑥ Threaded Hole for Tripod
- ⑦ Autofocus Button (available for 340A series)
- ⑧ Capture Button
- ⑨ Battery

2.3 Right View

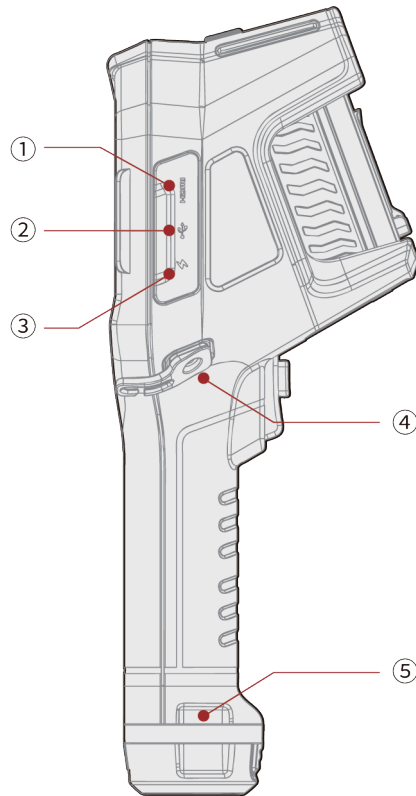

- ① Micro HDMI Interface
- ② USB Type-C Interface
- ③ Battery Charge Interface
- ④ Wrist Strap Bracket Fixed Point (left and right sides)
- ⑤ Wrist Strap Lanyard Fixed Point (left and right sides)

2.4 Left View

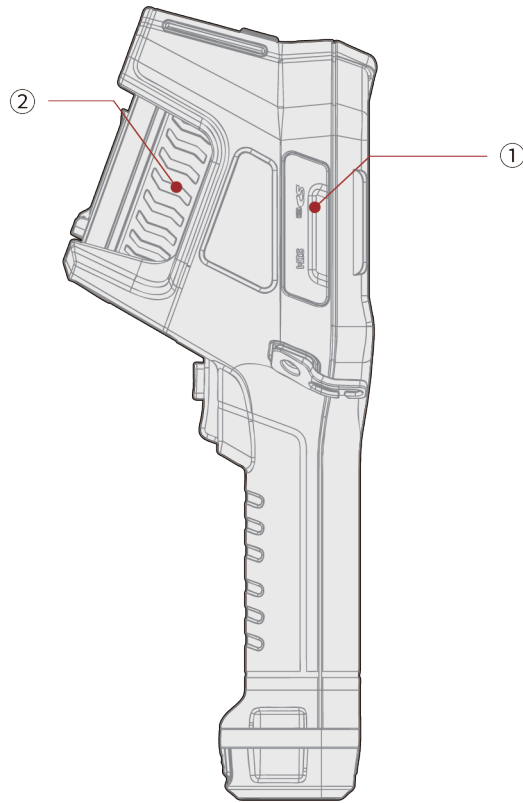

① SD Storage Card Interface

② Focus Ring

Operation Guide

3.1 Charging the battery

Note: Please charge the battery with accompanying battery charger

LED indicator lamp on the accompanying dual battery charger



Signal Type	Explanation
The LED flashes in green/ glows continuously in red	The battery is being charged
The LED glows continuously in green	The battery is fully charged

LED indicator lamp on the front view of thermal imager:

Signal Type	Explanation
The LED flashes in Yellow/Green	When charger is plugged in, screen is on and battery is being charged.
The LED glows continuously in Yellow/Green	When charger is plugged in, screen is on, and battery is fully charged. When charger is plugged in and screen off. No matter device is turned on or off. When charger is not plugged, the device is turned on and screen off
The LED is off	When charger is not plugged, the device is turned on and screen on. When charger is not plugged, and the device is turned off.

3.2 Turning on and Turning off the Thermal Imager



- To turn on the thermal imager, long press the **Power Button** .
- To power off or restart the thermal imager, long press the **Power Button**  (for about 5 seconds), and the selection menu "Power-off" and "Reboot" will pop up.

To turn off the screen or awaken the screen when the thermal imager is on, tap the power button .

3.3 Adjusting the Infrared Lens Manually

Operation Figure

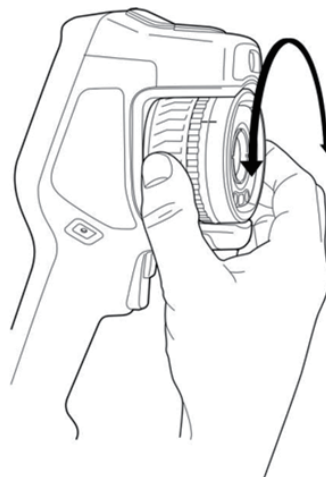

- For far focus, rotate the focus ring clockwise (align the LCD facing towards you).
- For near focus, rotate the focus ring counterclockwise (align the LCD facing towards you).

3.4 The TurboFocus System of the Infrared Thermal Imager (available for 340A series)

FOTRIC TurboFocus auto focus system supports thermal image contrast focus and laser distance focus modes.

1. Thermal image contrast focus: The focus system performs Autofocus based on maximizing optimize the thermal image contrast.



2. Laser distance focus: The focus system performs Autofocus by Laser distance measurement between the thermal imager and the target.
3. The focus modes can be configured through settings. Select System Menu → Settings → Device Set → Focus → Autofocus, and then select CT (Thermal Image Contrast) or Laser.

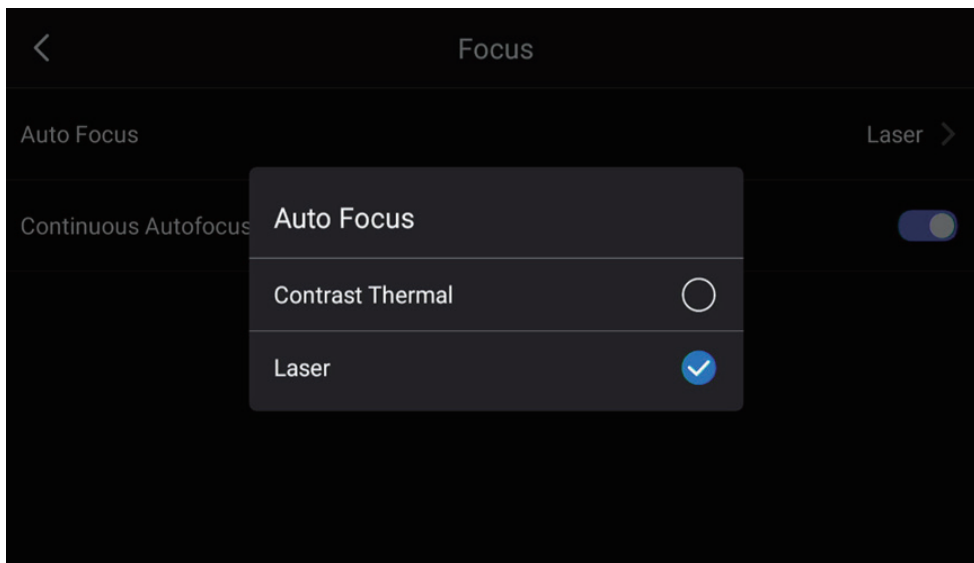
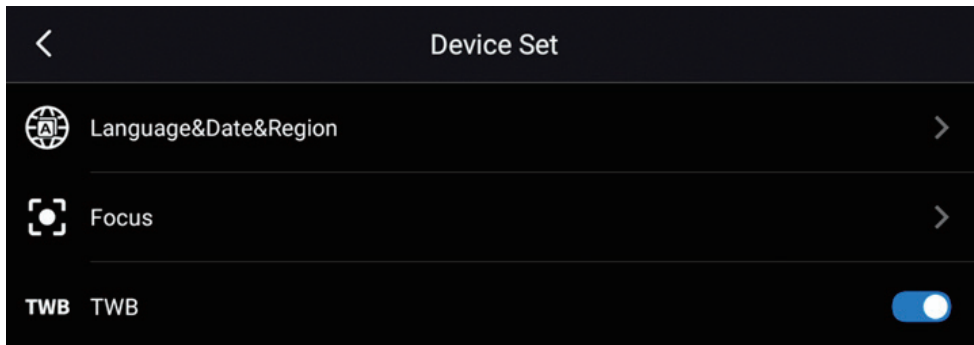

To use Autofocus, press the Autofocus button (the red trigger button at the handle of the thermal imager).

Setting Procedures

- Enter System Menu → Settings → Device Set → Focus → Autofocus → Laser /

Image.

3.5 Continuous Autofocus (available for 340A series)

When the continuous Autofocus function is turned on, the thermal imager will continuously and automatically adjust the focal length according to the measured objects at different distances in the scene by performing thermal image contrast

or laser distance. The thermal imager uses a built-in sensor to detect whether it is moving. When the thermal imager stops moving, it focuses automatically without pressing the Autofocus button.

Enable/disable continuous Autofocus settings: Enter System Menu → Settings → Set Device → Focus → CAF(Continuous AutoFocus) → On/Off.

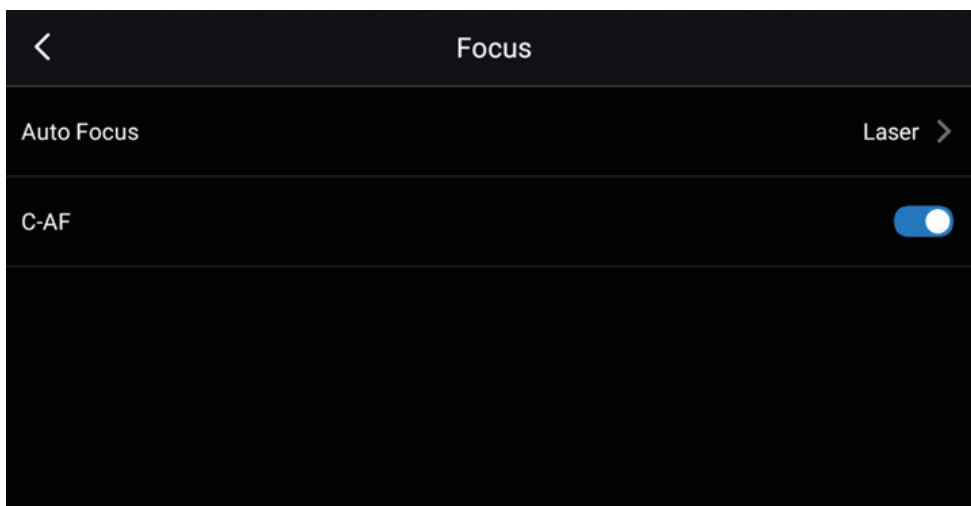
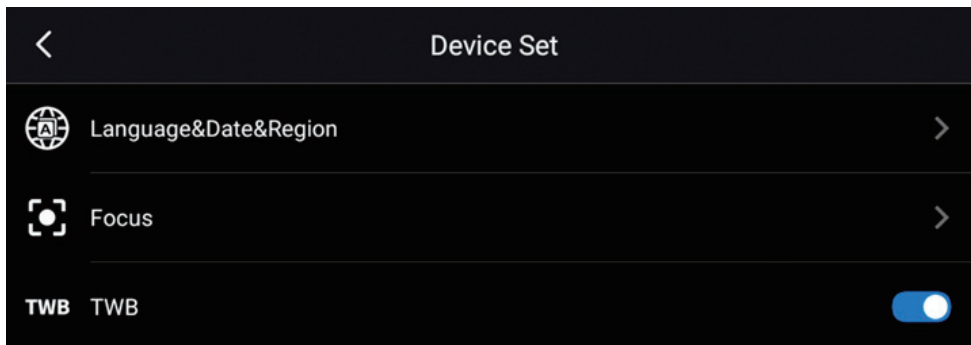

3.6 Changing the Lens of Thermal Imager

Operating Procedures

1. Hold the front end of the infrared lens, rotate counterclockwise to remove the lens;
2. Align the new lens to the mounting point, insert the lens and rotate clockwise to complete the replacement;

3. The thermal imager can automatically recognize the new lens and perform temperature calibration to ensure temperature measurement accuracy.

3.7 Transferring Data to A Computer with SD Card

When saving images or video clips in the thermal imager's gallery, the files are stored in the SD memory card. With SD card reader, the files can be transferred to a computer.

Operating Procedures

- Unplug the SD memory card of the thermal imager;
- Insert the SD card into the card reader, and then insert the card reader into the USB interface of the computer;
- Open the "Gallery" folder from SD card in computer;
- Import images into PC analysis software to "AnalyzeIR" to analyze;
- Unplug the SD card and insert it into the thermal imager. The LED indicator of the memory card lights up.

Note:

- Please do not unplug the memory card while the LED is flashing.
- Please do not connect the thermal imager to the computer while the LED is flashing.

3.8 Transferring Data to A Computer through USB Connection

Images and videos are stored in the SD memory card. With a USB cable, the files can be transferred to a computer.

Operating Procedures

1. Turn on the thermal imager.
2. Open the cover of the Thermal Imager interface box, and plug the USB cable to the USB Type-C interface. Connect the other end of the USB cable to the computer.
3. Open the "Gallery" folder in SD card disk, move the needed files to the computer.

Note: transferring files by drag-and-drop will not delete the files in SD card.

4. Import the images into the PC analysis software "AnalyzIR" to analyze.



3.9 Laser Distance Meter (available for 340A series)

The laser distance meter contains of Laser transmitter and laser receiver. It determines the distance to a target by measuring the time it takes for a laser pulse to reach the target and return to the laser receiver. This time is converted to distance, which is displayed on the screen.

The laser transmitter also works as a laser pointer. When the laser distance meter is on, you will see a laser dot approximately on the target. The thermal imager can be configured to automatically measure the distance when save image.

Operating Procedure

1. To turn on the laser, press and hold the Laser button .

2. When the laser is turned on, the symbol  will be displayed on the screen, and the position and distance of the laser spot will also be displayed on the screen.
3. To turn off the laser, release the Laser button .

To automatically update the test distance, select System Menu →  (Settings) → Save Options and Storage → Measure Distance. (In real-time mode, it will not affect the distance setting in temperature measurement parameters.)

! Note: The laser distance calculation takes about 2 seconds.

! Note: Retain two decimal places for the laser ranging.

! Note: Use m² as the area unit when the distance unit is meters; use ft² as the area unit when the distance unit is feet.

! Note: If the target reflection is too low or the target is at certain angle to the laser beam, there may be no return signal and the distance cannot be measured.

3.10 Measuring Areas (available for 340A series)

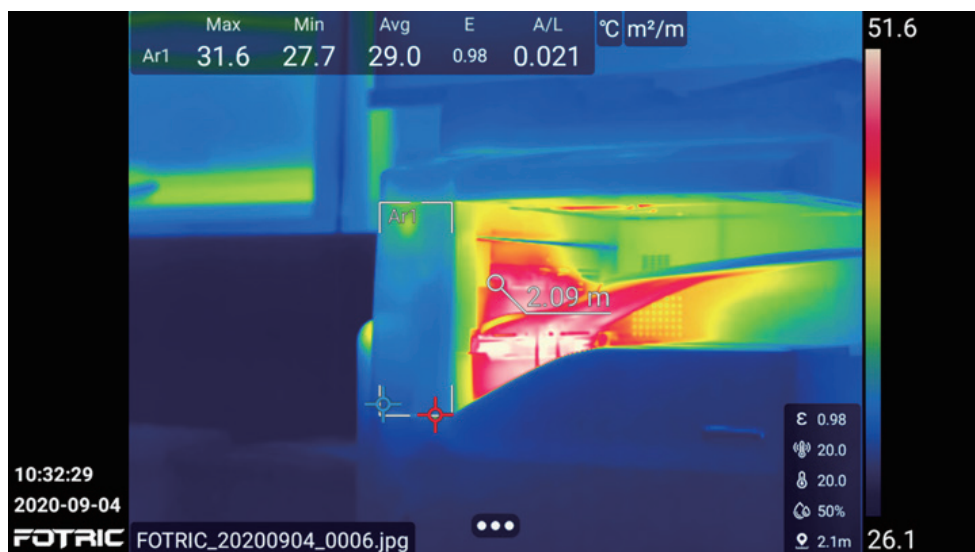

To measure areas, you need to add a temperature measurement rectangle or circle on the screen. The thermal imager will calculate the area of the rectangle or circle, according to the distance of the target. When the laser distance meter is turned on, a laser dot can be seen on the measured target. The thermal imager assumes that this distance is valid to the measurement area of the entire rectangle or circle.

Please follow setting procedures as below:

1. Make sure the "save laser distance" is selected, in "save and storage options".
2. Add a rectangle or circle measurement tool.
3. Make sure the box or circle tool is close to the center of the image.
4. Adjust the size of the box or circle tool to the size of the target.
5. Keep the thermal imager perpendicular to the target, and stable. Press the capture button.
6. The calculated area will be displayed in the result table.

Note: Avoid multiple complex targets with different distances from the thermal imager in the aiming area, otherwise it might cause measurement errors.

3.11 Measuring Length (available for 340A series)

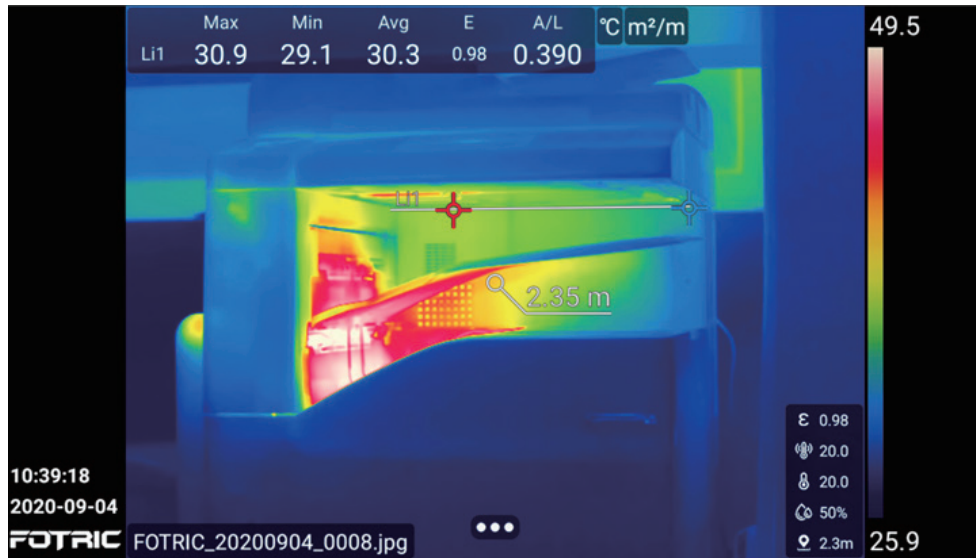

To measure the length, you need to add a temperature measurement line on the screen. The Thermal Imager will calculate the length of the temperature line based on the measured distance to the target. When the laser distance meter is turned on, a laser dot can be seen on the measured target. The thermal imager assumes that this distance is valid to the measurement area of the entire line.

Please follow setting procedures as below:

1. Make sure the "save laser distance" is selected, in "save and storage options".
2. Add a temperature measurement line.
3. Make sure the temperature measurement line is close to the center of the image.
4. Adjust the length and direction of the temperature measurement line to match the target.
5. Keep the thermal imager perpendicular to the target. Press the capture button.

6. The calculated length will be displayed in the result table.

Note: Avoid multiple complex targets with different distances from the thermal imager in the aiming area, otherwise it might cause measurement errors.

3.12 AI Programmable Key



The AI Programmable key can be configured to multiple functions. For example, it can be used to easily switch among frequently used settings.

Long press the AI key for about 2 seconds to program/select the AI switch function.

Tap the AI key to switch to the programmed function.

- Set functions on the Main Interface with AI button

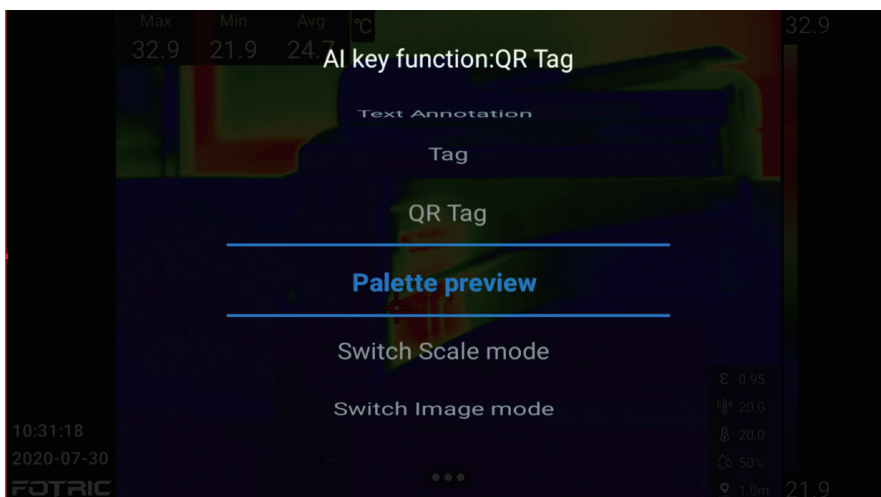

Switch Temperature measurement Range, Palette Preview, Switch Scale mode, NUC and Switch Image Mode.

- Set functions on the Freeze Interface with AI button

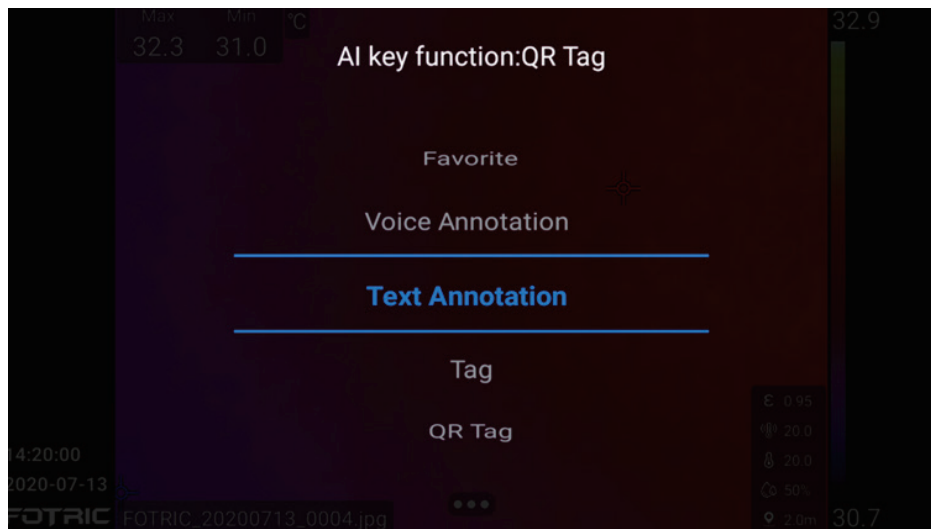

Favorite, Voice Annotation, Text Annotation, Tag and QR Tag.

- Set functions on the Gallery Analysis Interface with AI button

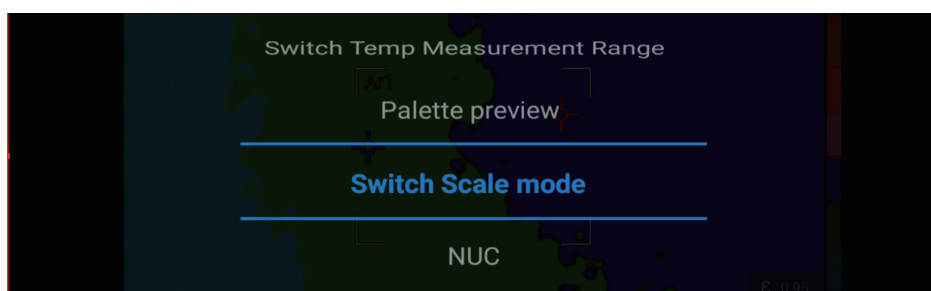
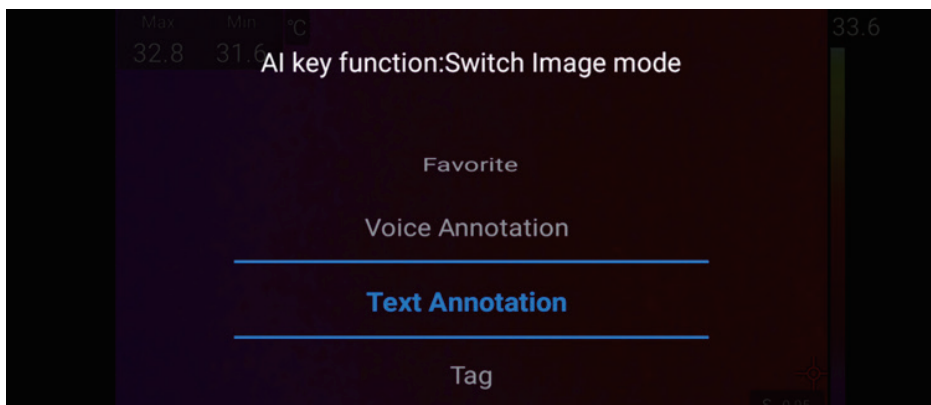

- Favorite, Voice Annotation, Text Annotation, Tag, QR Tag, Palette Preview, Switch Scale mode, and Switch Image Mode.

3.13 Gallery



Press the Gallery button  to enter the Gallery view, as shown below. See Chapter 7 Gallery for more.



3.14 Calibration (NUC)

When the thermal imager displays "Calibrating...", it indicates that a thermal imaging technology called Non-Uniformity Correction (NUC) is being performed.

- NUC is performed automatically, for example, at start-up and change measurement range.
- To perform manual NUC, long press Gallery button for more than 2 seconds.

Main Interface

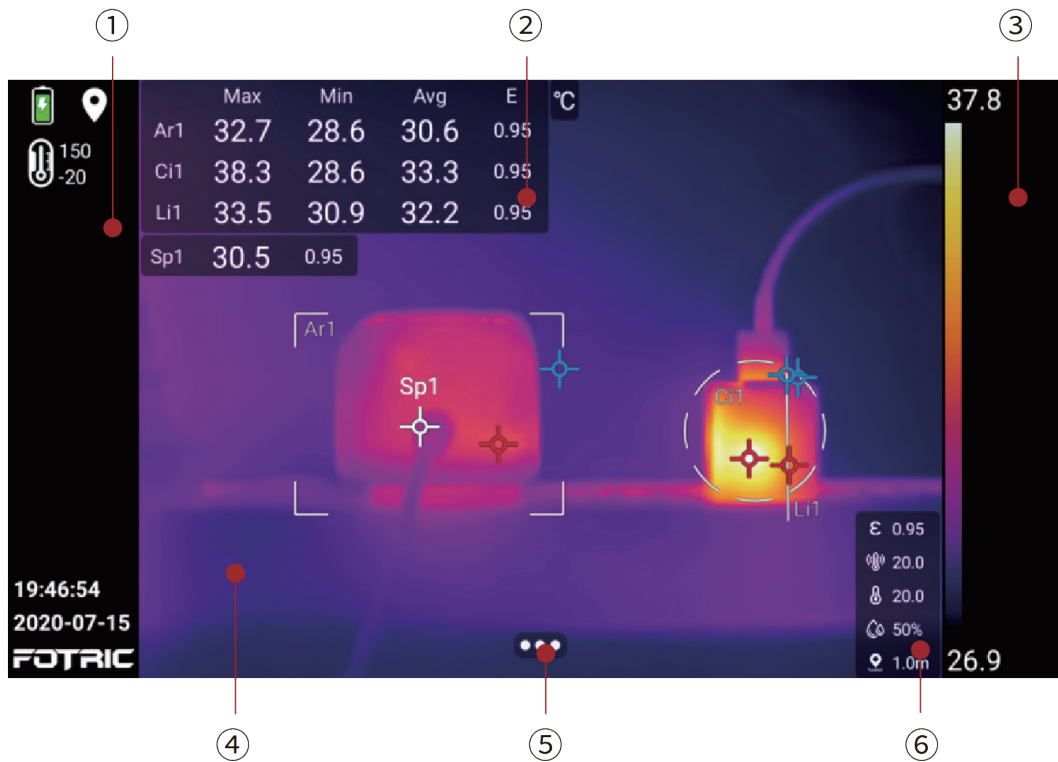

4.1. Main Menu

① Status Bar

Displays read-only information:

- Battery percentage: charging status can be displayed.
- Location
- Temperature measurement range
- Laser status: displayed when the laser is activated
- Date & Time

- Logo
- Warning icon for SD card low storage capacity: displayed when SD card storage is less than 100MB.

② Measurement Result Table

Displays:

- On-screen highest, lowest, and average Temperature values and emissivity.
- ROI area's maximum, minimum, average temperature values, emissivity and area/length (available for 340A series) values. For specific configurations, please refer to Section 4.9.3 ROI Display Settings

③ Palette and Temperature Scale Display

Displays: currently used palette ribbon, the upper and lower limits of temperature scale range. For specific configurations, please refer to Section 4.5 Temperature Scale Mode and 4.10 Palette.

④ Image Display

Displays : Thermal, Digital camera, Picture in Picture, Thermal & Visual light digital camera mode(T-DEF) images and measurement tools. For specific configurations, please refer to Section 4.7 Image Mode.

⑤ System Menu

For specific functions and configurations, please refer to Section 4.4 System Menu.

⑥ Temperature Measurement Parameters

Displays: emissivity, reflection temperature, ambient temperature, humidity, measurement distance and transmittance. For specific configurations, please refer to Section 4.6 Measurement Parameters Settings.

4.2 Swipe-down Menu

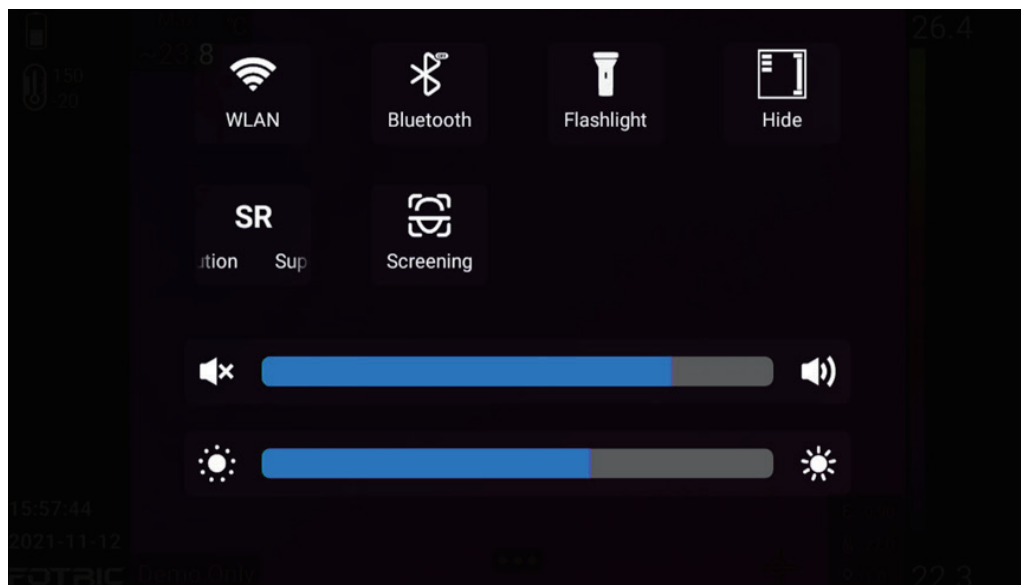

Displays the the system functional status, includes: flashlight, Hide, SR (super resolution), volume, brightness.

Operating Procedures

1. To open: Swipe down from the top of the screen
2. Button control can be adjusted by click.

3. To close: Swipe up from the bottom, or click the "back" button.

Hide All Overlays

Image overlay information includes measurement result table, temperature measurement parameters, ROI settings and system menu button.

Overlay information can be "Hide" in swipe-down menu.

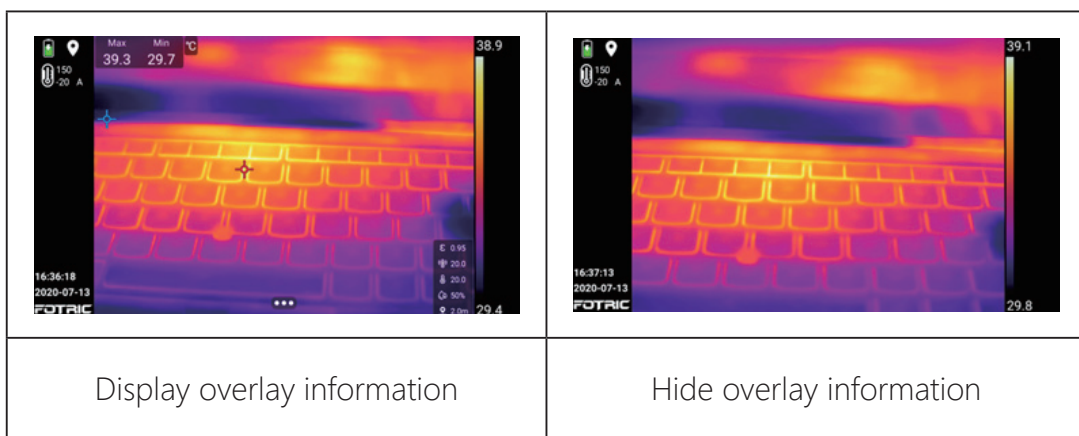

4.3 Digital Zoom of Real-Time Image

The Real time thermal image and video can be scaled using the digital zoom function of the thermal imager. Digital zoom only works in thermal mode.



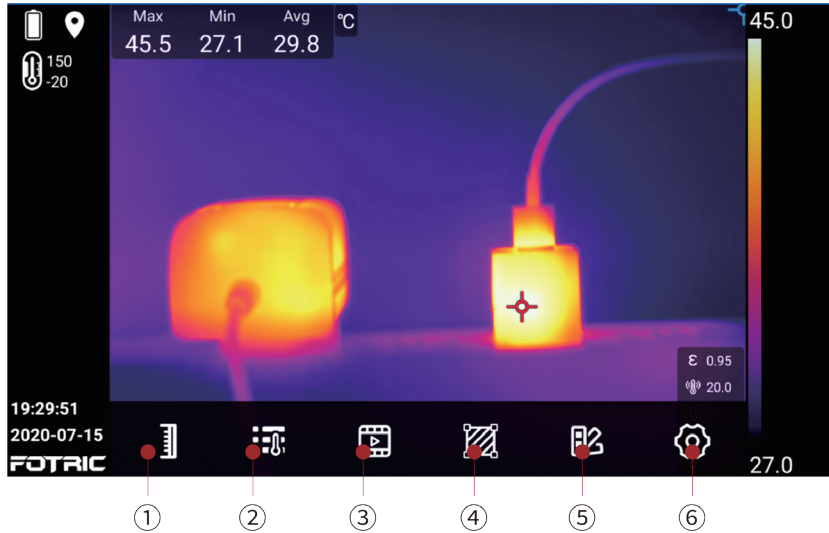

Operating Procedures

- Zoom in: Touch the screen with two fingers and spread the fingers apart.
- Zoom out: Touch the screen with two fingers and pinch the fingers together.

4.4 System Menu



Click system menu button  to open, includes: Temperature scale mode, Measurement parameters, Image mode, ROI, Palette, and Settings.

1.  Temperature scale mode: auto scale, manual scale, touch-screen scale.
2.  Measurement parameters: emissivity, reflection temperature, ambient temperature, relative humidity, temperature measurement distance, IR window compensation .
3.  Image mode: thermal image,digital camera, picture-in-picture, thermal& visual light digital camera(T-DEF) measurement mode settings.
4.  ROI temperature measurement tools: points, rectangles, circles, lines, etc., settings for temperature rise, delete, display settings for temperature measurement masks.
5.  Palette: Iron/ Grey/ Rainbow/ Rain/ Chinese Medical/ GreyRed/ etc.,



Above the alarm temperature, below the alarm temperature, the interval alarm temperature, MagicThermal Rainbow, and MagicThermal Iron.

6.  Settings: capture mode, temperature measurement range, storage and save options, device set.

4.5 Temperature Scale Mode

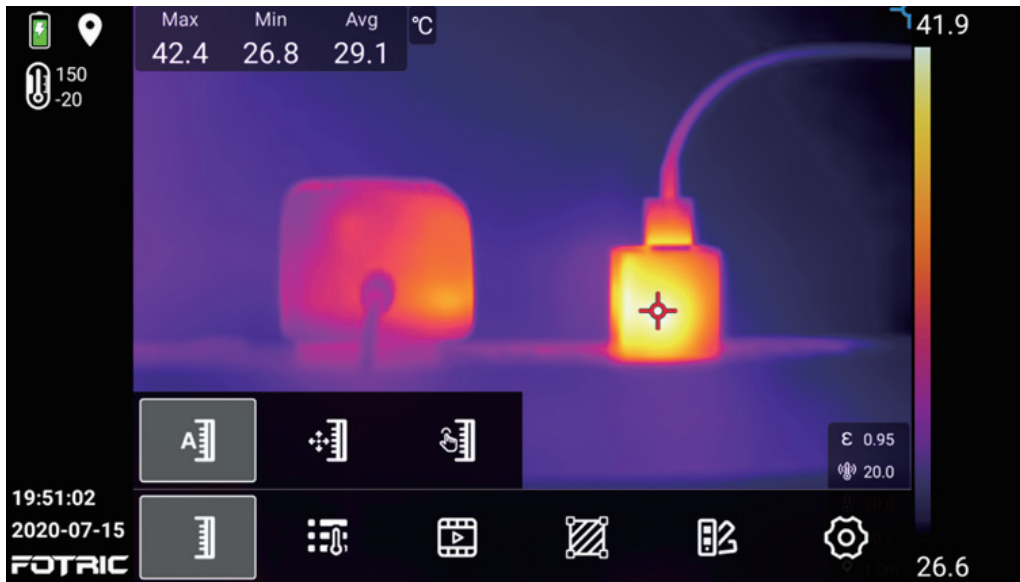
The temperature scale mode button can adjust the image temperature scale.



The thermal imager supports  auto scale,  manual scale and  touch-screen scale modes.

4.5.1 Auto Scale Mode



In Auto Scale Mode, the upper and lower temperature scale limits can be automatically adjusted to achieve the best image effect.

in TWB mode, They are the highest and lowest of the histogram range, not the on-screen's.

4.5.2 Manual Scale Mode



In Manual Scale Mode, the upper and lower limits of temperature scale limits can be set manually. Manual scale has two options, and can be set in Settings- Device Set- manual mode.

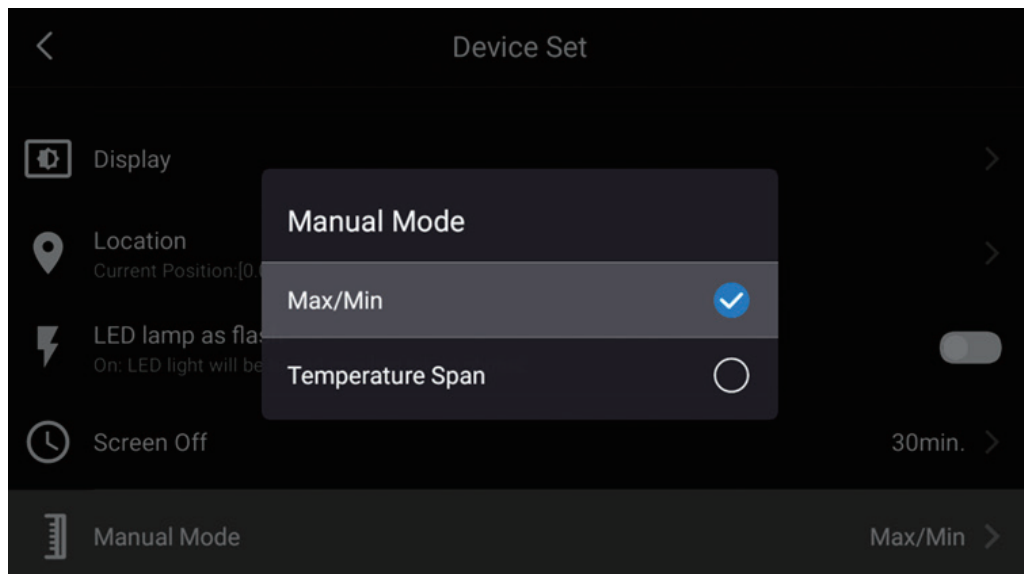

Max / Min Value Mode

In Maximum/Minimum mode, the upper and lower limits of temperature scale can be adjusted.

1. After selecting the manual temperature scale, the upper and lower limits of the temperature scale can be selected, and the grey bottom is in the selected state.

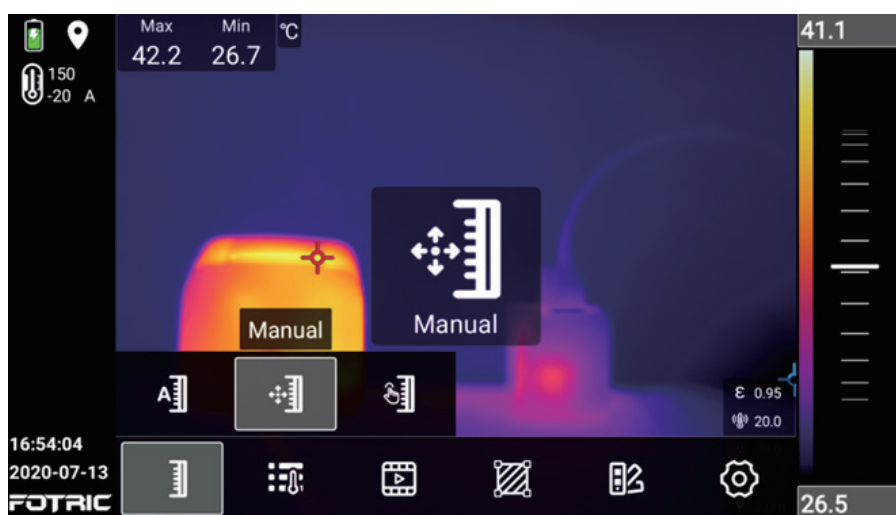

2. The upper and lower limits of temperature scale in the selected state can be

adjusted by using the slider or pressing the up and down direction keys.

As shown in the figure below, the upper and lower limits of temperature scale can be adjusted at the same time by using the slider :

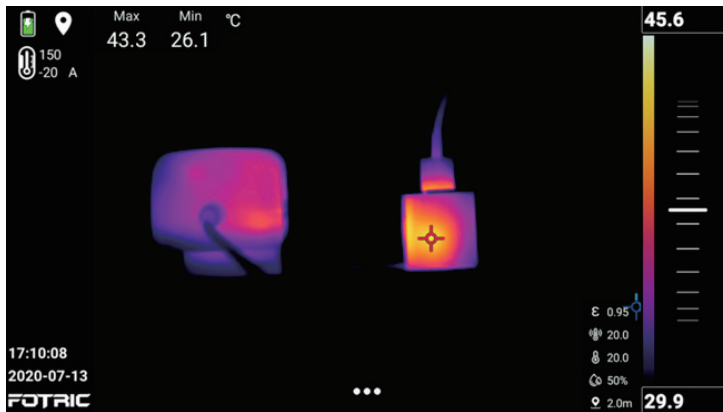

As shown in the figure below, the lower limit of temperature scale can be adjusted by using the slider :



As shown in the figure below, the higher limit of temperature scale can be adjusted using the slider:

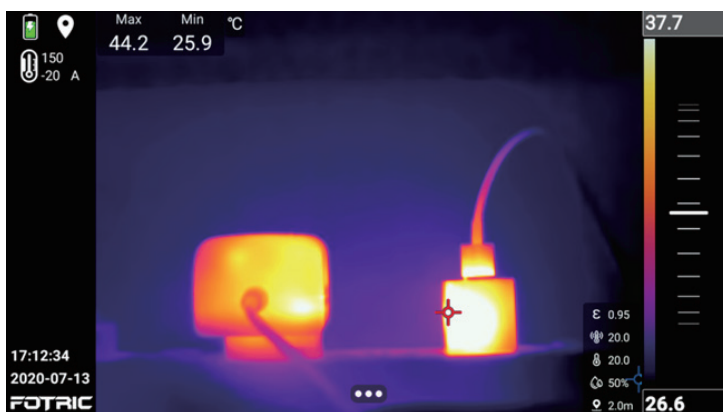

As shown in the figure below, both upper and lower limits of temperature scale are locked and cannot be adjusted :

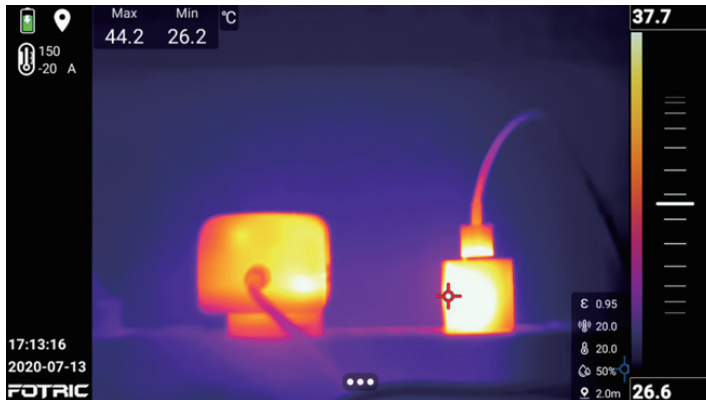

Temperature span mode

In temperature span mode, the temperature scale range (difference between upper and lower limits) value are set unchanged at 4°C, as shown in the figure below:

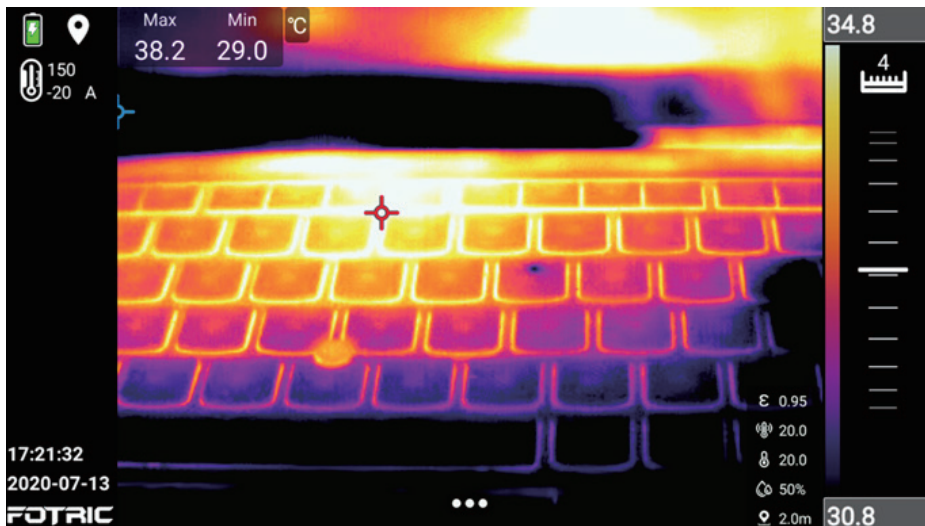

- The upper and lower limits of temperature scale can only be adjusted at the same time, not separately.
- Press the left and right direction keys to adjust the temperature scale range



4.5.3 Touch-screen Scale mode

 In Touch-screen scale mode, the upper and lower temperature scale limits can be adjusted automatically by touching the screen based on temperature range of the touch area (about 10 x 10 pixels in size).

Touch scale mode has two options like manual scale mode.

1. In Maximum/Minimum value mode, the temperature scale can be adjusted by selecting the upper and lower limits of the temperature scale. (If gray base is selected, refer to manual mode).
2. In Temperature span mode, the upper and lower limits of the temperature scale can only be adjusted at the same time, not separately. Press the left and right direction keys to adjust the temperature scale range.

4.6 Measurement Parameter Settings

 is the temperature parameter set button, which can be used to adjust the temperature parameters of the thermal imager. For accurate measurements, it is important to set the measurement parameters.

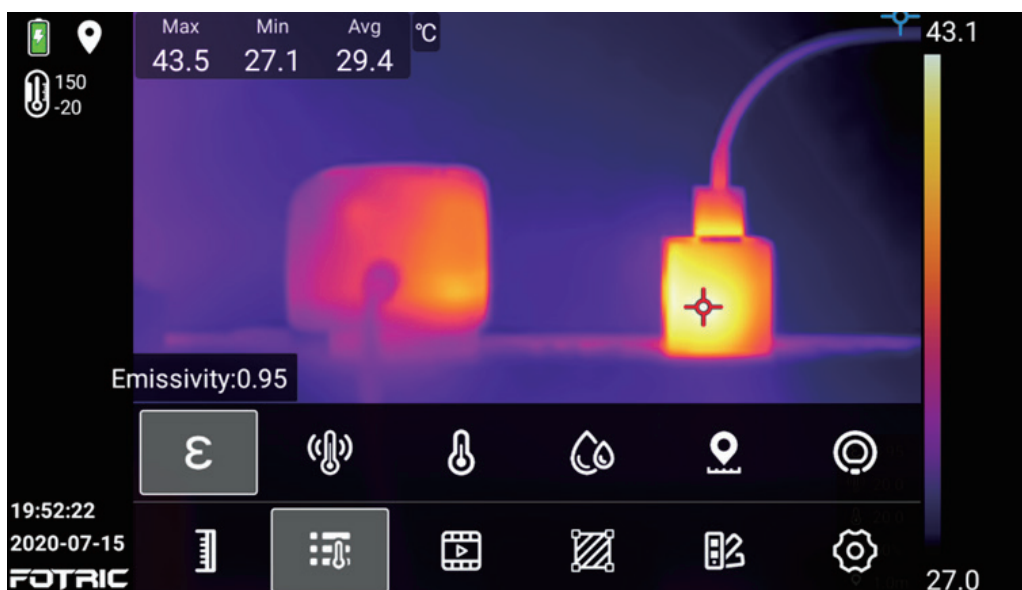

4.6.1 Setting Emissivity

Emissivity is the rate of the measured object's outward radiation energy to the black body's, at the same temperature and wavelength. The value is between 0 and 1.

Note: Emissivity is the most important parameter to be set correctly for accurate temperature measurement.



ε The emissivity settings of the FOTRIC thermal imager has 2 options: full-screen emissivity correction and partial emissivity correction.

To set full-screen emissivity, please perform the following steps:

1. Click the emissivity set button.
2. Slide up and down to set the emissivity value (0.01 – 1.0), or choose the material type.
3. If the materials type is not found on screen, please refer to the material Emissivity Table in the end of this manual. If the material type is not in the

material emissivity table or unknown, please contact Fotric on how to set it.

4. Click on other areas of the thermal image screen, or click the back button to complete the setting.
5. If the emissivity of the unknown material is not recorded in the material emissivity table in the end of this manual, please refer to the text description of how to set the emissivity of thermal imager in this manual for operation.

For partial emissivity, please refer to Section 4.8.5 ROI partial emissivity setting.

4.6.2 Setting Reflection Temperature

The reflection temperature set is used to compensate for the radiation from the surroundings reflected by the measured object. The property of the object is called "reflectivity".

Note: If the emissivity is low and the ambient temperature is much lower than target, it is important to set this parameter correctly for accurate temperature measurement.



 To set the reflection temperature, please perform the following steps:

1. Measure the actual temperature of the reflection source near the target with a thermal imager.
2. Click the reflection temperature set button.
3. Slide up and down to set the reflection temperature value as the result measured by the thermal imager.
4. Click on other areas of the thermal image screen, or click the back button to complete the setting.

! Note: Try to avoid reflection interference as possible, which can highly improve the measurement accuracy.

4.6.3 Setting Ambient Temperature

Ambient temperature is the air temperature between the measured object and the Lens of thermal imager.





To set the ambient temperature, please perform the following steps:

1. Click the ambient temperature set button.
2. Slide up and down to set the ambient temperature value.
3. Click on other areas of the thermal image screen, or click the back button to complete the setting.

Note: The ambient temperature value is set by default in system. This parameter should be set only if the ambient temperature is higher than the measured object's.

4.6.4 Setting Relative Humidity

Relative humidity set is used to compensate for the thermal radiation by atmosphere moisture between the measured object and the Lens of thermal imager.



To set the relative humidity, please perform the following steps:

1. Click the relative humidity set button.
2. Slide up and down to set the relative humidity value.
3. Click on other areas of the thermal image screen, or click the back button to complete setting.

! Note: For short distances and normal humidity, relative humidity is set to the default value of the thermal imager.

4.6.5 Setting Measurement Distance

Measurement distance is the distance between the measured object and the lens of the thermal imager. This parameter is used to compensate for the following two elements:

- The thermal radiation which the atmosphere air absorbed between the object and the thermal imager lens.
- Thermal radiation from the atmosphere air itself.

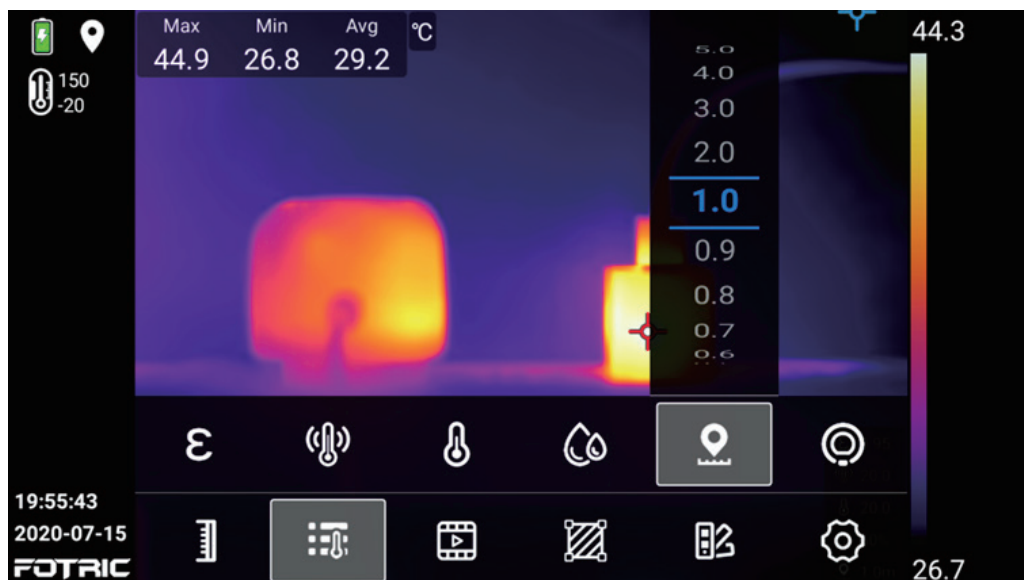



To set the measurement distance, please perform the following steps:

1. Click the measure distance set button.
2. According to the actual distance between the measured target and the infrared thermal imager lens, slide the distance value on the screen up and down, and set the distance value to the actual value.
3. Click on other areas of the thermal image screen, or click the back button to complete the setting.

Note: The measurement distance is usually set to the default value at a short distance or less than the longest accurate measurement distance of the thermal imager.

4.6.6 Setting IR Window Compensation

IR window compensation is used to compensate the transmittance and temperature of the external optics between measured object and the lens of the thermal imager.

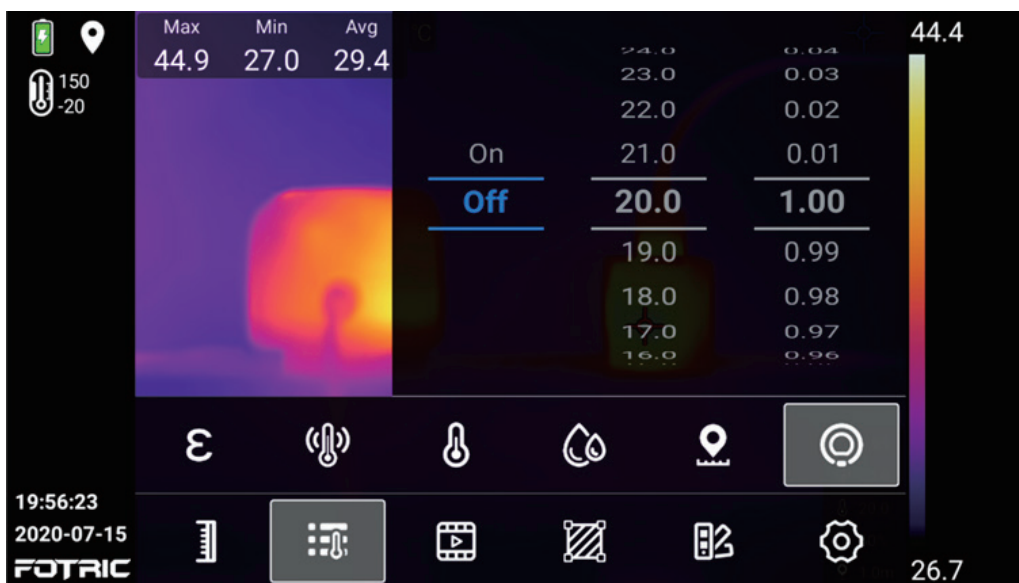

To set the IR window compensation, perform the following steps:

1. Measure the actual transmittance of the external lens or external infrared window (usually tested by the FOTRIC after-sales service department or by a qualified partner licensed by FOTRIC, with standard measurement master for precise test).
2. Click the IR window compensation set button.
3. Slide up and down to select the temperature of the external optical window/ lens.
4. Slide up and down (0.01 – 1.0) and set the transmittance value.
5. Click on other areas of the thermal image screen, or click the back button to complete distance measurement setting.

! Note: If the selected external optical lens has been calibrated at the factory, or there is no external infrared window, the IR window compensation is usually set to off.

4.6.7 Recommended Values

In normal occasions, if you are unsure about the values, the followings are recommended:

Emissivity	0.95
Reflection temperature	20°C
Ambient temperature	20°C
Relative humidity	50%
Distance	1.0 m
IR window compensation	Closed

4.7 Image Mode



The image modes of the thermal imager includes: Thermal image, Digital camera, Picture in Picture, Thermal & Visual light digital camera mode(T-DEF).

4.7.1 Thermal Image Mode

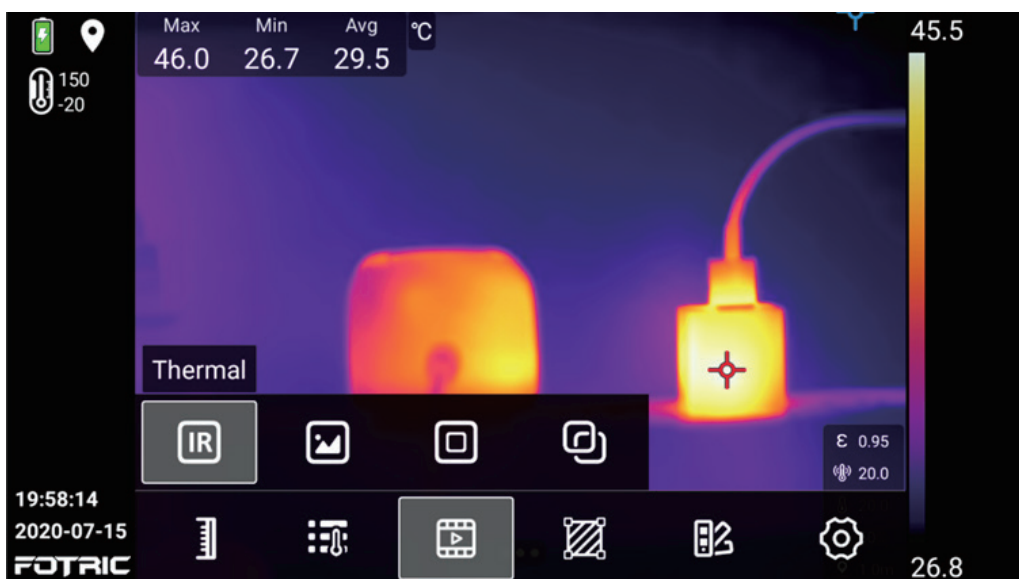

Displays infrared thermal image.

Note: In Thermal Image Mode, please ensure the accurate focus of the thermal imager for accurate temperature measurement.

4.7.2 Digital Camera Mode



 Displays visual light digital camera image.

4.7.3 Picture-in-Picture Mode

 Displays Infrared thermal image superimposed on visual light digital image.

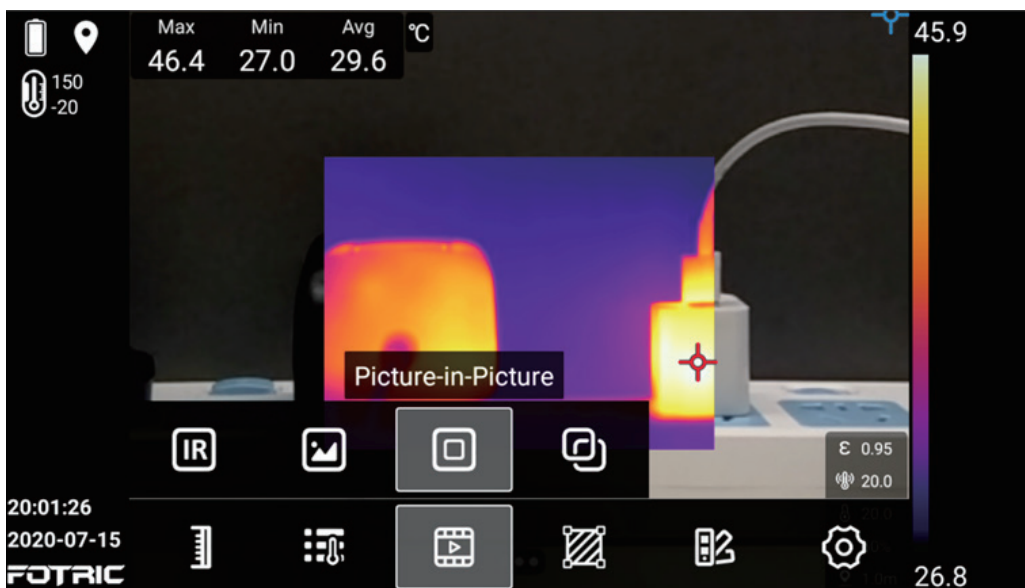

To move or resize the thermal area, please perform the following the steps:

1. Click the four corners and drag to adjust the's size of thermal image;
2. Click the center of the image and drag to adjust the position of the image.



! Note: In Picture-in-Picture Mode, please ensure the focus of the infrared thermal imager is accurate. If the infrared thermal imager does not focus correctly, the temperature measurement accuracy of the thermal imager will be affected, and the visual light will not match the thermal image.

4.7.4 T-DEF Mode



Thermal & Visual light digital camera mode(T-DEF) Mode: Fusion of thermal image and visual light digital camera image to enhance the display of image contrasts.

Note: In T-DEF Mode, please ensure the accurate focus of the thermal imager. If not, the fusion of thermal image and visual light image will not be matched.

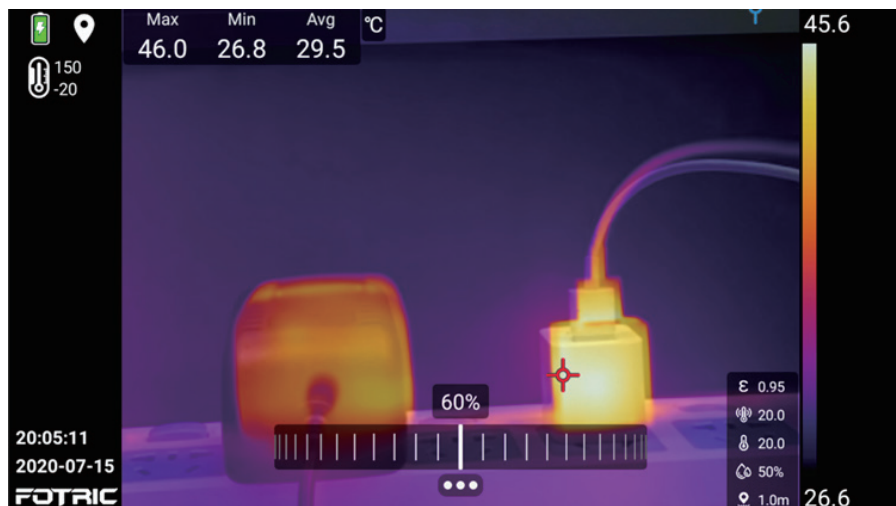
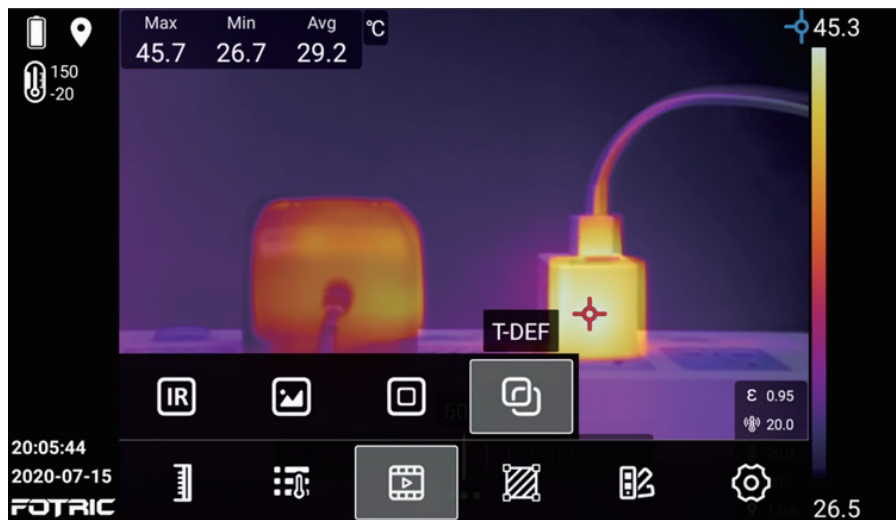

The transparency of the thermal image picture can be adjusted by using the slider. In 0% transparency, the temperature identification and temperature data can be directly displayed in the visual light image.

It is recommended to turn on the continuous focus function to ensure the best aligned overlapping of the picture. (available for 340A series)

4.8 ROI Measurement Tool



Click the ROI measurement tool button to enter its sub-menu.

ROI is the abbreviation for Region Of Interest. ROI can be set up as circular, rectangular, line and point measurement areas.

The circular measurement area is abbreviated as Ci; The rectangular measurement area is abbreviated as Ar; The linear measurement area is abbreviated as Li; The point measurement area is abbreviated as Sp.

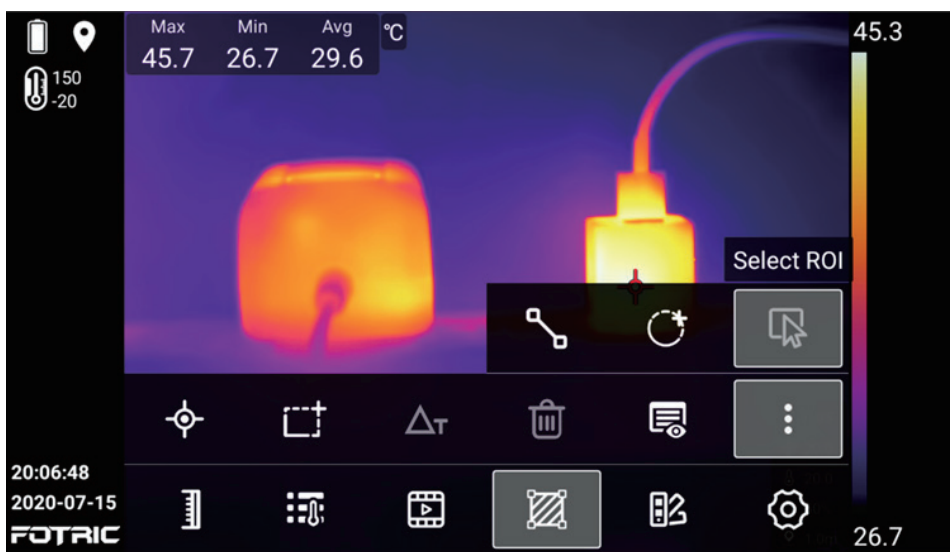

Click to add a movable measurement point.



Click to add a movable rectangle measurement area.



Click to set the temperature rise between the measurement ROI and a reference temperature value, or the temperature difference between the temperature measurement ROIs.



Click to clear all ROIs.



Display settings button for ROIs.



Click to display more function buttons.



Click to add a movable measurement line.

 Click to add a movable circle measurement area.

 Click to select the ROIs.

4.8.1 Measurement of Area and Length (available for 340A series)

- The laser distance meter button can be used to measure the areas after adding a rectangular/circular area. See Section 3.10 Measuring Areas .
- The laser distance meter button can be used to measure the line length after adding a line. See Section 3.11 Measuring length.

4.8.2 Select ROI

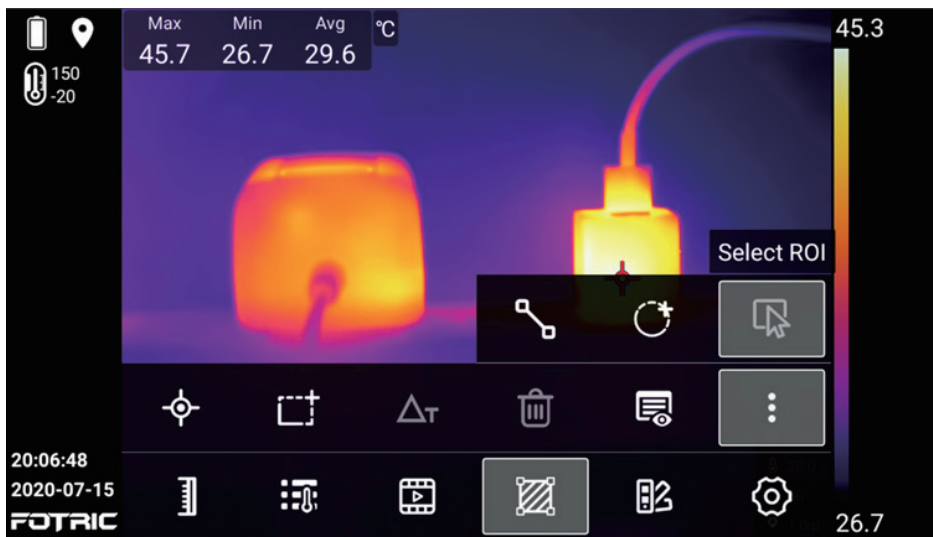





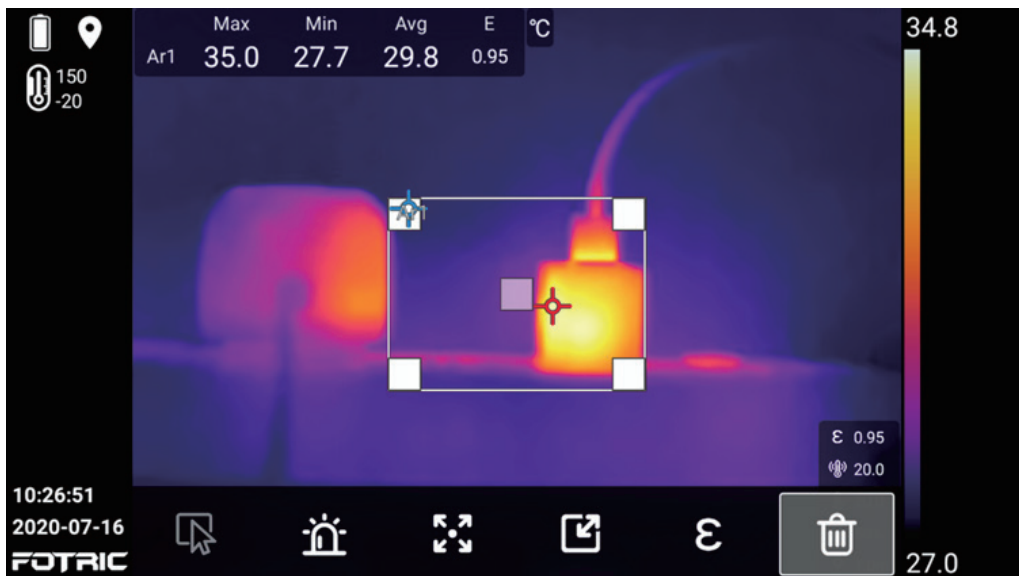

To select ROI, Please follow the steps as below:

1. Click directly on the ROI or the select ROI button.
2. Press or slide up and down in the ROI selection area, to adjust its position, size and emissivity.

3. Click on other areas of the screen, or click the back button to complete selection.

4.8.3 Settings of ROI



-  Click to select ROI.
-  Click to set the sound/silent alarm.
-  Click to move the ROI position.
-  Click to resize ROI area.
-  Click to set ROI partition emissivity.
-  Click to delete selected ROI.

To set the ROI, please perform the following steps:

1. Select the ROI on the screen, and click the alarm set button to set temperature alarm. Please refer to Section 4.9 sound alarm .
2. Click the ROI position move button, and lightly press the four direction keys

(up, down, left and right)or directly press the ROI to move position.

3. Click the ROI area resize button, and slightly press the four direction keys (up, down, left and right)or directly press the ROI to adjust the ROI size.
4. Click the ROI emissivity button and choose the emissivity value or find material type in the emissivity material table.
5. Click on other areas of the screen, or click the back button to complete the ROI adjustment and setting.

4.8.4 Delete ROI

There are two ways to delete ROI: Delete selected ROI and delete all ROIs.

Delete Selected ROI

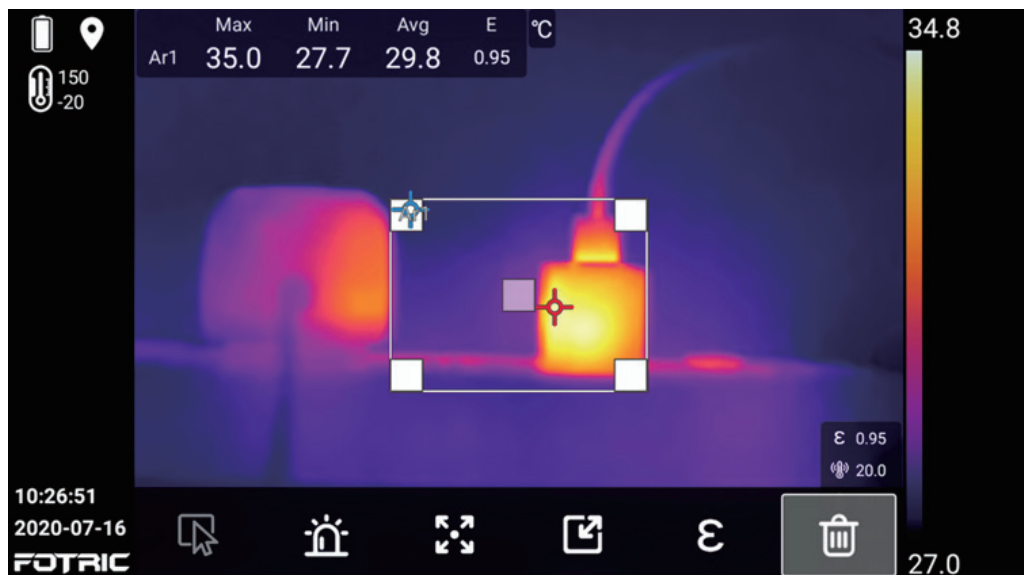

To remove the selected ROI, please perform the following steps:

1. Click the ROI (such as Ar1) on the screen that needs to be removed.
2. Click the icon .

3. Click the  delete ROI button to delete the ROI (such as Ar1)

Delete all ROIs

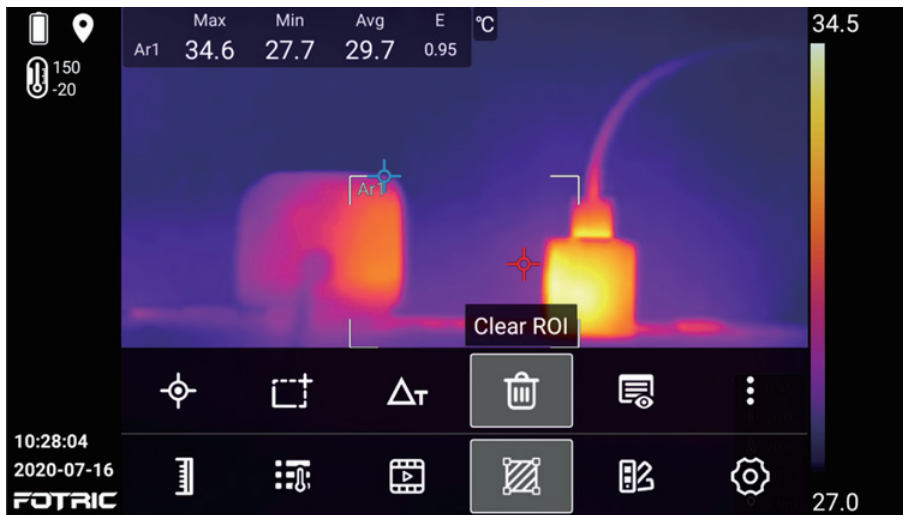

To delete the entire ROI, please perform the following steps:

1. Click the system menu button.
2. Click the ROI measurement tool button.
3. Click the Clear ROI button to delete all ROI information on the screen.

4.8.5 The ROI Partial Emissivity Setting

 ROI Partial Emissivity Set button

To set the ROI partition emissivity, please perform the following steps:

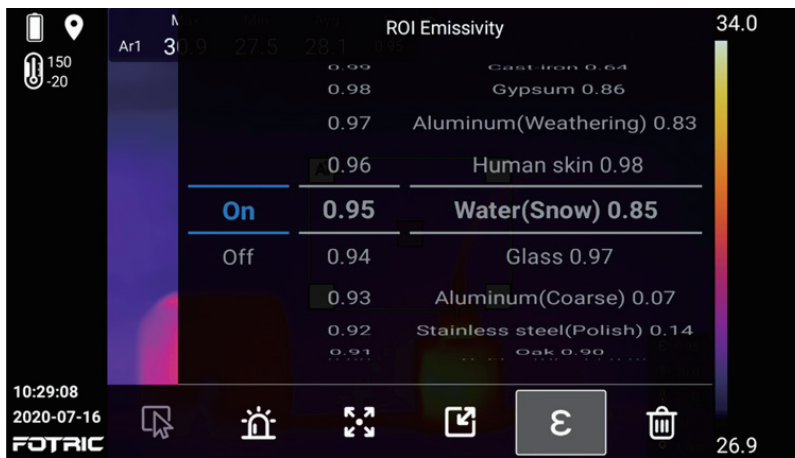

1. Click the ROI that requires partial emissivity setting.
2. Click the emissivity button.
3. Slide up and down to set the emissivity value (0.01 – 1.0), or choose the material type.
4. If the materials type is not found on screen, please refer to the material Emissivity Table in the end of this manual. If the material type is not in the material emissivity table or unknown, please contact Fotric on how to set it.
5. After the ROI partial emissivity set, click the other area of the screen or click the back button to complete.

4.8.6 ROI Display Setting

 ROI display set button.

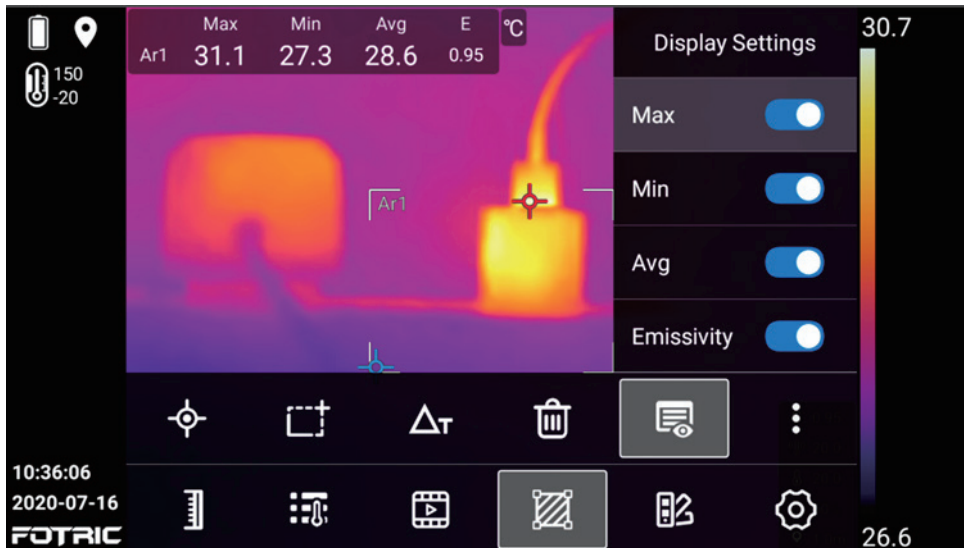

ROI information can be set to display on screen, including maximum, minimum, average temperature and emissivity.

4.8.7 Temperature Difference Calculation

 Temperature rise & difference button.

1. Click to set the temperature difference between the temperature measurement ROIs, or the the temperature rise between the ROI and a reference temperature value.

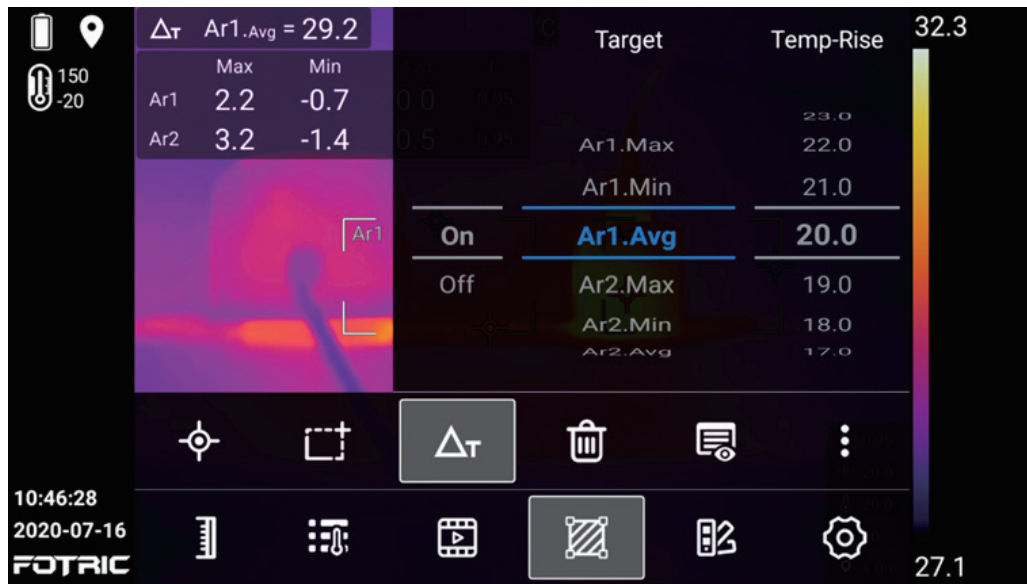

- For the temperature rise between the ROI and a reference temperature, the temperature displayed on the screen is the actual temperature minus the reference temperature, which can be used to eliminate environmental interference and calculate the temperature change.



4.9 Sound Alarm

 ROI sound alarm set button.

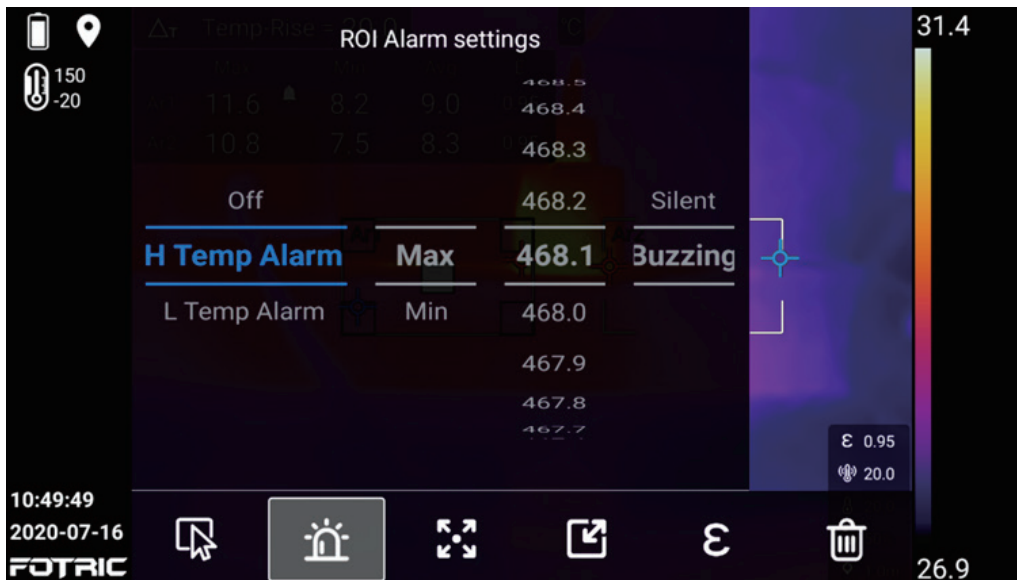

High temperature alarm: When the designed temperature is higher than the preset high temperature threshold, the temperature value will turn red, and a sharp rapid beep sound can be set triggered to remind.

Low temperature alarm: When the designed temperature is lower than the preset low temperature threshold, the temperature value will turn blue, and a sharp and intermittent beep sound can be set triggered to remind.

Highest temperature: alarm is given for the highest temperature of ROI ;

Lowest temperature: alarm is given to the lowest temperature of ROI ;

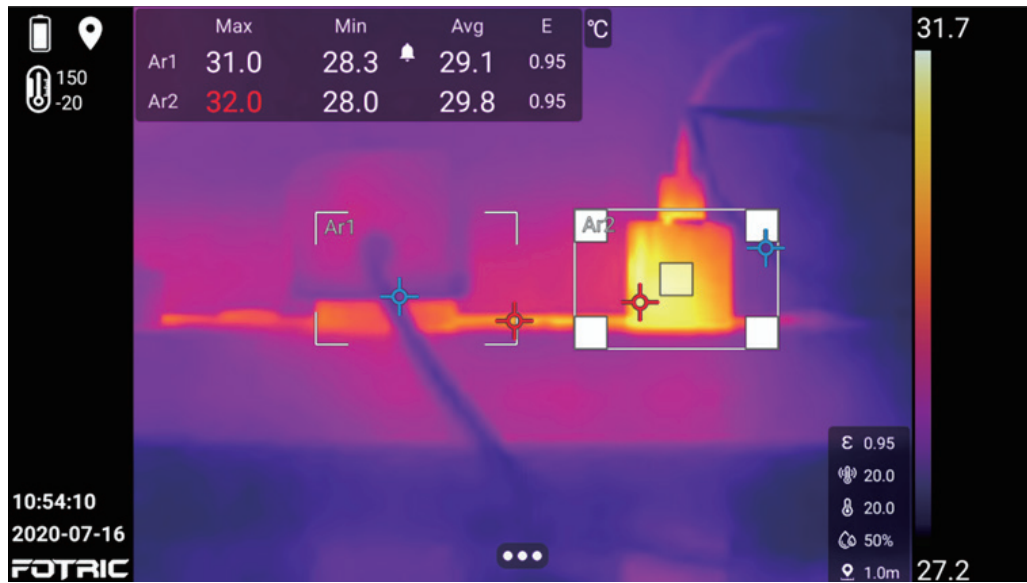

To turn on the sound alarm, please perform the following steps:

1. Select the alarm area; (different alarms can be set for different ROIs).
2. Click  button at the bottom of the screen and select the sound alarm button.
3. Choose high temperature alarm or low temperature alarm as required.
4. Set maximum or minimum temperature in the region.
5. In the temperature alarm bar on the screen, slide up and down to adjust the temperature threshold.
6. Click the other areas of the screen, or click the back button to complete the sound alarm setting.

4.10 Palette

 Click the palette set button and enter the palettes sub-menu. You can select the palette and set the color alarm (isotherm).

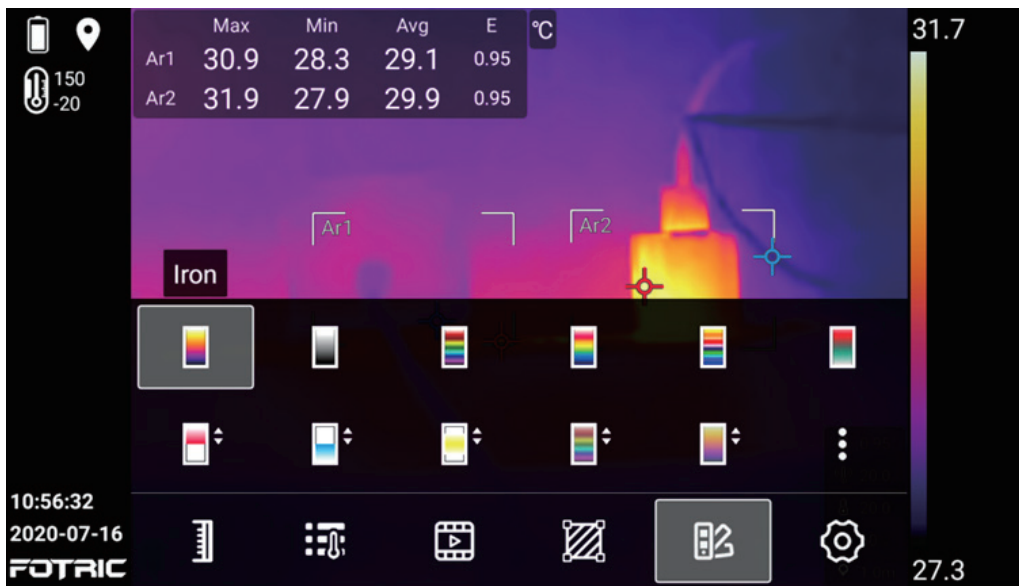

 Iron Palette.

 Grey Palette.

 Rainbow Palette.

 Spring Rain Palette.

 Chinese Medical Palette.

 GreyRed Palette.

 Color alarm (isotherm) above temperature, which is generally used to quickly find the temperature abnormal area of the measured object.

 Color alarm (isotherm) below temperature, which is generally used to quickly find the temperature abnormal area of measured object.

 Color alarm (isotherm) interval the temperatures, which is generally used to quickly find the temperature abnormal area of the measured object.

 MagicThermal Rainbow Palette.

 MagicThermal Iron Palette.

 More hidden buttons, as shown below:

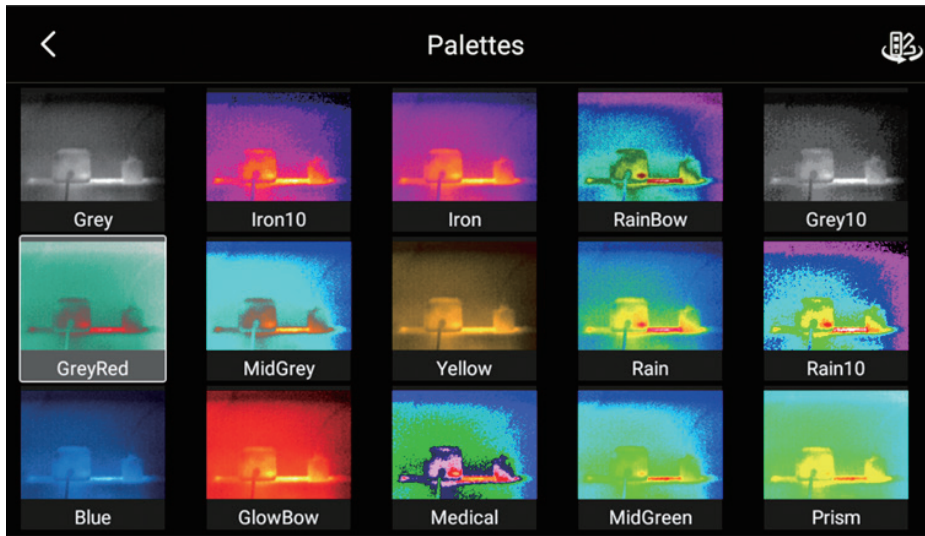

 To invert the color for the palettes.

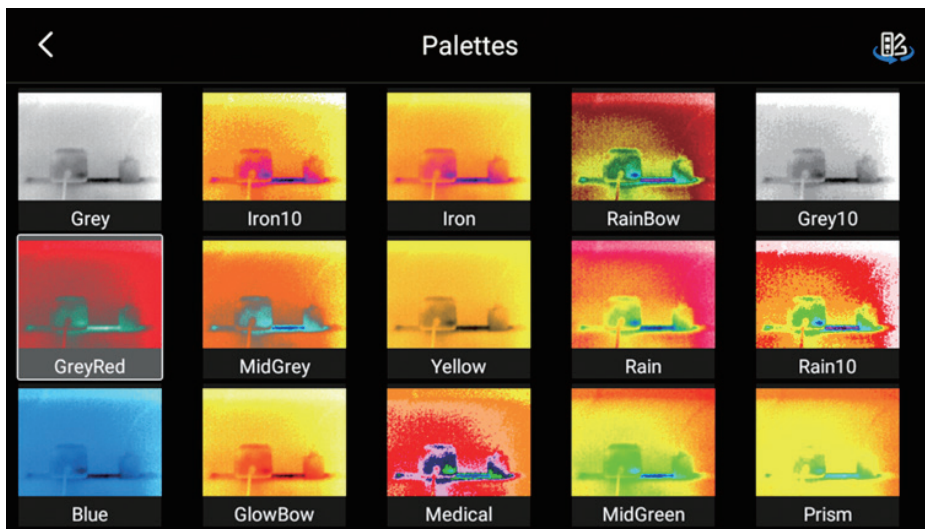

4.11 Color Alarm (Isotherm)

Color Alarms (Isotherms) are generally used for rapid screening of temperature anomalies. This thermal imager supports three kinds of isotherms: above temperature, below temperature and interval temperatures.

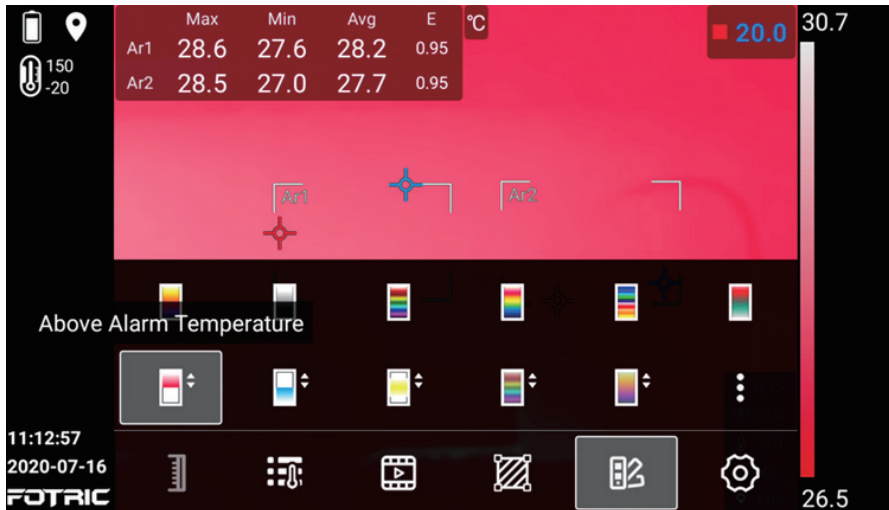

4.11.1 High Temperature Color Alarm

Select  above-temperature. The value in the upper right corner can be selected, and can be adjusted by pressing up and down keys when it turns blue.



4.11.2 Low Temperature Color Alarm

Select  below alarm temperature for color alarm. The value in the upper right corner can be selected, and can be adjusted by pressing up and down keys when it turns blue.



4.11.3 Temperature Range Alarm

Select  interval alarm temperature.



The lower limit and upper limit of temperature range alarm can be set and the value in the upper right corner can be selected, and can be adjusted by pressing up and down keys when it turns blue.

System Settings

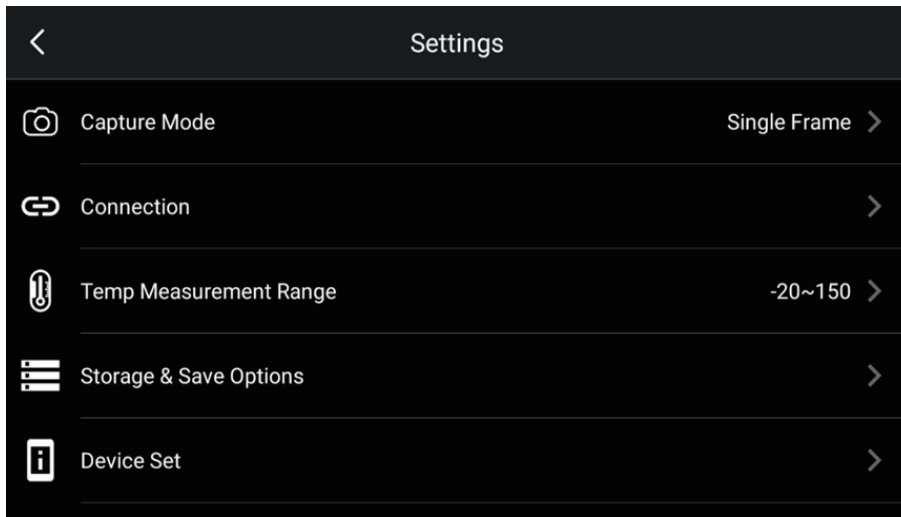

The system settings menu includes the following options:

- Capture Mode
- Temperature Measurement Range
- Storage & Save Options
- Device Set

5.1. Capture Mode

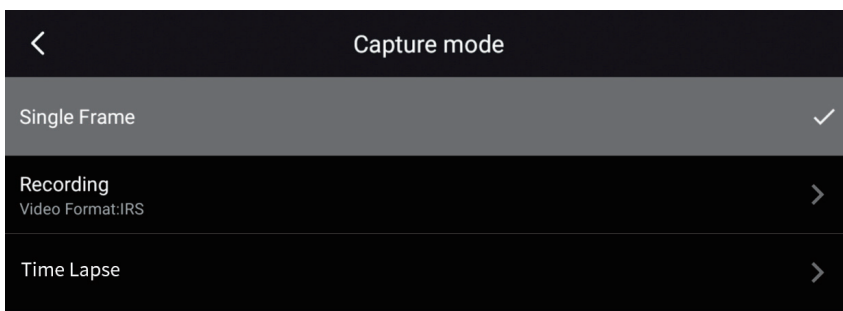

Single frame Capture, video recording and Timer(Time lapse) can be set.

When select single frame capture, press the capture trigger to take photos.

5.2 Video Recording

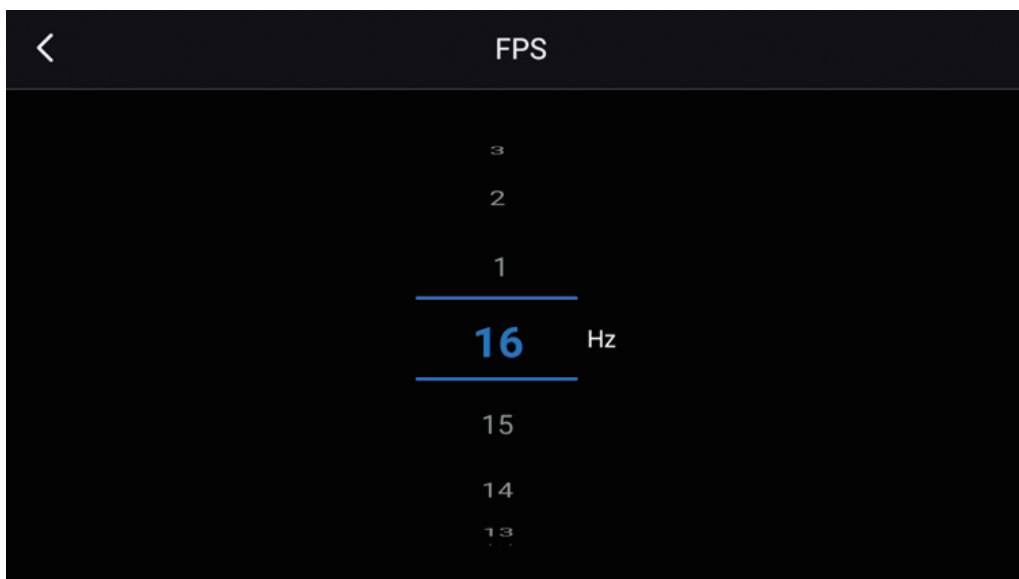

1. The recording frame rate can be set from 1 to 16 HZ(frames per second), and the capture mode is automatically set as video after selection.
2. After set to video recording, click the camera trigger to start recording and click the camera trigger again to pause.
3. IRS and MP4 files are supported. IRS is a thermal imaging video format that supports full-radiation analysis, while MP4 files are ordinary videos(cannot be edited after saving).
4. The video compression format can be set in (Settings) → Storage and Save Options → Video Format.
5. Full radiation recording only supports thermal image mode, while non-full-radiation recording can support all image modes.

5.3 Time-lapse Capture

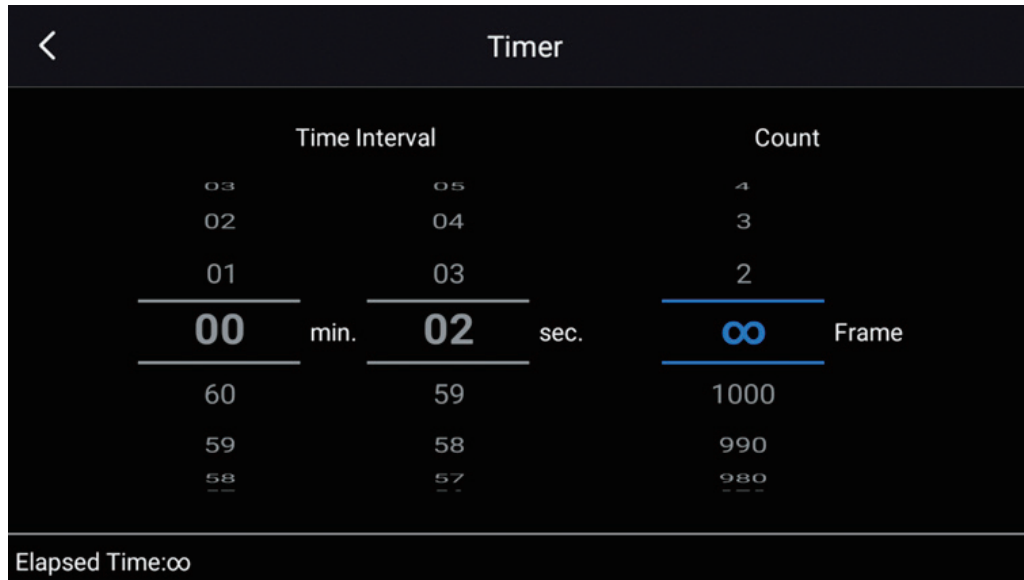

1. The capture time interval can be set here. The shortest interval is 2 seconds and the longest is 60 minutes 59 seconds;
2. It can be set to automatically stop after a certain number of capture frames. The maximum is 1000, or unlimited captures.
3. After select time-lapse capture, press the trigger to start capture. Press the trigger again to stop. If the total number of photos is set, it will automatically stop when reached.

Note: During time-lapse capture, only thermal image mode is supported. No operation is allowed except the focus operation.

5.4 Connections

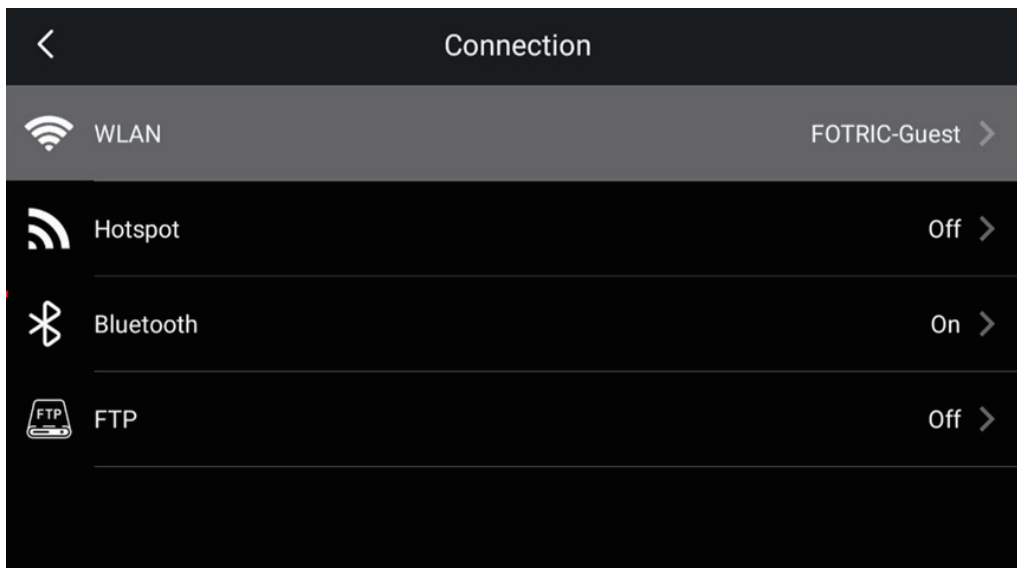
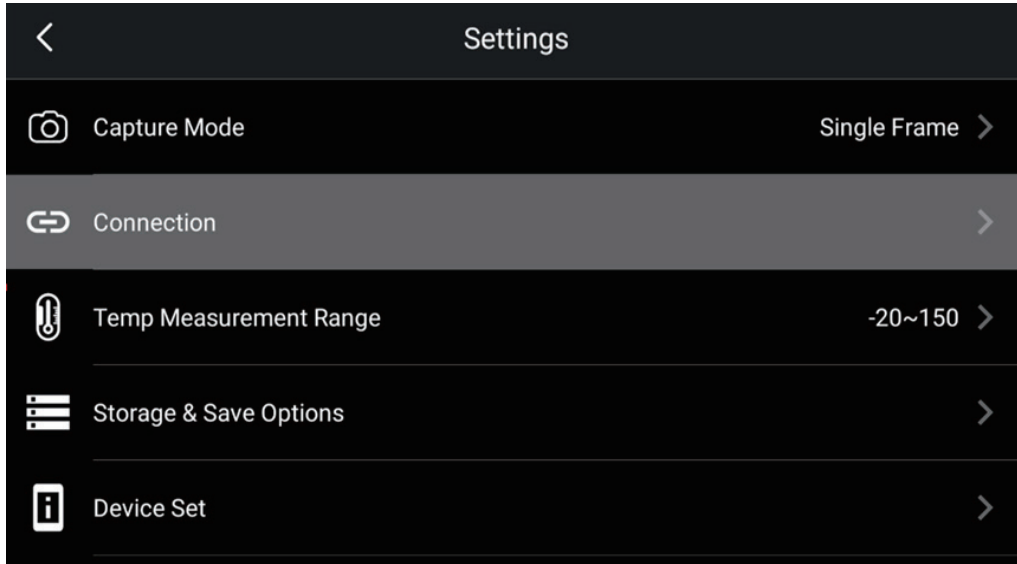

Wi-Fi, Bluetooth, and WLAN FTP Transfer

5.4.1 WLAN

The thermal imager can be connected to WLAN via Wi-Fi .

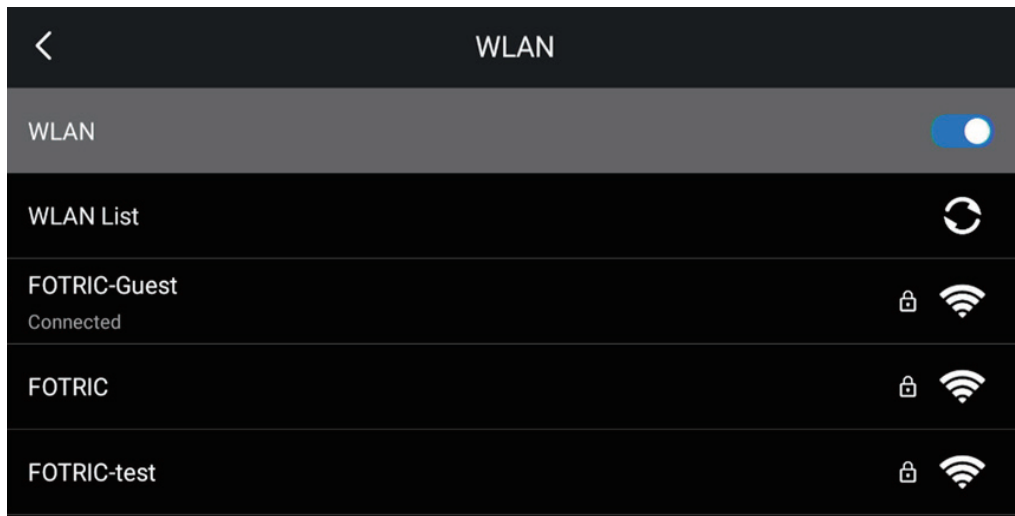

1. Click on **【...】** on the screen or the confirm button on the operation panel.
2. Click on "Settings"
3. Click on "Connection"- "WLAN"
4. Turn on "WLAN".
5. Choose an available Wi-Fi network. Enter password if required.

5.4.2 Hotspot

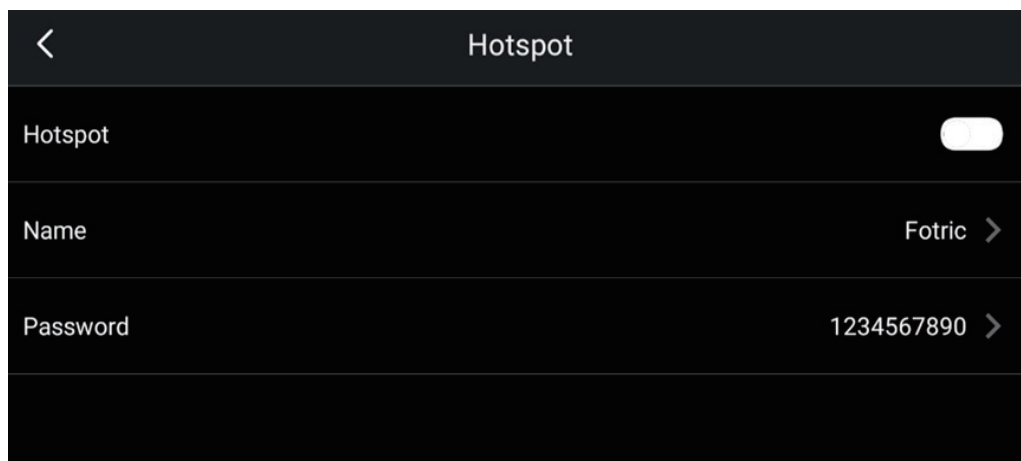

1. Click **【...】** on the Main interface, to display the menu bar.
2. Click on settings.
3. Click on "Connectivity" -> "Hotspot"
4. Turn on the "Hotspot" function
5. Enter Hotspot's username and password.
6. Hotspot can be used to transfer data from thermal imager to computer, via FTP protocols.

5.4.3 Bluetooth device pair

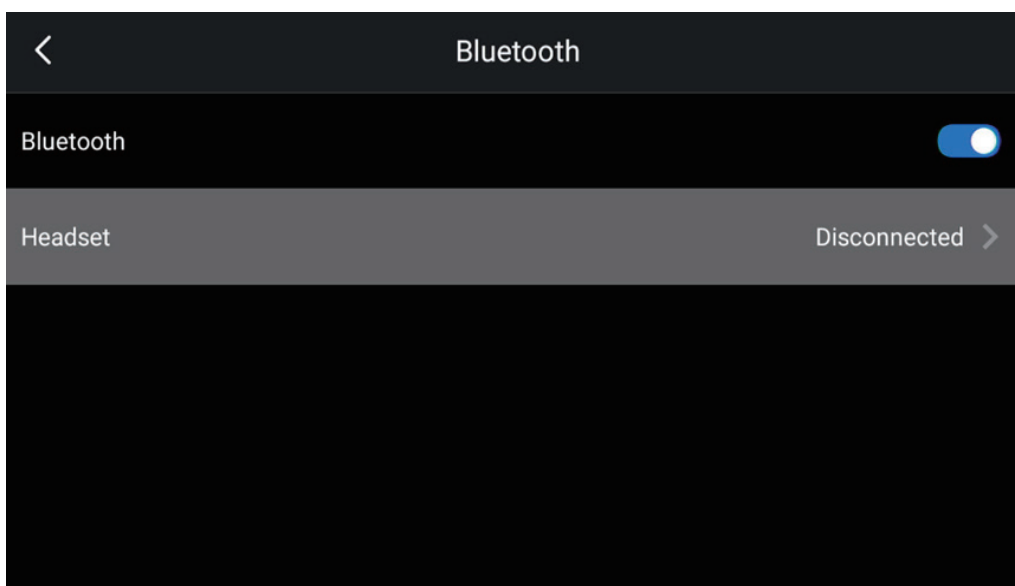

Thermal camera can be paired with Bluetooth devices, such as Bluetooth headset, which can be used for voice annotation.

When paired with Bluetooth, the thermal camera's Mic will be deactivated.

5.4.4 WLAN-FTP Transfer

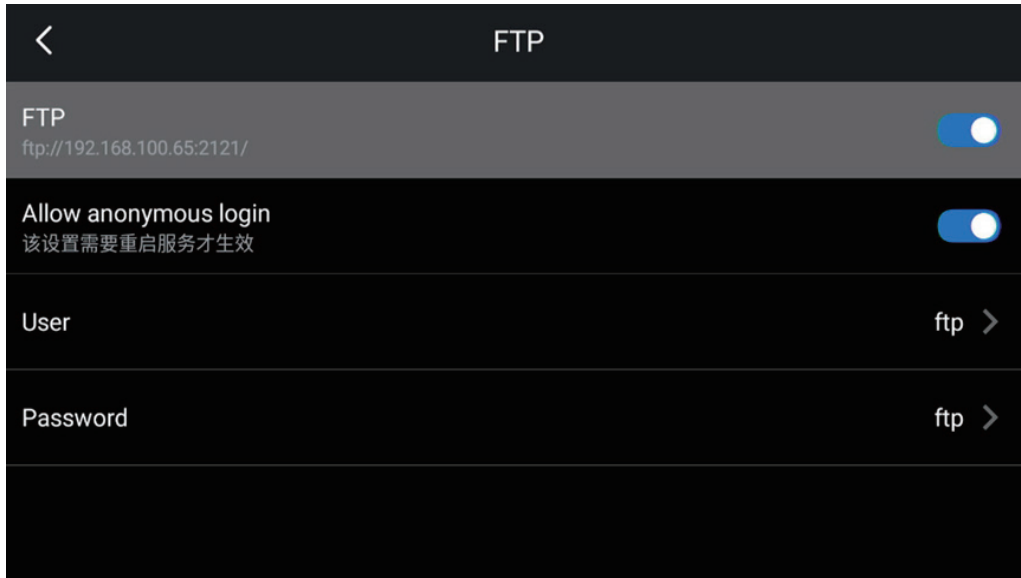

1. When the FTP Transfer function is turned on, the thermal camera's storage data (TF card) can be transferred to a computer via FTP protocols.
2. Click on – "Settings" – "Connection" – "FTP Transfer"
3. Connect a computer and thermal cameras to the same WLAN network, or connect the computer to a hotspot, and then turn on FTP Transfer.
4. When successfully connected, an address will be generated: ftp://IP:+port. Users can access the address from a web browser, file explorer, or FTP tools to transfer data.
5. Users can choose to turn on/off anonymous access. If it's turned on, the client can access the FTP service and file system without extra validation.
6. If anonymous access is turned off, the clients must have pre-set user name and password to access the file system

Note! When using FTP Transfer, the computer and thermal imager must be connected to the same WLAN Network, or via hotspot function.

5.5 Temperature Measurement Range

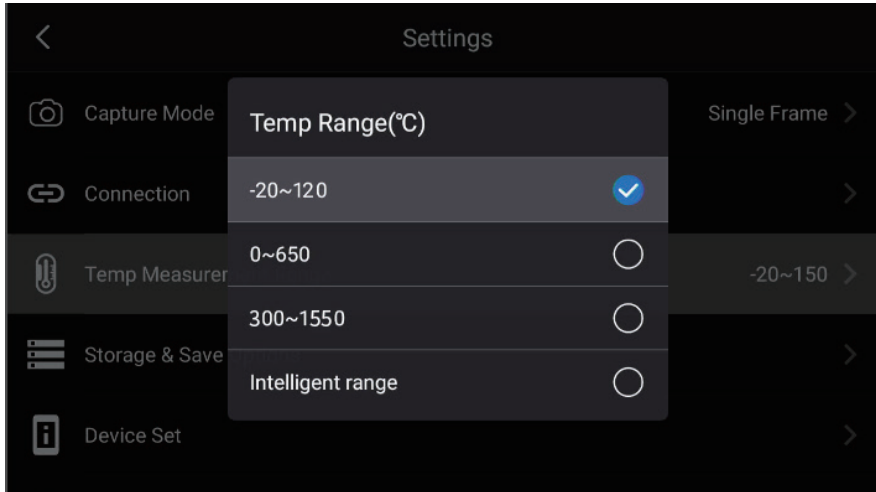

There are two principles to select the temperature range: Firstly, the temperatures of the measured object must be within the range, the second is to select as small a range.

The Intelligent range is recommended. It can automatically adjust the temperature measurement range according to the current temperature of the measured object.

5.6 Storage & Save Options

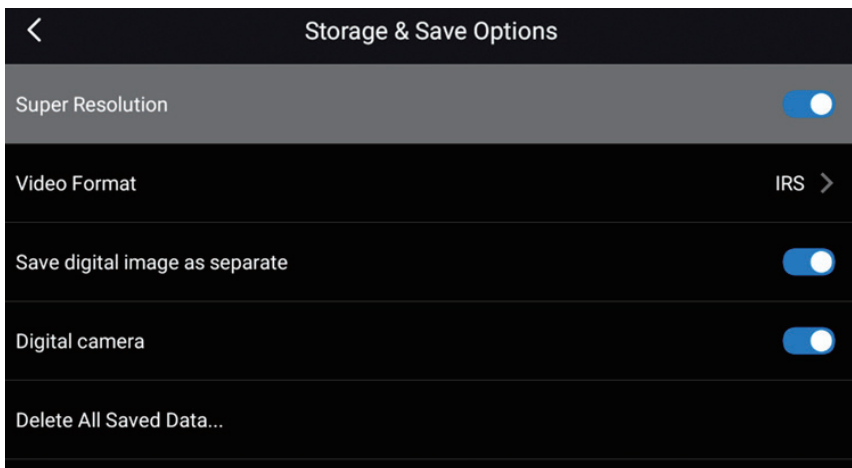

- Super Resolution: In SR mode, the pixels of the thermal image is be four-times than the default. Super resolution is not supported for video recording and Time-lapse Capture.

- Video Format: The available options are:

MP4 (* .mp4): MP4 file, which can be played but cannot be edited and the user's operation activities will be recorded at the same time.

IRS file (.IRS): Full-radiation video file can be analyzed and edited. This file does not contain any visual light information.

- Save digital image as separate: For thermal Image Mode, Picture-in-Picture Image Mode, and T-DEF Mode, the visual light digital image is default saved inside the same file of the thermal image's. Enabling this option will save the digital image as a separate JPEG file.

- Save distance measurement(available for 340A series):

This option defines whether to use a laser distance meter to measure distance when saving an image. If this option is activated, the measured distance will be used to automatically update the object distance parameter in the image data (It has no effect on the object distance setting in real-time mode.)

- Digital camera: If the digital camera is turned off, only the thermal imaging mode can be used and the the visual light images can't be taken.

- Delete all saved Data: Permanently delete all files (images and videos) saved in the memory card.

5.7 Device Set

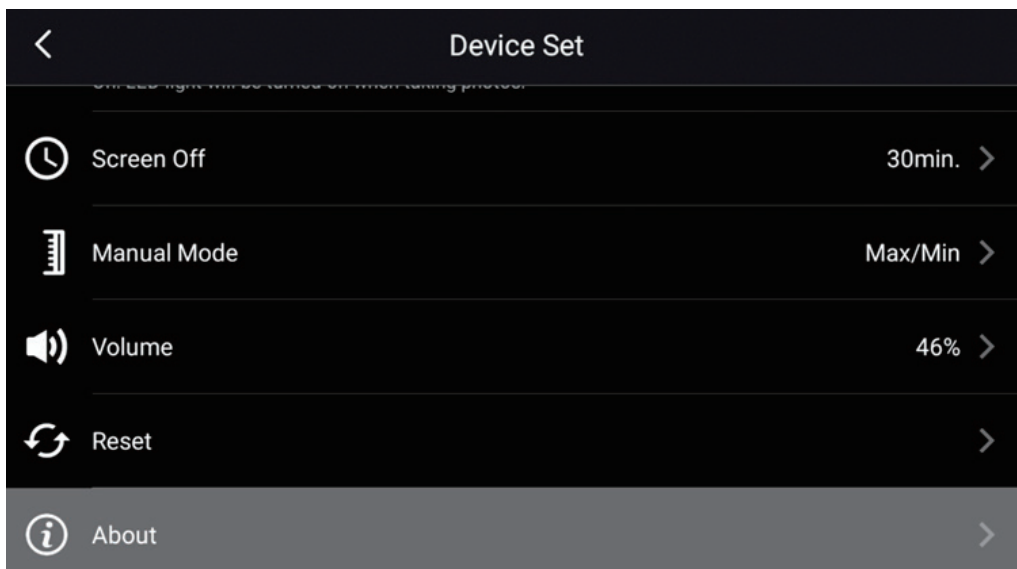
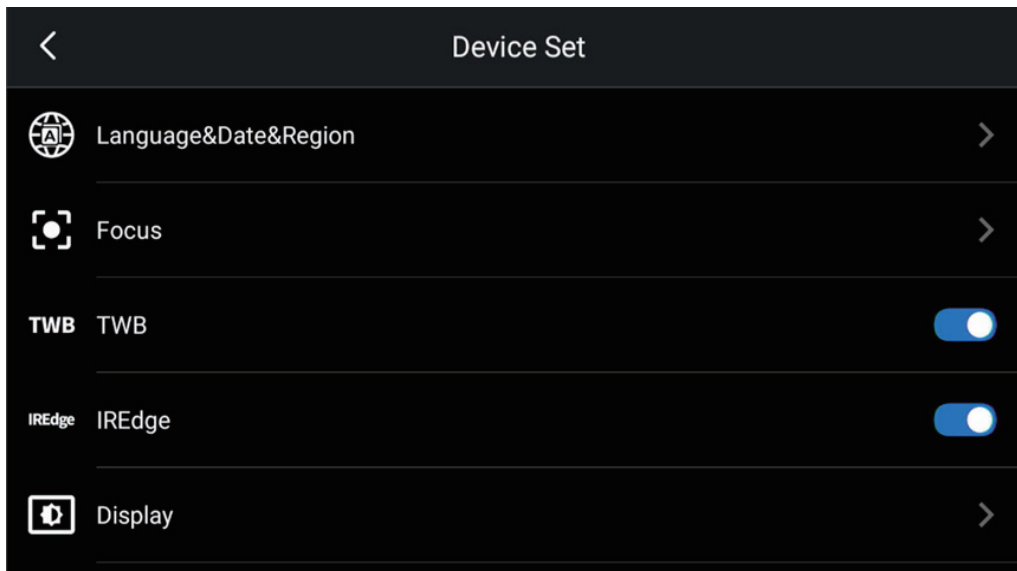

5.7.1 Unit, Language, Time and Regional Settings

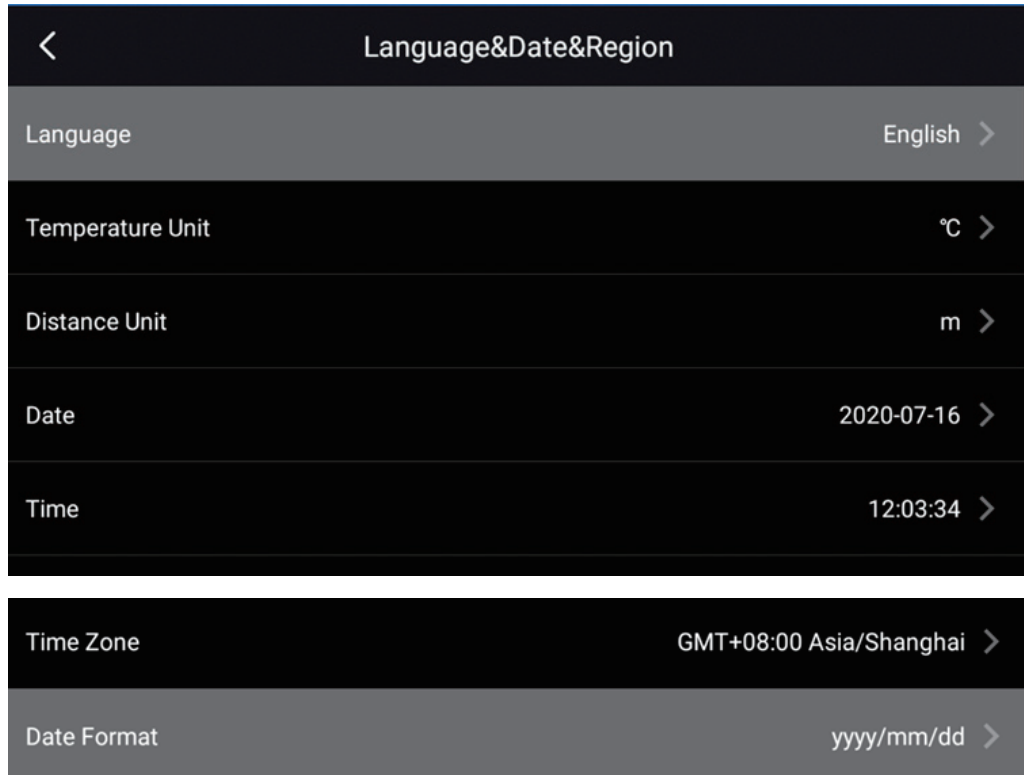

- Language& Date& Region : Contains the settings of multiple parameters: language, temperature unit, distance unit, date, time, time zone, date format settings.
- Language: English

- Temperature unit: °C, K, °F

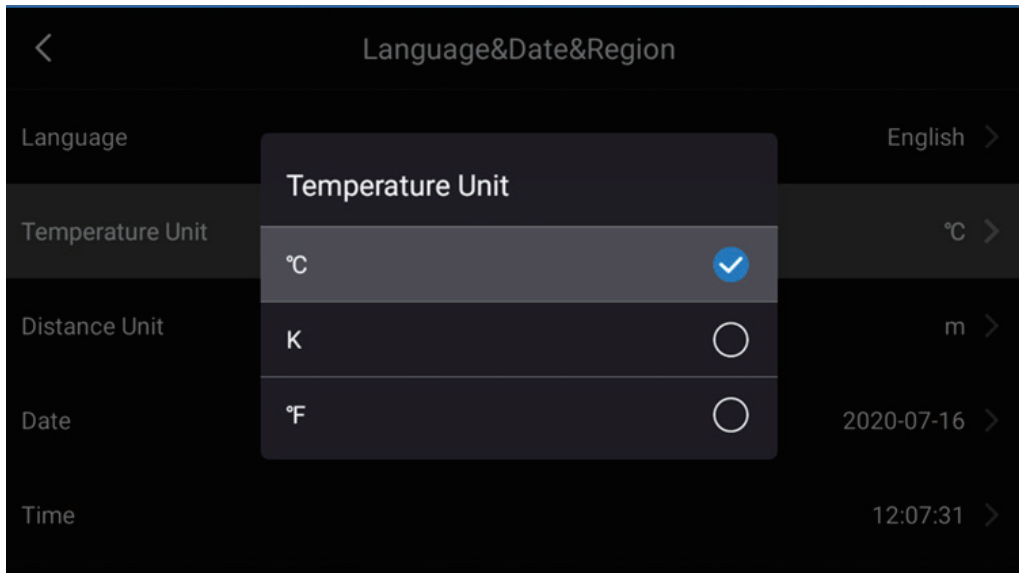

- Distance unit: m, ft.

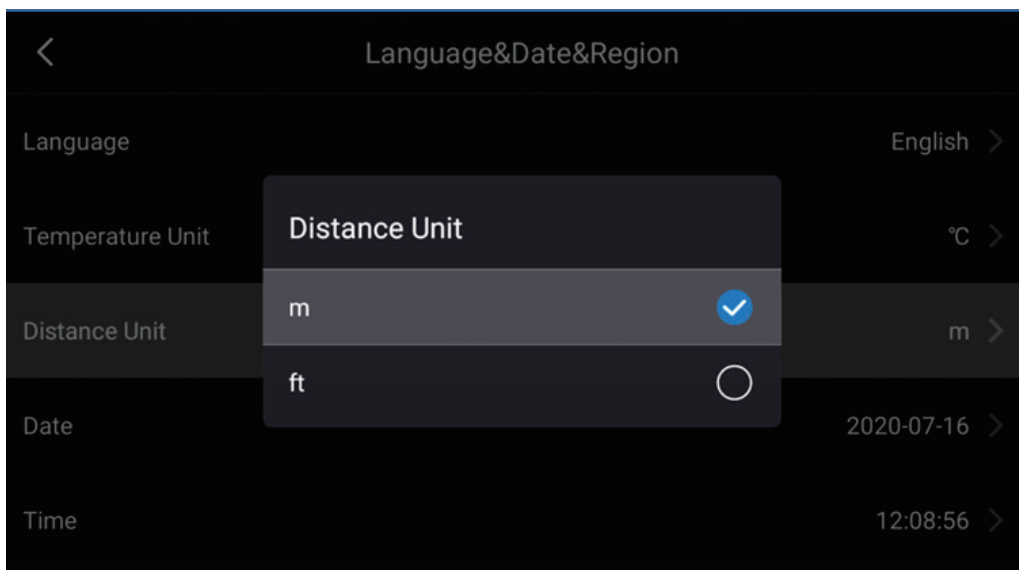

- Date

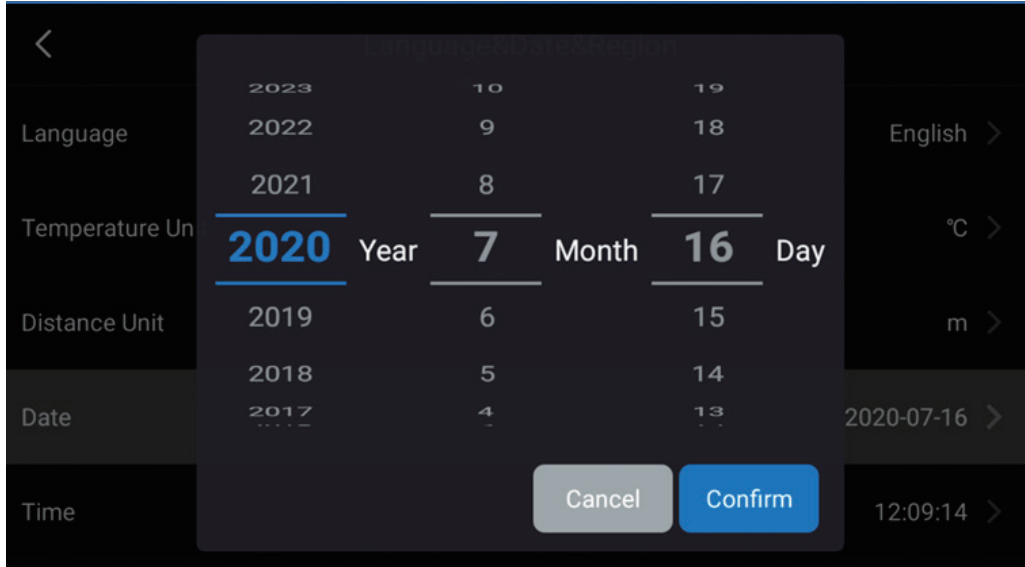

- Time

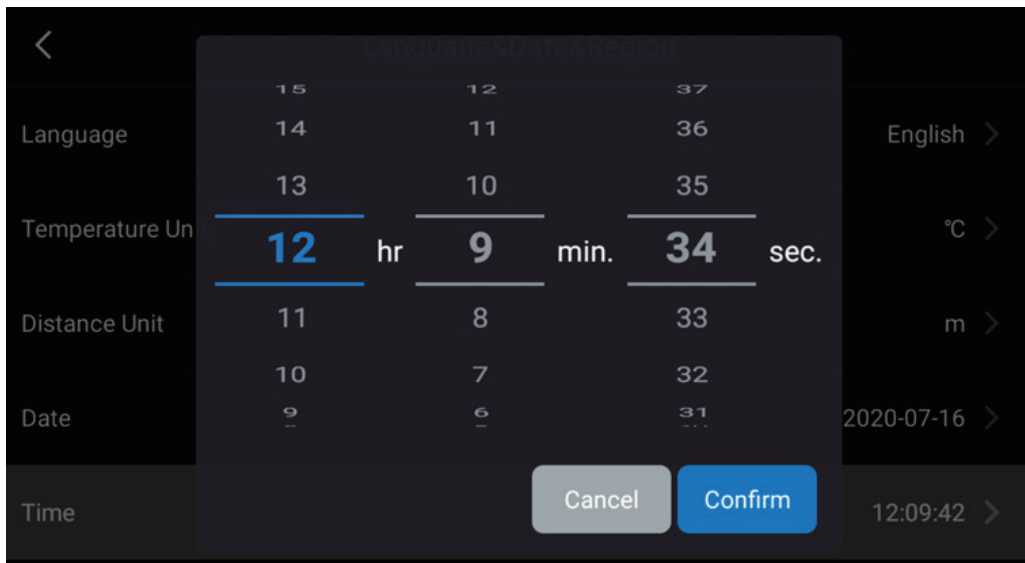

- Time zone

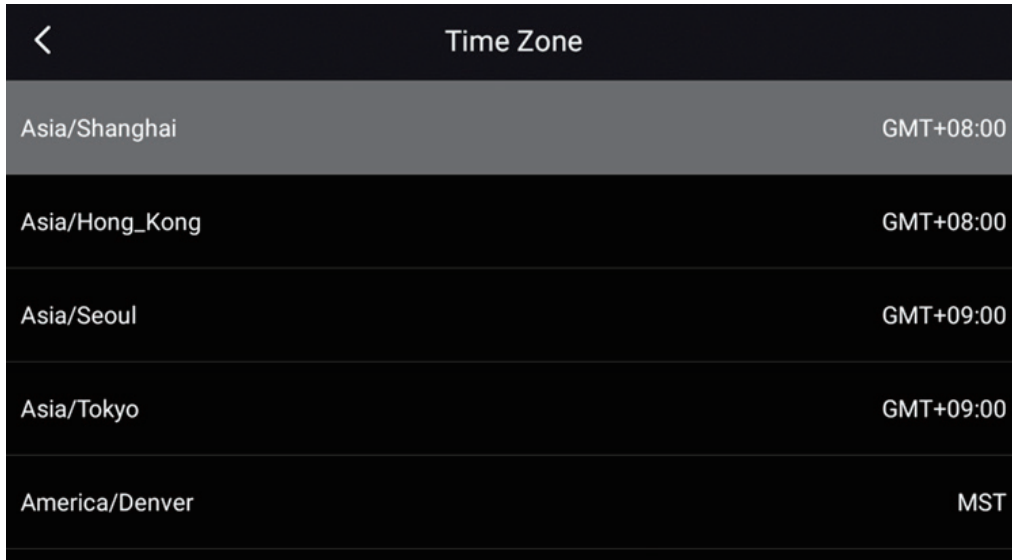

A screenshot of the 'Time Zone' settings menu. The title is 'Time Zone' with a back arrow on the left. The menu lists five time zones with their corresponding offsets:

Time Zone	Offset
Asia/Shanghai	GMT+08:00
Asia/Hong_Kong	GMT+08:00
Asia/Seoul	GMT+09:00
Asia/Tokyo	GMT+09:00
America/Denver	MST

- Date format

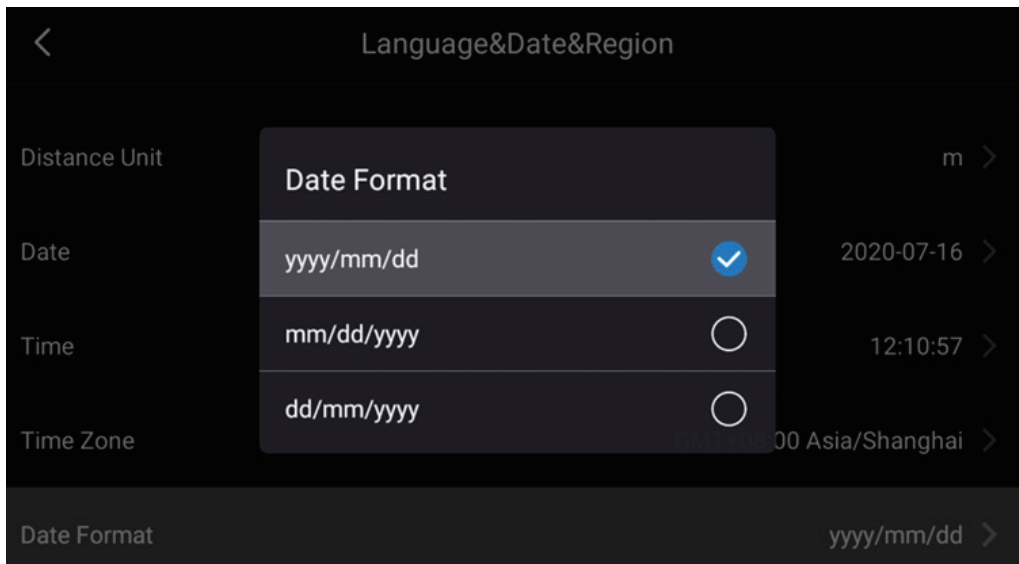

5.7.2 Focus Settings (available for 340 A series)

- Focus: contains Autofocus using contrast (focusing will be based on maximizing image contrast) and Autofocus using laser meter (focusing will be based on laser distance measurement, and the laser will be on when the thermal imager is in Autofocus).

Continuous Autofocus (available for 340 A series)

- Enable / disable continuous Autofocus. The thermal imager will automatically detect the movement after turning it on. When the camera stops moving, it will automatically focus without pressing the focus button.

5.7.3 Display Set

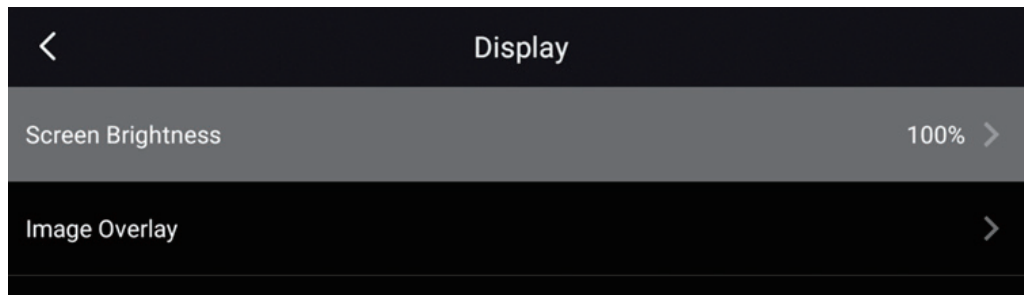

- Display settings: including screen brightness setting and image overlay information.

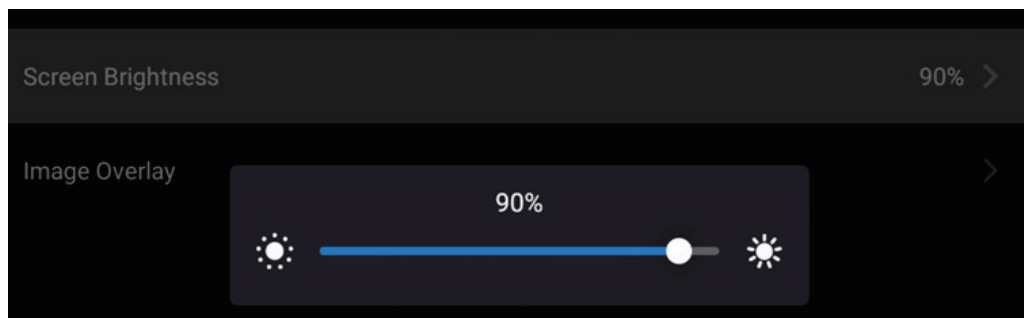

- Slide to adjust screen brightness

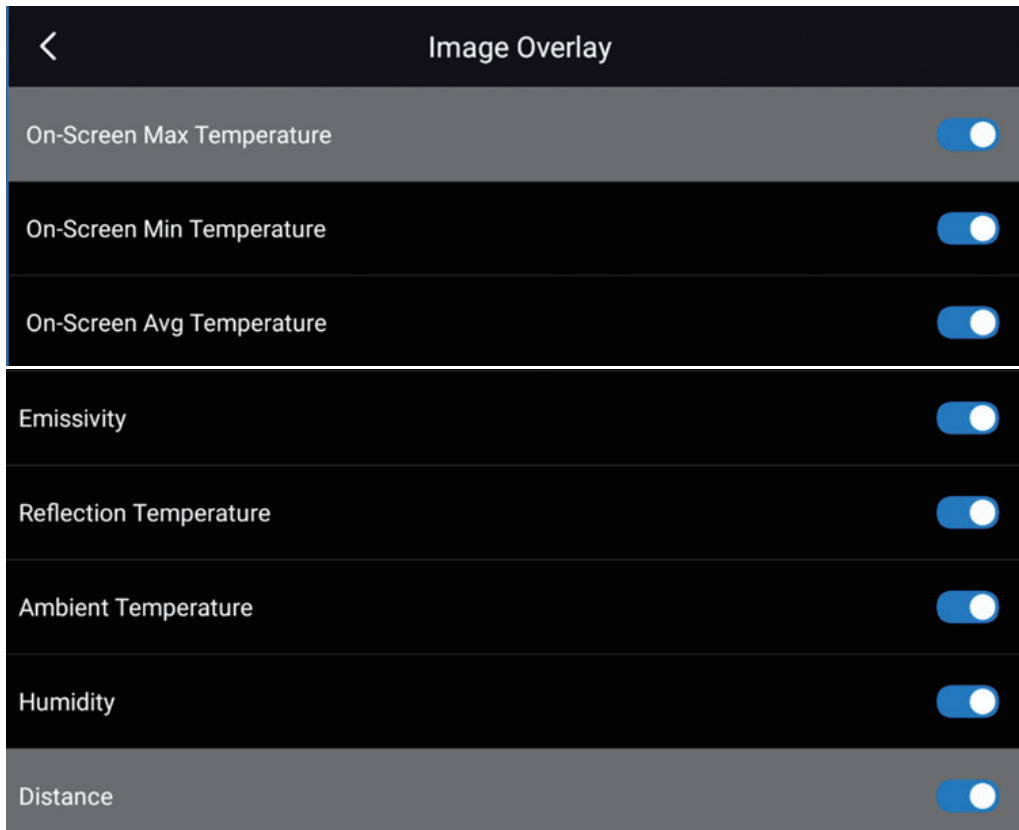

- Image overlay information includes: On-screen maximum temperature, On-screen minimum temperature, On-screen average temperature; emissivity, reflected temperature, ambient temperature, humidity, distance, etc. This setting is used to specify what information is overlaid on the screen. All image information is always saved in the image file.

5.7.4 Location

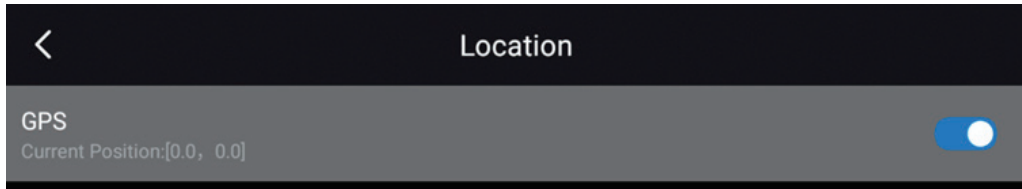

GPS: Enable / disable GPS.

5.7.5 LED Lamp as Flash

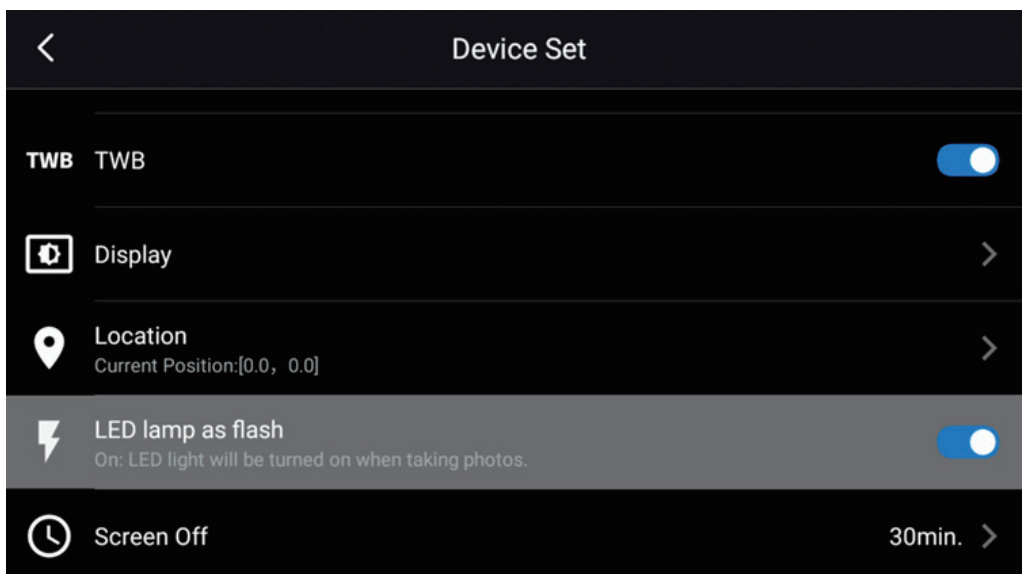

The thermal imager's LED lamp can be used as a flash for digital cameras. After the flash function is enabled, the LED lamp will be turned on when press the trigger button.

You can also turn on the LED of the thermal imager in the swipe-down menu.

5.7.6 Screen Off

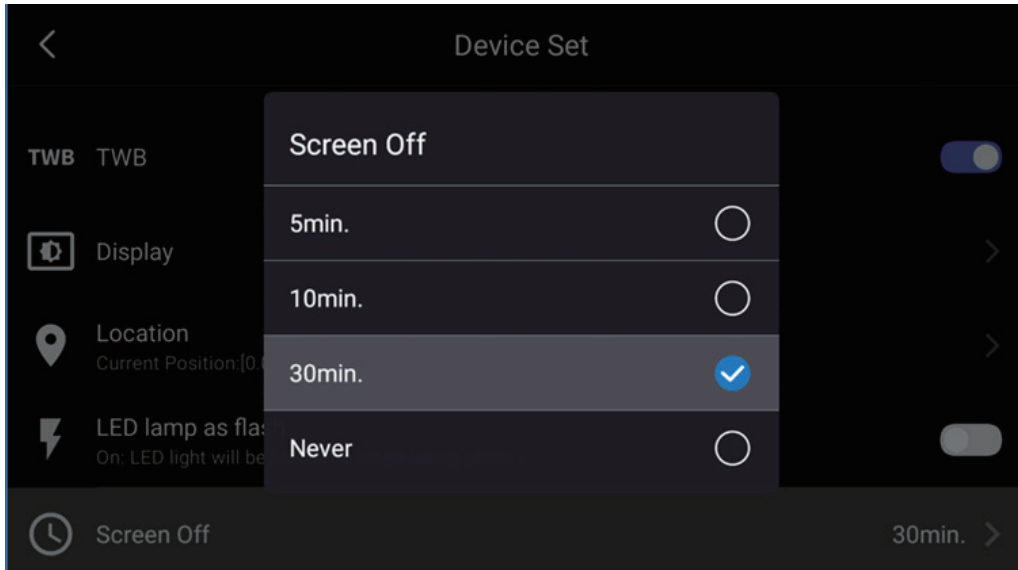

- Screen-off time: It is a timer for screen-off after not operate the thermal imager. Options include 5 minutes, 10 minutes, 30 minutes, and permanent.
- In screen-off mode, click the thermal imager's power button to wake up the screen. When using the thermal imager, you can also enter the screen-off mode manually by click the power button.

5.7.7 Manual Mode Settings

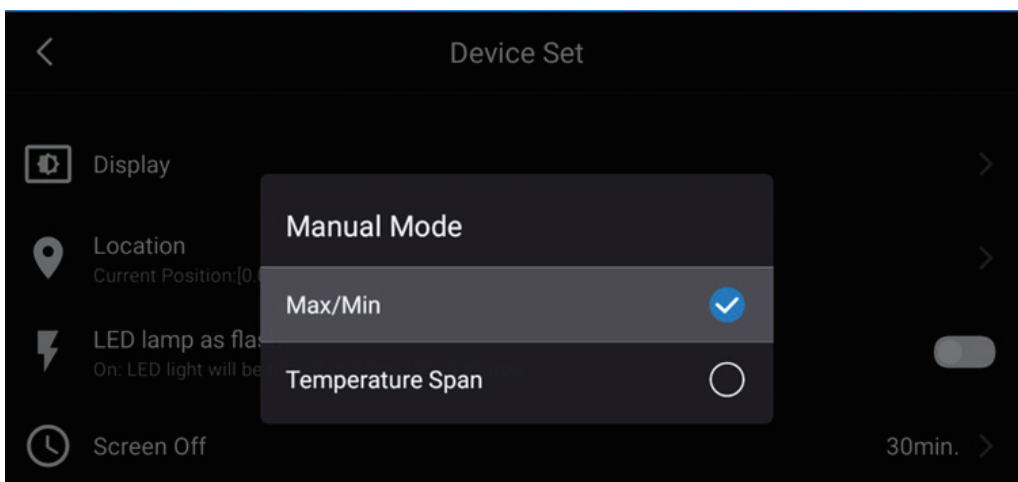

- Manual Mode, Manual Temperature Scale Adjustment Mode
- In the Maximum / Minimum Mode, the upper and lower limits of the temperature scale range can be set separately or together.
- In temperature span mode, the upper and lower limits of the temperature scale range can only be adjusted at the same time, and cannot be adjusted separately. The default temperature range is set to 4 °C.

5.7.8 Volume

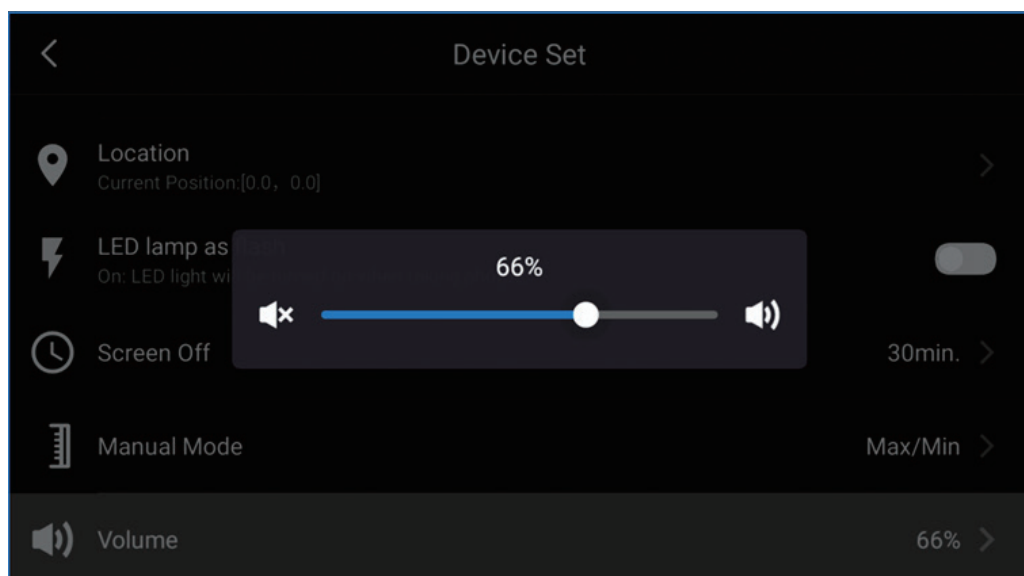

- Volume adjustment.
- You can set the volume by sliding or tapping the screen volume bar.

5.7.9 Reset

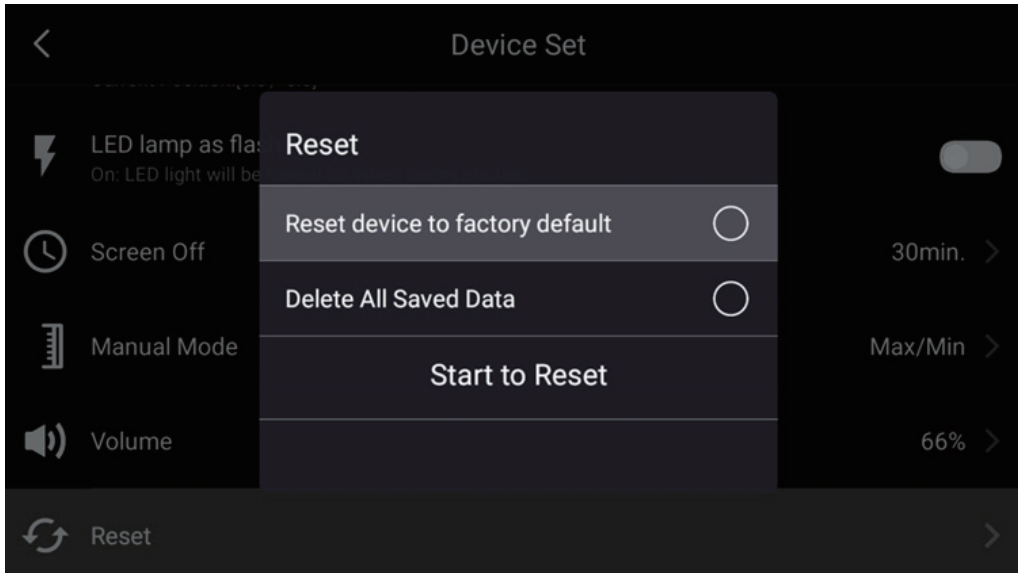

- Reset options: Reset parameters to factory default settings, or delete all saved data.

5.7.10 Thermal Imager Information

About	
Model	Fotric 348A#L25
Serial Number	Z1C5L6M1009
Software Version	V2.0.13
System Version	5.0.6.13
Operation System Version	2.0.4.12

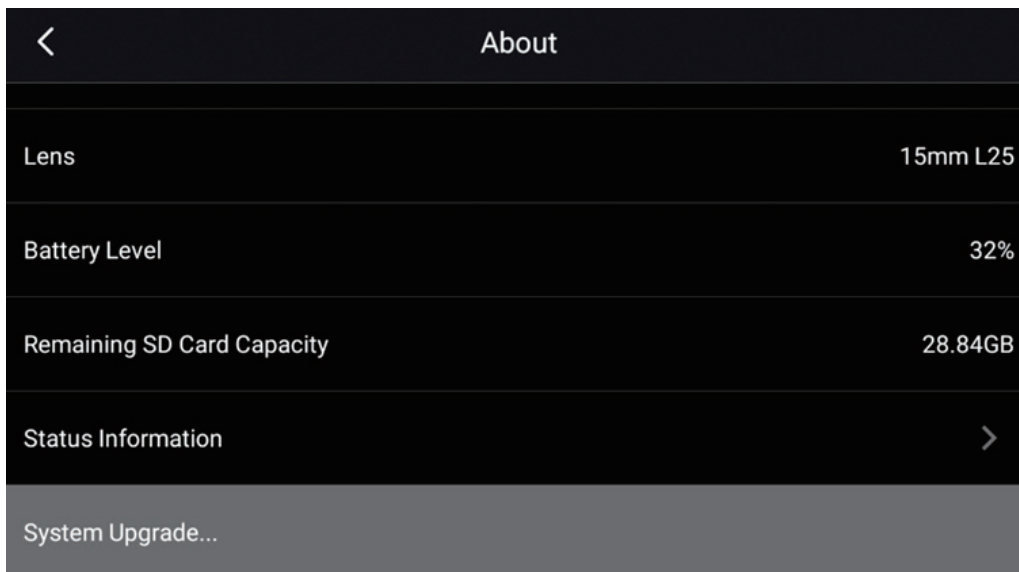

- Thermal imager information: thermal imager model, serial number, software version, system version, operation system version, sensor, lens, battery level, remaining SD card storage, status information (IP address, Mac address) and system upgrade..

Image Freeze Interface

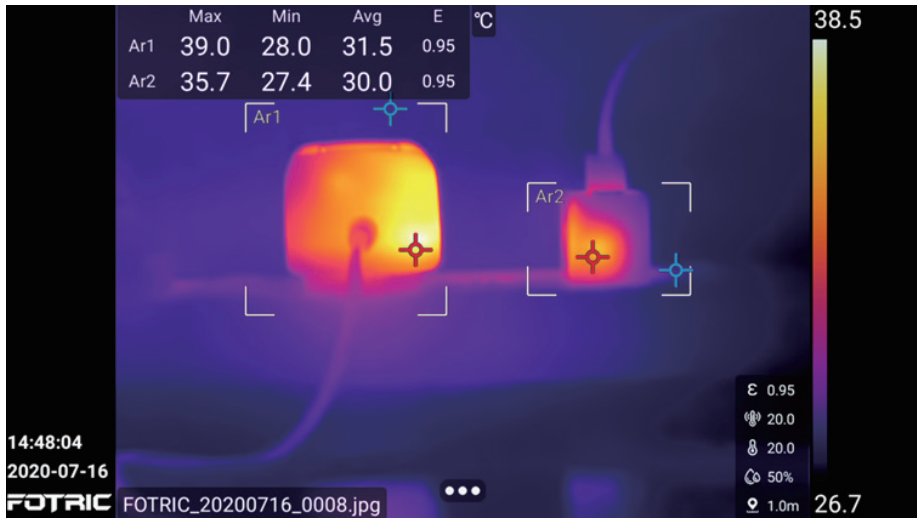

On the Image Freeze Interface, the image can be edited or added more information before save. Press the capture button again to save the image.

Press "Back" twice to exit the Image Freeze Interface without saving the image.

The Image Freeze Interface function is not available in Visual light digital camera image mode.

Click on  to display the Image Freeze Interface.





Favorite button. The favorite files can be filtered in gallery;



Temperature scale set button. For details, see 4.5 Temperature Scale Mode.



ROI measurement tool. For details, see 4.8 ROI measurement tool.



Voice annotation.



Text annotation.



Tag.

6.1 Favorite



1. Click on the favorite button and a favorite mark will be displayed on the upper left corner of screen.
2. In gallery, you can click on the favorites to filter all the favorite image files.

6.2 Voice Annotation

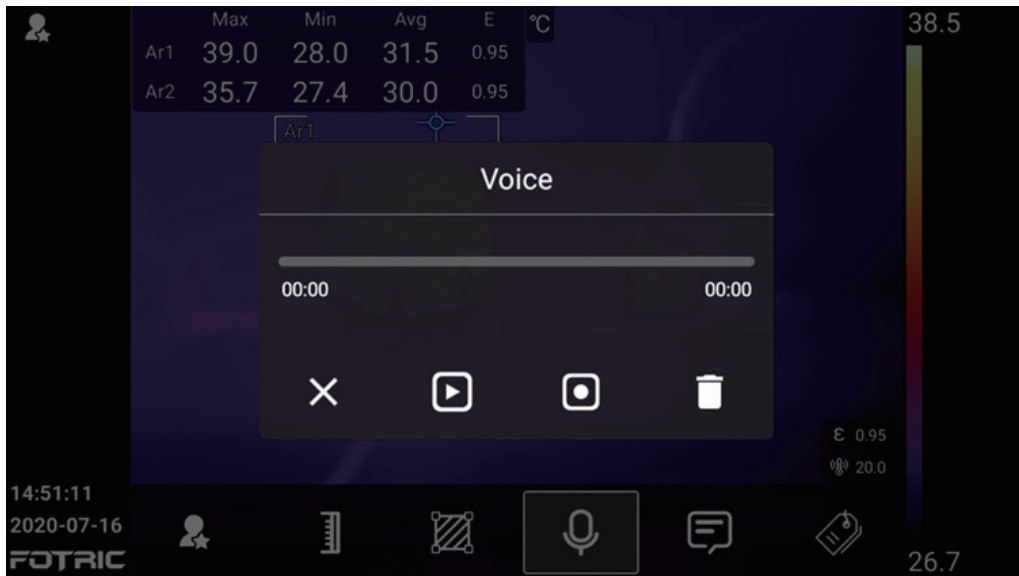

The voice annotation supports 200-second voice recording and is recorded in the image file. It can be played in the gallery or in PC software.

 Close

 Play

 Record

 Delete

6.3 Text Annotation

 Text annotations can be added in the thermal image file by the virtual keyboard on screen.

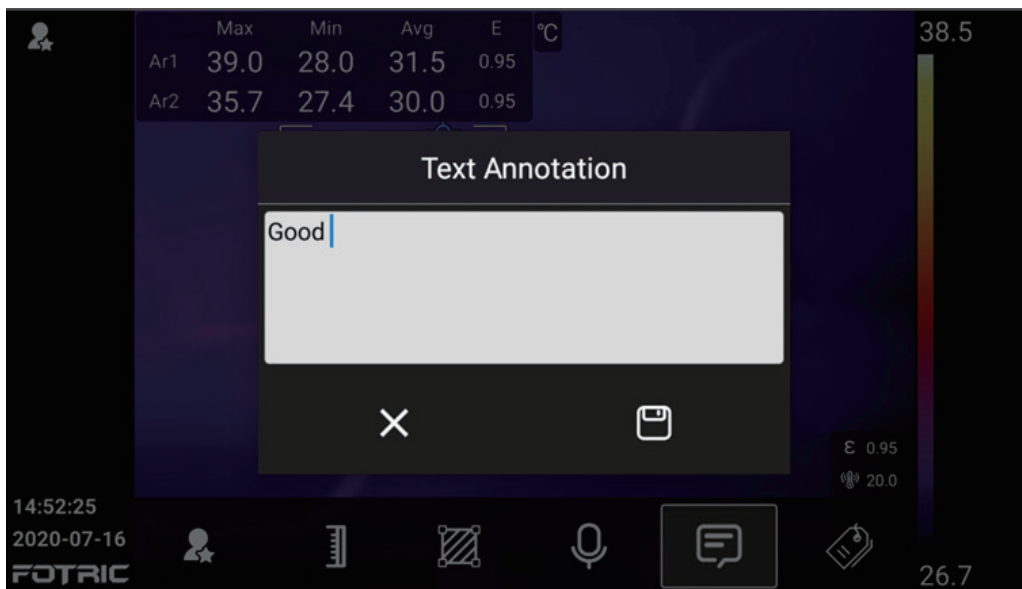

 Close

 Save

6.3.1 Keyboard Input

To add text annotations with virtual keyboard, please perform the following steps:

1. Click on the text box and switch to the appropriate text input method.
2. After entering the text information for notes, click on the area outside the text box to exit the text input keyboard.
3. Click on the Save button to save the text information.

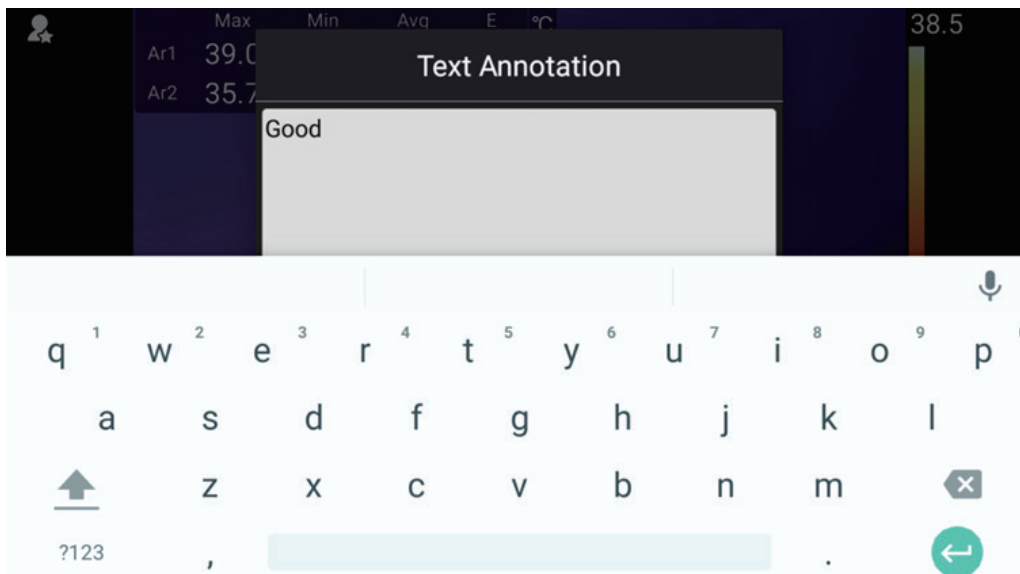

6.4 Tag

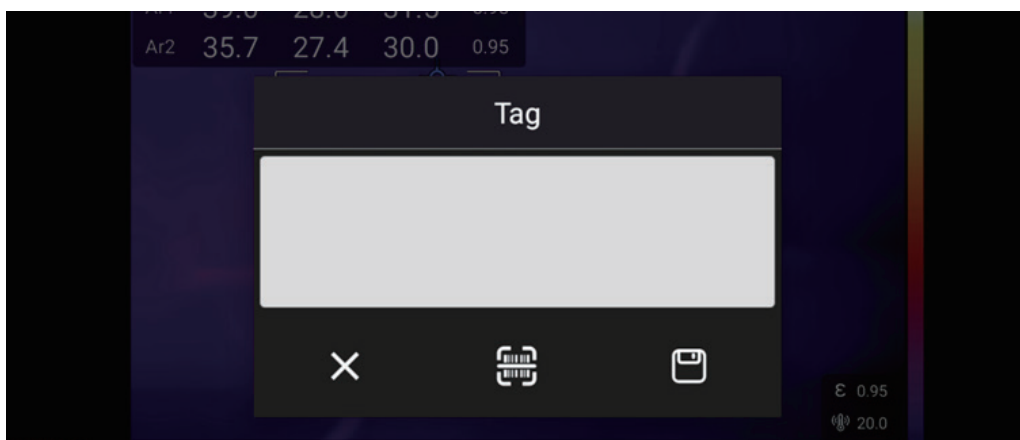

The automatic tag function can be performed by QR code scan and manual keyboard input.



6.4.1 Keyboard Input

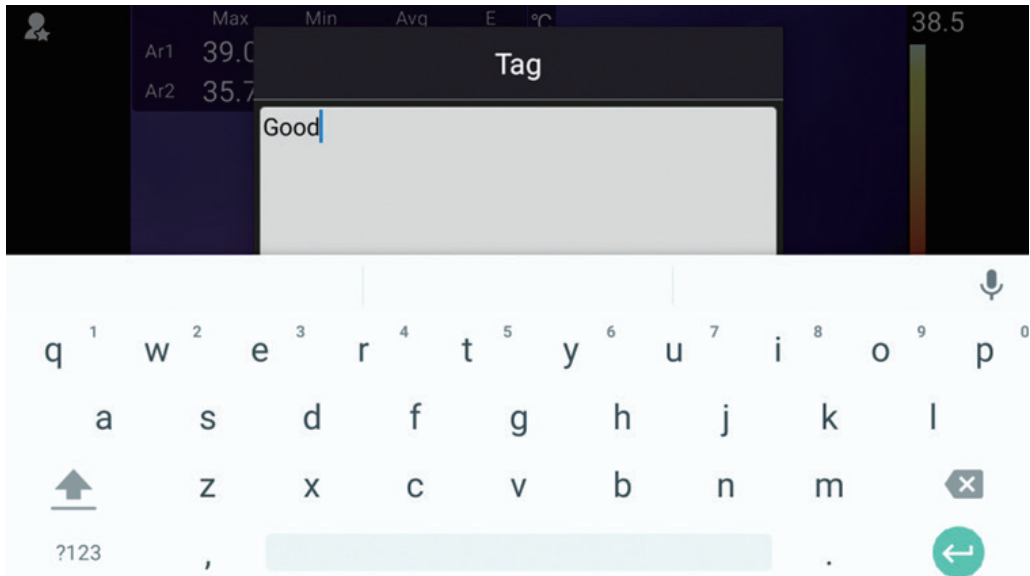



Same descriptions as Section 6.3.1 Keyboard Input

6.4.2 QR Code Scan

Click on  to enter the QR code recognition function;

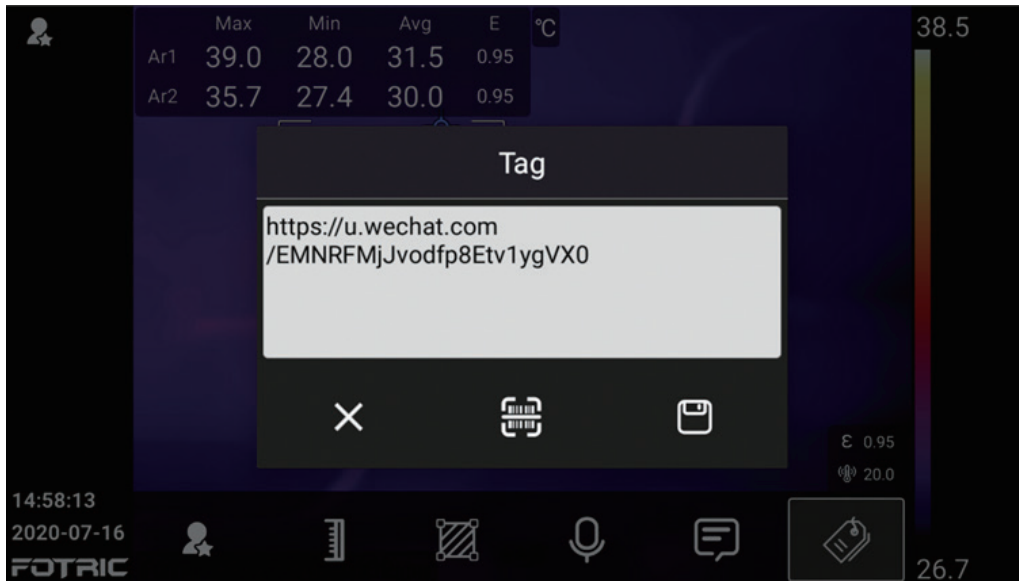





1. Click on  and align to the QR code to be scanned.
2. QR code content will be displayed.
3. Click on Save to save the content. The tag mark will be displayed appears on the upper left corner of the image.

Gallery

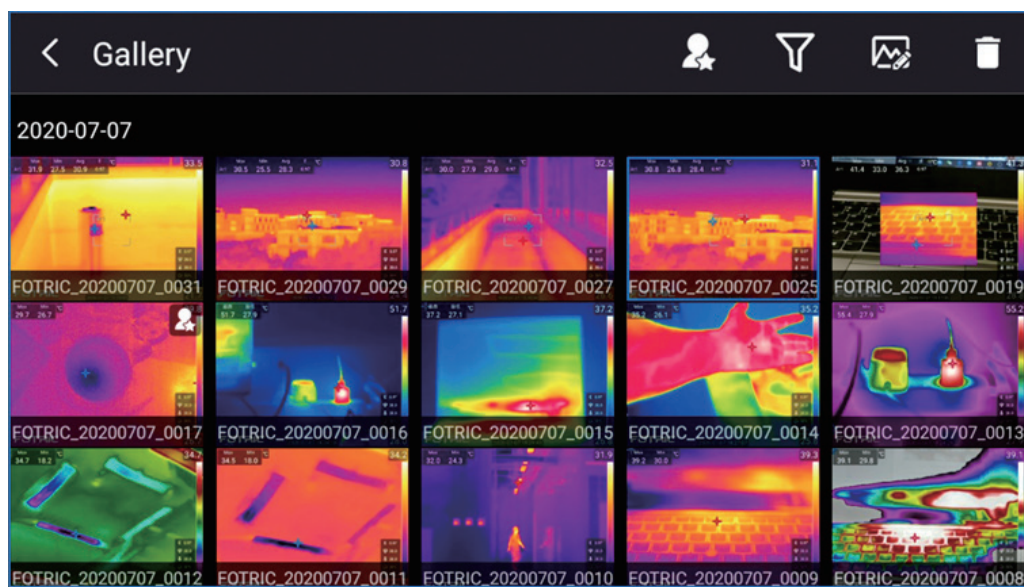
The images are saved in the SD memory card which can be viewed in the gallery. Click the Gallery button to open the gallery. Image files are grouped by date, as shown in the figure below. The images can be switched by clicking on the left / right and the up / down keys, and be selected to analyze or playback. To return to the live image, click on the "Back" button.



 Filter favorite files

 Filter tag files

 File analysis

 Delete

7.1 Favorites and Filters

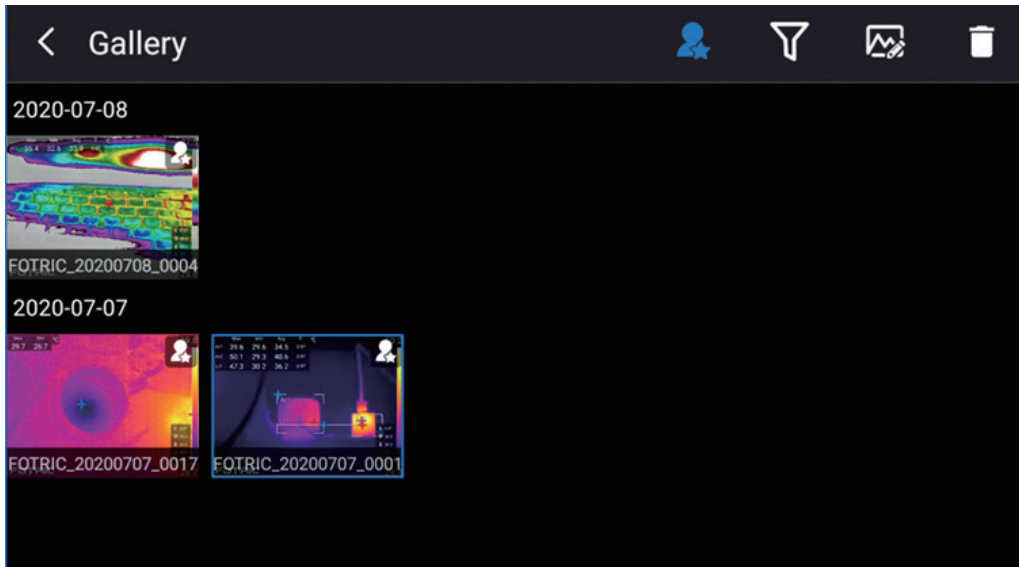

Click on  Favorites icon to filter all favorite files. For details on adding to the favorites, see 6.1 Favorite.

7.2 Filter Tag

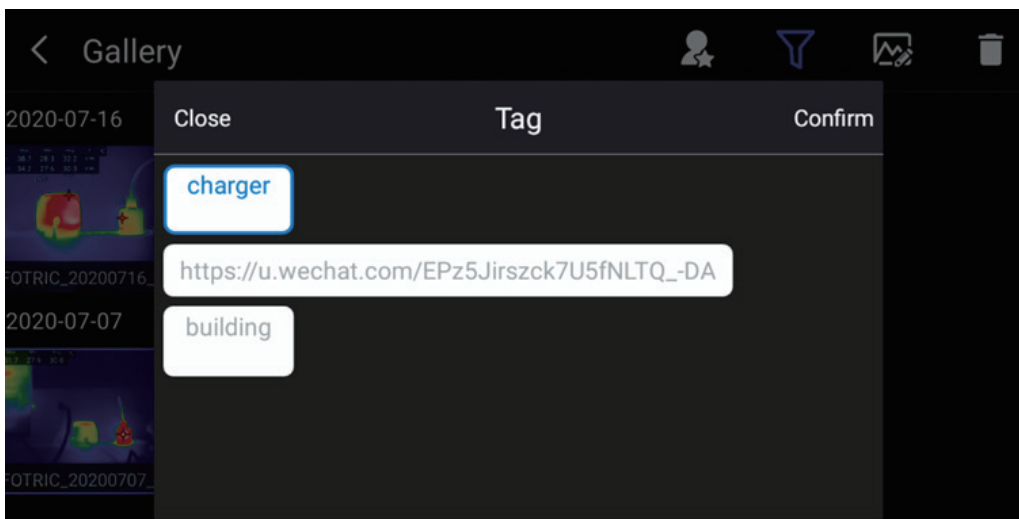

Click on  to enter the tag filter interface;

Select the tag to be filtered and click Confirm to filter the files with this tag.

For details on adding tags, see Section 6.4 Tag

7.3 Opening Image and Video Files

The image files in the gallery include thermal images, visual light digital images, videos, and burst images.

Click on  to open the thermal image file and enter the analysis interface, open the thermal image file through the following operations:

1. For thermal images, picture-in-picture images, and T-DEF images, open the analysis interface to view, analyze or delete.
2. For visual light image, open the analysis interface to view or delete.
3. For IRS full-radiation video files, open the analysis interface to view the temperature information.
4. For MP4 videos recorded in full screen, opened to playback.
5. For burst images which are shown as a group. , enter the burst image interface to view, analyze and delete on each image separately.

7.4 Thermal Image File Analysis

Visual light images can only be viewed, while thermal image files, picture-in-picture files, and T-DEF image files can be opened for analysis as below:

Open the thermal image file in the gallery and enter the thermal image file analysis interface. Click on  to open more functions.

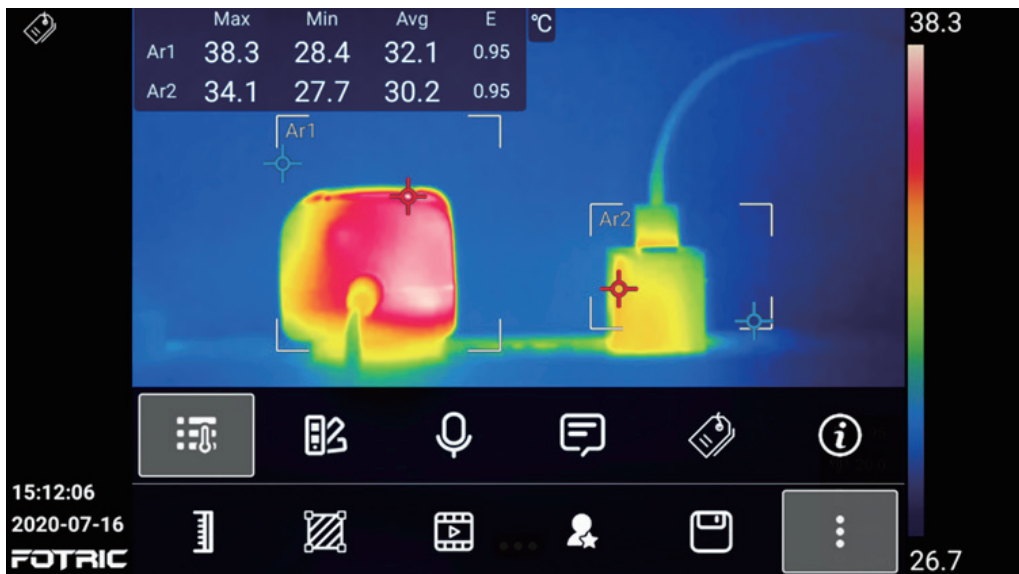

 Temperature Scale mode, see Section 4.5 Temperature Scale Mode for details;

 ROI measurement tool, see Section 4.8 ROI Measurement Tool for details;

 Image mode, can be switched to thermal image, digital camera, picture-in-picture, or T-DEF image;

 Favorites, see Section 6.1 Favorite;

 Save;

 More options;

 Measurement parameters, see Section 4.6 Measurement Parameter Settings for details;



Palette, see Section 4.10 Palette for details;



Voice annotation, see Section 6.2 voice annotation for details;



Text annotation, see Section 6.3 Text annotation;



Tag, see Section 6.4 Tag;



Image's detailed Information, click to open.

7.4.1 Thermal Video File

While MP4 video files can only be opened for playback, IRS video files can be opened for analysis by following operations:

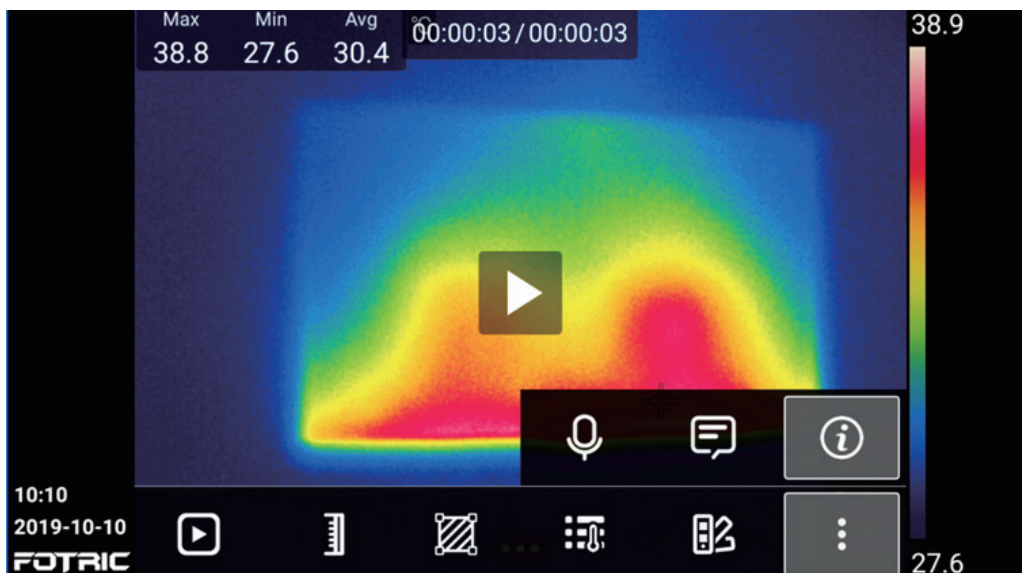

Play, click to play the video;



Temperature scale mode, see Section 4.5 Temperature scale mode for details;



ROI Measurement tool, see Section 4.8 ROI Measurement Tool for details;



Measurement parameters, see Section 4.6 Measurement Parameter Settings for details;



Palette, see Section 4.10 Palettes for details;



More options;



Voice annotation, see Section 6.2 voice annotation for details;



Text annotation, see Section 6.3 Text annotation;



Image's detailed Information, click to open.

7.5 Deleting An Image or Video File

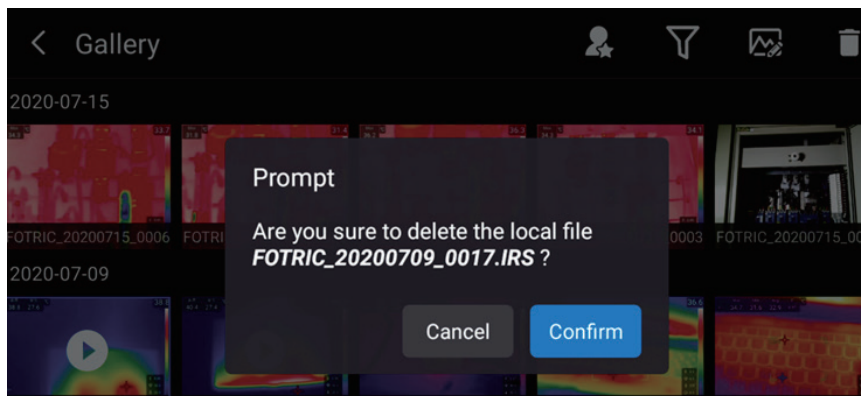

1. Click on the Gallery button to open the gallery.
2. Select an image, click on the Delete button.
3. Select Confirm to delete.

7.6 Deleting Multiple Files

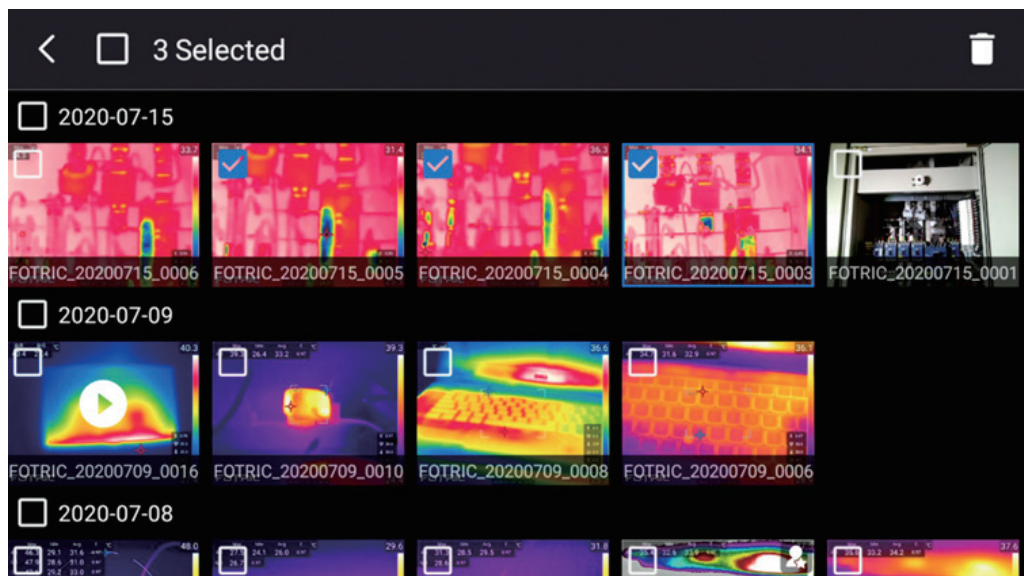

1. Long press one of the thumbnails, enter the multi-select mode. In the multi-select mode, you can select multiple files and then click on Delete button.
2. Confirm to delete the selected files.

Maintenance of the Thermal Imager

8.1 Cleaning the Camera Shell, Cables and other Components

Cleaning Procedures

Please use a soft cloth and pure water/Non-irritant cleaning liquid to clean.

Note:

Please don't apply corrosive or similar liquid on the Imager, cable or other parts. This might cause damages.

8.2 Cleaning the Infrared Lens

Cleaning Procedures

Please use professional lens cleaning cotton pad and liquid with an isopropyl alcohol concentration above 30%, or 96% ethanol (C₂H₅OH) to clean.

Note:

1. Lens cleaning cotton pad is a disposable item; do not reuse it.
2. Please be careful when cleaning the infrared lens. The lens has a precise anti-reflective coating.
3. Do not use excessive force to clean the infrared lens. This might damage the anti-reflective coating.

8.3 Cleaning the Uncooled Infrared Focal Plane Detector

Cleaning Procedures

Even a small amount of dust on the uncooled infrared focal plane detector may cause major defects in the image.

Please follow the steps below:

1. Remove the lens from the camera.
2. The compressed air produced by rubber bulb syringe can be used to blow off the dust on the surface of the uncooled infrared focal plane detector.

Do not use compressed air generated by pneumatic circuits in workshops and other places, because this air usually contains oily mist and will damage the detector surface.

Note:

1. This section only applies to thermal imagers where the uncooled infrared focal plane detector can be exposed by removing the lens.
2. In some cases, the dust on the surface of uncooled infrared focal plane detectors must be cleaned mechanically.
3. This mechanical cleaning operation must be performed by the FOTRIC customer service department or a service partner authorized by FOTRIC.

8.4 Maintenance of Lithium Battery

1. Do not expose the Battery close to heat sources or high-temperature environments , such as unattended vehicles in the direct sunlight.
2. Do not disassemble or squeeze the battery and battery pack.

3. Take out the battery from device when not use for long term.
4. Keep the battery and battery pack clean and dry.
5. Use only the power adapter approved by FOTRIC to charge the battery.

8.5 Operation Guide on Update FOTRIC 340 App

Notes:

The purpose of this document is to guide FOTRIC distributors or end-users on how to update the 340 thermal camera App.

The App update is not necessary unless regarding customized requirements or critical bugs fixed.

FOTRIC 340 Update Procedures

Step 1:

Turn on the thermal imager, and check if your device app's version. You can find it in "Device set"- "About" – "software version."

Please tap on the screen, tap the "software version" version number.

About	
Model	Fotric 348A#L25#L07
Serial Number	Z1S2K7A2070
Software Version	V1.4.1
System Version	5.0.4.50
Operation System Version	2.1.0.10

Step 2:

Connect the Thermal imager to the computer with Type-C to USB cable, or plug the imager's SD card and SD reader into the computer.

Step 3:

Copy the new software package (Ensure its name is falcon) into the SD card's main folder- the "update" folder. As shown below:

If this folder does not exist, please create one.

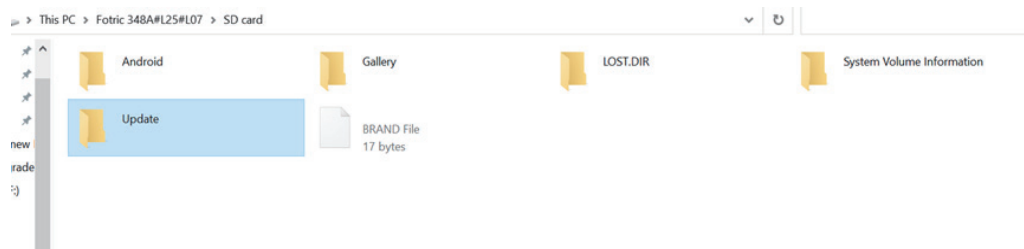

Step 4:

Tap on the thermal imager's screen, open "system menu"- "Settings"- "Device Set" -"About" -" System update"

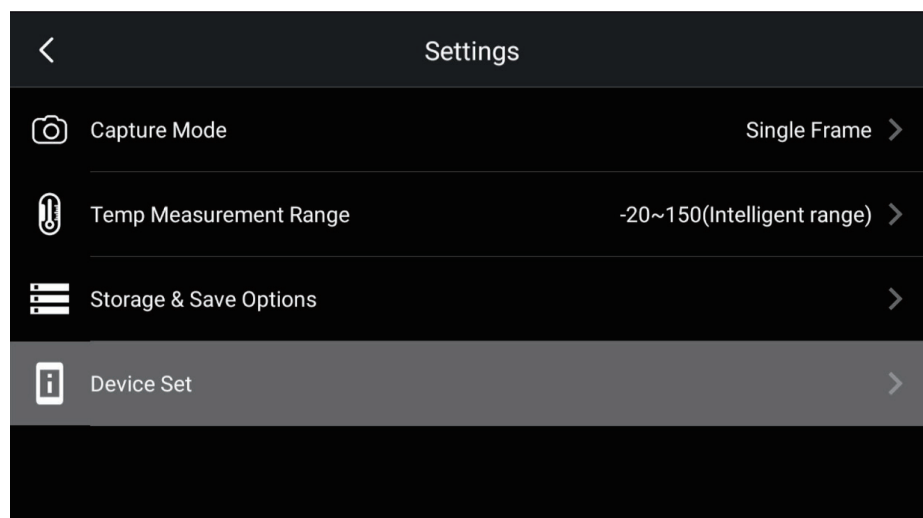

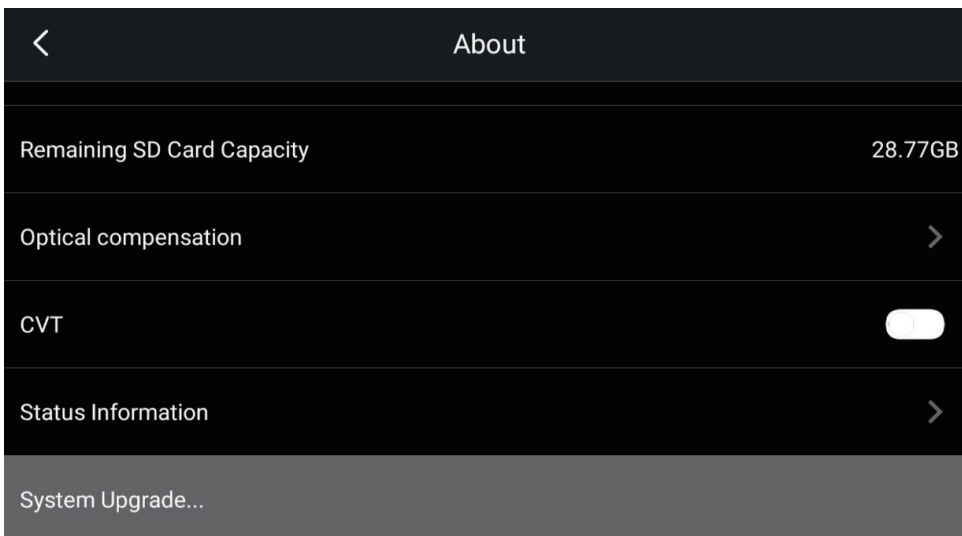
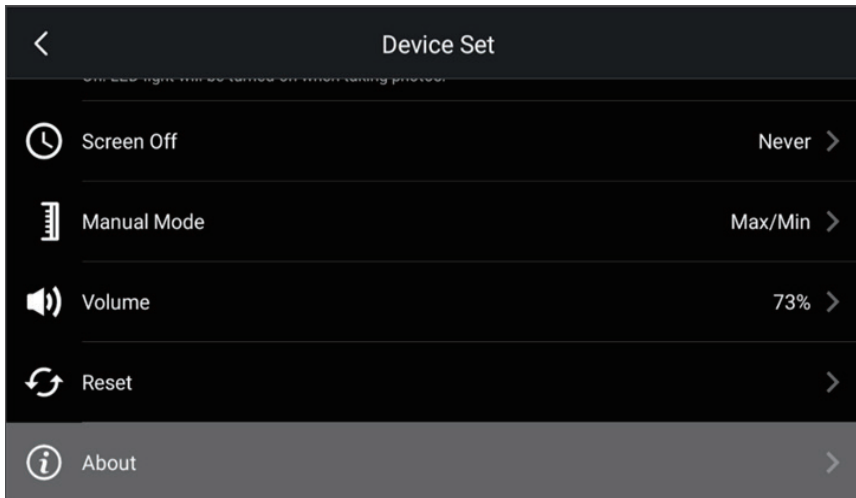

Step 5

Click "System upgrade" - "SD update"

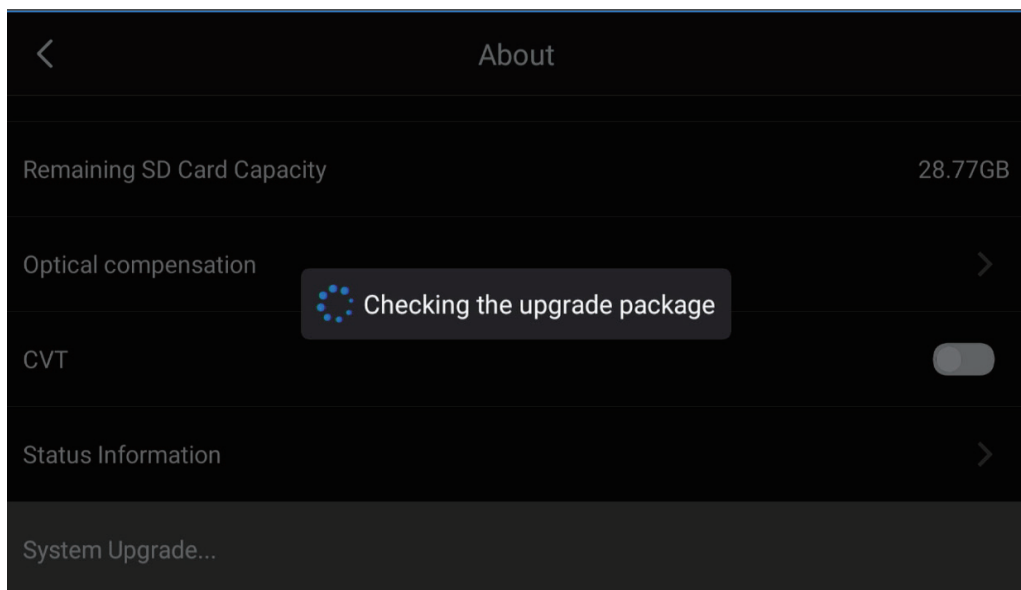
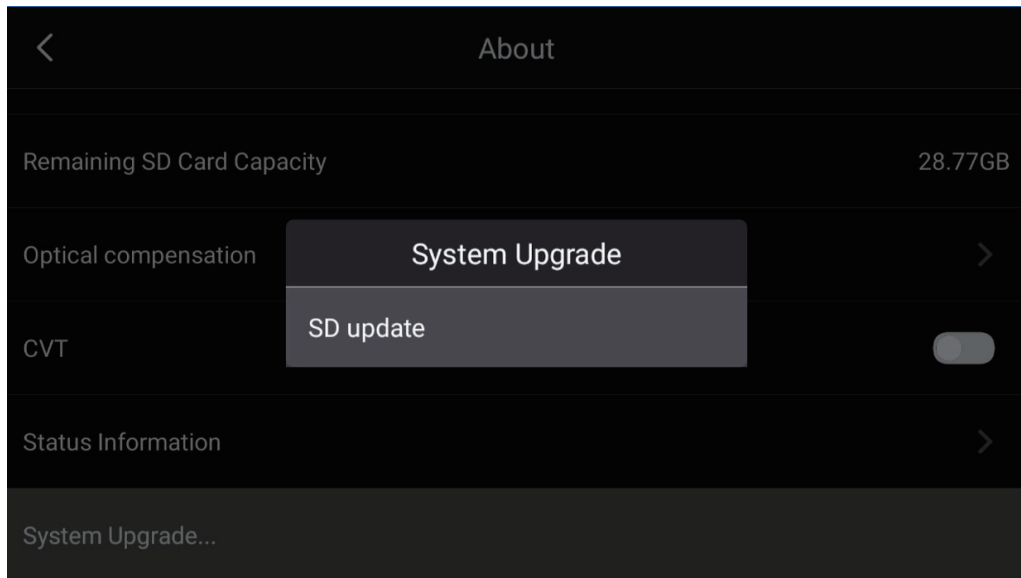

Step 6:

Click the blue color button "update" to update to the newer software version.

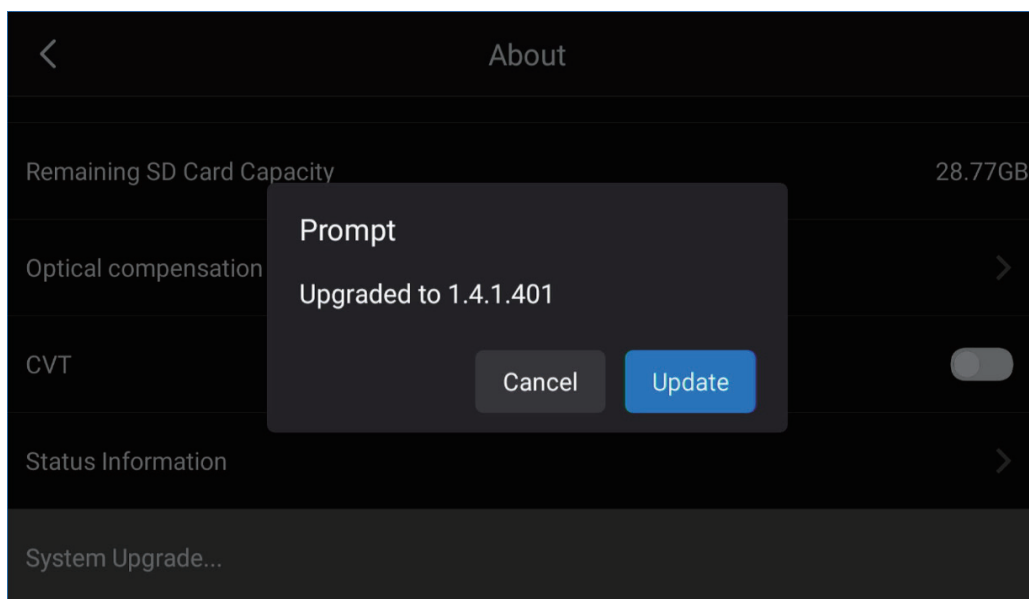

Step 7:

After the 340device display is back to Main Menu, you can recheck the software version from the "About" – "software version".

If the software version display is the same as the newest version, this update is successful. Now please kindly check if the 340 device is functional well after the update.

Laser

9.1 General

The laser distance ranger consists of a laser transmitter and a laser receiver. The laser distance ranger determines the distance to a target by measuring the time it takes for a laser pulse to reach the target and return to the laser receiver. This time is converted to a distance, which is displayed on the screen.

The laser receiver also works as a laser pointer. When the laser distance ranger is on, you will see a laser dot approximately at the target.

9.2 Laser warning label

A laser warning label with the following information is attached to the camera:



9.3 Laser rules and regulations

Wavelength: 635 nm. Maximum output power: 1 mW.

This is Class 2 Laser Product.

Complies with 21 CFR 1040.10 and 1040.11 except for conformance with IEC 60825-1 Ed. 3., as described in Laser Notice No. 56, dated May 8, 2019.

Caution: Use of controls or adjustments or performance of procedures other than those specified herein may result in hazardous radiation exposure.

Appendix

Emissivity Table

(For reference only)

Material Name	Surface Condition	Temperature (°C)	Emissivity (ϵ)
Aluminum	Non-oxidized	100	0.20
	Oxidized	100	0.55
Brass	Polished brown	20	0.40
	Unpolished	38	0.22
	Oxidized	100	0.61
Copper	Severely oxidized	20	0.78
Iron	Oxidized	100	0.74
	Rusty	25	0.65
Cast iron	Oxidized	200	0.64
	Non-oxidized	100	0.21
Wrought iron	Roughened	25	0.94
	Polished	38	0.28
Nickel	Oxidized	200	0.37
Stainless steel	Oxidized	60	0.85
Steel	Oxidized at 800°C	200	0.79
Common brick	Surface	20	0.93
Concrete	Surface	20	0.92
Glass	Polished plate	20	0.94

Lacquer	White	100	0.92
	Natural color black	100	0.97
Carbon	Smoke black	25	0.95
	Candle soot	20	0.95
	Graphite rough surface	20	0.98
Paint	Average of 16 colors	100	0.94
Paper	White	20	0.93
Sand	Surface	20	0.90
Wood	Polished	20	0.90
Water	Distilled water	20	0.96
Skin	Human	32	0.98
Pottery	Fine	21	0.90
	Abrasive	21	0.93

Innovation Excellence Integrity

Equipment described herein may require EU, US and UNSC authorization for export purposes.

Imagery for illustration purposes only.

Specifications are subject to change without notice.

FOTRIC INC. All Rights reserved.

Contact FOTRIC

CHINA

Lane 2500-14, Xiupu Road,
Pudong District, Shanghai,
P.R.China
+86 (21) 6698 1992

U.S.

+1 (214) 235-4544

✉ info@fotric.com

🏠 www.fotric.com

FOTRIC