



Franklin Electric
GRID SOLUTIONS

**CELLGUARD™ WIRELESS BATTERY
MONITORING SYSTEM
GEN III
INSTALLATION GUIDE**

The information in this publication is provided for reference only. While every effort has been made to ensure the reliability and accuracy of the information contained in this manual at the time of printing, we recommend that you refer to the appropriate website for the most current version of this manual. All product specifications, as well as the information contained in this publication, are subject to change without notice. Franklin Electric Co., Inc. does not assume responsibility and expressly disclaims liability for loss, damage, or expense arising out of, or in any way connected with, installation, operation, use, or maintenance by using this manual. Franklin Electric Co., Inc. assumes no responsibility for any infringement of patents or other rights of third parties that may result from use of this manual or the products. We make no warranty of any kind with regard to this material, including, but not limited to, the implied warranties of merchantability and fitness for a particular purpose.

Copyright © 2021 Franklin Electric Co., Inc., Madison, WI 53718. All world rights reserved. No part of this publication may be stored in a retrieval system, transmitted, or reproduced in any way, including, but not limited to, photocopy, photograph, magnetic, or other record, without the prior written permission of Franklin Electric Co., Inc.

For technical assistance, please contact:

franklinfueling.com

3760 Marsh Rd. • Madison, WI 53718 • USA

Tel: USA & Canada +1 800 225 9787 • Fax: +1 608 838 6433

Tel: UK +44 (0) 1473 243300 • Tel: Mex 001 800 738 7610

Tel: DE +49 6571 105 380 • Tel: CH +86 10 8565 4566

Firefox is a trademark of the of the Mozilla Foundation.

Safari is a registered trademark of Apple Inc.

Cellguard is a trademark of Franklin Electric Co., Inc.

Windows is a registered trademark of Microsoft Corporation.

1000008420 r2

CONVENTIONS USED IN THIS MANUAL

This manual includes safety precautions and other important information presented in the following format:

NOTE: This provides helpful supplementary information.

IMPORTANT: This provides instructions to avoid damaging hardware or a potential hazard to the environment, for example: fuel leakage from equipment that could harm the environment.

▲ CAUTION: This indicates a potentially hazardous situation that could result in minor or moderate injury if not avoided. This may also be used to alert against unsafe practices.

▲ WARNING: This indicates a potentially hazardous situation that could result in severe injury or death if not avoided.

▲ DANGER: This indicates an imminently hazardous situation that will result in death if not avoided.

OPERATING PRECAUTIONS

▲ WARNING: IMPORTANT SAFETY INSTRUCTIONS. BEFORE INSTALLING ANY FRANKLIN ELECTRIC GRID SOLUTIONS EQUIPMENT, READ THIS GUIDE AND FOLLOW SAFETY AND OPERATING INSTRUCTIONS. SAVE THESE INSTRUCTIONS.

▲ WARNING: Risk of explosive gases: Batteries generate explosive gases during normal operation, and when discharged or charged.

▲ WARNING: To reduce risk of battery explosion, follow these safety instructions and those published by the battery manufacturer and the manufacturer of any equipment you intend to use in the vicinity of a battery. Review cautionary marking on these products and on the battery cabinets, battery racks, battery rooms, and on equipment containing the battery.

▲ WARNING: Do not disassemble any equipment; contact Franklin Electric Grid Solutions when a repair is required. Incorrect reassembly may result in a risk of electric shock or fire.

▲ WARNING: Use Franklin Electric Grid Solutions equipment in a dry, well-ventilated area.

▲ WARNING: Do not expose Franklin Electric Grid Solutions equipment to rain or snow.

▲ WARNING: To avoid electric shock when testing jars, abide by your company's safety practices and the following guidelines:

▲ WARNING: Perform service work only for which you have been trained.

▲ WARNING: Refer to NFPA 70E for electrical safety requirements.

▲ WARNING: Use of Personal Protection Equipment (PPE) and Protective Clothing per NFPA 70E guidelines is required. Some examples of these, but not limited to, are: Electrical-insulating, acid-resistant, and protective gloves and sleeves per ASTM D 120, OSHA 29 CFR 1910.137, and NFPA 70E requirements; Protective footwear; Aprons (acid-resistant); Insulating blankets; On-site spill kits; Protective clothing for voltage levels, level of corrosive protection, and the amount of arc-flash protection provided; Insulated rescue hooks or other means for pulling personnel from live circuits; Eyewash stations or portable eyewash bottles; Class "C" dry chemical re extinguishers instead of water around battery systems.

▲ WARNING: Always have someone within range of your voice, or close enough to come to your aid, when working around lead acid batteries.

▲ WARNING: Have plenty of fresh water and baking soda nearby in case battery acid contacts skin, clothing or eyes.

▲ WARNING: If battery acid contacts skin or clothing, wash immediately with baking soda and water. If acid enters the eye, immediately flush with cold running water for at least 10 – 15 minutes, and seek medical attention.

▲ WARNING: Never smoke or allow a spark or flame in the vicinity of a battery or engine.

▲ WARNING: Be extra cautious to reduce risk of dropping a metal tool onto the battery. It might spark or short circuit the battery or other electrical part that may cause an explosion.

▲ WARNING: Before working with a lead-acid battery, remove personal metal items such as rings, bracelets, necklaces, watches, etc. A lead-acid battery can produce a short circuit current high enough to weld such items causing a severe burn.

▲ WARNING: Always wear safety glasses with side shields in the vicinity of battery work per 29CFR1910.133 (OSHA).

▲ WARNING: Do not disconnect the battery cables from power systems during the test without authorization.

▲ WARNING: Do not place yourself in an electrical circuit.

▲ WARNING: Avoid simultaneous contact with the jar and with the battery cabinet, racks, or hardware that may be grounded.

▲ WARNING: Battery posts, terminals, and related accessories contain lead and lead compounds, chemicals known to cause cancer and birth defects or other reproductive harm. Wash hands after handling.

CONTENTS

INTRODUCTION.....	1
SYSTEM TOPOLOGY.....	1
BASE COORDINATOR UNIT (BCU)	2
SENSORS	4
SAFETY PRECAUTIONS	5
HARDWARE INSTALLATION: SENSORS & VTC	7
SENSORS	7
REQUIRED TOOLS.....	7
PROPER PPE (SEE SAFETY PRECAUTIONS).....	7
SENSOR INSTALLATION	8
INSTALLING THE SENSORS WITH STRAP RESISTANCE	15
VTC	17
CURRENT TRANSDUCER INSTALLATION	23
SOLID-CORE CURRENT TRANSDUCER INSTALLATION	26
GROUND CABLE INSTALLATION	28
AMBIENT ZONE TEMPERATURE SENSOR INSTALLATION	28
POWERING UP THE VTC	30
BCU INSTALLATION AND POWER.....	31
POWERING THE BCU	31
WIRING THE 100VDC-1000VDC	33
48VDC TO DC CONVERTER INSTALLATION	34
SETTING UP A CONNECTION TO THE BCU	35
CONNECTING TO A LAPTOP/PC	35
GEN 3 BCU WEB INTERFACE TO WINDOWS® 10.....	36
ACCESSING THE WEB BROWSER INTERFACE	37
HARDWARE COMMISSIONING SENSORS AND VTC.....	39
SENSOR COMMISSIONING	39
SCANNING SENSOR DATA	40
CONFIGURE SYSTEM PARAMETERS.....	41
BATTERY DATA ENTRY	42
SCANNING SENSOR DATA	42
VTC COMMISSIONING	45
BCU CONFIGURATION SETTING SYSTEM PARAMETERS.....	48
SETTING SYSTEM PARAMETERS.....	48
SYSTEM ID.....	49
CELLGUARD™	50
DOWNLOADING A CONFIGURATION FILE	56
VERIFY INSTALLATION AND CONFIGURATION	57
SETTING BCU OUTPUT COMMUNICATIONS.....	58
NETWORKING>ETHERNET	58
COMMUNICATIONS>PROTOCOLS	59
CELLTRAQ™ COMMISSION	61
TOOLS>MODBUS REGISTER.....	62

Intentionally Blank

INTRODUCTION

SYSTEM TOPOLOGY

The Gen III Wireless Battery Monitoring System (BMS):

- Provides accurate and reliable indication of battery state of health through monitoring and analysis of battery voltage, temperature, and conductance.
 - Detects specific battery deterioration and battery string failures and provides automatic alarms via; dry alarm contacts, modbus TCP/IP, email, SNMP traps, and text messages.
 - Collects and analyzes battery health indicators to provide detailed battery health status reports.
- Eliminates the manual time and cost consuming maintenance programs with programmed battery performance testing and reporting through the web/intranet.
 - CELLGUARD™ System-Gen-3 provides local application access and immediate battery health information. Battery state of health indicators are reported to a remote server with outgoing email. Wireless sensors reduce time and cost of installation and maintenance.
 - CELLGUARD™ System-Gen-3 eliminates the need for dedicated computers to monitor each battery system.
 - Lowers cost of ownership from installation to its product life cycle.

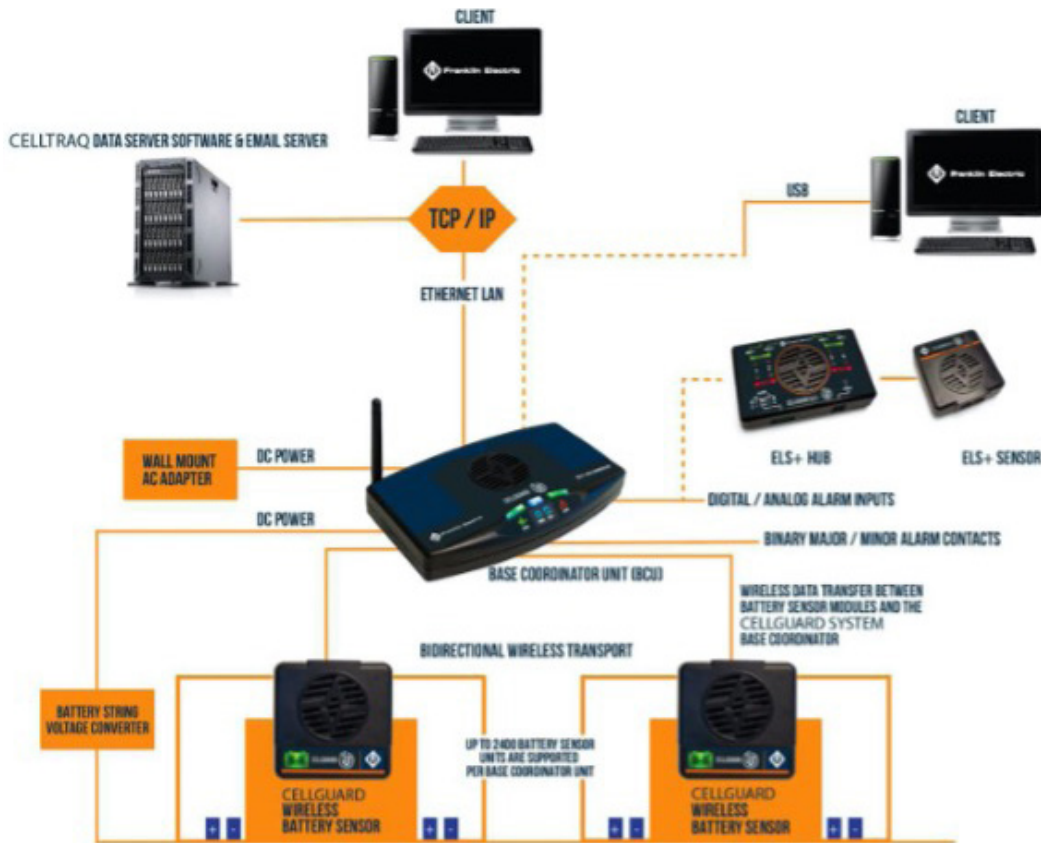

BASE COORDINATOR UNIT (BCU)



FEATURES

- Supports up to 16 Battery Strings.
 - 600 cells/batteries total per BCU.
- Network Communications via:
 - TCP/IP Ethernet/Intranet
 - Modbus over TCP/IP
 - MQTT
 - SNMP v3
 - 2 Form C Dry Contacts.
- Embedded Internal Webserver.
- Field Upgradable Firmware.
- 2 Ambient Temperature Sensors.
- Remote Configuration and Hardware Commissioning.
- Captures String & Battery data including battery discharge data.
- Sends data to CELLTRAQ™ Enterprise software at scheduled frequency.

SPECIFICATIONS

Battery Strings:

- Max strings is 16.
- Max sensors per string is 300.
- Max sensors per BCU is 600 (irrespective of how they are divided by strings).
- Test Measurement Intervals:
 - Battery Voltage and Temperature.
 - Range: 1 – 24 Hours (Default: 4hrs).
 - Battery Conductance and Strap Resistance.
 - Range: 1 – 30 Days (Default: 7 Days)

Examples of BCU String Configurations:

- If 60 cells per string, then the max is 10 strings ($60 \times 10 = 600$)
- If 4 batteries per string, then the max is 16 strings ($4 \times 16 = 64$)
- If 24 cells per string, then the max is 16 strings ($24 \times 16 = 384$)
- If 240 cells per string, then the max is 2 strings ($240 \times 2 = 480$)

- Power Input: 9-12Vdc @ 800mA.
- Operating Temperature: 0°C - 65°C.
- Storage Temperature: -10°C - 80°C.
- Processor: Quad Core @ 1250MHz.
- RAM: 1Gb SDRAM @ 400MHz.
- Storage: 16GB micro SD card.
- USB Type A: 2.0.
- UART: Baud Rate: 57.6Kbps; Data Bits: 8; Parity Bit: None; Stop Bit: 1.
- Ethernet: RJ45; 10/100Mbps; Auto-Negotiate; 802.3 Compliant.
- Analog Alarm Input: 0.2Vdc – 10Vdc.
- Binary Alarm Input: Dry contact only.
- Major/Minor Alarm Output: Close/Open Form C Dry Contacts.
- Wireless RF Radio Band: 802.15.4 Compliant; 2.4GHz @ 8mW (6.3dBm).
- Modbus: Ethernet TCP/IP UDP.
- Regulatory Compliance: FCC, CE, RoHS, IEEE.
- Physical Dimensions: L:7.8in, W:4.47in, H1.44in.

SENSORS



FEATURES

- One sensor per cell/battery.
- Sensor Types: 2V, 6V-12V, 12V.
- Sensor Measurements: Voltage, Temperature, Conductance, Strap Resistance.
- Mesh Routing Communication.
- Quick, fully hot swappable sensor and/or wiring harness.
- Remote upgradable firmware.
- Compatible with VRLA batteries and VLA cells.
- Conductance technology for Ohmic testing.
- Non-Invasive to the battery.
- Accurate battery state-of-health results.
- Wireless system minimizes wiring, installation cost, and maintenance.

SPECIFICATIONS

- Wireless RF Radio Band: 802.15.4 Compliant; 2.4GHz @ 8mW (6.3dBm).
- Wireless Range: 0 – 30 meters (Unobstructed).
- Operating Temperature: 0°C - 65°C
- Storage Temperature: -10°C - 80°C
- Test Current: 1100 – 4500mA depending on battery/cell float voltage.
- Voltage Resolution: 1mV
- Conductance Resolution: 1 Ω
- Regulatory Compliance: FCC, CE, RoHS, IEEE
- Physical Dimensions: L:2.63in, W:2.64in, H:1.06in

SAFETY PRECAUTIONS

IMPORTANT: Read this manual before installing the products.

▲ WARNING: To avoid electrical shock when testing jars, follow your company's safety practices and these guidelines:

1. IMPORTANT SAFETY INSTRUCTIONS. IT IS OF UTMOST IMPORTANCE THAT BEFORE INSTALLING YOUR SYSTEM YOU READ THIS MANUAL AND FOLLOW THE SAFETY AND OPERATING INSTRUCTIONS. SAVE THESE INSTRUCTIONS.
 - a. TO REDUCE RISK OF BATTERY EXPLOSION, FOLLOW THESE SAFETY INSTRUCTIONS AND THOSE PUBLISHED BY THE BATTERY MANUFACTURER AND THE MANUFACTURER OF ANY EQUIPMENT YOU INTEND TO USE IN THE VICINITY OF A BATTERY. REVIEW CAUTIONARY MARKING ON THESE PRODUCTS AND ON THE BATTERY CABINETS, BATTERY RACKS, AND BATTERY ROOMS, OR EQUIPMENT CONTAINING THE BATTERY.

IF YOU ARE UNCERTAIN AS TO THE TYPE OF BATTERY YOU ARE WORKING ON, THEN CONTACT THE SELLER OR BATTERY MANUFACTURER.

- b. DO NOT INSTALL THIS EQUIPMENT IF IT HAS BEEN DROPPED OR OTHERWISE DAMAGED IN ANY WAY; CONTACT FRANKLIN GRID TECHNICAL SERVICES OR CUSTOMER SERVICE.
 - c. DO NOT DISASSEMBLE ANY PARTS; CONTACT FRANKLIN GRID TECHNICAL SERVICES OR CUSTOMER SERVICE WHEN A REPAIR IS REQUIRED. INCORRECT REASSEMBLY MAY RESULT IN A RISK OF ELECTRIC SHOCK OR FIRE.
 - d. INSTALL EQUIPMENT IN A DRY, WELL-VENTILATED AREA.
 - e. DO NOT EXPOSE EQUIPMENT TO RAIN OR SNOW.
2. Perform service work only for which you have been trained.
 - a. Refer to NFPA 70E for electrical safety requirements.
 - b. Use of Personal Protection Equipment (PPE) and Protective Clothing per NFPA 70E guidelines. Some examples of these, but not limited to, are:
 - Electrical-insulating, acid-resistant, and protective gloves and sleeves per ASTM D 120, OSHA 29 CFR 1910.137, and NFPA 70E requirements.
 - Protective footwear.
 - Aprons (acid-resistant).
 - Insulating blankets.
 - On-site spill kits.
 - Protective clothing for voltage levels, level of corrosive protection, and the amount of arc-ash protection provided.
 - Insulated rescue hooks or other means for pulling personnel from live circuits.
 - Eyewash stations or portable eyewash bottles.
 - Class “C” dry chemical fire extinguishers instead of water around battery systems.

- c. Always have someone within range of your voice, or close enough to come to your aid, when working around lead acid batteries.
- d. Have plenty of fresh water and baking soda nearby in case battery acid contacts skin, clothing or eyes.
- e. If battery acid contacts skin or clothing, wash immediately with baking soda and water. If acid enters the eye, immediately flush with cold running water for at least 10 – 15 minutes and seek medical attention.
- f. Never smoke or allow a spark or flame in the vicinity of a battery or engine.
- g. Be extra cautious to reduce risk of dropping a metal tool onto the battery. It might spark or short circuit the battery or other electrical part that may cause an explosion.
- h. Before working with a lead-acid battery, remove personal metal items such as rings, bracelets, necklaces, watches, etc. A lead-acid battery can produce a short circuit current high enough to weld such items causing a severe burn.
- i. Always wear safety glasses with side shields in the vicinity of battery work per 29CFR1910.133 (OSHA).
- j. Do not disconnect the battery cables from power systems during the installation without proper authorization.
- k. Do not place yourself in an electrical circuit.
- l. Avoid simultaneous contact with a battery and with the battery cabinet, racks, or hardware that may be grounded.
- m. Battery posts, terminals, and related accessories contain lead and lead compounds, chemicals known to cause cancer and birth defects or other reproductive harm.

NOTE: WASH HANDS AFTER HANDLING.

HARDWARE INSTALLATION: SENSORS & VTC

SENSORS

REQUIRED TOOLS

- Insulated Torque Wrench
- Insulated Sockets and Extension



PROPER PPE (SEE SAFETY PRECAUTIONS)

Use of Personal Protection Equipment (PPE) and Protective Clothing per NFPA 70E guidelines. Some examples of these, but not limited to, are:

- Electrical-insulating, acid-resistant, and protective gloves and sleeves per ASTM D 120, OSHA 29 CFR 1910.137, and NFPA 70E requirements.
- Protective footwear.
- Aprons (acid-resistant).
- Insulating blankets.
- On-site spill kits.
- Protective clothing for voltage levels, level of corrosive protection, and the amount of arc-ash protection.
- Insulated rescue hooks or other means for pulling personnel from live circuits.
- Eyewash stations or portable eyewash bottles.
- Class “C” dry chemical fire extinguishers instead of water around battery systems.
- Always wear safety glasses with side shields in the vicinity of battery work per 29CFR1910.133 (OSHA).
- Make Sure Battery String is disconnected from charging circuit.

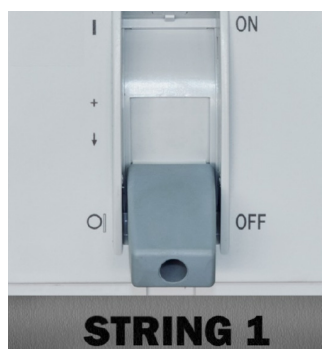

SENSOR INSTALLATION

NOTE: When installing tabs on the first and last batteries, installation of the VTC string voltage cable and/or the DC to DC cable and solid core transducers should be done with ring terminals to prevent having to disconnect ring terminals multiple times. See the VTC Installation and Powering BCU sections.

NOTE: Torque all battery terminals to battery manufacturer specifications.

MONITORING APPLICATIONS

- Telco- two-tab ring terminals if no strap resistance.
- Data Center – Four-tab ring terminals - Strap Resistance.
- Utility (NERC)- Four-tab ring terminals - Strap Resistance.

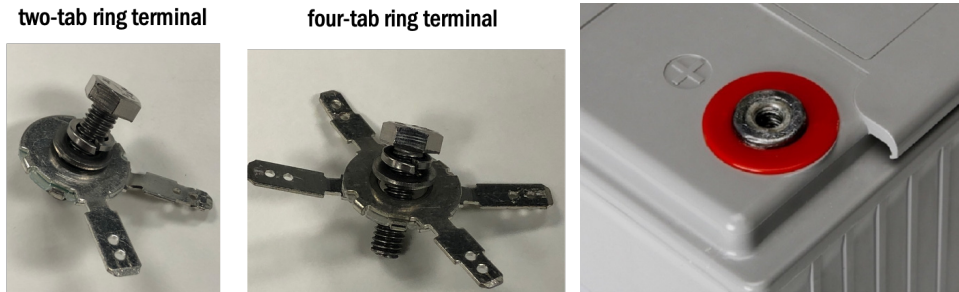

Terminal Cross Reference Table

Post Size Compatibility			
Metric		US	
M4	4mm	#8	0.176"
M6	6mm	1/4"	0.250"
M8	8mm	5/16"	0.3125"
M10	10mm	3/8"	0.375"
M10	10mm	7/16"	0.4375"

Tabbed Ring Terminal Part Numbers and Sizes

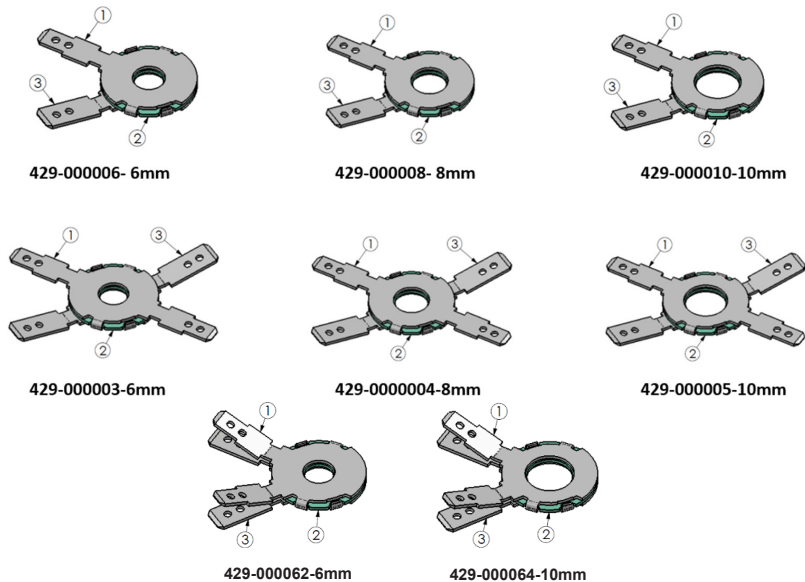

- Electrically isolate the battery string and reduce the voltage to <60VDC.
- Note the initial torque value of the battery/cell.

NOTE: The path of current flow to the battery string (conventional current flow, positive to negative).



⚠ WARNING: When working on batteries, use proper PPE.

- The bolt hardware **MUST** be arranged as follows (from bolt head to bottom):
 - ■ Lock-Washer
 - ■ Washer
 - ■ FE GRID Solutions Tabbed Washer

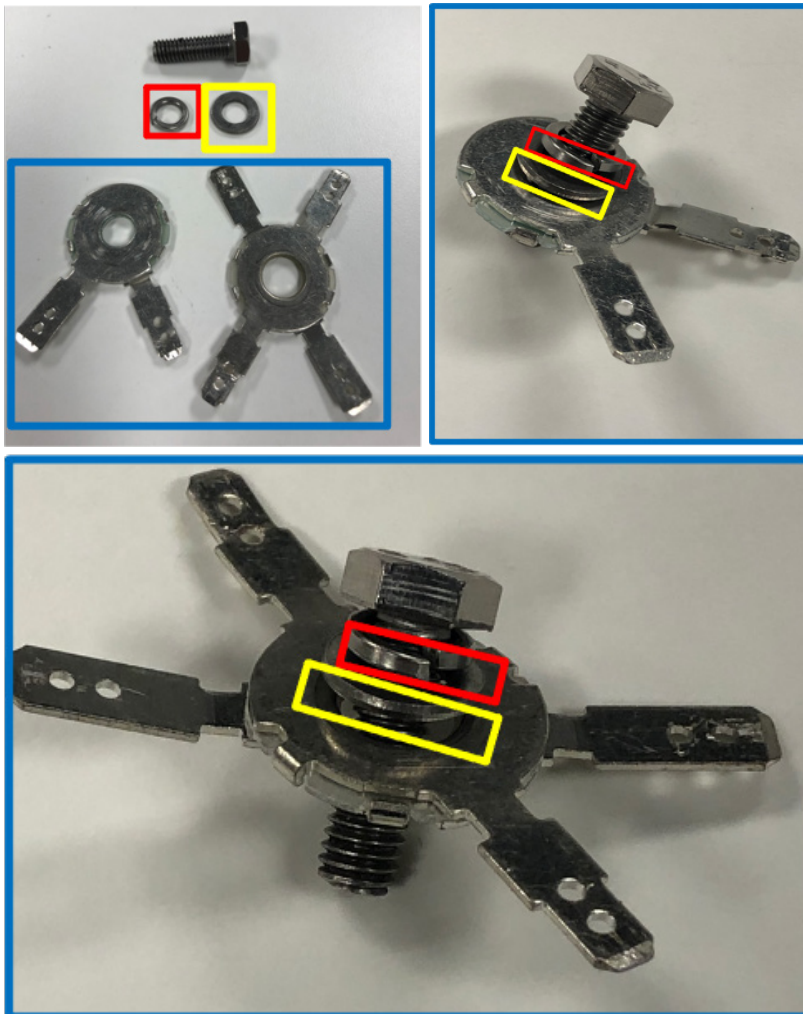

- The FE GRID Tab must be closest to the battery to ensure accurate readings.
- Testing is sensitive enough to pick up resistance created by a misplaced washer.

SPECIAL CONDITIONS: For deep well connections such as on OPz cells, spacers may be needed to obtain proper connection.

TAB TERMINAL INSTALLATION

The bolt hardware **MUST** be arranged as follows (from bolt head to bottom):

- 1. ■ Lock-Washer
- 2. ■ Washer
- 3. ■ FE GRID Solutions Tabbed Washer
- 4. ■ FE GRID Solutions spacer(s) (**must use FE hardware**)
- 5. ■ Inter-cell connector

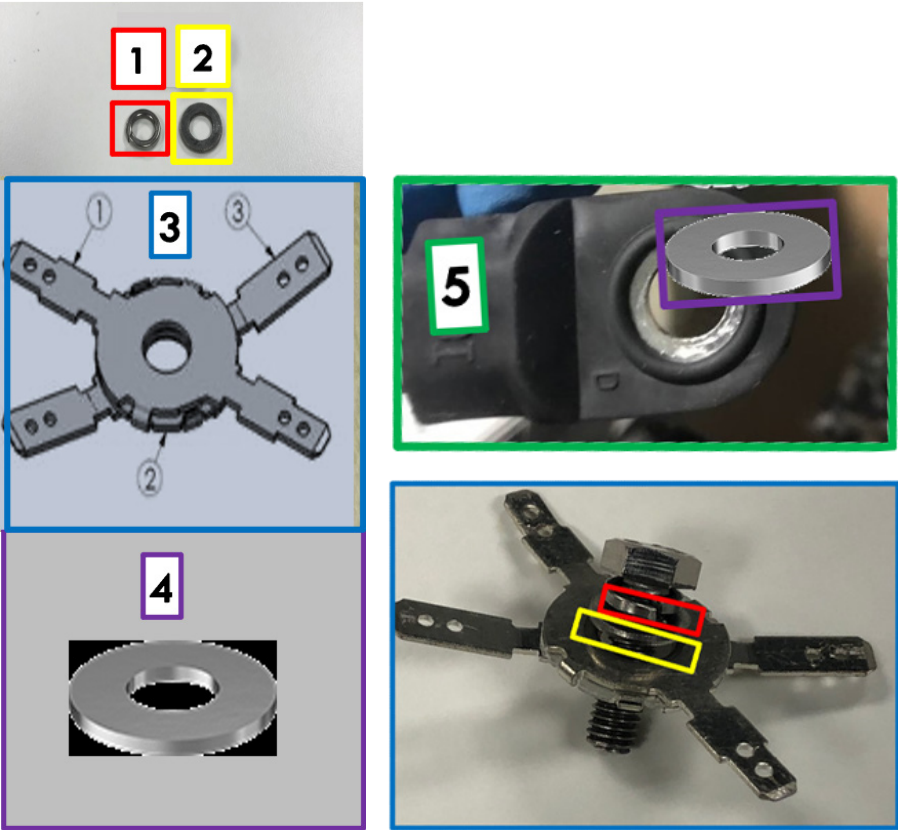

Typical OPz Connections

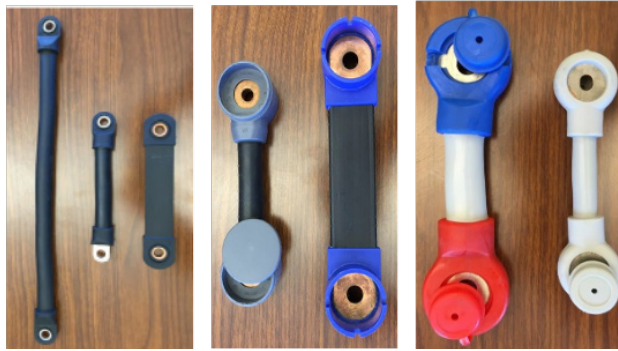

Spacer Part Numbers and Sizes

143-000017	Sn PLATED CU RING/SPACER 10MM ID X 14MM OD X 2MM THICK	A_2	RELEASED	
143-000018	Sn PLATED CU RING/SPACER 6MM ID X 14.75MM OD X 4MM THICK	A	RELEASED	
143-000019	Sn PLATED CU RING/SPACER 8MM ID X 14.75MM OD X 4MM THICK	A	RELEASED	
143-000020	Sn PLATED CU RING/SPACER 10MM ID X 14.75MM OD X 4MM THICK	A	RELEASED	

BATTERY SENSOR TERMINAL INSTALLATION

Two-Tab Terminal Installation

1. Remove bolt and washers.
2. Install tab terminal as shown.

NOTE: Ensure wide tab (.250 wide tab) is on the bottom touching the strap and narrow tab (.187 wide tab) is on top touching the washer and bolt.

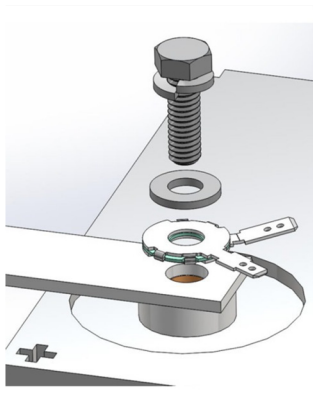
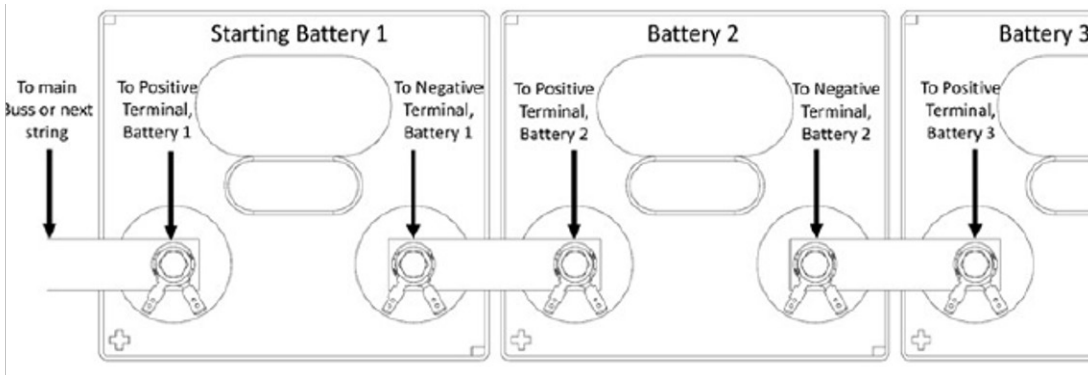

Narrow Tab - top

Wide Tab - bottom

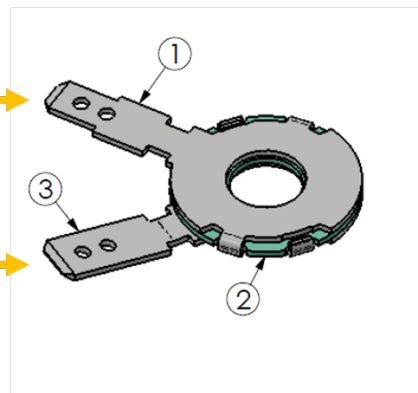

Four-Tab Terminal Installation

1. Remove bolt and washers.
2. Install with orientation as follows:
 - a. Bottom portion of terminal surface indicated, with the two .250 wide tabs, contacts the strap. (These are the wider tabs)
 - b. Top portion of terminal surface indicated, with the two .187 wide tabs, contacts the washer and bolt. (These are the narrower tabs)

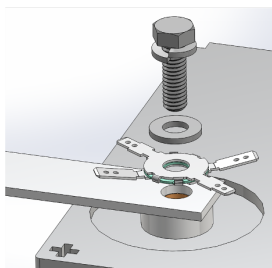

Bottom Portion

Top Portion

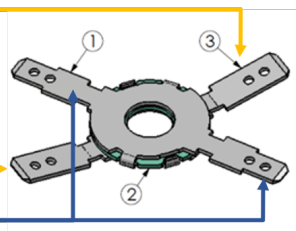

Installing the Sensors (without strap resistance test)

Sensor wire definitions:

- Orange: Input signal lead
- Red: Positive battery post sense lead
- Brown: Negative battery post signal return lead
- Blue: Negative battery post temperature
- Black: Negative battery post sense lead



- Make sure the battery string is powered down.
NOTE: For CELLGUARD™ BMS Battery 1 is always the most positive battery in the string regardless if it is a positive grounded battery system.
- Always install the **BLACK** and **BLUE** wires first.
NOTE: **BLACK** and **BLUE** wires are treated with Heat shrink and are not fully insulated.
IMPORTANT: Any variance from these steps can cause injury or damage the sensor

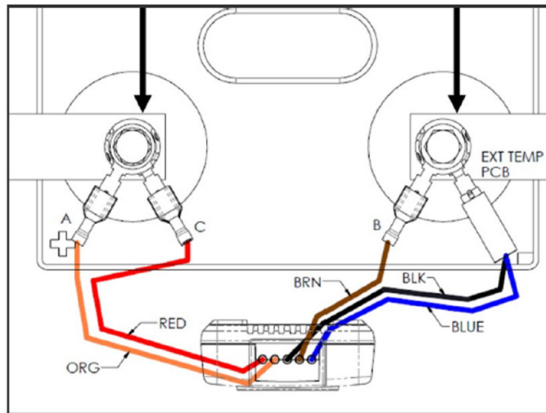

- On Negative Post; install **BLACK** and **BLUE** wire to the bottom most .187 narrow terminal.
- On negative post; install the **BROWN** wire to the .25 wide terminal.
- On Positive Post; install the **ORANGE** wire to the bottom most .25 wide terminal.
- On the positive post; install the **RED** wire to the bottom most .187 narrow terminal.
- Repeat until all sensors are installed.

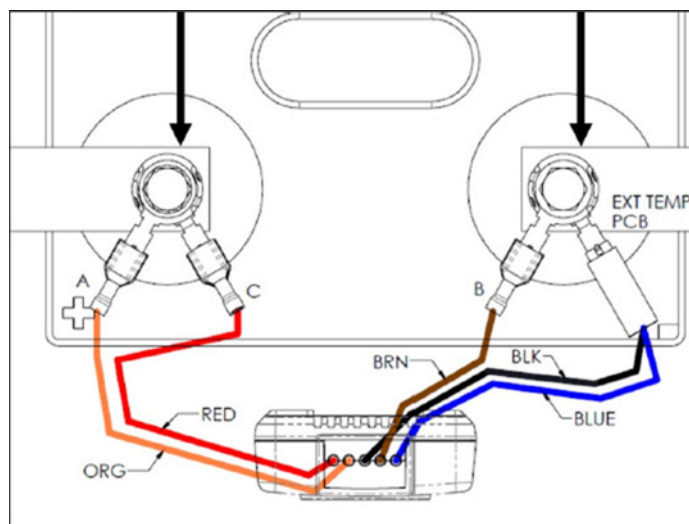

GEN III UPS-Utility Battery Hook-up with
REV A_3 Cable

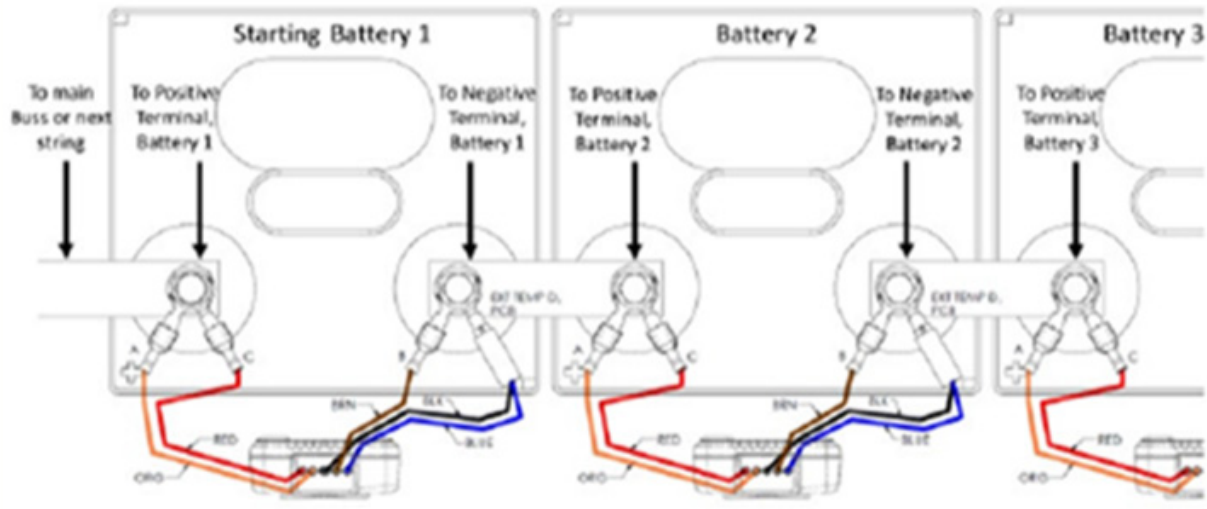

INSTALLING THE SENSORS WITH STRAP RESISTANCE

- First battery or cell:
 - On Negative Post; install **BLACK** and **BLUE** wire to the upper .187 narrow terminal.
 - On negative post; install **BROWN** wire to lower .250 wider terminal.
 - On First battery Only; On Positive post Connect **ORANGE** wire to .250 wide terminal .
 - On first battery Only; On positive post connect **YELLOW** wire to .187 terminal.
 - On Positive Post Connect **RED** wire to .187 terminal.

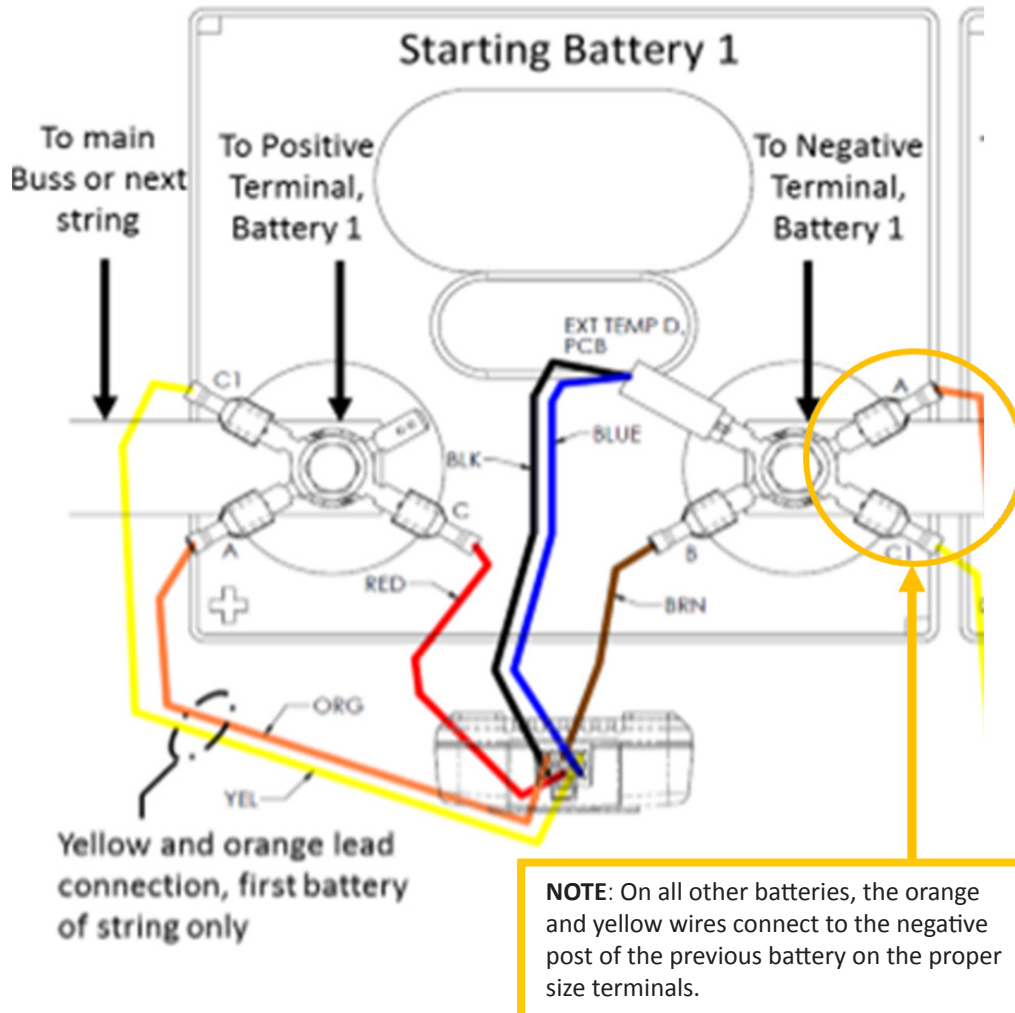

- On Negative Post; install **BLACK** and **BLUE** wire to the top .187 narrow terminal.
- On negative post; install **BROWN** wire to lower .250 wider terminal .
- Install **ORANGE** wire to .250 wide terminal on the negative post of the previous battery/cell.
- Install **YELLOW** wire to .187 terminal on the negative post of the previous battery/cell.
- On Positive Post install **RED** wire to .187 terminal.

Installation of Sensors with the Strap Resistance Measuring Wires

GEN III UPS-Utility Battery Hook-up

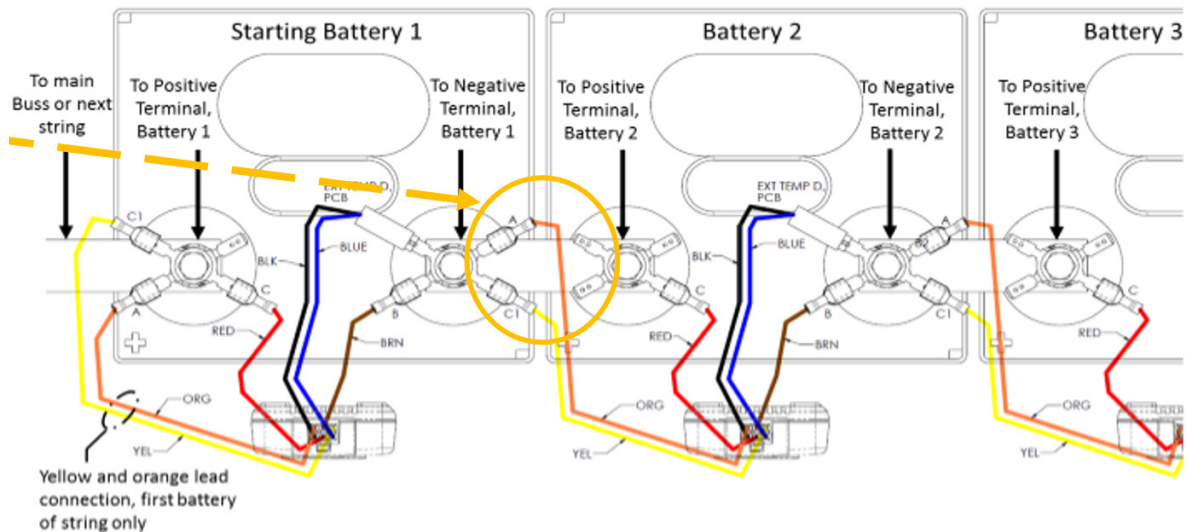

NOTE: When the **ORANGE** and **YELLOW** wires cannot make the reach for tier to tier or battery shelf to shelf connections, treat these connects like the first battery/cell.

- When first installed, Sensors will flash **RED** and **YELLOW**.
- Indication that sensors are on the factory RF channel and need to be commissioned to the BCU.

Sensor wire definitions:

- Orange: Input signal lead
- Yellow: Strap resistance sense lead
- Red: Positive battery post sense lead
- Brown: Negative battery post signal return lead
- Blue: Negative battery post temperature
- Black: Negative battery post sense lead

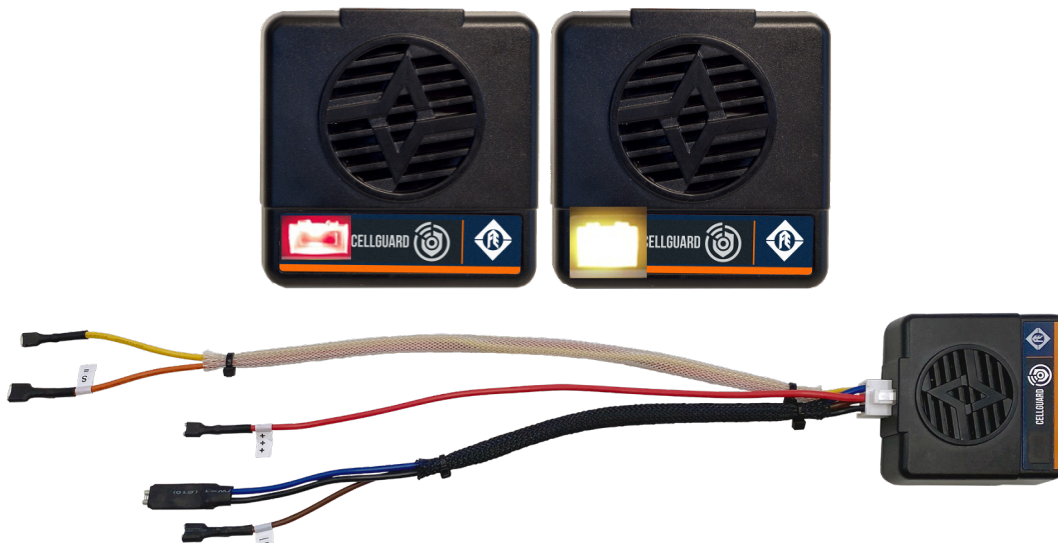

VTC

REQUIRED TOOLS

- Insulated Torque Wrench
- Insulated Socket Set
- Phillips-Head Screwdriver
- Crimping tool
- Wire stripper

PROPER PPE

Per site requirement



- Verify Battery String is **OFFLINE** (Battery breaker/disconnect switch is open) before installing string voltage/VTC Power cable.
- Crimp power cable ring terminals.
 - Choose the terminal size (M6 or M10) that closely matches the diameter of the bolt where the string voltage cables will be installed.
 - Crimp a terminal onto the positive and negative leads connected to the fuse holders.

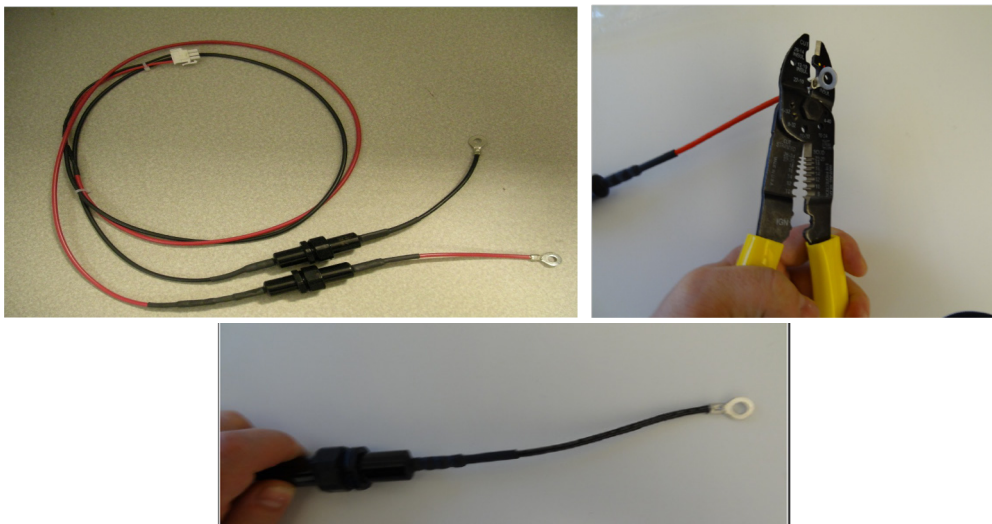

- Remove power cable fuses.
 - On the Positive and Negative leads, hold the fuse holder and twist lock ring.
 - Once lock ring is loose, pull cable sections apart.
 - Fuse can be pulled out of fuse socket without twisting.
 - Remove KLM-1 fuse.

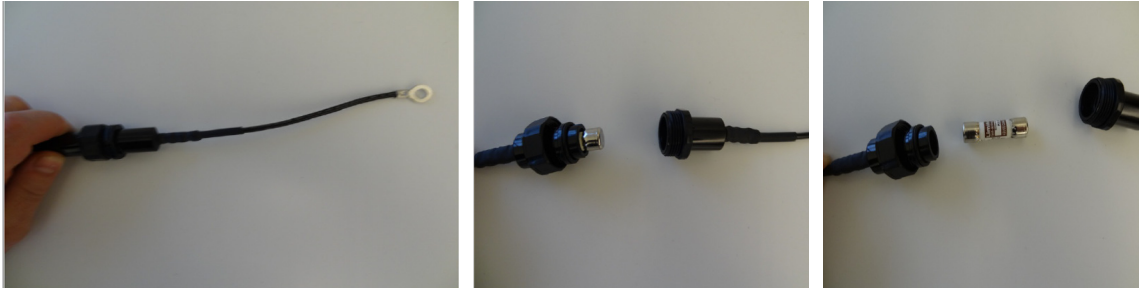

- Remove the most positive bolt.
 - Ensure that feeder is properly protected from shorting to any other metal object or battery post.
- Repeat process for negative terminal .
 - Remove the most negative bolt.
 - Ensure the Feeder cable is electrically safe.



NOTE: VTC power cable installed with fuse links on positive and negative terminal plates.

- Stack the most positive hardware .
 - The bolt hardware **MUST** be arranged as follows (from bolt head to bottom):
 1. 1 Lock-Washer
 2. 2 Washer
 3. 3 VTC Power Cable, **RED** wire ring terminal.
 4. 4 FE GRID Solutions tabbed washer.

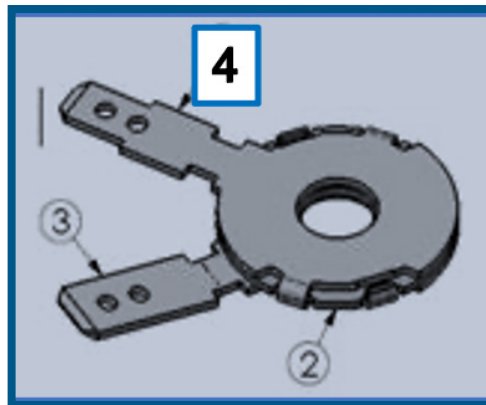
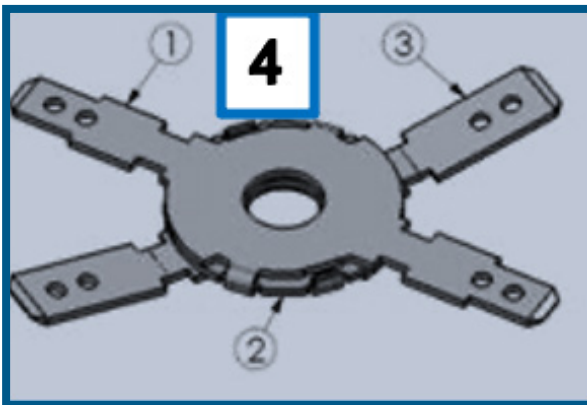
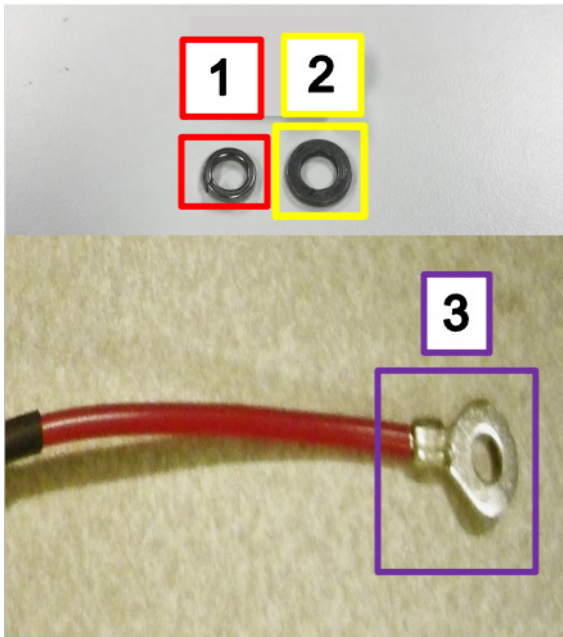

- The FE GRID Tab must be closest to the battery to ensure accurate readings.
- Testing is sensitive enough to pick up resistance created by a misplaced washer.

- Install most positive connection.
 - Verify the battery string breaker is **OPEN** before installing the String Voltage Cable.

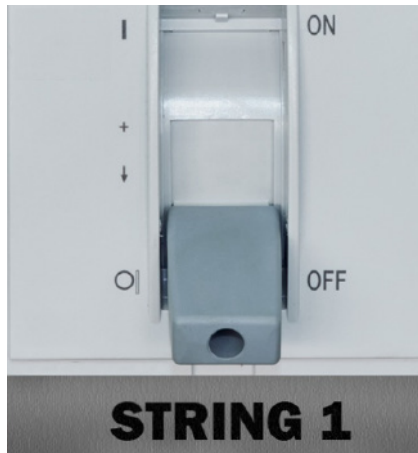

- Attach the **RED** (Positive, +) wire of the string voltage cable to the positive terminal of battery/cell 1 or a positive termination on the battery side of the string breaker.

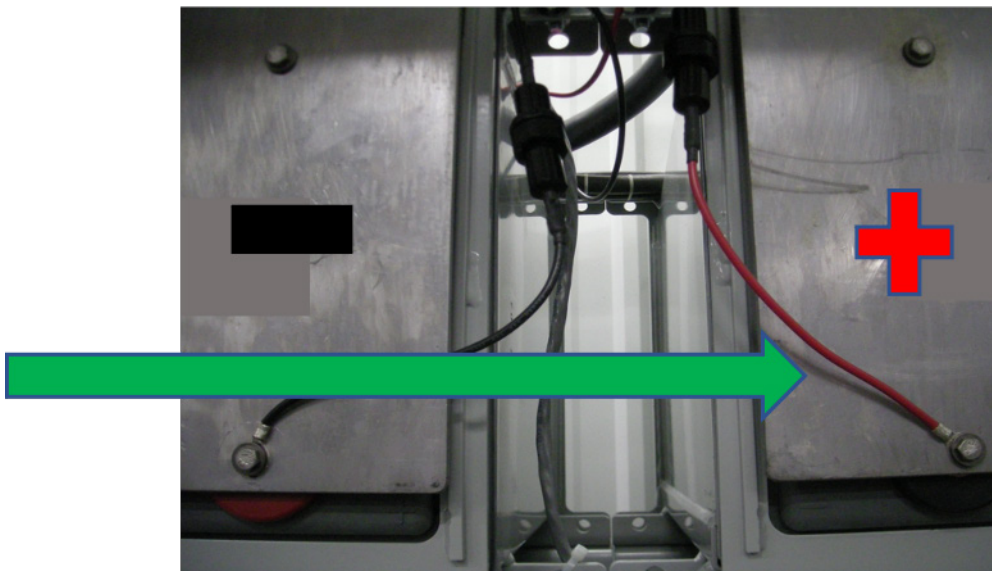

- Repeat process for negative terminal.
 - Remove the Most Negative Bolt.
 - Ensure the Feeder cable is electrically safe.
 - Arrange the Negative hardware stack as previously arranged for the positive stack.
 - Attach the **BLACK** (Negative, -) wire of the string voltage cable to the negative terminal of the last battery/cell in the string, or a negative termination on the battery side of the string breaker.

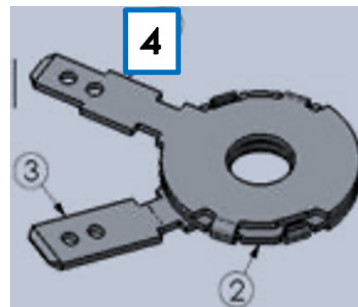
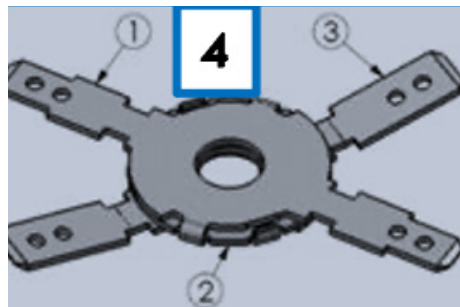
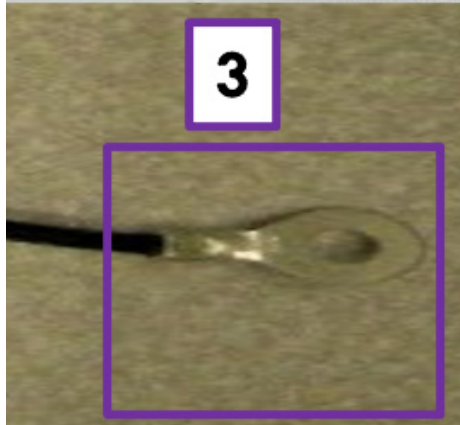
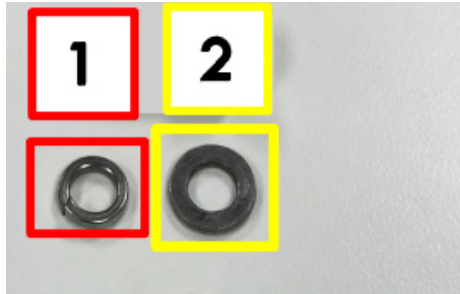

- Repeat prior steps for the most negative connection.
 - Verify the battery string breaker is **OPEN** before installing the String Voltage Cable.

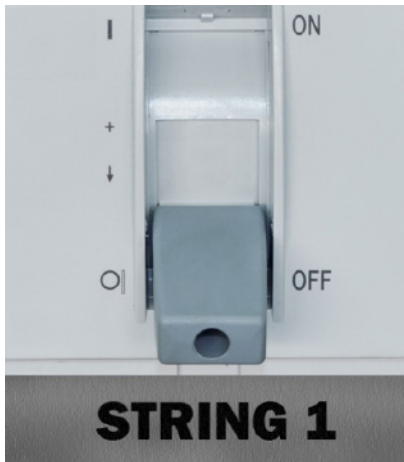

- Attach the **BLACK** (Negative, -) wire of the string voltage cable to the negative terminal of the last battery/cell in the string, or a negative termination on the battery side of the string breaker.

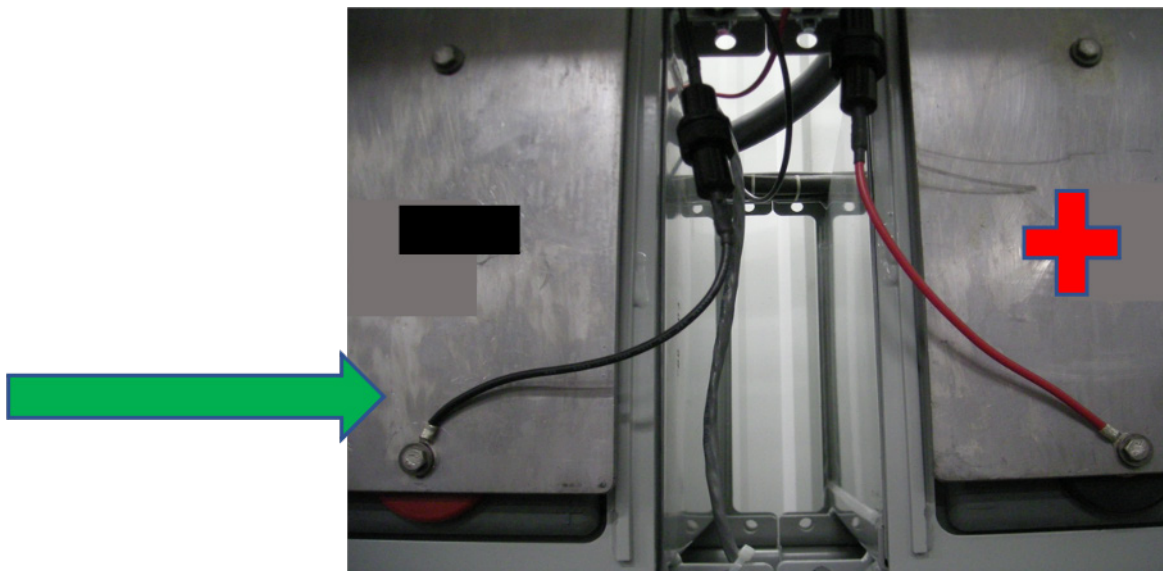

CURRENT TRANSDUCER INSTALLATION

Two Current Transducer Options:

- Option #1; Solid Core

CT Option 1: 124-015 - Physical Space Requirements

DIM	Inches	Name	Notes
L1	7.575"	Length – Installed	With cables installed
L2	6.375"	Length – Main housing only	
H	4.050"	Height	
X1	1.250"	Clearance 1: Hole to Top	
X2	1.230"	Clearance 2: Hole to Near Side	
W1	2.950"	Width/Thickness – Overall	
W2	1.490"	Width/Thickness – Top Section	
D	1.553"	Aperture Diameter (max)	500 MCM cable max Verify lug will fit

p/n 124-015

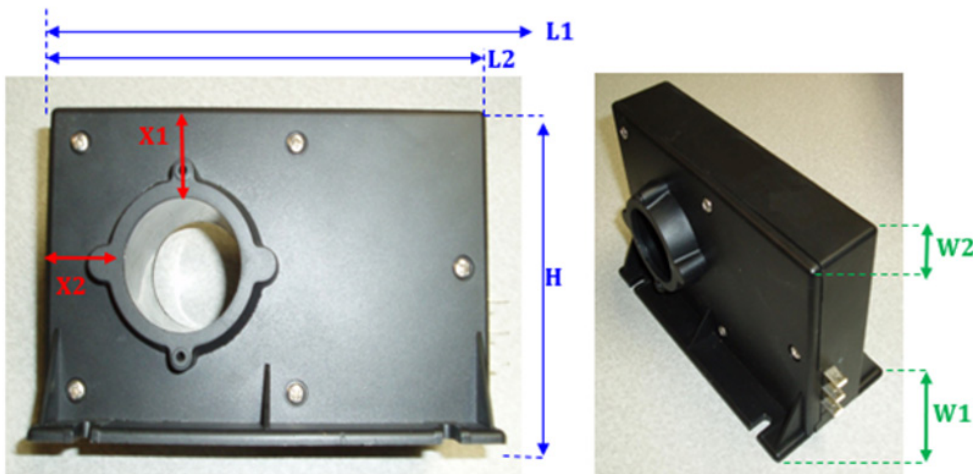

- Option #2; Split-Core

CT Option 2: 124-000001 - Physical Space Requirements

DIM	Inches	Name	Notes
L1	6.750"	Overall Length	
H	3.375"	Height	
X1	0.910"	Clearance 1: Hole to Top	
X2	1.375"	Clearance 2: Hole to Side	Same for each side
W1	1.980"	Width/Thickness – Overall	At widest part
W2	1.230"	Width/Thickness – Top Section	
AL	4.080"	Width of Aperture	
AH	1.565"	Height of Aperture	

Note: this option is sold at a higher price

p/n 124-000001

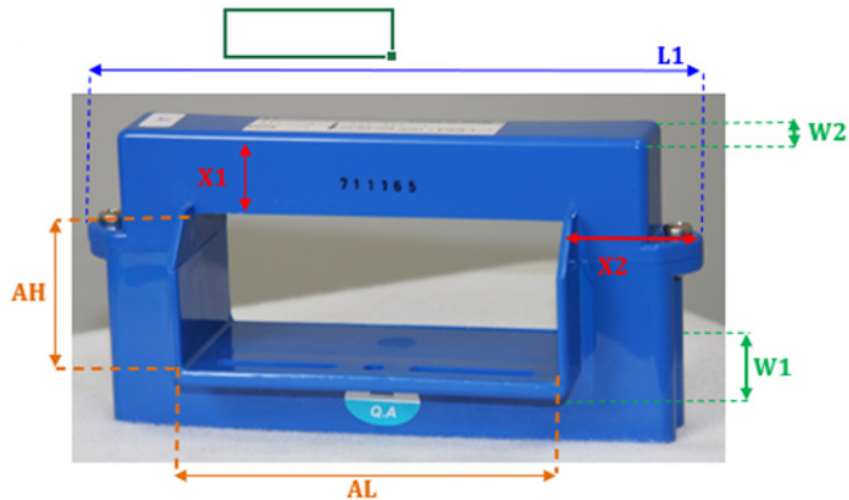

- Verify the battery string breaker is **OPEN** before installing the Current Transducer.
- Identify a location in the battery string on the battery side of the breaker where the current transducer can be safely and securely mounted.
- Locate arrow on Current Transducer .



- The battery string cable, strap, or conductor must pass through the Current Transducer aperture with positive to negative current flow in the direction of the arrow on top of the Current Transducer (CT). ○

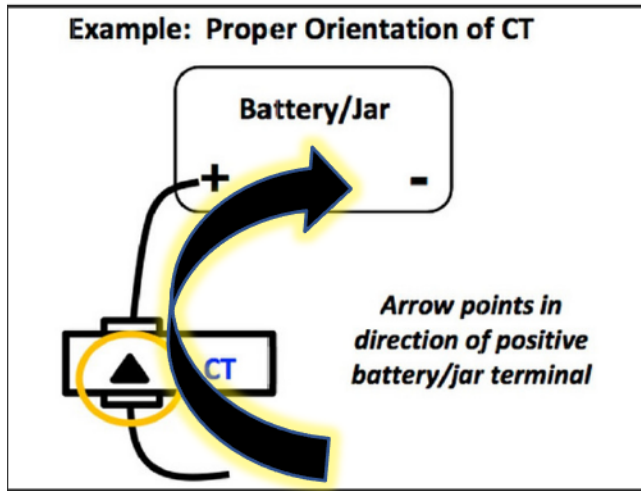

Charge current flow, + positive to - negative

- If installing the CT near a strap or cable that connects to a **POSITIVE** terminal, the arrow should point **TOWARDS** the positive terminal.

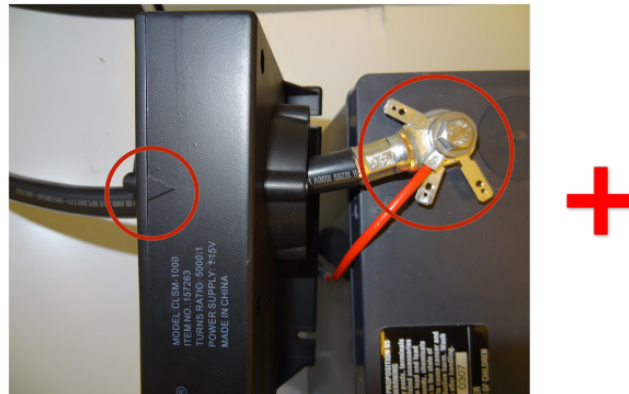

- If installing the CT near a strap or cable that connects to a **NEGATIVE** terminal, the arrow should point **AWAY** from the negative terminal.

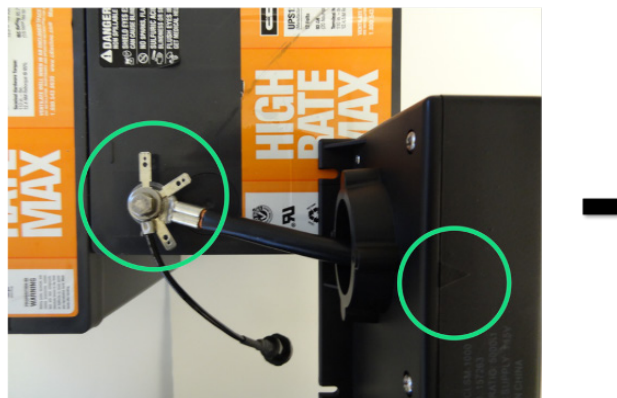

SOLID-CORE CURRENT TRANSDUCER INSTALLATION

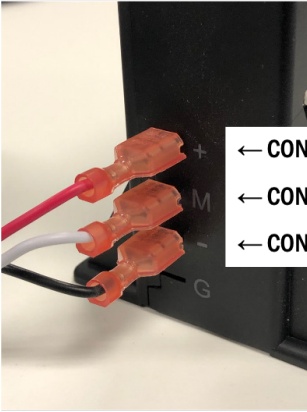

- ← CONNECT THE RED (POSITIVE, +) WIRE TO THE (+) TERMINAL
- ← CONNECT THE WHITE WIRE TO THE (M) TERMINAL
- ← CONNECT THE BLACK (NEGATIVE, -) WIRE TO THE (-) TERMINAL

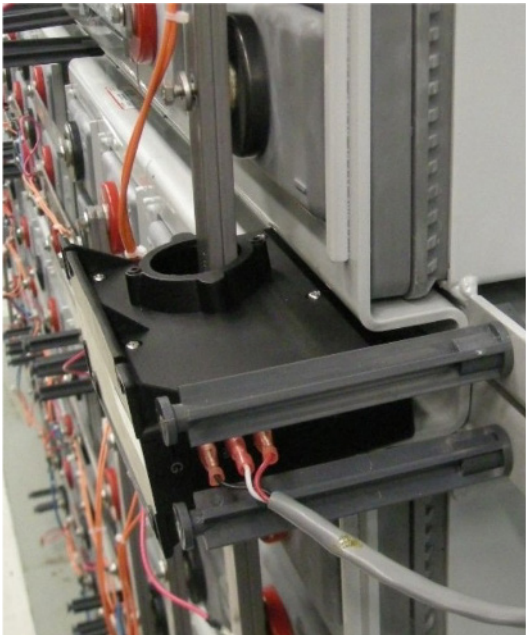
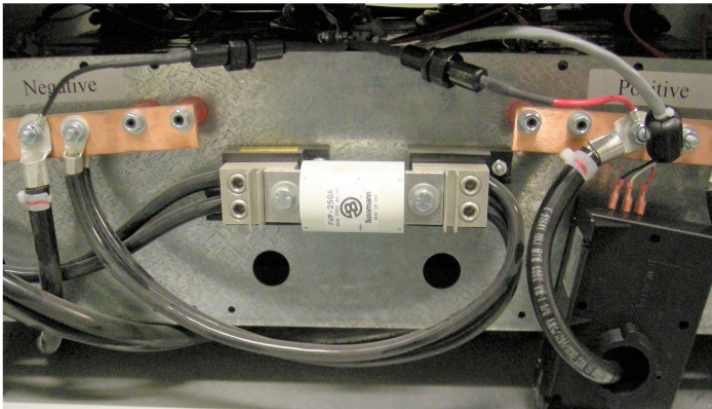
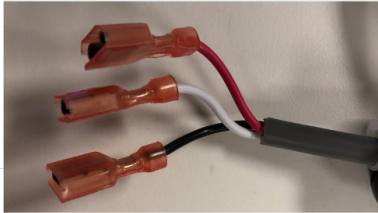

- When multiple parallel current carrying cables cannot fit through the current transducer aperture, a current multiplier must be applied during commissioning > current multiplier, which is a parameter setting under the string configuration.

<input type="checkbox"/> Strings	+		
<input type="checkbox"/> Purple	-	Name	Purple
		Has VTC	Yes
		VTC MAC Address	0013A200419340D1
		Current Multiplier	1.00 A
		Adaptive Reference	Yes



CURRENT MULTIPLIER WOULD BE : 2

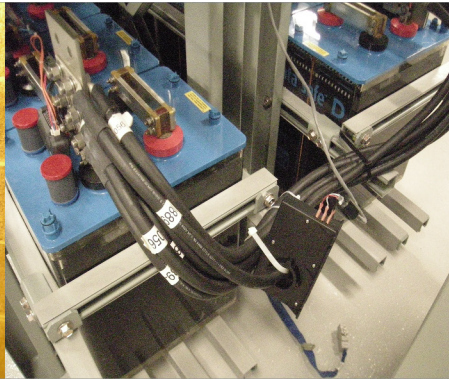

CURRENT MULTIPLIER WOULD BE : 6



CURRENT MULTIPLIER WOULD BE : 3



- ← CONNECT THE RED WIRE TO THE +15/Red TERMINAL
- ← CONNECT THE BLACK WIRE TO THE -15/Black TERMINAL
- ← CONNECT THE WHITE WIRE TO THE Out/White TERMINAL
- ← CONNECT THE GREEN WIRE TO THE Gnd/Green TERMINAL



GROUND CABLE INSTALLATION

Ground Cable

- Crimp a ring terminal onto the silvered end of the ground cable.
- Connect ground wire to a proper earth ground.
- Attach the ground wire lug to the GROUND connector on the back of the VTC. Carefully tighten the screw upon completion so as not to strip the terminal threads inside of the VTC.



AMBIENT ZONE TEMPERATURE SENSOR INSTALLATION

Mount the sensors using the Velcro strips provided.

- Positioning:
 - Vertical racks: mount “Zone A” at the top and “Zone B” at the bottom.
 - Cabinets: mount “Zone A” at the top and “Zone B” at the bottom.
 - Open Racks: mount “Zone A” near to the BCU or start of the string, and “Zone B” away from the BCU.
- Mount the sensors on the same plane if there are multiple parallel open rack strings.
- On singular planes, mount the sensors near and far, and high and low in a diagonal orientation if there is a single string with multiple tiers.
- Position the sensors in a consistent manner for all strings in an installation.



- Plug in cables for Temperature and Current Transducer.
 - Connect the 4-pin connector for the Ambient Temperature Sensor cable to the **TEMPERATURE** port. (Optional)
 - Connect the 6-pin connector for the CT cable to the **CURRENT PROBE** port.
 - The 2-pin connector, "**POWER TO BCU**," is not used for GenIII.
 - Ensure that all VTC cables and wires are securely mounted and neatly routed in a manner that does not allow them to be loose enough to get snagged and cause a hazard during battery or other maintenance activities.



**Not Used
No
Connection**

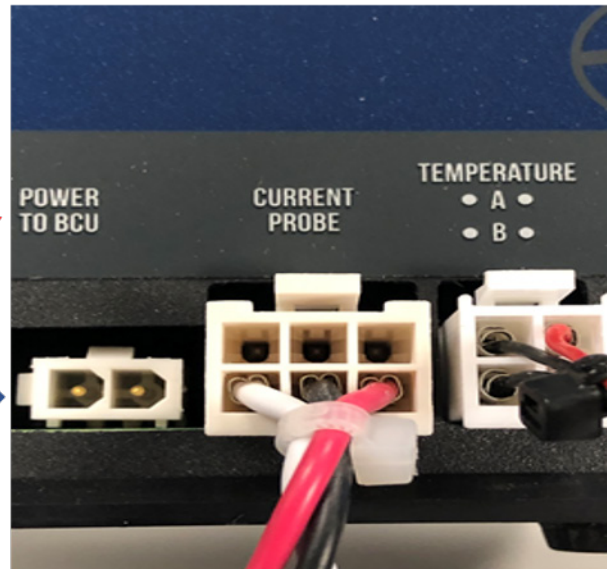
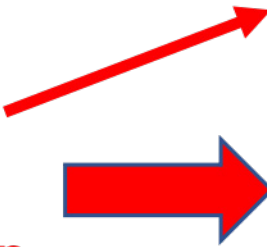

POWERING UP THE VTC

1. First, Connect the 3 pin (2 wires)
 - a. Connector from the VTC Power cable and/or the VTC Inductor Assembly to the **STRING VOLTAGE** port.
2. Next, install fuse into negative cable .
 - a. Insert the fuse into the fuse holder and tighten twist lock ring.
3. Last, install fuse into positive cable .
 - a. Insert the fuse into the fuse holder and tighten twist lock ring.



BCU INSTALLATION AND POWER

POWERING THE BCU

BCU Can be powered in two different ways:

- Option #1 - - AC Input, DC Output power supply into a wall outlet.
- Option #2 - - DC to DC Converter from the battery string.

In all cases to set up the BCU you must have:

- Ethernet connection
 - Direct connect to a laptop.
 - Connected to local area network (LAN).
 - Add: Permission to modify the Ethernet Address.

POWERING THE BCU (OPTION #1)

- AC Input to 9VDC Power Supply
 - Plug 9V AC Power Supply into wall outlet.
 - Connect plug in to 9VDC input on BCU.



AC Input to 9VDC Power Supply



BCU

POWERING THE BCU (OPTION #2)

- DC to DC Converter
 - Connect positive and negative terminals to the battery string.
 - Positive to most positive battery in the string.
 - Negative to the most negative battery in the string.
- Connect wires to the connections on the converter.
- Plug the converter cable into the 9VDC input on BCU.



100VDC-1000VDC



42VDC - 65VDC



**CELL 1
POSITIVE**

**LAST CELL
NEGATIVE**

WIRING THE 100VDC-1000VDC



CONNECTING THE HARNESS

1. Loosen terminal pins 1, 3, 4, 7, and ensure terminal pins 2, 5 and 6 are tightened closed.
2. Insert the red wire of harness P/N 10000006864 into terminal 3 (+Vin) and tighten.
3. Insert the black wire of harness P/N 10000006864 into terminal 1 (-Vin) and tighten. **(Figure 1)**
4. Insert the red wire of harness P/N 10000006863 into terminal 4 (+Vout) and tighten.
5. Insert the black wire of harness P/N 10000006863 into terminal 7 (-Vout) and tighten. **(Figure 2)**
6. Ensure no exposure copper wiring can be seen at any of the four terminals.
7. Place covers over each terminal. **(Figure 3)**

PIN CONNECTIONS							
PIN	1	2	3	4	5	6	7
FUNCTION	-Vin	NC	+Vin	+Vout	NC	NC	-Vout



FIGURE 1



FIGURE 2



FIGURE 3

48VDC TO DC CONVERTER INSTALLATION



DC-DC Converter Specifications

- Input Voltage Range: 42 - 65 Vdc
- Output Voltage: 12 Vdc +/-1% Load Regulation
- Output Power: 10 Watts Max
- Power Consumption: 1.8 Watts
- Power Efficiency: 86% Typical
- Temperature Range: -40 to 85°
- Dimensions: 3.972 in L x .876 in H x 0.6 in W

SETTING UP A CONNECTION TO THE BCU

CONNECTING TO A LAPTOP/PC

- To access the BCU using a web browser interface, connect a PC to the BCU through the Ethernet port.
- If BCU is already networked, you can access the BCU by directly connecting over the same network as the BCU using Chrome, Firefox™, or Safari®.
- Using an Ethernet cable.
 - Plug 10 base-T cable into RJ-45 connector Ethernet port on the BCU.
 - Connect other end of cable into RJ-45 jack (Network Interface Card) on laptop.



GEN 3 BCU WEB INTERFACE TO WINDOWS® 10

- Update connection properties for ability to direct connect to BCU module using Ethernet(RJ-45) Cat 5-6 cable.

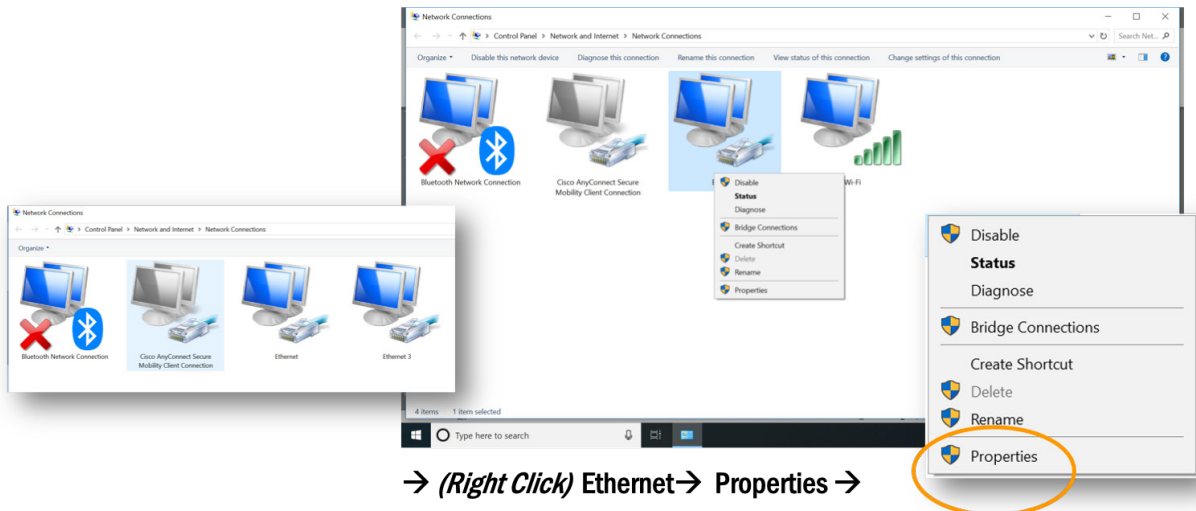

NOTE: See Windows® 7 Connection to BCU for information about connecting the BCU to Windows® 7.

- From properties window highlight Internet Protocol Version 4 (TCP/IP) > Properties- Use the Following IP Address-enter 192.168.168.167 (or any number different from 168 up to 255) for IP Address, 255.255.255.0 for Subnet Mask. Default gateway is not required.

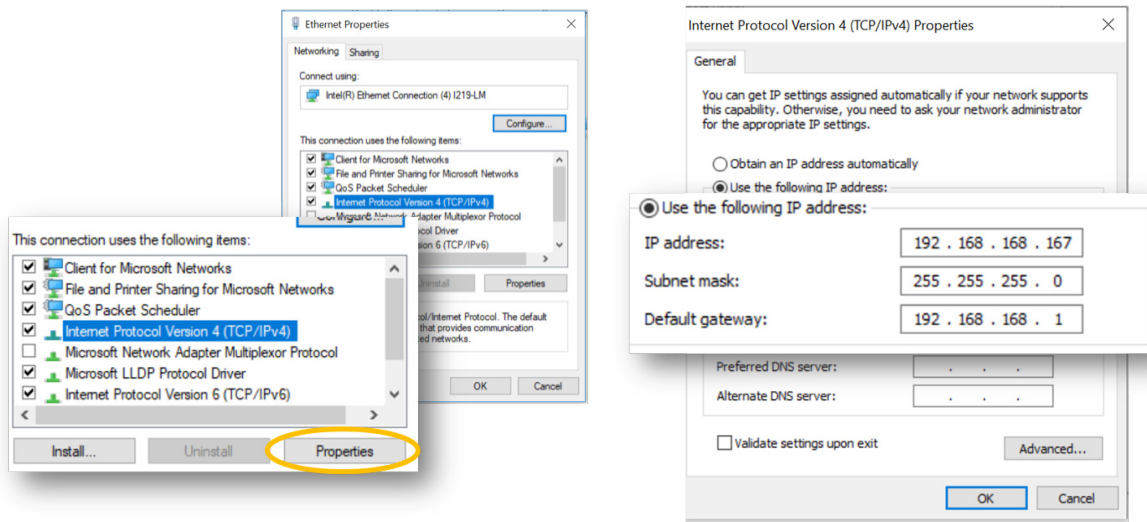

ACCESSING THE WEB BROWSER INTERFACE

NOTE: The first time you login you must create a password for user: ADMIN.

- Using laptop or PC, open a web browser.
 - Setup of network parameters covered in previous section.
 - Type in HTTPS://192.168.168.168 . YOU MUST USE HTTPS:
 - The CELLGUARD™ Gen III BCUs are password protected and user will need to enter applicable information relative to user account when properly connected.
 - Once properly logged into the system, user can confirm successful login in upper right corner.

The image shows a web browser interface with a security warning. On the left, there is a form titled "HOME" for creating a new password for the user "admin". The form includes fields for "New Password" and "Repeat Password", both masked with dots, and a "Set new password" button. On the right, a red warning triangle is displayed above the text "Your connection is not private". Below this, it states: "Attackers might be trying to steal your information from 192.168.168.168 (for example, passwords, messages, or credit cards). [Learn more](#)". The error code "NET:ERR_CERT_AUTHORITY_INVALID" is shown. A checkbox is checked, with the text: "Help improve Chrome security by sending URLs of some pages you visit, limited system information, and some page content to Google. [Privacy policy](#)". There are two buttons: "Advanced" (circled in yellow) and "Back to safety". Below the warning, there is a "Hide advanced" button and a "Back to safety" button. A text block explains: "This server could not prove that it is 192.168.168.168; its security certificate is not trusted by your computer's operating system. This may be caused by a misconfiguration or an attacker intercepting your connection." At the bottom, a link "Proceed to 192.168.168.168 (unsafe)" is circled in yellow.

- Once logged in, navigate to Settings-Configuration and set time out to a minimum of 8 hours.

Group	Parameter Name	Parameter Value
<input type="checkbox"/> System ID
<input type="checkbox"/> System Preferences
<input type="checkbox"/> Date/Time
<input type="checkbox"/> User Roles		
<input type="checkbox"/> Users		
<input type="checkbox"/> admin	Password ***** Session Timeout Session Number Limit 3	10 minutes 1 hour 8 hours 1 day Disabled
<input type="checkbox"/> Preferences

- Date/ Time:

NOTE: Navigate to Configuration, and set the time zone before setting the correct date and time under date and time section.

<input type="checkbox"/> Date/Time	Time Zone	United States - New York
	NTP Servers	

- Current Date/ Time
 - Use drop downs to set current date and time .
 - Click set, to update data/time on BCU.

CONVERGE™ HOME REPORTS MONITORING ▾ TOOLS ▾ SETTINGS ▾

- Preferences
- Configuration
- VTC Discovery
- Battery Data Entry
- Celltraq Commission
- Date/Time**

DATE/TIME

Current Date/Time: 2020 ▾ June ▾ 23 ▾ 11 ▾ : 23 ▾ : 20 ▾ Set

HARDWARE COMMISSIONING SENSORS AND VTC

SENSOR COMMISSIONING

QR CODE SCANNER

Ensure BCU and QR code scanner are attached to laptop and powered.



NOTE: The scanner must have the ability to scan a QR code. Simple bar scanners will not scan sensor data.

SCANNING SENSOR DATA

- Label each sensor with a sting number and sensor number prior to scanning sensors with the QR code scanner.

NOTE: Sensors must be scanned in order.

- Example: 24 battery sting > string 1/sensor 1 is first to scan, string 1/Sensor 2 is next, then string 1/sensor 3, then string 1/sensor 4, and so on until all 24 sensors for string 1 are successfully scanned.
- If you do not have QR code scanner, MAC addresses will need to be entered manually.

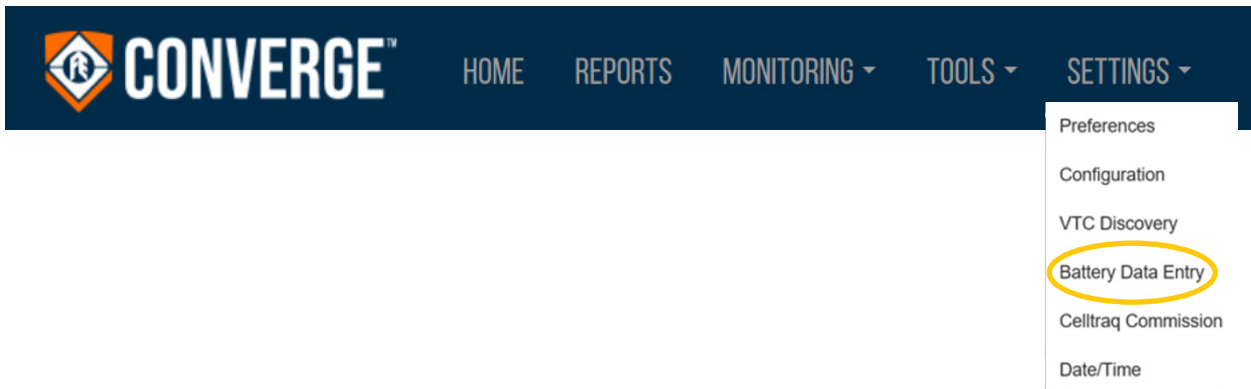

CONFIGURE SYSTEM PARAMETERS

- Click ">>" to expand a group to see the full programming section.
- Click "+" to add a String Battery.
- Click "-" to delete a String, Battery.
- Navigate to Settings > Configuration.
- Click on Show Errors to begin entering configuration.
- Click on <not set> to begin entering Site Name.
- After entering name you need to press the enter key to save.
- Continue programing all necessary parameters.
 - Click on Show Errors to see which parameters still need programming.
- Click save when all **RED** parameters sections are updated.

NOTE: After the battery parameters are saved – BCU will start to search for sensors.

The screenshot displays the CONVERGE web application interface. At the top, a dark blue navigation bar contains the CONVERGE logo and menu items: HOME, REPORTS, MONITORING, TOOLS, and SETTINGS. The SETTINGS menu is expanded, showing a list of options: Preferences, Configuration (circled in yellow), VTC Discovery, Battery Data Entry, Celltraq Commission, and Date/Time.

Below the navigation bar, the main content area is titled 'CONFIGURATION'. It features a red error banner that reads 'Configuration error'. Below this banner is a toolbar with buttons for 'Drag and drop: Move', 'Download', 'Upload...', 'Merge...', 'Revert', 'Save', and 'Show errors'. The main configuration area is divided into two sections, each with a table of parameters.

The top section is for 'System ID' (indicated by a checkbox) and contains the following parameters:

Group	Parameter Name	Parameter Value
System ID	Site Name	<not set>
	ID Line 1	
	ID Line 2	
	ID Line 3	

The bottom section is also for 'System ID' and contains the following parameters:

Group	Parameter Name	Parameter Value
System ID	Site Name	<input type="text"/>
	ID Line 1	
	ID Line 2	
	ID Line 3	
	ID Line 4	
ID Line 5		

BATTERY DATA ENTRY

ENTERING BATTERY MAC ADDRESS

- String > “Add string” will appear if a battery string has not been configured. You can start scanning sensors and this will be configured as String 1.
- Click on Battery 1
 - Use QR scanner to capture MAC address off back of sensor or manually Type in MAC if QR scanner is not available.

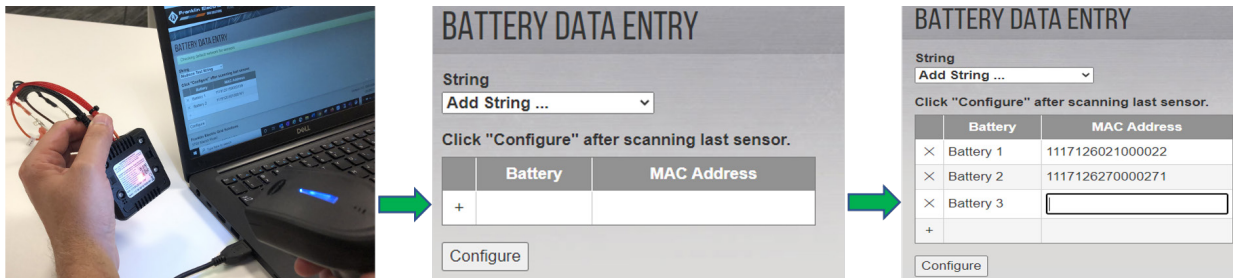
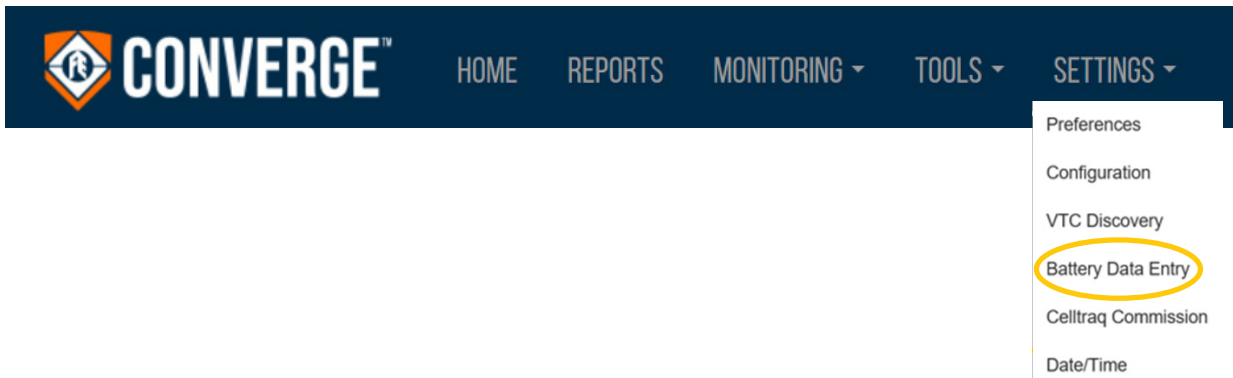

- Once all MAC addresses are added click “configure”

SCANNING SENSOR DATA

- Label each sensor with a sting number and sensor number prior to scanning sensors with the QR code scanner.

NOTE: Sensors must be scanned in order.

- Example: 24 battery sting > string 1/sensor 1 is first to scan, string 1/Sensor 2 is next, then string 1/sensor 3, then string 1/sensor 4, and so on until all 24 sensors for string 1 are successfully scanned.
- If you do not have QR code scanner, MAC addresses will need to be entered manually.

- Preferences
- Configuration
- VTC Discovery
- Battery Data Entry**
- Celltraq Commission
- Date/Time



BATTERY DATA ENTRY

String
String 1 ▾

Click "Configure" after scanning last sensor.

	Battery	MAC Address
×	Battery 1	0119126682000502
×	Battery 2	0119126680000500
×	Battery 3	0119126667000487
×	Battery 4	0519126816000636
×	Battery 5	<input type="text"/>
+		

Configure

- Navigate to Settings.
 - Configuration > Cell Guard > String > Batteries
- Confirm all MAC addresses are populated. Save the configuration. Attach the sensors to the wire harnesses and terminals, or attach the sensor to terminals (2 Volt, 12 Volt).

The screenshot shows the CONVERGE™ web interface. The top navigation bar includes HOME, REPORTS, MONITORING, TOOLS, and SETTINGS. The SETTINGS dropdown menu is open, with 'Configuration' highlighted. The main content area is titled 'CONFIGURATION' and contains a table of configuration groups. The 'Cell Guard' group is expanded, showing 'Strings' and 'Batteries' sub-sections. The 'Batteries' section is further expanded to show two battery entries, each with a 'MAC Address' and 'Conductance Reference' field. The 'MAC Address' for Battery 1 is 1119120159000159, and for Battery 2 it is 1119120161000161. The 'Conductance Reference' for both is 2,730 S.

Group	Parameter Name	Parameter Value
<input type="checkbox"/> System ID	
<input type="checkbox"/> System Preferences	
<input type="checkbox"/> Date/Time	
<input type="checkbox"/> User Roles		+
<input type="checkbox"/> Users	
<input type="checkbox"/> Networking	
<input type="checkbox"/> Communications	
<input type="checkbox"/> Diagnostics	
<input type="checkbox"/> Cell Guard	
<input type="checkbox"/> Strings		+
<input type="checkbox"/> Batteries		+
<input type="checkbox"/> Battery 1	MAC Address	1119120159000159
	Conductance Reference	2,730 S
<input type="checkbox"/> Battery 2	MAC Address	1119120161000161
	Conductance Reference	2,730 S

VTC COMMISSIONING

- Under settings, Navigate to VTC discovery.
- Click, “start VTC Autodiscover”.
- When the VTC is discovered, it will appear in the list under MAC address.
- Configure the VTC for the system you are working on.

CONVERGE™ HOME REPORTS MONITORING ▾ TOOLS ▾ SETTINGS ▾

Franklin Electric GRID SOLUTIONS HOME REPORTS MONITORING ▾ TOOLS ▾ SETTINGS ▾

VTC DISCOVERY

In VTC autodiscovery mode

Stop VTC Autodiscover

Rediscover Last scan: Oct 12, 2020, 11:51:05 AM

MAC Address	Test LED	Assign to String	Configure
0013A20041AAB874	Test	New String ▾	Configure

Franklin Electric Grid Solutions
3760 Marsh Road
Madison, Wisconsin 53718 USA
P: +1 (608) 838-8786

- Configuring the VTC for the system you are working on.

Clicking “Configure” will take you to the configuration page where the selected VTC MAC address will be automatically filled in for you. Once you add details, if needed, save the configuration and the system will commission the VTC to the system channel and pan id.

CONVERGE HOME REPORTS MONITORING TOOLS SETTINGS

CONFIGURATION

In VTC autodiscovery mode

Drag and drop: Move Download Upload... Merge... Revert Save

Group	Parameter Name	Parameter Value
System ID		---
System Preferences		---
Date/Time		---
User Roles		+
Users		---
Networking		---
Communications		---
Diagnostics		---
Cell Guard	Wireless PAN Id	73F1
	Wireless Channel	0x0C
	Enable Discharge Detection	Yes
	Plant-Wide Conductance Reference	No
	Default Battery Type	VRLA - Sealed
	Default Manufacturer	ENERSYS
	Default Model	12HX150
	Battery Conductance Reference	1,025 S
	Battery Voltage	12 V
Interval Tests		---
Strings		+
String 1	Name	String 1
	Has VTC	Yes
	VTC MAC Address	0013A20041AAB874
	Current Multiplier	1.00
	Reverse Current Polarity	No
	Adaptive Reference	Yes
	String-Wide Conductance Reference	No
	Battery Type	VRLA - Sealed
	Default Manufacturer	ENERSYS
	Default Model	12HX150
	Battery Conductance Reference	1,025 S
	Battery Voltage	12 V
	Battery Sensor Type	6-12 Volt UPS

Save configuration to commission the VTC and exit auto-discovery mode.

Auto-Filled MAC Address.

CONFIGURING MULTIPLE VTCs

- You can only configure one VTC a time.
- To add another VTC, go back to the VTC discovery page and get the next MAC address before you save the configuration so that they all get commissioned together.
- If you have more than one VTC, there are two ways you can accomplish distinguishing the MAC addresses. The first and easiest (if the computer is near the string or you are in communication with someone at the string location) is to use the “Test” button on the VTC Discovery page. This will cause the LED light on the front of the selected VTC to blink for a very brief period of time allowing you to distinguish which string it is installed on. The other option is to plug in one at a time and use the “Rediscover” button to find new VTCs that are on the default settings.

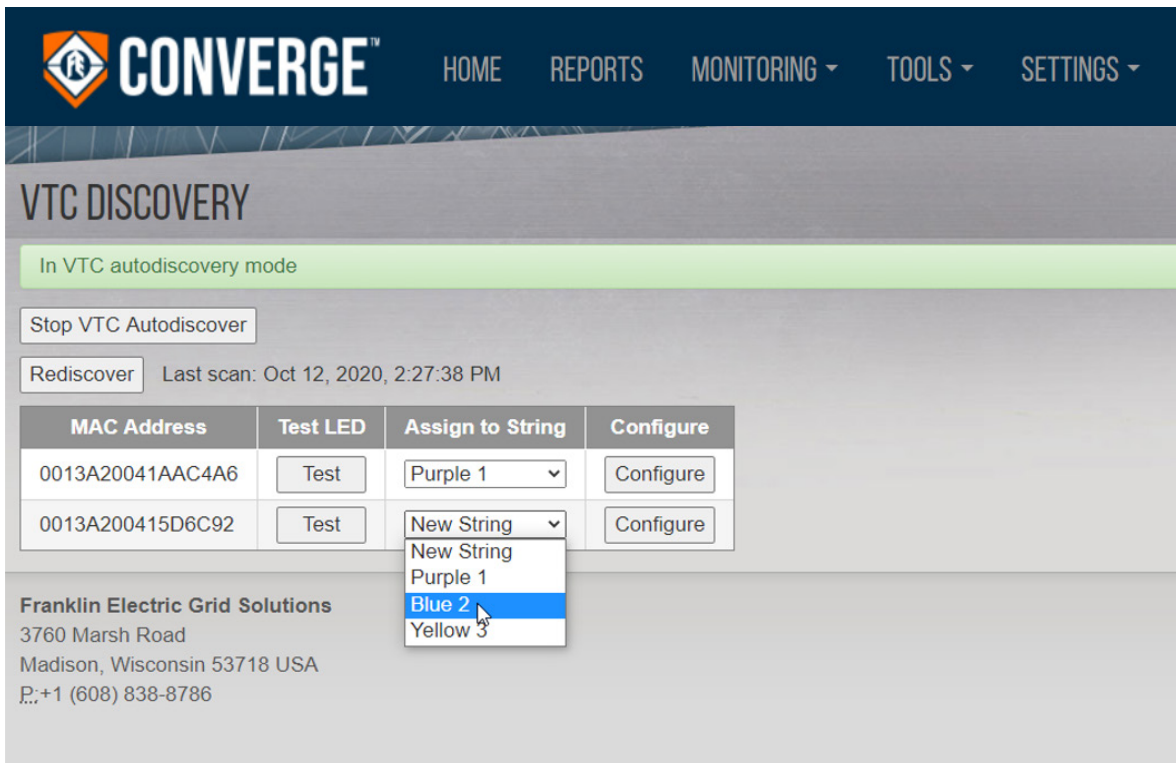

The screenshot shows the CONVERGE VTC Discovery page. At the top, there is a navigation bar with the CONVERGE logo and links for HOME, REPORTS, MONITORING, TOOLS, and SETTINGS. Below the navigation bar, the page title is "VTC DISCOVERY". A green banner indicates "In VTC autodiscovery mode". There are two buttons: "Stop VTC Autodiscover" and "Rediscover". The "Rediscover" button is active, and the last scan time is "Oct 12, 2020, 2:27:38 PM".

MAC Address	Test LED	Assign to String	Configure
0013A20041AAC4A6	<input type="button" value="Test"/>	Purple 1	<input type="button" value="Configure"/>
0013A200415D6C92	<input type="button" value="Test"/>	New String	<input type="button" value="Configure"/>

The dropdown menu for "Assign to String" is open, showing the following options: "New String", "Purple 1", "Blue 2", and "Yellow 3". The "Blue 2" option is currently selected.

Franklin Electric Grid Solutions
3760 Marsh Road
Madison, Wisconsin 53718 USA
P: +1 (608) 838-8786

BCU CONFIGURATION SETTING SYSTEM PARAMETERS

SETTING SYSTEM PARAMETERS

- Navigate to Settings > Configuration.
- To set system parameters, click the appropriate menu selection and edit the selection as needed and hit enter to save.
- Once all parameters are configured, click the confirmation option SAVE in upper right corner.
- You must have administrative access to make set up changes.

The screenshot shows the CONVERGE web interface. The top navigation bar includes HOME, REPORTS, MONITORING, TOOLS, and SETTINGS. The SETTINGS dropdown menu is open, with 'Configuration' highlighted. Below the navigation bar, the 'CONFIGURATION' section is visible, featuring a table with columns for Group, Parameter Name, and Parameter Value. The table lists various system parameters such as System ID, System Preferences, Date/Time, User Roles, Users, Networking, Communications, Diagnostics, and Cell Guard.

Group	Parameter Name	Parameter Value
System ID
System Preferences
Date/Time
User Roles	+	
Users
Networking
Communications
Diagnostics
Cell Guard

SYSTEM ID

- Site Name: Physical name of site; typically will have store number or other unique identifier.
- ID Line: These lines will contain physical address of site. This information will appear as header on reports and used to identify the site.
 - Other data can be entered such as IP address, serial number, phone numbers, etc.
- System Preferences
 - Language-select correct language.
 - Regional Formats-select appropriately.
 - Units-Temperature- Fahrenheit or Celsius.
- Date/ Time
 - Time Zone-Set correct time zone.
 - NTP Servers- If using NTP server, enter NTP server address.

CONFIGURATION

Drag and drop: Move Download Upload... Merge...

<input type="checkbox"/> Group »	Parameter Name	Parameter Value
<input type="checkbox"/> System ID »
<input type="checkbox"/> System Preferences »
<input type="checkbox"/> Date/Time »
<input type="checkbox"/> <input checked="" type="checkbox"/> System ID »	Site Name	Telco 12V Multi-String
<input type="checkbox"/>	ID Line 1	
<input type="checkbox"/>	ID Line 2	
<input type="checkbox"/>	ID Line 3	
<input type="checkbox"/>	ID Line 4	
<input type="checkbox"/>	ID Line 5	

<input type="checkbox"/> System Preferences	Language	English
	Regional Formats	United States
<input type="checkbox"/> Units	Temperature	Celsius

CELLGUARD™

CELLGUARD™

NOTE: If multiple units are in the same area, randomize the PAN ID and channel for each unit.

- Wireless PAN ID
- Wireless channel
- Enable Discharge Detection: Yes or No
- Plant-Wide Conductance Reference: Yes or No

NOTE: If battery manufacturer and/ or model is not selectable in drop down menu, custom must be selected from battery type and battery information entered manually

- Default Battery type: select correct battery type.
- Default manufacture: select battery Manufacture.
- Default model: Select battery model.
- Battery Conductance reference: enter the conductance reference if known or the calculated conductance value based on the age of the batteries.
- Battery voltage: select correct voltage for battery being monitored.

CONFIGURATION

Drag and drop: Move Download Upload... Merge...

Group	Parameter Name	Parameter Value
<input type="checkbox"/> System ID
<input type="checkbox"/> System Preferences
<input type="checkbox"/> Date/Time
<input type="checkbox"/> User Roles	+	
<input type="checkbox"/> Users
<input type="checkbox"/> Networking
<input type="checkbox"/> Communications
<input type="checkbox"/> Diagnostics
<input type="checkbox"/> Cell Guard

<input type="checkbox"/> Cell Guard	Wireless PAN Id	1450
	Wireless Channel	0x13
	Enable Discharge Detection	No
	Plant-Wide Conductance Reference	No
	Default Battery Type	VRLA - Sealed
	Default Manufacturer	ENERSYS
	Default Model	12V170F
	Battery Conductance Reference	2,370 S
	Battery Voltage	12 V

INTERVAL TESTS

- Conductance (G Interval): Number days between Conductance tests.
- Voltage/Temperature (VT Interval): number of hours between Voltage and Temperature tests.

RECOMMENDED INTERVAL SETTINGS		
<input type="checkbox"/> Interval Tests	G Interval	7.0 Days
	VT Interval	4.0 Hours

STRINGS

- Click “+” to add string .
- Strings will list in order they are programmed.
- Stings can be reorganized using drag and drop feature.

<input type="checkbox"/> Strings	+		
<input type="checkbox"/> Purple	»
<input type="checkbox"/> Blue	»
<input type="checkbox"/> Yellow	»
<input type="checkbox"/> Lab Batteries	»
<input type="checkbox"/> String 5	»

- NAME- Name assigned to string.
- Has VTC- Yes or NO
- VTC MAC Address: auto populated with VTC Discovery.
- Current multiplier: if only one cable, enter 1 (when there are multiple current carrying cables and all cables cannot fit through the aperture of the current transducer, then the value to enter is the total number of current carrying cables that are in parallel).
- Adaptive reference: Yes or NO
- Default manufacture: select battery Manufacture.
- Default model: Select battery model.
- Battery Conductance reference: enter battery conductance reference.
- Battery voltage: select correct voltage for battery being monitored.
- Battery Sensor Type: select correct sensor installed on battery.

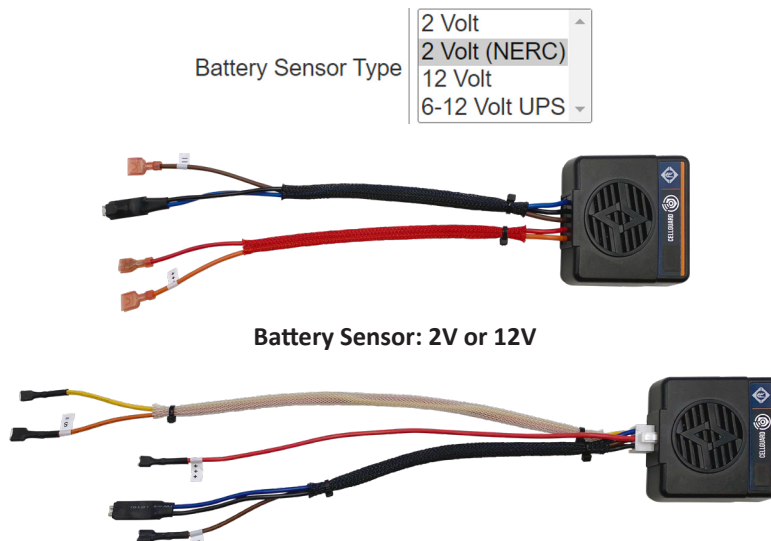

Battery Sensor: 2V (NERC), 6-12V UPS

<input type="checkbox"/> Strings	+		
<input type="checkbox"/> Purple	-	Name	Purple
		Has VTC	Yes
		VTC MAC Address	0013A200419340D1
		Current Multiplier	1.00 A
		Adaptive Reference	Yes
		String-Wide Conductance Reference	No
		Battery Type	VRLA - Sealed
		Default Manufacturer	ENERSYS
		Default Model	12V170F
		Battery Conductance Reference	2,370 S
		Battery Voltage	12 V
		Battery Sensor Type	12 Volt
<input type="checkbox"/> Batteries	»
<input type="checkbox"/> Battery Thresholds	»
<input type="checkbox"/> String Thresholds	»

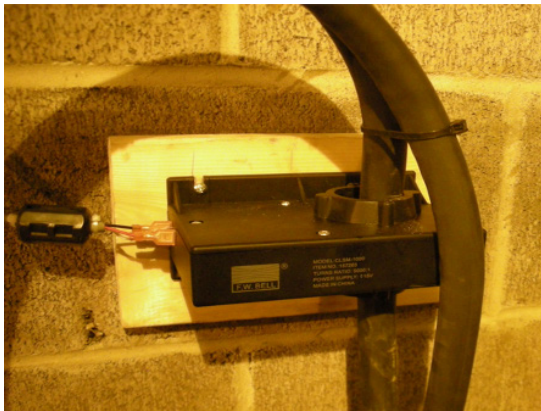

CURRENT MULTIPLIER WOULD BE : 2

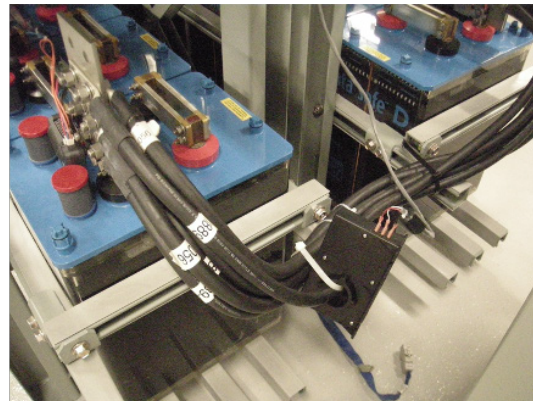

CURRENT MULTIPLIER WOULD BE : 6

BATTERIES

- Select “+” to add batteries.
 - MAC Address
- NOTE:** this section will auto populate using battery Data entry screen.
- Updating data on all batteries in string.
 - Make updates to parameters at string level.
 - Manufacture
 - Model
 - Conductance Reference
 - Voltage
 - Sensor type
- Change string-wide conductance reference to Yes.
- Change back to no and changes will now reflect in all batteries.

<input type="checkbox"/> Madison test String	-	Name	Madison test String
		Has VTC	No
		Adaptive Reference	Yes
		String-Wide Conductance Reference	No
		Battery Type	Custom
		Default Custom Manufacturer	Hoppecke
		Default Custom Model	1234567-XL-12V
		Default Custom Conductance Reference	3,000
		Default Custom Voltage	12 V
		Battery Sensor Type	<not set>
<input type="checkbox"/> Batteries	+		
<input type="checkbox"/> Battery 1	-	MAC Address	<not set>
		Custom Manufacturer	Hoppecke
		Custom Model	1234567
		Custom Conductance Reference	3,000 S
		Custom Voltage	12 V
<input type="checkbox"/> Battery 2	-	MAC Address	<not set>
		Custom Manufacturer	Hoppecke
		Custom Model	1234567-XL
		Custom Conductance Reference	3,000 S
		Custom Voltage	12 V

String-Wide Conductance Reference

Yes ▲
No
▼

BATTERY THRESHOLDS

- Conductance
 - High Alarm, High warning, low warning, low alarm –level of conductance that will trigger alarms.
- Strap resistance
 - High Alarm, High warning, low warning, low alarm –level of strap resistance that will trigger alarms.
- Conductance %
 - High Alarm, High warning, low warning, low alarm –level of conductance % that will trigger alarms.
- Temperature
 - High Alarm, High warning, low warning, low alarm –level of temperature that will trigger alarms.
- Voltage
 - High Alarm, High warning, low warning, low alarm –level of voltage that will trigger alarms.

<input type="checkbox"/> Battery Thresholds			
<input type="checkbox"/> Conductance	Enable	Yes	
	High Alarm	3,500 S	
	High Warning	3,000 S	
	Low Warning	1,500 S	
	Low Alarm	1,000 S	
<input type="checkbox"/> Strap Resistance	Enable	Yes	
	High Alarm	<not set>	
	High Warning	<not set>	
	Low Warning	<not set>	
	Low Alarm	<not set>	
<input type="checkbox"/> Conductance %	Enable	Yes	
	High Alarm	130.0 %	
	High Warning	115.0 %	
	Low Warning	80.0 %	
	Low Alarm	60.0 %	
<input type="checkbox"/> Temperature	Enable	Yes	
	High Alarm	130 °F	
	High Warning	100 °F	
	Low Warning	40 °F	
	Low Alarm	30 °F	
<input type="checkbox"/> Voltage	Enable	Yes	
	High Alarm	14.500 V	
	High Warning	14.000 V	
	Low Warning	12.000 V	
	Low Alarm	11.000 V	

STRING THRESHOLDS

- Voltage
 - High Alarm, High warning, low warning, low alarm –level of voltage that will trigger alarms.
- Current
 - High Alarm, High warning, low warning, low alarm –level of current that will trigger alarms.

<input type="checkbox"/> String Thresholds			
<input type="checkbox"/> Voltage	Enable	Yes	
	High Alarm	58.000 V	
	High Warning	56.000 V	
	Low Warning	48.000 V	
	Low Alarm	44.000 V	
<input type="checkbox"/> Current	Enable	Yes	
	High Alarm	<not set>	
	High Warning	<not set>	
	Low Warning	<not set>	
	Low Alarm	<not set>	

TEMPERATURE ZONES

- Name- name of zone being measured.
- Connection type: VTC or BCU
- Channel- Channel of temperature sensor.

- High alarm- temperature to trigger high temperature alarm.
- Low Alarm- temperature to trigger low temperature alarm.

<input type="checkbox"/> Temperature Zones	+		
<input type="checkbox"/> Purple A	-	Name	Purple A
		Connection Type	VTC
		VTC	Purple
		Channel	A
		High Alarm	90 °F
		Low Alarm	32 °F

ELS STRANDS

- Name- Name of ELS Strand
- Digital Input # - 1 or 2

<input type="checkbox"/> ELS Strands	+		
<input type="checkbox"/> ELS Strand 1	-	Name	ELS Strand 1
		Digital Input #	<not set>

To configure additional battery strings with the same parameters, click Drag and drop > Move/Copy > Copy, and then click the section to copy, and drag it to the copy location.

- Example:
 - A new String was added, String 1
 - Clicked "Drag and drop: Copy" and selected String 1
 - Dragged to Strings
 - Now String 2 was created using String 1's parameters for String 2

CONFIGURATION

Drag and drop: Move | Drag and drop: Copy | Download | Upload... | Merge... | Revert | Save | Show errors

Group	Parameter Name	Parameter Value
String 1	Name	String 1
	Has VTC	Yes
	VTC MAC Address	1234567891011121
	Current Multiplier	1.00 A
	Adaptive Reference	Yes
	String-Wide Conductance Reference	No
	Battery Type	VRLA - Sealed
	Default Manufacturer	POWERSAFE/HAWKER
	Default Model	BC25
	Battery Conductance Reference	550 S
	Battery Voltage	12 V
	Battery Sensor Type	12 Volt

<input type="checkbox"/> String 2	-	Name	String 2
		Has VTC	No
		Adaptive Reference	Yes
		String-Wide Conductance Reference	No
		Battery Type	VRLA - Sealed
		Default Manufacturer	POWERSAFE/HAWKER

DOWNLOADING A CONFIGURATION FILE

CONFIGURATION

Drag and drop: Move **Download** Upload... Merge...

Group	Parameter Name	Parameter Value
<input type="checkbox"/> System ID		...
<input type="checkbox"/> System Preferences		...
<input type="checkbox"/> Date/Time		...
<input type="checkbox"/> User Roles		...
<input type="checkbox"/> Users		...
<input type="checkbox"/> Networking		...
<input type="checkbox"/> Communications		...
<input type="checkbox"/> Diagnostics		...
<input type="checkbox"/> Cell Guard		...

Franklin Electric Grid Solutions
3760 Marsh Road
Madison, Wisconsin 53718 USA
P: +1 (608) 838-8716

Version 1.1.1
00-B827-EB0A-C080-00

config (10).xml

config (10).xml

Show all

CONFIGURATION

Drag and drop: Move Download Upload... Merge...

Group	Parameter Name	Parameter Value
<input type="checkbox"/> System ID		...
<input type="checkbox"/> System Preferences		...
<input type="checkbox"/> Date/Time		...
<input type="checkbox"/> User Roles		...
<input type="checkbox"/> Users		...
<input type="checkbox"/> Networking		...
<input type="checkbox"/> Communications		...
<input type="checkbox"/> Diagnostics		...
<input type="checkbox"/> Cell Guard		...

Franklin Electric Grid Solutions
3760 Marsh Road
Madison, Wisconsin 53718 USA
P: +1 (608) 838-8788

Version 1.1.1
827-EB0A-C080-00

Open

This PC > Documents > Grid Solutions > Gen 3 > Setup Files

Name	Status	Date modified	Type	Size
Gen 3 BCU Set Up file.xml		6/16/2021 4:14 PM	XML Document	9 KB

File name: _____ Custom Files (*.xml;*.xml*)

Open Cancel

VERIFY INSTALLATION AND CONFIGURATION

- Go to; Tools > Manual Operations
 - Manual operations tab can be used to test individual sensors and to test entire string.
 - VT - Voltage / Temperature testing.
 - G - Conductance testing.

NOTE: Once tests are initiated, navigate to Monitoring>Status to see new readings populate.

CONVERGE HOME REPORTS MONITORING TOOLS SETTINGS

MANUAL OPERATIONS

Action Level	VT	G	Adaptive Reference
Site	Start VT	Start G	Reset Adaptive Reference
String 1			Reset Adaptive Reference
Battery 1	Start VT	Start G	Reset Adaptive Reference
Battery 2	Start VT	Start G	Reset Adaptive Reference
Battery 3	Start VT	Start G	Reset Adaptive Reference
Battery 4	Start VT	Start G	Reset Adaptive Reference
Battery 5	Start VT	Start G	Reset Adaptive Reference
Battery 6	Start VT	Start G	Reset Adaptive Reference
Battery 7	Start VT	Start G	Reset Adaptive Reference
Battery 8	Start VT	Start G	Reset Adaptive Reference

Upgrade
OTA Update
Modbus Registers
Manual Operations
Reset
About

SETTING BCU OUTPUT COMMUNICATIONS

NETWORKING > ETHERNET

IPV4

- **Method:**
 - Manual: Enter IP address manually.
 - DHCP: Obtain a valid IP address.
- **Address:** IP address must either be address on network or static IP provide by service provider.
- **Network Mask:** The mask must match that of the network the BCU is connected to.
- **Gateway:** Logical address to the nearest router port.
- **DNS Servers:** Domain Name Systems: Required if using email functionality of BCU.
- **DHCP Server:** Enable/Disable
 - Start: 2-254
 - Limit: 1-50
 - Lease Time: 2-1440 (in minutes)

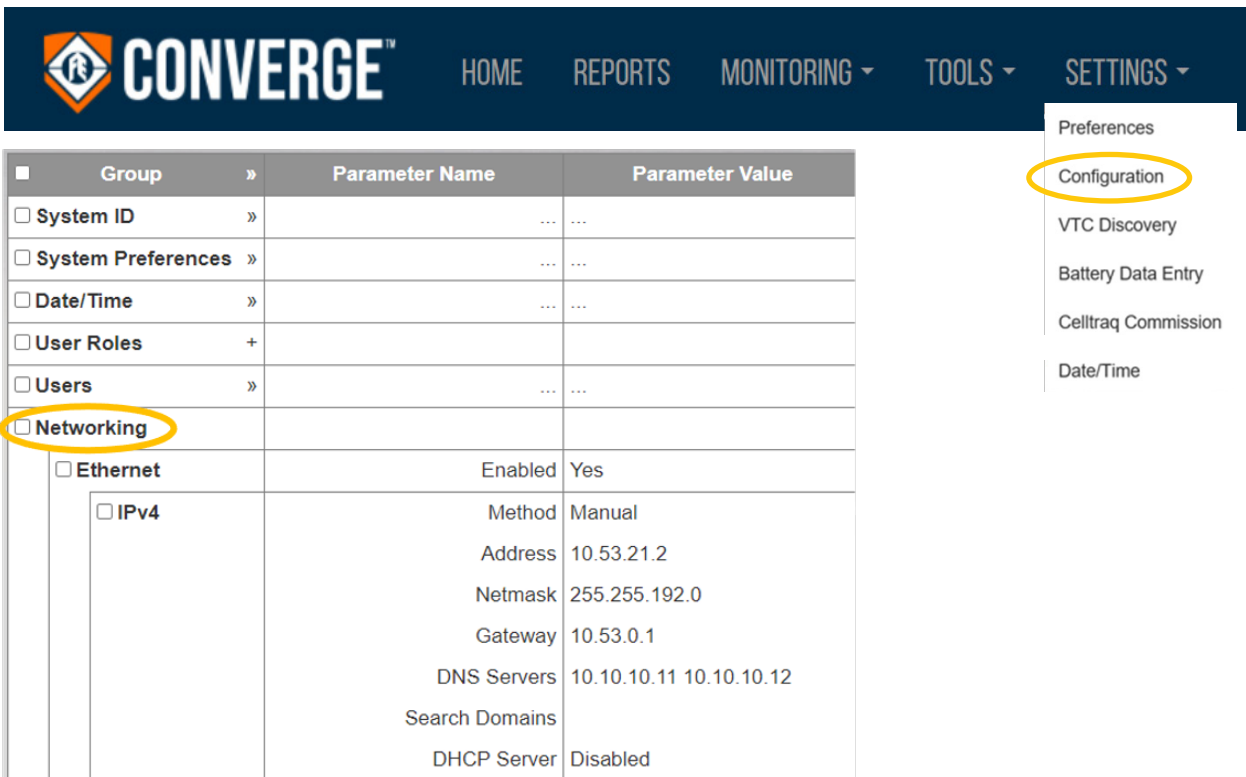

Group	Parameter Name	Parameter Value
<input type="checkbox"/> System ID	
<input type="checkbox"/> System Preferences	
<input type="checkbox"/> Date/Time	
<input type="checkbox"/> User Roles		
<input type="checkbox"/> Users	
<input type="checkbox"/> Networking		
<input type="checkbox"/> Ethernet	Enabled	Yes
<input type="checkbox"/> IPv4	Method	Manual
	Address	10.53.21.2
	Netmask	255.255.192.0
	Gateway	10.53.0.1
	DNS Servers	10.10.10.11 10.10.10.12
	Search Domains	
	DHCP Server	Disabled

COMMUNICATIONS>PROTOCOLS

CELLTRAQ™

- Enabled : Yes or NO (Must be set to Yes and at least one battery string must be created for “CELLTRAQ™ commission” to appear in the settings list).
- Site Serial Number: serial number of BCU. (Sites with multiple BCUs reporting to CELLTRAQ™ require programming same serial number in each BCU.)
- Site Name: site name for battery Hierarchy.
- Plant Name: plant name for battery hierarchy.
- Server: IP address of server where CELLTRAQ™ is located.
- Port: SMTP Port number on server.
- Enable debugging: Yes or No

The screenshot shows the CONVERGE™ web interface. The navigation bar includes HOME, REPORTS, MONITORING, TOOLS, and SETTINGS. The SETTINGS dropdown menu is open, showing options like Preferences, Configuration (highlighted), VTC Discovery, Battery Data Entry, Celltraq Commission, and Date/Time. The main content area displays a table of configuration parameters. The 'Communications' group is expanded, and the 'Protocols' sub-group is also expanded. The 'Celltraq' protocol is checked, and its parameters are listed:

Group	Parameter Name	Parameter Value
<input type="checkbox"/> System ID	
<input type="checkbox"/> System Preferences	
<input type="checkbox"/> Date/Time	
<input type="checkbox"/> User Roles		+
<input type="checkbox"/> Users	
<input type="checkbox"/> Networking	
<input checked="" type="checkbox"/> Communications		
<input checked="" type="checkbox"/> Protocols		
<input checked="" type="checkbox"/> Celltraq	Enabled	Yes
	Site Serial	0617120375000006-120120
	Site Name	FE_Madison
	Plant Name	PKL
	Server	23.99.225.231
	Port	25
	Enable Debugging	No
<input type="checkbox"/> Modbus	Enabled	No
<input type="checkbox"/> SNMP	Enabled	No
<input type="checkbox"/> MQTT		+

MODBUS

- Enabled: Yes or NO
- Port: Modbus port assignment.

SNMP V3

NOTE: Set the SNMP Configuration to match the protocol of the device the BCU will communicate to using SNMP.

	SNMP Version	SNMP v3
	SNMPv3 User Name	12345678910
	Authentication Protocol	MD5
	Authentication Pass Phrase	<not set>
	Privacy Protocol	AES
	Set Privacy Pass Phrase	Yes
	Privacy Pass Phrase	<not set>
<input type="checkbox"/> Notifications +	Authentication Failure Traps	Enabled
<input type="checkbox"/> -	Host	<not set>
	Port	162
	Notification Type	SNMPv3 Trap
<input type="checkbox"/> -	Host	<not set>
	Port	162
	Notification Type	SNMPv3 Trap
<input type="checkbox"/> -	Host	<not set>
	Port	162
	Notification Type	SNMPv3 Trap

MQTT

- Click “+” to add connection.
- Connection 1
 - Name- Name of connection.
 - Service-select service for connection.
 - Password- set password for connection.
- Click “-” to remove connection.

The screenshot shows the Converge web interface. At the top, there is a navigation bar with 'HOME', 'REPORTS', 'MONITORING', 'TOOLS', and 'SETTINGS'. The 'SETTINGS' menu is open, showing options like 'Preferences', 'Configuration', 'VTC Discovery', 'Battery Data Entry', 'Celltraq Commission', and 'Date/Time'. The 'Configuration' option is circled in yellow. Below the navigation bar, the 'Communications' section is circled in yellow, containing a table with columns for 'Name', 'Service', and 'Password'. The 'Protocols' section is also circled in yellow, containing a table with columns for 'Name', 'Service', and 'Password'. The 'MQTT' section is expanded, showing 'Connection 1' with 'Service' set to 'Diagnostic' and 'Password' set to '<not set>'. The 'Celltraq' and 'Modbus' protocols are also listed with their respective settings.

CELLTRAQ™ COMMISSION

- Commission site to CELLTRAQ™
 - Complete programming in CELLTRAQ™ section under configuration.
 - This should then populate in the CELLTRAQ™ commission screen.
 - Once all data is confirmed, click on Commission site to CELLTRAQ™.
 - Verify in CELLTRAQ™ the site was created.

The screenshot shows the CONVERGE web interface. The top navigation bar includes HOME, REPORTS, MONITORING, TOOLS, and SETTINGS. The SETTINGS menu is open, showing options like Preferences, Configuration, VTC Discovery, Battery Data Entry, Celltraq Commission (highlighted), and Date/Time. The main content area is titled 'CELLTRAQ COMMISSION' and contains a 'Commission Site to Celltraq' section. This section includes a 'Site Configuration' table and a 'String Configuration' table. The 'Site Configuration' table is circled in yellow and contains the following data:

Site Configuration	
Site Serial	00B827EBE69A1200_20200724
Site Name	Saco Test System (UPS)
Plant Name	UPS 12V Sensor Array
Server	23.99.225.231
Port	25

Below the 'Site Configuration' table is a 'String Configuration' table with the following data:

Name	Total
String 1	40

To the right of the 'String Configuration' table is a 'Protocols' table. The 'Celltraq' protocol is checked and has the following configuration:

Enabled	Yes
Site Serial	00B827EBE69A1200_20200724
Site Name	Saco Test System (UPS)
Plant Name	UPS 12V Sensor Array
Server	23.99.225.231
Port	25
Enable Debugging	No

NOTE: CELLTRAQ™ must be enabled and at least one battery string must be created for “CELLTRAQ™ commission” to appear in the settings list.

NOTE:

- If CELLTRAQ™ was previously used, Site, Plant, and String names must match CELLTRAQ™ identically.
- Site Serial number must match exactly what is populated in CELLTRAQ™.

TOOLS>MODBUS REGISTER

1. Click Tools>Modbus Registers.
2. Click the string to display the battery register.
3. The Modbus register map is provided upon request.

The screenshot shows the CONVERGE web interface. At the top is a dark blue navigation bar with the CONVERGE logo and menu items: HOME, REPORTS, MONITORING, TOOLS, and SETTINGS. The TOOLS dropdown menu is open, showing options: Upgrade, OTA Update, Modbus Registers (highlighted with a yellow circle), Manual Operations, Reset, and About.

Below the navigation bar is a white panel titled "MODBUS REGISTERS". It contains a sub-header "Click String to Display Battery Registers" and a list of expandable sections: [-] Purple, [+] Blue, [+] Yellow, [+] Lab Batteries, and [+] String 5. The "[-] Purple" section is expanded, showing a table with the following data:

Battery	MAC Address	Register
1	1119120158000158	2000
2	1119120165000165	2016
3	1119120164000164	2032
4	1119120160000160	2048

Intentionally Blank



Franklin Electric
GRID SOLUTIONS

10000008420 r2