



Franklin Electric
GRID SOLUTIONS

CELLGUARD™
WIRED BATTERY MONITORING SYSTEM
INSTALLATION GUIDE

The information in this publication is provided for reference only. While every effort has been made to ensure the reliability and accuracy of the information contained in this manual at the time of printing, we recommend that you refer to the appropriate website for the most current version of this manual. All product specifications, as well as the information contained in this publication, are subject to change without notice. Franklin Electric Co., Inc. does not assume responsibility and expressly disclaims liability for loss, damage, or expense arising out of, or in any way connected with, installation, operation, use, or maintenance by using this manual. Franklin Electric Co., Inc. assumes no responsibility for any infringement of patents or other rights of third parties that may result from use of this manual or the products. We make no warranty of any kind with regard to this material, including, but not limited to, the implied warranties of merchantability and fitness for a particular purpose.

Copyright © 2020 Franklin Electric Co., Inc., Madison, WI 53718. All world rights reserved. No part of this publication may be stored in a retrieval system, transmitted, or reproduced in any way, including, but not limited to, photocopy, photograph, magnetic, or other record, without the prior written permission of Franklin Electric Co., Inc.

For technical assistance, please contact:
Franklin Electric Grid Solutions
3760 Marsh Rd. • Madison, WI 53718, USA
Tel: +1 608 838 8786 • Fax: +1 608 838 6433
Tel: USA & Canada +1 800 225 9787

Cellguard and Celltraq are trademarks of Franklin Electric Company, Inc.

167-000800 r1

Conventions used in this manual

This manual includes safety precautions and other important information presented in the following format:

NOTE: This provides helpful supplementary information.

IMPORTANT: This provides instructions to avoid damaging hardware or a potential hazard to the environment, for example: fuel leakage from equipment that could harm the environment.

▲ CAUTION: This indicates a potentially hazardous situation that could result in minor or moderate injury if not avoided. This may also be used to alert against unsafe practices.

▲ WARNING: This indicates a potentially hazardous situation that could result in severe injury or death if not avoided.

▲ DANGER: This indicates an imminently hazardous situation that will result in death if not avoided.

Operating precautions

▲ WARNING: IMPORTANT SAFETY INSTRUCTIONS. BEFORE INSTALLING ANY FRANKLIN ELECTRIC GRID SOLUTIONS EQUIPMENT, READ THIS GUIDE AND FOLLOW SAFETY AND OPERATING INSTRUCTIONS. SAVE THESE INSTRUCTIONS.

▲ WARNING: Risk of explosive gases: Batteries generate explosive gases during normal operation, and when discharged or charged.

▲ WARNING: To reduce risk of battery explosion, follow these safety instructions and those published by the battery manufacturer and the manufacturer of any equipment you intend to use in the vicinity of a battery. Review cautionary marking on these products and on the battery cabinets, battery racks, battery rooms, and on equipment containing the battery.

▲ WARNING: Do not disassemble any equipment; contact Franklin Electric Grid Solutions when a repair is required. Incorrect reassembly may result in a risk of electric shock or fire.

▲ WARNING: Use Franklin Electric Grid Solutions equipment in a dry, well-ventilated area.

▲ WARNING: Do not expose Franklin Electric Grid Solutions equipment to rain or snow.

▲ WARNING: To avoid electric shock when testing jars, abide by your company's safety practices and the following guidelines:

▲ WARNING: Perform service work only for which you have been trained.

▲ WARNING: Refer to NFPA 70E for electrical safety requirements.

▲ WARNING: Use of Personal Protection Equipment (PPE) and Protective Clothing per NFPA 70E guidelines is required. Some examples of these, but not limited to, are: Electrical-insulating, acid-resistant, and protective gloves and sleeves per ASTM D 120, OSHA 29 CFR 1910.137, and NFPA 70E requirements; Protective footwear; Aprons (acid-resistant); Insulating blankets; On-site spill kits; Protective clothing for voltage levels, level of corrosive protection, and the amount of arc-flash protection provided; Insulated rescue hooks or other means for pulling personnel from live circuits; Eyewash stations or portable eyewash bottles; Class "C" dry chemical re extinguishers instead of water around battery systems.

▲ WARNING: Always have someone within range of your voice, or close enough to come to your aid, when working around lead acid batteries.

▲ WARNING: Have plenty of fresh water and baking soda nearby in case battery acid contacts skin, clothing or eyes.

▲ WARNING: If battery acid contacts skin or clothing, wash immediately with baking soda and water. If acid enters the eye, immediately flush with cold running water for at least 10 – 15 minutes, and seek medical attention.

▲ WARNING: Never smoke or allow a spark or flame in the vicinity of a battery or engine.

▲ WARNING: Be extra cautious to reduce risk of dropping a metal tool onto the battery. It might spark or short circuit the battery or other electrical part that may cause an explosion.

▲ WARNING: Before working with a lead-acid battery, remove personal metal items such as rings, bracelets, necklaces, watches, etc. A lead-acid battery can produce a short circuit current high enough to weld such items causing a severe burn.

▲ WARNING: Always wear safety glasses with side shields in the vicinity of battery work per 29CFR1910.133 (OSHA).

▲ WARNING: Do not disconnect the battery cables from power systems during the test without authorization.

▲ WARNING: Do not place yourself in an electrical circuit.

▲ WARNING: Avoid simultaneous contact with the jar and with the battery cabinet, racks, or hardware that may be grounded.

▲ WARNING: Battery posts, terminals, and related accessories contain lead and lead compounds, chemicals known to cause cancer and birth defects or other reproductive harm. Wash hands after handling.

Contents

- Introduction1
- System components2
 - Accessories4
 - Battery sensor components5
 - String sensor components.....5
 - The BC.....6
 - Specific functions.....6
 - Components7
 - Indicator lights7
- Installation.....9
 - Assembly.....9
 - Numbering batteries.....9
 - Addressing11
 - Installing sensor cables.....12
 - Crimping sensor cables.....12
 - Addressing sensors13
 - Addressing the TC.....14
 - Connecting the BC and TC.....15
 - The BC.....15
 - The TC15
 - Wiring the TA16
 - TA 116
 - Wiring multiple string sensors in series17
 - Wiring multiple string sensors in parallel.....17
 - Wiring the BC and TC.....18
 - The TC18
 - The BC.....18
 - Multiple TCs18
 - Connecting the current transducer19
 - Powering the BC20
- Commissioning the BC.....21
 - Connecting the BC web interface.....21
 - Using the Integrator tool22
 - Setting up string parameters23
 - Changing port settings.....23
 - Changing IR settings.....25
 - Connecting the BC web interface.....26

Configuring network connections	26
Performing the Resistance Test	28
Confirming IR values	28
Configuring the Franklin Interface (FI)	29
Starting the FI	30
Commissioning the site	32
Setting up batteries.....	33
Setting alert limits.....	35
Setting discharge limits.....	35
Testing and confirming communication	36
Editing IP address names.....	37

Introduction



Franklin Electric Grid Solutions Wired Battery Monitoring System (BMS) consists of battery sensors (TA) that measure voltage, temperature, and the internal resistance of the battery. TC sensors measure the battery string current and ambient temperature. Both sensors report data to the Base Controller (BC) module:

- The BC:
 - Communicates through Ethernet (RJ-45) or RS-485.
 - Must have monitoring software and middleware for you to view data.
 - Uses Integrator software to configure the BC during installation.
- The standard configuration:
 - Allows you online monitoring of cell voltage, internal resistance, and temperature, as well as string voltage, charge and discharge current, and ambient temperature.
 - Provides automatic over-limit alarms.
 - Provides sata storage functions and can upload data though an RS-485 or network port.
 - Has one dry-contact input.

System components



1. BC.
2. Battery sensor module.
3. String sensor module.
4. Current transducer.
5. Celltraq™ data management software.

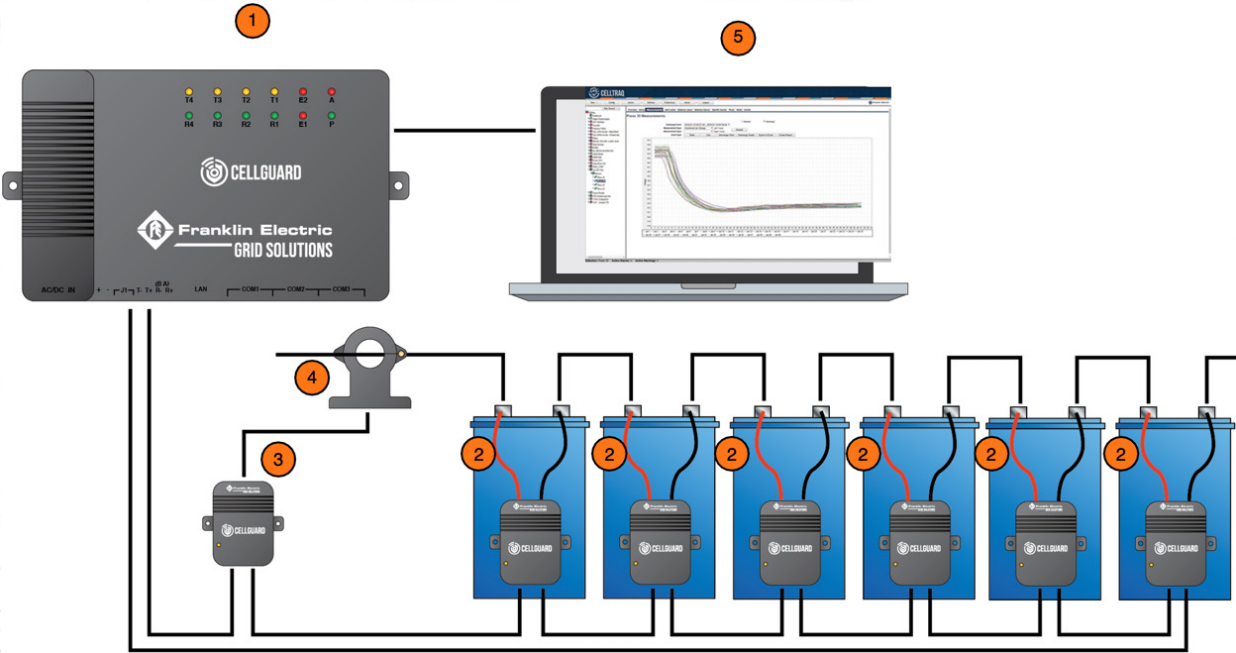

- The TAs collect the voltage, internal resistance, and temperature of each cell.
- The TC collects the ambient temperature and the charge and discharge current of battery strings.
- All sensors and TCs are connected through a UART bus, back to the BC.
- The BC is connected through Ethernet or a serial port to give you centralized management and allow you to view the health of battery string.
- TAs monitor cell voltage, Internal resistance and temperature, and uploads data through the COM port:



- TAs are powered by the monitored battery:
 - 1V Ni-Cd, 13mA maximum.
 - 6V, less than 7mA.
 - 2V current absorption, 7mA maximum (no more than 13mA).
 - 12V current absorption, 3mA maximum (no more the 7mA).
- Sensors must be installed on a battery with the appropriate voltage for the sensor or the unit can be damaged:
 - 1V Ni-Cd only.
 - 6V battery only.
 - 2V battery only.
 - 12V battery only.
- TCs monitor charge and discharge current and ambient temperature for one string. The TC communicates with the BC through the COM1 and COM2 serial ports. Each string must have separate TCs.
 - The current threshold is -3 Amp with a sample rate every 20 seconds.



Accessories

- Battery tabs (acquisition terminal).
- The Address Modifier-HA-6224AAAO is used to address TAs and TCs:



- The Interconnect cable is used to connect TAs and TCs to the BC and is included with sensors: 13" and TC-8 m (25").



- The sensor-battery cable is included with TAs.



Battery sensor components



1. Indicator light.
2. Battery connection port.
3. COM port.

String sensor components



1. Indicator light.
2. Battery sensor connection port.
3. COM port.
4. Power input.

The BC



The BC can read the monitoring values, one-by-one, from TAs and TCs. This includes:

- Analysis and processing of data received from TAs and TCs.
- A maximum of six battery strings for each BC and 2 strings per COM port.

Specific functions

The BC reads each sensor in series to the end strings or strings including a TC.

- Parameters for string(s) set up in the Integrator software cover upper and lower alarm limits.
- An automatic alarm function. (When an alarm happens, the E2 light illuminates.)
- The COM port is an RJ-45 (Ethernet) RS-485 Serial.
- Power Options:
 - CGBC-300-WD(BC) 85 to 246VAC/110VDC to 370VDC, 10W.



- CGBC-300-WD-48V(BC) 36VDC-72VDC (DC ONLY), 15W.



Components



1. Alarm indicator lights.
2. Power input.
3. Power output.
4. Dry contact.
5. Upload port.
6. LAN port.
7. Communication ports.

Indicator lights



- P–Power light.
- A–Alarm light.
- E1–Commuincation failure.
- E2–Battery alarm.
- R1/T1–Transmit and receive for COM1.
- R2/T2–Transmit and receive for COM2.
- R3/T3–Transmit and receive for COM3.
- R4/T4–Transmit and receive for COM4.

Intentionally Blank



Installation

Assembly

Numbering batteries

Before you connect the TAs to the batteries, label and number both the TAs and batteries clearly.

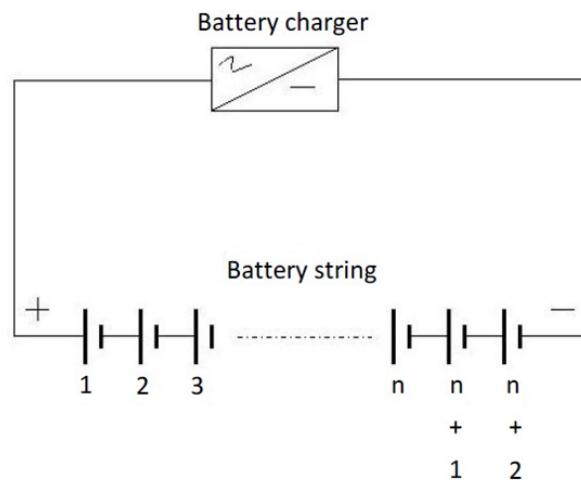

- The first battery, or battery NO.1, must be the first one on the string's positive terminal, the NO.2 is the battery following the NO.1 battery, and so on:
 - Multiple strings with separate ports and sensors in parallel:
 - Each string starts with 1 and continues to last battery in string.
 - Each string requires a TC.
 - Example: 120 Batteries consisting of 2 strings of 60:
 - String 1: 1-60 (addressing).
 - String 2: 1-60 (addressing).
 - Multiple strings that use the same port (maximum 2 strings) with sensors in series:
 - String 1: 1-30 (addressing).
 - String 2: 31-60 (addressing).
 - Second TC (has an address different from the first TC).
- The last battery is the one attached closest to the string negative terminal. Number the batteries according to this practice.

The BMS is a multiple string system. COM ports 1-3 on the BC are capable of supporting two strings (six strings maximum) for each COM port.

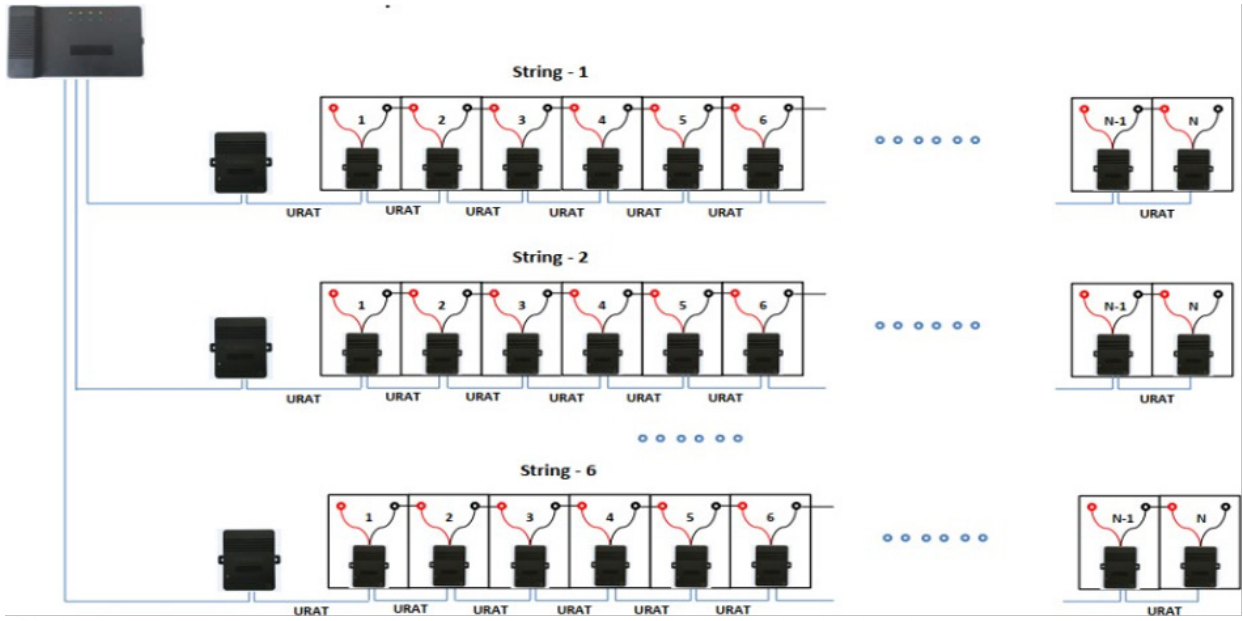

Addressing

Install the U-type acquisition terminals (provided) on each post on top of the batteries to be monitored. Install the terminals in the following order:

U-type acquisition terminals > Flat washer > Spring washer > Nut (or bolt)

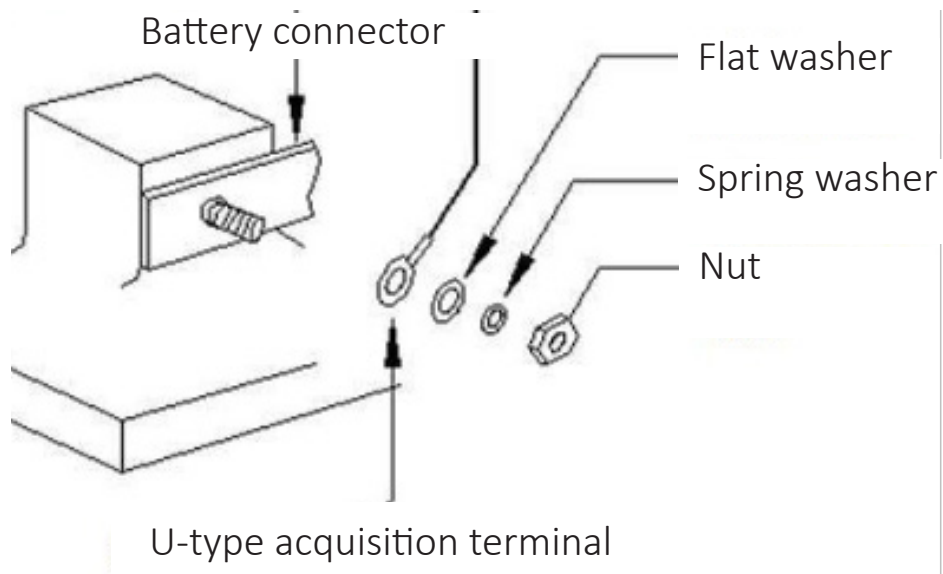
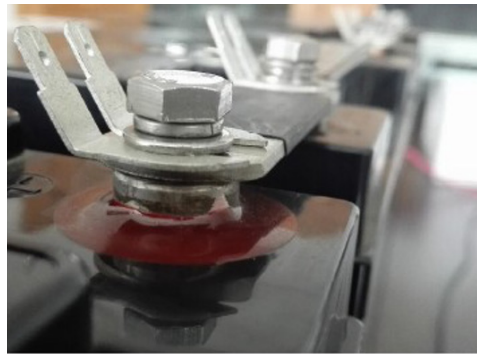

Installing sensor cables

Attach the appropriate end of the sensor cable to the tabs on the U-type acquisition terminal, and then plug the sensor cable into the sensor module connector.

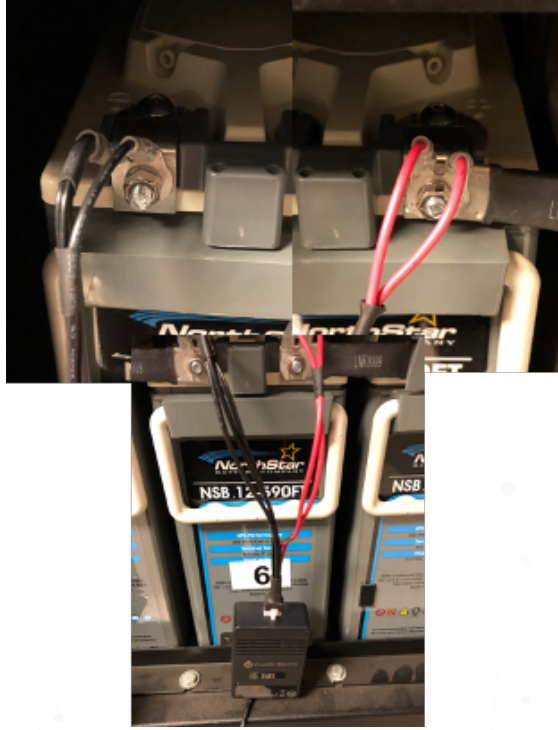

Crimping sensor cables

IMPORTANT: You must use an RJ-22 crimping tool.

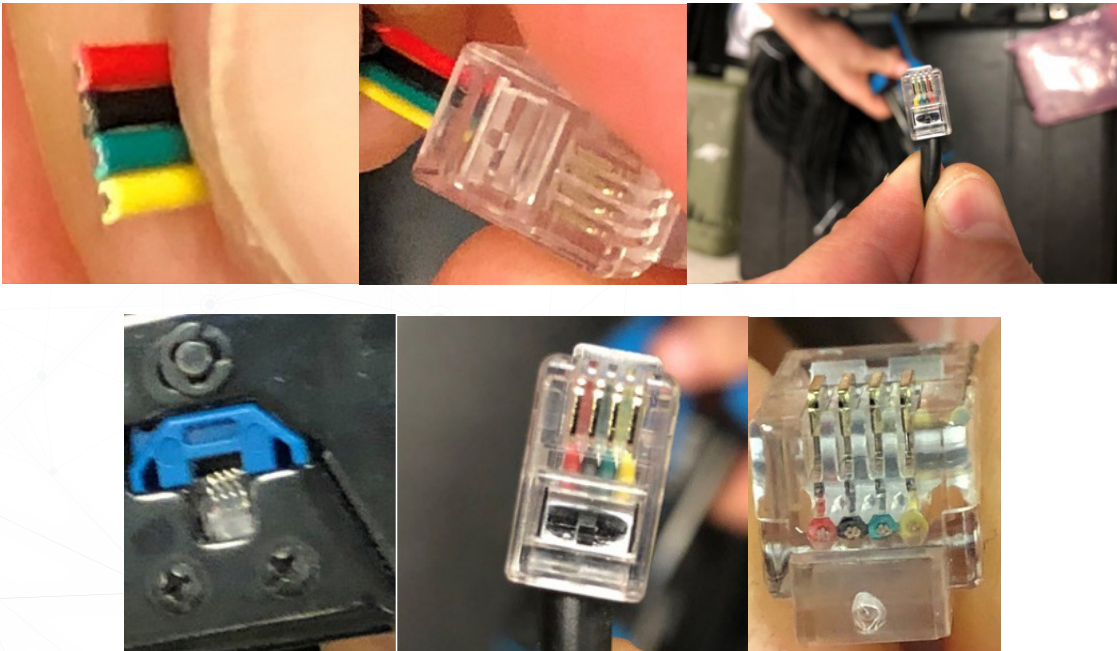

Addressing sensors

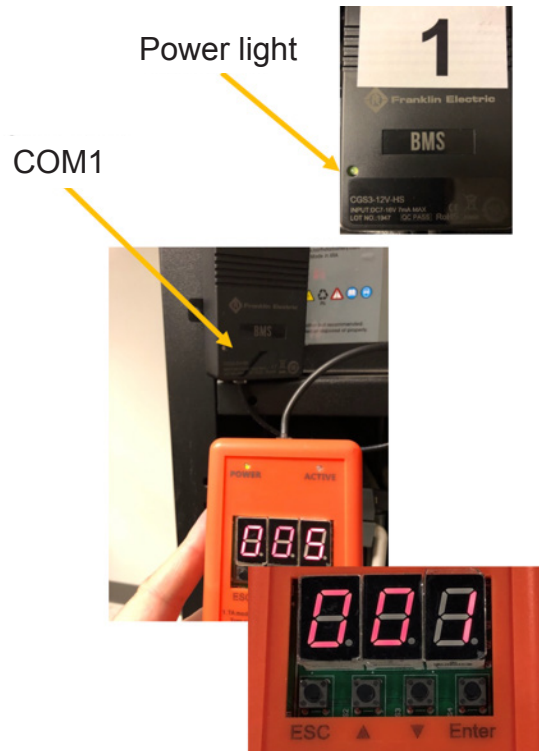

1. Make sure the sensor is secured on the batteries, and confirm the power light in the lower left corner is green.
2. Use the TA address modifier (provided) to:
 - Connect the connector wire to the TA address modifier and COM1 of the sensor.
 - Press the up or down arrow at the bottom of the TA address modifier until the desired address number appears on the TA address modifier display (1-240).
 - Press Enter. The Active light flashes green.
 - The address is changed, and the TA address modifier changes to the next address automatically.
 - Connect the TA address modifier to the next sensor, and press Enter until the entire string is addressed.

IMPORTANT: Sensors will not address if the cable is connected to COM2. Make sure only the TA address modifier is connected to the sensor when you attempt to address the sensor.

Addressing the TC

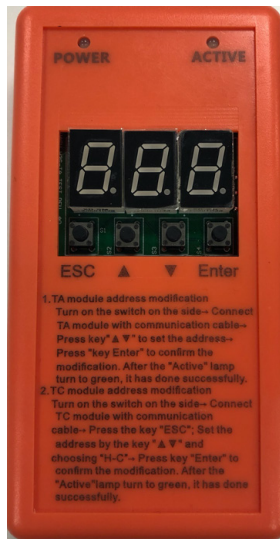

The default TC address is 241, but you can choose an address from 241 to 247. If you are monitoring only one battery string, the address can remain the default.

To change the address:

1. Connect the address modifier to COM1 on the TC.
2. Turn on the address modifier power switch.
3. Press the ESC button.
4. Use the arrow buttons to change the address.
5. Press Enter to select the next digit. After you set the last digit, press Enter.
6. Press the arrow to select H-C, and then press Enter.
7. When "96" appears in the address modifier display, press Enter. The address will be appear in the display.
8. Press Enter. When the ACTIVE lamp turns green, the change is complete.

Connecting the BC and TC

The BC

- COM1 on the BC:



- Left side to either COM port on the TC.
- Right side from COM2 of the last battery in string 1 or string 2, if you use two strings for each COM port.

The TC

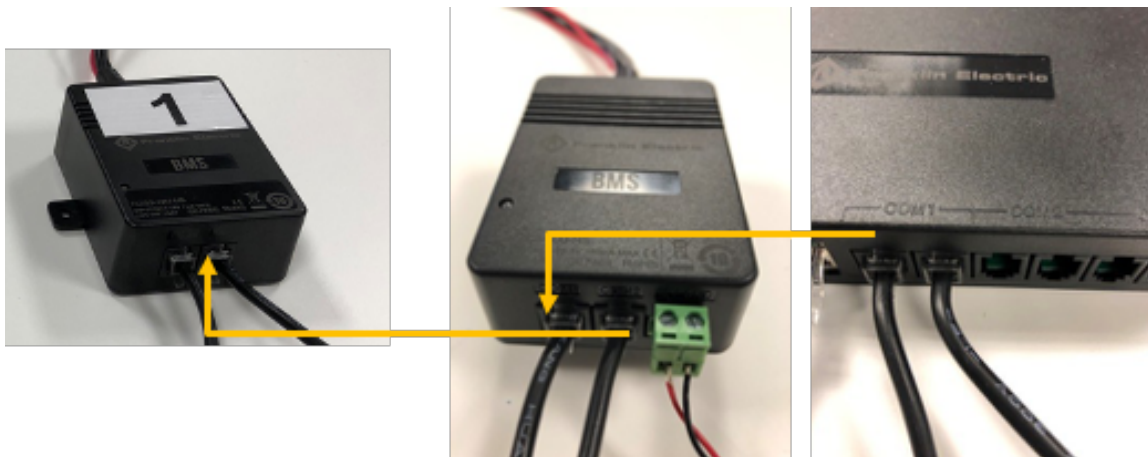

- COM1 and COM2 operate identically once the TC is addressed.

Wiring the TA

TA 1

- COM1 and COM2 act identically once they are addressed.
- The last sensor in the string, COM2, has a home run back to the right port on COM1 on the BC.



Wiring multiple string sensors in series

NOTE: This wiring method uses the same COM port.

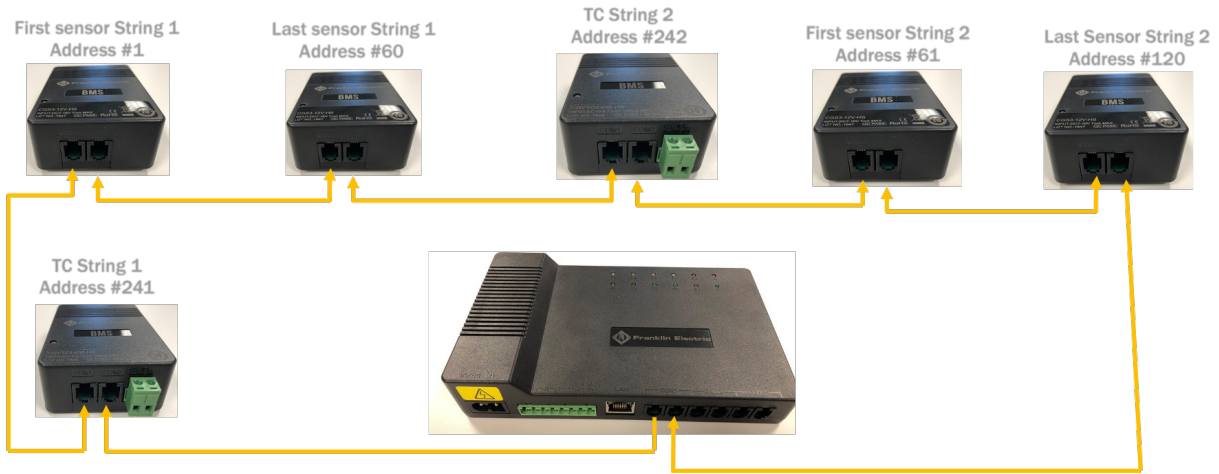

Wiring multiple string sensors in parallel

NOTE: This wiring method uses multiple COM ports.



Wiring the BC and TC

The TC



- TC (8-13VDC- 1W-from the BC):
 - Wire (18-22AWG).
 - Red (+) on left.
 - Black (-) on right.

The BC

IMPORTANT: These terminals are at the far end of the terminal strip, to the left of J1.



- Red (+) on left.
- Black (-) on right.

Multiple TCs

Power is daisy chained from one TC to another TC.



Connecting the current transducer

Use the provided cable to connect to the TC:

- A 4-pin terminal connects to the current transducer.
- A white, six-section plug connects to the top of TC.
- You can separate the current transducer, which should be embedded in the cable of the positive pole of the battery string and fastened with a cable tie.
- The direction indicated on the current transducer should be the same direction as battery charging current.
- The arrow points away from terminal block.

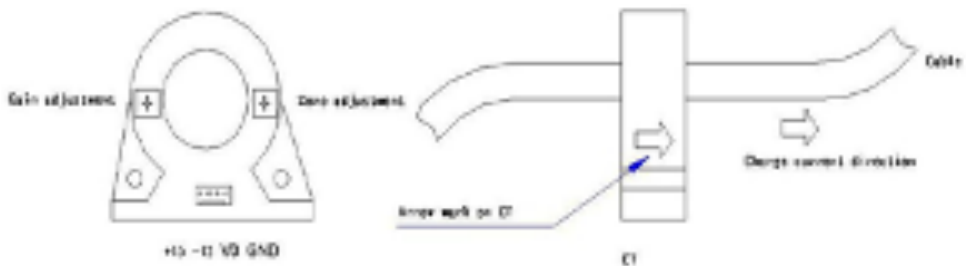

Powering the BC

48VDC parasitic option:

- Connect the power cable to both the positive and negative ends of the string:
 - Connect the positive end of the string to the most positive battery in the string.
 - Connect the negative end of the string to the most negative battery in the string.
- Connect the ring terminal on top of the existing TA terminals.

Commissioning the BC

Connecting the BC web interface

1. Update the connection properties in order to connect directly to the BC using an Ethernet(RJ-45) Cat 5-6 cable.



2. In the Ethernet Properties window, select Internet Protocol Version 4 (TCP/IP) Properties, and enter IP Address 192.168.0.1 (the default the gateway of the unit). Enter Subnet Mask 255.255.255.0. The default gateway is not required.

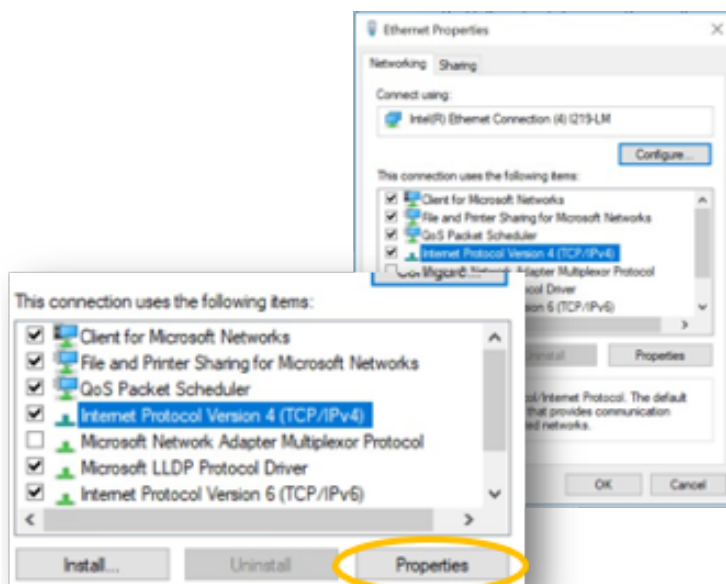

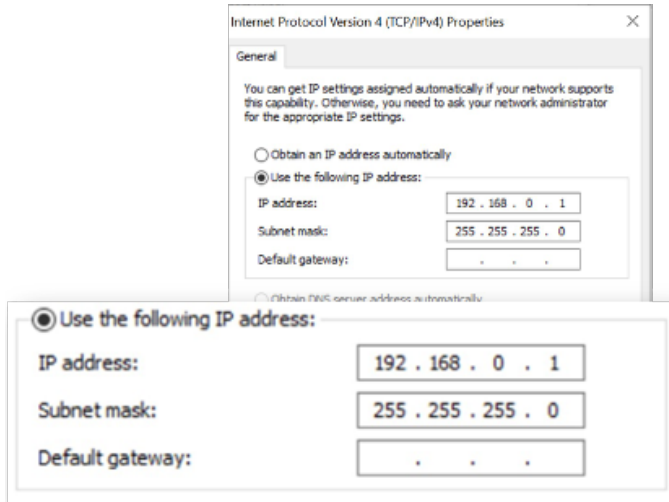

Using the Integrator tool

1. Make sure the unit is connected with an Ethernet cable, and open the Integrator tool.
2. Set IP Address to 192.168.0.105 and Port to 4007.

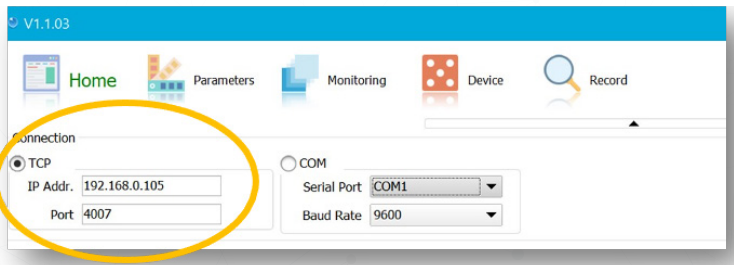

3. Click OFF to turn on-connect.



4. String 1 appears once connected.

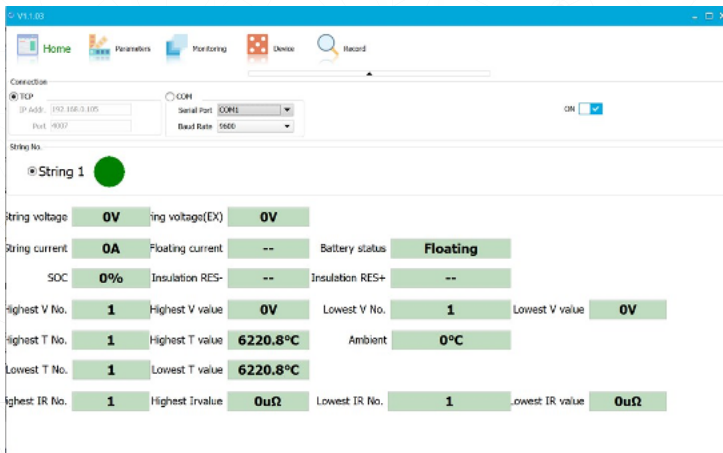

Setting up string parameters

1. Click Parameters, and open Easy Setup.

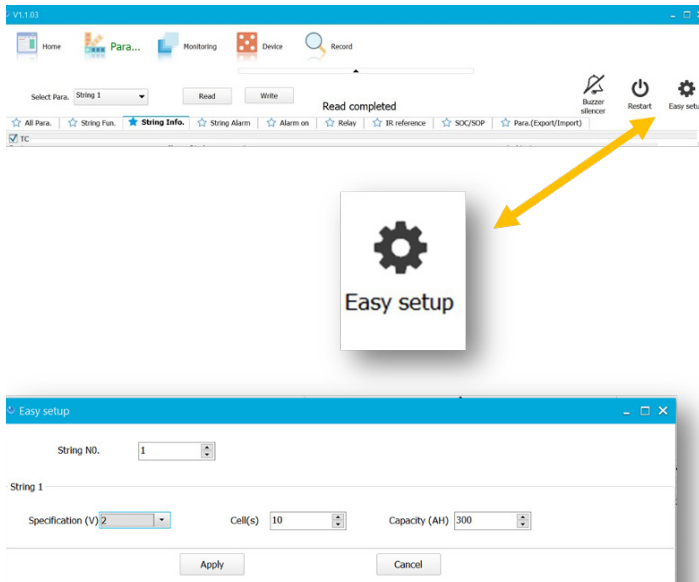

2. Choose the string number you want to configure.
3. Choose the battery voltage.
4. Choose the number of cells in the string.
5. Set the capacity (Amp hours), and then click Apply.

Changing port settings

1. Click Parameters.

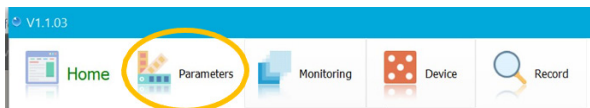

2. In the Parameters section, scroll through the list of editable parameters to locate and edit the port parameters you want to modify.

Statu	Name	Value	Ur
▲	NET port subnet IPv6 NET bit high byte / IPv4 mask, high byte add. 1, low byte add. 2	2552	
●	NET port subnet IPv6 NET bit high byte / IPv4 mask, high byte add. 3, low byte add. 4	2550	
▲	gateway IPv6 add. 7 / IPv4 add., high byte add. 1, low byte add. 2	1921	
▲	gateway IPv6 add. 8 / IPv4 add., high byte add. 3, low byte add. 4	1	
▲	NET port TCP protocol upload protocol	1	
●	TCP / UDP administrator upload protocol port	4001	
●	TCP / UDP custom upload protocol port	4002	
▲	SNMP protocol trap sends IP add. 1	1921	
●	SNMP protocol trap sends IP add. 2	21	
▲	data upload server IP add. 1	1921	
●	data upload server IP add. 2	1	
▲	data upload backup server IP add. 1	1921	
●	data upload backup server IP add. 2	2	
●	data upload server port No.	4005	
●	PC client port	4007	
▲	

3. Change port numbers as follows:

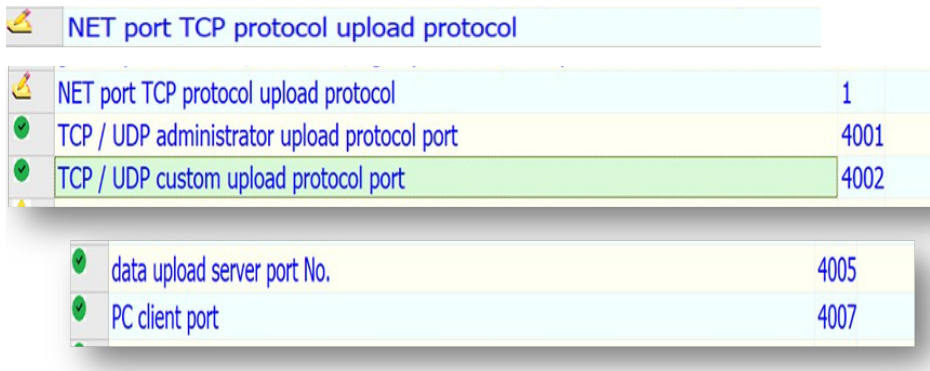

Parameter Name	Value
NET port TCP protocol upload protocol	1
TCP / UDP administrator upload protocol port	4001
TCP / UDP custom upload protocol port	4002
data upload server port No.	4005
PC client port	4007

NOTE: The field to right is an editable field. The icon to the left changes to  once a change is made.

4. Once all settings are edited, click Write.

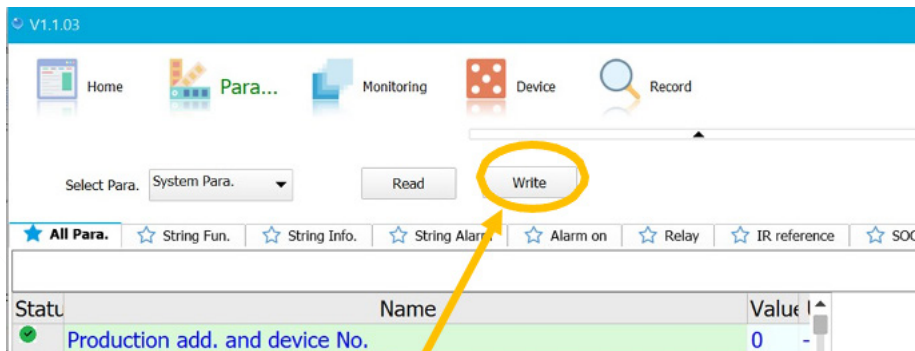

The following message appears when all parameters have been changed:

Write【NET port TCP protocol upload protocol】Success

Changing IR settings

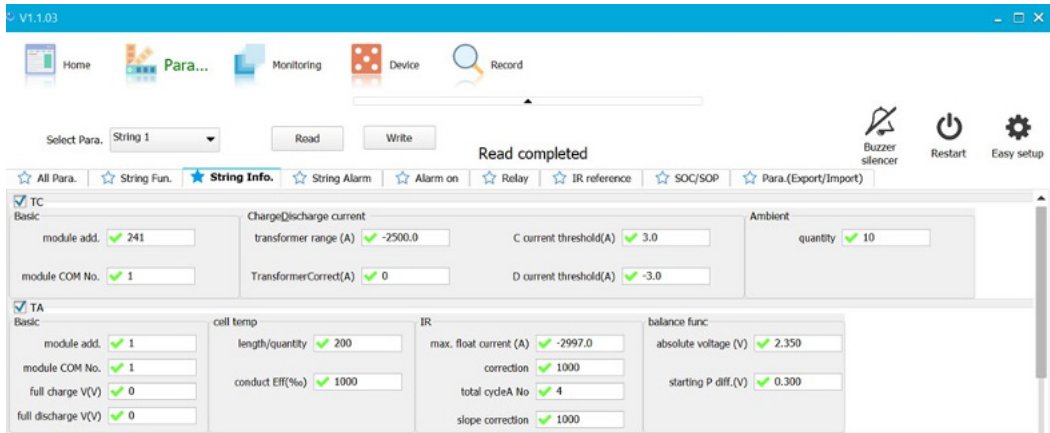

Parameters string information:

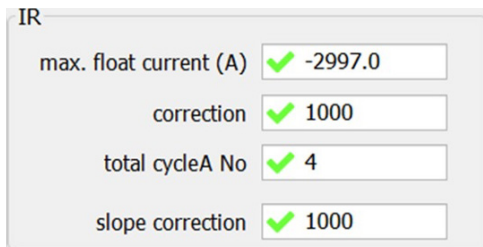

1. Make sure Correction and Slope Correction are set to 1000.
2. To correct, enter 1 in each field for the correction and slope correction.
3. Click Write.
4. Click Read to confirm the change.

Connecting the BC web interface

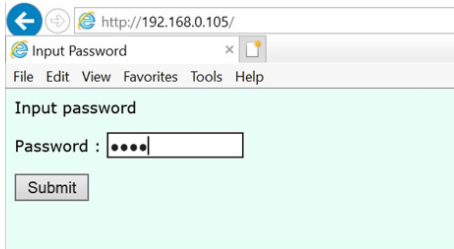

@192.168.0.105		BMS Online Configurations	
Monitoring Data	Target String number: <input type="text"/>		
Alarm Information	<input type="button" value="Pre. str"/> <input type="button" value="Pre. page"/> <input type="button" value="Refresh"/> <input type="button" value="Next page"/> <input type="button" value="Next str"/>		
Resistance Test	Green: normal Red: alarm Gray: com. error Blue: sensor error		
System Parameters	Battery Real-time Data		
String Parameters	Latest voltage D&T: 2000-00-00 00:00:00		
Read/Wr. Registers	Latest resistance D&T: 2000-00-00 00:00:00		
System Maintain	String voltage(V): 0.0	Current(A): +0.0	
	Ambient1(°C): +25.0	Ambient2(°C): +25.0	
	The highest_V batt No.: 0	The highest_V value(V): 0.000	
	The lowest_V batt No.: 0	The lowest_V value(V): 0.000	
	The highest_R batt No.: 0	The highest_R value(μΩ): 0	
	The string's SOC(%): ----	The string's SOE: ----	
	The average diff.(mV): 0	The extreme diff.(mV): 0	

1. Make sure the unit is connected with an Ethernet cable, and then open a browser.
2. Enter IP address 192.168.0.105.
http://192.168.0.105/
3. Enter "2022" in Password.

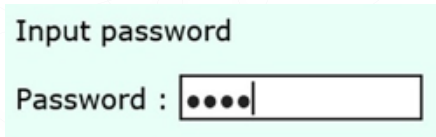

Configuring network connections

The following is the Menu tab on the web Interface landing page:

Monitoring Data
Alarm Information
Resistance Test
System Parameters
String Parameters
Read/Wr. Registers
System Maintain

1. Choose System Parameters on the web Interface landing page Menu tab.
2. Enter the appropriate network information (as shown below), and then click Modify.

Firmware Version:	Rev0000.B0.18
Note: Incorrect network parameters may lead to connection errors.	
IP Address:	192 . 168 . 0 . 105
Subnet Mask:	255 . 255 . 255 . 0
Default Gateway:	192 . 168 . 0 . 1
Port:	0
<input type="button" value="Modify"/>	

3. Choose System Maintain on the web Interface landing page Menu tab, and then click Reset.

Function B: Restart CM. Need relogin after reset.
<input type="button" value="Reset"/>
After done the following operations, please restart the CM:
1. After the network parameters was modified.
2. After restored the factory or saved defaults.
3. After modified the CM's parameter registers.

NOTE: After you complete a change, you will need to update the laptop connection parameters to reconnect to the BC.

NOTE: You must use the new default gateway as the IP address in the laptop network parameters.

4. Choose System Maintain on the web Interface landing page Menu tab, and then click Reset.

Function B: Restart CM. Need relogin after reset.
<input type="button" value="Reset"/>
After done the following operations, please restart the CM:
1. After the network parameters was modified.
2. After restored the factory or saved defaults.
3. After modified the CM's parameter registers.

Performing the Resistance Test

The Resistance Test screen allows you to run an internal resistance test on all sensors. You must complete this test at commissioning.

1. Choose Resistance Test on the web Interface landing page Menu tab.
2. Select the string to be tested, and click Test IR. During the test, each sensor light turns red.

Target String number: 1 (ALL: performing IR test for all strings)

a. Test R. If target number selects ALL, all strings will be tested in turn

Test status, press the Refresh button above to show the latest status:

S1: Modules do not support IR test

3. Enter "7" in the days field to perform the IR Test every 7 days.

d. IR AutoTest mode selection

The date 1 (Performing IR test automatically on the choosed date every month)

30 days (The range from 1 to 99 days, performing IR test every the choosed days)

The next IR-Test time: 2020-06-12 06:00

Confirming IR values

@192.168.0.105 **BMS Online Configurations**

Monitoring Data Target String number: 1

Alarm Information

Resistance Test
Green: normal
Red: alarm
Gray: com. error
Blue: sensor error

System Parameters

String Parameters

Read/Wr. Registers

System Maintain

Battery Real-time Data				
Battery No.	Voltage(V)	Resistance(uΩ)	Temperature(°C)	SOC(%)
1	11.953	43464	+21.7	----
2	12.108	33725	+22.3	----
3	11.982	42827	+22.0	----

1. Choose Monitoring Data on the web Interface landing page Menu tab to see Resistance Test results.
2. Click Next Page to see data for the first 20 batteries. Click Next Page again to see the remaining batteries in the target string.
3. Use the Target String number drop-down list to choose additional strings.

Configuring the Franklin Interface (FI)

NOTE: The following files and programs are in the .zip file provided by Franklin Electric.

IMPORTANT: Configure the FI before you open it.

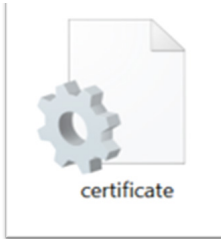

```
mailserver=localhost
server=localhost,1433
password=1@admin2020
autostart=false
[Para]
TZ=8
VT=2
GT=2
DTINSECONDS=15
```

1. Open the certificate file with Notepad. You must restart the FI to make further changes.
2. Mailserver = localhost:
 - Leave as the default if the FI is on the same PC as Celltraq™.
 - Change to the Celltraq™ server IP.
3. Server = localhost, 1433:
 - Leave as the default if the FI is on the same PC as Celltraq™.
 - Change to the Celltraq™ server IP.
4. Password = sasql2008#r2:
 - Default or confirm in c:\program files\apache software foundation\apachetomcat-7.0.59\conf.
 - Server.xml (Open this in Notepad.)

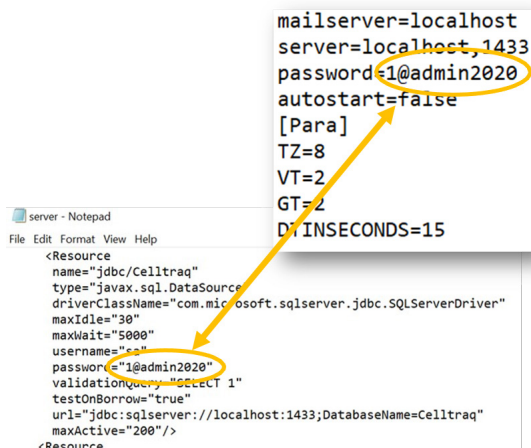

Starting the FI

1. Right click Franklin Interface and choose Run as Administrator. The Franklin directory appears.

NOTE: The Commission Site button remains grayed out until the site parameters are complete.

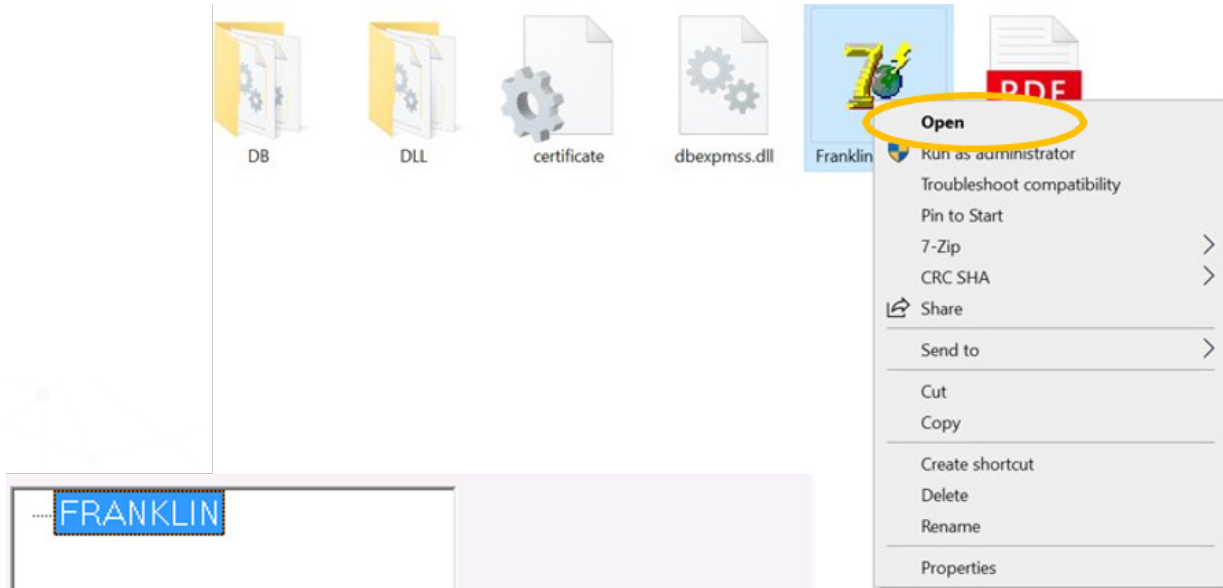

2. Right click the directory FRANKLIN. Add the BC site IP address.

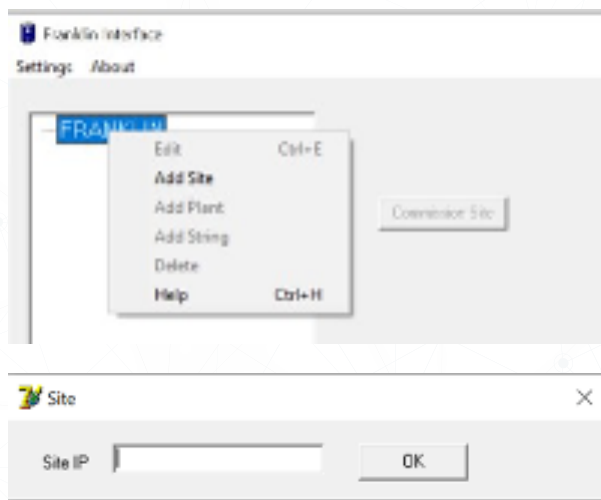

3. Right Click Site>Add Plant.



4. Right click Plant to add strings. Click Plant again to add additional strings.

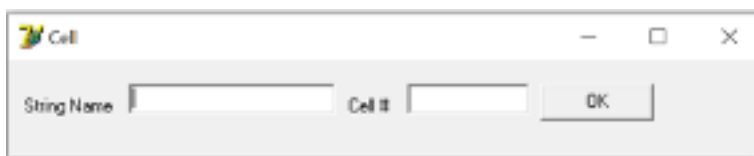
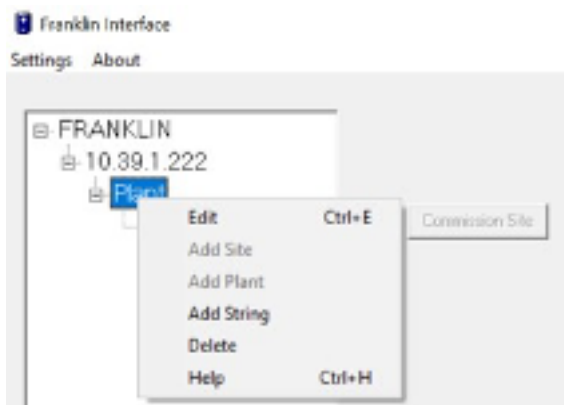

Commissioning the site

The Commission Site button should be active.

1. Click Commission Site.
2. Login to Celltraq™ to confirm the Celltraq™ heirarchy is populated.

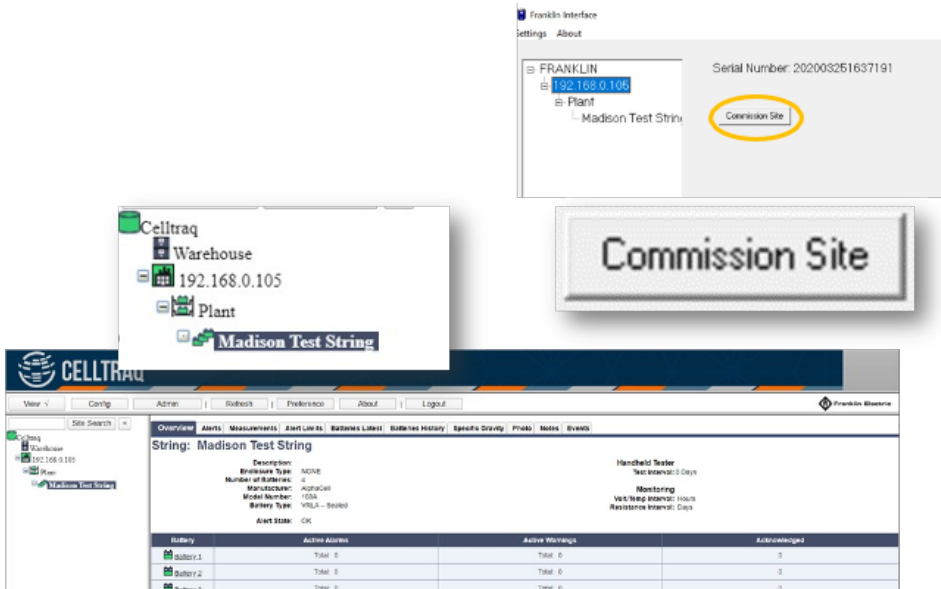

3. When you have confirmed the Celltraq™ heirarchy is populated, update the certificate file as follows
 - Open the certificate file in Notepad.
 - Save and close. You must restart the FI for changes to take effect.

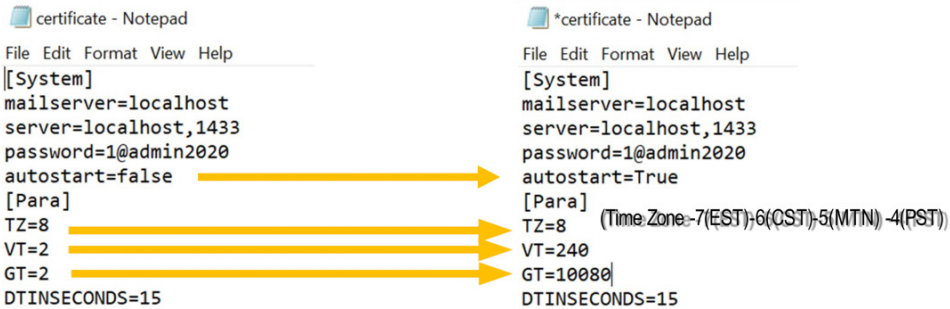

4. Return to the FI. Click Settings, and confirm that scanning has started.



Setting up batteries



1. Log in to Celltraq™, click Config, and expand the hierarchy to the string level.
2. Choose Edit to open the Edit String screen.
3. Confirm the Battery Type is correct. If so, the procedure is finished. If not, go to the next step.
4. Choose Edit to open the Choose Battery Specification screen.

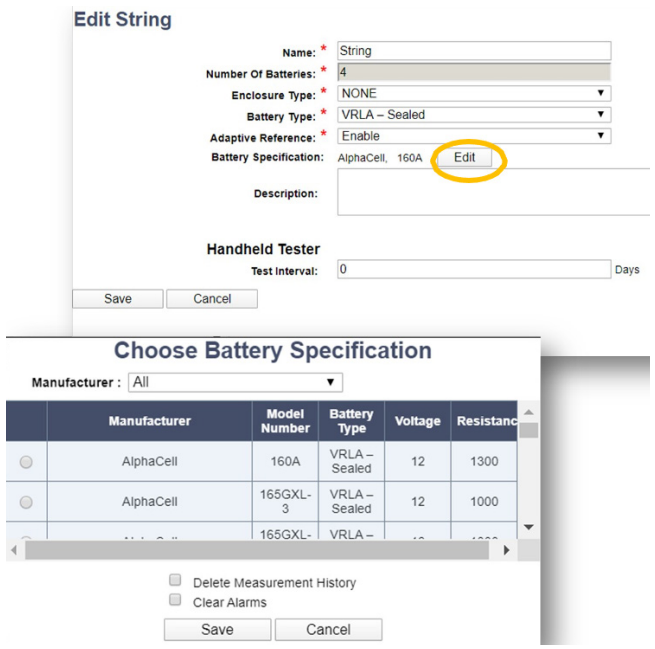

- Select Manufacturer to access information about the battery model. You cannot enter battery specifications if the correct model is not listed.

Choose Battery Specification

Manufacturer:

	Manufacturer	Model Number	Battery Type	Voltage	Resistance
<input type="radio"/>	HOPPECKE	12343567-XL -12V	VRLA - Sealed	12	
<input type="radio"/>	HOPPECKE	XTA16CL-B-BS	VRLA - Sealed	12	350

Delete Measurement History
 Clear Alarms

Choose Battery Specification

Manufacturer:

	Manufacturer	Model Number	Battery Type	Voltage	Resistance
<input checked="" type="radio"/>	HOPPECKE	12343567-XL -12V	VRLA - Sealed	12	
<input type="radio"/>	HOPPECKE	XTA16CL-B-BS	VRLA - Sealed	12	350

Delete Measurement History
 Clear Alarms

- Click the model number of the battery for which you want to enter specifications.
- If alarms or measurements exist for previous batteries, clear them by choosing Clear Alarms and then deleting the measurement history.
- Click Save to save the battery selection.
- To confirm the update, click View, and locate the string in the heirarchy. The correct manufacturer and model number should be listed.

String: String

Description:
Enclosure Type: NONE
Number of Batteries: 4
Manufacturer: HOPPECKE
Model Number: 12343567-XL -12V
Battery Type: VRLA - Sealed
Alert State: OK

Battery	Active Alarms
Battery 1	Total: 0
Battery 2	Total: 0
Battery 3	Total: 0
Battery 4	Total: 0

Setting alert limits

1. Click Config and then Alert Limits.

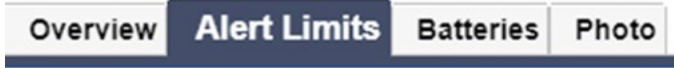

2. Set parameters for the string and battery alert limits. To correct alert limits, click Edit to change measurements.

Overview **Alert Limits** Batteries Photo

String 1 Alert Limits

Charge State: Normal Charge Discharge

String Alert Limits
Note: String Voltage Alert Limits are calculated by multiplying the Battery/Cell Voltage Alert Limits by the number of batteries in the string.

Measurement	Enabled	Reference	High Alarm	High Warning	Low Warning	Low Alarm	Operation
String Temperature	Y		50	45	15	10	Edit Delete
String Voltage	Y		60.48	60.0	51.6	51.12	Edit Delete
String Current	Enable						Insert

Battery Alert Limits

Measurement	Enabled	Reference	High Alarm	High Warning	Low Warning	Low Alarm	Operation
Battery/Cell Voltage	Y		15.12	15.0	12.9	12.78	Edit Delete
Battery/Cell Temperature	Y		50	45	15	10	Edit Delete
Battery/Cell Strap Resistance	Y		1000	800			Edit Delete
Battery/Cell Voltage	Enable						Insert

3. Click Save when completed. To edit additional measurements, repeat the previous step.

Setting discharge limits

String Alert Limits

Charge State: Normal Charge Discharge

String Alert Limits
Note: String Voltage Alert Limits are calculated by multiplying the Battery/Cell Voltage Alert Limits by the number of batteries in the string.

Measurement	Enabled	Reference	High Alarm	High Warning	Low Warning	Low Alarm	Operation
String Current	Enable						Insert

- String current.
- String voltage:
 - Choose the Measurement drop-down list.
 - Enter the limits.
 - Click Insert.

Editing IP address names

When the site is active and sending data to Celltraq™, you can modify the IP address to better resemble the site name.

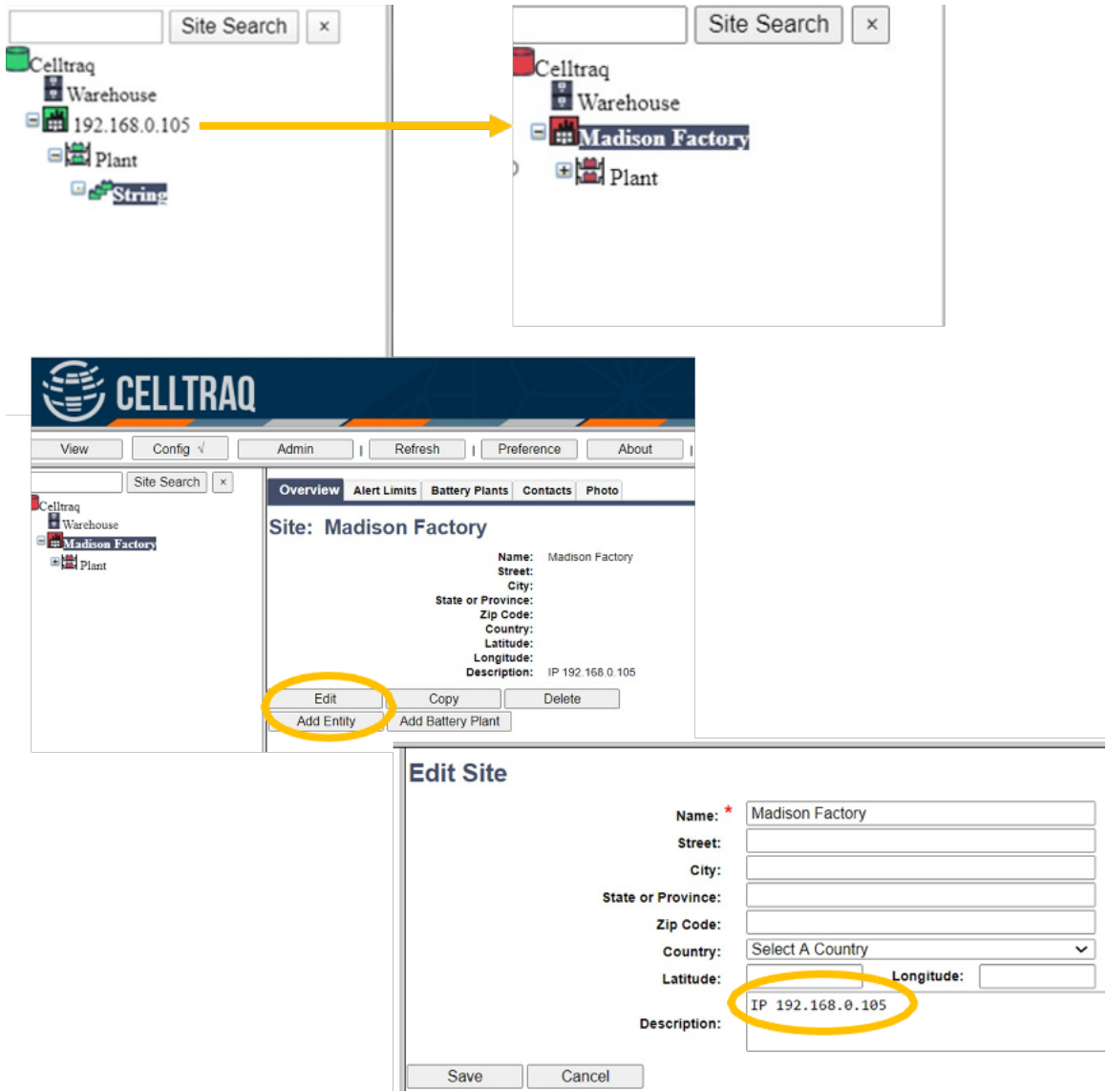

1. Click Config.
2. Click the site.
3. Click Overview.
4. Click Edit. Change the Name field to the name you prefer for the site.
5. Enter the IP address in Description.

Intentionally Blank

Intentionally Blank



Franklin Electric
GRID SOLUTIONS