

Patents

The **CELLTRON ADVANTAGE** Universal Stationary Battery Analyzer is made in the U.S.A. by Franklin Electric and is protected by one or more of the following U.S. Patents: 6633165; 6623314; 6621272; 6597150; 6586941; 6566883; 6556019; 6544078; 6534993; 6507196; 6497209; 6495990; 6469511; 6466026; 6466025; 6465908; 6456045; 6445158; 6441585; 6437957; 6424158; 6417669; 6392414; 6377031; 6363303; 6359441; 6351102; 6332113; 6331762; 6329793; 6323650; 6316914; 6313608; 6313607; 6310481; 6304087; 6294897; 6294896; 6262563; 6259254; 6249124; 6225808; 6222369; 6172505; 6172483; 6163156; 6137269; 6104167; 6091245; 6081098; 6051976; 6037777; 6037751; 6002238; 5945829; 5914605; 5871858; 5831435; 5821756; 5757192; 5656920; 5598098; 5592093; 5589757; 5585728; 5583416; 5574355; 5572136; 5469043; 5343380; 5140269; 4912416; 4881038; 4825170; 4816768; 4322685; 3909708; 387391; and 387391. Other U.S. and Foreign patents issued and pending. This product may utilize technology exclusively licensed to Franklin Electric by Johnson Controls, Inc. and/or Motorola, Inc.

Limited Warranty

The **CELLTRON ADVANTAGE** is warranted to be free of defects in materials and workmanship for a period of one year from date of purchase. Franklin Electric will, at our option, repair or replace the unit with a remanufactured unit. This limited warranty applies only to the **CELLTRON ADVANTAGE** analyzer, and does not cover any other equipment, static damage, water damage, overvoltage damage, dropping the unit, or damage resulting from extraneous causes including owner misuse. Franklin Electric is not liable for any incidental or consequential damages for breach of this warranty. The warranty is void if owner attempts to disassemble the unit or to modify the cable assembly.

Service

To obtain service, purchaser should contact Franklin Electric for a Return Authorization number, and return the unit to Franklin Electric freight prepaid, Attention: RA# _____. Franklin Electric will service the analyzer and reship the next scheduled business day following receipt, using the same type carrier and service as received. If Franklin Electric determines that the failure was caused by misuse, alteration, accident, or abnormal condition of operation or handling, purchaser will be billed for the repaired product and it will be returned freight prepaid with freight charges added to the invoice. Battery analyzer beyond the warranty period are subject to the repair charges in effect at that time. Optional remanufacturing service is available to return the tester to like-new condition. Out-of-warranty repairs will carry a 3-month warranty. Remanufactured units purchased from Franklin Electric are covered by a 6-month warranty.

CELLTRON ADVANTAGE

INSTRUCTION MANUAL



GRID SOLUTIONS

STATIONARY POWER DEVICES
FRANKLIN ELECTRIC | GRID SOLUTIONS
7133 Monroee Street
Willowbrook, IL 60527

www.franklingrid.com
customerservice@franklingrid.com
+1 844.344.5025

FIND US ON:

Table of Contents

Safety	2-3
Product Overview	5-8
Accessories	9
Hot Keys	10
Main Menu Overview	11-13
Performing a Test	14-17
Reports	17
Add-Ons/Expansion Modules	19-21
Troubleshooting	22-23

Safety Guidelines

General Safety Precautions

1. IMPORTANT SAFETY INSTRUCTIONS. **IT IS OF UTMOST IMPORTANCE THAT BEFORE USING YOUR TESTER, YOU READ THIS MANUAL AND FOLLOW THE SAFETY AND OPERATING INSTRUCTIONS EXACTLY. SAVE THESE INSTRUCTIONS.**

<p>Risk of explosive gases</p> <p>Batteries generate explosive gases during normal operation, and when discharged or charged.</p>
--

- 1.1 To reduce risk of battery explosion, follow these safety instructions and those published by the battery manufacturer and the manufacturer of any equipment you intend to use in the vicinity of a battery. Review cautionary marking on these products and on the battery cabinets, battery racks, battery rooms, and on the vehicle or equipment containing the battery.
If you are uncertain as to the type of battery you are trying to test, then contact the seller or battery manufacturer.
- 1.2 Do not operate the tester if it has received a sharp blow, been dropped or otherwise damaged in any way; contact Franklin Electric customer service.
- 1.3 Do not disassemble tester; contact Franklin Electric customer service when a repair is required. Incorrect reassembly may result in a risk of electric shock or fire.
- 1.4 Test batteries in a dry, well-ventilated area.
- 1.5 Do not expose the tester to rain or snow.

Testing Precautions

 **IMPORTANT:**
Read this instruction manual before using the tester.

<p>WARNING</p> <p>To avoid electric shock when testing jars, follow your company's safety practices and these guidelines:</p>
--

- | | |
|--|---|
| <ul style="list-style-type: none"> <input type="checkbox"/> Mandatory use of safety glasses with side shields in the vicinity of battery work per 29CFR1910.133 (OSHA) <input type="checkbox"/> Wear protective rubber gloves <input type="checkbox"/> Wear a protective apron or shop coat. <input type="checkbox"/> Perform service work only for which you have been trained <input type="checkbox"/> Do not disconnect the battery cables from power systems during the test without authorization <input type="checkbox"/> Do not place yourself in an electrical circuit <input type="checkbox"/> Avoid simultaneous contact with the jar and with frame racks or hardware that may be grounded | <ul style="list-style-type: none"> <input type="checkbox"/> Battery posts, terminals, and related accessories contain lead and lead compounds, chemicals known to cause cancer and birth defects or other reproductive harm. Wash hands after handling. <input type="checkbox"/> Aprons (acid-resistant) <input type="checkbox"/> Insulating blankets <input type="checkbox"/> On-site spill kits <input type="checkbox"/> Protective footwear <input type="checkbox"/> Clothing (e.g., voltage levels, level of corrosive protection, the amount of arc-flash protection provided) <input type="checkbox"/> Insulated rescue hooks or other means for pulling personnel from live circuits |
|--|---|

Personal Precautions

- 2.1 Always have someone within range of your voice, or close enough to come to your aid, when working around lead acid batteries.
- 2.2 Have plenty of fresh water and baking soda nearby in case battery acid contacts skin, clothing or eyes.
- 2.3 Refer to NFPA 70E for electrical safety PPE requirements.
- 2.4 If battery acid contacts skin or clothing, wash immediately with baking soda and water. If acid enters the eye, immediately flush with cold running water for at least 10 minutes, and seek medical attention.
- 2.5 Never smoke or allow a spark or flame in vicinity of a battery or engine.
- 2.6 Be extra cautious to reduce risk of dropping a metal tool onto the battery. It might spark or short circuit the battery or other electrical part that may cause an explosion.
- 2.7 Before working with a lead-acid battery, remove personal metal items such as rings, bracelets, necklaces, watches, etc. A lead-acid battery can produce a short circuit current high enough to weld such items causing a severe burn.

PRINTER STATUS LED

When a printer fault occurs, the STATUS LED flashes. You can identify the fault by the number of sequential flashes:

Solutions

- If the IR transmitter and receiver are not aligned, all the data may not print. The infrared ports on the top of the analyzer and on the printer (below the MODE button) should be pointed directly at each other. The maximum distance for reliable transmission between the ports is 18 inches (45 cm).
To realign, press the BACK key to cancel the print. Verify alignment between the analyzer and printer; then try to print the test results again.
- If the message PRINTING appears on the screen, but no data are printing, press the BACK key to cancel the print. Turn off the printer and charge the printer battery for at least 15 minutes before attempting to print again. Align the analyzer and printer IR transmitters and print again.
- Make sure the printer is on. The printer shuts off after two minutes of inactivity to conserve the battery. To turn the printer on, briefly press the MODE button. The green STATUS light should turn on. Make sure you are using the printer provided with the **CELLTRON ADVANTAGE**. Other printers may not be compatible.

- Direct sunlight interferes with infrared data transmission/receiving. If the printer is not receiving data, remove the printer and the **CELLTRON ADVANTAGE** from direct sunlight. If the printed characters are not clear or are partially missing, recharge the battery and reprint.
- Verify that a compatible communications protocol is selected in the printer setup. IrDA Mode is compatible with the printer ("IrDA Physical Layer" on the printer's self-test printout). Refer to the printer manual for information.
- If you are unable to print after ensuring the analyzer is functioning, the printer is on, the batteries are good, and the IR transmitter and receiver are aligned, see the printer manual for further instructions or call Franklin Electric See Patents, Limited Warranty, Service.)

Troubleshooting

The troubleshooting tips in this section will help you resolve most testing and printing problems. For problems with the printer, digital temperature gun, or the PC software application, refer to their manuals or call Franklin Electric Customer Service for assistance. (See Patents, Limited Warranty, Service.) Screen does not power on during testing (no text/graphics)

- Check the connection to the jar.
- The jar voltage might be too low (less than 1 volt) to test.
- The analyzer's battery pack might need to be recharged or replaced.

Recharging the analyzer battery pack

Recharge the analyzer battery pack if:

- The display does not turn on when you press the POWER button.
- The screen displays:

****Warning****
Internal Battery Low!
Replace Batteries Soon!

1. Insert the AC adapter plug into the connector.
 Connect the power of the AC adapter to an AC outlet.
2. Periodically turn on the analyzer and check if the charge level indicator is black. When the battery pack is fully charged, disconnect the adapter from the analyzer and the AC outlet.

NOTE The maximum charge time is 3 to 4 hours. Do not overcharge.

Replacing the analyzer battery pack

If the screen does not power on after recharging, replace the battery pack.

1. Press battery pack end tabs and pull battery pack.
2. Replace with charged battery pack.

If the problem persists, call Franklin Electric Customer Service. (See Patents, Limited Warranty, Service).

Probe tip is bent or stops retracting

To replace a damaged a probe tip:

1. Grasp the probe tip with pliers at the top of the sleeve.

⚠ CAUTION

Do not damage probe when removing from sleeve.
 Grasping the sleeve that encases the probe tip can damage the tip.

2. Pull the tip straight out.
3. Grasp the replacement tip with the pliers and insert it into the sleeve.
4. Push the probe tip into a soft surface, such as cardboard, until it hits the bottom of the sleeve.

NOTE To obtain replacement tips, contact Franklin Electric Customer Service.

Test Failure

If the analyzer fails to advance to the next jar count, try to retest. Ensure clamps are connected and clamp LEDs are off.

Test results do not print or print incorrectly

- Check that the printer is on
- Check that the tester IR transmitter are aligned
- Check printer batteries
- Flourescent lights can affect IR transmission. Remove the tester from any flourescent lights and re-transmit.

Model Numbers:

- CAD-5000 (Bronze Kit)
- CAD-5200 (Silver Kit)
- CAD-5500 (Gold Kit)

Applications:

Tests individual Lead-Acid or Nickel-Cadmium cells or Monoblocs (up to 16Volts) in any common configuration, approximately 10-6000Ah.

Voltage Range:

1.0 - 20.0 Volts DC

Conductance Range:

100 - 19,990 Siemens

Test Data Storage:

50 string locations of 240 test results stored internally

Accuracy:

+/-2% across test range, Voltage and Conductance

Voltmeter Resolution:

5mV

User Programmable Functions:

- Preset values for over 250 battery types
- Low voltage alarm setting
- Low conductance warning
- Low conductance failure

- Test mode (pushbutton/auto start)

Calibration:

Franklin Electric certifies that all Stationary Battery testers produced and calibrated by Franklin Electric do not require re-calibration, unless the tester has been physically modified or altered thereafter. Future calibration is not required of any Franklin Electric stationary battery testers, and no re-calibration schedules apply. Franklin Electric will work with each customer to establish a regular calibration program if it is required by their quality or other management system.

Cable Options:

- Dual contact clamps
- Dual contact probes
- Custom cables by quotation

Power Requirements:

7.2V, 2500mAh, NiMH
 Internal swappable battery& charger

Display:

LCD- FST 2.97 in x 2.81 in (75.4 mm x 71.3mm), 128 x 128 pixels, 40 degree viewing angle, contrast ratio, LED backlight

continued →

Keypad:

Alpha-numeric, Stainless-steel dome, polycarbonate overlay, 1,000,000 actuations

Data Transfer:

USB Flash Drive (Type A)
 USB PC Interface (Type B)
 Infra-red, half-duplex IRDA Protocol for printer

Environmental Operating Range:

0 to +40°C, 95% relative humidity, non-condensing

Storage Temperature:

-20 to 82°C

Over Voltage Protection:

- Protected up to 600 VDC
- Auto-reset disconnect
- Reverse polarity protected

Housing Material:

Acid-resistant ABS plastic
 Santoprene overmold

Analyzer Dimensions:

11inx4inx3in
 280mmx105mmx80mm

Case Dimensions:

19inx15.5inx7in
 485mmx395mmx180mm

Analyzer Weight:

1 Kg/2.6 lb

CAD-5500 Test Kit Shipping Weight:

Approximately 5 Kg/11 lb



Gen Start Hot Key:

If activated, this activates the test function to determine state of health of generator starting batteries.

GENSTART

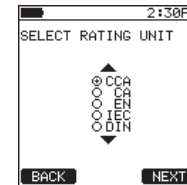

Select battery rating units.

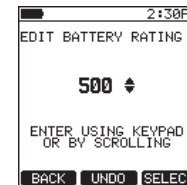

Enter battery rating.



Connect clamps/probes to battery.

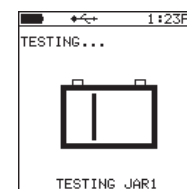

Screen shows battery test in progress.

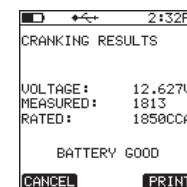

Battery test results screen. Press the F3 Key to print results. Results can be viewed, but not saved or stored.

Add-Ons & The following add ons for your **CELLTRON ADVANTAGE**
Expansion Modules: are available for purchase

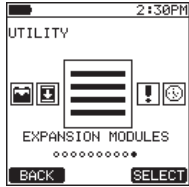

Expansion Modules Screen:

Access the available modules through this menu option.

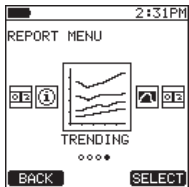

Trending Screen:

This function provides ability to trend battery conductance from measurement to measurement.

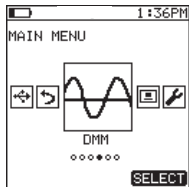

Digital Multimeter

Provides live voltmeter functions and AC volts function.

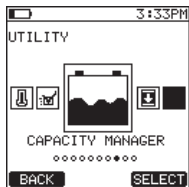

Capacity Manager:

Track, manage, and record traditional battery discharge information during load testing. Allows for discharge time record.

CELLTRON ADVANTAGE

PRODUCT OVERVIEW

continued →

Product Map

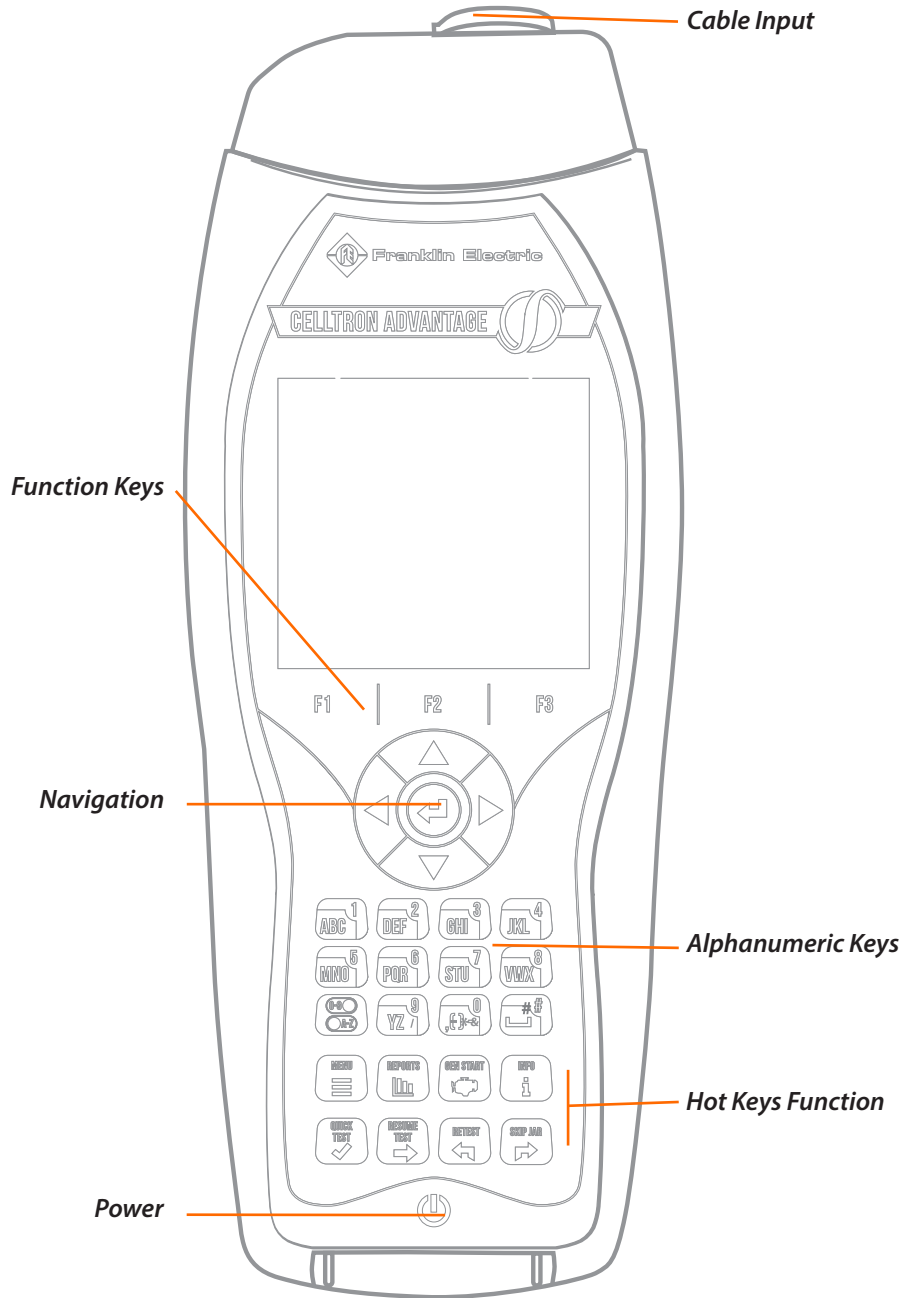

CELLTRON ADVANTAGE

ADD-ONS/EXPANSION MODULES

Activate the full capabilities of your **CELLTRON ADVANTAGE**

Contact Franklin Electric with your unit in hand for an activation key.

FRANKLIN ELECTRIC | GRID SOLUTIONS

Phone: 1.844.344.5025

Email: customerservice@franklingrid.com

TOP

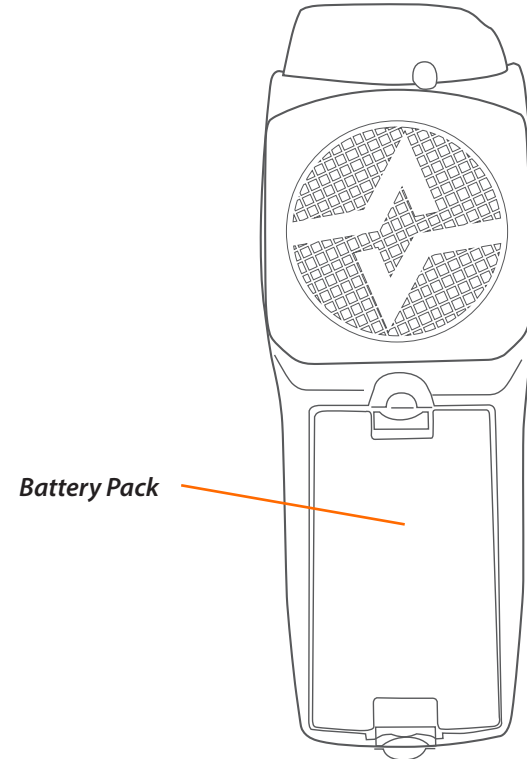
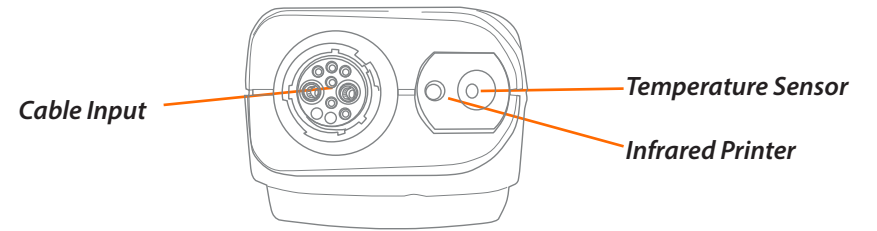

BOTTOM

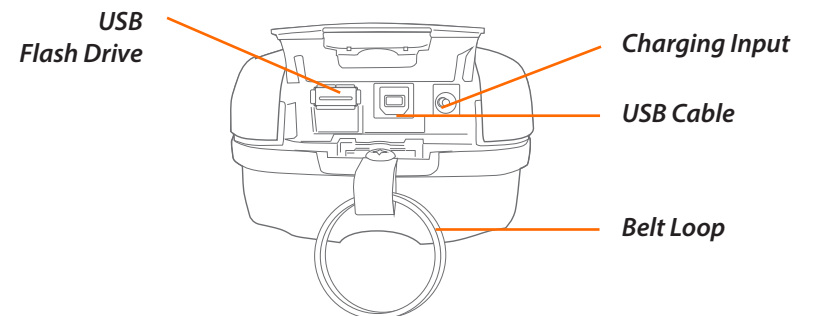

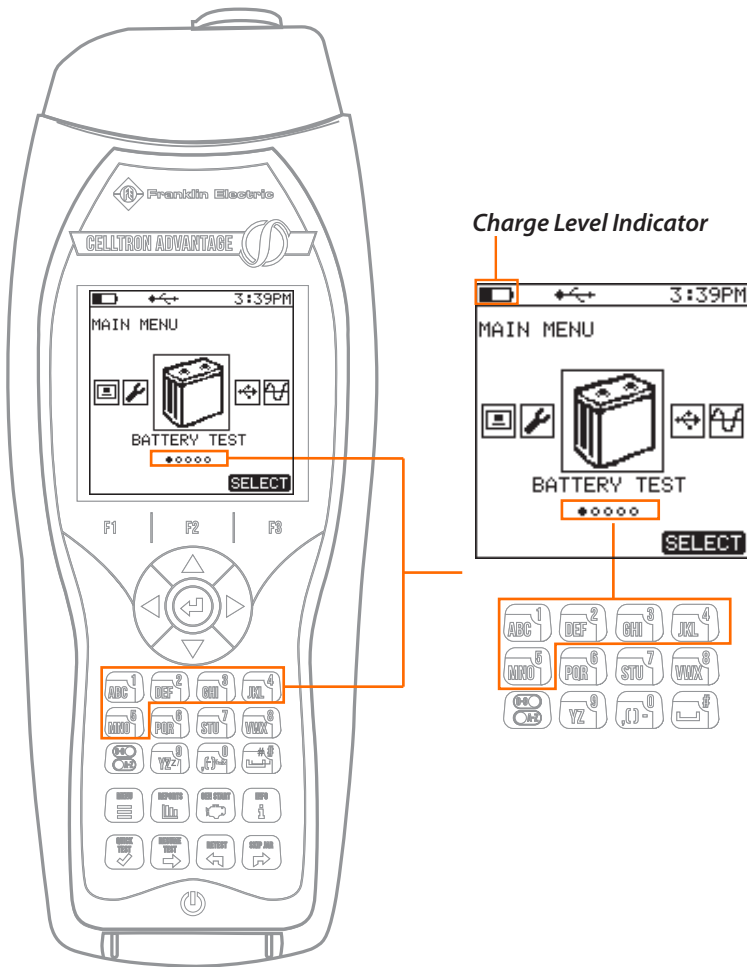



Quick Navigation

The numbers of dots on the menu screen (as highlighted) represent the sections of your CELLTRON ADVANTAGE. To quickly navigate thru these option, without having to continuously use the Navigation Button, you can use the number pad to get to the screen you want.

This quick navigation feature can be used anywhere in your CELLTRON ADVANTAGE.

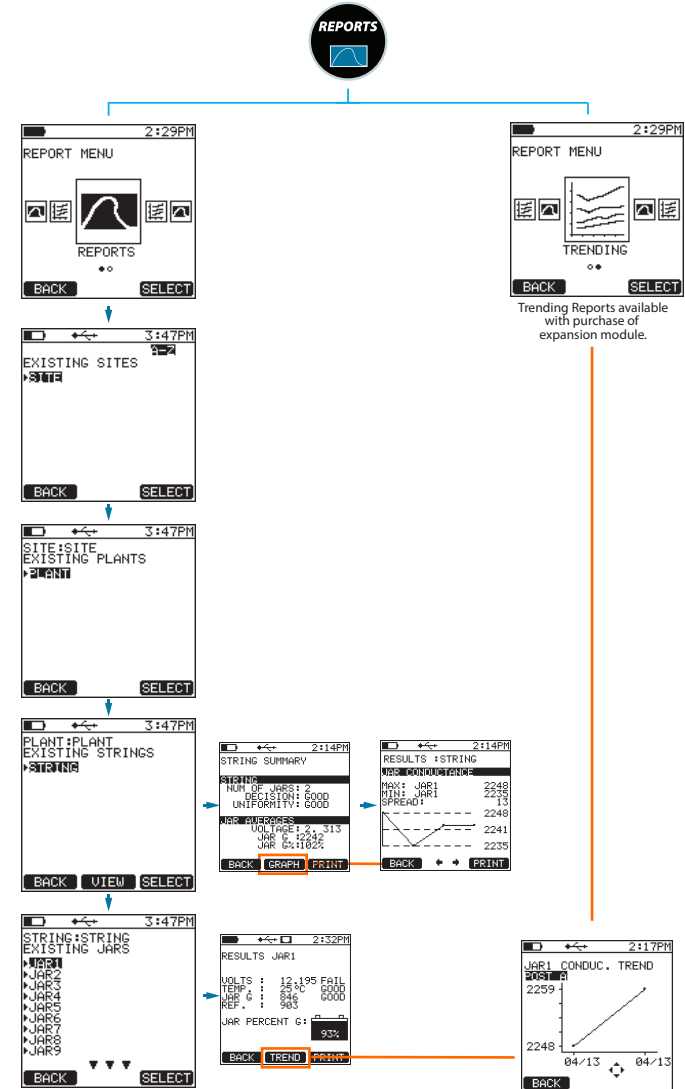
Results: The Reports menu allows for the selection of individual battery string results and other system information. Graphs and results can be generated from this menu.



1. Use the UP/DOWN buttons to navigate from jar to jar.
2. Use RIGHT/LEFT buttons for post results.
3. Press  anytime to retest any jar in review screen.

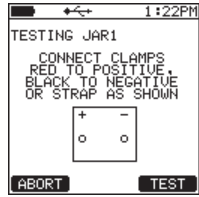

Site Setup: Next, attach clamps or probes to the battery posts.

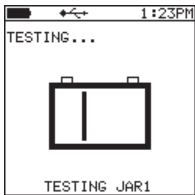
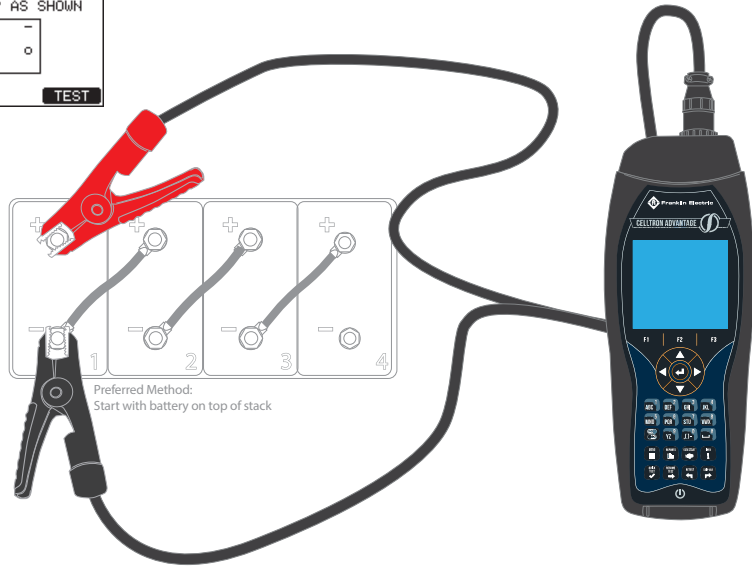

Progress screen is shown during the testing of your battery.



Result Screen:
This screen shows the results after you have tested your battery.

CELLTRON ADVANTAGE will run a test on the number of jars in your battery and give you result per jars.

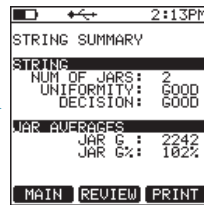

End Result Screen

The parts listed are all accessories that are available for the CELLTRON ADVANTAGE :



CA026
Interchangeable Test Cable



CA093 Probe Set
CA093R Red Probe
CA093B Black Probe



CA091
Battery Charger



CA031
Waffle Probe Tips

Optional Accessories:



CA092 Clamp Set
CA092R Red Clamp
CA092B Black Clamp



CA034
Probe Extender Kit



CA096
Cradle Charger

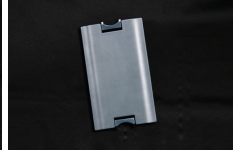

CA090
Battery Pack



CA087
Printer



CA089
USB Flash Drive



CA049
USB Cable



CA069
Long Probe Tips Kit



CA025
Long Probe Cable



CA024
Long Clamp Cable

1. Using the Quick Keys, you will be able to easily perform a function with the **CELLTRON ADVANTAGE**.

MAIN MENU The Main Menu key allows a quick return to the main menu and all of its functions.

REPORTS The Reports key generates the report options from both past and present battery tests.

GEN START The Gen Start activates the function (optional) to test a generator or engine start battery.

HELP The Help key lists tester information

QUICK TEST The Quick Test bypasses the base setup information for testing a cell, unit, jar, or battery. This allows you to perform a single test; the test results can be viewed on the screen but are not saved or stored.

RESUME TEST The Resume Test key resumes an interrupted test.

RETEST The Retest key enables you to retest a cell, unit, jar, or battery that has been previously tested. (Normally due to a suspect reading)

SKIP JAR The Skip Jar key enables you to put a placeholder of 0.000V and 0 conductance for a cell, unit, jar, battery, that is too low for the **CELLTRON ADVANTAGE** to test in the battery string.

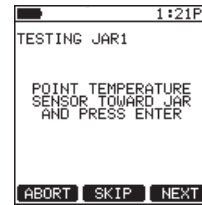

Site Setup: To begin testing, a battery temperature must be taken. It is recommended that the measurement be taken close to the negative post.

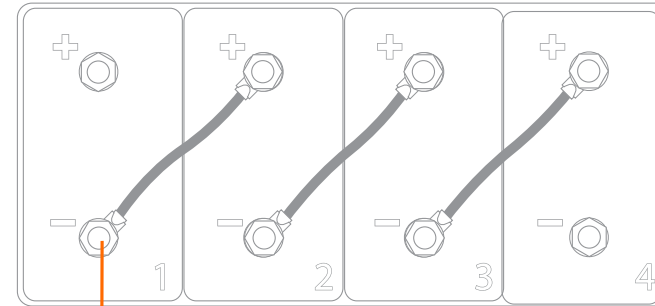

Preferred Method:
Start with battery on top of stack



continued →

1 Performing a battery test.

Getting Started: Before you start testing your battery you have to complete a few steps to properly retrieve and save your data. Below are the screens that will get you ready to start testing.



Site Setup: Enter a unique site or identifier.



Site Setup: Enter an identifier for the battery plant.

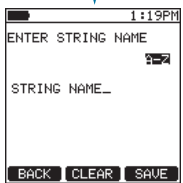

Site Setup: String name can be unique or consistent with plant configuration.



Site Setup: Enter Tech I.D.

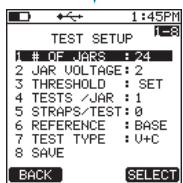

Follow prompts to input test parameters.

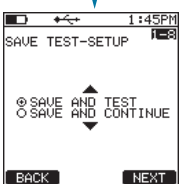

Choose save and test to begin test process or continue to additional setup.

- 1 Using the “Main Menu” Quick Key, you will be able to navigate thru the CELLTRON ADVANTAGE options. Select your desired screen and press the  button. This will open up your options per screen/section. Choose desired function.



Main Menu Quick Key

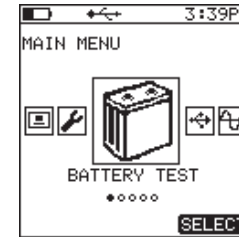

Begins the process of site, string, battery setup.



Transfer data to/from CELLTRON ADVANTAGE

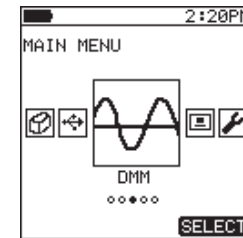

Digital Multimeter is available with an upgraded package. DC / AC Voltage Measurement

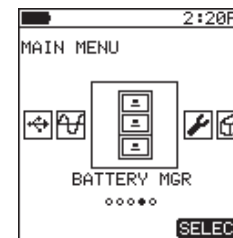

Internal battery reference base.

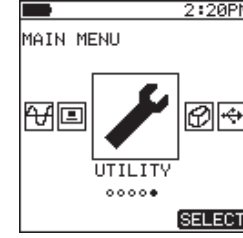

Utility setting for system including temperature, scale, clock, day/date, etc.

2 Utilizing the following screens you can choose the desired function you wish to perform.

BATTERY TEST

Site Setup: For a standard battery test, you will setup a site. For a breakdown of this procedure, please reference page 12, Performing a Battery Test.

Let's you create new battery set up.

Let's you use existing sites.

Pick your favorite site and plant from Utilities Menu

DATA MANAGER

Data Manager: Allows the upload, download, and deletion of data.

Upload your test results via USB flash drive to CELLTRAQ.

Download your test results via USB flash drive from CELLTRAQ.

Delete old or unwanted results.

Enables you to update tester from file via USB.

BATTERY MANAGER

Battery Manager: Choose the manufacturer of the battery you are testing

This screen allows you to choose the manufacturer of the battery you are testing.

Choose model.

Configure detail.

DMM Multi-meter

DMM Multi-meter: Allows the DMM multimeter Function.

This screen allows you to choose DC Volts function

This screen allows you to choose AC Volts function

Typical DC Volts measurement.

UTILITY

Utility: Helps you set the way you want your CELLTRON ADVANTAGE to function.

Set tester thresholds for voltage, conductance, and temperature.

Set the date and time.

Choose preferred language.

Sets tester to activate test process on contact.

Set display brightness, contrast, etc.

Set temperature mode: per jar or per string.

Enables you to start a test on a single cell or monoblock without first setting up a site.

Enables you to record cell voltages on a timed interval during a capacity load test.

File type selection for exporting data use w/ CELLTRAQ EXPRESS or CELLTRAQ ENTERPRISE

Select and activate additional capabilities of the CELLTRON ADVANTAGE.

Set up favorites for quick access.

continued →