



# Thermo Scientific Fresco 17 / 21 Centrifuge

## Instructions for Use

50133376-e • 06 / 2020

## **WEEE Conformity**

This product is subject to the regulations of the EU Waste Electrical & Electronic Equipment (WEEE) Directive 2012/19/EU. It is marked by the following symbol:



# Table of Contents

	<b>Preface</b> .....	<b>iii</b>
	<b>Scope of Supply</b> .....	<b>iii</b>
	<b>Intended Use</b> .....	<b>iv</b>
	<b>Accident Prevention</b> .....	<b>iv</b>
	<b>Precautions</b> .....	<b>v</b>
<b>Chapter 1</b>	<b>Introduction and Description</b> .....	<b>1-1</b>
	Characteristics of the Fresco 17 / 21 .....	1-2
	Technical Data .....	1-3
	Directives, Standards and Guidelines .....	1-4
	Functions and Features .....	1-5
	Mains Supply .....	1-5
	Rotor Selection .....	1-6
	Refrigerant .....	1-6
<b>Chapter 2</b>	<b>Before Use</b> .....	<b>2-1</b>
	Before Setting up .....	2-2
	Transporting the Centrifuge .....	2-2
	Location .....	2-2
	Aligning the Centrifuge .....	2-3
	Mains Connection .....	2-3
	Storage .....	2-4
<b>Chapter 3</b>	<b>Control Panel</b> .....	<b>3-1</b>
	Control Panel .....	3-2
	Keys .....	3-2
<b>Chapter 4</b>	<b>Operation</b> .....	<b>4-1</b>
	Switch on Centrifuge .....	4-2
	Door Opening .....	4-2
	Close Door .....	4-2
	Rotor Installation .....	4-2
	Entering Parameters .....	4-4
	Centrifugation .....	4-8
	Short-term Centrifugation .....	4-8
	Removing the Rotor .....	4-9
	Aerosol-tight Rotors .....	4-9
	Audible Alarm .....	4-9
	Turning off the Centrifuge .....	4-10
<b>Chapter 5</b>	<b>Maintenance and Care</b> .....	<b>5-1</b>
	Cleaning Intervals .....	5-2
	Cleaning .....	5-2
	Disinfection .....	5-4

## Contents

	Decontamination .....	5-5
	Autoclaving .....	5-5
	Service of Thermo Fisher Scientific .....	5-6
	Shipping and Depositing of Accessories .....	5-6
<b>Chapter 6</b>	<b>Troubleshooting .....</b>	<b>6-1</b>
	Mechanical Emergency Door Release .....	6-2
	Troubleshooting by User .....	6-3
	When to contact Service Technician .....	6-5
	<b>Chemical Compatibility Chart .....</b>	<b>A-1</b>
	<b>Index .....</b>	<b>I-1</b>

## Preface

Before starting to use the centrifuge, read through this instruction manual carefully and follow the instructions.

The information contained in this instruction manual is the property of Thermo Fisher Scientific; it is forbidden to copy or pass on this information without explicit approval.

Failure to follow the instructions and safety information in this instruction manual will result in the expiration of the sellers warranty.

## Scope of Supply

Article number		Quantity	Check
	Centrifuge Fresco 17 / 21	1	<input type="checkbox"/>
	Power Supply Cable	1	<input type="checkbox"/>
	Rotor	1	<input type="checkbox"/>
20360104	Allen Wrench	1	<input type="checkbox"/>
50133376	CD with Instruction Manual	1	<input type="checkbox"/>

If any parts are missing, please contact your nearest Thermo Fisher Scientific representative.



This symbol refers to general hazards.

**WARNING** means that injuries or material damage or contamination could occur.

**CAUTION** means that material damage could occur.



This symbol refers to biological hazards.

Observe the information contained in the instruction manual to keep yourself and your environment safe.



This symbol refers to hot surfaces

Observe the information contained in the instruction manual to keep yourself and your environment safe.

## Intended Use

- This centrifuge is a laboratory product designed to separate components by generation of Relative Centrifugal Force. It separates human samples (e.g. blood, urine and other body fluids) collected in appropriate containers, either alone or after addition of reagents or other additives.
- As general purpose centrifuge, it is designed to also run other containers filled with chemicals, environmental samples and other non-human body samples.
- Together with the hematocrit rotor 75003473 the centrifuge can be used as an in-vitro diagnostics device to determine the haematocrit value by using centrifugation. Apply DIN 58933 to determine the hematocrit value.
- The centrifuge is to be used for separating materials of different density or particle size suspended in a liquid.

Maximum sample density at maximum speed:  $1.2 \frac{g}{cm^3}$

## Accident Prevention



**WARNING** If a hazardous situation occurs, turn off the power supply to the centrifuge and leave the area immediately.



**WARNING** In case of a rotor failure the centrifuge can be damaged. The cooling agent can escape. Ventilate the room well and leave it. Inform Customer Service.

Prerequisite for the safe operation of the Fresco 17 / 21 is a work environment in compliance with standards, directives and trade association safety regulations and proper instruction of the user.

The safety regulations contain the following basic recommendations:

- Maintain a radius of at least 30 cm around the centrifuge.

**Remaining risk: Improper use can cause damages, contamination, and injuries with fatal consequences.**

- Implementation of special measures which ensure that no one can approach the centrifuge for longer than absolutely necessary while it is running.
- The mains plug must be freely accessible at all times. Pull out the power supply plug or disconnect the power supply in an emergency.



# Precautions

In order to ensure safe operation of the Fresco 17 / 21, the following general safety regulations must be followed:

- The centrifuge should be operated by trained specialists only.
- The centrifuge is to be used for its intended use only.
- While handling centrifuge, rotor, and samples you must wear laboratory clothing (e.g. gloves).
- Plug the centrifuge only into sockets which have been properly grounded.
- Do not move the centrifuge while it is running.
- Do not lean on the centrifuge.
- Use only rotors and accessories for this centrifuge which have been approved by Thermo Fisher Scientific. Exceptions to this rule are commercially available glass or plastic centrifuge tubes, provided they have been approved for the speed or the RCF value of the rotor.
- Do not use rotors which show any signs of corrosion and/or cracks.
- Do not touch the mechanical components of the rotor and do not make any changes to the mechanical components.
- Use only with rotors which have been properly installed. Follow the instructions in section “[Rotor Installation](#)” on [page 4-2](#).
- Use only with rotors which have been loaded properly. Follow the instructions given in the rotor manual.
- Never overload the rotor. Follow the instructions given in the rotor manual.
- Never open the lid until the rotor has come to a complete stop and this has been confirmed in the display.
- The lid emergency release may be used in emergencies only to recover the samples from the centrifuge, e.g. during a power failure (see section “[Mechanical Emergency Door Release](#)” on [page 6-2](#)).
- Never use the centrifuge if parts of its cover panels are damaged or missing.
- Do not touch the electronic components of the centrifuge or alter any electronic or mechanical components.
- Please observe the safety instructions.





Please pay particular attention to the following aspects:

- Location: well-ventilated environment, set-up on a level and rigid surface with adequate load-bearing capacity.
- Rotor installation: Check that the rotor is locked properly into place before operating the centrifuge.
- Especially when working with corrosive samples (salt solutions, acids, bases), the accessory parts and rotor chamber have to be cleaned carefully.
- Always balance the samples.

Centrifuging hazardous substances:



- Do not centrifuge explosive or flammable materials or substances which could react violently with one another.
- The centrifuge is neither inert nor protected against explosion. Never use the centrifuge in an explosion-prone environment.
- Do not centrifuge inflammable substances.

**Remaining risk: Improper use can cause damages, contamination, and injuries with fatal consequences.**

- Do not centrifuge toxic or radioactive materials or any pathogenic micro-organisms without suitable safety precautions.  
When centrifuging microbiological samples from the Risk Group II (according to the Biosafety Manual" of the World Health Organization (WHO)), aerosol-tight biological seals have to be used.  
For materials in a higher risk group, extra safety measures have to be taken.

- If toxins or pathogenic substances have gotten into the centrifuge or its parts, appropriate disinfection measures have to be taken (see [“Disinfection” on page 5-4](#)).  
**Remaining risk: Improper use can cause damages, contamination, and injuries with fatal consequences.**
- Highly corrosive substances which can cause material damage and impair the mechanical stability of the rotor, should only be centrifuged in corresponding protective tubes.



# Introduction and Description

## Contents

- “Characteristics of the Fresco 17 / 21” on page 1-2
- “Technical Data” on page 1-3
- “Directives, Standards and Guidelines” on page 1-4
- “Functions and Features” on page 1-5
- “Mains Supply” on page 1-5
- “Rotor Selection” on page 1-6

## Characteristics of the Fresco 17 / 21

You can use various rotors with commercially available containers.

The set speed is reached within seconds. The maintenance-free induction motor ensures quiet and low-vibration operation even at high speeds, and guarantees a very long lifetime.

The user-friendly control panel makes it easy to pre-set the speed, RCF value, running time, and temperature. You can choose between the display of speed and RCF or the entry mode.

These settings can be changed even while the centrifuge is running.

With the help of the  key you can also centrifuge a sample for just a few seconds, if called for.

The Fresco 17 / 21 is equipped with various safety features:

- The housing is made of high-impact resistant plastic and the interior of armour steel.
- The lid is equipped with a view port and a lock.
- The lid of the centrifuge can only be opened while the centrifuge is switched on and the rotor has come to a complete stop. The centrifuge cannot be started until the lid has been closed properly.
- An electronic imbalance recognition in ventilated centrifuges.
- For emergencies only, e.g. during power failures (see [“Mechanical Emergency Door Release”](#) on [page 6-2](#))

## Technical Data

The technical data of the Fresco 17 / 21 is listed in the following table.

**Table 1-1.** Technical Data Fresco 17

Feature	Value		
Environmental Conditions	-Use in interior Spaces -Altitudes of up to 2,000 m above Sea Level -Max. relative Humidity 80 % up to 31 °C; Decreasing linearly up to 50 % relative Humidity at 40 °C		
Permissible Ambient Temperature during Operation	+5 °C to +40 °C	+5 °C to +40 °C	+5 °C to +40 °C
Permissible Ambient Temperature during Storage and Shipping	+2 °C to +50 °C	+2 °C to +50 °C	+2 °C to +50 °C
Overvoltage Category	II	II	II
Pollution Degree	2	2	2
Heat Dissipation	Fresco 17	Fresco 17	Fresco 17
	230 V	120 V	100 V
	1092 BTU/h	1126 BTU/h	1126 BTU/h
IP	20	20	20
Run Time	unlimited	unlimited	unlimited
Max Speed $n_{max}$	13300 rpm	13300 rpm	13300 rpm
Min Speed $n_{min}$	300 rpm	300 rpm	300 rpm
Maximum RCF Value at $n_{max}$	17000 x g	17000 x g	17000 x g
Maximum Kinetic Energy	<1.90 kNm	<1.90 kNm	<1.90 kNm
Noise Level at maximum Speed	< 50 dB (A)	< 50 dB (A)	< 50 dB (A)
Dimensions			
Height	330 mm	330 mm	330 mm
Width	292 mm	292 mm	292 mm
Depth	440 mm	440 mm	440 mm
Weight without Rotor	28 kg	28 kg	28 kg

**Table 1-2.** Technical Data Fresco 21

Feature	Value		
Environmental Conditions	-Use in interior Spaces -Altitudes of up to 2,000 m above Sea Level -Max. relative Humidity 80 % up to 31 °C; Decreasing linearly up to 50 % relative Humidity at 40 °C		
Permissible Ambient Temperature during Operation	+5 °C to +40 °C	+5 °C to +40 °C	+5 °C to +40 °C
Permissible Ambient Temperature during Storage and Shipping	+2 °C to +50 °C	+2 °C to +50 °C	+2 °C to +50 °C

**Table 1-2.** Technical Data Fresco 21

Feature	Value		
Overvoltage Category	II	II	II
Pollution Degree	2	2	2
Heat Dissipation	Fresco 21	Fresco 21	Fresco 21
	230 V	120 V	100 V
	1262 BTU/h	1297 BTU/h	1228 BTU/h
IP	20	20	20
Run Time	unlimited	unlimited	unlimited
Max Speed $n_{max}$	14800 rpm	14800 rpm	14800 rpm
Min Speed $n_{min}$	300 rpm	300 rpm	300 rpm
Maximum RCF Value at $n_{max}$	21100 x g	21100 x g	21100 x g
Maximum Kinetic Energy	<2.35 kNm	<2.35 kNm	<2.35 kNm
Noise Level at maximum Speed	< 50 dB (A)	< 50 dB (A)	< 50 dB (A)
Dimensions			
Height	330 mm	330 mm	330 mm
Width	292 mm	292 mm	292 mm
Depth	440 mm	440 mm	440 mm
Weight without Rotor	28 kg	28 kg	28 kg

## Directives, Standards and Guidelines

**Table 1-3.** Directives, Standards and Guidelines

Region	Marked	Standard
<b>Europe</b> 220-230 V, 50 / 60 Hz 230 V, 50 / 60 Hz	98/79/EC In Vitro Diagnostics	EN 61010-1
	2011/65/EU RoHS	EN 61010-2-020
	Directive on the Restriction of the use of certain Hazardous Substances in electrical and electronic equipment	EN 61010-2-101
	Protective goals of:	EN 61326-1 Class B
	2006/42/EC Machinery	EN 61326-2-6
	2014/35/EU Low Voltage	EN ISO 14971
	2014/30/EU Electromagnetic Compatibility (EMC)	EN ISO 13485
<b>USA &amp; Canada</b> 220-230 V, 50 / 60 Hz 120 V, 60 Hz	FDA listed	ANSI/UL 61010-1
	Product code JQC	UL 61010-2-020
	centrifuges for clinical use	UL 61010-2-101
	Device class 1	EN ISO 14971
		EN ISO 13485
<b>Japan</b> 100 V, 50 / 60 Hz		IEC 61010-1
		IEC 61010-2-020
		IEC 61010-2-101
		IEC 61326-2-6
<b>China</b> 230 V, 50 / 60 Hz 208-240 V, 50 / 60 Hz	CFDA listed	IEC 61326-1 Class B
		EN ISO 14971
		EN ISO 13485

## Functions and Features

The following table contains an overview of the electrical connection data for the Fresco 17 / 21.

**Table 1-4.** Functions and Features

Component / Function	Description / Features
Structure / Housing	Sheet steel chassis with attached plastic housing and steel reinforcement
Rotor Chamber	Plastic with galvanized steel reinforcement guard ring Up to 48 ml of spilled liquids are retained in the chamber and cannot enter the instrument.
Drive	Induction drive without carbon brushes
Keys and Display	Easy-to-clean keypad and display surface
Controls	Microprocessor-controlled
Internal Memory	Most recent data is saved
Functions	RCF-selection, temperature control, pretemp
Imbalance Recognition	Electronic in ventilated centrifuges
Door Lock	Automatic door closing and locking starting from an initial hold position

## Mains Supply

The following table contains an overview of the electrical connection data for the der Fresco 17 / 21.  
This data is to be taken into consideration when selecting the mains connection socket.

**Table 1-5.** Electrical connection data

Cat.		Mains voltage	Frequency	Rated current	Power consumption	Equipment fuse	Building fuse
75002420 75002423	Fresco 17	230 V $\pm$ 10%	50 / 60 Hz	1.9 A	320 W	4 A, 2-pole circuit breaker	16 AT
75002421 75002402	Fresco 17	120 V $\pm$ 10%	60 Hz	3.9 A	330 W	8 A, 2-pole circuit breaker	15 AT
75002425 75002555	Fresco 21	230 V $\pm$ 10%	50 / 60 Hz	2.2 A	370 W	4 A, 2-pole circuit breaker	16 AT
75002426 75002556	Fresco 21	120 V $\pm$ 10%	60 Hz	4.4 A	380 W	8 A, 2-pole circuit breaker	15 AT

## Rotor Selection

The Fresco 17 / 21 is supplied with a rotor. Various rotors are available to choose from.

24 x 1.5 / 2.0 mL Rotor	75003424
36 x 0.5 mL Rotor	75003436
Dual Row 18 x 2.0 / 0.5 mL Rotor	75003418
PCR 4 x 8 Rotor	75003440
PCR 8 x 8 Rotor	75003489
Hematocrit Rotor	75003473
10 x 5 mL Rotor	75003465

The technical data of the rotors and the corresponding adapters and reduction sleeves for various commercially available containers can be found in the corresponding rotor operating manuals.

For more information visit our website at: [www.thermofisher.com/centrifuge](http://www.thermofisher.com/centrifuge).

## Refrigerant

Art. No.	Centrifuge	Refrigerant	Quantity	Pressure	GWP	CO2e
75002420	Thermo Scientific Fresco17	R-134a	0.26 kg	21 bar	1430	0.37 t
75002421	Thermo Scientific Fresco 17	R-134a	0.26 kg	21 bar	1430	0.37 t
75002423	Thermo Scientific Fresco 17	R-134a	0.26 kg	21 bar	1430	0.37 t
75002402	Thermo Scientific Fresco 17	R-134a	0.26 kg	21 bar	1430	0.37 t
75002425	Thermo Scientific Fresco 21	R-134a	0.26 kg	21 bar	1430	0.37 t
75002426	Thermo Scientific Fresco 21	R-134a	0.26 kg	21 bar	1430	0.37 t
75002555	Thermo Scientific Fresco 21	R-134a	0.26 kg	21 bar	1430	0.37 t
75002556	Thermo Scientific Fresco 21	R-134a	0.26 kg	21 bar	1430	0.37 t

Contains fluorinated greenhouse gases in a hermetically sealed system.

## Before Use

### Contents

- “Before Setting up” on page 2-2
- “Transporting the Centrifuge” on page 2-2
- “Location” on page 2-2
- “Aligning the Centrifuge” on page 2-3
- “Mains Connection” on page 2-3
- “Storage” on page 2-4

## Before Setting up

1. Check the centrifuge and the packaging for any shipping damage.  
Inform the shipping company and Thermo Fisher Scientific immediately if any damage is discovered.
2. Remove the packaging.
3. Remove the rotor transport protection. The cardboard shall prevent damages due to impacts.
4. Check the order for completeness (see “[Scope of Supply](#)” on [page iii](#)).  
If the order is incomplete, please contact Thermo Fisher Scientific.

## Transporting the Centrifuge

- Due to its weight (see “[Technical Data](#)” on [page 1-3](#)), the centrifuge should be carried by several people.
- Always lift the centrifuge at both sides on the bottom plates.

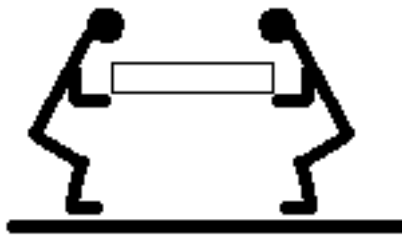

**Figure 2-1.** Lifting the centrifuge at both sides.

- The centrifuge can get damaged due to impacts.

## Location

The centrifuge should only be operated indoors.

The set-up location must fulfil the following requirements:

- A safety zone of at least 30 cm must be maintained around the centrifuge.  
People and hazardous substances must be kept out of the safety zone while centrifuging.
- The supporting structure must be stable and free of resonance, for example a level laboratory bench.
- The supporting structure must be suitable for horizontal setup of the centrifuge.
- The centrifuge should not be exposed to heat and strong sunlight.



**WARNING** UV rays reduce the stability of plastics.  
Do not subject the centrifuge, rotors and plastic accessories to direct sunlight.



- The set-up location must be well-ventilated at all times.

## Aligning the Centrifuge

The horizontal alignment of the centrifuge must be checked every time after moving it to a different location.

The supporting structure must be suitable for horizontal setup of the centrifuge.



**CAUTION** If the centrifuge is not level, imbalances can occur and the centrifuge can be damaged.  
Do not place anything under the feet to level the centrifuge.

## Mains Connection

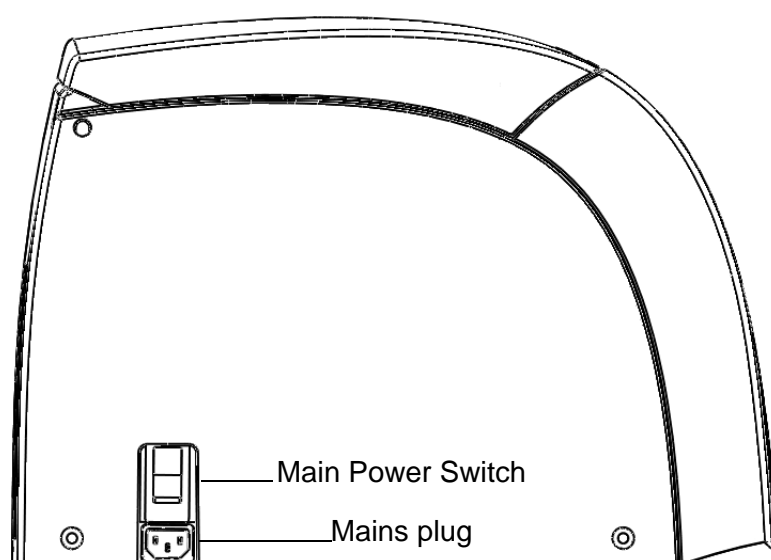

**Figure 2-2.** Mains Connection

1. Turn off the power supply switch on the back (press "0").
2. Plug the centrifuge into grounded electrical sockets only.

**Note** The centrifuge must be connected directly to a socket. Extensions and connectors are not allowed.

3. Check whether the cable complies with the safety standards of your country.
4. Make sure that the voltage and frequency correspond to the figures on the rating plate.  
Establish the connection to the power supply with the connecting cable.

## **Storage**

- Before storing the centrifuge and the accessories it must be cleaned and if necessary disinfected and decontaminated.
- Store the centrifuge in a clean, dust-free location.
- Be sure to place the centrifuge on its feet.
- Avoid direct sunlight.

# Control Panel

## Contents

- “Control Panel” on page 3-2
- “Keys” on page 3-2





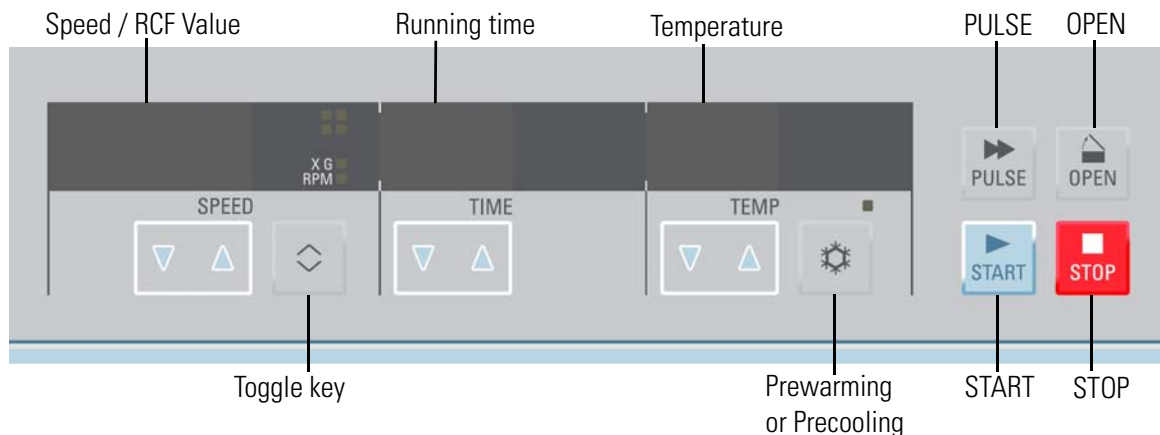





## Control Panel

In the control panel you find the keys and displays of the centrifuge. The main power switch is located on the left side. All parameters can be selected and changed during operation.



## Keys

The keys allow user intervention for controlling the operating mode as follows:

Key	Display contents
 <b>Start</b>	Normal start of the centrifuge
 <b>Stop</b>	End run manually
 <b>Open lid</b>	Automatic release (possible only when device is switched on). Emergency release (see <a href="#">"Mechanical Emergency Door Release"</a> on <a href="#">page 6-2</a> )
 <b>Pulse</b>	By pressing the  key the centrifuge starts immediately and accelerates up to the end speed. Releasing the key initiates a stopping process at the highest braking curves.
 <b>PreTemp</b>	By pressing the  key you start the pretemp function of the centrifuge.
	By pressing the  key up and down you change the value in the display. If you hold the key pressed, the display changes continuously at first slowly and after a few seconds at an accelerated pace to the higher or lower values. By pressing the key briefly, you increase or decrease the speed in one step. When pressing both arrows the cursor moves to the left.
 <b>Changing the display mode</b>	Use the  key to change the display mode. (speed / RCF value, sample / chamber temperature, run time counter from start or preset speed on)

# Operation

## Contents

- “Switch on Centrifuge” on page 4-2
- “Door Opening” on page 4-2
- “Close Door” on page 4-2
- “Rotor Installation” on page 4-2
- “Entering Parameters” on page 4-4
- “Centrifugation” on page 4-8
- “Short-term Centrifugation” on page 4-8
- “Removing the Rotor” on page 4-9
- “Aerosol-tight Rotors” on page 4-9
- “Audible Alarm” on page 4-9
- “Turning off the Centrifuge” on page 4-10

## Switch on Centrifuge

1. Switch on the centrifuge.  
The centrifuge shows the actual value in the display. Speed and Run time show **0**. The display shows the current temperature of the sample.

## Door Opening

1. Press the  key.  
The display shows the following message:



**Note** Use the emergency release only for malfunctions and power failures (see “[Mechanical Emergency Door Release](#)” on [page 6-2](#)).

## Close Door

1. Close the door by pressing down on it lightly in the middle or on both sides of it.

**Note** The door should audibly click into place.



**CAUTION** Do not slam the door.

## Rotor Installation

The approved rotors for the Fresco 17 / 21 are listed in section “[Rotor Selection](#)” on [page 1-6](#). Use only the rotors and accessories from this list in the centrifuge.



**CAUTION** Unapproved or incorrectly combined accessories can cause serious damage to the centrifuge.

Proceed as follows:

1. Open the door of the centrifuge and if necessary remove any dust, foreign objects or residue from the chamber.  
Thread and o-ring must be clean and undamaged.



**CAUTION** Do not install the rotor when the temperature difference between shaft and rotor lock is  $>20$  °C. Otherwise the rotor might jam during the installation. A jammed rotor can lead to damages of centrifuge and rotor.

2. Hold the rotor over the centrifuge spindle. The two bars in the labeling on the upper side of the rotor (a) must be above the retaining pin (b) of the centrifuge spindle.

a

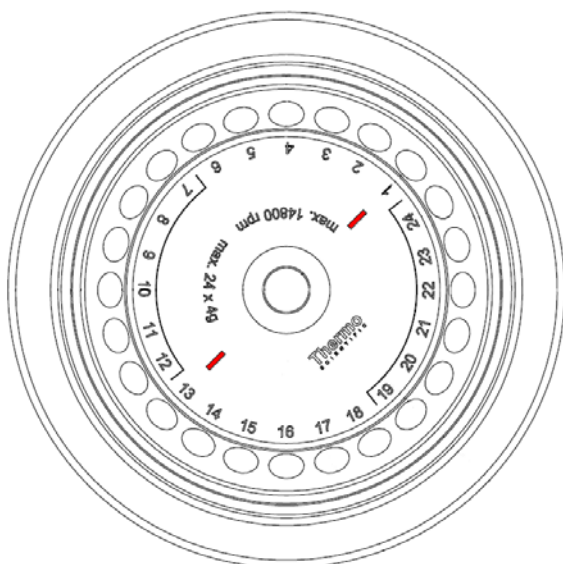

b

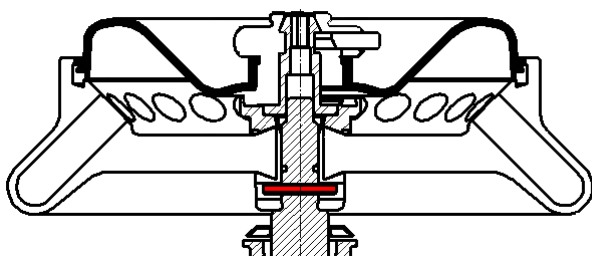

3. Let the rotor slide slowly down the centrifuge spindle.



**CAUTION** Do not force the rotor onto the centrifuge spindle. If the rotor is very light, then it may be necessary to press it onto the centrifuge spindle with a bit of pressure.

4. Thread the fastening tool into the centrifuge spindle clockwise. Hold the rotor with the other hand into position.
5. Close the rotor.
6. Check if the rotor is properly installed by lifting it slightly on the handle.



**WARNING** Check for any damage to the rotor: Damaged rotors must not be used. Keep the centrifuge spindle area of the rotor clear of objects.



**CAUTION** Check that the rotor is properly locked on the centrifuge spindle before each use by pulling it at its handle. Fasten the rotor if necessary.



Be sure to check all sealings before starting any aerosol-tight applications.



See the information in the rotor instruction manual.

7. Close the centrifuge door.

## Entering Parameters

**Note** Due to limited display digits there is a need to round the values. The direct comparison between the two values speed and RCF is therefore restricted.

### Select Speed or RCF-Value

1. Press the  key under the left display. When the lower indicator is lit the display shows the speed. Press the  key to toggle between the two modes.

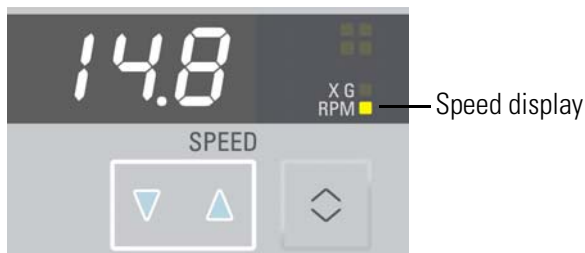



2. When the upper indicator is lit the display shows the RCF value. Press the  key to toggle between the two modes.







### Pre-selecting Speed

1. Enter the desired value by pressing the key   repeatedly, until the desired value shows.  
You can adjust the speed in 100 rpm increments.
2. Press the  key to confirm the pre-selected value.  
If you do not press any key, the display flashes for a few seconds. The new preselected value is now stored and the display shows the actual value.

**Note** The centrifuge speed can be set to a minimum of 300 rpm.  
The maximum speed depends on the centrifuge variant.

### Pre-selecting RCF-Value

1. Enter the desired value by pressing the key   repeatedly, until the desired value shows.  
You can adjust the RCF pre-selected value in steps of 100 x g.
2. Press the  key to confirm the pre-selected value.  
If you do not press any key, the display flashes for a few seconds. The new preselected value is now stored and the display shows the actual value.

**Note** The RCF value can be set to a minimum of 100 x g.  
The maximum speed depends on the centrifuge variant.  
The displayed RCF value is always corresponding to the maximum of centrifuge radius of the 24 x 1.5 / 2.0 mL Rotor (75003424).  
Refer to the “[Explanation of RCF-Value](#)” on [page 4-5](#) and the rotor manual for further information.

### Explanation of RCF-Value

The relative centrifugal force (RCF) is given as a multiple of the force of gravity g. It is a unitless numerical value which is used to compare the separation or sedimentation capacity of various centrifuges, since it is independent of the type of device. Only the centrifuging radius and the speed come into play in it:

$$\text{RCF} = 11.18 \times \left\langle \frac{n}{1000} \right\rangle^2 \times r$$

r = centrifuging radius in cm

n = rotational speed in rpm



The maximum RCF value is related to the maximum radius of the tube opening.

Remember that this value is reduced depending on the tubes and adapters used.

This can be accounted for in the calculation above if required.

## Run Time Pre-selection

**Note** You can select a run time between 1 and 99 min or continuous operation.

1. Enter the desired value by pressing the key  below the display in the middle repeatedly, until the desired value shows.  
You can adjust the run time in steps of 1 min.
2. Press the  key to confirm the pre-selected value.  
If you do not press any key, the display flashes for a few seconds. The new preselected value is now stored and the display shows the actual value.



## Continuous Operation

1. Press the  key until **hd** is shown.





2. During continuous operation, the centrifuge will continue running until you stop it manually with the  key.



**CAUTION** Please note that the lifetime of particularly plastic rotor tubes is limited. Continuous operation (extended use) may cause damage to them.

## Pre-selecting the Temperature

You can determine the sample temperature in °C. Proceed as follows:



1. Enter the desired value by pressing the key  under the right display repeatedly, until the desired value shows.  
You increase or decrease the temperature in steps of 1 °C.
2. Press the  key to confirm the pre-selected value.  
If you do not press any key, the display flashes for a few seconds. The new preselected value is now stored and the display shows the actual value.





3. Close the centrifuge door.
4. Restart the centrifuge.  
The refrigeration starts operating if the pre-selected temperature is below the current temperature of the rotor chamber.

### Pre-warming or Pre-cooling the Centrifuge

In order to pre-temp the centrifuge and the unloaded rotor proceed as follows:

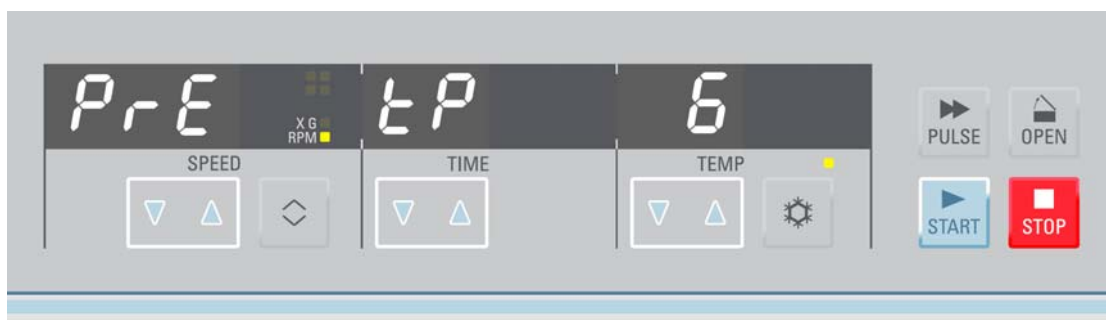
1. Press the  key.  
An indicator above the  key indicates operation at the activated pre-temp function.



2. Enter the desired value by pressing the key  under the right display repeatedly, until the desired value shows.  
You increase or decrease the temperature in steps of 1 °C.
3. Press the  key.  
The rotor will be operated at optimal speed.

**Note** When you press a different key than the  key you will quit the pre-temp function.

**Note** If you wish to change the temperature of your samples, please consider that the time required for temperature adjustment is prolonged. For critical applications you should take other precautions to ensure that the desired temperature is actually reached and maintained.

### Changing the settings during the run

You can change the settings during the run as follows:

1. Press one of the three  keys in the control panel.  
The current value will switch into the pre-selecting value mode.
2. Enter the new value as described above.

3. Press the  key.  
The value is taken over immediately.

## Centrifugation

Once the rotor has been properly installed, the main switch has been turned on and the door has been closed, you can start centrifuging.

### Starting Centrifuge Program

Press the  key on the control panel. The centrifuge accelerates to the preset speed with the time display active.

The run display begins to count down from the pre-selected value. If the remaining run time is less than 1 minute, the remaining time is given in seconds.

The circulating indicators in the left display represent the spinning rotor.

In continuous operation **hd** the time display counts up. The displayed run time is first in seconds. After one minute the displays changes every minute.

### Stopping the Centrifugation Program

#### With preset Run Time



If the run time has been pre-selected, and all you have to do, is to wait until the centrifuge terminates the run automatically.

As soon as the speed drops to zero, the message **END** will appear in the display. By pressing the  key, you can open the door and remove the centrifuge material.

You can also stop the centrifuging program manually at any time by pressing the  key.

#### Continuous Operation

If you selected continuous operation (see “[Continuous operation](#)” on [page 4-6](#)), you will have to stop the centrifuge manually.

1. Press the  key on the control panel.  
The centrifuge will be decelerated at the designated rate.
2. Press the  key to open the centrifuge door and the remove the samples when the message **END** appears in the display.

## Short-term Centrifugation

For short-term centrifuging, the Fresco 17 / 21 has a PULSE- function.

By holding down the  key, spinning will start and continue until the key is let go.

The centrifuge accelerates and brakes at maximum power. The pre-selected value is ignored.

**Note** The centrifuge accelerates to the maximum speed.  
Check carefully whether you have to maintain a certain speed for your application.

The displayed run time is first in seconds. After one minute the displays changes every minute.

After an short-term centrifugations the set values are restored.

## Removing the Rotor

To remove the rotor, proceed as follows:

1. Open the centrifuge door.
2. Unscrew the rotor with the allen wrench.
3. Grab the rotor in the middle. Pull the rotor directly upwards and remove it from the centrifuge spindle. Make sure not to tilt the rotor while doing this.



**WARNING** Be careful, when you change a rotor after a run. Centrifuge spindle and motor bearing assembly can be hot (>55 °C).

## Aerosol-tight Rotors

When using an aerosol tight lid the rotor can be removed with the lid closed. This is to protect you and the samples.

## Audible Alarm

### Error

Accompanying all error messages, a warning signal is given out.

Press any key to silence the warning signal.

### End of Run

By default there is an acoustic signal at the end of any centrifugation run. To switch off this signal proceed as follows:

Press the  key when you turn on the centrifuge.

The display shows:





## 4 Operation

### Turning off the Centrifuge

or



4. Press the  key under the display in the middle.  
The acoustic signal is turned on or off.
5. Press the  key to confirm the pre-selected value.

## Turning off the Centrifuge

1. To turn off the centrifuge put the mains switch to "0".

**Note** The centrifuge is equipped with a special switch for balancing potential voltage discrepancies in the power grid. After pressing the mains switch the display therefore may still flash up to 10 seconds.

# Maintenance and Care

## Contents

- “Cleaning Intervals” on page 5-2
- “Cleaning” on page 5-2
- “Disinfection” on page 5-4
- “Decontamination” on page 5-5
- “Autoclaving” on page 5-5
- “Service of Thermo Fisher Scientific” on page 5-6

## Cleaning Intervals

For the sake of personal, environmental, and material protection, it is your duty to clean and if necessary disinfect the centrifuge on a regular basis.

Maintenance	Recommended Interval
Clean Rotor Chamber	Daily or when polluted
Clean Rotor	Daily or when polluted
Accessories	Daily or when polluted
Cabinet	Once per Month
Filter Unit	Every three Months
Ventilation Holes	Every six Months



**CAUTION** Refrain from using any other cleaning or decontamination procedure than those recommended here, if you are not entirely sure that the intended procedure is safe for the equipment.

Use only approved cleansers.

If in doubt, contact Thermo Fisher Scientific.

## Cleaning

When cleaning centrifuge

- Use warm water with a neutral solvent.
- Never use caustic cleaning agents such as soap suds, phosphoric acid, bleaching solutions or scrubbing powder.
- Rinse the cavities out thoroughly.
- Use a soft brush without metal bristles to remove stubborn residue.
- Afterwards rinse with distilled water.
- Place the rotors on a plastic grate with their cavities pointing down.
- If drying boxes are used, the temperature must never exceed 50 °C, since higher temperatures could damage the material and shorten the lifetime of the parts.
- Use only disinfectants with a pH of 6-8.
- Dry aluminum parts off with a soft cloth.
- After cleaning, treat the entire surface of aluminum parts with corrosion protection oil (70009824). Also treat the cavities with oil.
- Store the aluminum parts at room temperature or in a cold-storage room with the cavities pointing down.





**CAUTION** Before using any cleaning or decontamination methods except those recommended by the manufacturer, users should check with the manufacturer that the proposed method will not damage the equipment.

Clean centrifuge and accessories as follows:

1. Open the centrifuge.
  2. Turn off the centrifuge.
  3. Pull out the power supply plug.
  4. Grasp the rotor with both hands and lift it vertically off the centrifuge spindle.
  5. Remove the centrifuge tubes and adapters.
  6. Use a neutral cleaning agent with a pH value between 6 and 8 for cleaning.
  7. Dry all of the rotors and accessories after cleaning with a cloth or in a warm air cabinet at a maximum temperature of 50 °C.
- After cleaning, treat the entire surface of aluminum parts with corrosion protection oil (70009824). Also treat the cavities with oil.



**CAUTION** When cleaning, do not allow liquids, especially organic solvents, to get on the drive shaft or the bearings of the centrifuge. Organic solvents break down the grease in the motor bearing. The drive shaft could freeze up.

After some applications there might be ice in the rotor chamber. Let the ice melt and drain it off. Clean the rotor chamber as described above.

## Cleaning Filter Unit

Refrigerated centrifuges have a filter unit to protect the cooling device.

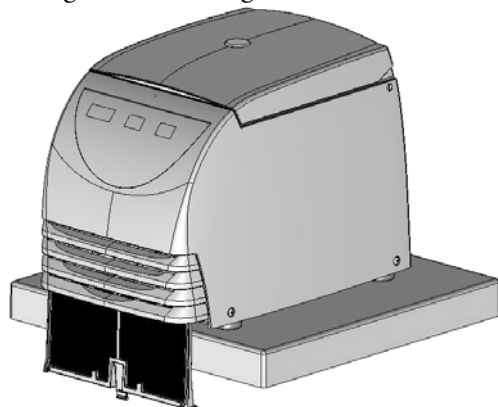

1. Pull the centrifuge to the edge of the table.
2. Pull the clip below the sucking grid and remove the filter unit completely by pulling it down.
3. Remove the cumulated dust with a soft cloth.

4. Inserting the filter again the labelling **Front** must show to the front of the centrifuge.
5. Push the filter upwards into the slot until the clip locks in the bottom plate.

## Disinfection

Disinfect the centrifuge immediately whenever infectious material has spilled during centrifugation.



**WARNING** Infectious material can get into the centrifuge when a tube breaks or as a result of spills. Keep in mind the risk of infection when touching the rotor and take all necessary precautions.

In case of contamination, make sure that others are not put at risk.

Decontaminate the affected parts immediately.

Take other precautions if need be.

The rotor chamber and the rotor should be treated preferably with a neutral disinfectant.



**CAUTION** Before using any cleaning or decontamination methods except those recommended by the manufacturer, users should check with the manufacturer that the proposed method will not damage the equipment.

Observe the safety precautions and handling instructions for the cleaning agents used.

Contact the Service Department of Thermo Fisher Scientific for questions regarding the use of other disinfectants.

Disinfect the rotor and accessories as follows:

1. Open the centrifuge.
2. Turn off the centrifuge.
3. Pull out the power supply plug.
4. Grasp the rotor with both hands and lift it vertically off the centrifuge spindle.
5. Remove the centrifuge tubes and adapters and dispose of them or disinfect them.
6. Treat the rotor and accessories according to the instructions for the disinfectant. Adhere strictly to the given application times.
7. Be sure the disinfectant can drain off the rotor.
8. Rinse the rotor and accessories thoroughly with water.
9. Dispose of the disinfectant according to the applicable guidelines.
10. Dry all of the rotors and accessories after cleaning with a cloth or in a warm air cabinet at a maximum temperature of 50 °C.
11. After cleaning, treat the entire surface of aluminum parts with corrosion protection oil (70009824). Also treat the cavities with oil.

## Decontamination

Decontaminate the centrifuge immediately whenever radioactive material has spilled during centrifugation.



**WARNING** Infectious material can get into the centrifuge when a tube breaks or as a result of spills. Keep in mind the risk of infection when touching the rotor and take all necessary precautions.

In case of contamination, make sure that others are not put at risk. Decontaminate the affected parts immediately. Take other precautions if need be.



**CAUTION** Before using any cleaning or decontamination methods except those recommended by the manufacturer, users should check with the manufacturer that the proposed method will not damage the equipment.

For general radioactive decontamination use a solution of equal parts of 70 % ethanol, 10 % SDS and water.

1. Open the centrifuge.
2. Turn off the centrifuge.
3. Pull out the power supply plug.
4. Grasp the rotor with both hands and lift it vertically off the centrifuge spindle.
5. Remove the centrifuge tubes and adaptors and dispose of them or disinfect them.
6. Rinse the rotor first with ethanol and then with de-ionized water.
  - Adhere strictly to the given application times.
7. Be sure the decontamination solution can drain off the rotor.
8. Rinse the rotor and accessories thoroughly with water.
9. Dispose of the decontamination solution according to the applicable guidelines.
10. Dry all of the rotors and accessories after cleaning with a cloth or in a warm air cabinet at a maximum temperature of 50 °C.
11. After cleaning, treat the entire surface of aluminum parts with corrosion protection oil (70009824). Also treat the cavities with oil.

## Autoclaving

1. Before autoclaving clean rotor and accessories and described above.
2. Place the rotor on a flat surface.
  - Rotors and adapter can be autoclaved at 121 °C.
  - The maximum permissible autoclave cycle is 20 minutes at 121 °C.

**Note** No chemical additives are permitted in the steam.



**CAUTION** Never exceed the permitted temperature and duration when autoclaving. If the rotor shows signs of corrosion or wear, it must be replaced.

## Service of Thermo Fisher Scientific

Thermo Fisher Scientific recommends having the centrifuge and accessories serviced once a year by an authorized service technician. The service technicians check the following:

- the electrical equipment
- the suitability of the set-up site
- the lid lock and the safety system
- the rotor
- the fixation of the rotor and the drive shaft

Thermo Fisher Scientific offers inspection and service contracts for this work. Any necessary repairs are performed for free during the warranty period and afterwards for a charge.

This is only valid if the centrifuge has only been maintained by a Thermo Fisher Scientific service technician.

## Shipping and Deposing of Accessories



**WARNING** Before shipping or deposing centrifuges and accessories you have to clean and if necessary disinfect or decontaminate everything.

# Troubleshooting

## Contents

- “Mechanical Emergency Door Release” on page 6-2
- “Troubleshooting by User” on page 6-3
- “When to contact Service Technician” on page 6-5

## Mechanical Emergency Door Release

During a power failure, you will not be able to open the centrifuge door with the regular electric door release. A mechanical override is provided to allow sample recovery in the case of an emergency. However, this should be used only in emergencies and after the rotor has come to a complete stop.



**WARNING** The rotor can still be spinning at high speed. If touched, it can cause serious injuries.

Always wait a few minutes until the rotor has come to a stop without braking. The brake does not work when there is no current. The braking process lasts much longer than usual.

Proceed as follows:

1. Make sure the rotor has stopped (view port in the lid).



**WARNING** Never use your hand or other tools to brake the rotor.

2. Pull out the power supply plug.
3. Insert a 3 inch long wire (e.g. a staple) into the hole above the control panel.
4. Press the centrifuge door down gently. Push the wire further into the hole until you hear and feel the door latch unlocking.
5. Remove the wire from the hole and open the centrifuge door.  
Now you can remove your samples.

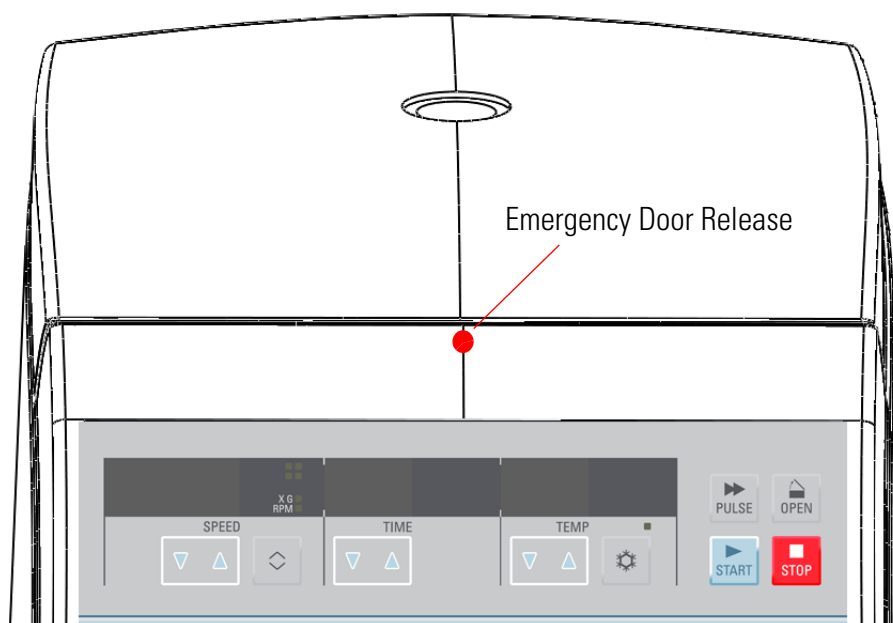



**Figure 6-1.** Emergency Door Release

Reconnect the centrifuge once the power has been restored. Switch on the centrifuge.

## Troubleshooting by User



If problems occur other than those listed in this table, the authorized customer service representative must be contacted.

Failure message	Problem with centrifuge	Possible causes and cures
Display remains dark.	The drive stops. The centrifuge runs down without being braked. The centrifuge door cannot be opened.	No mains connection 1. Is the centrifuge turned on? 2. Check the mains connection. If an error message appears again, inform Customer Service.
Display fails briefly	The drive stops. The centrifuge runs down without being braked.	Mains connection interrupted for some seconds, 1. Turn off mains switch. 2. Check whether the mains power cord is connected properly 3. Restart the centrifuge.
The centrifuge door cannot be opened.	Pressing  key has no effect.	Centrifuge door is not correctly engaged or warped. 1. Check if mains connection is working and the instrument is switched on (display is lit). 2. If this is unsuccessful, you may open the centrifuge door using the mechanical emergency door release (" <a href="#">Mechanical Emergency Door Release</a> " on <a href="#">page 6-2</a> )
-	Exceptionally running noise.	Imbalance 1. Stop the centrifuge. Press the  key or unplug mains power cord. 2. Wait until the centrifuge comes to a complete stop. 3. Check whether the rotor is properly loaded. Check whether a broken tube, damage to the rotor or motor is responsible for the run noise. If an error message appears again, inform Customer Service.
Display <b>oP</b> appears although lid is closed.	Centrifuge does not start.	Centrifuge door not properly closed. Open the centrifuge door and repeat locking procedure. If an error message appears again, inform Customer Service.
<b>Lid</b>	Rotor stops with deceleration to standstill.	Centrifuge door was opened manually during the run. Close centrifuge door immediately Rotor stops with deceleration to standstill. For further centrifugation, you have to switch the instrument off and switch it on again.
E-01 - E-13	Rotor stops with deceleration to standstill. The centrifuge cannot be operated.	Internal program error Switch the instrument off and on again. If an error message appears again, inform Customer Service.

Failure message	Problem with centrifuge	Possible causes and cures
E-14	Rotor stops with deceleration to standstill. The centrifuge cannot be operated.	Overtemperature in the centrifuge chamber. Switch the centrifuge off and turn it on again after approx. one minute. If an error message appears again, inform Customer Service.
E-15-E-16	Rotor stops with deceleration to standstill. The centrifuge cannot be operated.	Temperature measurement error Switch the instrument off and on again. If an error message appears again, inform Customer Service.
E-22 - E-23	Rotor stops with deceleration to standstill. The centrifuge cannot be operated.	Error in speed entry Switch the instrument off and on again. The display shows <b>BR</b> and a countdown from <b>100 - 0</b> . If an error message appears again, inform Customer Service.
E-24	The centrifuge cannot be operated.	Wrong status information from the door latch 1. Switch the instrument off and on again. 2. After re-switching on, the display shows <b>Lid FAiL</b> . 3. If the centrifuge door has been already opened, the display shows <b>CLOSE Lid</b> . Thereupon close the door. 4. The centrifuge tries to open the lid to switch for starting the normal operation mode. If an error message appears again, inform Customer Service.
E-29	Motor does not start	Motor or rotor blocked 1. Switch instrument off and on again using the mains switch. 2. Open the centrifuge door. 3. Check whether the rotor can turn freely. If an error message appears again, inform Customer Service.
E-31	Rotor stops without deceleration to standstill or does not start.	Overtemperature in the motor 1. Turn instrument off and unplug mains power cord. 2. Check and clean the venting slots if necessary and respectively the filter unit of the cooled centrifuge. 3. After approx. 60 minutes you can restart the instrument. Observe the maximum permissible environmental temperature. If an error message appears again, inform Customer Service.
E-33	Rotor stops with deceleration to standstill.	Overpressure in the refrigeration system 1. Turn instrument off and unplug mains power cord. 2. Check and clean the venting slots if necessary and respectively the filter unit of the cooled centrifuge. 3. After approx. 60 minutes you can restart the instrument. Observe the maximum permissible environmental temperature. If an error message appears again, inform Customer Service.
E-36	Rotor stops with deceleration to standstill. The centrifuge cannot be operated.	Overcurrent or error in current measurement Switch the instrument off and on again. If an error message appears again, inform Customer Service.



Failure message	Problem with centrifuge	Possible causes and cures
E-41 - E-56	Rotor stops with deceleration to standstill. The centrifuge cannot be operated.	Internal program error Switch the instrument off and on again. If an error message appears again, inform Customer Service.
E-60	Rotor stops with deceleration.	Insufficient temperature in the refrigeration unit. 1. Stop the centrifugation run. 2. Open the centrifuge door and defrost the chamber. Never touch the chamber directly with your hands – you may freeze up. 3. After approx. 60 minutes you can restart the instrument. Observe the maximum permissible ambient temperature 4. If a strong ice sheet is present in the internal chamber, be sure to remove all condensate after defrosting. If an error message appears again, inform Customer Service.

## When to contact Service Technician

If you need to contact customer service, please provide the order no. and the serial no. of your device. This information can be found on the back near the inlet for the power supply cable.

To identify the software version, proceed as follows:

1. Push the  key and then switch on the centrifuge.  
In the display all segments are lit.
- Subsequently, the following readings will be displayed for 5 seconds each:

Software number	SOFT	058	3_
Software version		_01	
NV-RAM number	EEPRO	462	1_
NV-RAM version		_01	
Cycle counter	CYCLE	001	25

- The values shown above are just examples.

Software	0583 Version 01
NV-RAM	4521 Version 01
cycles completed	125

2. Communicate the software version to the service technician.



# Chemical Compatibility Chart

CHEMICAL	MATERIAL																										
	ALUMINUM	ANODIC COATING for ALUMINUM	BUNA N	CELLULOSE ACETATE BUTYRATE	POLYURETHANE ROTOR PAINT	COMPOSITE Carbon Fiber/Epoxy	DELRIN	ETHYLENE PROPYLENE	GLASS	NEOPRENE	NORYL	NYLON	PET <sup>1</sup> , POLYCLEAR, CLEARCRIMP	POLYALLUMER	POLYCARBONATE	POLYESTER, GLASS THERMOSET	POLYETHERIMIDE	POLYRTHYLENE	POLYPROPYLENE	POLYSULFONE	POLYVINYL CHLORIDE	RULON A, TEFLON	SILICONE RUBBER	STAINLESS STEEL	TITANIUM	TYGON	VITON
2-mercaptoethanol	S	S	U	-	S	M	S	-	S	U	S	S	U	S	S	-	S	S	S	S	U	S	S	S	S	S	S
Acetaldehyde	S	-	U	U	-	-	-	M	-	U	-	-	-	M	U	U	U	M	M	-	M	S	U	-	S	-	U
Acetone	M	S	U	U	S	U	M	S	S	U	U	S	U	S	U	U	U	S	S	U	U	S	M	M	S	U	U
Acetonitrile	S	S	U	-	S	M	S	-	S	S	U	S	U	M	U	U	-	S	M	U	U	S	S	S	S	U	U
Alconox	U	U	S	-	S	S	S	-	S	S	S	S	S	S	M	S	S	S	S	S	S	S	S	S	S	S	U
Allyl Alcohol	-	-	-	U	-	-	S	-	-	-	-	S	-	S	S	M	S	S	S	-	M	S	-	-	S	-	-
Aluminum Chloride	U	U	S	S	S	S	U	S	S	S	S	M	S	S	S	S	-	S	S	S	S	S	M	U	U	S	S
Formic Acid (100 %)	-	S	M	U	-	-	U	-	-	-	-	U	-	S	M	U	U	S	S	-	U	S	-	U	S	-	U
Ammonium Acetate	S	S	U	-	S	S	S	-	S	S	S	S	S	S	S	U	-	S	S	S	S	S	S	S	S	S	S
Ammonium Carbonate	M	S	U	S	S	S	S	S	S	S	S	S	S	S	U	U	-	S	S	S	S	S	S	M	S	S	S
Ammonium Hydroxide (10 %)	U	U	S	U	S	S	M	S	S	S	S	S	-	S	U	M	S	S	S	S	S	S	S	S	S	M	S
Ammoniumhydroxid (28 %)	U	U	S	U	S	U	M	S	S	S	S	S	U	S	U	M	S	S	S	S	S	S	S	S	S	M	S
Ammonium Hydroxide (conc.)	U	U	U	U	S	U	M	S	-	S	-	S	U	S	U	U	S	S	S	-	M	S	S	S	S	-	U
Ammonium Phosphate	U	-	S	-	S	S	S	S	S	S	S	S	-	S	S	M	-	S	S	S	S	S	S	M	S	S	S
Ammonium Sulfate	U	M	S	-	S	S	U	S	S	S	S	S	S	S	S	S	-	S	S	S	S	S	S	U	S	S	U
Amyl Alcohol	S	-	M	U	-	-	S	S	-	M	-	S	-	M	S	S	S	S	M	-	-	-	U	-	S	-	M
Aniline	S	S	U	U	S	U	S	M	S	U	U	U	U	U	U	U	-	S	M	U	U	S	S	S	S	U	S
Sodium Hydroxide (<1 %)	U	-	M	S	S	S	-	-	S	M	S	S	-	S	M	M	S	S	S	S	S	S	M	S	S	-	U
Sodium Hydroxide (10 %)	U	-	M	U	-	-	U	-	M	M	S	S	U	S	U	U	S	S	S	S	S	S	M	S	S	-	U
Barium Salts	M	U	S	-	S	S	S	S	S	S	S	S	S	S	S	M	-	S	S	S	S	S	M	S	S	S	S
Benzene	S	S	U	U	S	U	M	U	S	U	U	S	U	U	U	M	U	M	U	U	U	U	U	U	S	U	S
Benzyl Alcohol	S	-	U	U	-	-	M	M	-	M	-	S	U	U	U	U	U	U	U	-	M	S	M	-	S	-	S

## A Chemical Compatibility Chart

CHEMICAL	MATERIAL																											
	ALUMINUM	ANODIC COATING for ALUMINUM	BUNA N	CELLULOSE ACETATE BUTYRATE	POLYURETHANE ROTOR PAINT	COMPOSITE Carbon Fiber/Epoxy	DELRIN	ETHYLENE PROPYLENE	GLASS	NEOPRENE	NORYL	NYLON	PET <sup>1</sup> , POLYCLEAR, CLEARCRIMP	POLYALLUMER	POLYCARBONATE	POLYESTER, GLASS THERMOSET	POLYETHERIMIDE	POLYRTHYLENE	POLYPROPYLENE	POLYSULFONE	POLYVINYL CHLORIDE	RULON A, TEFLON	SILICONE RUBBER	STAINLESS STEEL	TITANIUM	TYGON	VITON	
Boric Acid	U	S	S	M	S	S	U	S	S	S	S	S	S	S	S	S	U	S	S	S	S	S	S	S	S	S	S	
Cesium Acetate	M	-	S	-	S	S	S	-	S	S	S	S	-	S	S	-	-	S	S	S	S	S	S	S	M	S	S	S
Cesium Bromide	M	S	S	-	S	S	S	-	S	S	S	S	S	S	S	-	-	S	S	S	S	S	S	S	M	S	S	S
Cesium Chloride	M	S	S	U	S	S	S	-	S	S	S	S	S	S	S	-	-	S	S	S	S	S	S	S	M	S	S	S
Cesium Formate	M	S	S	-	S	S	S	-	S	S	S	S	S	S	S	-	-	S	S	S	S	S	S	S	M	S	S	S
Cesium Iodide	M	S	S	-	S	S	S	-	S	S	S	S	S	S	S	-	-	S	S	S	S	S	S	S	M	S	S	S
Cesium Sulfate	M	S	S	-	S	S	S	-	S	S	S	S	S	S	S	-	-	S	S	S	S	S	S	S	M	S	S	S
Chloroform	U	U	U	U	S	S	M	U	S	U	U	M	U	M	U	U	U	M	M	U	U	S	U	U	U	M	S	
Chromic Acid (10 %)	U	-	U	U	S	U	U	-	S	S	S	U	S	S	M	U	M	S	S	U	M	S	M	U	S	S	S	
Chromic Acid (50 %)	U	-	U	U	-	U	U	-	-	-	S	U	U	S	M	U	M	S	S	U	M	S	-	U	M	-	S	
Cresol Mixture	S	S	U	-	-	-	S	-	S	U	U	U	U	U	U	-	-	U	U	-	U	S	S	S	S	U	S	
Cyclohexane	S	S	S	-	S	S	S	U	S	U	S	S	U	U	U	M	S	M	U	M	M	S	U	M	M	U	S	
Deoxycholate	S	S	S	-	S	S	S	-	S	S	S	S	S	S	S	-	-	S	S	S	S	S	S	S	S	S	S	
Distilled Water	S	S	S	S	S	S	S	S	S	S	S	S	S	S	S	S	S	S	S	S	S	S	S	S	S	S	S	
Dextran	M	S	S	S	S	S	S	-	S	S	S	S	S	S	S	S	S	S	S	S	S	S	S	M	S	S	S	
Diethyl Ether	S	S	U	U	S	S	S	U	S	U	U	S	U	U	U	U	U	U	U	U	U	S	S	S	S	M	U	
Diethyl Ketone	S	-	U	U	-	-	M	-	S	U	-	S	-	M	U	U	U	M	M	-	U	S	-	-	S	U	U	
Diethylpyrocarbonate	S	S	U	-	S	S	S	-	S	S	U	S	U	S	U	-	-	S	S	S	M	S	S	S	S	S	S	
Dimethylsulfoxide	S	S	U	U	S	S	S	-	S	U	S	S	U	S	U	U	-	S	S	U	U	S	S	S	S	U	U	
Dioxane	M	S	U	U	S	S	M	M	S	U	U	S	U	M	U	U	-	M	M	M	U	S	S	S	S	U	U	
Ferric Chloride	U	U	S	-	-	-	M	S	-	M	-	S	-	S	-	-	-	S	S	-	-	-	M	U	S	-	S	
Acetic Acid (Glacial)	S	S	U	U	S	S	U	M	S	U	S	U	U	U	U	U	M	S	U	M	U	S	U	U	S	-	U	
Acetic Acid (5 %)	S	S	M	S	S	S	M	S	S	S	S	S	M	S	S	S	S	S	S	S	M	S	S	M	S	S	M	
Acetic Acid (60 %)	S	S	U	U	S	S	U	-	S	M	S	U	U	M	U	S	M	S	M	S	M	S	M	U	S	M	U	
Ethyl Acetate	M	M	U	U	S	S	M	M	S	S	U	S	U	M	U	U	-	S	S	U	U	S	M	M	S	U	U	
Ethyl Alcohol (50 %)	S	S	S	S	S	S	M	S	S	S	S	S	U	S	U	S	S	S	S	S	S	S	S	M	S	M	U	
Ethyl Alcohol (95%)	S	S	S	U	S	S	M	S	S	S	S	S	U	S	U	-	S	S	S	M	S	S	S	U	S	M	U	
Ethylene Dichloride	S	-	U	U	-	-	S	M	-	U	U	S	U	U	U	U	U	U	U	-	U	S	U	-	S	-	S	
Ethylene Glycol	S	S	S	S	S	S	S	S	S	S	S	S	-	S	U	S	S	S	S	S	S	S	S	M	S	M	S	
Ethylene Oxide Vapor	S	-	U	-	-	U	-	-	S	U	-	S	-	S	M	-	-	S	S	S	U	S	U	S	S	S	U	
Ficoll-Hypaque	M	S	S	-	S	S	S	-	S	S	S	S	-	S	S	-	S	S	S	S	S	S	S	M	S	S	S	

<b>CHEMICAL</b>	<b>MATERIAL</b>	ALUMINUM	ANODIC COATING for ALUMINUM	BUNA N	CELLULOSE ACETATE BUTYRATE	POLYURETHANE ROTOR PAINT	COMPOSITE Carbon Fiber/Epoxy	DELRIN	ETHYLENE PROPYLENE	GLASS	NEOPRENE	NORYL	NYLON	PET <sup>1</sup> , POLYCLEAR, CLEARCRIMP	POLYALLUMER	POLYCARBONATE	POLYESTER, GLASS THERMOSET	POLYETHERIMIDE	POLYRTHYLENE	POLYPROPYLENE	POLYSULFONE	POLYVINYL CHLORIDE	RULON A, TEFLON	SILICONE RUBBER	STAINLESS STEEL	TITANIUM	TYGON	VITON
Hydrofluoric Acid (10 %)	U	U	U	M	-	-	U	-	-	U	U	S	-	S	M	U	S	S	S	S	M	S	U	U	U	-	-	
Hydrofluoric Acid (50 %)	U	U	U	U	-	-	U	-	-	U	U	U	U	S	U	U	U	S	S	M	M	S	U	U	U	-	M	
Hydrofluoric Acid (conc.)	U	U	U	U	-	U	U	M	-	U	M	U	U	M	U	U	U	-	S	-	U	S	U	U	U	-	-	
Formaldehyde (40 %)	M	M	M	S	S	S	S	M	S	S	S	S	S	M	S	S	S	U	S	S	M	S	S	S	M	S	M	U
Glutaraldehyde	S	S	S	S	-	-	S	-	S	S	S	S	S	S	S	S	-	-	S	S	S	-	-	S	S	S	-	-
Glycerol	M	S	S	-	S	S	S	S	S	S	S	S	S	S	S	S	S	-	S	S	S	S	S	S	S	S	S	S
Guanidine Hydrochloride	U	U	S	-	S	S	S	-	S	S	S	S	S	S	S	S	-	-	S	S	S	S	S	S	U	S	S	S
Haemo-Sol	S	S	S	-	-	-	S	-	S	S	S	S	S	S	S	S	-	-	S	S	S	S	S	S	S	S	S	S
Hexane	S	S	S	-	S	S	S	-	S	S	U	S	U	M	U	S	S	U	S	S	S	M	S	U	S	S	U	S
Isobutyl Alcohol	-	-	M	U	-	-	S	S	-	U	-	S	U	S	S	M	S	S	S	-	S	S	S	-	S	-	S	S
Isopropyl Alcohol	M	M	M	U	S	S	S	S	S	U	S	S	U	S	U	M	S	S	S	S	S	S	S	S	M	M	M	S
Iodoacetic Acid	S	S	M	-	S	S	S	-	S	M	S	S	M	S	S	-	M	S	S	S	S	S	M	S	S	M	M	M
Potassium Bromide	U	S	S	-	S	S	S	-	S	S	S	S	S	S	S	S	S	S	S	S	-	S	S	S	M	S	S	S
Potassium Carbonate	M	U	S	S	S	S	S	-	S	S	S	S	S	S	U	S	S	S	S	S	S	S	S	S	S	S	S	S
Potassium Chloride	U	S	S	-	S	S	S	S	S	S	S	S	S	S	S	-	S	S	S	S	S	S	S	S	U	S	S	S
Potassium Hydroxide (5 %)	U	U	S	S	S	S	M	-	S	S	S	S	-	S	U	S	S	S	S	S	S	S	S	M	U	M	S	U
Potassium Hydroxide (conc.)	U	U	M	U	-	-	M	-	M	S	S	-	U	M	U	U	U	S	M	-	M	U	-	U	U	-	U	
Potassium Permanganate	S	S	S	-	S	S	S	-	S	S	S	U	S	S	S	M	-	S	M	S	U	S	S	M	S	U	S	
Calcium Chloride	M	U	S	S	S	S	S	S	S	S	S	S	S	S	M	S	-	S	S	S	S	S	S	M	S	S	S	S
Calcium Hypochlorite	M	-	U	-	S	M	M	S	-	M	-	S	-	S	M	S	-	S	S	S	M	S	M	U	S	-	S	S
Kerosene	S	S	S	-	S	S	S	U	S	M	U	S	U	M	M	S	-	M	M	M	S	S	U	S	S	U	S	S
Sodium Chloride (10 %)	S	-	S	S	S	S	S	S	-	-	-	S	S	S	S	S	-	S	S	S	S	-	S	S	M	-	S	S
Iodoacetic Acid	U	-	S	U	S	S	S	-	-	-	-	S	S	S	S	S	-	S	S	-	S	-	S	S	M	-	S	S
Carbon Tetrachloride	U	U	M	S	S	U	M	U	S	U	U	S	U	M	U	S	S	M	M	S	M	M	M	M	U	S	S	S
Aqua Regia	U	-	U	U	-	-	U	-	-	-	-	-	U	U	U	U	U	U	U	U	-	-	-	-	-	S	-	M
Solution 555 (20 %)	S	S	S	-	-	-	S	-	S	S	S	S	S	S	S	-	-	S	S	S	-	S	S	S	S	S	S	S
Magnesium Chloride	M	S	S	-	S	S	S	S	S	S	S	S	S	S	S	S	S	S	S	S	S	S	S	M	S	S	S	S
Mercaptoacetic Acid	U	S	U	-	S	M	S	-	S	M	S	U	U	U	U	-	S	U	U	S	M	S	U	S	S	S	S	S
Methyl Alcohol	S	S	S	U	S	S	M	S	S	S	S	S	U	S	U	M	S	S	S	S	S	S	S	M	S	M	U	U
Methylene Chloride	U	U	U	U	M	S	S	U	S	U	U	S	U	U	U	U	U	U	M	U	U	U	S	S	M	U	S	U
Methyl Ethyl Ketone	S	S	U	U	S	S	M	S	S	U	U	S	U	S	U	U	U	U	S	S	U	U	S	S	S	U	U	U

# A Chemical Compatibility Chart

CHEMICAL	MATERIAL																										
	ALUMINUM	ANODIC COATING for ALUMINUM	BUNA N	CELLULOSE ACETATE BUTYRATE	POLYURETHANE ROTOR PAINT	COMPOSITE Carbon Fiber/Epoxy	DELRIN	ETHYLENE PROPYLENE	GLASS	NEOPRENE	NORYL	NYLON	PET <sup>1</sup> , POLYCLEAR, CLEARCRIMP	POLYALLUMER	POLYCARBONATE	POLYESTER, GLASS THERMOSET	POLYETHERIMIDE	POLYETHYLENE	POLYPROPYLENE	POLYSULFONE	POLYVINYL CHLORIDE	RULON A, TEFLON	SILICONE RUBBER	STAINLESS STEEL	TITANIUM	TYGON	VITON
Metrizamide	M	S	S	-	S	S	S	-	S	S	S	S	-	S	S	-	-	S	S	S	S	S	S	M	S	S	S
Lactic Acid (100 %)	-	-	S	-	-	-	-	-	-	M	S	U	-	S	S	S	M	S	S	-	M	S	M	S	S	-	S
Lactic Acid (20 %)	-	-	S	S	-	-	-	-	-	M	S	M	-	S	S	S	S	S	S	S	M	S	M	S	S	-	S
N-Butyl Alcohol	S	-	S	U	-	-	S	-	-	S	M	-	U	S	M	S	S	S	S	M	M	S	M	-	S	-	S
N-Butyl Phthalate	S	S	U	-	S	S	S	-	S	U	U	S	U	U	U	M	-	U	U	S	U	S	M	M	S	U	S
N, N-Dimethylformamide	S	S	S	U	S	M	S	-	S	S	U	S	U	S	U	U	-	S	S	U	U	S	M	S	S	S	U
Sodium Borate	M	S	S	S	S	S	S	S	S	S	S	U	S	S	S	S	-	S	S	S	S	S	S	M	S	S	S
Sodium Bromide	U	S	S	-	S	S	S	-	S	S	S	S	S	S	S	S	-	S	S	S	S	S	S	M	S	S	S
Sodium Carbonate (2 %)	M	U	S	S	S	S	S	S	S	S	S	S	S	S	U	S	S	S	S	S	S	S	S	S	S	S	S
Sodium Dodecyl Sulfate	S	S	S	-	S	S	S	-	S	S	S	S	S	S	S	-	S	S	S	S	S	S	S	S	S	S	S
Sodium Hypochlorite (5 %)	U	U	M	S	S	M	U	S	S	M	S	S	S	M	S	S	S	S	M	S	S	S	M	U	S	M	S
Sodium Iodide	M	S	S	-	S	S	S	-	S	S	S	S	S	S	S	-	-	S	S	S	S	S	S	M	S	S	S
Sodium Nitrate	S	S	S	-	S	S	S	S	S	S	S	S	S	S	S	S	-	S	S	S	S	S	U	S	S	S	S
Sodium Sulfate	U	S	S	-	S	S	S	S	S	S	S	S	S	S	S	S	S	S	S	S	S	S	S	M	S	S	S
Sodium Sulfide	S	-	S	S	-	-	-	S	-	-	-	S	S	S	U	U	-	-	S	-	-	-	S	S	M	-	S
Sodium Sulfite	S	S	S	-	S	S	S	S	M	S	S	S	S	S	S	M	-	S	S	S	S	S	S	S	S	S	S
Nickel Salts	U	S	S	S	S	S	-	S	S	S	-	-	S	S	S	S	-	S	S	S	S	S	M	S	S	S	S
Oils (Petroleum)	S	S	S	-	-	-	S	U	S	S	S	S	U	U	M	S	M	U	U	S	S	S	U	S	S	S	S
Oils (Other)	S	-	S	-	-	-	S	M	S	S	S	S	U	S	S	S	S	U	S	S	S	S	-	S	S	M	S
Oleic Acid	S	-	U	S	S	S	U	U	S	U	S	S	M	S	S	S	S	S	S	S	S	S	M	U	S	M	M
Oxalic Acid	U	U	M	S	S	S	U	S	S	S	S	S	U	S	U	S	S	S	S	S	S	S	U	M	S	S	S
Perchloric Acid (10 %)	U	-	U	-	S	U	U	-	S	M	M	-	-	M	U	M	S	M	M	-	M	S	U	-	S	-	S
Perchloric Acid (70 %)	U	U	U	-	-	U	U	-	S	U	M	U	U	M	U	U	U	M	M	U	M	S	U	U	S	U	S
Phenol (5 %)	U	S	U	-	S	M	M	-	S	U	M	U	U	S	U	M	S	M	S	U	U	S	U	M	M	M	S
Phenol (50 %)	U	S	U	-	S	U	M	-	S	U	M	U	U	U	U	U	S	U	M	U	U	S	U	U	U	M	S
Phosphoric Acid (10 %)	U	U	M	S	S	S	U	S	S	S	S	U	-	S	S	S	S	S	S	S	S	S	U	M	U	S	S
Phosphoric Acid (conc.)	U	U	M	M	-	-	U	S	-	M	S	U	U	M	M	S	S	S	M	S	M	S	U	M	U	-	S
Physiologic Media (Serum, Urine)	M	S	S	S	-	-	S	-	S	S	S	S	S	S	S	S	S	S	S	S	S	S	S	S	S	S	S
Picric Acid	S	S	U	-	S	M	S	S	S	M	S	U	S	S	S	U	S	S	S	S	U	S	U	M	S	M	S
Pyridine (50 %)	U	S	U	U	S	U	U	-	U	S	S	U	U	M	U	U	-	U	S	M	U	S	S	U	U	U	U
Rubidium Bromide	M	S	S	-	S	S	S	-	S	S	S	S	S	S	S	-	-	S	S	S	S	S	S	M	S	S	S

CHEMICAL	MATERIAL																											
	ALUMINUM	ANODIC COATING for ALUMINUM	BUNA N	CELLULOSE ACETATE BUTYRATE	POLYURETHANE ROTOR PAINT	COMPOSITE Carbon Fiber/Epoxy	DELRIN	ETHYLENE PROPYLENE	GLASS	NEOPRENE	NORYL	NYLON	PET <sup>1</sup> , POLYCLEAR, CLEARCRIMP	POLYALLUMER	POLYCARBONATE	POLYESTER, GLASS THERMOSET	POLYETHERIMIDE	POLYRTHYLENE	POLYPROPYLENE	POLYSULFONE	POLYVINYL CHLORIDE	RULON A, TEFLON	SILICONE RUBBER	STAINLESS STEEL	TITANIUM	TYGON	VITON	
Rubidium Chloride	M	S	S	-	S	S	S	-	S	S	S	S	S	S	S	-	-	S	S	S	S	S	S	M	S	S	S	
Sucrose	M	S	S	-	S	S	S	S	S	S	S	S	S	S	S	S	S	S	S	S	S	S	S	S	S	S	S	
Sucrose, Alkaline	M	S	S	-	S	S	S	-	S	S	S	S	S	S	U	S	S	S	S	S	S	S	S	M	S	S	S	
Sulfosalicylic Acid	U	U	S	S	S	S	S	-	S	S	S	U	S	S	S	-	S	S	S	-	S	S	S	U	S	S	S	
Nitric Acid (10 %)	U	S	U	S	S	U	U	-	S	U	S	U	-	S	S	S	S	S	S	S	S	S	M	S	S	S	S	
Nitric Acid (50 %)	U	S	U	M	S	U	U	-	S	U	S	U	U	M	M	U	M	M	M	S	S	S	U	S	S	M	S	
Nitric Acid (95 %)	U	-	U	U	-	U	U	-	-	U	U	U	U	M	U	U	U	U	M	U	U	S	U	S	S	-	S	
Hydrochloric Acid (10 %)	U	U	M	S	S	S	U	-	S	S	S	U	U	S	U	S	S	S	S	S	S	S	S	U	M	S	S	
Hydrochloric Acid (50 %)	U	U	U	U	S	U	U	-	S	M	S	U	U	M	U	U	S	S	S	S	M	S	M	U	U	M	M	
Sulfuric Acid (10 %)	M	U	U	S	S	U	U	-	S	S	M	U	S	S	S	S	S	S	S	S	S	S	U	U	U	S	S	
Sulfuric Acid (50%)	M	U	U	U	S	U	U	-	S	S	M	U	U	S	U	U	M	S	S	S	S	S	U	U	U	M	S	
Sulfuric Acid (conc.)	M	U	U	U	-	U	U	M	-	-	M	U	U	S	U	U	U	M	S	U	M	S	U	U	U	-	S	
Stearic Acid	S	-	S	-	-	-	S	M	S	S	S	S	-	S	S	S	S	S	S	S	S	S	M	M	S	S	S	
Tetrahydrofuran	S	S	U	U	S	U	U	M	S	U	U	S	U	U	U	-	M	U	U	U	U	S	U	S	S	U	U	
Toluene	S	S	U	U	S	S	M	U	S	U	U	S	U	U	U	S	U	M	U	U	U	S	U	S	U	U	M	
Trichloroacetic Acid	U	U	U	-	S	S	U	M	S	U	S	U	U	S	M	-	M	S	S	U	U	S	U	U	U	M	U	
Trichloroethane	S	-	U	-	-	-	M	U	-	U	-	S	U	U	U	U	U	U	U	U	U	S	U	-	S	-	S	
Trichloroethylene	-	-	U	U	-	-	-	U	-	U	-	S	U	U	U	U	U	U	U	U	U	S	U	-	U	-	S	
Trisodium Phosphate	-	-	-	S	-	-	M	-	-	-	-	-	-	S	-	-	S	S	S	-	-	S	-	-	S	-	S	
Tris Buffer (neutral pH)	U	S	S	S	S	S	S	-	S	S	S	S	S	S	S	S	S	S	S	S	S	S	S	S	S	S	S	
Triton X-100	S	S	S	-	S	S	S	-	S	S	S	S	S	S	S	S	S	S	S	S	S	S	S	S	S	S	S	
Urea	S	-	U	S	S	S	S	-	-	-	-	S	S	S	M	S	S	S	S	-	S	S	S	M	S	-	S	
Hydrogen Peroxide (10 %)	U	U	M	S	S	U	U	-	S	S	S	U	S	S	S	M	U	S	S	S	S	S	S	M	S	U	S	
Hydrogen Peroxide (3 %)	S	M	S	S	S	-	S	-	S	S	S	S	S	S	S	S	M	S	S	S	S	S	S	S	S	S	S	
Xylene	S	S	U	S	S	S	M	U	S	U	U	U	U	U	U	M	U	M	U	U	U	S	U	M	S	U	S	
Zinc Chloride	U	U	S	S	S	S	U	S	S	S	S	S	S	S	S	S	S	S	S	S	S	S	S	U	S	S	S	
Zinc Sulfate	U	S	S	-	S	S	S	S	S	S	S	S	S	S	S	S	S	S	S	S	S	S	S	S	S	S	S	
Citric Acid (10 %)	M	S	S	M	S	S	M	S	S	S	S	S	S	S	S	S	M	S	S	S	S	S	S	S	S	S	S	

<sup>1</sup>Polyethyleneterephthalate

## A Chemical Compatibility Chart

### Key

- S Satisfactory
- M Moderate attack, may be satisfactory for use in centrifuge depending on length of exposure, speed involved, etc. Suggest testing under actual conditions of use.
- U Unsatisfactory, not recommended.
- Performance unknown; suggest testing, using sample to avoid loss of valuable material.

Chemical resistance data is included only as a guide to product use. No organized chemical resistance data exists for materials under the stress of centrifugation. When in doubt we recommend pretesting sample lots.



# Index

<b>A</b>	
Accident Prevention .....	iv
Aerosol-tight Rotors .....	4-9
Aligning .....	2-3
Audible Alarm .....	4-9
Autoclaving .....	5-5
<b>B</b>	
Before Use .....	2-1
<b>C</b>	
Care .....	5-1
Centrifugation .....	4-8
Characteristics .....	1-2
Chemical Compatibility Chart .....	A-1
Cleaning .....	5-2
Cleaning Intervals .....	5-2
Close Door .....	4-2
Contact Information .....	B-1
Control Panel .....	3-2
<b>D</b>	
Decontamination .....	5-5
Depositing .....	5-6
Description .....	1-1
Directives .....	1-4
Disinfection .....	5-4
<b>E</b>	
Emergency Door Release .....	6-2
<b>F</b>	
Features .....	1-5
Filter Unit .....	5-3
Functions .....	1-5
<b>G</b>	
Guidelines .....	1-4
<b>I</b>	
Intended Use .....	iv
Introduction .....	1-1
<b>K</b>	
Keys .....	3-2
<b>L</b>	
Location .....	2-2
<b>M</b>	
Mains Connection .....	2-3
Mains Supply .....	1-5
Maintenance .....	5-1
<b>O</b>	
Opening .....	4-2
Operation .....	4-1
<b>P</b>	
Parameters .....	4-4
Precautions .....	v
Preface .....	iii
<b>R</b>	
RCF-Value .....	4-5
Removing the Rotor .....	4-9
Rotor Selection .....	1-6
<b>S</b>	
Scope of Supply .....	iii
Service .....	5-6
Service Technician .....	6-5
Setting up .....	2-2
Shipping .....	5-6
Standards .....	1-4
Storage .....	2-4
Switch on .....	4-2

**Index:**

**T**

Technical Data ..... 1-3  
Transporting ..... 2-2  
Troubleshooting ..... 6-1, 6-3  
Turning off ..... 4-10





**Thermo Electron LED GmbH**  
Zweigniederlassung Osterode  
Am Kalkberg, 37520 Osterode am Harz  
Germany

[thermofisher.com/centrifuge](https://thermofisher.com/centrifuge)

© 2011-2020 Thermo Fisher Scientific Inc. All rights reserved.

All trademarks are the property of Thermo Fisher Scientific Inc. and its subsidiaries unless otherwise indicated.

Delrin, TEFLON, and Viton are registered trademarks of DuPont. Noryl is a registered trademark of SABIC. POLYCLEAR is a registered trademark of Hongye CO., Ltd. Hypaque is a registered trademark of Amersham Health As. RULON A and Tygon are registered trademarks of Saint-Gobain Performance Plastics. Alconox is a registered trademark of Alconox. Ficoll is a registered trademark of GE Healthcare. Haemo-Sol is a registered trademark of Haemo-Sol. Triton is a registered trademark of Union Carbide Corporation. Valox is a registered trademark of General Electric Co.

Specifications, terms and pricing are subject to change. Not all products are available in all countries. Please consult your local sales representative for details.

Shown pictures within the manual are examples and may differ considering the set parameters and language. Pictures of the user interface within the manual are showing the English version as example.

**Australia** +61 39757 4300

**Austria** +43 1 801 40 0

**Belgium** +32 9 272 54 82

**China** +800 810 5118, +400 650 5118

**France** +33 2 2803 2180

**Germany national toll free**

0800 1 536 376

**Germany international** +49 6184 90 6000

**India toll free** +1800 22 8374

**India** +91 22 6716 2200

**Italy** +39 02 95059 552

**Japan** +81 3 5826 1616

**Korea** +82 2 2023 0600

**Netherlands** +31 76 579 55 55

**New Zealand** +64 9 980 6700

**Nordic/Baltic/CIS countries**

+358 10 329 2200

**Russia** +7 812 703 42 15, +7 495 739 76 41

**Singapore** +82 2 3420 8700

**Spain/Portugal** +34 93 223 09 18

**Switzerland** +41 44 454 12 12

**UK/Ireland** +44 870 609 9203

**USA/Canada** +1 866 984 3766

**Other Asian Countries** +852 3107 7600

**Countries not listed** +49 6184 90 6000

en

