

FT-110 Series – TurboFlow® Economical Flow-Rate Sensors

- ▶ Low Cost Plus High Accuracy $\pm 3\%$ of Reading
- ▶ Measures Low Liquid Flow Rates of 0.13 to 9.2 GPM (0.5 to 35 LPM)
- ▶ Lightweight Plastic Design Enables Mounting in any Position
- ▶ O-ring Design for Manifold Mounting

Gems Hall Effect turbine flow rate sensor is ideal for OEM applications involving low flow liquid monitoring. The low cost coupled with 1/2% repeatability makes it an ideal candidate for replacing dispensing timer systems. Unlike existing timing systems, turbine technology is not influenced by changes in system pressure caused by aging filters. The sensor's standard power and output specifications make it easy to retrofit to existing controllers.

Specifications

Wetted Materials	
Body	Nylon 12
Turbine	Nylon 12 Composite
Bearings	PTFE/15% Graphite
Operating Pressure	200 PSIG (13.7 bar)
Burst Pressure	2500 PSIG (172 bar)
Operating Temperature	-4°F to 212°F (-20°C to 100°C)
Viscosity	32 to 81 SSU (.8 to 16 Centistokes)
Filter	<50 Microns
Input Power	5 to 24 VDC @ 8mA
Output (Hz)	NPN Sinking Open Collector @ 20mA Maximum Leakage Current 10 μ A (Pull-Up Resistor Required)
Accuracy	$\pm 3\%$ of Reading
Repeatability	0.5% of Full Scale
Electrical Connection	DIN 9.4mm Spacing* 24 AWG 3 ft. Cable
Inlet/Outlet Ports	3/8" NPT Male G3/8 Male O-Ring

* Mating DIN ordered separately.

Wiring

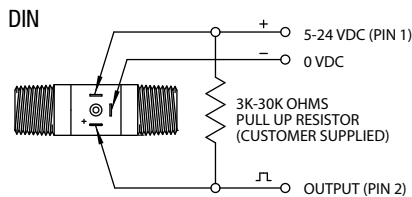

Cable

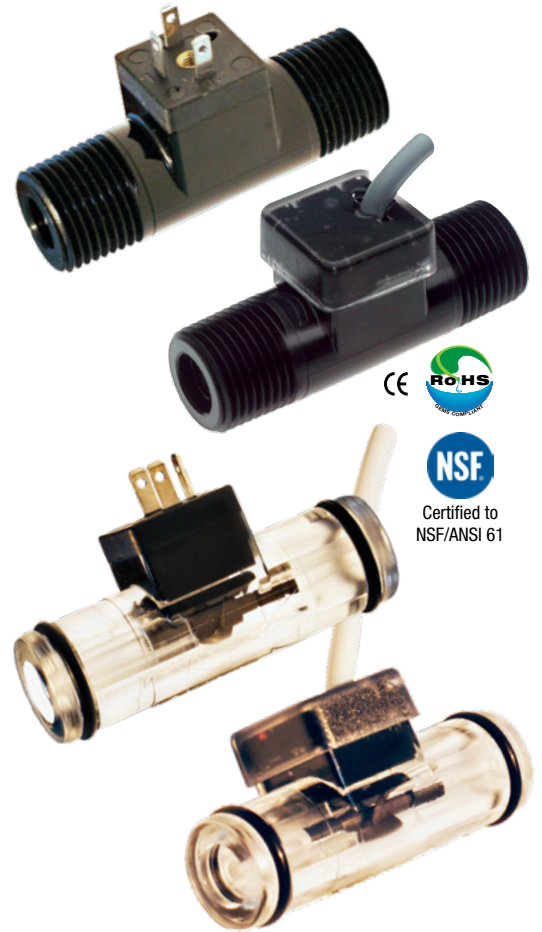
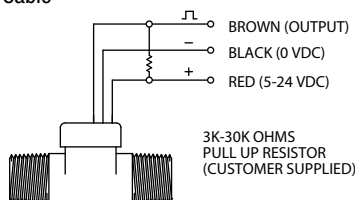

Pressure Drop—Typical

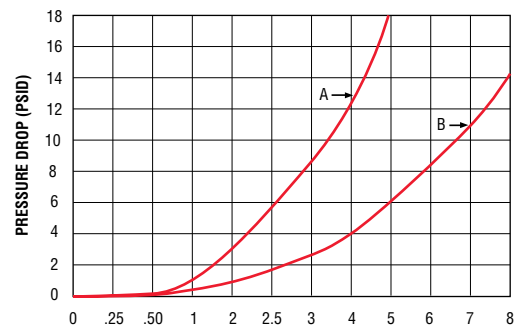

Tests conducted with water flow at 68°F (20°C).

Flow Range A	Flow Range B
.13 - 2.6 GPM	.26 - 9.2 GPM
.5 - 10 LPM	1 - 35 LPM

Dimensions

O-Ring DIN

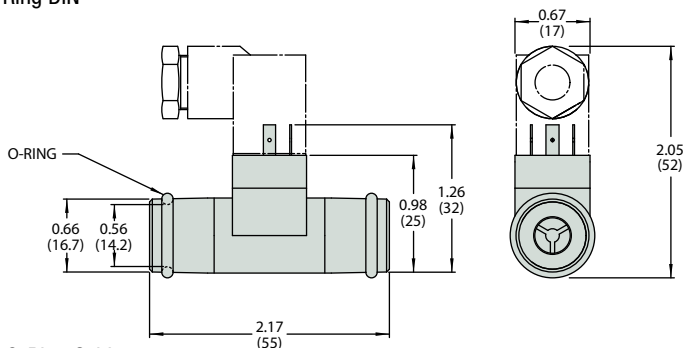

3/8" NPT and G3/8 DIN

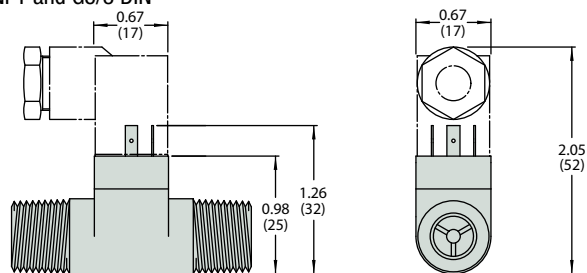

O-Ring Cable

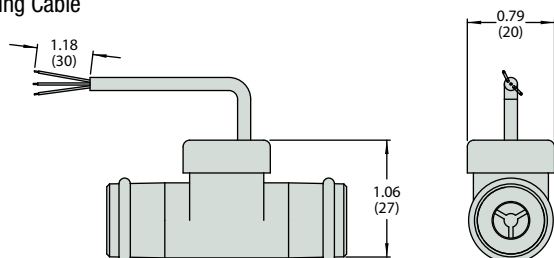

3/8" NPT and G3/8 Cable

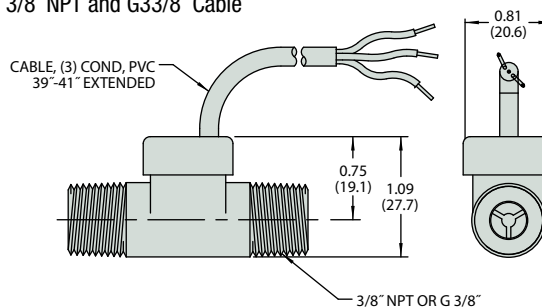

inch
(mm)

How To Order – Standard Models

Specify Part Number based on flow range.

Flow Range		Pulses per		Frequency Output	3/8" NPT Part Number		O-Ring Part Number		G3/8 European Thread P/N	
GPM	Liters/m	Gallon	Liter		Cable	DIN	Cable	DIN	Cable	DIN
.13-1.3	.5-5	26200	6900	58-575 Hz	173931-C	173931-D	244421-C	244421-D	173936-C	173936-D
.13-2	.5-7.5	17800	4700	39-588 Hz	173933-C	173933-D	244423-C	244423-D	173938-C	173938-D
.26-2.6	1-10	12500	3300	55-550 Hz	173932-C	173932-D	244422-C	244422-D	173937-C	173937-D
.26-4	1-15	8300	2200	37-550 Hz	173934-C	173934-D	244424-C	244424-D	173939-C	173939-D
.26-6.6	1-25	3800	1000	16.7-416 Hz	173935-C	173935-D	244425-C	244425-D	173940-C	173940-D
.53-9.2	2-35	2840	750	25-438 Hz	234265-C	234265-D	244426-C	244426-D	234266-C	234266-D

FT-110 Accessories

Consult factory for special customized OEM versions.

Description	Part Number
1 Meter DIN PVC Cable Assembly with 10K Pull-Up Resistor	218572
Mating DIN Connector	212404