

Druck DPI611

Portable Pressure Calibrator

User Manual – K0571



© 2014 General Electric Company. All Rights Reserved. Specifications are subject to change without notice. GE is a registered trademark of General Electric Company. Other company or product names mentioned in this document may be trademarks or registered trademarks of their respective companies, which are not affiliated with GE.

Revision History

This document supersedes all previously issued versions, providing new or revised information. The most recent publication can be determined by comparing the last three characters at the end of the part number and the date issued.

DPI 611 Portable Pressure Calibrator User Manual Part Number: K0571

Revision Level	Date Issued	General Description of Changes
Issue 1	13/08/14	Initial release

Contents

1 INTRODUCTION.....	7
1.1 EQUIPMENT IN THE BOX	7
1.2 OBSERVANCE OF THE USER MANUAL.....	7
1.3 GENERAL SAFETY PRECAUTIONS.....	7
1.4 GENERAL WARNINGS	8
1.5 ELECTRICAL WARNINGS.....	9
1.6 PRESSURE WARNINGS	10
1.7 OVERVOLTAGE CATEGORY	11
1.8 PREPARING THE INSTRUMENT	11
1.8.1 Initial Checks.....	11
1.8.2 Install the Battery.....	12
1.9 PARTS.....	13
1.9.1 Test Port.....	14
1.9.2 Pneumatic Pressure Release Valve.....	15
1.10 SELECTOR.....	15
1.10.1 Pump.....	16
1.10.2 Volume Adjuster	16
1.11 ACCESSORIES:.....	17
1.11.1 Carry Case (P/N IO611-CASE-1).....	17
1.11.2 Rechargeable Battery pack (P/N IO611-BATTERY)	17
1.11.3 Mains Adaptor (P/N IO620-PSU).....	17
1.11.4 USB Cable (P/N IO620-USB-PC).....	17
1.11.5 IDOS to USB Converter (P/N IO620-IDOS-USB)	17

1.11.6	USB to RS 232 Cable (P/N IO620-USB-RS232)	17
1.11.7	Dirt Moisture Trap (P/N IO620-IDT621)	18
1.11.8	Pneumatic Hose	18
1.11.9	Pressure Adaptor set	19
1.11.10	Comparator Adaptor (P/N IO620-COMP)	19
1.12	DRUCK DPI611, MODES	20
1.12.1	Power ON	20
1.12.2	Power OFF	20
1.12.3	Power up from Standby Mode	21
1.13	NAVIGATION	21
1.13.1	Set Date, Time and Language	22
1.13.2	Themes	22
1.13.3	DRUCK DPI611 Manual	22
1.14	SOFTWARE AND FIRMWARE UPGRADES	22
1.14.1	Viewing Software Revision	22
1.14.2	Upgrading the Software	23
1.14.3	Upgrade the Application Software	23
1.14.4	Upgrade the Operating System and Boot Loader Software	23
1.15	MAINTENANCE	24
1.15.1	Cleaning	25
1.15.2	Replace the Batteries	25
1.16	INSTRUMENT RETURN	25
1.16.1	Returned Material Procedure	25
1.16.2	Safety Precautions	25
1.16.3	Important Notice	26
1.16.4	Instrument Disposal in the European Union	26

1.16.5	For more information contact.....	26
1.17	ENVIRONMENT.....	26
1.18	MARKS AND SYMBOLS.....	27
2	OPERATIONS.....	28
2.1	PNEUMATIC PRESSURE OPERATIONS.....	28
2.1.1	Introduction.....	28
2.1.2	Release the Pressure.....	28
2.1.3	Attach/Remove the device under test.....	28
2.1.4	Vacuum or Pressure Operation.....	30
2.2	CALIBRATOR OPERATIONS.....	31
2.2.1	Basic Calibrator Operation.....	31
2.2.2	Set the Function Utility Options.....	38
2.2.3	Measurement Display Options.....	42
2.2.4	Example Procedures.....	43
2.3	PRESSURE CALIBRATION.....	48
2.3.1	Set up a Leak Test.....	49
2.3.2	Set the Pressure Module to Zero.....	51
2.3.3	Error Indications.....	51
2.4	MEASURE PRESSURE: IDOS Option.....	52
2.4.1	IDOS Option Assembly Instructions.....	52
2.4.2	IDOS Function Procedures.....	53
3	DATA LOGGING OPERATION.....	54
3.1	SET-UP.....	55
3.2	OPERATION.....	57
3.3	FILE REVIEW.....	57
3.4	FILE MANAGEMENT.....	58

3.4.1	Transfer	58
3.4.2	Erase	59
3.4.3	Memory Status.....	59
3.5	DATA FORMAT	59
4	DOCUMENTATION.....	61
4.1	ANALYSIS	61
4.2	SET-UP.....	62
4.2.1	Define the Reference Channel	62
4.2.2	Define each Input Channel.....	63
4.3	ANALYSIS FUNCTION.....	64
4.4	RUN PROCEDURE.....	65
4.4.1	Sequence to Upload and Download file	66
5	CALIBRATION.....	67
5.1	GENERAL.....	67
5.2	CALIBRATION CHECK	67
5.3	CALIBRATION ADJUSTMENTS.....	68
5.4	BEFORE STARTING	68
5.5	PROCEDURES: CURRENT (measure).....	70
5.6	PROCEDURES: CURRENT (source).....	71
5.7	PROCEDURES: DC mV/Volts (measure).....	72
5.8	PROCEDURES: DC Volts (source).....	74
5.9	PROCEDURES: PRESSURE INDICATOR.....	75
5.10	PROCEDURES: IDOS UPM	76
6	GENERAL SPECIFICATION	77
7	MANUFACTURER.....	79

1 INTRODUCTION

The Druck DPI611 is a battery-powered instrument for performing pressure and electrical calibration operations. The Druck DPI611 also supplies the power and user interface functions for all optional items.

1.1 EQUIPMENT IN THE BOX

The following items are supplied with the Druck DPI611:

- Standard AA size batteries
- 1/8" NPT & BSP pressure adaptors
- Set of four test leads
- Safety and Quick Start Guide
- Stylus

1.2 OBSERVANCE OF THE USER MANUAL

This manual contains safety and battery installation information for the Druck DPI611. It is the responsibility of the customer, to make sure that all personnel operating and maintaining the equipment are correctly trained and qualified. Before operating or using the equipment read and obey all sections, including all WARNINGS and CAUTIONS given in the Quick Start Guide.

1.3 GENERAL SAFETY PRECAUTIONS

Read and obey all the operator's local health and safety regulations and safe working procedures or practices. When doing a procedure or task.

- Use only the approved tools, consumable materials and spares to operate and maintain the equipment.
- Read and obey all applicable **WARNING** signs.

- Make sure that:
 - a) All work areas are clean and clear of unwanted tools, equipment and materials.
 - b) All unwanted consumable materials are discarded in accordance with local health and safety and environmental regulations.

1.4 GENERAL WARNINGS



- It is dangerous to ignore the specified limits for the instrument or its related accessories. This can cause injuries.
- If the equipment is used in a manner not specified by the manufacturer, the protection provided by the equipment may be impaired.
- Do not use the instrument in locations with explosive gas, vapor or dust. There is a risk of an explosion.
- Make sure all equipment is serviceable.
- Use equipment only for the purpose for which it is provided.
- Wear all applicable Personal Protective Equipment (PPE).
- Do not use sharp objects on the touch-screen.

1.5 ELECTRICAL WARNINGS



- The DC input to the DPI611 is rated at 5V (+/-5%) 4 Amps.
- External circuits should have appropriate insulation to the mains.
- To prevent electrical shocks or damage to the instrument, do not connect more than 30V CAT I between the terminals or between the terminals and the ground (earth).
- This instrument uses standard AA size batteries. To prevent an explosion or fire do not short circuit.
- The power supply input range to the optional power supply unit is 100 – 260Vac, 50 to 60Hz, 250mA, installation category CAT II.
- When using the optional power supply unit as position the power supply so as not to obstruct the supply disconnecting device.
- Note that the operating and storage temperature range of the optional PSU does not match that of the DPI611. Mains PSU operating temperature range 0°C to +40°C, storage temperature range -40°C to +70°C.
- To make sure the display shows the correct data, disconnect the test leads before power is set to **ON** or changing to another measure or source function.
- Keep the leads free from all contaminants.

1.6 PRESSURE WARNINGS



- Some liquid and gas mixtures are dangerous. This includes mixtures that occur because of contamination. Make sure that the equipment is safe to use with the necessary media.
- It is dangerous to attach an external source of pressure to a DPI611 pressure station. Use only the internal mechanisms to set and control pressure in the pressure station.
- To prevent a dangerous release of pressure, isolate and bleed the system before disconnecting a pressure connection.
- To prevent a dangerous release of pressure, make sure that all the related pipes, hoses and equipment have the correct pressure rating, are safe to use and are correctly attached.
- To prevent damage to the DPI611 calibrator, only use it within the specified pressure limits.
- Do not exceed the maximum pressures stated in the appropriate component manual for the unit under test.
- Reduce pressure at a controlled rate when venting to atmosphere.
- Carefully de-pressurize all pipes to atmospheric pressure before disconnecting and connecting to the unit under test.
- Observe absolute cleanliness when using the instrument.
- Severe damage can be caused if equipment connected to this instrument is contaminated.

- Connect only clean equipment to the instrument. To avoid any contamination, an external Dirt Moisture Trap (See Section 1.11.7) is recommended.
- Always wear appropriate eye protection when working with pressure.

1.7 OVERVOLTAGE CATEGORY

The following summary of installation and measurement overvoltage categories are derived from IEC61010-1. The overvoltage categories indicate the severity of overvoltage transients.

Table 1-1

Overvoltage Category	Description
CAT I	<i>Overvoltage category I has the least severe overvoltage transients. Generally CAT I equipment is not designed to be directly connected to the mains supply. Examples of CAT I equipment are process loop powered devices.</i>
CAT II	<i>Overvoltage category II describes an electrical installation where typically single phase equipment is connected. Examples of such equipment are appliances and portable tools.</i>

1.8 PREPARING THE INSTRUMENT

On receipt of the instrument check the contents in the box, listed in accessories *See Section 1.11*. It is recommended to retain the box and packaging for future use.

1.8.1 Initial Checks

Before you use the instrument for the first time:

- Make sure that there is no damage to the instrument, and that there are no missing items; *See Section 1.11*.

- Remove the plastic film that protects the display.

1.8.2 Install the Battery

- Remove the battery cover by loosening the captive battery cover fixing screw and lifting the cover upwards.
- Place the batteries in the battery compartment with the correct **+/-** position.
- Replace the battery cover by pressing the lugs inside the slots (A) and bring down the cover, securing by tightening the fixing screw. (See *Figure 1-1*).

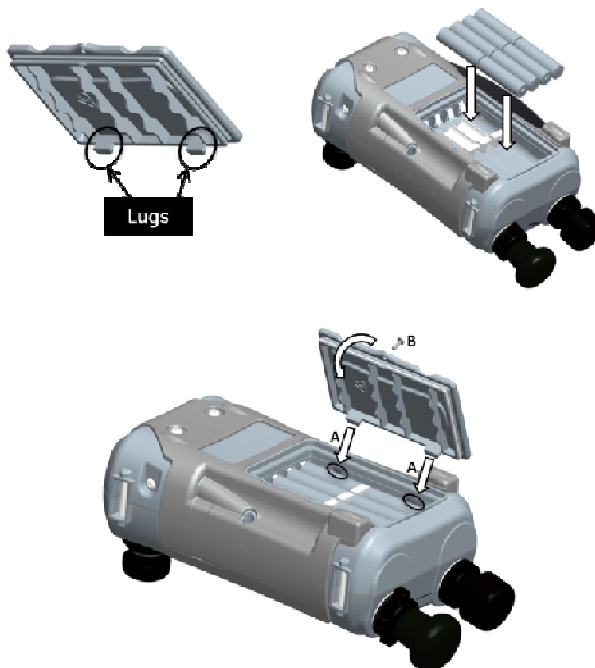
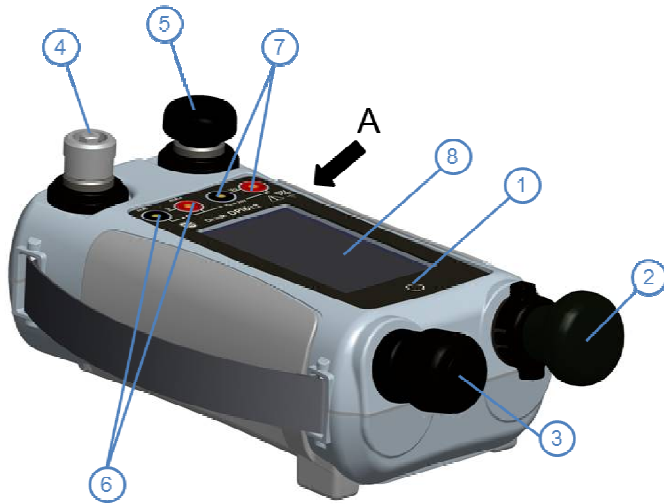

Figure 1-1 Battery Cover Insert

1.9 PARTS



VIEW A

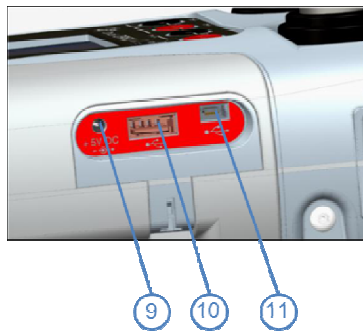

Figure 1-2 DPI611 Pressure Calibrator

Table 1-2

1	ON or OFF button.
2	Pump mechanism and pressure/vacuum selector.
3	Pneumatic volume adjuster.
4	Test port: To attach the device under test.
5	Pneumatic pressure release valve to release pressure in the system.
6	Electrical connectors for: Voltage Measure (V); Current (mA+, mA-); Switch Operation.
7	Isolated electrical connectors for: Voltage Source (10 Vo); 24 V loop power supply (24 Vo).
8	Liquid Crystal Display (LCD): Color display with touch-screen. To make a selection, lightly tap on the applicable display area.
9	+5 V DC power input socket.
10	USB type A connector for connections to external peripherals (USB flash memory or optional external modules).
11	USB mini-type B connector for communication with a computer.

1.9.1 Test Port

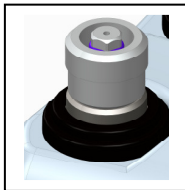

Figure 1-3
Test port

To attach the device under test, the test port uses “Quick fit” pressure adaptors; See *Section 1.11*. These are easy to remove, change and install; See *Section 2.1.3* (Attach/Remove the device under test).

1.9.2 Pneumatic Pressure Release Valve



Figure 1-4
Pressure Release
Valve

This is a needle point valve that lets you release the pressure or vacuum, or seal the system.



1.10 SELECTOR



Before you turn the pressure/vacuum selector to + or -, release all the pressure. Sudden high pressure in the pump mechanism can cause damage.



Figure 1-5
Selector

This control sets the operation of the instrument (pressure or vacuum). To prevent a pressure leak, turn it fully clockwise or counterclockwise.

+ : Pressure, - : Vacuum

1.10.1 Pump

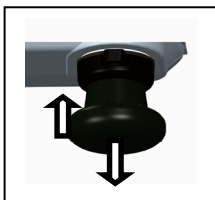

Figure 1-6
Pump

When you have set the operation to pressure or vacuum (See Section 1.10), seal the system (See Section 1.9.2) and use the pump to set the necessary pressure or vacuum.

You can then make the last adjustments with the volume adjuster (See Section 1.10.2).

1.10.2 Volume Adjuster

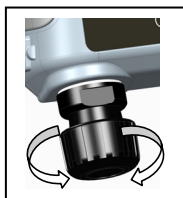

Figure 1-7
Volume Adjuster

This control increases or decreases the pressure/vacuum.

Before you seal the system (See Section 1.9.2), turn this control to the necessary position:

- For equal adjustment, turn it to the middle of its range.
- For maximum adjustment, turn it fully clockwise or counterclockwise.

When you have set the necessary pressure or vacuum with the pump (See Section 1.10.1), use the volume adjuster to make the fine adjustments.

1.11 ACCESSORIES:

1.11.1 Carry Case (P/N IO611-CASE-1)

A tailored fabric carry case with carrying strap allows the DPI611 to be used without removing it from the case.

1.11.2 Rechargeable Battery pack (P/N IO611-BATTERY)

Use in place of AA cells. The battery pack is charged within the instrument.

1.11.3 Mains Adaptor (P/N IO620-PSU)



A universal input mains adaptor (Input voltage 100 to 240VAC (50/60Hz) and Mains socket adaptors are provided.

1.11.4 USB Cable (P/N IO620-USB-PC)

It connects the DPI611 to a PC.

1.11.5 IDOS to USB Converter (P/N IO620-IDOS-USB)



It allows connection of an IDOS universal pressure module to the DPI611. USB Cable (P/N IO620-USB-PC) is also required to connect the converter to the DPI611 USB port.

1.11.6 USB to RS 232 Cable (P/N IO620-USB-RS232)

It connects the DPI611 to an RS232 interface.

1.11.7 Dirt Moisture Trap (P/N IO620-IDT621)



It prevents contamination of the DPI611 pneumatic system and cross contamination from one device under test to another. The trap connects directly to the pressure port and replicates the DPI611 quick fit connection for compatibility with standard adaptors, adaptor kits and hoses.

1.11.8 Pneumatic Hose



A high pressure pneumatic hose rated to 400 bar (5800 psi). The hose connects directly to the DPI611 pressure port and replicates the quick fit connection for compatibility with the standard adaptors supplied and the other adaptor kits.

P/N IO620-HOSE-P1: 1m/3,2ft pneumatic adaptor hose

P/N IO620-HOSE-P2: 2m/6.4ft pneumatic adaptor hose

1.11.9 Pressure Adaptor set



A set of test point adaptors to connect the tool-less quick fit DPI611 pressure port or the extension hoses to the device under test.

P/N IO620-BSP: G1/8 male and G1/4 male, G1/4 female, G3/8 female and G1/2 female.

P/N IO620-NPT: 1/8" male and 1/4" male, 1/4" female, 3/8" female and 1/2" female.

P/N IO620-MET: 14mm female and 20mm female.

1.11.10 Comparator Adaptor (P/N IO620-COMP)



For greater efficiency, two test devices can be connected at the same time. The adaptor connects to the pressure port of the DPI611 and provides two outlet ports. It is compatible with the standard adaptors supplied and the adaptor kits.

1.12 DRUCK DPI611, MODES

1.12.1 Power ON

From **OFF** – momentarily press the power button until the GE Logo appears.

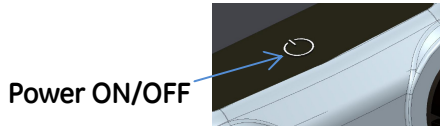

Figure 1-8 Power Button

1.12.2 Power OFF

Press and Release the Power Button:

Select SWITCH OFF from the POWERDOWN OPTIONS window displayed.

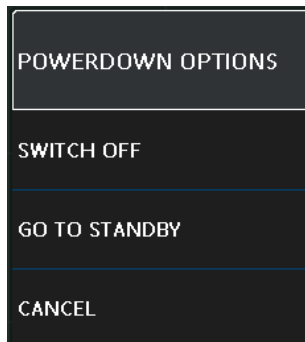

Figure 1-9 Power Down Options

SWITCH OFF – Full power down of DPI611 – Recommended if unit is not going to be used for several hours (Requires full reboot on next power up).

GO TO STANDBY– DPI611 placed in standby mode – Reduced power consumption from operating mode – recommended if unit is to be inactive for short periods. (DPI611 has fast turn on from STANDBY mode).

CANCEL – Touch CANCEL option if you do not want to Switch Off or Standby the instrument.

1.12.3 Power up from Standby Mode

When powered-up from standby mode the instrument always opens the last screen shown before going into standby mode.

1.13 NAVIGATION

On power up the DPI611 displays the Dashboard. The user should select the desired option by touching the appropriate icon. Function screens are navigated by swiping a finger from right to left while touching the screen. List menus are navigated by swiping a finger up and down while touching the screen.

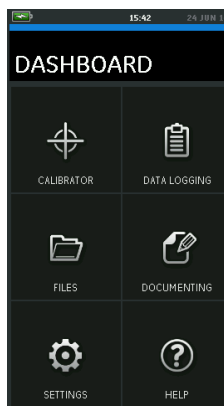

Figure 1-10 Dash Board

1.13.1 Set Date, Time and Language

To access Date, Time and Language menus
Select:

DASHBOARD >>  SETTINGS >> DATE

Note: *The DPI611 will maintain the date and time for 30 days after being left without batteries. In case of loss of date and time, replace the batteries, connect the mains adaptor to the DPI611 and keep it turned on for 50 hours to fully recharge the clock battery.*

1.13.2 Themes

Two themes are available: Dark and Light; select the correct theme for the light level.
Select:

DASHBOARD >>  SETTINGS >> THEME

1.13.3 DRUCK DPI611 Manual

Select the Help icon on the Dashboard to access the manual. The manual can be downloaded onto a memory stick for viewing or printing on a remote PC.

DASHBOARD >>  HELP

1.14 SOFTWARE AND FIRMWARE UPGRADES

1.14.1 Viewing Software Revision

The software revisions running on the DPI611 can be viewed by selecting:

DASHBOARD >>  SETTINGS >> STATUS
>> SOFTWARE BUILD

Note: If the software revision number is highlighted red then an upgrade is available.

1.14.2 Upgrading the Software

Follow the website instructions to download the files onto a USB flash memory drive.

www.ge-mcs.com

DASHBOARD >>  SETTINGS
>> ADVANCED

Enter the calibration PIN: 5487; Select the ✓ button and continue upgrade with one of these operations.

1.14.3 Upgrade the Application Software

1. Copy the 'AMC' application folder into the root of a USB flash memory device.
2. Put the USB flash memory drive into the USB type A connector.
3. Select: **APPLICATION**
4. Follow the on-screen instructions.

1.14.4 Upgrade the Operating System and Boot Loader Software.

1. Copy the 'OS' folder into the root of a USB flash memory device.
2. Put the USB flash memory drive in the USB type A connector.
3. Select: **OPERATING SYSTEM**

4. Follow the on-screen instructions.

Note: *The boot loader can only be upgraded as part of an operating system upgrade.*

Notes:

- *If a mistake is made during upgrade and there are no files to upload, follow the on-screen instructions and complete the procedure.*
- *When an upgrade completes normally, the initial operation of the touch screen may be slower (a period of approximately 30 seconds).*
- *To make sure the upgrade completed correctly, use the Status menu.*

1.15 MAINTENANCE

The DPI611 instrument contains no user serviceable parts and should be returned to a GE service center or an approved service agent for all repairs.

Do not dispose of this product as household waste. Use an approved organization that collects and/or recycles waste electrical and electronic equipment.

For more information, contact our customer service department at www.ge-mcs.com

1.15.1 Cleaning



**Do not use solvents or abrasive materials.
Clean the case and display with a lint-free cloth
and a weak detergent solution.**

1.15.2 Replace the Batteries

To replace the batteries, See *Section 1.8.2*. Then re-attach the cover.

All the configuration options stay in memory.

1.16 INSTRUMENT RETURN

1.16.1 Returned Material Procedure

If the instrument is unserviceable and requires a repair return to a GE Service Center or approved Service Agents.

Web site: www.ge-mcs.com

Contact the GE Service Center, either by phone, fax or E-mail to obtain a Returned Material Authorization (RMA) number, providing the following information:

- Product (i.e. Druck DPI611)
- Serial number
- Details of defect/work to be undertaken
- Operating conditions

1.16.2 Safety Precautions

Provide information if the product has been in contact with any hazardous or toxic substances and, the relevant MSDS

and or COSHH references and precautions to be taken when handling.

1.16.3 Important Notice

Do not use unauthorized sources to service this equipment as this will affect the warranty and may not guarantee further performance.

When discarding used equipment and batteries, obey all the local health and safety procedures.

1.16.4 Instrument Disposal in the European Union

Do not dispose of this product or its battery as household waste.



Use an approved organization that collects and/or recycles the applicable item.

1.16.5 For more information contact

GE Sensing customer service department:

www.ge-mcs.com





1.17 ENVIRONMENT

The following conditions apply for both shipping and storage:

Temperature Range -20°C to +70°C (-40°F to +158°F)

altitude up to 15,000 feet (4,570 meters).

1.18 MARKS AND SYMBOLS

	Complies with European Union directives
	USB ports: Type A; Mini Type B connector
	Ground (Earth)
	DC adaptor polarity: the Centre of the plug is negative

2 OPERATIONS

2.1 PNEUMATIC PRESSURE OPERATIONS

2.1.1 Introduction

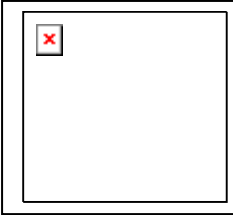

Figure 2-1
DPI611 Pressure
Calibrator

This section gives examples of how to connect and use the DPI611 pressure calibrator for the necessary pressure or vacuum operations.

Before you start:

- Read and understand the “Safety” section.
- Make sure that there is no damage to the instrument and there are no missing items.

Note: Use only original parts supplied by the manufacturer.

2.1.2 Release the Pressure



Figure 2-2
Pressure Release Valve

To release all the pressure in this instrument, open the pressure release valve counterclockwise (1 turn).

To control a change in pressure conditions (for example, to go to or through another test pressure) use the volume adjuster (See Section 1.10.2) or open and close the pressure release valve.

2.1.3 Attach/Remove the device under test



Pressurized gases are dangerous. Before you attach or disconnect pressure equipment, safely release all the pressure.

CAUTION

To prevent damage to the instrument, do not let dirt get into the pressure mechanism. Before you attach equipment, make sure it is clean.



Figure 2-3
Pressure Port

The test port uses “Quick fit” pressure adaptors; See Section 1.11 (Accessories). These are easy to remove, change and install (See Figure 2-4).

a. Procedure (to Attach)

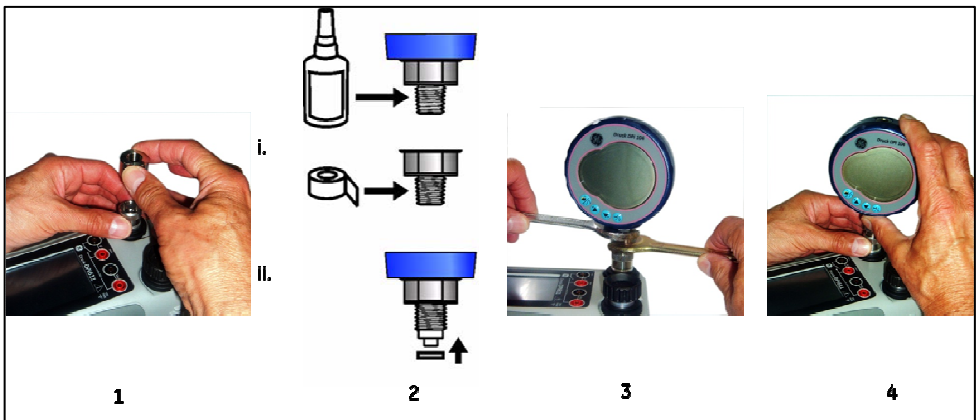

Figure 2-4 Attach / Remove Pressure connections

Table 2-1

Step	Procedure
1	Remove the adaptor
2	Use an applicable seal for the pressure connection: i. NPT type: Use an applicable sealant on the thread. ii. BSP (parallel) type: We recommend a bonded seal at the bottom.
3	Attach the adaptor to the device; if necessary use one of the alternative adaptors listed in <i>Section 1.11</i> (Accessories), then tighten to the applicable torque.
4	Re-attach the adaptor to the test port and tighten it until it is hand tight only.

b. Procedure (to Remove)

To remove a device, first release the pressure (See *Section 2.1.2*). You can then do steps 4, 3, and 1 mentioned in *Section 2.1.3* but do the operations in the reverse order.

2.1.4 Vacuum or Pressure Operation

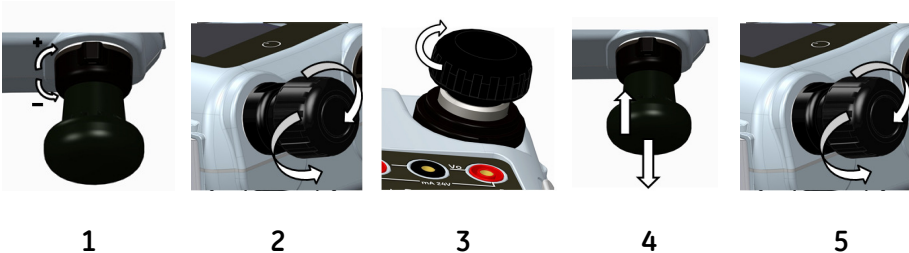

Figure 2-5 Vacuum or Pressure operation

Table 2-2

Step	Procedure (Vacuum)
1	Set to vacuum operation (-).
2	To do equal adjustments (up or down) at the end of the procedure, turn the volume adjuster to the middle of its range of operation.
3	Seal the system.
4	Use the pump to set the maximum vacuum or set the vacuum you want to adjust.
5	Adjust the vacuum (+ decrease; - increase).

Table 2-3

Step	Procedure (Pressure)
1	Set to Pressure operation (+).
2	To do equal adjustments (up or down) at the end of the procedure, turn the volume adjuster to the middle of its range of operation.
3	Seal the system.
4	Use the pump to set the maximum pressure or set the pressure you want to adjust.
5	Adjust the pressure (+ decrease; - increase).

2.2 CALIBRATOR OPERATIONS

2.2.1 Basic Calibrator Operation

1. Select:

DASHBOARD >>  CALIBRATOR

2. Select the channel by performing the following tasks.
 - Swipe to the TASK MENU by swiping the display from right to left.

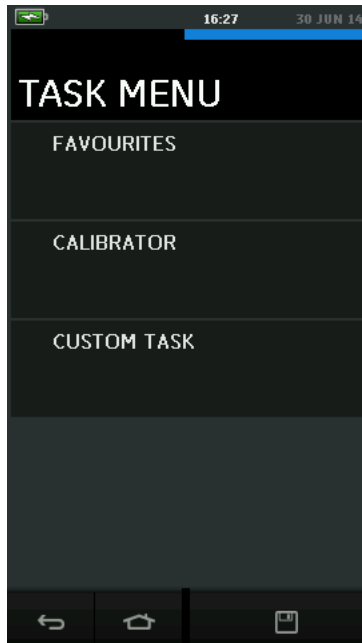

Figure 2-6 Task Menu

a) Saving Tasks

At any point within the TASK MENU the currently active tasks can be saved to FAVOURITES by selecting

Save  Task.

Note: *Saved Function is what is currently active in the calibrator window. It is NOT a selected Task – refer to COPY TASK to copy selected Task to the favourites*

b) Calibrator

- I. Select CALIBRATOR from the TASK MENU.
This will allow the user to select from commonly used combinations of functions.



Figure 2-7 Calibrator

- II. Select the required function by touching either the appropriate text or diagram. The DPI611 will set the functions and return to the main Calibrator screen.



Figure 2-8 Calibrator with selected option

- III. Functions can be copied to FAVOURITES by selecting as shown in *Figure 2-8* and selecting

Copy Task .

If the required task is not available as a Default, a new task should be created using CUSTOM TASK.

c) Favourites

- I. Selecting FAVOURITES from the TASK MENU allows selection of all SAVED and COPIED tasks.



Figure 2-9 Favourites

- II. Select the required function by touching either the appropriate text or diagram. The DPI611 will set the functions and return to the main calibrator screen.

- III. Task can be deleted by selecting DELETE .

d) Custom Task

- I. Select the CUSTOM TASK option from **TASK MENU**.

This will allow the user to set up the Electrical, Pressure and USB (IDOS) channels.

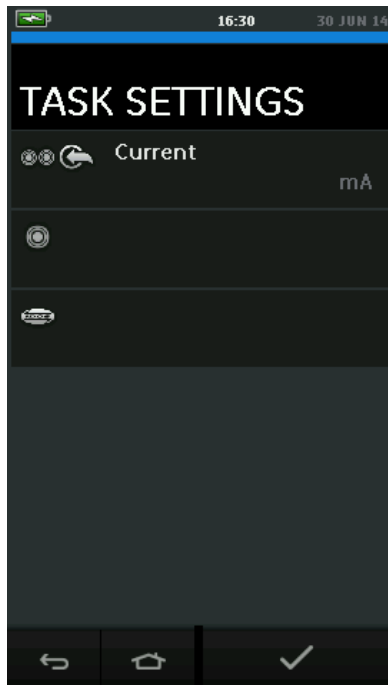

Figure 2-10 Task Settings Menu

- II. Select to enter the CHANNEL SETTINGS menu.
 - is used for pressure measurements. (See Section 2.3)
 - IDOS is used for external IDOS sensors. (See Section 2.4)

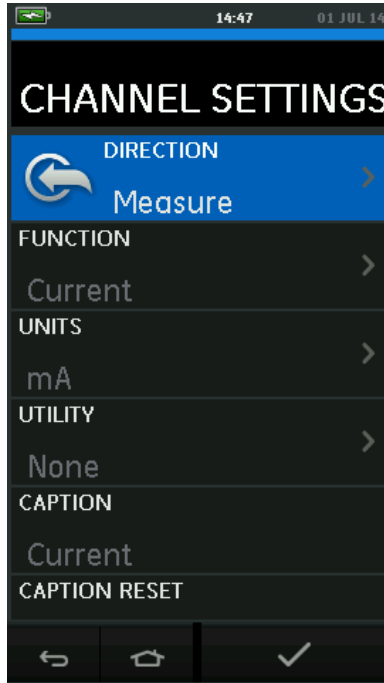





Figure 2-11 Channel Settings Menu

- III. Setup a channel for measurement
- DIRECTION selects  Source or  measure for the selected function.
 - FUNCTION selects the function required (E.g.: Current or Voltage). For more options, scroll down the menu by swiping the display from bottom to top.
 - UNITS selects the type of unit required, (E.g: Volts, Amps), please note that there may only be 1 type of unit available in particular Functions.

- UTILITY selects the required utility (See Section 2.2.2 for details).
- CAPTION allows the user to change the caption, if required.
- CAPTION RESET allows the user to reset the caption.
- Once all settings have been selected, press the ✓ button at the bottom of the screen to return to the TASK SETTINGS screen.
- Please note for the settings to be set the user must also press the ✓ button in the TASK SETTINGS menu.
- Repeat the above if another channel is required.

2.2.2 Set the Function Utility Options

For each function only one utility may be active. Not all source and measure functions have associated utilities. For all options, the  button resets the additional readings.

a. Max/Min. Avg

This utility is only available with measure functions.

The additional values displayed show the minimum, maximum, and average values of the input signal.



Figure 2-12 Max/Min Example

b. Switch Test

This utility is available with pressure functions.

The additional values displayed show signal values (measure or source) when the instrument detects a switch opening and closing. The difference between the two values is displayed as hysteresis value for the switch. This utility can be used with Ramp Automation, where the rising signal causes the switch to change state and the falling signal causes the switch to resume its' original state.

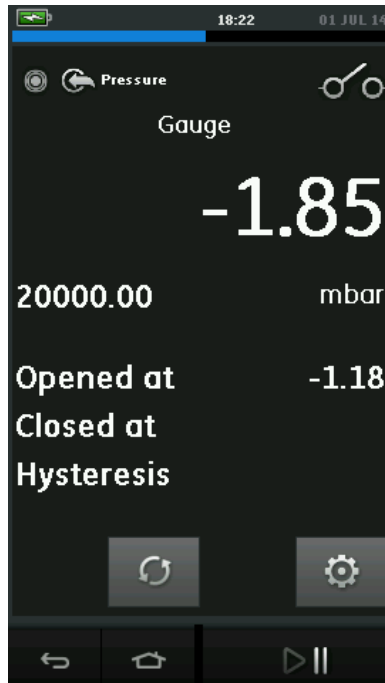

Figure 2-13 Switch Test Example

c. Relief Valve

This utility is only available with measure functions.

This utility tests circuits or mechanisms that have a cut-out response when an input reaches a defined threshold value. The utility allows the user to select a mode of operation which can be rising or falling. The utility displays additional values that represent the maximum and minimum values achieved by the input signal.



Figure 2-14 Relief Valve Example

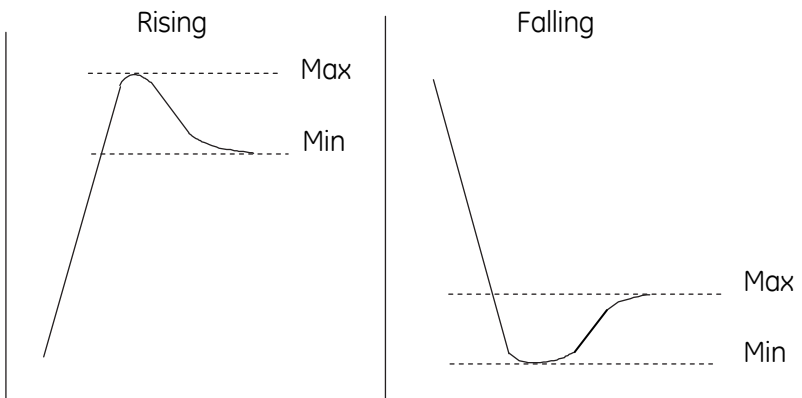

Figure 2-15 Relief Valve Utility

2.2.3 Measurement Display Options

There are 2 display views in the CALIBRATOR screen when multiple channels are in use:

- *Figure 2-16* displays a reduced view of all the selected channels.



Figure 2-16 Calibration Window – Reduced View

- *Figure 2-17* displays an expanded view of the selected channel and minimizes the remaining channels.



Figure 2-17 Calibration Window - Expanded View

The display options can be changed by pressing the channel the user wants to display in expanded view.

Selecting  displays all channels in the reduced view.

2.2.4 Example Procedures

a. Example Procedure: Measure or Source Current with internal loop power

- *Figure 2-18 shows CH1 set-up to measure or source a current with internal loop power.*

Note: *Loop drive is provided by connecting to the 2 red terminals on the front of the DPI611 and enabling Current (24V) as the electrical function.*

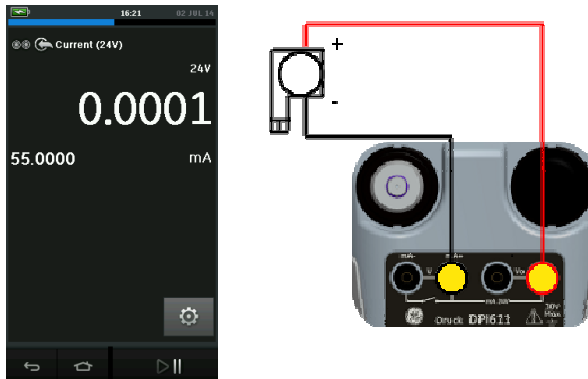

Figure 2-18 Measure current on CH1. Range ± 55 mA

1. Set the applicable software options.
2. Complete the electrical connections and continue with the measure or source operation.
3. Source only (Automation). Set the applicable output value.

b. Example Procedure: Measure Voltage

- *Figure 2-19* shows CH1 set-up to measure a DC voltage (± 30 V) or DC mV (± 2000 mV).

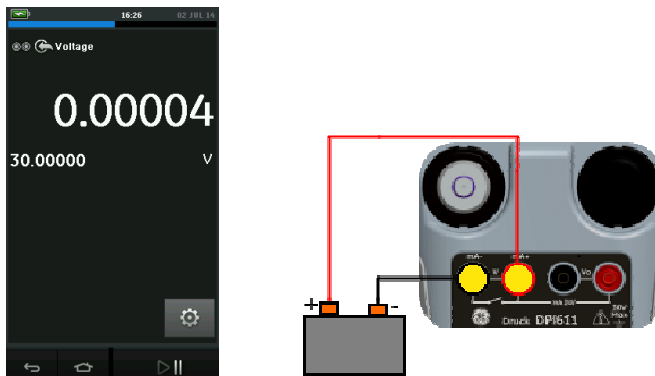

Figure 2-19 Measure DC Volts or DC mV on CH1.

1. Set the applicable software options.
2. Complete the electrical connections and continue with the measure operation.

c. Example Procedure: Measure or Source Current with External Loop drive

- *Figure 2-20* and *Figure 2-21* show how to set-up to measure ($\pm 55\text{mA}$) or source (0 to 24mA) a current with external loop power.

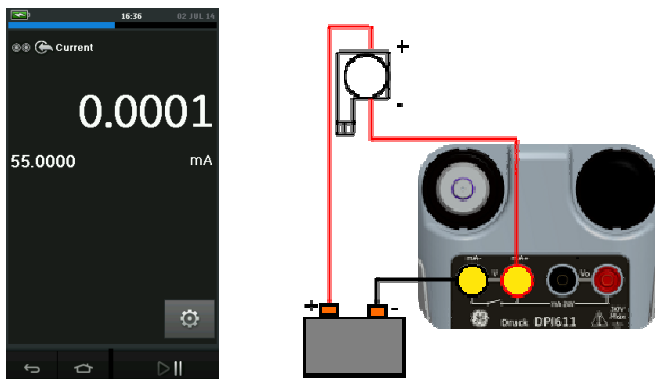

Figure 2-20 Measure current with external loop power (Range: $\pm 55\text{mA}$)

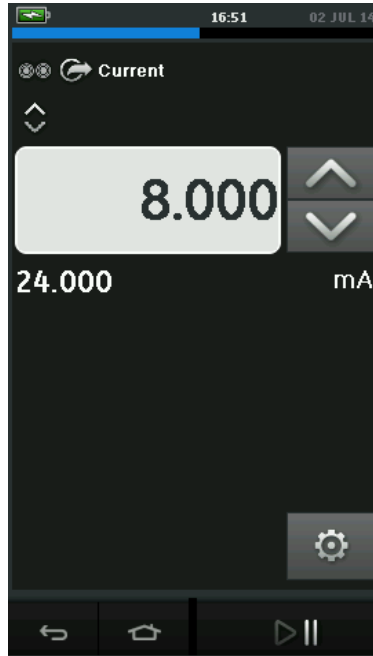

Figure 2-21 Source current with external loop power. (Range: 0 to 24 mA)

1. Set the applicable software options.
2. Complete the electrical connections and continue with the measure or source operation.
3. Source only (Automation): Set the applicable output value.

d. Example Procedure: Switch Test

Switch Test is only valid when a Pressure Function is selected.

Switch operation

When setting the Switch Test, the software automatically sets the electrical channel to the switch test function.

Note: If there is an electrical function already selected it will automatically be disabled. The display will show a screen message.

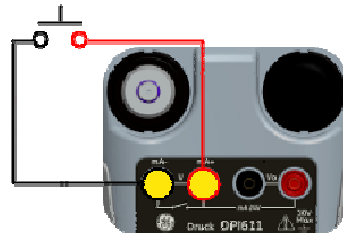
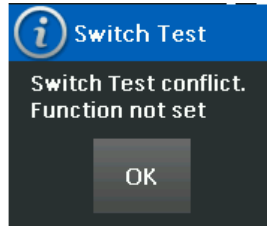

Figure 2-22 Switch Test

e. Example Procedure: Measure Voltage with Internal Voltage Source

Figure 2-23 shows CH1 set-up to measure a DC voltage (± 30 V) or DC mV (± 2000 mV) with Internal Voltage Source (e.g. for use with Resistive bridge).

Note: Internal Voltage is provided by connecting to the V_o terminals on the front of the DPI611 and enabling Voltage (10V) or Millivolts (10V) as the electrical function.

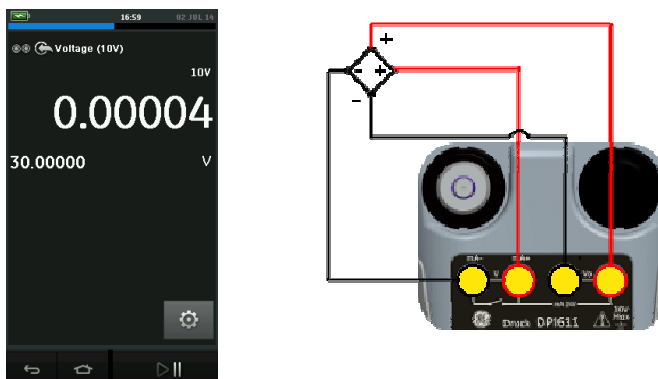

Figure 2-23 Measure DC Volts (10V) or DC mV (10V) on CH1

1. Set the applicable software options.
2. Complete the electrical connections and continue with the measure operation.

2.3 PRESSURE CALIBRATION

PRESSURE TASKS are available in the TASK MENU. See *Section 2.2.1 Basic Calibrator Operation* for details.

Select the required function by touching either the appropriate text or diagram. The DPI611 will set the functions and return to the CALIBRATOR screen.

Pressure Functions can also be selected through the CUSTOM TASK function. See *Section 2.2.1* for details.

If required, change the Units or the function. If necessary, set a Utility for the function:

- Max/Min/Avg
- Switch Test
- Relief valve
- Leak Test

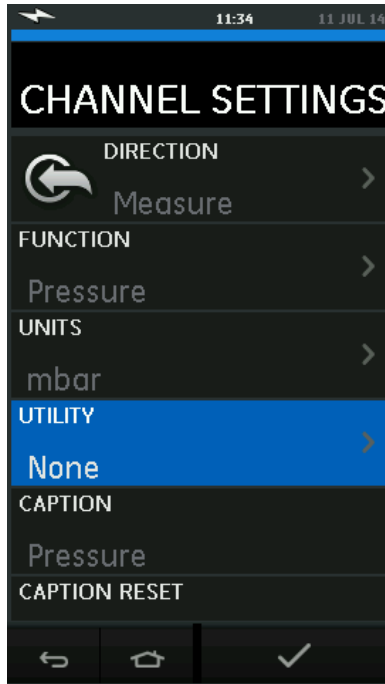

Figure 2-24 Channel Settings

Note: *UNITS and UTILITIES are accessed through selecting the function through CUSTOM TASK.*

2.3.1 Set up a Leak Test

 This utility is only available in Pressure Measurement modes. This utility provides a test to calculate the leak of a system.



Figure 2-25 Leak Test Example

To configure leak test:

1. Set the Utility to Leak Test.

Select:

 **SETTINGS >> LEAK TEST**

2. Set the following periods

WAIT TIME:

The time before the test starts in hours:minutes:seconds (hh:mm:ss).

TEST TIME:

The period of the leak test in hours:minutes:seconds (hh:mm:ss)

3. Use  to start the Leak Test
4. Use  to stop the Leak Test.

2.3.2 Set the Pressure Module to Zero

SETTINGS >> ZERO >> ZERO

Use this option to write a new zero pressure value to the pressure module in use. The sensor adjustment is permitted if it obeys the condition that follows:

- Adjustment $\leq 10\%$ FS positive pressure value (for the Sensor).
Note: To make a temporary adjustment for zero, use the Tare function.

2.3.3 Error Indications

Under range: The display shows this symbol for this condition:

<<<<<

Reading < 110% Negative Full Scale (Pressure)

Reading < 102% Negative Full Scale (Electrical)

Over range: The display shows this symbol for this condition:

>>>>>

Reading > 110% Positive Full Scale (Pressure)

Reading > 102% Positive Full Scale (Electrical)

If the display shows <<<< (under range) or >>>> (over range):

- Make sure that the range is correct.
- Make sure that all the related equipment and connections are serviceable.

2.4 MEASURE PRESSURE: IDOS Option

Optional item, An IDOS Universal Pressure Module (UPM) uses Intelligent Digital Output Sensor (IDOS) technology to measure the applied pressure and supply the data to an IDOS instrument. Before using an IDOS module, (Ref: User Manual: K0378, Druck IDOS UPM).

Note: To attach an IDOS module to the Druck DPI611 use an IO620-IDOS-USB adaptor.

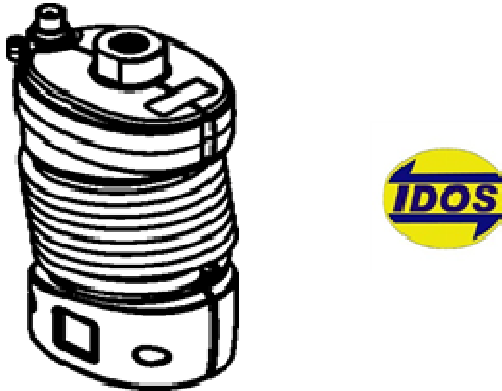



Figure 2-26 IDOS Module

2.4.1 IDOS Option Assembly Instructions

Table 2-4

Step	Procedure
1	Attach one end of the adaptor IO620-IDOS-USB to the IDOS module
2	Push the Type A end of USB Cable into the USB socket on the instrument and the type B end into the adaptor (IO620-IDOS-USB)
3	Set the instrument power on
	When this symbol flashes at the top of the display, it shows there is communication between the IDOS module and the calibrator

2.4.2 IDOS Function Procedures

The procedures for an IDOS module are the same as for the internal pressure sensor.

Enable the IDOS module from the TASK menu:

- IDOS function (Measure or Differential)
- If necessary, change the Units for the function
- If necessary, set a Utility for the function:

- I. Max/Min/Avg
- II. Switch Test
- III. Leak Test
- IV. Relief Valve

The Settings menu for the IDOS module contains the following options.

- Units.
- Process (Tare, Alarm, Filter, Flow, Scaling).
- Zero. The procedure is the same for an IDOS module or the internal pressure sensor. Zero the gauge sensor before use.
- Resolution. Select the number of digits to be displayed.

3 DATA LOGGING OPERATION

Select the  DATA LOGGING option on the Dashboard. The Data Logging function records instrument readings so they can be reviewed or analyzed.

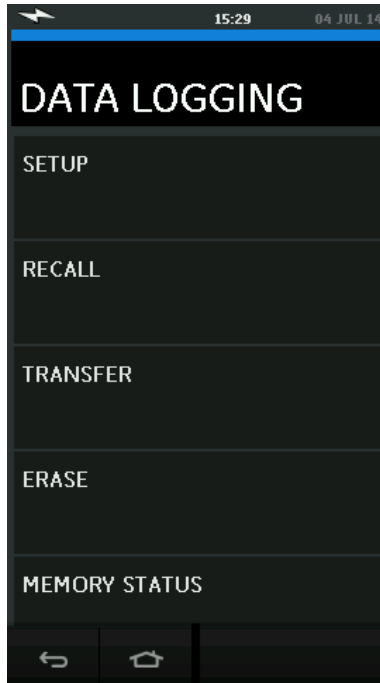

Figure 3-1 Data Logging

The data file can be reviewed by using the following:

- RECALL

The data file can be processed externally by using the following:

- TRANSFER
 - Transfer to a USB Flash Drive
 - Transfer to a Computer via serial port

This chapter describes how to use the Data Logging function to log data to a file.

In Data Logging mode the display data from all active channels is stored at each data point.

The data can be stored:

- Periodically
- Key press

The data is stored in the internal memory or on a USB Flash Drive connected to the Unit until the Data Logging is stopped.

3.1 SET-UP

Before starting, set all channels to the correct functions. (See *Chapter OPERATIONS*). To access the Data logging function do the following:

DASHBOARD >>  DATA LOGGING >> SETUP

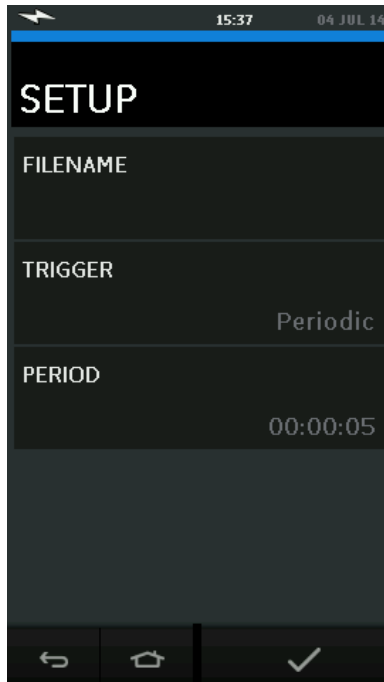

Figure 3-2 Data logging Setup

- **FILENAME**
Enter the filename (10 characters maximum).
- **TRIGGER**
Select one of the following:
 - a. Key Press (logs one data point each time the button is pressed).
 - b. Periodic (logs one data point at a set time interval).
- **PERIOD**
This option is used to set the time interval for periodic data logging.

To start Data Logging Mode:

1. Select appropriate options and enter filename for Data Log file.

Note: When entering filename it is first necessary to select destination (INTERNAL or USB FLASH DRIVE)

2. Select the  button.

3.2 OPERATION

In periodic mode, to begin data logging tap 'Start logging'  button.

In Key press mode, a data point is taken every time the user taps the log button 



To stop Data Logging select 

The data logging indicator  flashes to indicate whenever a reading is logged.

3.3 FILE REVIEW

DASHBOARD >>  DATA LOGGING >> RECALL

To view a data file point by point do the following:

1. Tap the Filename button to display the list of data files.
2. Select the file to be displayed.
3. Tap  to see the data display.
4. To step the display one data point, tap the Next Log button .

Note: The data point number sequence is displayed in the top right-hand corner (e.g. 4 of 100).

5. To go back one data point, press the Previous Log button .
6. Exit the screen.

3.4 FILE MANAGEMENT

The data log file management options are as follows:

- **TRANSFER**
Upload data log files to another computer.
- **ERASE**
Delete data log files.
- **MEMORY STATUS**
Displays amount of free memory.

3.4.1 Transfer

Data may be transferred as follows:

- **USB Flash Drive:** Selected files are written in the root folder of the USB Flash Drive.
- **USB Serial Port:** Transfers data as a text file to a computer. A communications program can be used to receive the data (e.g. Microsoft® Hyper Terminal).

The serial set-up is as follows:

Baud rate:	19,200 bits/sec
Data bits:	8
Parity:	none
Stop bits:	1

3.4.2 Erase

The Erase options are as follows:

- ERASE ONE FILE: Select file and tap tick bottom right on the screen to erase.
- CLEAR INTERNAL: Clears all internal files.

3.4.3 Memory Status

The MEMORY STATUS button will show the amount of available memory in the areas that follow:

- Internal
- USB Flash Drive (if fitted)

3.5 DATA FORMAT

The data files are produced in a Comma Separated Variable (csv) format (See *Figure 3-3*). This allows the data to be imported into a spreadsheet (e.g. Microsoft® Excel). The first section of the data file contains the following:

FILENAME - The data file name

COLUMNS - Information for internal use

START - Data log start time

VERSION - Data format version

CHANNEL - The function setting of each active channel

The second section of the data file contains the following:

Individual headings

Data point data

```
FILENAME,P080821A
COLUMNS,3,9
START,21 Aug 2008, 21:38:59
CHANNEL 001, Current (24V), In,mA,55
CHANNEL 005, HART, In,,0
DATA,START
ID,Date,Time,Main Reading,Secondary Reading,
0,21 Aug 2008, 21:39:14,8.7525,24V,4,0,False
1,21 Aug 2008, 21:39:29,8.5711,24V,4,0,False
2,21 Aug 2008, 21:39:44,8.4080,24V,4,0,False
3,21 Aug 2008, 21:39:59,8.2475,24V,4,0,False
4,21 Aug 2008, 21:40:14,8.0733,24V,4,0,False
5,21 Aug 2008, 21:40:29,7.9288,24V,4,0,False
```

Figure 3-3 Example .csv Data log File

4 DOCUMENTATION

This chapter describes the Documenting functions available with the Druck DPI611 calibrator as follows:

- ANALYSIS
- RUN PROCEDURE

4.1 ANALYSIS

The Analysis function takes readings from two or more DPI611 channels to calibrate the transfer characteristic of the device being tested. One channel is the Reference channel and is used as follows:

- It provides a measure of the input signal to the device.
- If the device is a pressure transmitter the Reference channel would be Pressure, measuring the input pressure to the device.



The other channel is the Input channel and is used as follows:

- Measures the output signal from the device
- If calibrating a process transmitter it could be the electrical channel in Current Measure mode.

Any active channel that is not defined as Reference is Input by default. There must be one Reference channel and at least one Input channel defined for the Analysis function set-up to be correct.

At each value the Analysis function calculates the difference of each Input channel to the ideal transfer characteristic and compares this to a tolerance limit.

- The deviation is shown in %Span or %Rdg

- The tolerance test result is shown a Pass  or  Fail icon.

4.2 SET-UP

1. Set the Druck DPI611 channels in the Calibrator function. (See *Section 2.2*).
2. Connect the calibrator to the device under test.
3. Enter the Documenting function.

DASHBOARD >>  DOCUMENTING

4. Tap the ANALYSIS button.

4.2.1 Define the Reference Channel

1. Tap the channel button that is to be used as the Reference channel for the analysis.

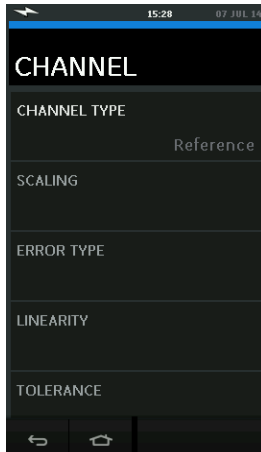

Figure 4-1 Select Reference Channel

2. Set the channel type to Reference.
3. All other channel settings for that channel are cancelled. All other active channels are set to Input.

4.2.2 Define each Input Channel

Tap each Input channel button to set the Input options.

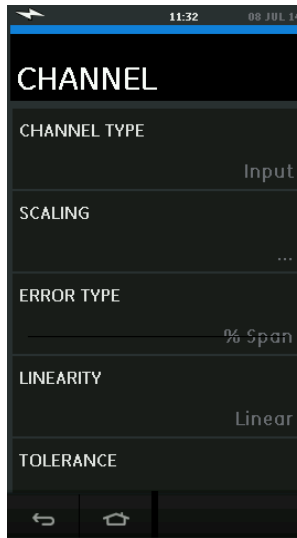

Figure 4-2 Select Input Options

SCALING

The scaling values are two pairs of values that define the ideal transfer characteristic:

The maximum and minimum Reference signal values (Reference High and Reference Low) and the corresponding Input signal values (Input High and Input Low).

ERROR TYPE -

Selects how the deviation from the ideal transfer characteristic is to be displayed. This can be one of the following:

% Span- a percentage of the Input signal span.

% Rdg - a percentage of the Input signal reading.

LINEARITY - The transfer characteristic from Reference to Input signal. This can be one of the following:

Linear - a proportional response.

Square Root - often found in flow sensors.

TOLERANCE - The test limits for the deviation from the transfer characteristic.

4.3 ANALYSIS FUNCTION

Set Input channel parameters (See *Section 4.2*), and return to CHANNEL SETUP screen.

Select the Start button .

The Analysis window displays the following:

- The deviation of each Input channel from the ideal transfer characteristic.
- A tolerance limit test icon

Pass  (within tolerance test limit)

Fail  (outside tolerance test limit)

To check the full range of the device do the following:

1. Step the Reference signal value through its range.
2. Check the Analysis window at each step.
3. If the Reference is sourced from the calibrator, move to the channel window to change the Reference value.
4. Return to the Analysis window.
5. When the analysis is complete exit the window by selecting exit .

4.4 RUN PROCEDURE



The purpose of the Run procedure is to do calibration procedures which have been downloaded from 4 Sight software. The 4 Sight calibration procedures contain all the values to calibrate a device under test (test points, ramp time).

The same calibration procedure can be used for all the applicable devices under test. To use the Run Procedure function, the following items are required:

- A copy of the 4 Sight Calibration Software.
- Standard USB lead (as supplied).
- A Druck DPI611 calibrator device driver available as a download from the website www.ge-mcs.com.

4.4.1 Sequence to Upload and Download file

Table 4-1

Step	Procedure
1	Connect the USB cable (See <i>Section 1.11, Accessories</i>) to the Druck DPI611 calibrator.
2	Connect the lead to the USB port on the computer that has the calibrator manager installed.
3	Use 4 Sight to set-up the procedure and create a work order for the device. The procedure includes the parameters for the calibration, the number of test points, the relationship and pass/fail tolerance.
4	Use the Download button in calibrator manager to Download the file to the Druck DPI611 calibrator. A communications symbol will be displayed at the bottom of the screen.
5	Select: DASHBOARD >> DOCUMENTING >> RUN PROCEDURE
6	In the Results window, select the filename specified in calibrator manager.
7	Enter the User ID and the DUT Serial Number.
8	Tap on the Start button  . The procedure sets up the necessary Channel options e.g. mA and Volts.
9	Use the Take Reading button at each point specified by the procedure. A prompt show for each point.
10	When all the readings are complete, tap on the Exit Button  . Look at the results on the display (As found/As Left).
11	To complete the process, use the calibrator manager to Upload the file back into the 4 Sight database.

5 CALIBRATION

5.1 GENERAL

The instrument is supplied by the manufacturer, complete with calibration certificate(s). A calibration period of 12 months is recommended. The actual calibration interval depends on instrument usage and the total measurement uncertainty acceptable for the specified application.

The DPI611 is a very precise measuring instrument and the test equipment and conditions of test must be suitable for the type of work. The calibration check and calibration adjustment should be carried out in a controlled environment by a calibration technician.

Note: *A calibration technician must have the necessary technical knowledge, documentation, special test equipment and tools to carry out the calibration work on this equipment.*

Note: *GE Measurement and Control can provide a calibration service that is traceable to international standards.*

Note: *GE Measurement and Control recommend returning the instrument to the manufacturer or an approved service agent for calibration. If using an alternative calibration facility, check that it uses the standards that follow.*

5.2 CALIBRATION CHECK

At the chosen calibration interval, the instrument readings should be compared with a known pressure standard.

The recommended method starts at 0, increasing in 20% steps to 100% full-scale and then decreasing in 20% steps to 0.

Note any deviations between the instrument and the pressure standard and consider traceability (accuracy to a National Standard). If, after a calibration check, the results exceed the tolerance in the specification (or other suitable performance standard), carry out a calibration adjustment.

5.3 CALIBRATION ADJUSTMENTS

If the instrument is operating correctly, only zero and full-scale calibration will vary. Any excessive non-linearity or temperature effects indicate a fault. The instrument should be returned to a qualified service agent.

5.4 BEFORE STARTING

Use only original parts supplied by the manufacturer. To do an accurate calibration, use the following:

- Calibration equipment specified in *Table 5-1*.
- Stable temperature environment: $21 \pm 1^{\circ}\text{C}$ ($70 \pm 2^{\circ}\text{F}$).

Before starting a calibration procedure, it is recommended leaving the equipment in the calibration environment for a minimum of two hours.

Table 5-1

Function	Calibration equipment (ppm = parts per million)
Current	Current (mA) calibrator. Accuracy - Current measure/source, <i>See Table 5-2 and Table 5-3.</i>
Voltage	Volts calibrator. Accuracy - Voltage measure/source, <i>See Table 5-5 or Table 5-6.</i>
Millivolts	mV calibrator. Accuracy - Millivolts measure/source, <i>See Table 5-4 .</i>
Pressure (P1)	All Ranges total uncertainty of 0.025% reading or better.
IDOS	UPM only. Refer to the user manual for the IDOS UPM.

Before starting the calibration, check the time and date on the instrument are correct.

To do a calibration on a measure or source function, use the advanced menu option.

Select:

DASHBOARD >>  SETTINGS
>> ADVANCED

Enter the calibration PIN: 4321

Select the  button.

Select: PERFORM CALIBRATION

Then select a function and start the calibration:

1. Select channel
2. Select function

3. Select range (if applicable)
4. Follow on-screen instructions

When the calibration is complete, set the next calibration date.

5.5 PROCEDURES: CURRENT (measure)

Do the procedure as follows:

1. Connect the applicable calibration equipment (See Table 5-1)
2. Let the equipment get to a stable temperature (minimum: 5 minutes since the last power on).
3. Use the calibration menu (See Section 5.4) to do a three-point calibration (-FS, Zero and +FS) for each range: 20 mA and 55 mA.
4. Check the calibration is correct.
 - Select the applicable Current (measure) function.
 - Apply the values that follow:
 - mA: -55, -25, -20, -10, -5, 0 (open circuit)
 - mA: 0, 5, 10, 20, 25, 55.
 - Check the error is in the specified limits (See Table 5-2).

Table 5-2 Current (measure) error limits

Applied mA	Calibrator uncertainty (mA)	Permitted DPI611 error (mA)
±55	0.0030	0.0057
±25	0.0025	0.0043
±20	0.00063	0.0022
±10	0.00036	0.0016
±5	0.00025	0.0013
0 (open circuit)	0.0002	0.0010

5.6 PROCEDURES: CURRENT (source)

When recalibrating measure and source functions for this range, the measure function must be adjusted before the source function.

Do the procedure as follows:

1. Connect the applicable calibration equipment
(See *Table 5-1*):
 - CH1 (24 mA range): (See *Table 5-3*).
2. Let the equipment get to a stable temperature (minimum: 5 minutes since the last power on).
3. Use the calibration menu (See *Section 5.4*) to do a two-point calibration (0.2 mA and FS):
 - CH1: 24 mA.
4. Check the calibration is correct:
 - Select the applicable Current (source) function
 - Apply the values that follow:
mA: 0.2, 6, 12, 18, 24
 - Check the error is within limits (See *Table 5-3*)

Table 5-3 Current (source) error limits

Applied mA	Calibrator uncertainty (mA)	Permitted DPI611 error (mA)
0.2	0.00008	0.0013
6	0.00023	0.0017
12	0.00044	0.0020
18	0.0065	0.0024
24	0.0012	0.0028

5.7 PROCEDURES: DC mV/Volts (measure)

Do the procedure as follows:

1. Connect the applicable calibration equipment (See *Table 5-1*).
2. Let the equipment get to a stable temperature (minimum: 5 minutes since the last power on).
3. Use the calibration menu (See *Section 5.4*) to do a three-point calibration.

(-FS, Zero and +FS) for the applicable set of ranges:

mV (measure) ranges

200 mV

2000 mV

Volts (measure) ranges

20 V

30 V

4. Check the calibration is correct:
 - Select the applicable Millivolts or Voltage (measure) function.
 - Apply the input values that are applicable to the Calibration:

mV: -2000, -1000, -200, -100, 0 (short circuit)

mV: 0, 100, 200, 1000, 2000

Volts (V): -30, -21, -20, -10, -5, 0 (short circuit)

Volts (V): 0, 5, 10, 20, 21, 30.

- Check that the error is within limits (See Table 5-4 and Table 5-5).

Table 5-4 Millivolts (measure) error limits

Applied mV	Calibrator uncertainty (mV)	Permitted DPI611 error (mV)
±2000	0.051	0.1280
±1000	0.040	0.0940
±200	0.051	0.0148
±100	0.0040	0.0110
0 (short circuit)	0.0036	0.0070

Table 5-5 Voltage (measure) error limits

Applied V	Calibrator uncertainty (V)	Permitted DPI611 error (V)
±30	0.00052	0.00180
±21	0.00040	0.00154
±20	0.00031	0.00118
±10	0.00016	0.00089
±5	0.00008	0.00075
0	0.000024	0.00060

5.8 PROCEDURES: DC Volts (source)

Do the procedure as follows:

1. Connect the applicable calibration equipment (See *Table 5-1*).
2. Let the equipment get to a stable temperature (minimum: 5 minutes since the last power on).
3. Use the calibration menu (See *Section 5.4*) to do a two-point calibration for the applicable range:

Volts (source) range

10 V

24 V

4. Check the calibration is correct:
 - Select the applicable Voltage (10V) or Current (24V) (measure) function (See *Section 5.7*).

10V

24V

- Check the error is within limits (See *Table 5-6*).

Table 5-6 Voltage (source) error limits

Source V	Calibrator uncertainty (V)	Permitted DPI611 error (V)
10	0.0001	0.0015
24	0.0004	0.0036

5.9 PROCEDURES: PRESSURE INDICATOR

Do the procedure as follows:

1. Connect the instrument to the pressure standard.
2. Let the equipment get to a stable temperature (minimum: 60 minutes since the last power on).
3. Use the calibration menu (*See Section 5.4*) to do a two-point calibration.
 - Zero and +FS for gauge sensors.
4. Check the calibration is correct:
 - Select the applicable pressure function.
 - Apply the following pressure values.
 - 0, 20, 40, 60, 80, 100, 80, 60, 40, 20 (%FS).
 - Apply the following pressure values.
 - -200, -400, -600, -800, -600, -400, -200, 0 mbar.
 - Check the error is within limits

From the datasheet use the values in the Accuracy column.

5.10 PROCEDURES: IDOS UPM

(Refer: User Manual IDOS UPM).

When the calibration is complete, the instrument automatically sets a new calibration date in the UPM.

6 GENERAL SPECIFICATION

For a full specification of the Druck DPI611 calibrator and its related accessories refer to the relevant product datasheet.

The DPI 611 is suitable for indoor use with the following environmental requirements. It is permitted to use the DPI 611 outdoors as a portable instrument if the environmental requirements are met.

Table 6-1

Display	Size: 110 mm (4.3in) diagonal. 480 x 272 pixels. LCD: Color display with touch-screen
Languages	English (default), Chinese, Dutch, French, German, Italian, Japanese, Korean, Portuguese, Russian, Spanish
Operating temperature	-10°C to 50°C (14°F to 122°F), 0°C to 40°C (32°F to 104°F) when powered from optional mains adaptor IO620-PSU
Storage temperature	-20°C to 70°C (-4°F to 158°F)
Ingress Protection	IP54. Protected against dust and splashing water from any direction
Humidity	0 to 90% RH none condensing. To Def Stan 66-31, 8.6 cat III
Shock / Vibration	BS EN 61010-1:2010 / MIL-PRF-28800F CLASS 2
Altitude	Up to 2000m
EMC	BS EN 61326-1:2013
Electrical safety	BS EN 61010-1:2010
Pressure safety	Pressure Equipment Directive - Class: Sound Engineering Practice (SEP)
Enclosure materials	Polycarbonate, polyamide, polypropylene, acrylic, cotton
Approved	CE Marked
Size (L:W:H)	270 x 130 x 120mm (10.6 x 5.1 x 4.7 in)
Weight	1.96Kg (4.3lb) including batteries

Power supply	8 x AA alkaline batteries Optional mains adaptor P/N IO620-PSU 100–260V +/- 10%, 50 / 60Hz AC, Output DC V=5A, 1.6A
Battery life	18 to 26 hours depending on functions
Connectivity	USB type A, USB type mini B

Note 1: *The DPI611 has been assessed to the European IEC60529 standard as having an ingress protection rating of IP54, but this is for reliability purposes and not for safety reasons.*

Note 2: *To meet the immunity requirements of annex A of EN61326-1:2013, when used in an industrial environment, the unit must be battery powered to guarantee measurement specification*

Note 3: *The case of the DPI611 is not suitable for prolonged exposure to UV.*

Note 4: *The DPI611 is not suitable for permanent installation in an outdoor environment.*

7 MANUFACTURER

Druck Limited
Fir Tree Lane
Groby
Leicester
LE6 0FH
United Kingdom

Tel: +44 (0)116 231 7100