

Leakage Current Tester

GLC-10000

USER MANUAL

Rev. A



ISO-9001 CERTIFIED MANUFACTURER

GW INSTEK

This manual contains proprietary information, which is protected by copyright. All rights are reserved. No part of this manual may be photocopied, reproduced or translated to another language without prior written consent of Good Will company.

The information in this manual was correct at the time of printing. However, Good Will continues to improve products and reserves the rights to change specification, equipment, and maintenance procedures at any time without notice.

Good Will Instrument Co., Ltd.
No. 7-1, Jhongsing Rd., Tucheng Dist., New Taipei City 236, Taiwan.

Table of Contents

SAFETY INSTRUCTIONS	6
OVERVIEW	11
Introduction.....	11
Key Features	18
Basic Theory	22
Leakage Current Modes	24
Leakage Current Modes	30
Measurement Flow Chart.....	32
Front Panel	33
Rear Panel.....	35
Touch Screen Basics	38
GETTING STARTED	39
Preparation	39
Power and Probe Connection	40
Tilt the Stand and Hand Carry.....	44
Power Up	45
Shut Down	46
OPERATION	47
Measurement Terminals.....	47
Earth Leakage Current.....	50
(Touch) Enclosure - Earth Leakage Current	51
(Touch) Enclosure - Enclosure Leakage Current..	53
(Touch) Enclosure - Line Leakage Current.	55
Patient Auxiliary Current	57
Patient Connection - Earth Leakage Current (Patient Leakage Current I)	58
External Voltage on a SIP/SOP Leakage Current (Patient Leakage Current II)	60

External Voltage on a Specific F-type Applied Part Leakage Current (Patient Leakage Current III)	62
External Voltage on Metal Accesible Part not Protectively Earthed Leakage Current ..	63
Total Patient Leakage Current (Patient Connection – Earth)	65
Free Current (Enclosure – Enclosure)	66
MEASUREMENT	68
Interface of Home Screen	68
Selecting a Measuring Network.....	73
Selecting the Safety Class/ Grounding Class	76
Selecting a Leakage Measurement Mode... ..	77
Selecting Measurement Parameters	79
Saving Measurement Results	87
SAVE/RECALL FEATURES	89
Save Panel Settings	89
Recall Panel Settings or Test Data	92
USB Storage	96
Connection and Navigation	96
Download and Upload Files	97
Firmware Update	98
Save a Screen Image	99
SYSTEM SETTINGS.....	100
Meter Measurement.....	101
EUT Voltage and Current Check	104
Initialize Menu	106
System Self Test	107
Beep Settings	108
Display Settings	109
Interface Settings.....	110

Clock Settings	112
Calibration	113
Information	114
Measure Settings	115
REMOTE CONTROL	117
Remote Interface Configuration	118
COMMAND OVERVIEW	122
Command Syntax	122
Command List	125
Appendix for Commands.....	185
EXTERNAL I/O.....	200
Features	200
Cautions	200
I/O Definition	201
Connection	203
Electrical Characteristics.....	204
Internal Circuit Configuration	205
FAQ.....	206
APPENDIX.....	207
Measurement Functions	207
Specifications	209
Accessories.....	210
Measurement Network (MD)	211
Fuse Replacement.....	213
Dimensions	214
Declaration of Conformity.....	215
INDEX	216

S SAFETY INSTRUCTIONS

This chapter contains important safety instructions that you must follow during operation and storage. Read the following before any operation to ensure your safety and to keep the instrument in the best possible condition.

Safety Symbols

These safety symbols may appear in this manual or on the instrument.



WARNING

Warning: Identifies conditions or practices that could result in injury or loss of life.



CAUTION

Caution: Identifies conditions or practices that could result in damage to the GLC-10000 or to other properties.



DANGER High Voltage



Attention Refer to the Manual



Protective Conductor Terminal



Earth (ground) Terminal



Do not dispose electronic equipment as unsorted municipal waste. Please use a separate collection facility or contact the supplier from which this instrument was purchased.

Safety Guidelines

- General Guideline • Do not place any heavy object on the instrument.
-  CAUTION • Avoid severe impact or rough handling that leads to damaging the instrument.
- Do not discharge static electricity to the instrument.
 - Do not block or obstruct the cooling fan vent opening.
 - Do not perform measurement at circuits directly connected to Mains (Note below).
 - Do not disassemble the instrument unless you are qualified as service personnel.

(Measurement categories) EN 61010-1:2001 specifies the measurement categories and their requirements as follows. the GLC-10000 falls under category II

- Measurement category IV is for measurement performed at the source of low-voltage installation.
- Measurement category III is for measurement performed in the building installation.
- Measurement category II is for measurement performed on the circuits directly connected to the low voltage installation.
- Measurement category I is for measurements performed on circuits not directly connected to Mains.

Power Supply



WARNING

- AC 100V~240V $\pm 10\%$, 50/60Hz
- Connect the protective grounding conductor of the AC power cord to an earth ground, to avoid electrical shock.

Fuse



WARNING

- Fuse type: T0.63A/250V
 - Make sure the correct type of fuse is installed before power up.
-

- To ensure fire protection, replace the fuse only with the specified type and rating.
- Disconnect the power cord before fuse replacement.
- Make sure the cause of fuse blowout is fixed before fuse replacement.

Cleaning the
GLC-10000

- Disconnect the power cord before cleaning.
- Use a soft cloth dampened in a solution of mild detergent and water. Do not spray any liquid.
- Do not use chemical or cleaner containing harsh material such as benzene, toluene, xylene, and acetone.

Operation
Environment

- Location: Indoor, no direct sunlight, dust free, almost non-conductive pollution (Note below)
- Relative Humidity: < 80%
- Altitude: < 2000m
- Temperature: 0°C to 40°C

(Pollution Degree) EN 61010-1:2001 specifies the pollution degrees and their requirements as follows. The GLC-10000 falls under degree 2.

Pollution refers to “addition of foreign matter, solid, liquid, or gaseous (ionized gases), that may produce a reduction of dielectric strength or surface resistivity”.

- Pollution degree 1: No pollution or only dry, non-conductive pollution occurs. The pollution has no influence.
- Pollution degree 2: Normally only non-conductive pollution occurs. Occasionally, however, a temporary conductivity caused by condensation must be expected.
- Pollution degree 3: Conductive pollution occurs, or dry, non-conductive pollution occurs which becomes conductive due to condensation which is expected. In such conditions, equipment is normally protected against exposure to direct sunlight, precipitation, and full wind pressure, but neither temperature nor humidity is controlled.

Storage environment

- Location: Indoor
 - Relative Humidity: < 80%
 - Temperature: -10°C to 50°C
 - Mains supply voltage fluctuations: +/-10 %
 - If the equipment is used in a manner not specified by the manufacturer, the protection provided by the equipment may be impaired.
 - LAN, RS232, USB, Signal I/O and GPIB ports are only to be connected to the circuits which are separated from mains supply by double / reinforce insulation.
-

Disposal

Do not dispose this instrument as unsorted municipal waste. Please use a separate collection facility or contact the supplier from which this instrument was purchased. Please make sure discarded electrical waste is properly recycled to reduce environmental impact.

Power Cord

- Do NOT replace the detachable MAINS supply cord by inadequately RATED cords.
 - Suitable supply cord set shall use with the equipment:
 - Mains plug: Shall be national approval;
 - Mains connector: C13 type;
 - Cable:
 - 1) Length of power supply cord: less than 3 m;
 - 2) Cross-section of conductors: at least 0.75 mm²;
 - Cord type:
 - Shall meet the requirements of IEC 60227 or IEC 60245 (e.g.: H05VV-F, H05RN-F) or national approval.
 - The power switch that is included in the instrument is not considered a disconnecting device. The mains plug is used as the disconnecting device. Do NOT position the equipment so that it is difficult to disconnect the appliance inlet or power plug.
-

O VERVIEW

This chapter describes the GLC-10000 in a nutshell, including the main features, front and rear panel description, and the power up sequence.

Introduction

Overview

Many electrical products must undergo electrical safety testing to ensure their safety. These tests include insulation resistance, withstand voltage, ground continuity and leakage current tests. These tests are complex and critical for safety standards compliance.

To comply with international standards and to ensure operator safety, leakage current tests are also performed under normal and faulty operating conditions.

Leakage current tests can be separated into 3 basic types:

- Earth Leakage current
- Enclosure Leakage current
- Patient Leakage current

The GLC-10000 complies with IEC, UL and other international electrical safety standards requiring leakage current measurement.

Leakage Current Modes

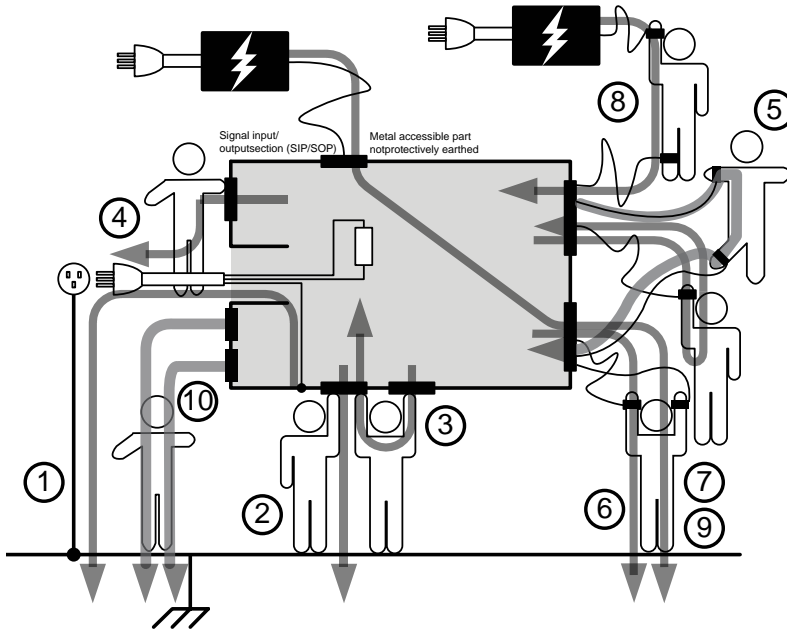

Earth Leakage Current Refers to the current that flows through a protective grounding wire to earth **#1**. (General Electrical, Medical Equipment)

(Touch) Enclosure Leakage Current Refers to the current that flows through a human body in contact with a device enclosure including three scenarios: Enclosure - Earth **#2**, Enclosure - Enclosure **#3** and Enclosure - Line **#4**. (General Electrical, Medical Equipment)

Patient Auxiliary Current Refers to the current that flows through an applied part to human body to applied part **#5**. (Medical Equipment)

Patient connection - Earth Leakage Current (Patient Leakage Current I)	Refers to the current that flows through an applied part to human body to earth #6. (Medical Equipment) It also refers to the Patient Leakage Current I associated with MD-F 1995.
--	---

External Voltage Leakage Current (Patient Leakage Current II)	Refers to the current that flows through an applied part to human body to earth #7. (Medical Equipment) It also refers to the Patient Leakage Current II associated with MD-F 1995.
---	--

External Voltage on a Specific F-type Applied Part Leakage Current (Patient Leakage Current III)	Refers to the current that flows through an applied part of malfunctioning medical equipment to human body to F-type applied part #8. (Medical Equipment) It also refers to the Patient Leakage Current III associated with MD-F 1995.
--	---

External Voltage on Metal Accesible Part not Protectively Earthed Leakage Current	Refers to the current that flows through a metal accesible part not protectively earthed to applied part to human body to earth #9. (Medical Equipment)
---	---

Total Patient Leakage Current	Refers to the current which is the total sum of all leakage current to/from patient connection of the multiple applied parts of identical type #10 (e.g., Patient - Earth). (Medical Equipment)
-------------------------------	---

Free Current Leakage Measurement	Refer to the current which flows between enclosure and enclosure from 2 ungrounded points on the enclosures.
----------------------------------	--

Measurement Principles

Background

Leakage current can be categorized into 3 types: Electric current that flows through the body of someone who touches the equipment, the current that flows through a protective grounding wire to earth and the current that flows through a human body connected to an applied part. When testing the leakage current of an EUT (equipment under test), testing must be performed under normal and single fault conditions.

As shown below, a number of relays are used to simulate different fault conditions. Power to the EUT is normally open and thus turning off the power disconnects one wire on the power line.

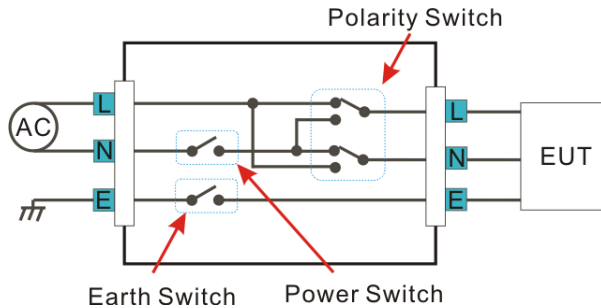

Single Fault conditions include the following:

1. Earth disconnected (excluding earth leakage current tests).
2. Disconnected neutral power line.
3. External equipment failure. (Patient leakage current II, Patient Leakage Current III).

Polarity of the power supply can also be switched to measure the leakage current under test. Thus the polarity of the power supply should also be taken into account.

Measurement Methods

The diagram below shows how the probes, MD's and power supply are connected for different leakage current tests.

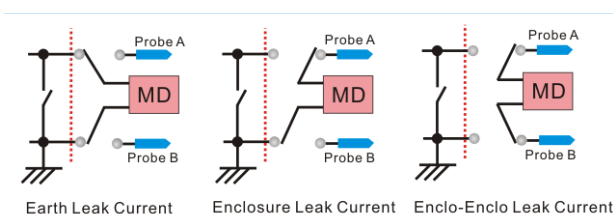

Measuring Devices

Background

Leakage current (touch current) tests that measure electrical equipment require a circuit network that can simulate the impedance of a human body. The impedance of a human body varies with the contact points, area and the path of conduction. Thus the circuit network used to simulate the impedance of a human body varies with the type of test performed. As such, the safety standards used to measure leakage current also varies greatly. The circuit networks used are known as measuring devices, or MD for short. MD circuits are resistor-capacitor (RC) circuits. The GLC-10000 supports 12 different measuring devices.

UL Standards

MD-A

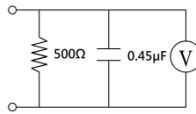

MD-B

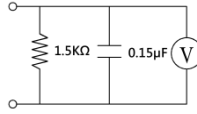

IEC60990-1

MD-C1

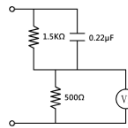

MD-C2

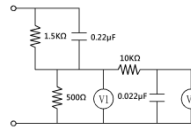

MD-C3

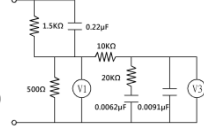

IEC60598-1

MD-D

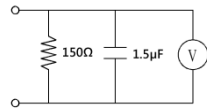

Medical Networks

MD-F

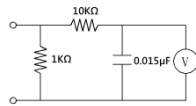

MD-E (without RC filter)

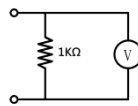

IEC61010-1

MD-G

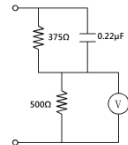

MD-H

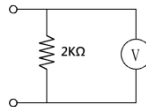

JIS Standards

MD-I

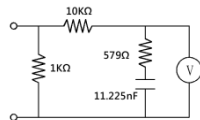

PCC

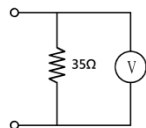



When conducting leakage current tests, please note the following:

1. Under normal operating conditions, leakage current is measured when an electrical device under test is properly insulated with earth. If the device is not properly insulated, the leakage current that is conducted through the measurement network may be invalid.
 2. Leakage current tests involve high voltages. When working with high voltages, testing personnel should use proper safety precautions. All test labs should establish safety rules to cut-off power to an EUT should conditions become unsafe. Contacting any electrical appliance under test is extremely hazardous and should not be attempted.
 3. The surrounding environment has an effect upon leakage current tests. Avoid high temperatures, high humidity and surface pollutants on the enclosure surface as they can all have an influence on the resulting data.
-

Key Features

International Standards and Regulations

The GLC-10000 has 12 measurement networks (Measuring Devices: MD) supporting GB/12113, IEC/UL and other international standards for electrical products:

1. MD-A: UL
 2. MD-B: UL
 3. MD-C1: IEC60990
 4. MD-C2: IEC60990
 5. MD-C3: IEC60990
 6. MD-D: IEC60598
 7. MD-E: (1k Ω):-general application
 8. MD-F: IEC60601
 9. MD-G: IEC61010-1
 10. MD-H: (2k Ω)-general application
 11. MD-I: JIS
 12. PCC: (35 Ω)
-

Measurement Modes	<p>There are a number of leakage current measurement tests covering general electrical equipment and medical electrical equipment.</p> <ol style="list-style-type: none">(1) Earth leakage current(2) Touch current (Enclosure - Earth)(3) Touch current (Enclosure - Enclosure)(4) Touch current (Enclosure - Line)(5) Patient auxiliary current(6) Patient leakage current (Patient connection - Earth)(7) Patient leakage current (external voltage on a SIP/SOP)(8) Patient leakage current (external voltage on a specific F-type applied part)(9) Patient leakage current (external voltage on metal accessible part not protectively earthed)(10) Total patient leakage current (Patient connection - Earth)(11) Total patient leakage current (external voltage on a SIP/SOP)(12) Total patient leakage current (external voltage on a specific F-type applied part)(13) Total patient leakage current (external voltage on metal accessible part not protectively earthed)(14) Free current (Enclosure - Enclosure)(15) Enclosure - Earth leakage current(16) Enclosure - Enclosure leakage current(17) Enclosure - Line leakage current(18) Patient leakage current I(19) Patient leakage current II(20) Patient leakage current III
-------------------	---



Note

- The tests applicable to medical MD-F 2020: 6, 7, 8, 9, 10, 11, 12, 13.
 - The tests applicable to medical MD-F 1995: 5, 18, 19, 20.
-

Leakage Current Types	Leakage current measurement modes : DC, AC, AC+DC, AC Peak.
Measurement Range	Automatic/Manual ranges: DC/AC/AC+DC : 50uA/500uA/5mA/50mA (Range : 4uA~50mA) AC Peak : 750uA/7.5mA/75mA (Range : 40uA~75mA)
Operation	<ul style="list-style-type: none"> • Auto/Manual/Programmable Single fault conditions and power supply polarity switch • Measurement/Delay time settings • Maximum / minimum hold • PASS/FAIL(Upper, Lower) Judgement (limits) • Save and recall setup and measurement results • System clock settings • Multilanguage support • System Self test • EUT voltage/current/power consumption • High output alarm and led indicators. • Remote control interface options
Interface	With the exception of the Start, Reset and power switches, the user-interface is entirely controlled via a touch screen.
LCD	The simple, user-friendly interface is extremely intuitive with a large 7.0" color TFT screen.
EUT Test Status	The voltage, current and power consumption of the EUT can be measured.

Memory	<ul style="list-style-type: none">• 30 sets of memory for user defined test conditions• 1000 sets of measurements can be saved/recalled
Remote Interface	There are a variety of remote control interfaces including: RS-232, USB (Host/Device), LAN, EXT I/O connector and GPIB (optional).
Protection	The LED warning indicator will illuminate and emit a tone by default for: <ul style="list-style-type: none">• High Voltages output from the testing terminals.

Basic Theory

- Overview
- GLC-10000 consists of the following blocks as illustrated in the figure below.
 - Tester and EUT power supply
 - MD (Measuring Device) circuit network
 - Current detection
 - Signal Process
 - CPU/Digital control
 - User I/O
 - Remote control interfaces

Block Diagram

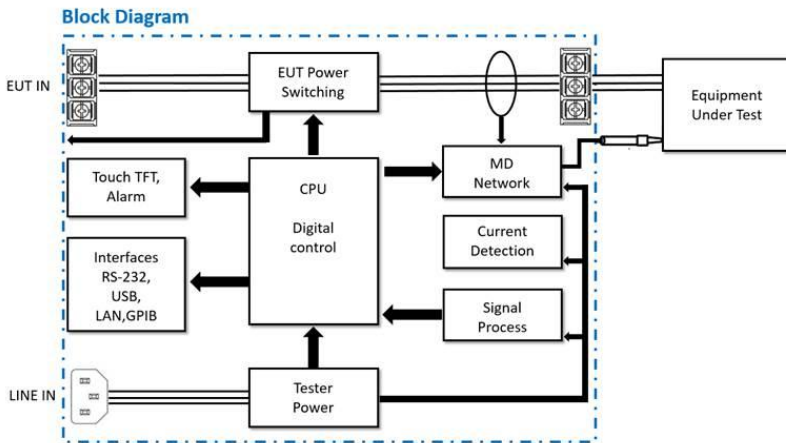

- Power
- Tester Power: Provides the power for tester circuits.
 - EUT Power: Provides an isolated power source to EUT.

EUT Power Switching	This switching matrix controls relays to alter the EUT power to simulate a number of different test conditions, such as earth open or reverse polarity, etc.
MD Network	Different MD networks represent different equivalent circuits of a human body. They are chosen according to different regulations.
Probe	Probes are used to simulate a human-touch-point on the EUT. The leakage current flows through the probe and is measured.
Current detection & signal process.	Detects and measures the different leakage current types (AC,DC,...)
CPU and digital control	CPU, digital circuits and memory.
LCD/ Alarm/Button	The touch-screen LCD, buttons and alarm are controlled by the CPU for user input and display.
Interfaces	Interfaces allow remote control via RS232, USB, LAN and GPIB (optional).

Leakage Current Modes

Definition As illustrated below, the leakage current generated with a high voltage in an electrical appliance requires measurement under normal EUT (Equipment Under Test) conditions and under single fault conditions. Leakage current can be categorized into 3 types: Electric current that flows through the body of someone who touches the equipment, the current that flows through a protective grounding wire to earth and the current that flows through a human body connected to an applied part.

Leakage current can be composed of either conduction current that flows through insulation resistance, or displacement current that flows through distributed capacitance.

Earth Leakage Current

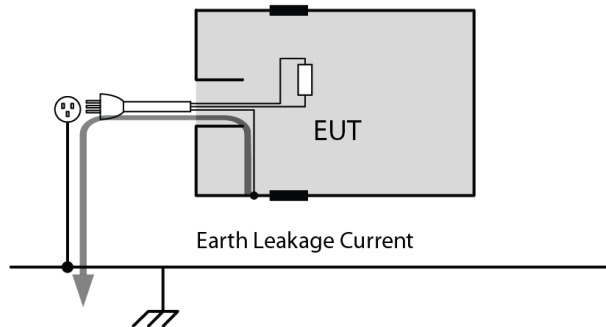

Description

Earth Leakage Current Tests measure the current that flows through a protective grounding wire to earth.

Class I equipment requires the protective grounding wire to be disconnected under single fault conditions.

Leakage current can be dangerous and produce shocks over a certain limit.

(Touch)
Enclosure and
Earth Leakage
Current

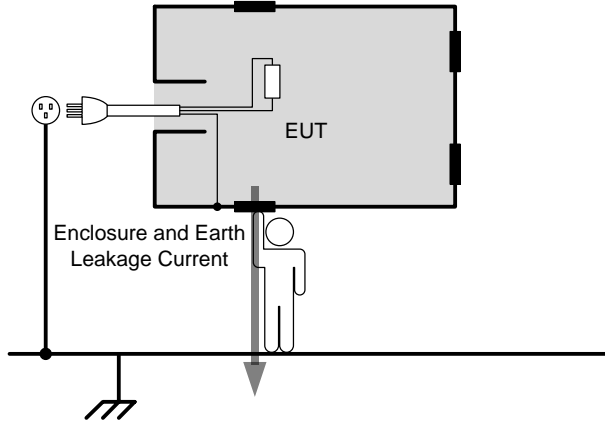

Description

During normal conditions, an operator or a patient is expected to touch the enclosure of an instrument (except for applied parts). The enclosure and earth leakage current test measures the leakage current that flows through a human body to earth when in contact with the instrument enclosure.

For class II equipment, enclosures are ungrounded, and must be tested for leakage current that flows through a human body impedance network to earth. This test also applies to Class I equipment where the enclosure is not grounded.

(Touch)
Enclosure and
Enclosure
Leakage Current

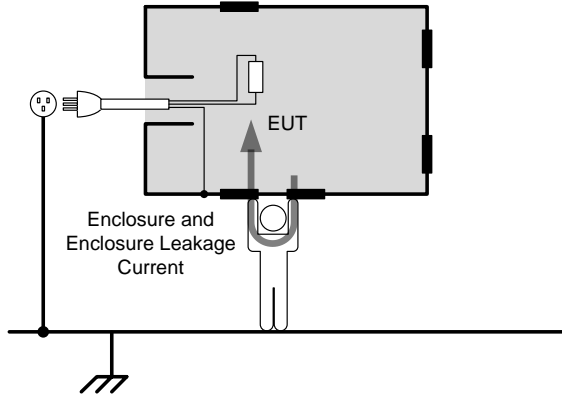

Description

Under normal or single fault conditions, the leakage current that flows through a human body (operator or patient) from any 2 isolated parts of the enclosure.

(Touch)
Enclosure and
Line Leakage
Current

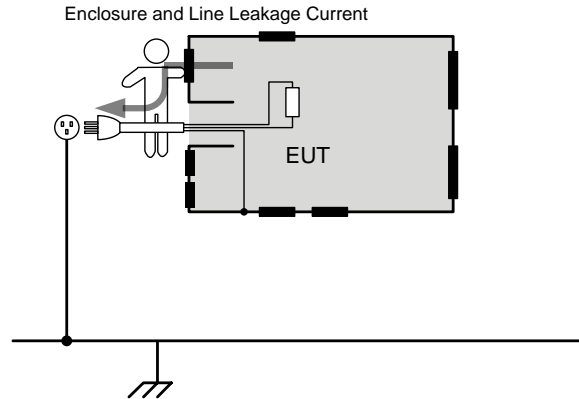

Description

Under normal or single fault conditions, the leakage current that flows through a human body (operator or patient) to Line when in contact with the instrument enclosure.

Patient Auxiliary Current

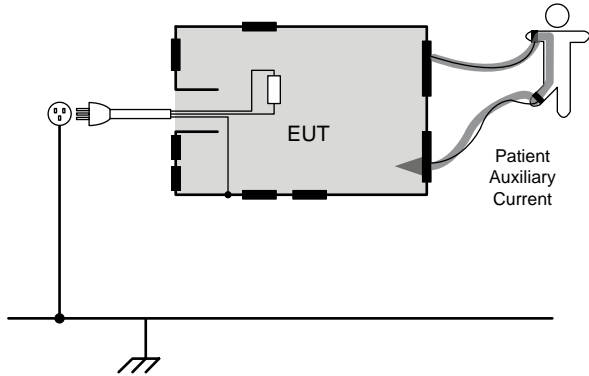

Description

Patient Auxiliary Current is the leakage current that flows through an applied part to human body to applied part. It has nothing to do with type of applied parts or medical equipment class. This measurement is implemented for all medical equipment with multiple applied parts.

Patient connection - Earth Leakage Current
(Patient Leakage Current I)

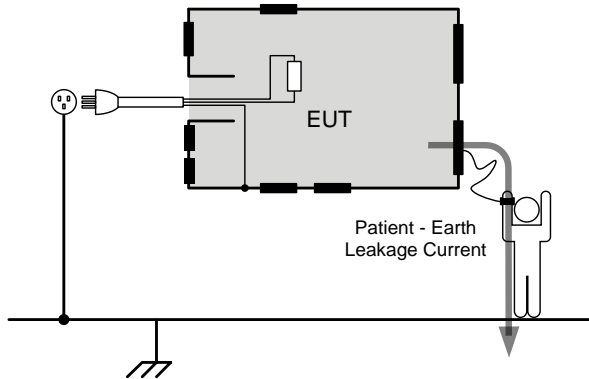

Description

Patient connection - Earth Leakage Current is the leakage current that flows through a person connected to an applied part to earth. It measures medical instruments with applied parts (non F-type) and a signal input/output section.

External Voltage on a SIP/SOP Leakage Current
(Patient Leakage Current II)

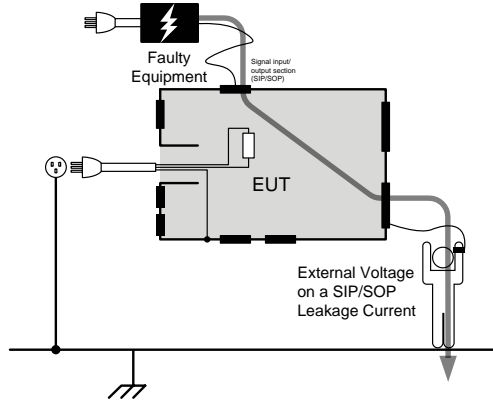

Description

External Voltage on a SIP/SOP Leakage Current refers to the current that flows from an applied part through a human body to earth. It is assumed that an external I/O device that is connected to the signal input of the EUT malfunctions with an output of 110% of the rated voltage.

External Voltage on a Specific F-type Applied Part Leakage Current
(Patient Leakage Current III)

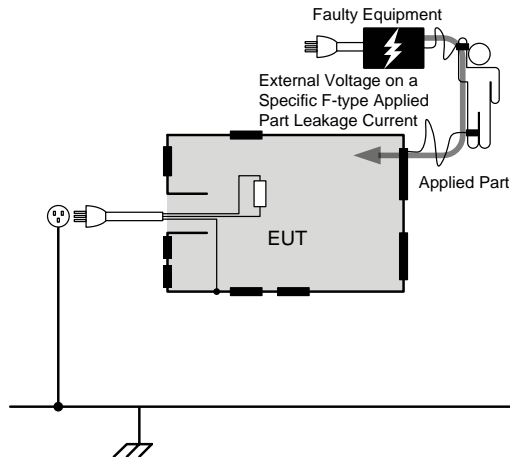

Description

External Voltage on a Specific F-type Applied Part Leakage Current is the leakage current that flows from a malfunctioning applied part, through a person, and through only a F-type applied part.

External Voltage on Metal Accessible Part not Protectively Earthed Leakage Current

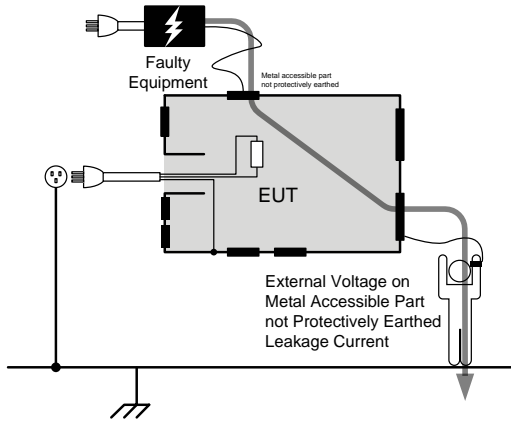

Description External Voltage on a Specific F-type Applied Part Leakage Current is the leakage current that flows from a malfunctioning applied part, through a person, and through only a F-type applied part.

Total Patient Leakage Current

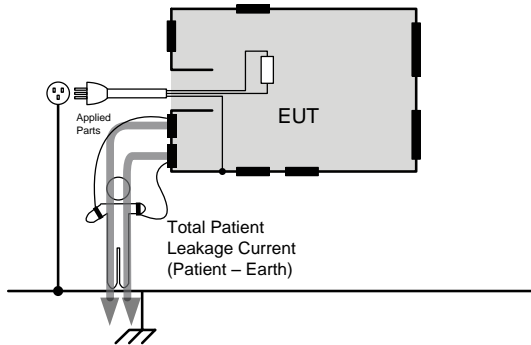

Description Total Patient Leakage Current is the total sum of all leakage current to/from patient connection of the all applied parts of identical type. It is suggested to measure all leakage current components including Patient connection - Earth, External Voltage on a SIP/SOP, External Voltage on a F-type Applied Part and External Voltage on Metal Accessible Part not Protectively Earthed.

Leakage Current Modes

Type	Normal Condition	Single Fault	Fault Description	Notes
Earth Leakage Current	Yes	Yes	1. Power line disconnected.	1.Functional grounding wire is disconnected (Class I only) 2.Grounding wire for patient connection and power supply circuit for measurement are disconnected (Class I only)
(Touch) Enclosure to Earth Leakage Current	Yes	Yes		Situation other than touch current (Enclosure - Line) is applicable 1. Functional grounding wire is disconnected
(Touch) Enclosure to Enclosure Leakage Current	Yes	Yes	1. Power line disconnected. 2. protective earth conductor is disconnected*	2. Grounding wire for patient connection and power supply circuit for measurement are disconnected
(Touch) Enclosure to Line Leakage Current	Yes	Yes		3. A voltage that is 110% of the rated voltage is applied between an isolated signal input/output section and earth (Not medical equipment)
Patient Auxiliary Current	Yes	Yes	1. Power Line disconnected. 2. The protective earth conductor is disconnected.	1.Functional grounding wire is disconnected





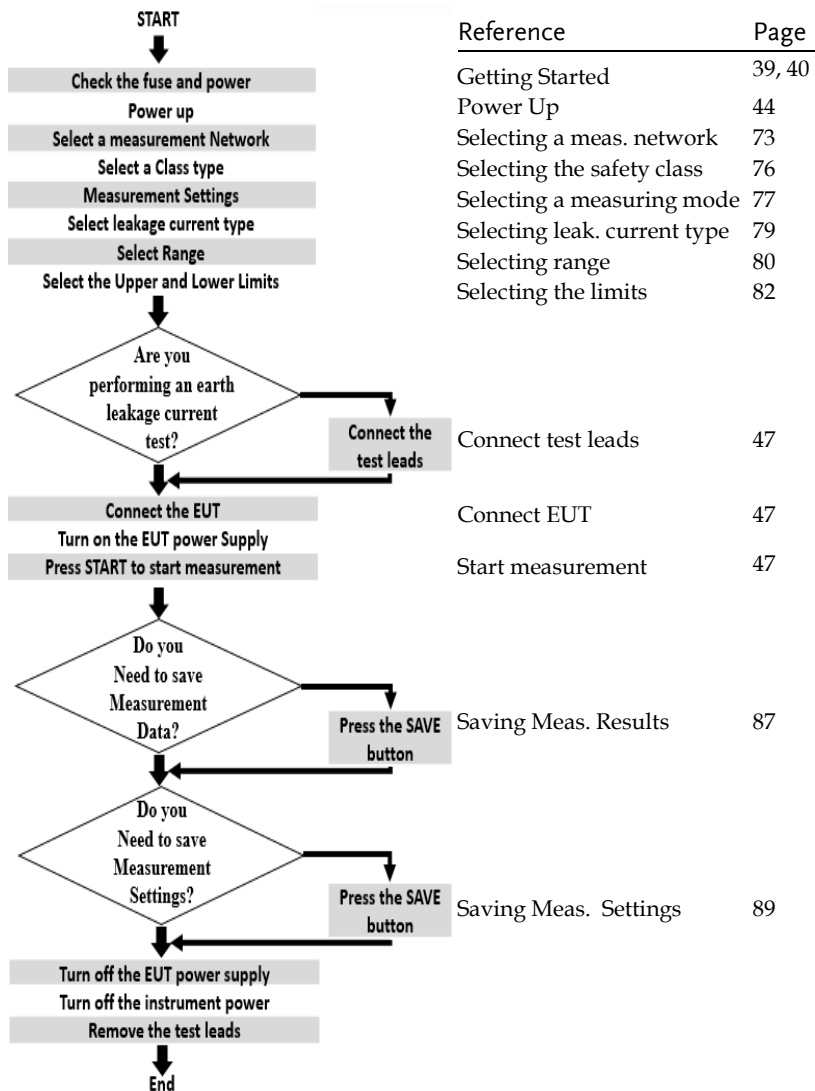

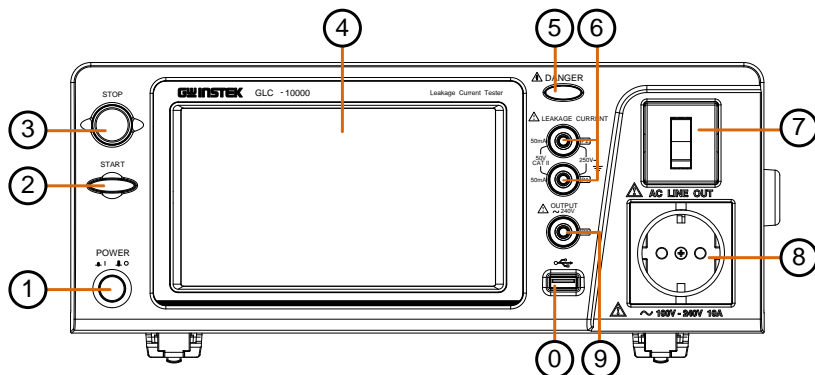

Patient Leakage Current (Patient Connection - Earth)/ (Patient Leakage Current I)	Yes	Yes	<ol style="list-style-type: none"> 1. Power Line disconnected. 2. The protective earth conductor is disconnected. 	<ol style="list-style-type: none"> 1 Functional grounding wire is disconnected 2. Grounding wire for patient connection and power supply circuit for measurement are disconnected
Patient Leakage Current (External Voltage on a SIP/SOP)/ (Patient Leakage Current II)	Yes	Yes	<ol style="list-style-type: none"> 1. Power Line disconnected. 2. The protective earth conductor is disconnected. 	<ol style="list-style-type: none"> 1. Functional grounding wire is disconnected 2. Metal accessible part not protectively earthed and grounding wire is disconnected 3. A voltage that is 110% of the rated voltage is applied between an isolated signal input/output section and earth
Patient Leakage Current (External Voltage on a Specific F-Type Applied Part)/ (Patient Leakage Current III)	No	No		<ol style="list-style-type: none"> 1. A voltage that is 110% of the rated voltage is applied between an F-applied part and earth. (Does not qualify as a single fault condition under IEC 60601-1: 2005 3rd Edition.) 2. Metal accessible part not protectively earthed and grounding wire is disconnected 3. Functional grounding wire is disconnected
Patient Leakage Current (External Voltage on Metal Accessible Part not Protectively Earthed)	No	No	<ol style="list-style-type: none"> 1.The protective earth conductor is disconnected. 	<ol style="list-style-type: none"> 1. Applied to metal accessible part not protectively earthed 2. Functional grounding wire is disconnected

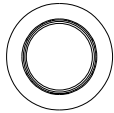
Measurement Flow Chart

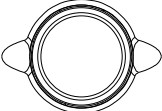

Front Panel



Item		Description
1. POWER	<p>POWER</p>  	<p>The power switch turns the power on or off.</p> <p> : ON</p> <p> : OFF</p>
2. START	<p>START</p> 	<p>The green START button starts measurements.</p>
3. STOP	<p>STOP</p> 	<p>The red STOP button stops measurements.</p>
4. Display		<p>7" inch touch screen LCD display. The touch screen display is the primary user interface.</p>
5. Warning Indicator	<p> DANGER</p> 	<p>The warning indicator lights up when high voltages are produced from terminals P1, P2 or P3. The warning indicator will flash when in standby mode.</p>

6. Measuring Terminals

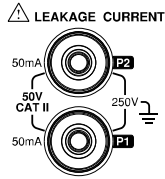

Measuring Terminals P1 and P2 are used to measure leakage current. Terminal P2 has a replaceable fuse (250V, 50mA).

7. Circuit Breaker

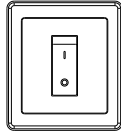

The circuit breaker has over-current protection for the EUT rated at 20A. When testing, the warning indicator will illuminate.

I: ON, normal operation

O: OFF, inactive or during over-current protection.

8. EUT AC Power Output Socket (European)

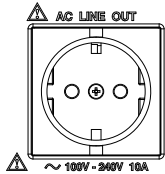

Supplies AC power for the EUT. Includes automatic shut-down (circuit breaker) with over-current protection. Maximum current output 10A, maximum power output, 1500VA.

EUT AC Power Output Socket (General)

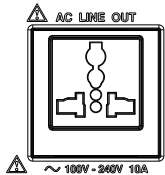

Note

For the EUT AC Terminal Block, the Live (L) and Neutral (N) line inputs are user-defined. Press *System>EUT Outlet* to configure the Live and Neutral line inputs.

9. P3 110% Voltage Application

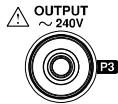

An isolated voltage (1:1) is output to P3 from the EUT AC IN voltage by an isolation transformer. This terminal is limited to medical networks (MD:F)

10. USB Host

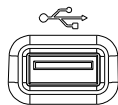

USB host terminal connects with USB flash drive for data storage or screenshot hardcopy.

Rear Panel

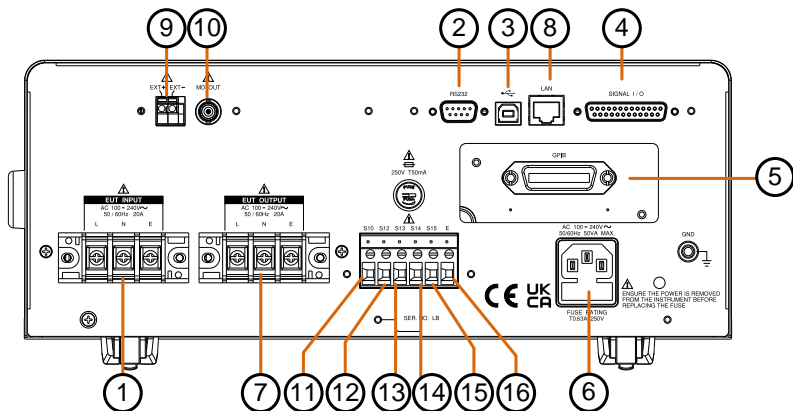

ITEM		Description
1. EUT AC Input Terminal		EUT AC inlet. AC voltage range: 100V~240V ±10%, 50/60Hz, 20A Max
2. RS-232 Port	RS232 	RS-232 interface for remote control.
3. USB Port		USB terminal for remote control.
4. SIGNAL I/O Connector	SIGNAL I/O 	External input/output remote control connector.
5. GPIB Connector	GPIB 	GPIB interface for remote control.

6. Power Socket/
Fuse socket

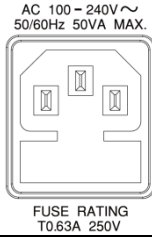

The power socket accepts AC mains power for the GLC-10000.

Power: AC 100V~240V
±10%, 50/60Hz
Fuse: T0.63A/250V

7. EUT AC Output Terminal

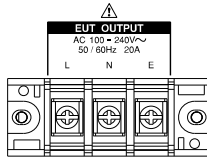

Supplies AC power for the EUT.

AC voltage range: 100V~240V AC, 50/60Hz, 20A Max

8. LAN Port



The Ethernet LAN port for remote control.

9. External MD Module Connector

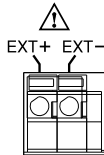

It is able to connect with an external MD module, which can be configured to a measuring device of two-pole or a measuring device of resistive, to expand more applications.

10. External BNC MD Output Port



Through BNC port, GLC-10000 outputs signal on display of connected oscilloscope or voltage meter for MD circuit verification.

11. S10
Terminal

It connects with earth terminal to earthed point of measuring supply system.

12. S12
Terminal

It connects with patient connection to earthed point of measuring supply circuit.

13. S13
Terminal

It connects with earth connection for metal accessible part not protectively earthed.

14. S14
Terminal

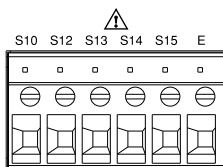

It acts a switch to connect or disconnect with patient connection to/from earth.

15. S15
Terminal

It provides connection to earth a metal plate of a non-conductive enclosure.

16. E Terminal

It connects with earth of Line In. It is Not allowed to change due to permanent connection property

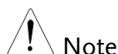

Note

Only when MD F network is chosen, the setting can therefore be enabled.

Touch Screen Basics



Caution

Do not use any sharp objects or excessive pressure on the touch screen display, doing so may damage the display.

Description

The LCD touch panel is used to configure system and measurement settings. Touching an on-screen icon mimics the action of pressing a button on traditional machines. Touching an on-screen icon is referred to as pressing a key in this manual.

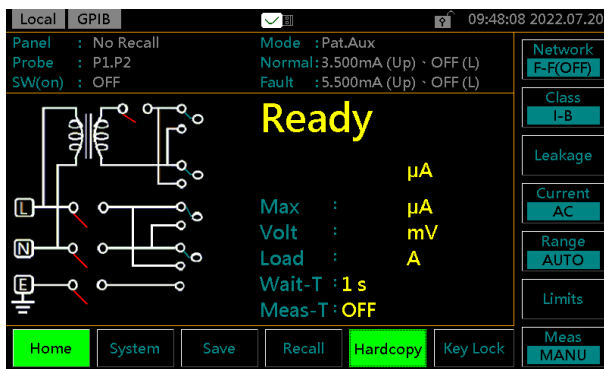

Any keys or icons that are dimmed indicate currently unavailable menus, icons or areas. This is shown in the screen capture below.



GETTING STARTED

This chapter describes the GLC-10000 in a nutshell, including the main features, front and rear panel descriptions, and the power up sequence.

Preparation

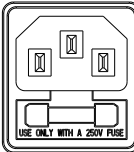
Fuse	Ensure the correct fuse is used before power up. (Fuse: T0.63A/250V)	
------	--	---

EUT AC Line In	<p>Before connecting power to the EUT AC Line In, confirm the EUT input power and test requirements do not exceed the EUT AC Line In requirements.</p> <p>Voltage Range: AC 100V~ 240V ±10%, 50/60Hz</p>
----------------	--



* EUT : 20A(max), at maximum load 15min



EUT Power wiring

Note the position of the live and neutral line inputs for the EUT AC Input terminal, EUT AC Power Output socket and EUT AC Output terminal. Failing to connect EUT power input properly will affect the measurement accuracy.

As the EUT AC Power Output Socket is designed for multiple regions, it has user-defined live and neutral inputs. To configure the L & N input to your region, see the *System>EUT Outlet* menu.

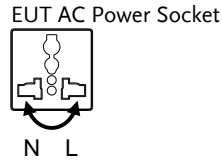

Power and Probe Connection

Mains Power Socket

1. Ensure the power is switched off from the front panel.
2. Insert the AC mains power into the power socket on the right side of rear panel.

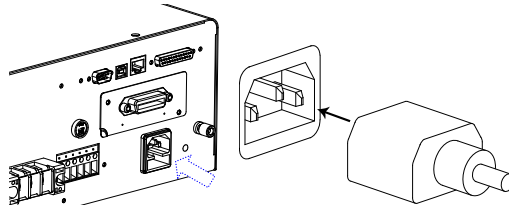

The arrow above shows the location of the AC main power socket.

EUT AC Input Terminal

1. Ensure the power switch is off on the front panel.
2. Connect the AC power wires to the EUT AC Input terminal on the left side of rear panel.

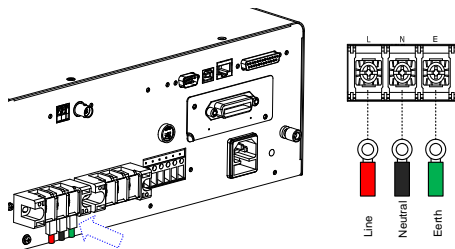

The arrow above shows the EUT AC Input terminal located on the left side of rear panel.



If network B (MD B) is selected an isolation transformer that outputs 110% of the rated voltage specified for the EUT is required. The neutral line must be grounded (from the secondary side of the transformer).

Measurement networks (MD)A, B, C all require an isolation transformer.

EUT AC Power Output Socket

1. Ensure the power switch is off on the front panel.
2. Inset power plug from EUT into the EUT AC Power Output socket in the front panel

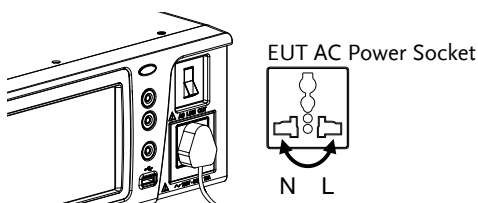

As the EUT AC Power Output Socket is designed for multiple regions, it has user-defined live and neutral inputs. To configure the L & N input to your region, see page 104.

EUT AC Output Terminal

1. Ensure the power switch is off on the front panel.
2. Connect the AC power wires from EUT to the EUT AC Output terminal on the left side of rear panel.

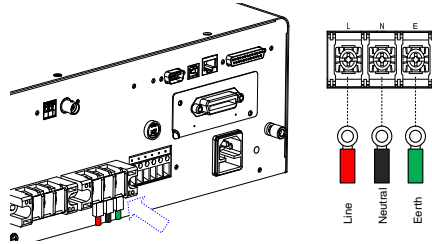

The arrow above shows the EUT AC Output terminal located in the midst of rear panel.



Caution

If network B (MD B) is selected an isolation transformer that outputs 110% of the rated voltage specified for the EUT is required. The neutral line must be grounded (from the secondary side of the transformer).

Measurement networks (MD)A, B, C all require an isolation transformer.

P1/P2/P3 Terminals

1. Insert the test leads to one of the terminals
2. The measuring mode determines which terminal will be used.

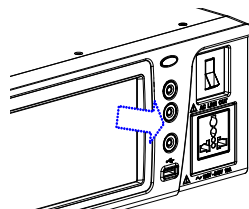

Terminals P1, P2 and P3 are shown above.



To avoid the risk of electric shock, do not touch the tips of the test leads when operating.

Foil Probe

1. The foil probe is used to measure the surface leakage current (touch current) of the EUT. Attach the probe metal-foil-side down onto the enclosure of the EUT.
2. Attach the test leads to the foil probe using alligator clips to the area on the right, as shown in the diagram

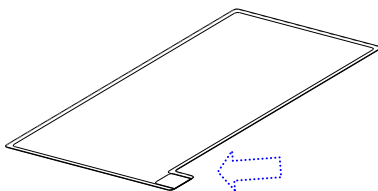

The arrow above shows the contact point for the test lead.

Alligator Clips

1. Plug a test lead into the rear panel.
2. Use an alligator clip to clip to the metal foil or to other points under test.

The arrow mark indicates the location that the test lead and alligator clips are clipped together.

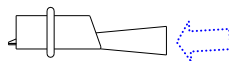

Tilt the Stand and Hand Carry

Horizontal position

Place the unit on a flat surface horizontally.

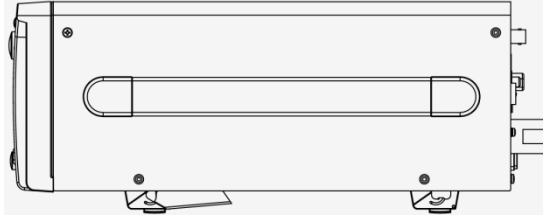

Tilt stand position

Gently pull the 2 stands out from the bottom and the unit will be placed in the tilt stand position.

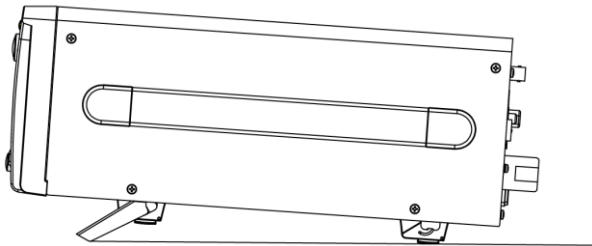

Hand Carry

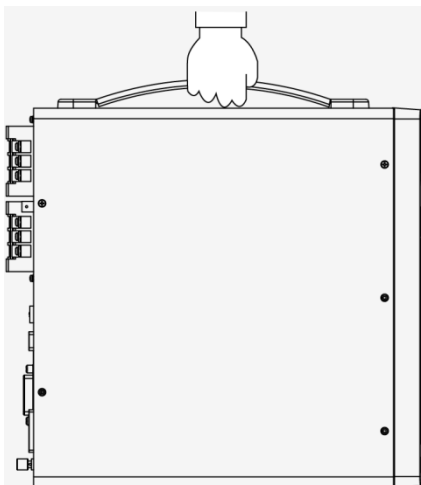

Power Up

Power Up

Press the power switch to turn on the power. The system will enter the measurement interface after a quick initialization.

POWER

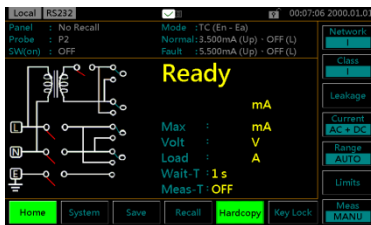

Steps

1. Turn on the power switch. Ensure the EUT power switch is off.
2. The GLC-10000 will load the last panel setting before the last shut down.
3. Wait for the machine to warm up for 30 minutes before operating.

Shut Down

Before shutdown, ensure the EUT is shut down properly. As illustrated below, power off the circuit breaker before turning off the equipment.

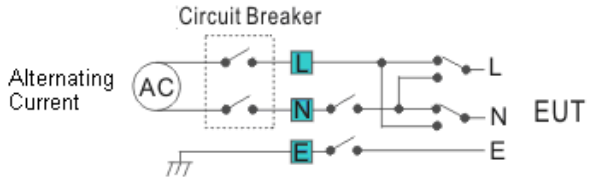

EUT Power Down Ensure the circuit breaker is turned off.

I : ON

O : OFF

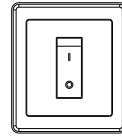

Power Down Turn off the power switch.

POWER
■ | ■ ○

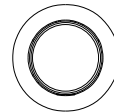

O PERATION

Measurement Terminals

When a measurement network is selected, different measuring terminals are required for each test and equipment class. The following tables list which terminals are used for with which network/test.

Non-medical Network (General Electrical Appliance)

MD-A, B, E, H, I

	CLASS I	CLASS II	Internal Power Supply
Earth Leakage Current	—	—	—
(Touch) Enclosure and Earth Leakage Current	P2	P2	P2
(Touch) Enclosure and Enclosure Leakage Current	P1, P2	P1, P2	P1, P2
(Touch) Enclosure and Line Leakage Current (Selected line Internal)	P2	P2	—
(Touch) Enclosure and Line Leakage Current (Selected line External)	P1, P2	P1, P2	—
Free Current	P1, P2	P1, P2	P1, P2

MD- C1, C2, C3, D, G

	CLASS I	CLASS II	Internal Power Supply
Earth Leakage Current	—	—	—
(Touch) Enclosure and Earth Leakage Current	P2	P2	P2
(Touch) Enclosure and Enclosure Leakage Current	P1, P2	P1, P2	P1, P2
(Touch) Enclosure and Line Leakage Current (Selected line Internal)	P2	P2	—
(Touch) Enclosure and Line Leakage Current (Selected line External)	P1, P2	P1, P2	—

Medical Equipment

MD-F

		CLASS I			CLASS II			Internal Power		
		Type B	Type BF	Type CF	Type B	Type BF	Type CF	Type B	Type BF	Type CF
Earth Leakage Current		—			—			—		
(Touch) Enclosure and Earth Leakage Current	Normal	P2	P2	P2	P2	P2	P2	P2	P2	P2
	Fault	P2, P3	P2, P3	P2, P3	P2, P3	P2, P3	P2, P3	P2, P3	P2, P3	P2, P3
(Touch) Enclosure and Enclosure Leakage Current	Normal	P1, P2	P1, P2	P1, P2	P1, P2	P1, P2	P1, P2	P1, P2	P1, P2	P1, P2
	Fault	P1, P2, P3	P1, P2, P3	P1, P2, P3	P1, P2, P3	P1, P2, P3	P1, P2, P3	P1, P2, P3	P1, P2, P3	P1, P2, P3
Patient Auxiliary Current		P1, P2	P1, P2	P1, P2	P1, P2	P1, P2	P1, P2	P1, P2	P1, P2	P1, P2
Patient Leakage Current (Patient Connection - Earth)		P2	P2	P2	P2	P2	P2	P1, P2 or P2	P1, P2 or P2	P1, P2 or P2
Patient Leakage Current (External Voltage on a SIP/SOP)		P2, P3	P2, P3	P2, P3	P2, P3	P2, P3	P2, P3	P2, P3	P2, P3	P2, P3
Patient Leakage Current (External Voltage on a Specific F-Type Applied Part)		—	P2	P2	—	P2	P2	—	P2	P2
Patient Leakage Current (External Voltage on Metal Accessible Part not Protectively Earthed)		P2, P3	P2, P3	—	P2, P3	P2, P3	—	P2, P3	P2, P3	—
Total Patient Leakage Current (Patient Connection - Earth)		P2	P2	P2	P2	P2	P2	P1, P2	P1, P2	P1, P2
Total Patient Leakage Current (External Voltage on a SIP/SOP)		P2, P3	P2, P3	P2, P3	P2, P3	P2, P3	P2, P3	P2, P3	P2, P3	P2, P3
Total Patient Leakage Current (External Voltage on a Specific F-Type Applied Part)		—	P2	P2	—	P2	P2	—	P2	P2
Total Patient Leakage Current (External Voltage on Metal Accessible Part not Protectively Earthed)		P2, P3	P2, P3	—	P2, P3	P2, P3	—	P2, P3	P2, P3	—
Free Current	Normal	P1, P2	P1, P2	P1, P2	P1, P2	P1, P2	P1, P2	P1, P2	P1, P2	P1, P2
	Fault	P1, P2, P3	P1, P2, P3	P1, P2, P3	P1, P2, P3	P1, P2, P3	P1, P2, P3	P1, P2, P3	P1, P2, P3	P1, P2, P3

Earth Leakage Current

Network Non medical network / Medical network

Connection 1. Connect the EUT power cord to the GLC-10000 as shown in the diagram below.

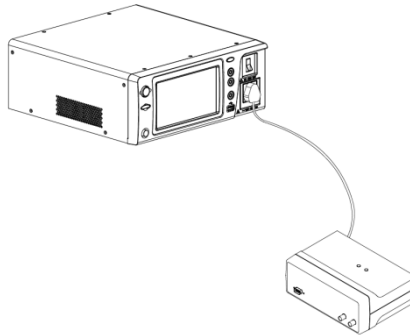

Measurement Setup Confirm all settings including MD, leakage current mode, measurement time, upper and lower limits, and other parameters.

Panel Operation 2. Turn on the circuit breaker. Connect the EUT power terminal.

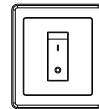

3. Press the START button to start measurements.

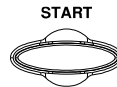

4. Press the STOP button to stop measurement.

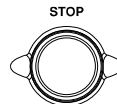

Warning

Turn the circuit breaker off before removing the EUT. Ensure the power consumption of the EUT doesn't exceed the rated power limits.

(Touch) Enclosure - Earth Leakage Current

Network	Non medical network / Medical network
Connection	As illustrated, ensure that the power source and test leads are properly connected.
Non-Medical Network	<ol style="list-style-type: none"> 1. Connect the test lead to terminal P2. 2. Position the test lead on an ungrounded section of the enclosure

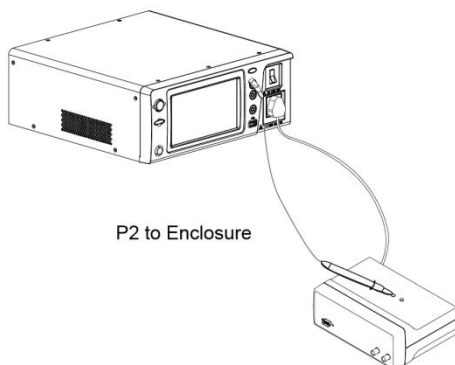

Non-medical type (General electrical equipment)

Medical Network	<ol style="list-style-type: none"> 1. Connect a test lead to the P2 terminal and position the test lead on an ungrounded section of the enclosure. 2. Connect a test lead to the P3 terminal and position the test lead on an ungrounded section of signal I/O on the EUT.
-----------------	--

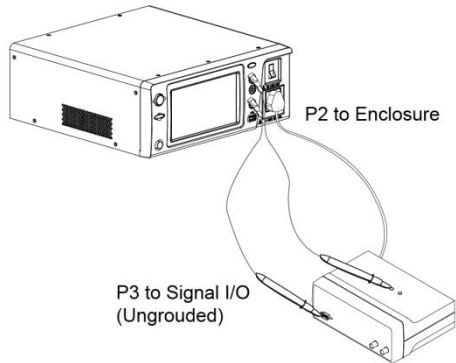

Medical type (MD-F) Requires 110% power supply voltage output.



The P3 terminal is high voltage. Avoid contact with the terminal. The P3 terminal should not be connected with an earth conductor.

Measurement Setup

Confirm all settings including MD, leakage current mode, measurement time, upper and lower limits, and other parameters.

Panel Operation

3. Turn on the circuit breaker. Connect the EUT to the power socket.
4. Press the START button to start measurements.
5. Press the reset button to stop measurement.

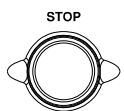
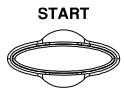
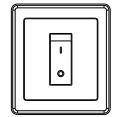

Warning

Turn the circuit breaker off before removing the EUT. Ensure the power consumption of the EUT doesn't exceed the rated power limits.

(Touch) Enclosure - Enclosure Leakage Current

Network	Non medical network / Medical network
---------	---------------------------------------

Connection	As illustrated, ensure that the power source and test leads are properly connected.
------------	---

- | | |
|---------------------|--|
| Non-Medical network | <ol style="list-style-type: none"> 1. Connect the tests lead to terminals P1& P2. 2. Position the test leads on un-grounded sections of the enclosure. |
|---------------------|--|

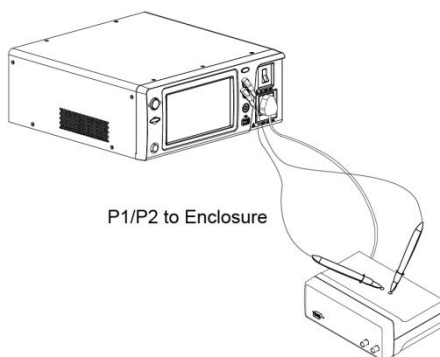

Non-medical type (General electrical equipment)

- | | |
|-----------------|--|
| Medical Network | <ol style="list-style-type: none"> 1. Connect the test leads to the P1 & P2 terminals and position the test leads on ungrounded sections of the enclosure. 2. Connect a test lead to the P3 terminal and position the test lead on an ungrounded section of signal I/O on the EUT. |
|-----------------|--|

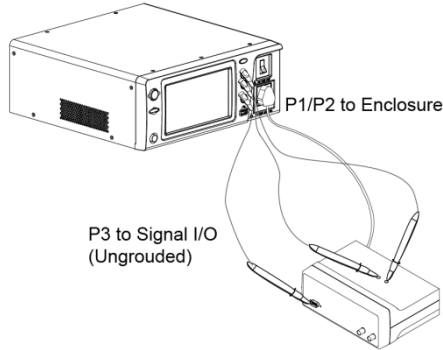

Medical type (MD-F) Requires 110% power supply voltage output.



The P3 terminal is high voltage. Avoid contact with the terminal. The P3 terminal should not be connected with an earth conductor.

Measurement Setup

Confirm all settings including MD, leakage current mode, measurement time, upper and lower limits, and other parameters.

Panel Operation

3. Turn on the circuit breaker. Connect the EUT to the power socket.

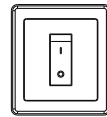

4. Press the START button to start measurements.

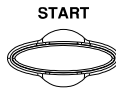

5. Press the reset button to stop measurement.

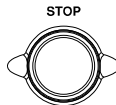

Warning

Turn the circuit breaker off before removing the EUT. Ensure the power consumption of the EUT doesn't exceed the rated power limits.

(Touch) Enclosure - Line Leakage Current

Network Non medical network / Medical network

Connection As illustrated below, ensure that the power source and test leads are properly connected.

Non Medical Network 1. Connect the test lead to P2 terminal. Position the test lead on an ungrounded section of the enclosure.

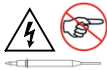
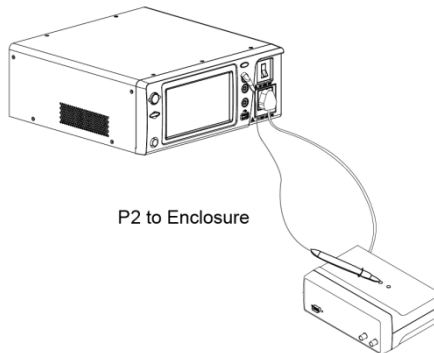

The P2 terminal is high voltage. Avoid contact with the terminal. The P2 terminal should not be connected with an earth conductor.

Measurement Setup Confirm all settings including MD, leakage current mode, measurement time, upper and lower limits, and other parameters.

Panel Operation 2. Turn on the circuit breaker. Connect the EUT power terminal.

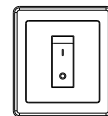

3. Press the START button to start measurements.

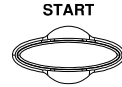

4. Press the reset button to stop measurement.

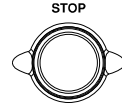

Warning

Turn the circuit breaker off before removing the EUT.

Ensure the power consumption of the EUT doesn't exceed the rated power limits.

Note

This test is equipped with ground (earth) fault detection. (A ground fault check is performed prior to measurement. Measurement is aborted if a ground fault is detected.)

Patient Auxiliary Current

Network Medical network

Connection As illustrated below, ensure that the power source and test leads are properly connected.

- Medical Network
1. Connect the test leads to the P1 and P2 terminals.

 2. Position the test leads to the applied part of the EUT.

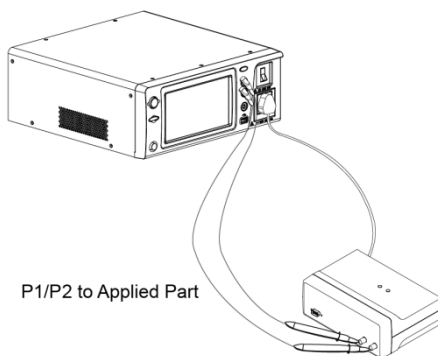

Measurement Setup Confirm all settings including MD, leakage current mode, measurement time, upper and lower limits, and other parameters.

- Panel Operation
3. Turn on the circuit breaker. Connect the EUT power terminal.

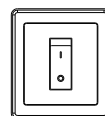

4. Press the START button to start measurements.



5. Press the reset button to stop measurement.

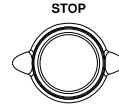

Warning

Turn the circuit breaker off before removing the EUT. Ensure the power consumption of the EUT doesn't exceed the rated power limits.

Patient Connection - Earth Leakage Current (Patient Leakage Current I)

Network	Medical network, (MD-F) for the applied part. Applicable for internal power supply and Class I and Class II types.
---------	--

Connection	As illustrated, ensure that the power source and test leads are properly connected.
------------	---

Internal Power Supply	<ol style="list-style-type: none"> 1. Connect the test leads to the P1 and P2 terminals. 2. Position the P1 test lead to an ungrounded section of the enclosure. 3. Position the P2 test lead to the applied part of the EUT.
-----------------------	--

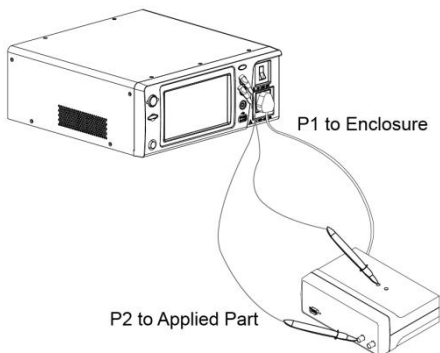

Medical network (Internal power supply)

- Class I/Class II
1. Position the P2 test lead to the applied part of the EUT.

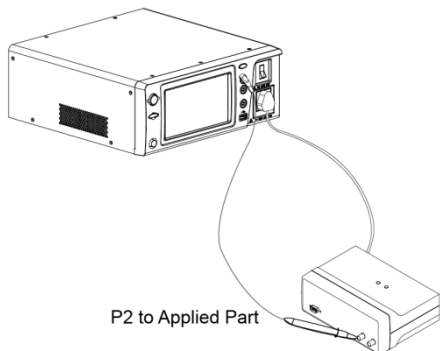

Medical network (Class I and Class II)

- Measurement Setup
- Confirm all settings including MD, leakage current mode, measurement time, upper and lower limits, and other parameters.

- Panel Operation
2. Turn on the circuit breaker.
Connect the EUT to the power socket.

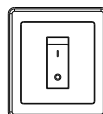

3. Press the START button to start measurements.

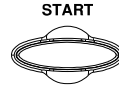

4. Press the reset button to stop measurement.

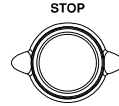

Warning

Turn the circuit breaker off before removing the EUT. Ensure the power consumption of the EUT doesn't exceed the rated power limits.

Enternal Voltage on a SIP/SOP Leakage Current (Patient Leakage Current II)

Network For medical network circuits only (MD-F), type B only.

Connection As illustrated, ensure that the power source and test leads are properly connected.

- Type B Medical Network**
1. Connect the test leads to the P2 & P3 terminals and position the P2 test lead to the applied part of the EUT.
 2. Position the P3 test lead on an ungrounded section of the signal I/O on the EUT.

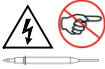
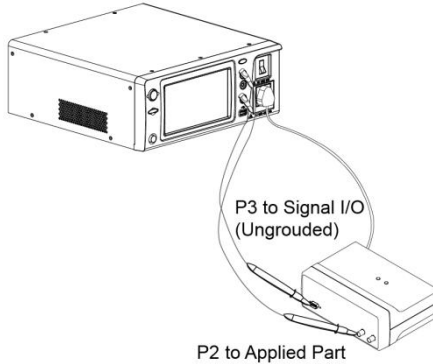

The P3 terminal is high voltage. Avoid contact with the terminal. The P3 terminal should not be connected with an earth conductor.

Measurement Setup

Confirm all settings including MD, leakage current mode, measurement time, upper and lower limits, and other parameters.

Panel Operation

3. Turn on the circuit breaker. Connect the EUT to the power socket.

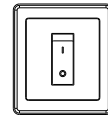

4. Press the START button to start measurements.

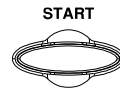

5. Press the reset button to stop measurement.

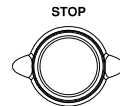

Warning

Turn the circuit breaker off before removing the EUT. Ensure the power consumption of the EUT doesn't exceed the rated power limits.

External Voltage on a Specific F-type Applied Part Leakage Current (Patient Leakage Current III)

Network For medical network circuits only (MD-F), type F only.

Connection As illustrated, ensure that the power source and test leads are properly connected.

Type F Medical Network 1. Connect the test lead to the P2 terminal and position the test lead to the applied part of the EUT.

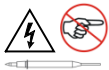
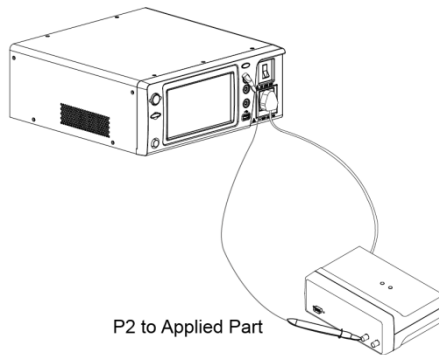

The P2 terminal is high voltage. Avoid contact with the terminal. The P2 terminal should not be connected with an earth conductor.

Measurement Setup Confirm all settings including MD, leakage current mode, measurement time, upper and lower limits, and other parameters.

Panel Operation 2. Turn on the circuit breaker. Connect the EUT to the power socket.

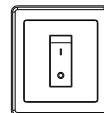

3. Press the START button to start measurements.

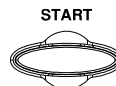

4. Press the reset button to stop measurement.

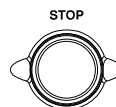

Warning

Turn the circuit breaker off before removing the EUT.

Ensure the power consumption of the EUT doesn't exceed the rated power limits.

External Voltage on Metal Accesible Part not Protectively Earthed Leakage Current

Network	For medical network circuits only (MD-F), type B only.
Connection	As illustrated, ensure that the power source and test leads are properly connected.
Type B Medical Network	<ol style="list-style-type: none"> 1. Connect the test leads to the P2 & P3 terminals and position the P2 test lead to the applied part of the EUT. 2. Position the P3 test lead on an ungrounded section of the signal I/O on the EUT.

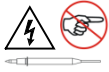
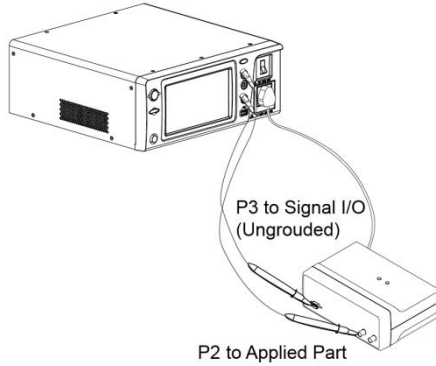

The P3 terminal is high voltage. Avoid contact with the terminal. The P3 terminal should not be connected with an earth conductor.

Measurement Setup

Confirm all settings including MD, leakage current mode, measurement time, upper and lower limits, and other parameters.

Panel Operation

3. Turn on the circuit breaker. Connect the EUT to the power socket.
4. Press the START button to start measurements.
5. Press the reset button to stop measurement.

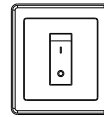

START



STOP

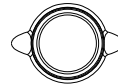

Warning

Turn the circuit breaker off before removing the EUT.

Ensure the power consumption of the EUT doesn't exceed the rated power limits.

Total Patient Leakage Current (Patient Connection – Earth)

Network	Medical network, (MD-F) for the applied part. Applicable for Class I and Class II types.
Connection	As illustrated, ensure that the power source and test leads are properly connected.
Class I/Class II	<ol style="list-style-type: none"> 1. Connect the test lead to the P2 terminal and position the test lead to the jig for measuring leakage current. 2. Put the applied parts of all the EUTs in contact with each other. 3. Position the test lead on the applied parts of EUT.
Measurement Setup	Confirm all settings including MD, leakage current mode, measurement time, upper and lower limits, and other parameters.
Panel Operation	<ol style="list-style-type: none"> 4. Turn on the circuit breaker. Connect the EUT to the power socket. 5. Press the START button to start measurements. 6. Press the reset button to stop measurement. 7. Note that any result of measurement within the permissible value is passable.

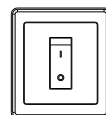

START



STOP

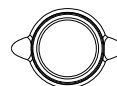



Warning

Turn the circuit breaker off before removing the EUT.

Ensure the power consumption of the EUT doesn't exceed the rated power limits.

It is required to prepare a jig specific for the applied parts of EUT since GLC-10000 is Not able to measure leakage current for all applied parts.

Free Current (Enclosure – Enclosure)

Network	Non medical network
---------	---------------------

Connection	As illustrated, ensure that the power source and test leads are properly connected.
------------	---

- | | |
|---------------------|--|
| Non-Medical network | <ol style="list-style-type: none"> 1. Connect the tests lead to terminals P1& P2. 2. Position the test leads on un-grounded sections of the enclosure. |
|---------------------|--|

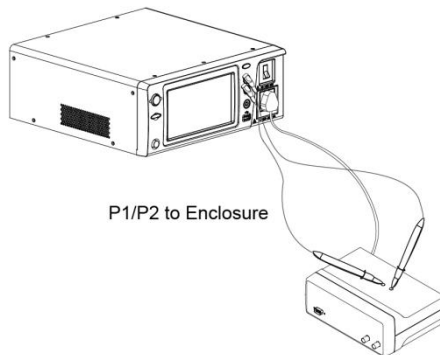

Non-medical type (General electrical equipment)

Measurement Setup	Confirm all settings including MD, leakage current mode, measurement time, upper and lower limits, and other parameters.
-------------------	--

Panel Operation 3. Turn on the circuit breaker.
Connect the EUT to the power socket.

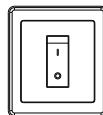

4. Press the START button to start measurements.



5. Press the reset button to stop measurement.

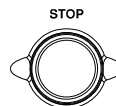

Warning

Turn the circuit breaker off before removing the EUT.
Ensure the power consumption of the EUT doesn't exceed the rated power limits.

M EASUREMENT

Interface of Home Screen

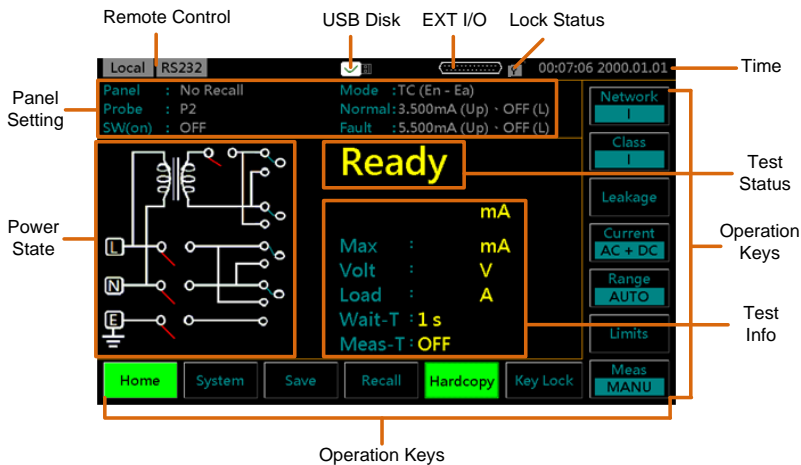

Main Display

Panel Setting	Panel	Shows the currently loaded panel setting. It appears “No Recall” when none of panel settings is selected. See page 92 for details of Recall setting.
	Probe	Shows the probe terminal used for the current measuring network. See page 47 for details.
	SW(on)	It indicates if the function(s) of SW terminals is activated, which is specifically associated with medical measurements. Refer to page 37 for the descriptions of SW terminals.

- Mode It shows the selected Leakage mode as follows:
- **Earth Leak:** Earth leakage current
 - **TC (En - Ea):** Touch current (Enclosure - Earth)
 - **En - Ea Leak:** Enclosure - Earth leakage current
 - **TC (En - En):** Touch current (Enclosure - Enclosure)
 - **En - En Leak:** Enclosure - Enclosure leakage current
 - **TC (En - Li):** Touch current (Enclosure - Line)
 - **En - Li Leak:** Enclosure - Line leakage current
 - **Pat. Aux:** Patient auxiliary current
 - **PL (Pa - Ea):** Patient leakage current (Patient connection - Earth)
 - **Pat. Leak I:** Patient leakage current I
 - **PL (SIP/SOP):** Patient leakage current (external voltage on a SIP/SOP)
 - **Pat. Leak II:** Patient leakage current II
 - **PL (F):** Patient leakage current (external voltage on a specific F-type applied part)
 - **Pat. Leak III:** Patient leakage current III
 - **PL (MP):** Patient leakage current (external voltage on a metal accessible part not protectively earthed)
 - **TPL (Pa - Ea):** Total Patient leakage current (Patient connection - Earth)
 - **TPL (SIP/SIP):** Total Patient leakage current (external voltage on a SIP/SOP)
 - **TPL (F):** Total Patient leakage current (external voltage on a specific F-type applied part)
 - **TPL (MP):** Total Patient leakage current (external voltage on a metal accessible part not protectively earthed)
 - **Free:** Free current

Normal	Displays the Normal upper and lower test limits respectively.
Fault	Displays the Fault upper and lower test limits respectively.

Power State	Displays the current power state settings.
-------------	--

Test Status	Displays the status of the test. See the following for details.
Wait	Occurs for specific time in accordance with the set Wait Time. See page 83 for details.
Ready	Occurs when the GLC-10000 is powered up or when the measurement network, class or leakage current mode is chosen.
Test	Press the Start button while in Ready status to enter Test mode.
Pass	Occurs when test is judged Pass, which means the measured value is within the range of set upper and lower limits.
Fail	Occurs when test is judged Fail, which means the measured value is either beyond or below the range of set upper and lower limits.

Test Info	Displays the measured values and relevant settings of the test. See the following for details.
Max	Indicates the measured maximum value.
Volt	Indicates the measured volt value.
Load	Indicates the measured load value.
Wait-T	Displays the wait time before a test commences.
Meas-T	Displays the Measurement time.

Lock Status  Indicates that the touch panel is currently unlocked. Press the Key Lock key to lock the front panel.



Indicates the front panel is locked. To unlock press and hold the Unlock key for 3 seconds. Note: The front panel will also become locked when Start is pressed or the remote control function is used.

Remote Control There are some remote control interfaces with status display on the upper-left corner.

RS232

The Remote Interface is set RS232.

GPIB

The Remote Interface is set GPIB.

USB

The Remote Interface is set USB.

LAN

The Remote Interface is set LAN.

Error

An error occurs from remote control.

RMT













Remote control mode is underway.

EXT I/O It indicates the EXT input/output is connected.

Time Displays the current system date and time.

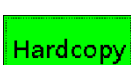
USB Disk  Indicates that a USB disk is properly connected with the GLC-10000.

Operation Keys

	<p>Measuring Network type. The selected Network appears on the button.</p>		<p>Equipment Class type. The selected Class appears on the button.</p>
	<p>Leakage current mode selection.</p>		<p>Leakage current type selection.</p>
	<p>Leakage current range selection.</p>		<p>Set leakage current limits.</p>
	<p>Sets the measurement mode.</p>		<p>Press to lock/unlock the touch panel.</p>
	<p>Save a screen image (BMP).</p>		<p>Recall settings.</p>
	<p>Save settings. Manual measurements can be saved in real-time.</p>		<p>Access the system parameters.</p>
	<p>Return to the Home screen.</p>		

Selecting a Measuring Network

Operation

1. Press the *Network* button. The twelve network choices will appear accordingly.

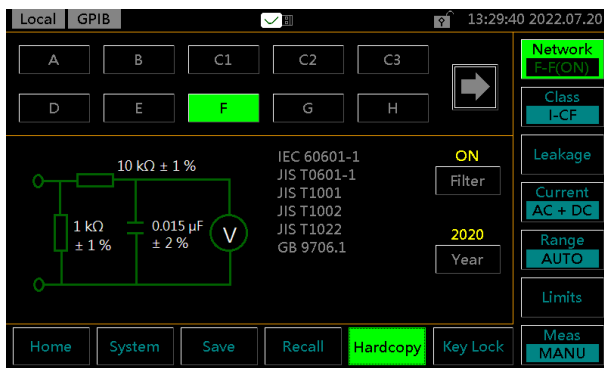

2. Press the *Right & Left* arrow keys to flip through pages of networks choices.



3. To choose a measuring network, press one of the network keys.

Range

Network A, B, C1, C2, C3, D, E, F, G, H, I, EXT

Network C2, C3

If Network C2 or C3 is selected, a V1/V2/V3 keys of Meas V can be toggled for varied applications.

C2 V1, V2

C3 V1, V3



Note

The V1/V2/V3 selections are reflected on the Network as shown below in figure A and figure B.

Figure A.

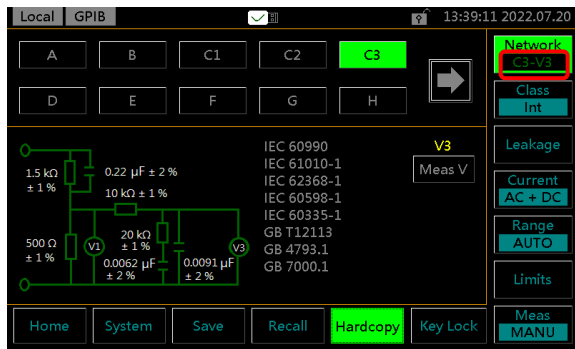
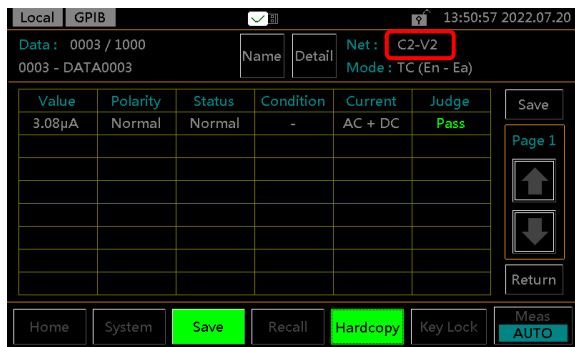

Figure B.



Network F

If Network F is selected, a Filter key can be toggled ON or OFF for varied applications.

Also, a year key can be toggled between 1995 and 2020 for different years of corresponding certificates. See page 19 and 13 for more details.



Note

When the Filter for Network F is turned On of Off, the ON or OFF is reflected on the Network as shown below in figure A and figure B.

Figure A.

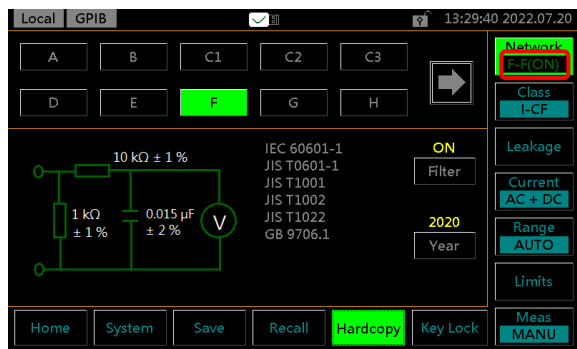
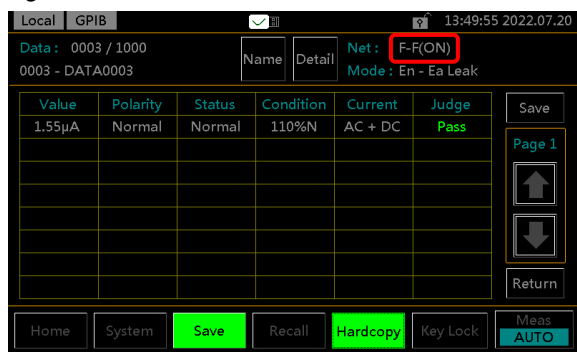

Figure B.



Network EXT

If Network EXT is selected, the Resistance value is configurable by pressing + or - keys



Range 50Ω - 5000Ω

Selecting the Safety Class/ Grounding Class

Operation

1. Press the *Class* button. The main three options of Earth Class will appear accordingly.

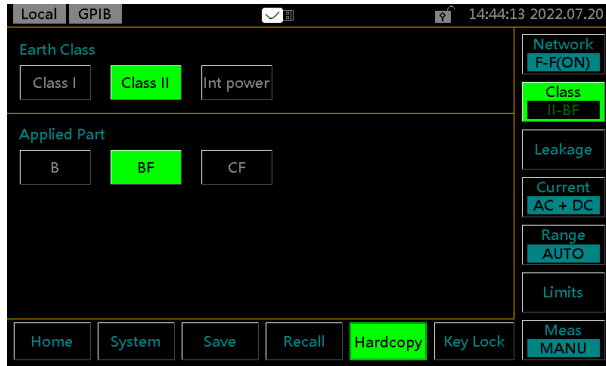

2. To select a class, press one of the class keys.

Non Medical

Earth Class Class I, Class II, Int power

Network F

When Network F is selected, there are 3 more medical options for applied parts can be selected.

Medical MD-F

Earth Class Class I, Class II, Int power

Applied Part Type B, Type BF, Type CF

Selecting a Leakage Measurement Mode

Operation

1. Press the *Leakage* button to enter the leakage section.

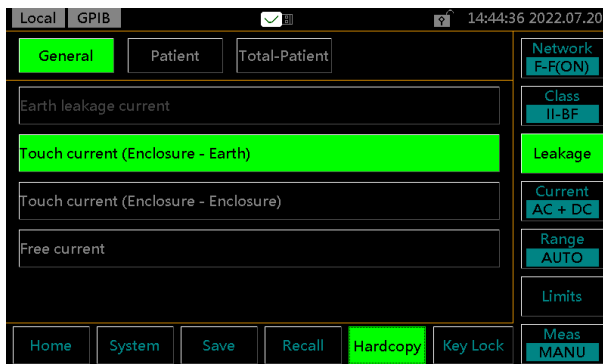

2. To choose a measurement mode, press one of the Leakage mode keys.

Non Medical

- General
- Earth leakage current
 - Touch current (Enclosure – Earth)
 - Touch current (Enclosure – Enclosure)
 - Touch current (Enclosure – Line)
 - Free current
 - Enclosure – Earth leakage current
 - Enclosure – Enclosure leakage current
 - Enclosure – Line leakage current

 Medical MD-F

- | | |
|---------|---|
| General | <ul style="list-style-type: none"> ▪ Earth leakage current ▪ Touch current (Enclosure – Earth) ▪ Touch current (Enclosure – Enclosure) ▪ Touch current (Enclosure – Line) ▪ Free current ▪ Enclosure – Earth leakage current ▪ Enclosure – Enclosure leakage current ▪ Enclosure – Line leakage current |
|---------|---|
-

- | | |
|---------|--|
| Patient | <ul style="list-style-type: none"> ▪ Patient auxiliary current |
| 2020 | <ul style="list-style-type: none"> ▪ Patient leakage current (Patient connection – Earth) |
| 2020 | <ul style="list-style-type: none"> ▪ Patient leakage current (external voltage on a SIP/SOP) |
| 2020 | <ul style="list-style-type: none"> ▪ Patient leakage current (external voltage on a specific F-type applied part) |
| 2020 | <ul style="list-style-type: none"> ▪ Patient leakage current (external voltage on a metal accessible part not protectively earthed) |
| 1995 | <ul style="list-style-type: none"> ▪ Patient leakage current I |
| 1995 | <ul style="list-style-type: none"> ▪ Patient leakage current II |
| 1995 | <ul style="list-style-type: none"> ▪ Patient leakage current III |
-

- | | |
|---------------|---|
| Total-Patient | <ul style="list-style-type: none"> ▪ Total Patient leakage current (Patient connection – Earth) ▪ Total Patient leakage current (external voltage on a SIP/SOP) ▪ Total Patient leakage current (external voltage on a specific F-type applied part) ▪ Total Patient leakage current (external voltage on a metal accessible part not protectively earthed) |
|---------------|---|
-

Selecting Measurement Parameters

Before measurement parameters can be set, the network model, grounding class and measurement mode need to be configured.

Setting Leakage Current Type

Operation

1. To set the leakage current type, press the *Current* button.

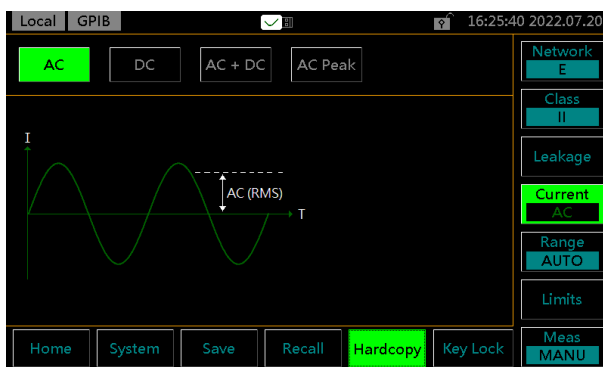

2. To choose a current type, press one of the current keys.

Current keys AC, DC, AC+DC, ACpeak

Setting the Range

Operation

1. To set the range, press the *Range* button.

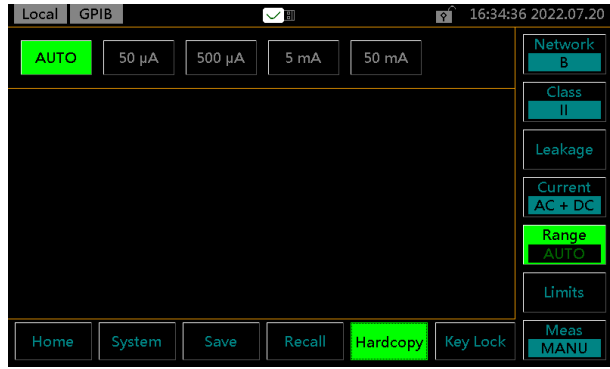

2. To set the range to automatic, press *Auto* key.
3. To set a specified range, press one of the range keys.

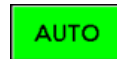

Range

DC, AC,	50.00 mA, 5.00 mA,
AC+DC	500.0 μA, 50.00 μA
ACpeak	75.0 mA, 7.5 mA, 750 μA



Note

The leakage current range depends on the measuring network used. The table below shows the maximum and minimum values of each range for each network type.

MD A,C1,C2,C3,D,E,F,G,I

AC, DC, AC+DC	Range	50.00mA	5.000mA	500.0uA	50.00uA
	Maximum	50.00mA	5.000mA	500.0uA	50.00uA
	Minimum	4.00mA	0.400mA	40.00uA	4.00uA
AC Peak	Range	75.0mA	7.500mA	750.0uA	
	Maximum	75.0mA	7.500mA	750.0uA	
	Minimum	5.0mA	0.500mA	50.0uA	

MD B

AC, DC, AC+DC	Range	50.00mA	5.000mA	500.0uA	50.00uA
	Maximum	33.33mA	3.333mA	333.3uA	33.33uA
	Minimum	2.66mA	0.266mA	26.66uA	4.00uA
AC Peak	Range	75.0mA	7.500mA	750.0uA	
	Maximum	50.0mA	5.000mA	500.0uA	
	Minimum	3.3mA	0.333mA	33.3uA	

MD H

AC, DC, AC+DC	Range	25.00mA	5.000mA	500.0uA	50.00uA
	Maximum	25.00mA	2.500mA	250.0uA	25.00uA
	Minimum	2.00mA	0.200mA	20.00uA	4.00uA
AC Peak	Range	75.0mA	7.500mA	750.0uA	
	Maximum	37.5mA	3.750mA	375.0uA	
	Minimum	2.5mA	0.250mA	25.0uA	

Setting the Limits

Operation

1. To set the Upper and Lower limits for both Normal and Fault conditions, press the *Limit* button to enter the specific setting page.

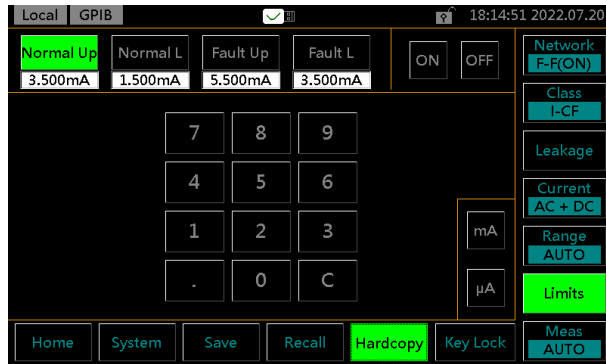

2. To choose a limit, press one of the limit keys.
Options Normal Up, Normal L, Fault Up, Fault L

3. Toggle *ON/OFF* key to turn on or off the selected limit.



4. Enter a limit value by using the keypad below.

Take 3.145mA for example as follows:

3.145mA 



- Press the C key from keypad to redo value input.
- Lower limit cannot be set greater than upper limit, and upper limit cannot be set less than lower limit.

Auto/Manual Measurement Functions

Background The *Meas* button is used to configure either manual or automatic measurements.

Operation 1. To set measurement functions, press the *Meas* measurement key.

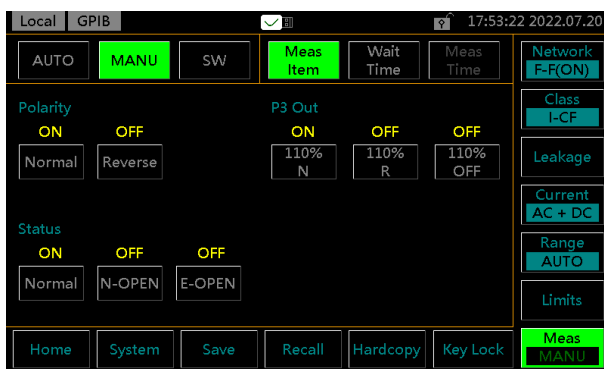

2. Choose *MANU* mode.

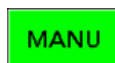

MANU Mode

3. Choose a *Polarity*.

Option

Non-Medical Normal, Reverse

Medical Normal, Reverse

4. Choose a *P3-Out*.

Option

Medical (MD-F) 110%N*, 110%R*, 110%OFF

Other N/A

5. Choose a line *Status*.

Option

Non-Medical Normal, N-OPEN, E-OPEN

Live, Neutral (Enclosure – Line)

Medical Normal, N-OPEN, E-OPEN

* 110% voltage application.

N= normal, R=reverse phase

6. Choose *SW terminal(s)* to be activated or deactivated.

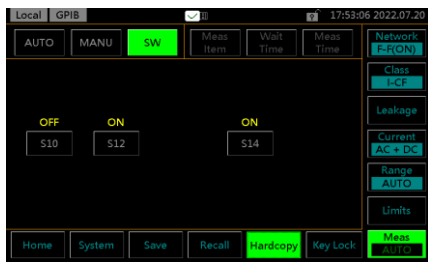

Option

Medical S10, S12, S13, S14, S15



Note

The SW terminals are available for MD-F medical applications only. The SW terminals can be multiple turned ON simultaneously. Refer to page 37 for details.

AUTO Mode

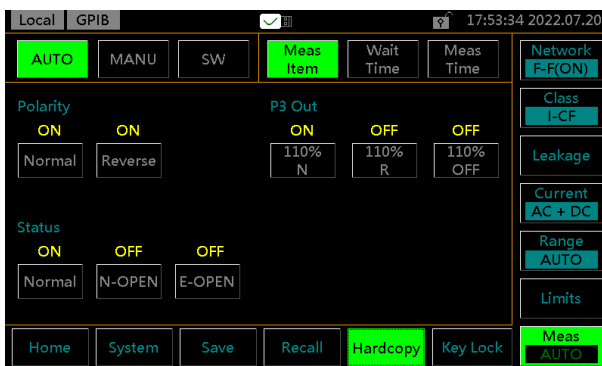

7. Choose *AUTO* mode.

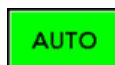

8. Set *Polarity*, *P3-Out*, line *Status* and *SW terminal(s)* parameters ON or OFF as the steps from MANU mode. However, all options can be multiple selection in AUTO mode.

Option

Polarity Normal, Reverse
 P3-Out 110%N, 110%R, 110%OFF
 Status Normal, N-OPEN, E-OPEN
 SW terminal S10, S12, S13, S14, S15

9. Choose *Wait Time*.

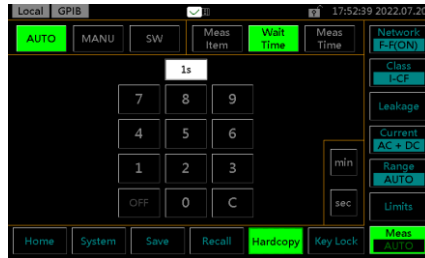

10. Use the keypad below to set the delay time before test.

Take 3 minutes for example as follows:



Note

Press the *C* key from keypad to redo value input.

11. Choose *Meas Time*.

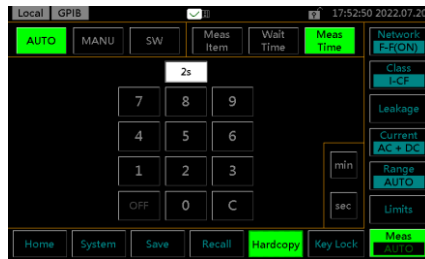

12. Use the keypad below to set the measure time.

Take 3 seconds for example as follows:



Note

- Meas Time is only available for AUTO mode.
- Press the *C* key from keypad to redo value input.

Saving Measurement Results

Background

When a measurement has completed, all results will be displayed on the screen, as shown below.

There are a scores of options as the following.

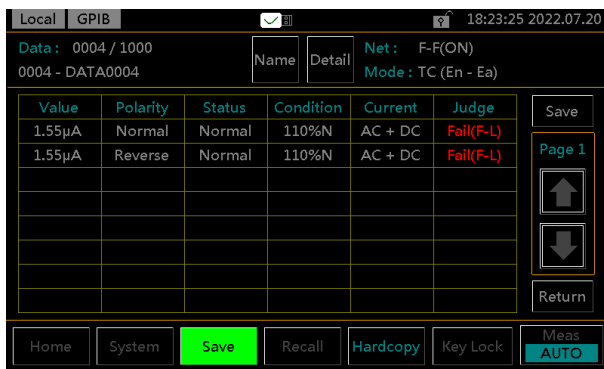

Operation

1. Use the *Up* and *Down* arrow keys to scroll through the results.



2. Press *Detail* to enter the page where detailed info of test panel setting are listed for reference.

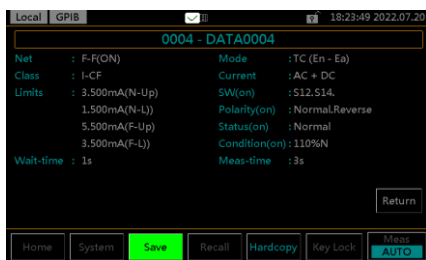

3. Press *Return* to return to the previous list of results.

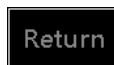

4. Press *Name* to the page where name of the test result can be defined by user.

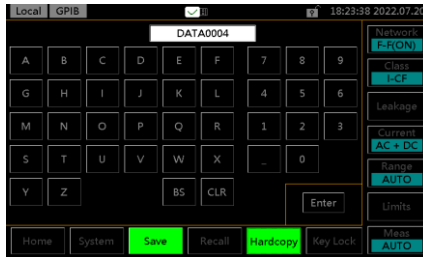

5. Use the alphanumeric keyboard to enter a file name.
Take "TEST" file name for example as follows:



Backspace



Clear all input

6. Press *Save* to save the test results.

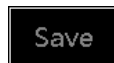

7. Press *Return* to return to the Home screen.

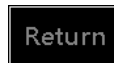

Note

The column "Value" within the measurement result page represents the maximum measured value regardless of Pass or Fail judgement from the "Judge" column.

SAVE/RECALL FEATURES

Save Panel Settings

Background The GLC-10000 can save panel settings into internal memory.

The Panel settings save the following information:

- Measuring network
- Class
- Leakage measurement mode
- Upper and Lower limits of Normal and Fault
- Measurement Settings (Polarity, power line Status, P3 Out and SW terminals)
- Wait time and Measurement time
- Stores the filename (in the save number)

In manual measurement, results are also saved. Internal memory has 30 sets of memory for user-configurable panel settings. For saving measurement results, see page 87.

Operation 1. To enter the Save section, press the *Save* button.

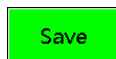

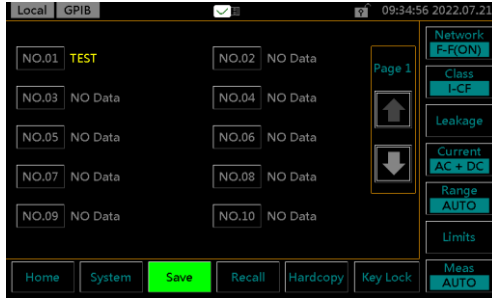

2. Use the *Up* and *Down* arrows to scroll through pages of panel setting files.



3. Choose a file to bring up the save file options.

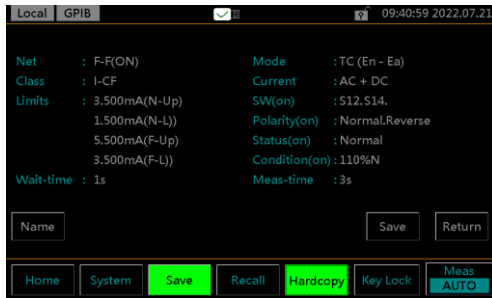

4. To create or rename the file, press *Name* key.





5. Use the alphanumeric keyboard to enter a file name. Take "TRIAL" file name for example as follows:

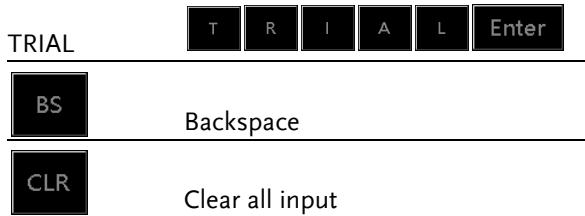

6. Press *Save* key to save the panel setting.
7. Press *Return* key to return to the previous page.

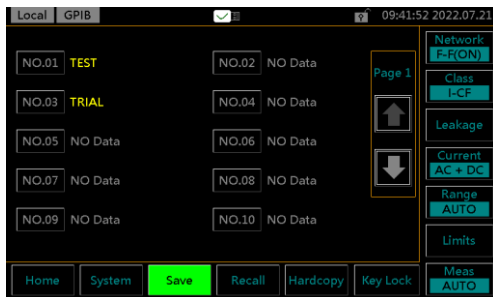

8. The newly saved panel setting (TRIAL) of NO.03 file appears in the page.

Recall Panel Settings or Test Data

Background The Recall menu is divided into 2 parts:
Panel Settings and Data of Test Results.

Recall Panel will recall panel settings, whilst
Recall Data will recall results data of measurement.

There are up to 30 panel settings.
The Panel settings recall the following information:

- Measuring network
- Class
- Leakage measurement mode
- Upper and Lower limits of Normal and Fault
- Measurement Settings (Polarity, power line Status, P3 Out and SW terminals)
- Wait time and Measurement time
- Stores the filename (in the save number)

Up to 1000 test results data can be recalled.

Operation 1. To enter the Recall section
menu, press the *Recall*
button.

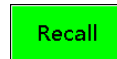

Recall Panel Setting

- Use the *Up* and *Down* arrow keys to scroll through each page of saved files.



- To recall a panel setting, choose a file to recall.

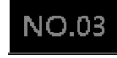

The panel setting of selected saved file will be displayed on the screen accordingly.

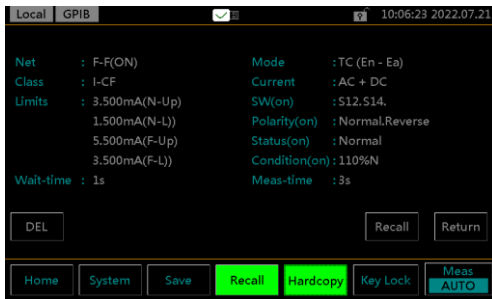

- Press *Recall* to recall the panel setting, which will be displayed on the Home screen afterwards as follows.

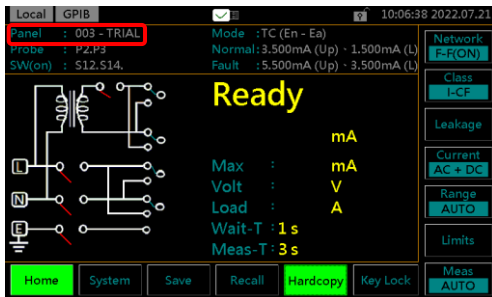

5. Press *DEL* key to delete the setting and return to the previous screen.



6. Press Return to return to the previous page directly.



Recall Test Data

7. To recall data, press the *See Data* key from the Recall section.

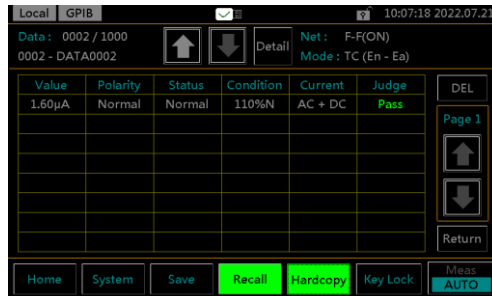

Up to 1000 results can be recalled.

8. Use the *Up* and *Down* arrow keys in the upper side to navigate through each test data.

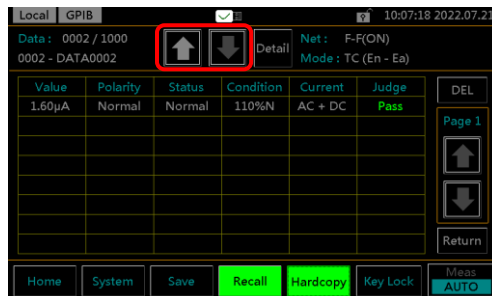

9. Use the *Up* and *Down* arrow keys in the right side to navigate through pages of each data.

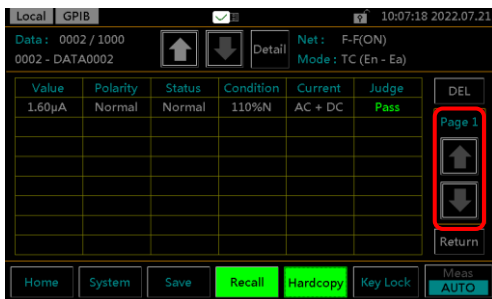

10. Press *Detail* to enter the page of selected data where detailed info of test panel setting are listed for reference.

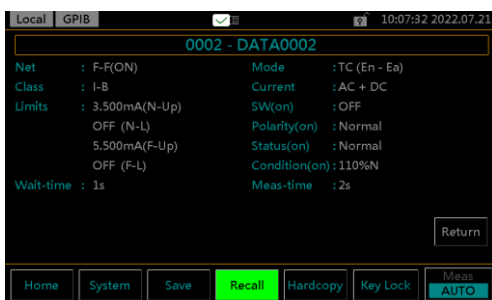

11. Press *Return* key to return to the previous page.

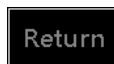

12. To delete the selected data, use the *DEL* key.



13. Press *Return* key to return to the previous page.



USB Storage

Connection and Navigation

Background	The USB port is used to copy files (panel settings, measurement results, screen images) and for performing firmware updates.
File Format	The GLC-10000 recognizes *.CSV *.BMP and *.BIN file formats.
File name	Only 8.3 length filenames are supported.

- Connection
1. Insert a USB flash disk into the USB port located on the front panel.

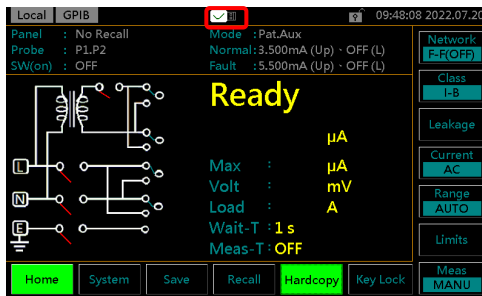
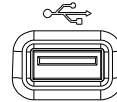

The flash drive will be automatically detected after insertion. Once detected, the USB icon will appear on the upper side of Home screen.

- Operation
2. Press the *System* button to enter the System section first.

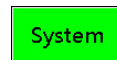

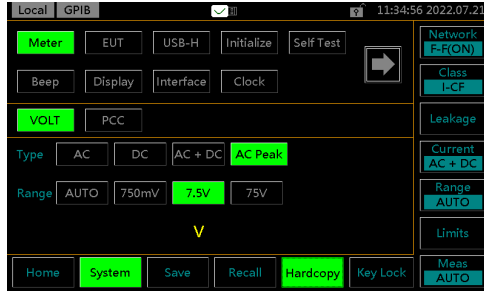



- Download files 3. Press *USB-H* key to enter the USB storage section 

Download and Upload Files

Background Panel settings and test data can be copied to USB storage, whereas only panel settings can be uploaded from USB storage to GLC-10000. Panel settings have the format *.CSV

- Download files 1. Press *Download* key of either Panel or Data to copy files from GLC-10000 into the inserted USB disk.  or 



- Upload files 2. Press *Upload* key of Panel to upload files from the inserted USB disk to GLC-10000. 

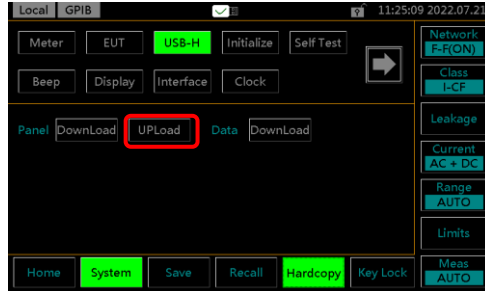

Firmware Update

The firmware update for GLC-10000 series requires an USB 2.0 flash disk and the corresponding “image.BIN” file beforehand.



Note

The firmware file “LC1XR.bin”, which is in different filename by default, needs to be manually renamed by user for firmware update. For instance, rename the original “GLC_10000_V1.02_LC1XR.bin” to the exactly “LC1XR.bin”.

- Update procedure
1. Power off GLC-10000 unit.
 2. Plug in the USB flash disk after copying the “LC1XR.bin” file to the root directory of the USB flash disk.
 3. Press and hold the STOP key followed by pressing the POWER button to power on GLC-10000 unit.
 4. The BootLoader Mode is accordingly shown for firmware update automatically.
 5. After firmware update, GLC-10000 unit will reboot automatically. Check the latest firmware version via going to the System - Information.
-

Save a Screen Image

Background Screenshots of display can be captured via the *Hardcopy* button. Each screenshot is saved as a bitmap (*.BMP) file in a directory GLC10000\PICTURE.

Operation

1. Insert a USB flash drive into the USB port located on the front panel.

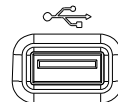

2. Press the *Hardcopy* button, and wait for the image to be copied to the USB flash drive.

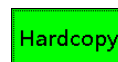

Note

If a USB disk has not been inserted, pressing the *Hardcopy* button will lead to no action.

S SYSTEM SETTINGS

Background The *System* key is used to access the System section, which can then be used to access a number of different system menus.

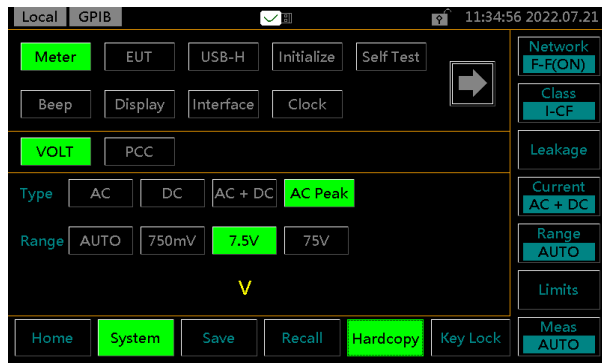

Panel Operation 1. To access the System section, press the *System* button.

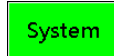

Meter Measurement

Background The Meter section can measure different types of voltages: AC, DC, AC+DC and AC peak. Also, the PCC (Protective Conductor Current) current can be measured from this section.

VOLT Meter Mode

1. From the System section, press the *Meter* key followed by *VOLT* key to display VOLT meter section.

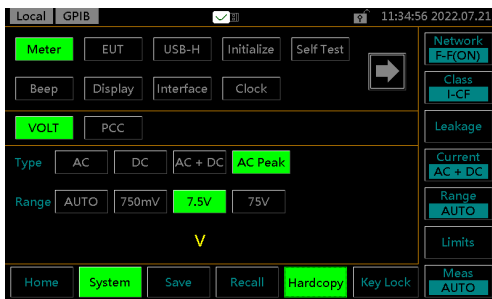
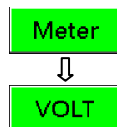

2. Choose a measurement Type and Range. Press the *START* button to begin measuring. And press the *STOP* button to stop measuring.

Type	AC, DC, AC+DC, AC Peak
Range	AUTO, 50mV, 500mV, 5V, 50V

- The instant measured volt will be shown below.

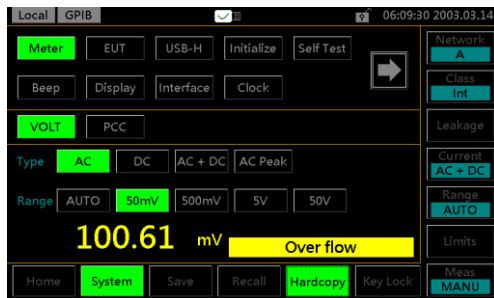

PCC Meter Mode

The PCC (Protective Conductor Current) measures the current, in the midst of normal conditions, flows through the protective earth conductor, that is, grounding wire. It is not applicable to the Class II equipment, which has no protective earth wire.

- From the System section, press the *Meter* key followed by *PCC* key to display PCC meter section.

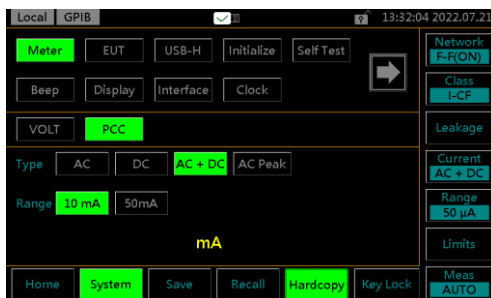
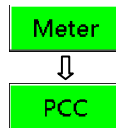

- Choose a measurement Type and Range.
Press the *START* button to begin measuring.
And press the *STOP* button to stop measuring.

Type	AC, DC, AC+DC, AC Peak
Range	10mA, 75mA

- The instant measured current will be shown below.

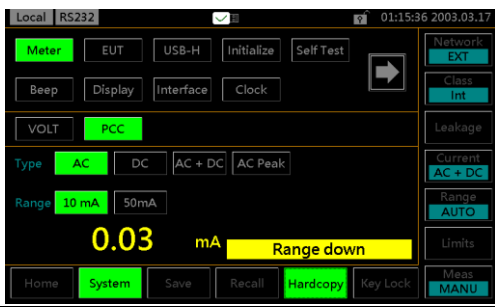

EUT Voltage and Current Check

Background The EUT voltage and current check tests voltage, current and power consumption. Also, the Outlet setting for output terminals to EUT can be set up from this section.

EUT V/A Check Operation

1. From the System section, press the *EUT* key followed by *V/A* key to display V/A check section.
2. To perform the voltage and current check, press *Start*.

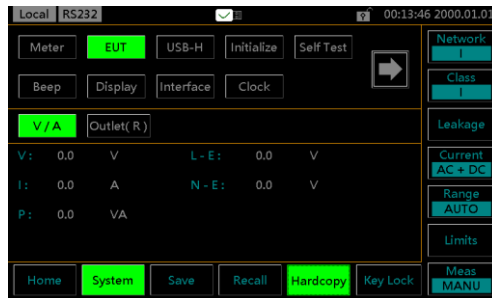
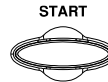
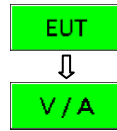

Voltage, current, power consumption and voltage between Live and Earth as well as Neutral to Earth will be checked and displayed here.

EUT Outlet Setup

The Outlet setting is used to set live and neutral polarity setting of output terminals for EUT on the front and rear AC blocks.

1. From the System section, press the *EUT* key followed by *Outlet* key to display Outlet setup section.

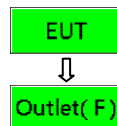

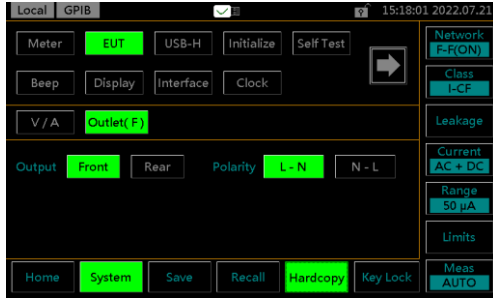

The EUT Outlet menu will allow you to select the live and neutral terminals polarity on AC blocks of front and rear panels, individually.

2. First select the Front or Rear output terminal followed by setting up which terminal polarity will be employed.

EUT AC Power Output Socket on front panel

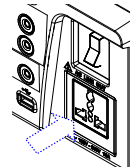

EUT AC Output Terminal on rear panel

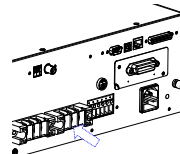

Output Front, Rear

Polarity (e.g., front)

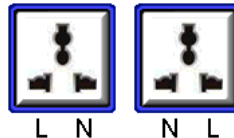



L N N L

Initialize Menu

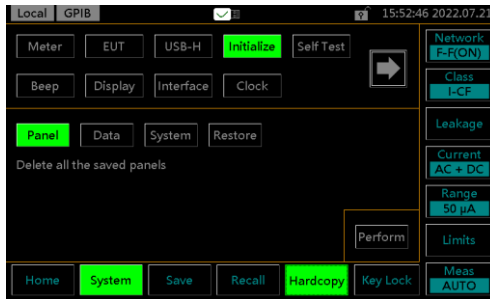

Background The Initialize section allows user to initialize a number of settings. Saved test data and panel settings can be deleted. The System and Factory default settings can be performed to restore.

Panel Operation 1. From the System section, press the *Initialize* key to enter the Initialize section. 

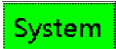

Delete Panel Setting & Test Data 2. Press the *Panel* or *Data* key to delete either all the panel settings or all the saved data.  or 

3. Press the *Perform* key to execute delete action. 

Restore System Default & Factory Default Settings 4. Press the *System* or *Restore* key to restore to either System or Factory default settings.  or 

5. Press the *Perform* key to execute restore action. 

 **Note**

- Factory restores all settings to the default.
- System restores only settings of System to the default.

System Self Test

Background The Self Test function allows the system functions to be checked automatically.

- Panel Operation**
1. From the System section, press the *Self Test* key to enter the specific section.

Self Test

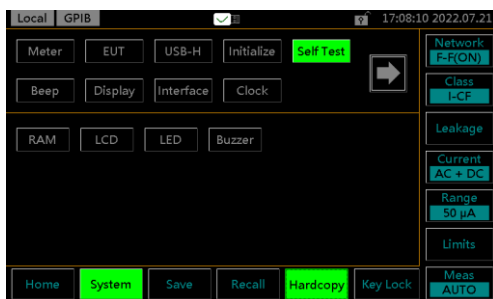

2. To perform a self test, choose any of the soft test functions (*RAM, LCD, LED, Buzzer*).

RAM

LCD

LED

Buzzer

3. The results of the system test will be shown after the selected self test finishes.

Option RAM, LCD, LED, Buzzer

Beep Settings

Background The Beep section is used to set tones for a scores of different events.

Panel Operation 1. From the System section, press the *Beep* key to enter the specific section.

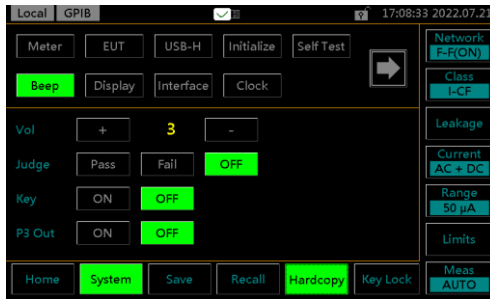

Setting an event to *ON* will allow a tone to be heard when that event occurs. Selecting *PASS* or *FAIL* will produce a tone for a pass or fail judgment. The *Vol* indicates the intensity of tone.

2. To turn an alarm on, set an event to *ON*, *PASS* or *FAIL*.



3. To turn off an alarm off, set an event to *OFF*.



4. Press the + or – keys to increase or decrease volume.



Range 1 (low), 2 (mid), 3 (high)

Display Settings

Background The Display section adjusts the LCD Light and the Language for user interface.

Panel Operation 1. From the System section, press the *Display* key to enter the specific section. Display

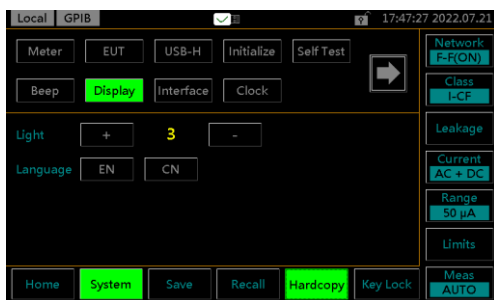

Back Light 2. Press the + or – keys to increase or decrease the light intensity. + -

Range 1~5

Language 3. Press the *EN* or *CN* keys to change UI display language. EN CN

Option EN (English), CN (Simplified Chinese)

Interface Settings

Background The Interface section is used to select the remote control interface with affiliated settings. After a connection has been established, an interface icon will be shown in the upper-left corner of display.

- Panel Operation**
1. From the System section, press the *Interface* key to enter the specific section. 

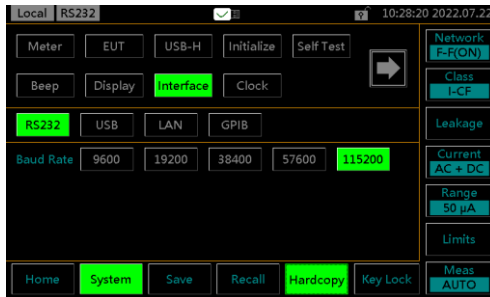

RS232, USB, LAN and GPIB can be selected from the interface menu. Each interface has a set a number of parameters and includes interface information.

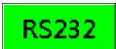
- RS232**
2. To set the interface to RS232, press *RS232* key. 
 3. Press a baud rate setting in accord with actual application.

Option 9600, 19200, 38400, 57600, 115200,
8 bit data, no parity check, 1 stop bit.

- USB**
4. To set the interface to USB, press *USB* key. 

- LAN**
5. To set the interface to LAN, press *LAN* key. 

6. First select DHCP (Dynamic Host Configuration Protocol) ON or OFF. When choosing ON, IP address along with affiliated parameters will be automatically assigned.



Option ON, OFF

7. If DHCP is selected OFF, manually set the following parameters in accordance with actual applications. Take "Port" for example, press the value field and press the + or - keys to increase or decrease value followed by pressing the *Enter* key.



IP Address 0-255.0-255.0-255.0-255

Netmask 0-255.0-255.0-255.0-255

Gateway 0-255.0-255.0-255.0-255

Port 0-65535

GPIB

8. To set the interface to GPIB, press *GPIB* key.



9. Press the + or - keys to designate an Address for GPIB.





Range 1~30

Clock Settings

Background The Clock section is used to set time and date.

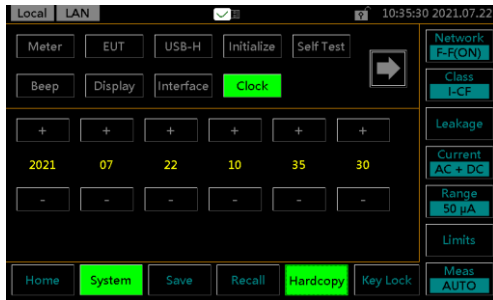
- Panel Operation**
1. From the System section, press the *Clock* key to enter the specific section. 



2. Use the + and - keys to set date and time, individually.  

Calibration

Background The Calibration section is used to access to the calibration function, which requires a password to enter the menu. Please see your distributor or dealer for details when necessary.

- Panel Operation**
1. From the System section, press the right arrow key to next page followed by pressing the *Calibration* key to enter the specific section.

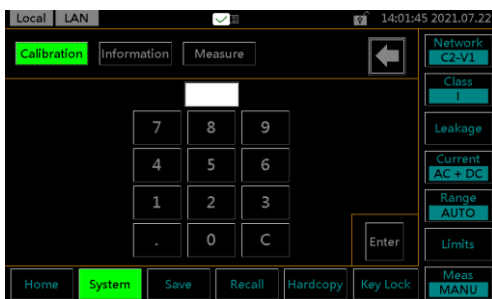
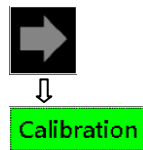

2. Use the keypad to enter the password followed by pressing *Enter* before entering the calibration page.



Information

Background Used to check GLC-10000 Firmware version number, Serial number as well as MAC info.

- Panel Operation**
1. From the System section, press the right arrow key to next page followed by pressing the *Information* key to enter the specific section.

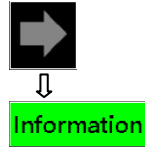

The firmware version, serial number and MAC info are clearly shown in this section.

Measure Settings

Background The Measure section refers to configuring on both Frequency and BNC settings.

- Panel Operation**
1. From the System section, press the right arrow key to next page followed by pressing the *Measure* key to enter the specific section.

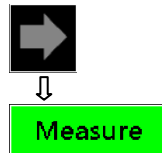

- Frequency**
2. Press either *15 Hz* or *0.1 Hz* for frequency setting. The 0.1 Hz increases measurement time but slows down the response of internal circuits. 15 Hz is the default setting.



Option 15 Hz, 0.1 Hz



Note

When network F(2020) is selected, the frequency range setting of the instrument is 0.1 - 1 MHz, which allows user to select either 0.1 Hz - 1 MHz or 15 Hz - 1 MHz. An 0.1 Hz - 1 MHz setting will slow down the response of internal circuits and increase measurement time. Therefore, perform the following tests to check the frequency range setting when using a F:2020 network. The expanded bandwidth (0.1 Hz to 1 MHz) is used as required by IEC 60601. To accurately measure low frequency components, set the test time to at least 120 seconds.(Default setting: 15 Hz - 1 MHz)

Check the frequency range setting at regular intervals with the following notes:

- Use the 0.1 Hz setting only for measurements in the F:2020 network.
- Selecting a network other than the F:2020 network in an 0.1 Hz setting will invalidate the 0.1 Hz setting. (The display does not change.)
- The auto range is not available when a 0.1 Hz frequency range setting is made. Selecting auto range automatically sets the hold range. (during ACpeak measurements: 750uA range; during AC/DC/AC+DC measurements: 50uA range)
- Setting the frequency range to 0.1 Hz in voltmeter mode engages the hold range (50 mV range).
- Setting the frequency range to 0.1 Hz when ACPeak is selected in leakage current meter mode selects AC+DC.

BNC

3. Press *ON* or *OFF* keys for BNC setting. Refer to page 36 for details of BNC MD Output Port.

OFF

ON

Option

ON, OFF

REMOTE CONTROL





This chapter describes basic configuration of IEEE488.2 based remote control. For a command list, refer to the Command Overview chapter on page 122.

Remote Interface Configuration	118
Configure USB Connection	118
Configure RS232 Connection	119
Configure GPIB Connection	120
Configure LAN Connection	121

Remote Interface Configuration

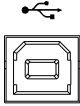
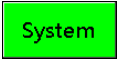
Configure USB Connection

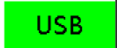
USB Configuration	PC side connector	Type A, host
	GLC-10000 side connector	Rear panel Type B, device
	Speed	1.1/2.0 (full speed)
	USB Class	CDC (communications device class)

- | | | |
|-------|---|--|
| Steps | <ol style="list-style-type: none"> 1. Connect the Type A-Type B USB cable from PC side to the rear panel USB B port of GLC-10000. |  |
| | <ol style="list-style-type: none"> 2. Press the <i>System</i> button to access the System section. |  |
| | <ol style="list-style-type: none"> 3. Press the <i>Interface</i> key to enter the specific section. |  |
| | <ol style="list-style-type: none"> 4. Press the <i>USB</i> key to set the interface to USB. |  |
| | <ol style="list-style-type: none"> 5. Enter the following command to test the system.
* IDN?
If remote control is working correctly, the query will return the machine manufacturer, model, serial number and firmware version number.
GW INSTEK, GLC-10000, SN: xxxxxxxx, Vx.xx
And the RMT icon  will appear on the upper-left corner of GLC-10000 display. | |

Configure RS232 Connection

RS232 Configuration	Connector Parameters	BD-9, male Baud rate, data bits, parity, stop bits.
---------------------	----------------------	--

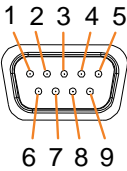
Pin Assignment		2: RxD (Receive data) 3: TxD (Transmit data) 5: GND 4, 6 ~ 9: No connection
----------------	---	--

Pin Connection Use a Null Modem connection (RS232C cable) as shown in the diagram below.

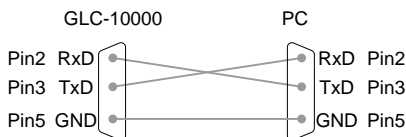

Steps

1. Connect a RS232C cable from the PC to the rear panel RS232 port of GLC-10000.
2. Press the *System* button to access the System section.
3. Press the *Interface* key to enter the specific section.
4. Press the RS232 key to set the interface to RS232.
5. Select an appropriate *Baud Rate* of GLC-10000 corresponding to the setting of PC side.

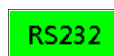
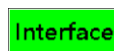
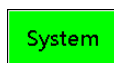
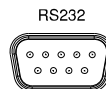

6. Enter the following command to test the system.
* IDN?

If remote control is working correctly, the query will return the machine manufacturer, model, serial number and firmware version number.

GW INSTEK, GLC-10000, SN: xxxxxxxx, Vx.xx

And the RMT icon  will appear on the upper-left corner of GLC-10000 display.

Configure GPIB Connection

Steps

1. Connect a GPIB cable from the PC to the rear panel GPIB port of GLC-10000.

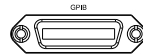

2. Press the *System* button to access the System section.

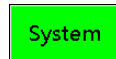

3. Press the *Interface* key to enter the specific section.



4. Press the *GPIB* key to set the interface to GPIB.



5. Select an appropriate *Address* of GLC-10000 corresponding to the setting of PC side.
6. Enter the following command to test the system.
* IDN?



If remote control is working correctly, the query will return the machine manufacturer, model, serial number and firmware version number.

GW INSTEK, GLC-10000, SN: xxxxxxxx, Vx.xx

And the RMT icon  will appear on the upper-left corner of GLC-10000 display.

Configure LAN Connection

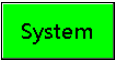
LAN Parameters	MAC Address (display only)	DHCP
	IP Address	Netmask
	Gateway	Port (default: 23)

- | | |
|-------|---|
| Steps | <ol style="list-style-type: none"> 1. Connect a LAN cable from the PC to the rear panel LAN port of GLC-10000.  2. Press the <i>System</i> button to access the System section.  3. Press the <i>Interface</i> key to enter the specific section.  4. Press the <i>LAN</i> key to set the interface to LAN.  5. To automatically have the network assign an IP address, set DHCP ON. Otherwise set DHCP OFF to manually set the affiliated settings including IP Address, Netmask, Gateway and Port. 6. Enter the following command to test the system.
 * IDN?

 If remote control is working correctly, the query will return the machine manufacturer, model, serial number and firmware version number.
 GW INSTEK, GLC-10000, SN: xxxxxxxx, Vx.xx
 And the RMT icon  will appear on the upper-left corner of GLC-10000 display. |
|-------|---|

C COMMAND OVERVIEW

The Command overview chapter lists all programming commands in functional order as well as alphabetical order. The command syntax section shows you the basic syntax rules you have to apply when using commands.

Command Syntax

Compatible Standard	IEEE488.2	Partial compatibility
	SCPI, 1994	Partial compatibility
Command Structure	<p>SCPI (Standard Commands for Programmable Instruments) commands follow a tree-like structure, organized into nodes. Each level of the command tree is a node. Each keyword in a SCPI command represents each node in the command tree. Each keyword (node) of a SCPI command is separated by a colon (:).</p> <p>For example, the diagram below shows an SCPI sub-structure and a command example.</p>	

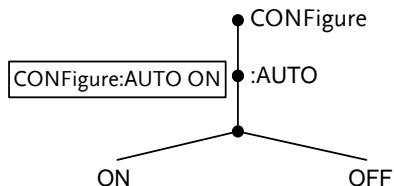

Command Types There are a number of different instrument commands and queries. A command sends instructions or data to the unit and a query receives data or status information from the unit.

Command types

Simple	A single command with/without a parameter
--------	---

Example	CONFigure:AUTO ON
---------	-------------------

Query	A query is a simple or compound command followed by a question mark (?). A parameter (data) is returned.
-------	--

Example

CONFigure:AUTO?

Command Forms Commands and queries have two different forms, long and short. The command syntax is written with the short form of the command in capitals and the remainder (long form) in lower case.

The commands can be written either in capitals or lower-case, just so long as the short or long forms are complete. An incomplete command will not be recognized.

Below are examples of correctly written commands.

Long form	CONFigure:AUTO ON
-----------	-------------------

Short form	CONF:AUTO ON
------------	--------------

Command
Format



1. Command header
2. Space
3. Parameter 1

Common Input Parameters	Type	Description	Example
	<Boolean>	boolean logic	0, 1
	<NR1>	integers	0, 1, 2, 3
	<NR2>	decimal numbers	0.1, 3.14, 8.5
	<NR3>	floating point with exponent	4.5e-1, 8.25e+1
	<NRf>	any of NR1, 2, 3	1, 1.5, 4.5e-1

Message Terminator (EOL)	Remote Command	Marks the end of a command line. The following messages are in accordance with IEEE488.2 standard.
		CR+LF
		The most common EOL character is CR+LF

Message Separator	EOL or ; (semicolon)	Command Separator
-------------------	----------------------	-------------------

Command List

Measurement Network Commands	NETWork	128
Measuring Equipment Configuration Commands	EQUIPMENT	129
	EQUIPMENT:TYPE.....	129
Measurement Mode Commands	MODE.....	131
Measurement Commands	CONFigure:AUTO	133
	NETWork:MEDical:YEAR	133
	NETWork:MEDical:FILTer	134
	NETWork:C2FILTer	135
	NETWork:C3FILTer	136
Measurement Items Commands	CONFigure:COMParator	137
	CONFigure:COMParator:SWITCh.....	138
	CONFigure:COMParator:FAULt.....	139
	CONFigure:COMParator:FAULt:SWITCh	140
	CONFigure:CURREnt	141
	CONFigure:RANGe.....	142
	CONFigure:SWITCh	143
Manual Measurement Commands	CONFigure:CONDition	144
	CONFigure:APPLY.....	145
	CONFigure:POLarity.....	146
	CONFigure:WTIME	147
Automatic Measurement Commands	AMC.....	148
	CONFigure:AMITem:CONDition	148
	CONFigure:AMITem:APPLY	150
	CONFigure:AMITem:POLarity.....	151
	CONFigure:AMTime	152
	CONFigure:AMTime:WAI	153

Measure	START.....	154
Commands	STOP	154
Measurement Data Commands	MEASure?	155
Save Data Commands	MEMory:NUMBer	157
	MEMory:IDENtity.....	157
	MEMory:MEASure	158
	MEMory:SAVE	160
	MEMory:SAVE:AUTO.....	160
System Setup Commands	SYSTem:MODE.....	161
	SYSTem:EUT	162
	SYSTem:FREQuency	162
	SYSTem:BACKlight.....	163
	SYSTem:BEEPer:VOL.....	163
	SYSTem:BEEPer:COMParator	164
	SYSTem:BEEPer:KEY.....	165
	SYSTem:BEEPer:T3OUT	166
	SYSTem:FILE:NAME	167
	SYSTem:DATA:NAME	167
	SYSTem:CLEar:MEASure	168
	SYSTem:CLEar:PANel	168
	SYSTem:DATE.....	169
	SYSTem:TIME	169
	SYSTem:FILE.....	170
	SYSTem:LOAD	174
	SYSTem:SAVE	174
	SYSTem:TEST:VA.....	174
System Related Commands	SYSTem:ERRor	176
	*IDN?	176
	*CLS	177
RS232 Interface Commands	SYSTem:LOCal	177

Voltage mode	CONFigure:VOLTage	178
Commands	CONFigure:VOLTage:RANGe.....	179
	MEASure:VOLTage?	180
Protective	CONFigure:PCC	181
conductor current	CONFigure:PCC:RANGe.....	182
mode Command	MEASure:PCC?	183
Error Information	Error information	183
Commands		

Measurement Network Commands

NETWork 128

NETWork

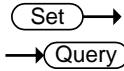

Sets or queries the measurement network.



Note

The set command can only be used in leakage current mode.

Syntax

NETWork {A|B|C1|C2|C3|D|E|F|G|H|I|EXT}

Query Syntax

NETWork?

Query Return

Returns network type: A|B|C1|C2|C3|D|E|F|G|H|I|EXT

Example

NETWork B

Sets the measurement network as network B.

Query Example

NETWork?

Return: B

measurement network is B.

Measuring Equipment Configuration Commands

EQUIPMENT.....	129
EQUIPMENT:TYPE	129

EQUIPMENT



Sets or queries the EUT class.



Note

The set command can only be used in leakage current mode.

Syntax EQUIPMENT {CLAss1|CLAss2|INTERNAL}

Query Syntax EQUIPMENT?

Query Return Returns the equipment class of the EUT as a string:
CLASS1|CLASS2|INTERNAL

Example EQUIPMENT CLAss1
Sets the class of the EUT to "CLASS 1".

Query Example EQUIPMENT?
Return: CLASS1
EUT class is CLASS1.

EQUIPMENT:TYPE



Sets or queries the applied part of the EUT.



Note

- This command can only be used with network F.
- The set command can only be used in leakage current mode.

Syntax EQUIPMENT:TYPE {B|BF|CF}

Query Syntax EQUIPMENT:TYPE?

Query Return Returns the applied part of the EUT as a string:
B|BF|CF (Network F only)

Example

EQUIPMENT:TYPE BF

The applied part of the EUT is set to type BF for network F.

Query Example

EQUIPMENT:TYPE?

Return: BF

Type BF is the currently applied part of the EUT for network F.

Measurement Mode Commands

MODE131

MODE

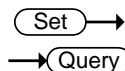

Set or queries the measurement mode of leakage current.



Note

- Different measuring networks have different measurement modes. Refer to the Appendix 1 on page 185 for details.
- The set command can only be used in leakage current mode.

Syntax

```
MODE
{EARTH|ENCLOsure1|ENCLOsure2|ENCLOsure3
|PATient1|PATient2|PATient3|PAUXiliary
|TOUCh1|TOUCh2|TOUCh3
|PATientP2E|PATientSIPSOP
|PATientFTYPE|PATientMP
|TPATientP2E|TPATientSIPSOP
|TPATientFTYPE|TPATientMP|FREE}
```

Query Syntax

```
MODE?
```

Query Return

```
Returns the measurement mode as a string:
EARTH|ENCLOSURE1|ENCLOSURE2|ENCLOSURE3
|PATIENT1|PATIENT2|PATIENT3|PAUXILIARY
|TOUCH1|TOUCH2|TOUCH3
|PATIENTP2E|PATIENTSIPSOP
|PATIENTFTYPE|PATIENTMP
|TPATIENTP2E|TPATIENTSIPSOP
|TPATIENTFTYPE|TPATIENTMP|FREE
```

Example MODE EARTH
 Sets the measurement mode to Earth leakage current.

Query Example MODE?
 Return: EARTH
 Earth leakage current is the current measurement mode.

Measurement Commands

CONFigure:AUTO	133
NETWork:MEDical:YEAR.....	133
NETWork:MEDical:FILTer	134
NETWork:C2FILTer.....	135
NETWork:C3FILTer.....	136

CONFigure:AUTO

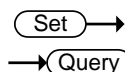

Configures or queries the measurement function of leakage current.



Note The set command can only be used in leakage current mode.

Syntax CONFigure:AUTO {ON|OFF}

Query Syntax CONFigure:AUTO?

Query Return Returns the measurement function as a string:
(ON|OFF)

ON: Automatic mode OFF: Manual mode

Example CONFigure:AUTO OFF

Sets the measurement function to manual mode.

Query Example CONFigure:AUTO?

Return: OFF

The measurement function is manual.

NETWork:MEDical:YEAR

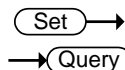

Sets or queries applicable standard year of Network F.



Note

- This command can only be used with network F.
- The set command can only be used in leakage current mode.

Syntax

NETWork:MEDical: YEAR {"2020"|"1995"}

Query Syntax

NETWork:MEDical: YEAR?

Query Return

Returns a string indicating Network F applicable standard year.

Example

NETWork:MEDical:YEAR "2020"

applicable standard year is 2020 for Measuring Network F.

Query Example

NETWork:MEDical: YEAR?

Return: 2020

the applicable standard year is 2020.

NETWork:MEDical:FILTer

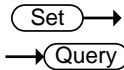

Sets or queries whether Network F has the RC network enabled/disabled. If the RC network is OFF, a 1k pure resistance filter is used.



Note

- This command can only be used with network F.
- The set command can only be used in leakage current mode.

Syntax

NETWork:MEDical:FILTer {ON|OFF}

Query Syntax

NETWork:MEDical:FILTer?

Query Return

Returns a string indicating if the RC network is ON or OFF.

ON: RC filter is ON.

OFF: RC filter is OFF, pure 1k resistance is enabled.

Example

NETWork:MEDical:FILTer OFF

Turns the RC filter OFF for Measuring Network F.

Query Example NETWork:MEDical:FILTer ?
 Return: OFF
 Returns the RC filter status. The RC filter is turned off.

NETWork:C2FILTer

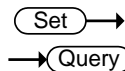

Sets or queries whether Network C2 has the RC network enabled/disabled.



Note

- This command can only be used with network C2.
- The set command can only be used in leakage current mode.

Syntax NETWork:C2FILTer {ON|OFF}

Query Syntax NETWork:C2FILTer?

Query Return Returns a string indicating if the RC network is ON or OFF.

ON: RC filter is ON.

OFF: RC filter is OFF.

Example NETWork:C2FILTer OFF

Turns the RC filter OFF for Measuring Network C2.

Query Example NETWork:C2FILTer ?

Return: OFF

Returns the RC filter status. The RC filter is turned off.

NETWork:C3FILTer

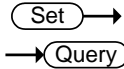

Sets or queries whether Network C3 has the RC network enabled/disabled.



Note

- This command can only be used with network C3.
- The set command can only be used in leakage current mode.

Syntax

NETWork:C3FILTer {ON|OFF}

Query Syntax

NETWork:C3FILTer?

Query Return

Returns a string indicating if the RC network is ON or OFF.

ON: RC filter is ON.

OFF: RC filter is OFF.

Example

NETWork:C3FILTer OFF

Turns the RC filter OFF for Measuring Network C3.

Query Example

NETWork:C3FILTer ?

Return: OFF

Returns the RC filter status. The RC filter is turned off.

Measurement Items Commands

CONFigure:COMParator	137
CONFigure:COMParator:SWITch	138
CONFigure:COMParator:FAULt	139
CONFigure:COMParator:FAULt:SWITch.....	140
CONFigure:CURRent.....	141
CONFigure:RANGe	142
CONFigure:SWITch.....	143

CONFigure:COMParator

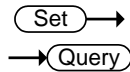

Sets or queries the current measuring mode's upper and lower limit of leakage current.



Note

The set command can only be used in leakage current mode.

Syntax

CONFigure:COMParator {NR3,NR3}

Query Syntax

CONFigure:COMParator?

Query Return

Returns the current measuring mode upper and lower limit. The first parameter is the upper limit, the second is the lower limit.

<NR3>: Range: +0.010E-6 ~ +75.00E-03 (in Amps)

In ac,dc,acdc current type,max value is +50.00E-03.

Example

CONFigure:COMParator +4.000E-03,+100.0E-06

Set the upper limit to 4mA and the lower limit to 100uA.

Query Example

CONFigure:COMParator?

Return: +4.000e-03,+1.000E-04

Returns an upper limit of 4mA and a lower limit of 100uA.

CONFigure:COMParator:SWITCh

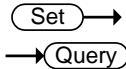

Sets or queries the current measuring mode's upper and lower limit of leakage current which has the switch enabled/disabled.



Note

The set command can only be used in leakage current mode.

Syntax

CONFigure:COMParator:SWITCh { str,str}

Query Syntax

CONFigure:COMParator:SWITCh?

Query Return

Returns strings indicating if the current measuring mode upper and lower limit switch is ON or OFF. The first parameter is the upper limit switch, the second is the lower limit switch.

<str>: ON|OFF

Example

CONFigure:COMParator:SWITCh ON,OFF

Set the upper limit switch is enable and the lower limit switch is disable.

Query Example

CONFigure:COMParator:SWITCh?

Return: ON,OFF

Returns an upper limit switch is enable and a lower limit switch is disable.

CONFigure:COMParator:FAULt

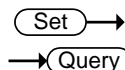

Sets or queries the current measuring mode's upper and lower limit of leakage current in single fault condition.



Note

The set command can only be used in leakage current mode.

Syntax

CONFigure:COMParator:FAULt {NR3,NR3}

Query Syntax

CONFigure:COMParator:FAULt?

Query Return

Returns the current measuring mode upper and lower limit in single fault condition. The first parameter is the upper limit, the second is the lower limit.

<NR3>: Range: +0.010E-6 ~ +75.00E-03 (in Amps)

In ac,dc,acdc current type,max value is +50.00E-03.

Example

CONFigure:COMParator:FAULt +4.000E-03,+100.0E-06

Set the upper limit to 4mA and the lower limit to 100uA in single fault condition.

Query Example

CONFigure:COMParator:FAULt?

Return: +4.000e-03,+1.000E-04

Returns an upper limit of 4mA and a lower limit of 100uA in single fault condition.

CONFigure:COMParator:FAULt:SWITCh

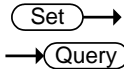

Sets or queries the current measuring mode's upper and lower limit of leakage current in single fault condition which has the switch enabled/disabled.



Note

The set command can only be used in leakage current mode.

Syntax

CONFigure:COMParator:FAULt:SWITCh { str,str}

Query Syntax

CONFigure:COMParator:FAULt:SWITCh?

Query Return

Returns strings indicating if the current measuring mode upper and lower limit switch in single fault condition is ON or OFF. The first parameter is the upper limit switch, the second is the lower limit switch.

<str>: ON|OFF

Example

CONFigure:COMParator:FAULt:SWITCh ON,OFF

Set the upper limit switch is enable and the lower limit switch is disable in single fault condition..

Query Example

CONFigure:COMParator:FAULt:SWITCh?

Return: ON,OFF

Returns an upper limit switch is enable and a lower limit switch is disable in single fault condition..

CONFigure:CURRent

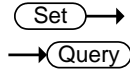

Sets or queries the current type of leakage current.



Note

- When the following configurations, which include the network F, the applicable standard year 2020 and the measure frequency 0.1Hz, are set, AC peak can't be set.
- Some times can't be set some one. Refer to the Appendix 3 on 196 for details.
- The set command can only be used in leakage current mode.

Syntax CONFigure:CURRent {ACDC|AC|DC|ACPeak}

Query Syntax CONFigure:CURRent?

Query Return Returns the leakage current type as a string:
ACDC|AC|DC|ACPEAK

Example CONFigure:CURRent DC
Set the leakage current type to DC.

Query Example CONFigure:CURRent?
Return: DC
the leakage current type is DC.

CONFigure:RANGe

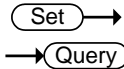

Sets or queries the current range of leakage current.



Note

- When the following configurations, which include the network F, the applicable standard year 2020 and the measure frequency 0.1Hz, are set, AUTO Range can't be set.
- HOLD4 Range can't be set when leakage current type is ACpeak.
- The set command can only be used in leakage current mode.

Syntax CONFigure:RANGe{AUTO|HOLD1|HOLD2|HOLD3|HOLD4}

Query Syntax CONFigure:RANGe?

Query Return Returns the leakage current range as a string:
AUTO|HOLD1|HOLD2|HOLD3|HOLD4

When AC, DC, AC+DC leakage current is selected (target):

AUTO	Automatic current range
HOLD1	50.00uA range
HOLD2	500.0uA range
HOLD3	5.000mA range
HOLD4	50.00mA range

When ACpeak leakage current is selected:

AUTO	Automatic current range
HOLD1	750.0uA range
HOLD2	7.500mA range
HOLD3	75.00mA range

Example CONFigure:RANGe AUTO
Set the leakage current range to AUTO.

Query Example CONFigure:RANGe?
 Return: AUTO
 the leakage current range is AUTO.

CONFigure:SWITCh

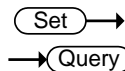

Sets or queries each Medical Ground switch state.



Note

- Some times can't be set for some one. Refer to the Appendix 4 on page 198 for details.
- The set command can only be used in leakage current mode.

Syntax CONFigure:SWITCh
 {string1,string2,string3,string4,string5}
 (SW10, SW12, SW13, SW14, SW15)

Query Syntax CONFigure:SWITCh?

Query Return Returns each Medical Ground switch state as a strings.

```
{string1,string2,st ON : This switch connect to
ring3,string4,stin      Ground.
g5}
OFF : This switch disconnect with
Ground.
```

Example CONFigure:SWITCh OFF,OFF,OFF,OFF,OFF
 Set each Medical Ground switch disconnect with Ground.

Query Example CONFigure:SWITCh ?
 Return: OFF,OFF,OFF,OFF,OFF
 Each Medical Ground switch disconnect with Ground.

Manual Measurement Commands

CONFigure:CONDition	144
CONFigure:APPLy	145
CONFigure:POLarity	146
CONFigure:WTime	147

CONFigure:CONDition

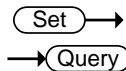

Sets or queries the EUT status when in manual testing.



Note

- Some times can't be set for some one. Refer to the Appendix 2 on page 188 for details.
- The set command can only be used in leakage current mode.
- The command can only be used in manual measurement functon.

Syntax

CONFigure:CONDition
{NORMAL|EARTH|POWersource|LLINE|NLINE}

Query Syntax

CONFigure:CONDition?

Query Return

Returns the EUT status when in manual measurement function as a string.

NORMAL|EARTH|POWERSOURCE|LLINE|NLINE

NORMAL Under normal conditions.

EARTH Disconnected earth line.

POWERSOURCE Disconnected live line.

LLINE Application of voltage from the live line. Normal live line connection.

NLINE Application of voltage from the neutral line.

Example

CONFigure:CONDition NORMAl

Set the leakage current test to normal conditions.

Query Example CONFigure:CONDition ?
 Return: NORMAL
 The leakage current test is normal conditions.

CONFigure:APPLy

Sets or queries the 110% power status when in manual testing.



Note

- Some times can't be set for some one. Refer to the Appendix 2 on page 188 for details.
- The set command can only be used in leakage current mode.
- The command can only be used in manual measurement function.

Syntax CONFigure:APPLy
 {NAPPLy|RAPPLy|OFF}

Query Syntax CONFigure: APPLy?

Query Return Returns the 110% power status when in manual measurement function as a string.

NAPPLY|RAPPLY|OFF

NAPPLY positive phase for 110% voltage application.

RAPPLY Negative phase for 110% voltage application.

OFF Disconnected 110% voltage application.

Example CONFigure: APPLy NAPPLy
 Set the 110% voltage application to positive phase.

Query Example CONFigure: APPLy?
 Return: NAPPLY
 The 110% voltage application is positive phase.

CONFigure:POLarity

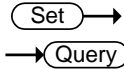

Sets or queries the power supply polarity in manual testing.



Note

- This command can't be set when EUT class is internally powered or when measurement mode of leakage current is Enclosure – Line.
- The set command can only be used in leakage current mode.
- The command can only be used in manual measurement function.

Syntax

CONFigure:POLarity {NORMal|REVerse}

Query Syntax

CONFigure:POLarity?

Query Return

Returns the polarity of the power supply in manual measurement function as a string t

NORMal|REVerse

NORMal positive polarity

REVerse negative polarity

Example

CONFigure:POLarity NORMal

Sets the power supply to positive polarity.

Query Example

CONFigure:POLarity?

Return: NORMal

The polarity of the power supply is currently set to positive.

CONFigure:WTIME

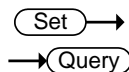

Sets or queries the wait time in manual function. Range: 1~999 seconds.



Note

- The set command can only be used in leakage current mode.
- The command can only be used in manual measurement function.

Syntax

CONFigure:WTIME <NR1>

Query Syntax

CONFigure:WTIME?

Query Return

Returns the wait time value under manual mode.

<NR1>s 1~999 seconds.

Example

CONFigure:WTIME 8

When in manual mode, sets the wait time to 8 seconds.

Query Example

CONFigure:WTIME?

Return: 8s

Returns the wait time for manual mode.

Automatic Measurement Commands

AMC	148
CONFigure:AMITem:CONDition.....	148
CONFigure:AMITem:APPLy.....	150
CONFigure:AMITem:POLarity	151
CONFigure:AMTime	152
CONFigure:AMTime:WAI	153

AMC

→ Query

Queries the automatic measurement completion.



Note

The set command can only be used in leakage current mode.

Query Syntax

AMC ?

Query Return

Returns automatic measurement condition as a numeric value (NR1).

0: In automatic measurement

1: Automatic measurement completed

Query Example

AMC?

1

Automatic measurement has been completed.

CONFigure:AMITem:CONDition

Set →

→ Query

Configures or queries EUT status of auto measurement settings. The settings must be compatible with the measuring network, class and leakage mode. Refer to the Appendix 2 on page 188 for details. Any bits that are set to 1 indicate that the corresponding mode/function is set.



Note

- The set command can only be used in leakage current mode.
- The command can only be used in Automatic function.

Syntax CONFigure:AMITem:CONDition {NR1,NR1}

Query Syntax CONFigure:AMITem:CONDition?

Query Return First vaule : <NR1> Returns a 3-bit integer (0~7).
 Second vaule : <NR1> Returns a 2-bit integer (0~3).

First vaule

128	64	32	16	8	4	2	1
bit7	bit6	bit5	bit4	bit3	bit2	bit1	bit0
					EARTH	POWer-source	NORMAL

Second vaule

128	64	32	16	8	4	2	1
bit7	bit6	bit5	bit4	bit3	bit2	bit1	bit0
						NLINE	LLINE

- NORMAL Under normal conditions.
- POWersource Disconnected live line.
- EARTH Disconnected earth line.
- LLINE Application of voltage from the live line. Normal live line connection.
- NLINE Application of voltage from the neutral line. Normal neutral line connection.

Example CONFigure: AMITem:CONDition 3,0

EUT status Of automatic measurement items include: normal power supply, disconnected live line.

Query Example CONFigure: AMITem:CONDition?
 Return: 3,0
 normal power supply and Power source disconnected
 is The EUT status of auto measurement settings.

CONFigure:AMITem:APPLY

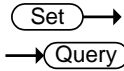

Configures or queries the 110% power status of auto measurement settings. The settings must be compatible with the measuring network, class and leakage mode. Refer to the appendix 2 on page 188 for details. Any bits that are set to 1 indicate that the corresponding mode/function is set.



Note

- The command can only be used in Automatic function.
- The set command can only be used in Leakage current function.

Syntax CONFigure:AMITem: APPLy {NR1 }

Query Syntax CONFigure:AMITem: APPLy?

Query Return <NR1> Returns a 3-bit integer (1~7).

128	64	32	16	8	4	2	1	
bit7	bit6	bit5	bit4	bit3	bit2	bit1	bit0	
						OFF	RAPPLY	NAPPLY

NAPPLY positive phase for 110% voltage application.

RAPPLY Negative phase for 110% voltage application.

OFF Disconnected 110% voltage application.

Example CONFigure: AMITem: APPLy 3

The 110% power status of automatic measurement items include: positive phase, Negative phase.

Query Example CONFigure: AMITem:APPLY?
 Return: 3
 positive phase and Negative phase is The 110% power of auto measurement settings.

CONFigure:AMITem:POLarity (Set) →
 → (Query)

Configures or queries the power supply polarity of auto measurement settings.



Note

- The command can only be used in Automatic function.
- The set command can only be used in Leakage current function.
- This command can't be set when EUT class is internally powered or when measurement mode of leakage current is Enclosure – Line.

Syntax CONFigure:AMITem:POLarity {NR1 }

Query Syntax CONFigure:AMITem: POLarity?

Query Return <NR1> Returns a 3-bit integer (1~3).

128	64	32	16	8	4	2	1	
bit7	bit6	bit5	bit4	bit3	bit2	bit1	bit0	
							REVerse NORMAL	

NORMAL positive polarity
 REVerse negative polarity

Example CONFigure: AMITem:POLarity 3

The power supply polarity of automatic measurement items include: positive phase, Negative phase.

Query Example CONFigure: AMITem:POLarity?

Return: 3
 positive phase and Negative phase is The power supply polarity of auto measurement settings.

CONFigure:AMTime

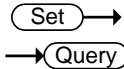

Sets or queries the auto measurement duration, ranging from 2~999 seconds.



Note

- The command can only be used in Automatic function.
- The set command can only be used in Leakage current mode.

Syntax

CONFigure:AMTime <NR1>

Query Syntax

CONFigure:AMTime?

Query Return

Returns the auto measurement time value.

<NR1>s 2~999 secs.

Example

CONFigure:AMTime 2

Set the duration of the auto measurement to 2 secs.

Query Example

CONFigure:AMTime?

2s

Returns the auto measurement time (2 seconds).

CONFigure:AMTime:WAI

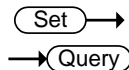

Sets or queries the wait time in automatic mode. Range: 1~999 seconds.



Note

- The command can only be used in Automatic function.
- The set command can only be used in Leakage current mode.

Syntax

CONFigure:AMTime:WAI <NR1>

Query Syntax

CONFigure:AMTime:WAI?

Query Return

Returns the wait time value under auto mode.

<NR1>s 1~999 seconds.

Example

CONFigure:AMTime:WAI 8

When in automatic mode, sets the wait time to 8 seconds.

Query Example

CONFigure:AMTime:WAI?

Return: 8s

Returns the wait time for automatic mode.

Measure Commands

START	154
STOP	154

START



Starts the measurement.

Syntax START

Example START
 Starts the measurement.

STOP



Stops the measurement.

Syntax STOP

Example STOP
 Stops the measurement.

Measurement Data Commands

MEASure?155

MEASure?

→ Query

Queries the measurement value.



Note

The command can only be used in Leakage current mode.

Query Syntax

MEASure?

Query Return

Returns the 4 values and 5 strings.

<value1>	The test number: Always 1 in manual function.
<value2>	The test counter of test numbe: Always 1 -1 in manual function.
<value3>	The maximum value in Amps
<value4>	The now value in Amps
<string 1>	Test /Judgment state: READY /WAIT / TEST / PASS /FAIL_H / FAIL_L PASS: Measurement is within upper and lower judgment limits (PASS) FAIL_H: Measurement is greater than the upper limit (FAIL-U) FAIL_L: Measurement is less than the lower limit (FAIL-L)
< string 2>	Power supply polarity: NORMAL / REVERSE NORMAL: Positive polarity REVERSE: Negative polarity

< string 3> Equipment status:
 NORMAL /E_OPEN /N_OPEN
 LIVE / NEUTRAL
 NORMAL: Normal conditions
 N_OPEN: Disconnected live line.
 E_OPEN: Disconnected earth line.
 LIVE: Normal live line connection
 conditions. Application of voltage
 from the live line.
 NEUTRAL: Normal neutral line
 connection conditions. Application
 of voltage from the neutral line.

< string 4> voltage application :
 110%N / 110%R / 110OFF ; INT/
 EXT
 110%N : Positive phase, 110%
 voltage application.
 110%R: Negative phase, 110%
 voltage application.
 INT: Uses internal contact.
 (internal contact and terminal P2)
 EXT: Uses external contact.
 (terminals P1 and P2)

< string 5> Leakage current type:
 AC / DC / AC+DC / AC PEAK

Query Example MEASure?
 02,
 02 – 01,+1.031E-03,+1.001E-03, PASS, NORMAL,
 NORMAL,-----,AC + DC,

Save Data Commands

MEMory:NUMBer.....	157
MEMory:IDENtity	157
MEMory:MEASure	158
MEMory:SAVE.....	160
MEMory:SAVE:AUTO	160

MEMory:NUMBer

→ Query

Queries the data where the file no. is recorded and saved.



Note

The command can only be used in Leakage current mode.

Query Syntax MEMory:NUMBer?

Query Return Returns the number of data files, ranging from 1~1000.

Query Example MEMory:NUMBer?

Return: 7

A total of 7 measurement records have been saved.

MEMory:IDENtity

→ Query

Queries the assigned file's name and time it was last updated.



Note

The command can only be used in Leakage current mode.

Query Syntax MEMory:IDENtity? <NR1>

<NR1> Memory number, range: 1~1000.

Query Return Returns three strings <string1>, <string2>, <string3>

<string1> File name.

<string2> File number

<string3> Time of the last update.

Query Example MEMory:IDENTity? 6
 Return: CeL,NO-6, 2018/08/08 08:08:08.
 Where CeL is the name of the file. 6 is the file number
 and 2018/08/08 08:08:08 is the update time.

MEMory:MEASure → Query

Queries the measurement values.



Note

The command can only be used in Leakage current mode.

Query Syntax

MEMory:MEASure? <NR1>

<NR1> Memory number, range 1~1000.

Query Return

Returns 3 values , 5 strings

< value1>
 <value2>, < value3>, < string 1>, < string 2>, < string
 3>, < string 4>,< string 5>

< value1>	total test number ; 1~24
<value2>	Maximum, in Amps
<value3>	Nowvalue, in Amps
< string 1>	Judgment state: PASS /FAIL_H / FAIL_L PASS: Measurement is within upper and lower judgment limits (PASS) FAIL_H: Measurement is greater than the upper limit (FAIL-U) FAIL_L: Measurement is less than the lower limit (FAIL-L)
< string 2>	Power supply polarity: NORMAL / REVERSE NORMAL: Positive polarity

	REVERSE: Negative polarity
< string 3>	Equipment status: NORMAL /E_OPEN /N_OPEN LIVE / NEUTRAL NORMAL: Normal conditions N_OPEN: Disconnected live line. E_OPEN: Disconnected earth line. LIVE: Normal live line connection conditions. Application of voltage from the live line. NEUTRAL: Normal neutral line connection conditions. Application of voltage from the neutral line.
< string 4>	voltage application : 110%N / 110%R / 110OFF ; INT/ EXT 110%N : Positive phase, 110% voltage application. 110%R: Negative phase, 110% voltage application. INT: Uses internal contact. (internal contact and terminal P2) EXT: Uses external contact. (terminals P1 and P2)
< string 5>	Leakage current type: AC / DC / AC+DC / AC PEAK

Query Example MEASure:AUTO?6
 04,
 +1.031E-03,+1.001E-03, PASS, NORMAL, NORMAL,--
 -----,AC + DC,
 +1.024E-03,+1.003E-03, PASS, NORMAL, N_OPEN,---
 -----,AC + DC,
 +1.040E-03,+1.010E-03, PASS,REVERSE, NORMAL,----
 ----,AC + DC,
 +1.019E-03,+0.999E-03, PASS,REVERSE, N_OPEN,-----
 ---,AC + DC,

MEMory:SAVE



Manual saves measurement results, including file name, file no., instrumentation class, medical network application, network, measurement mode, measurement type, leakage current, leakage current range, maximum limit, minimum limit, measuring conditions, power supply polarity and measurement items.



Note The set command can only be used in Leakage current mode.

Syntax MEMory:SAVE:AUTO

Example MEMory:SAVE:AUTO
 Enable auto saves automatic measurement results.

MEMory:SAVE:AUTO



Enable auto saves automatic measurement results, including file name, file no., instrumentation class, medical network application, network, measurement mode, measurement type, leakage current, leakage current range, maximum limit, minimum limit, measuring conditions, power supply polarity and automatic measurement items.



Note The set command can only be used in Leakage current mode.

Syntax MEMory:SAVE:AUTO

Example MEMory:SAVE:AUTO
 Enable auto saves automatic measurement results.

System Setup Commands

SYSTem:MODE	161
SYSTem:EUT	162
SYSTem:FREQuency	162
SYSTem:BACKlight	163
SYSTem:BEEPer:VOL	163
SYSTem:BEEPer:COMParator	164
SYSTem:BEEPer:KEY	165
SYSTem:BEEPer:T3OUT	166
SYSTem:FILE:NAME	167
SYSTem:DATA:NAME	167
SYSTem:CLEar:MEASure	168
SYSTem:CLEar:PANel	168
SYSTem:DATE	169
SYSTem:TIME	169
SYSTem:FILE	170
SYSTem:LOAD	174
SYSTem:SAVE	174
SYSTem:TEST:VA	174

SYSTem:MODE

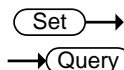

Sets or queries the meter mode.

Syntax	SYSTem:MODE {LC VOLT PCC EUT}
Query Syntax	SYSTem:MODE ?
Query Return	Returns a string indicating which now meter mode. LC : which Leakage current meter VOLT : which voltage meter PCC : which protective conductor current meter EUT : which equipment under test mode
Example	SYSTem:MODE LC Sets the meter mode is Leakage current meter

Query Example SYSTem:MODE ?
 Return: LC
 The meter mode is Leakage current meter

SYSTem:EUT (Set) →
 → (Query)

Sets or queries the output terminal and polarity of EUT power.



Note

The set command can only be used in Leakage current mode.

Syntax SYSTem:EUT < output >,< polarity >

Query Syntax SYSTem:EUT?

Query Return Returns the power output state :< output >,< polarity >.

output FRONT | REAR(string)

polarity LN| NL(string)

Example SYSTem:EUT FRONT,LN

Sets the output terminal to FRONT and polarity to LN.

Query Example SYSTem:EUT?

FRONT, LN

Returns the EUT power output terminal, polarity.

SYSTem:FREQuency (Set) →
 → (Query)

Sets or queries the frequency level of measurement.



Note

The set command can only be used in Leakage current mode or voltage mode.

Syntax SYSTem:frequency {"15Hz" | "0.1Hz"}

Query Syntax SYSTem: frequency?

Query Return Returns a string indicating which frequency level.

15Hz : measurement frequency higher than 15Hz.

	0.1Hz: measurement frequency lower than 15Hz
Example	SYSTem:frequency "15Hz" Sets the measurement frequency level is 15Hz.
Query Example	SYSTem: frequency? Return: 15Hz The measurement frequency higher than 15Hz.

SYSTem:BACKlight

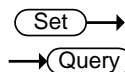

Sets or queries the brightness level of the LCD display.

 Note	The set command can only be used in Leakage current mode.
Syntax	SYSTem:BACKlight <NR1> <NR1> Range: 1~5
Query Syntax	SYSTem:BACKlight?
Query Return	Returns the brightness level of the LCD display. 1~5 1:darkest ; 5:brightest
Example	SYSTem:BACKlight 2 Sets the LCD brightness level is 2.
Query Example	SYSTem:BACKlight? Return: 2 The LCD brightness leve is 2.

SYSTem:BEEPer:VOL

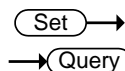

Sets or queries the buzzer volume.

 Note	The set command can only be used in Leakage current mode.
Syntax	SYSTem:BEEPer:VOL <NR1> <NR1> Range: 1~3

Query Syntax SYSTem:BEEPer:VOL?

Query Return Returns the buzzer volume.
 1~3 1:lowest ; 3:highest

Example SYSTem:BEEPer:VOL 2
 Sets the buzzer volume is 2.

Query Example SYSTem:BEEPer:VOL?
 Return: 2
 The buzzer volume is 2.

SYSTem:BEEPer:COMParator

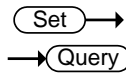

Sets or queries the alarm tone for judgment events.

 **Note** The set command can only be used in Leakage current mode.

Syntax SYSTem:BEEPer:COMParator {FAIL|PASS|OFF}

Query Syntax SYSTem:BEEPer:COMParator?

Query Return Returns a string indicating which event produces an alarm tone.

 FAIL The alarm tone will sound when a measurement is outside the upper and/or lower judgment limits (FAIL)

 PASS The alarm tone will sound when a measurement is within the upper and/or lower judgment limits (PASS)

 OFF The alarm tone is set to off.

Example SYSTem:BEEPer:COMParator PASS
 Sets the alarm tone to sound when a measurement passes.

Query Example SYSTem:BEEPer:COMParator?
 Return: PASS
 The alarm tone is set to on for a PASS measurement.

SYSTem:BEEPer:KEY

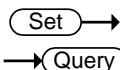

Sets or queries whether a tone is set for key entry (button presses).

**Note**

The set command can only be used in Leakage current mode.

Syntax

SYSTem:BEEPer:KEY {ON|OFF}

Query Syntax

SYSTem:BEEPer:KEY?

Query Return

Returns a string to indicate if a tone will sound when a key is pressed.

ON

A tone will sound when a key is pressed

OFF

No tone will sound for key presses.

Example

SYSTem:BEEPer:KEY OFF

Turns off the tone sound for key entry.

Query Example

SYSTem:BEEPer:KEY?

Return: OFF

The tone sound for key entry is set to off.

SYSTem:BEEPer:T3OUT

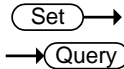

Sets or queries the tone sound of the P3 output when the voltage output is at 110%.



Note

The set command can only be used in Leakage current mode.

Syntax

SYSTem:BEEPer:T3OUT {ON|OFF}

Query Syntax

SYSTem:BEEPer:T3OUT?

Query Return

Returns the beeper status (on or off when the P3 output is at 110%).

ON

The beeper is set to on when the P3 voltage output is at 110%.

OFF

The beeper is set to off when the P3 voltage output is at 110%.

Example

SYSTem:BEEPer:T3OUT ON

Turn on the beeper when the P3 voltage output is at 110%.

Query Example

SYSTem:BEEPer:T3OUT?

Return: ON

The beeper is on.

SYSTem:FILE:NAME

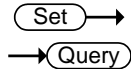

Sets or queries the panel name for save.



Note

- Only alphanumeric characters (A-Z, a-z, 0-9) and the “_” underscore character can be used.
- The set command can only be used in Leakage current mode.

Syntax SYSTem:FILE:NAME <”string”>

Query Syntax SYSTem:FILE:NAME?

Query Return Returns 8 character string

Example SYSTem:FILE:NAME “123_pan”
The panel name for save is 123_pan.

Query Example SYSTem:FILE:NAME?
Return: 123_pan

SYSTem:DATA:NAME

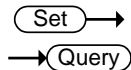

Sets or queries the measurement data name for save.



Note

- Only alphanumeric characters (A-Z, a-z, 0-9) and the “_” underscore character can be used.
- The set command can only be used in Leakage current mode.

Syntax SYSTem:DATA:NAME <”string”>

Query Syntax SYSTem: DATA:NAME?

Query Return Returns 8 character string

Example SYSTem: DATA:NAME “123_ data”
The measurement data name for save is 123_data.

Query Example SYSTem: DATA:NAME?
Return: 123_ data

SYSTem:CLEar:MEASure

Set →

Clears all the saved measurement data.



Note

- All the saved values will be deleted after this command is executed.
- The set command can only be used in Leakage current mode.

Syntax

SYSTem:CLEar:MEASure {ALL}

Example

SYSTem:CLEar:MEASure ALL

Clears all the saved measurement data.

SYSTem:CLEar:PANel

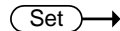
Set →

Clears one or all the panel settings that are saved.



Note

- This command will clear all saved panel settings.
- The set command can only be used in Leakage current mode.

Syntax

SYSTem:CLEar:PANel{NR1 |ALL}

Example

SYSTem:CLEar:PANel ALL

All the panel contents are cleared after executing the command.

SYSTem:DATE

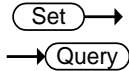

Sets or queries the system date.

Syntax SYSTem:DATE <Year>,<Month>,<Day>

Query Syntax SYSTem:DATE?

Query Return Returns the system date:<Year>,<Month>,<Day>.

Year 2000~2099(<NR1>)

Month 1~12(<NR1>)

Day 1~31(<NR1>)

Example SYSTem:DATE 2018,11,26

Sets the system date to November 26, 2018

Query Example SYSTem:DATE?

2018,11,26

Returns the year, month and day.

SYSTem:TIME

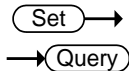

Sets or queries the current system time.

Syntax SYSTem:TIME <Hour>,<Minutes>,<Sec>

Query Syntax SYSTem:TIME?

Query Return Returns the the system time
<Hour>,<Minutes>,<Sec>.

Hour 0 ~23(<NR1>), 24 hours

Minutes 0 ~59(<NR1>)

Sec 0 ~59(<NR1>)

Example SYSTem:TIME 15,30,27

Set the system time to 15:30:27.

Query Example `SYSTem:TIME?`
 Return: 15:30:27 (System time is 15:30:27).

`SYSTem:FILE` → Query

Queries all the contents of a panel settings.

 **Note** The set command can only be used in Leakage current mode.

Query Syntax `SYSTem:FILE? <NR1>`
 `<NR1>` File number, ranging from 1~30.

Query Return 21 character/number strings are returned:

<code><string1></code>	File number
<code><string2></code>	File name
<code><string3></code>	Instrument class level: CLASS1 / CLASS2 / INTERNAL INTERNAL: Internally powered
<code><string4></code>	Application type of Medical network: B / BF /CF
<code><string5></code>	Network (Circuit network): A ~I 、 EXT
<code>< string6></code>	Network filter: ON /OFF forC2 、 C3 and F network. --for other network.
<code>< string7></code>	Measurement frequency: 15Hz / 0.1Hz
<code>< string8></code>	Measurement mode: EARTH ENCLOSURE1 ENCLOSURE 2 ENCLOSURE3 PATIENT1 PATIENT2 PATIENT3 PA UXILIARY TOUCH1 TOUCH2 TOUCH3

	PATIENTP2E PATIENTSIPSOP PATIENTFTYPE PATIENTMP TPATIENTP2E TPATIENTSIPSOP TPATIENTFTYPE TPATIENTMP FR EE
< string9>	Measurement method: AUTO / MANU
< string10>	Leakage current type: AC /DC /AC+DC /ACPEAK
< string11>	Measurement range: AUTO HOLD1 HOLD2 HOLD3 HO LD4 When the leakage current type is AC, DC or AC+DC: HOLD1: 50.00uA range HOLD2: 500.0uA range HOLD3: 5.000mA range HOLD4: 50.00mA range When the leakage current type is AC Peak: HOLD1: 750.0uA range HOLD2: 7.500mA range HOLD3: 75.00mA range
<Num value1> (NR3)	Upper limit of current in normal condition (unit : A) /OFF
<Num value2> (NR3)	Lower limit of current in normal condition (unit : A) /OFF
<Num value3> (NR3)	Upper limit of current in Single-fault condition (unit : A) /OFF
<Num value4> (NR3)	Lower limit of current in Single-fault condition (unit : A) /OFF

<Num value5> Medical Ground switch (NR1)							
128	64	32	16	8	4	2	1
bit7	bit6	bit5	bit4	bit3	bit2	bit1	bit0
SW15 SW14 SW13 SW12 SW10							
<Num value6> Power supply polarity item: (NR1) bit0 : positive phase bit1 : negative phase							
<Num value7> EUT status item: (NR1)							
128	64	32	16	8	4	2	1
bit7	bit6	bit5	bit4	bit3	bit2	bit1	bit0
NLINE LLINE EARTH POWersource NORMAl							
<Num value8> 110% voltage application item: (NR1)							
128	64	32	16	8	4	2	1
bit7	bit6	bit5	bit4	bit3	bit2	bit1	bit0
OFF RAPPLY NAPPLY							
<Num value8> measurement wait time in seconds. (NR1) Ns							
<Num value9> measurement measuring time in (NR1) seconds. Ns always OFF in manual measurement funcion							

Query Example SYSTem:FILE? 1
 Return:
 NO.01,PANEL 01
 CLASS1,--,D,--,15Hz,TOUCH1,MANU,AC +
 DC,AUTO,3.500E-03,OFF,5.500E-03,OFF,0,1,1,0
 ,1s,OFF

The 1th file has the following configuration:

File No.	NO.01
File name	PANEL 01
Equipment class	CLASS-I
Application type of Medical network	--
Network	D
Network filter	--
Measurement frequency	15Hz
Measurement mode	Touch Enclosure - earth leakage
Measurement method	Manual
Leakage current type	AC + DC
Leakage current range	AUTO
Upper limit level in normal condition	3.5mA
Lower limit level in normal condition	OFF
Upper limit level in single-faultcondition	5.5mA
Lower limit level in single-faultcondition	OFF
Medical Ground switch	NONE
Power supply polarity item	Pos phase

EUT status item	Normal
110% voltage application item	NONE
Measurement wait time	1s
Measurement measuring time	OFF

SYSTem:LOAD (Set) →
→ (Query)

Loads panel settings from memory.

 **Note** The set command can only be used in Leakage current mode.

Syntax SYSTem:LOAD <NR1>
 <NR1> Range: 1~30

Example SYSTem:LOAD 6
 Loads the panel settings from file no. 6.

SYSTem:SAVE (Set) →

Saves panel settings to memory.

 **Note** The set command can only be used in Leakage current mode.

Syntax SYSTem:SAVE <NR1>
 <NR1> Range: 1~30.

Example SYSTem:SAVE 3
 Saves the panel settings to file no. 3.

SYSTem:TEST:VA → (Query)

Performs a VA check of a device under test.

 **Note** The set command can only be used in EUT mode.

Query Syntax SYSTem:TEST:VA?

Query Return Returns 5 Numbered values:

<num value1>	The voltage between the live and neutral lines (NR3). (unit : V)
<num value2>	The load current (NR3). (unit : A)
<num value3>	The VA value (voltage X current) (NR3). (unit : VA)
<num value4>	The voltage between the live and earth lines (NR3). (unit : V)
<num value5>	The voltage between the neutral and earth lines (NR3). (unit : V)

Query Example SYSTem:TEST:VA?
+3.869E+01, +1.294E+01, +5.008E+02, +3.319E+01,
+3.319E+01
The result is described as below:
The voltage between a live line and neutral line:
+3.869E+01 V
Load current: +1.294E+01 A
VA value: +5.008E+02 VA
The voltage between a live line and earth contact:
+3.319E+01 V
The voltage between a neutral and earth contact:
+3.319E+01 V

System Related Commands

SYSTem:ERRor	176
*IDN?	176
*CLS	177

SYSTem:ERRor

→ Query

Reads error information of the previous error. See the error information table.

Query Syntax	SYSTem:ERRor?
Query Return	Returns an error string that includes an error code and an error description.
Query Example	SYSTem:ERRor? Return: 20,Command Error

*IDN?

→ Query

Shows the instrument identification.

Query Syntax	*IDN?
Query Return	Returns a string that includes instrument manufacturer, model, serial number and version.
Query Example	*IDN? Return: GW Instek,GLC10000 ,123456789 ,V1.00 GW Instek: Manufacturer GLC10000 : Model 123456789 : Model serial number V1.00 : Firmware version number

***CLS**→ **Query**

Clears the internal registers and error message, if any.

Syntax *CLS

RS232 Interface Commands

SYSTem:LOCal..... 17;

SYSTem:LOCal**Set** →

Sets the machine to local mode.

Syntax SYSTem:LOCal

Voltage mode Commands

CONFigure:VOLTage	178
CONFigure:VOLTage:RANGe	179
MEASure:VOLTage?	180

CONFigure:VOLTage



Sets and queries the target voltage



Note

- When measure frequency is 0.1Hz, the target voltage ACpeak can't be set.
- The set command can only be used in voltage mode.

Syntax CONFigure:VOLTage {ACDC|AC|DC|ACPeak}

Query Syntax CONFigure: VOLTage?

Query Return Returns the target voltage as a string:
ACDC|AC|DC|ACPEAK

Example CONFigure: VOLTage DC
Set the target voltage to DC.

Query Example CONFigure: VOLTage?
Return: DC
DC is the target voltage.

CONFigure:VOLTage:RANGe

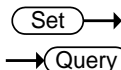

Sets or queries the voltage range.



- AUTO Range can't be set when measure frequency is 0.1Hz.
- HOLD4 Range can't be set when target voltage is ACpeak.
- The set command can only be used in voltage mode.

Syntax

CONFigure:VOLTage:RANGe
{AUTO|HOLD1|HOLD2|HOLD3| HOLD4}

Query Syntax

CONFigure:VOLTage:RANGe?

Query Return

Returns the voltage range as a string:
AUTO|HOLD1|HOLD2|HOLD3|HOLD4
When AC, DC, AC+DC voltage type is selected (target):

AUTO	Automatic voltage range
HOLD1	50.00uA range
HOLD2	500.0uA range
HOLD3	5.000mA range
HOLD4	50.00mA range

When ACpeak voltage type is selected:

AUTO	Automatic voltage range
HOLD1	750.0uA range
HOLD2	7.500mA range
HOLD3	75.00mA range

Example

CONFigure: VOLTage:RANGe AUTO
Set the voltage range to AUTO.

Query Example CONFigure: VOLTage:RANGe?
 Return: AUTO
 the voltage range is AUTO.

MEASure:VOLTage? → Query

Queries the measurement value.



Note

The set command can only be used in voltage mode.

Query Syntax MEASure:VOLTage?

Query Return Returns the value.

<value> (NR3) The now value in volt

Query Example MEASure:VOLTage?

+1.031E-03

Protective conductor current mode Commands

CONFigure:PCC.....	181
CONFigure:PCC:RANGe	182
MEASure:PCC?	183

CONFigure:PCC

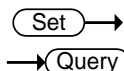

Sets or queries the protective conductor current type.



Note

The command can only be used in protective conductor current mode.

Syntax

CONFigure:PCC {ACDC|AC|DC|ACPeak}

Query Syntax

CONFigure: PCC?

Query Return

Returns the protective conductor current type as a string: ACDC|AC|DC|ACPEAK

Example

CONFigure:PCC DC

Set the protective conductor current type to DC.

Query Example

CONFigure:PCC?

Return: DC

DC is the protective conductor current type.

CONFigure:PCC:RANGe

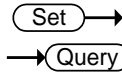

Sets or queries the protective conductor current range.



Note

The command can only be used in protective conductor current mode.

Syntax

CONFigure:PCC:RANGe{HOLD1|HOLD2}

Query Syntax

CONFigure:PCC:RANGe?

Query Return

Returns the protective conductor current range as a string: HOLD1|HOLD2

When AC, DC, AC+DC protective conductor current is selected (target):

HOLD1 10.00mA range

HOLD2 50.00mA range

When ACpeak protective conductor current is selected:

HOLD1 10.00mA range

HOLD2 75.00mA range

Example

CONFigure:PCC:RANGe HOLD1

Set the protective conductor current range to 10mA.

Query Example

CONFigure:PCC:RANGe?

Return: HOLD1

10mA is the protective conductor current range.

MEASure:PCC?

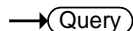

Queries the measurement value.



Note

The command can only be used in protective conductor current mode.

Query Syntax

MEASure:PCC?

Query Return

Returns the value.

<value> (NR3) The now value in Amps

Query Example

MEASure:PCC?

+1.031E-03

Error information Commands

Error information183

Error information



Background

The possible error messages returned from SYST:ERR? query are well listed below.

Code	Description
0	No Error
20	Command Error
21	Value Error
22	String Error
23	Query Error
24	Mode Error
25	Not ready/finish state
26	Not test state
27	Method Err
30	Not suit network

32	Not Medical network
33	Leakage Current Set Error
34	Measure Type Set Error
35	Measure Range Set Error
36	Normal Current HI SET Error
37	Normal Current LOW SET Error
38	Fault Current HI SET Error
39	Fault Current LOW SET Error
40	Ground Switch Set Error
42	Polarity Set Error
43	Power Item Set Error
44	Medical Item Set Error
45	Wait Time Set Error
46	Measure Time Set Error
50	Panel Number Set Error
51	Data Memory Set Error
52	Memory Full
60	Read Buffer Full
61	Send Buffer Error

Appendix for Commands

Appendix 1 - Leakage Current Mode Table

Under Network A, B, E, H, I, EXT

Machine Status \ Measurement Mode	CLASS-I	CLASS-II	Int Power
Earth leakage current	●	--	--
Enclosure to earth leakage current	●	●	●
Enclosure to enclosure leakage current	●	●	●
Enclosure to line leakage current	●	●	--
Free current	●	●	●



Note

Free current can be set which only in netwok I or EXT.

Under Network C1, C2, C3, D, G

Machine Status \ Measurement Mode	CLASS-I	CLASS-II	Int Power
Earth Leakage current	●	--	--
Touch current - enclosure to earth	●	●	●
Touch current - enclosure to enclosure	●	●	●
Touch current - enclosure to line	●	●	--

Under Network F and IEC60601-1 of 1995

Machine Status	CLASS-I			CLASS-II			Int Power		
Applied Part	B	BF	CF	B	BF	CF	B	BF	CF
Measurement Mode	B	BF	CF	B	BF	CF	B	BF	CF
Earth leakage current	●	●	●	--	--	--	--	--	--
Enclosure to earth leakage current	●	●	●	●	●	●	●	●	●
Enclosure to enclosure leakage current	●	●	●	●	●	●	●	●	●
Patient auxiliary current	●	●	●	●	●	●	●	●	●
Patient leakage current I	●	●	●	●	●	●	●	●	●
Patient leakage current II	●	--	--	●	--	--	●	--	--
Patient leakage current III	--	●	●	--	●	●	--	●	●
Free current	●	●	●	●	●	●	●	●	●

Under Network F and IEC60601-1 of 2020

Machine Status	CLASS-I			CLASS-II			Int Power		
Applied Part	B	BF	CF	B	BF	CF	B	BF	CF
Measurement Mode	B	BF	CF	B	BF	CF	B	BF	CF
Earth leakage current	•	•	•	--	--	--	--	--	--
Touch current – enclosure to earth	•	•	•	•	•	•	•	•	•
Touch current – enclosure to enclosure	•	•	•	•	•	•	•	•	•
Patient auxiliary current	•	•	•	•	•	•	•	•	•
Patient leakage current (Patient connection - Earth)	•	•	•	•	•	•	•	•	•
Patient leakage current (external voltage on SIP/SOP)	•	•	•	•	•	•	•	•	•
Patient leakage current (external voltage on a specific F-type applied part)	--	•	•	--	•	•	--	•	•
Patient leakage current (external voltage on metal accessible part not protectively earthed)	•	•	--	•	•	--	•	•	--
Total patient leakage current (Patient connection - Earth)	•	•	•	•	•	•	•	•	•
Total Patient leakage current (external voltage on SIP/SOP)	•	•	•	•	•	•	•	•	•
Total Patient leakage current (external voltage on a specific F-type applied part)	--	•	•	--	•	•	--	•	•
Total Patient leakage current (external voltage on metal accessible part not protectively earthed)	•	•	--	•	•	--	•	•	--
Free current	•	•	•	•	•	•	•	•	•

Appendix 2 – Test Condition Table

Under Network A, B, E, H, I ,EXT

Machine Status : CLASS-I

Condition \ Measurement Mode	Normal	Power line disconnect	Earth disconnect	Live line output	Neutral line output
Earth leakage current	●	●	--	--	--
Enclosure to earth leakage current	●	●	●	--	--
Enclosure to enclosure leakage current	●	●	●	--	--
Enclosure to line leakage current	--	--	--	●	●
Free current	●	●	●	--	--

Machine Status : CLASS-II

Condition \ Measurement Mode	Normal	Power line disconnect	Earth disconnect	Live line output	Neutral line output
Earth leakage current	--	--	--	--	--
Enclosure to earth leakage current	●	●	--	--	--
Enclosure to enclosure leakage current	●	●	--	--	--
Enclosure to line leakage current	--	--	--	●	●
Free current	●	●	--	--	--

Machine Status : Int Power

Measurement Mode \ Condition	Normal	Power line disconnect	Earth disconnect	Live line output	Neutral line output
	Earth leakage current	--	--	--	--
Enclosure to earth leakage current	●	--	--	--	--
Enclosure to enclosure leakage current	●	--	--	--	--
Enclosure to line leakage current	--	--	--	--	--
Free current	●	--	--	--	--



Note

Free current can be set which only in network I or EXT only.

Under Network C1, C2, C3, D, G

Machine Status : CLASS-I

Measurement Mode \ Condition	Normal	Power line disconnect	Earth disconnect	Live line output	Neutral line output
	Earth leakage current	●	●	--	--
Touch current – enclosure to earth	●	●	●	--	--
Touch current – enclosure to enclosure	●	●	●	--	--
Touch current – enclosure to line	--	--	--	●	●

Machine Status : CLASS-II

Condition \ Measurement Mode	Condition				
	Normal	Power line disconnect	Earth disconnect	Live line output	Neutral line output
Earth leakage current	--	--	--	--	--
Touch current – enclosure to earth	●	●	--	--	--
Touch current – enclosure to enclosure	●	●	--	--	--
Touch current – enclosure to line	--	--	--	●	●

Machine Status : Int Power

Condition \ Measurement Mode	Condition				
	Normal	Power line disconnect	Earth disconnect	Live line output	Neutral line output
Earth leakage current	--	--	--	--	--
Touch current – enclosure to earth	●	--	--	--	--
Touch current – enclosure to enclosure	●	--	--	--	--
Touch current – enclosure to line	--	--	--	--	--

Under Network F and IEC60601-1 of 1995

Machine Status : CLASS-I

Condition \ Measurement Mode	Normal	Power line disconnect	Earth disconnect	Application of 110% voltage :		
				Positive	Negative	OFF
Earth leakage current	●	●	--	--	--	--

Enclosure to earth leakage current	•	•	•	•	•	•
Enclosure to enclosure leakage current	•	•	•	•	•	•
Patient auxiliary current	•	•	•	--	--	--
Patient leakage current I	•	•	•	--	--	--
Patient leakage current II	--	--	--	•	•	--
Patient leakage current III	--	--	--	•	•	--
Free current	•	•	•	•	•	•

Machine Status : CLASS-II

Condition	Normal	Power line disconnect	Earth disconnect	Application of 110% voltage :		
				Positive	Negative	OFF
Measurement Mode						
Earth leakage current	--	--	--	--	--	--
Enclosure to earth leakage current	•	•	--	•	•	•
Enclosure to enclosure leakage current	•	•	--	•	•	•
Patient auxiliary current	•	•	--	--	--	--
Patient leakage current I	•	•	--	--	--	--
Patient leakage current II	--	--	--	•	•	--
Patient leakage current III	--	--	--	•	•	--
Free current	•	•	--	•	•	•

Machine Status : Int Power

Condition \ Measurement Mode	Normal	Power line disconnect	Earth disconnect	Application of 110% voltage :		
				Positive	Negative	OFF
Earth leakage current	--	--	--	--	--	--
Enclosure to earth leakage current	•	--	--	•	•	•
Enclosure to enclosure leakage current	•	--	--	•	•	•
Patient auxiliary current	•	--	--	--	--	--
Patient leakage current I	•	--	--	--	--	--
Patient leakage current II	--	--	--	•	•	--
Patient leakage current III	--	--	--	•	•	--
Free current	•	--	--	•	•	•



Note

- Patient leakage current II can be set in B applied part only .
- Patient leakage current III can be set in BF /CF applied part only.

Under Network F and IEC60601-1 of 2020

Machine Status : CLASS-I

Condition \ Measurement Mode	Normal	Power line disconnect	Earth disconnect	Application of 110% voltage :		
				Positive	Negative	OFF
Earth leakage current	•	•	--	--	--	--
Touch current – enclosure to earth	•	•	•	•	•	•
Touch current – enclosure to enclosure	•	•	•	•	•	•

Patient auxiliary current	•	•	•	--	--	--
Patient leakage current (Patient connection - Earth)	•	•	•	--	--	--
Patient leakage current (external voltage on SIP/SOP)	•	•	•	•	•	--
Patient leakage current (external voltage on a specific F-type applied part)	--	--	--	•	•	--
Patient leakage current (external voltage on metal accessible part not protectively earthed)	--	--	--	•	•	--
Total patient leakage current (Patient connection - Earth)	•	•	•	--	--	--
Total Patient leakage current (external voltage on SIP/SOP)	•	•	•	•	•	--
Total Patient leakage current (external voltage on a specific F-type applied part)	--	--	--	•	•	--
Total Patient leakage current (external voltage on metal accessible part not protectively earthed)	--	--	--	•	•	--
Free current	•	•	•	•	•	•

Machine Status : CLASS-II

Condition \ Measurement Mode	Normal	Power line disconnect	Earth disconnect	Application of 110% voltage :		
				Positive	Negative	OFF
Earth leakage current	--	--	--	--	--	--
Touch current – enclosure to earth	•	•	--	•	•	•

Touch current – enclosure to enclosure	•	•	--	•	•	•
Patient auxiliary current	•	•	--	--	--	--
Patient leakage current (Patient connection - Earth)	•	•	--	--	--	--
Patient leakage current (external voltage on SIP/SOP)	•	•	--	•	•	--
Patient leakage current (external voltage on a specific F-type applied part)	--	--	--	•	•	--
Patient leakage current (external voltage on metal accessible part not protectively earthed)	--	--	--	•	•	--
Total patient leakage current (Patient connection - Earth)	•	•	--	--	--	--
Total Patient leakage current (external voltage on SIP/SOP)	•	•	--	•	•	--
Total Patient leakage current (external voltage on a specific F-type applied part)	--	--	--	•	•	--
Total Patient leakage current (external voltage on metal accessible part not protectively earthed)	--	--	--	•	•	--
Free current	•	•	--	•	•	•

Machine Status : Int Power

Condition \ Measurement Mode	Normal	Power line disconnect	Earth disconnect	Application of 110% voltage :		
				Positive	Negative	OFF
Earth leakage current	--	--	--	--	--	--

Touch current – enclosure to earth	•	--	--	•	•	•
Touch current – enclosure to enclosure	•	--	--	•	•	•
Patient auxiliary current	•	--	--	--	--	--
Patient leakage current (Patient connection - Earth)	•	--	--	--	--	--
Patient leakage current (external voltage on SIP/SOP)	•	--	--	•	•	--
Patient leakage current (external voltage on a specific F-type applied part)	--	--	--	•	•	--
Patient leakage current (external voltage on metal accessible part not protectively earthed)	--	--	--	•	•	--
Total patient leakage current(Patient connection - Earth)	•	--	--	--	--	--
Total Patient leakage current (external voltage on SIP/SOP)	•	--	--	•	•	--
Total Patient leakage current (external voltage on a specific F-type applied part)	--	--	--	•	•	--
Total Patient leakage current (external voltage on metal accessible part not protectively earthed)	--	--	--	•	•	--
Free current	•	--	--	•	•	•



Note

- (Total) Patient leakage current_external voltage on a specific F-type applied part can be set in BF /CF applied part only.
- (Total) Patient leakage current_external voltage on metal accessible part not protectively earthed can be set in B /BF applied part only.

Appendix 3 – Target Current Type Table

Under Network A, B, E, H, I ,EXT

Measurement Mode \ Network	A /B /E /H	I /EXT
Earth leakage current	AC	AC
Enclosure to earth leakage current	DC	DC
Enclosure to enclosure leakage current	AC + DC	AC + DC
Enclosure to line leakage current	ACpeak	--
Free current	--	AC
	--	DC
	--	AC + DC
	--	ACpeak

Under Network C1, C2, C3, D, G

Measurement Mode \ Network	C1 /C2 /C3 /D /G
Earth leakage current	AC
Touch current - enclosure to earth	DC
Touch current - enclosure to enclosure	AC + DC
Touch current - enclosure to line	ACpeak

Under Network F and IEC60601-1 of 1995

Measurement Mode \ Network	F and IEC60601-1 of 1995
Earth leakage current	--
Enclosure to earth leakage current	--
Enclosure to enclosure leakage current	AC + DC
	--
Patient auxiliary current	AC
Patient leakage current I	DC
	--
	--

Patient leakage current II	--
Patient leakage current III	-- AC + DC
Free current	-- AC DC AC + DC ACpeak

Under Network F and IEC60601-1 of 2020

Measurement Mode	Network	F and IEC60601-1 of 2020
Earth leakage current		--
Touch current – enclosure to earth		--
Touch current – enclosure to enclosure		AC + DC
Patient auxiliary current		--
Patient leakage current (Patient connection - Earth)		AC DC
Patient leakage current (external voltage on SIP/SOP)		--
Patient leakage current (external voltage on a specific F-type applied part)		--
Patient leakage current (external voltage on metal accessible part not protectively earthed)		AC + DC --
Total patient leakage current (Patient connection - Earth)		AC DC
Total Patient leakage current (external voltage on SIP/SOP)		-- --
Total Patient leakage current (external voltage on a specific F-type applied part)		--
Total Patient leakage current (external voltage on metal accessible part not protectively earthed)		AC + DC --
Free current		AC DC AC + DC ACpeak

Appendix 4 – Medical Ground Switch Table

Under Network F and IEC60601-1 of 1995

Machine Status	CLASS-I					CLASS-II					Int Power				
Switch	S10	S12	S13	S14	S15	S10	S12	S13	S14	S15	S10	S12	S13	S14	S15
Measurement Mode															
Earth leakage current	●	●	--	--	--	--	--	--	--	--	--	--	--	--	--
Enclosure to earth leakage current	●	●	--	--	--	●	●	--	--	--	--	--	--	--	--
Enclosure to enclosure leakage current	●	●	--	--	--	●	●	--	--	--	--	--	--	--	--
Patient auxiliary current	●	--	--	--	--	●	--	--	--	--	--	--	--	--	--
Patient leakage current I	●	--	●	--	--	●	--	●	--	--	--	--	--	--	--
Patient leakage current II	●	--	●	--	--	●	--	●	--	--	--	--	--	--	--
Patient leakage current III	●	--	●	--	--	●	--	●	--	--	--	--	--	--	--
Free current	●	●	--	--	--	●	●	--	--	--	--	--	--	--	--



Note

- Patient leakage current II can be set in B applied part only.
- Patient leakage current III can be set in BF/CF applied part only .

Under Network F and IEC60601-1 of 2020

Machine Status	CLASS-I					CLASS-II					Int Power				
Switch	S10	S12	S13	S14	S15	S10	S12	S13	S14	S15	S10	S12	S13	S14	S15
Measurement Mode															
Earth leakage current	●	●	--	●	--	--	--	--	--	--	--	--	--	--	--
Touch current – enclosure to earth	●	●	--	●	--	●	●	--	●	--	--	--	--	--	--
Touch current – enclosure to enclosure	●	●	--	●	--	●	●	--	●	--	--	--	--	--	--

Patient auxiliary current	●	--	--	--	--	●	--	--	--	--	--	--	--	--	--
Patient leakage current (Patient connection - Earth)	●	--	●	--	●	●	--	●	--	●	--	--	--	--	--
Patient leakage current (external voltage on SIP/SOP)	●	--	●	--	--	●	--	●	--	--	--	--	--	--	--
Patient leakage current (external voltage on a specific F-type applied part)	●	--	●	--	●	●	--	●	--	●	--	--	--	--	--
Patient leakage current (external voltage on metal accessible part not protectively earthed)	●	--	--	--	--	●	--	--	--	--	--	--	--	--	--
Total patient leakage current (Patient connection - Earth)	●	--	●	--	●	●	--	●	--	●	--	--	--	--	--
Total Patient leakage current (external voltage on SIP/SOP)	●	--	●	--	--	●	--	●	--	--	--	--	--	--	--
Total Patient leakage current (external voltage on a specific F-type applied part)	●	--	●	--	●	●	--	●	--	●	--	--	--	--	--
Total Patient leakage current (external voltage on metal accessible part not protectively earthed)	●	--	--	--	--	●	--	--	--	--	--	--	--	--	--
Free current	●	●	--	●	●	●	●	--	●	●	--	--	--	--	--



Note

- (Total) Patient leakage current_external voltage on a specific F-type applied part can be set in BF/CF applied part only.
- (Total) Patient leakage current_external voltage on metal accessible part not protectively earthed can be set in B/BF applied part only.

EXTERNAL I/O

Features

1. Remote Start/Stop control
2. Recall the last 30 panel settings
3. Output measurement results.
4. Output measurement timing signals
5. Enable internal or external power

Cautions



CAUTION

1. To prevent damage, ensure the power is off before connecting the instrument.
2. Ensure the input voltage or current doesn't exceed the EXT I/O rating.
3. When using a relay, ensure that a protective diode is used to limit surge current.
4. Do not short the input or output terminals.
5. Don't short live and earth lines.
6. Only attempt to operate the instrument after the external I/O port is properly connected.

I/O Definition

Apart from power, all external control signals are active low.

Pin No.	Input/ Output	Signal Name	Description
1	Input	$\overline{\text{KEYLOCK}}$	The key lock is active on a low level signal.
2	Input	$\overline{\text{STOP}}$	Stop the current measurement
3	Input	$\overline{\text{LOAD1}}$	Selects a panel setting to load. LOAD1 is bit 2 of 5
4	Input	$\overline{\text{LOAD3}}$	Selects a panel setting to load. LOAD3 is bit 4 of 5
5	Input	$\overline{\text{TEST}}$	Active when testing
6	---	Reserved	
7	Output	$\overline{\text{PASS}}$	Active on a PASS judgement
8	Output	$\overline{\text{L-FAIL}}$	Active on a FAIL judgement (under lower limit)
9	---	Reserved	
10	Output	5VDC	Internal power supply
11	Output	5VDC	
12	Output	GND-INT	Internal ground
13	Output	GND-INT	
14	Input	$\overline{\text{START}}$	Start the Automatic measurement. Measurement will start when Load0 to LOAD4 are set and START is set to low (active low). The corresponding panel is also read.
15	Input	$\overline{\text{LOAD0}}$	Selects a panel setting to load. LOAD0 is bit 1 of 5

16	Input	$\overline{\text{LOAD2}}$	Selects a panel setting to load. LOAD2 is bit 3 of 5
17	Input	$\overline{\text{LOAD4}}$	Selects a panel setting to load. LOAD5 is bit 5 of 5
18	---	Reserved	
19	Output	$\overline{\text{MEAS}}$	The MEAS signal goes low for each measurement item during automatic measurement.
20	Output	$\overline{\text{H-FAIL}}$	Active on a FAIL judgement (exceeding upper limit)
21	---	Reserved	
22	Input	VDC-EXT	Power supply input from external equipment: 5~24V DC
23	Input	VDC-EXT	
24	Input	GND-EXT	Ground input from external equipment
25	Input	GND-EXT	

LOAD0~LOAD4 control table and corresponding panel settings

Panel no.	$\overline{\text{LOAD4}}$	$\overline{\text{LOAD3}}$	$\overline{\text{LOAD2}}$	$\overline{\text{LOAD1}}$	$\overline{\text{LOAD0}}$
1	1	1	1	1	0
2	1	1	1	0	1
3	1	1	1	0	0
4	1	1	0	1	1
5	1	1	0	1	0
6	1	1	0	0	1
7	1	1	0	0	0
8	1	0	1	1	1
9	1	0	1	1	0
10	1	0	1	0	1
11	1	0	1	0	0
12	1	0	0	1	1
13	1	0	0	1	0

14	1	0	0	0	1
15	1	0	0	0	0
16	0	1	1	1	1
17	0	1	1	1	0
18	0	1	1	0	1
19	0	1	1	0	0
20	0	1	0	1	1
21	0	1	0	1	0
22	0	1	0	0	1
23	0	1	0	0	0
24	0	0	1	1	1
25	0	0	1	1	0
26	0	0	1	0	1
27	0	0	1	0	0
28	0	0	0	1	1
29	0	0	0	1	0
30	0	0	0	0	1

Connection

1. Connect the EXT I/O cable to the EXT I/O terminal on the rear panel.
2. Power on the machine.
3. A remote icon is displayed on the LCD screen when remote connection is established. The KEYLOCK line will be active.
4. Complete all measurements before turning off the instrument.
5. Remove external EXT I/O connections.

Electrical Characteristics

Input Signals

$\overline{\text{KEYLOCK}}$, $\overline{\text{START}}$, $\overline{\text{STOP}}$, $\overline{\text{LOAD0}}$ ~ $\overline{\text{LOAD4}}$

Input Signal	Active Low
Maximum input voltage	24V DC (EXT-DCV), 5VDC (INT-DCV)
High Level	Up to EXT-DCV
Low Level	0.3VDC or less

Output signal

$\overline{\text{TEST}}$, $\overline{\text{MEAS}}$, $\overline{\text{PASS}}$, $\overline{\text{L-FAIL}}$, $\overline{\text{H-FAIL}}$

Output Signal	Open collector
Maximum Output voltage	24V DC (EXT-DCV), 5VDC (INT-DCV)
Minimum Output Current	50mA DC

Internal Power Supply

INT-DCV, INT-GND

Output Voltage	5V DC
Maximum output current	100mA (A large current output may damage the power supply)
Note	To enable internal power; connect INT-DCV and EXT-DCV, INT-GND and EXT-GND.

Internal Circuit Configuration

Prior to using the EXT I/O connection please carefully read the electrical characteristics above and refer to the internal electrical circuit structure below. Ensure EXT-GND and EXT-DCV is connected to drive the circuit I/O. The optocoupler outputs are open-collector outputs with a maximum current of 50mA.

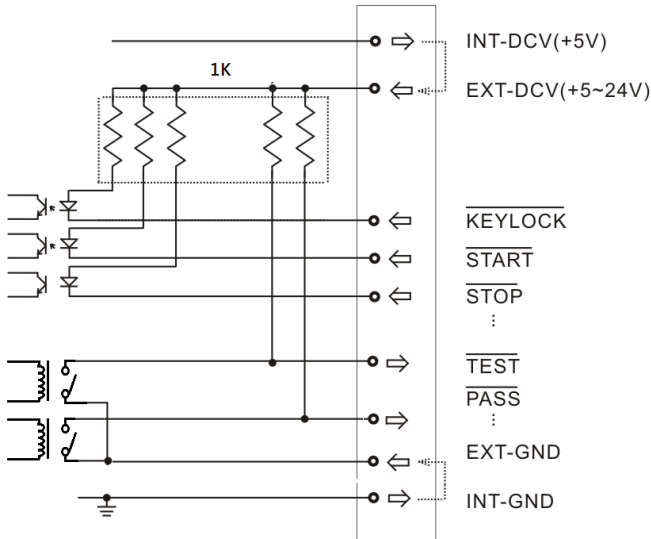

FAQ

Q1. Machine will not turn on.

A1. Ensure the instrument is correctly connected to the mains terminal and that the fuse has not blown.

Q2. The alarm isn't working.

A2. Perform a machine Sound self-test, or check *Beep* inside the *System* menu.

Q3. No voltage is output to the EUT.

A3. Check to see the circuit breaker.

For more information, please contact your nearest distributor or contact GW Instek at:

www.gwinstek.com or marketing@goodwill.com.tw

A PPENDIX

Measurement Functions

Leakage Current Measurement Modes	Earth leakage current
	Enclosure to earth leakage current
	Enclosure to enclosure leakage current
	Enclosure and line leakage current
	Patient leakage current(Patient connection-Earth)
	Patient leakage current(external voltage on a SIP/SOP)
	Patient leakage current(external voltage on a specific F-type applied part)
	Patient leakage current(external voltage on metal accessible part not protectively earthed)
	Total Patient leakage current(Patient connection-Earth)
	Total Patient leakage current(external voltage on a SIP/SOP)
Total Patient leakage current(external voltage on a specific F-type applied part)	
Total Patient leakage current(external voltage on metal accessible part not protectively earthed)	

Leakage Current Type	DC, AC, AC+DC, ACpeak
-------------------------	-----------------------

Maximum allowable measurement current	50mA (rms), 75mA (AC peak)
--	----------------------------

Leakage Current Range	50mA (Max 50.00mA, Resolution 0.01mA) 5mA (Max 5.000mA, Resolution:0.001mA) 500uA (Max 500.0uA, Resolution:0.1uA) 50uA (Max 50.00uA, Resolution:0.01uA)
Range Switch	AUTO, HOLD
110% Voltage Application	P3 output, internal 10k resistance protection
Measurement Terminals	Terminals P1, P2 (50mA fuse protected), P3
Measuring Networks	MD:A, B, C1,C2,C3, D, E, F, G, H, I,

Specifications

Specification accuracy is only applicable when the GLC-10000 has been warmed up for 30 minutes and has an operating temperature of +18°C - +28°C. The specifications below are based on a 1k Ω purely resistive network. For networks B and H scale the range by 1/1.5 and 1/2 respectively.

DC

Ranges	Range	Resolution	Accuracy
50.00mA	4.00mA~50.00mA	10uA	$\pm(2\%rdg+6dgt)$
5.000mA	0.400mA~5.000mA	1uA	$\pm(2\%rdg+6dgt)$
500.0uA	40.0uA~500.0uA	0.1uA	$\pm(2\%rdg+6dgt)$
50.00uA	4.00uA~50.00uA	0.01uA	$\pm 2.0\%fs$

AC/ AC+DC

Ranges	Range	Resolution	Accuracy		
			0.1Hz \cong f<15Hz	15Hz \cong f \cong 100kHz	100kHz< f \cong 1MHz
50.00mA	4.00mA~50.00mA	10uA	$\pm(4.0\%rdg+10dgt)$	$\pm(2.0\%rdg+6dgt)$	$\pm(2.0\%rdg+10dgt)$
5.000mA	0.400mA~5.000mA	1uA	$\pm(4.0\%rdg+10dgt)$	$\pm(2.0\%rdg+6dgt)$	$\pm(2.0\%rdg+10dgt)$
500.0uA	40.0uA~500.0uA	0.1uA	$\pm(4.0\%rdg+10dgt)$	$\pm(2.0\%rdg+6dgt)$	$\pm(2.0\%rdg+10dgt)$
50.00uA	4.00uA~50.00uA	0.01uA	$\pm 4.0\%fs$	$\pm 2.0\%fs$	$\pm 2.0\%fs$

AC Peak

Ranges	Range	Resolution	Accuracy		
			15Hz \cong f \cong 10kHz	10kHz< f \cong 100kHz	100kHz< f \cong 1MHz
75.0mA	5.0mA~75.0mA	100uA	$\pm(2.0\%rdg+6dgt)$	$\pm 5.0\%fs$	$\pm 15\%fs$
7.500mA	0.500mA~7.500mA	1uA	$\pm 2.5\%fs$	$\pm 5.0\%fs$	$\pm 15\%fs$
750.0uA	40.0uA~750.0uA	0.1uA	$\pm 4\%fs$	$\pm 5.0\%fs$	$\pm 20\%fs$

EUT Voltage / Current

Ranges	Range	Resolution	Accuracy
300V	85V~300V	0.1V	$\pm(5\%rdg+10dgt)$
20A	0.5A~20A	0.1A	$\pm(2\%rdg+5dgt)$

Operating Environment

Indoor use
 Altitude: ≤2000 meters
 Ambient Temperature: 0~40°C
 Relative humidity: ≤80%
 Installation category II
 Pollution degree 2

Storage Environment

Temperature: -10~50°C
 Relative humidity: ≤80%

Time of Continuous Operation

It requires stop time for at least 15 minutes after the maximum full-load operation for 15 minutes.

Power Supply

GLC-10000	AC 100V~240V ±10%, 50/60Hz
EUT IN	AC 100V~240V ±10%, 50/60Hz, 20A
EUT OUT Front	AC 100V~240V, 50/60Hz, 10A
EUT OUT Rear	AC 100V~240V, 50/60Hz, 20A

Power Consumption

50VA MAX.

Dimensions

342(W) X 133.87(H) X 348.51(D) mm

Weight

Approximately 7.5kg

Accessories

Standard Accessories

Name	Type	Quantity	Comments
CD (User manual)		1	
Test Lead	GTL-207A	2 sets	
Power Cord		1 set	Region Dependent
Alligator Clips	GLC-01	1 set	2 Red & 2 black per set
Foil Probe	GLC-02	1 piece	
Power Cord	GLC-03	1 set	EUT Power Cord
Terminal Cover	GLC-04	1 set	For Input & Output Terminals

Option

Name	Type	Quantity	Comments
GPIB Card	GLC-10KG1	1 piece	

Optional Accessories

Name	Type	Quantity	Comments
USB Cable	GTL-246	1 piece	USB 2.0, A-B type

Measurement Network (MD)

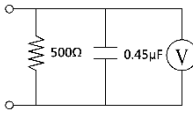
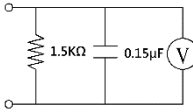
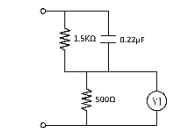
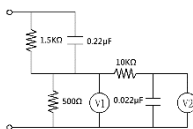
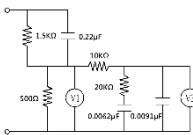
MD	Circuit	R.C. parameters*	Standards Compliance
A		500 Ω // 0.45 μF	UL1563
B		1.5 kΩ // 0.15 μF	UL UL554NP UL1310 UL471
C1		(1.5 kΩ // 0.22 μF) + 500 Ω	IEC 60990:2016 IEC61010-1:2016 GB/T12113:2003 GB4793.1:2007
C2		Basic: (1.5 kΩ // 0.22 μF) + 500 Ω Filter1: 10 kΩ + 22 nF	IEC 60990:2016 IEC61010-1:2016 IEC62368-1:2018 IEC 60598-1:2017
C3		Basic: (1.5 kΩ // 0.22 μF) + 500 Ω Filter2: 10 kΩ + (20 kΩ + 6.2 nF) // 9.1 nF	IEC 60990:2016 IEC60598-1:2017 GB/T12113:2003 GB7000.1:2015

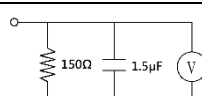
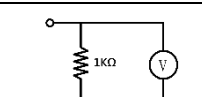
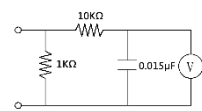
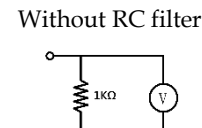
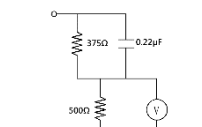
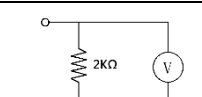
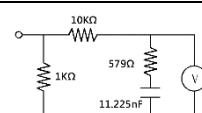
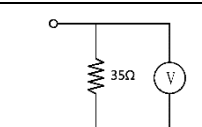
D		150 Ω//1.5 μF	IEC 60598-1:2017 GB 7000.1:2015
E		1k Ω	General
F		Basic: 1 kΩ Filter2: 10 kΩ + 15 nF	IEC 60601-1:2020 3.2rd GB 9706.1:2020 JIS T0601-1:2017
F	Without RC filter 	1 kΩ	IEC 60601-1:2020 3.2rd GB 9706.1:2020 JIS T0601-1:2017
G		(375 Ω//0.22 μF) + 500 Ω	IEC 61010-1:2016 GB4793.1:2007
H		2 kΩ	General
I		Basic: 1 kΩ Filter2: 10 kΩ + 11.22 nF + 579 Ω	JIS (for Electrical Appliance and Material Safety Law)
PC C		35 Ω	Protective Conductor Current

*R1% accuracy C 1% accuracy

Fuse Replacement

- Power Supply Fuse
1. Take out the power cord and remove the fuse socket using a screw driver.

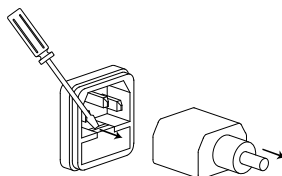

2. Replace the fuse in the holder.

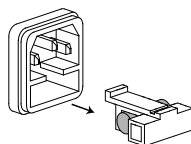

Rating AC 100V~240V $\pm 10\%$, 50/60Hz, T0.63A

- T2 Fuse
1. Turn off the power supply and circuit breakers. Remove the probe leads.
-
2. Gently push the fuse holder and turn 90 degrees counter clockwise by flathead screwdriver to pull the fuse holder out of unit.
 3. Replace with an appropriate fuse.
 4. Insert the fuse holder back into the terminal and turn clockwise 90 degrees.

Rating T50mA/250V

Dimensions

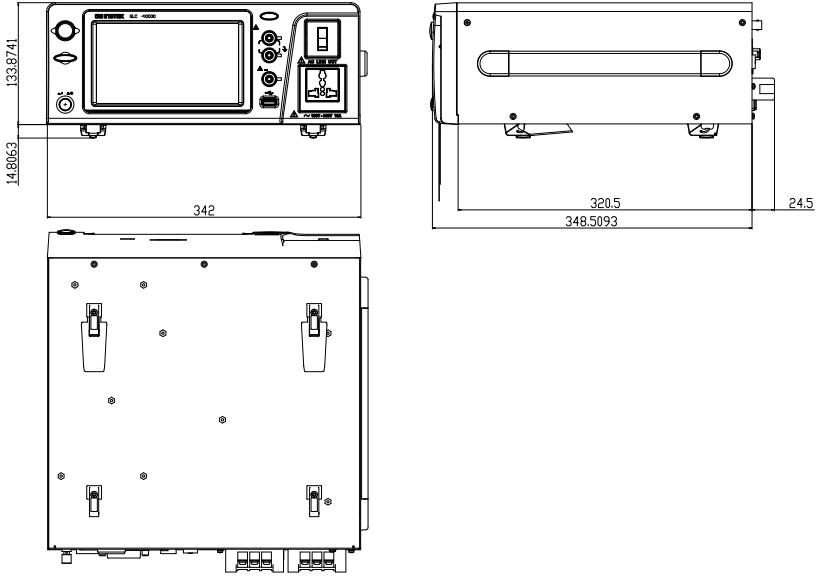

Declaration of Conformity

We

GOOD WILL INSTRUMENT CO., LTD.

declare that the CE marking mentioned product satisfies all the technical relations application to the product within the scope of council:

Directive: EMC; LVD; WEEE; RoHS

The product is in conformity with the following standards or other normative documents:

Ⓢ EMC	
EN 61326-1 :	Electrical equipment for measurement, control and laboratory use — EMC requirements
Conducted & Radiated Emission EN 55011 / EN 55032	Electrical Fast Transients EN 61000-4-4
Current Harmonics EN 61000-3-2 / EN 61000-3-12	Surge Immunity EN 61000-4-5
Voltage Fluctuations EN 61000-3-3 / EN 61000-3-11	Conducted Susceptibility EN 61000-4-6
Electrostatic Discharge EN 61000-4-2	Power Frequency Magnetic Field EN 61000-4-8
Radiated Immunity EN 61000-4-3	Voltage Dip/ Interruption EN 61000-4-11 / EN 61000-4-34
Ⓢ Safety	
EN 61010-1 :	Safety requirements for electrical equipment for measurement, control, and laboratory use - Part 1: General requirements

GOODWILL INSTRUMENT CO., LTD.

No. 7-1, Jhongsing Road, Tucheng District, New Taipei City 236, Taiwan

Tel: [+886-2-2268-0389](tel:+886-2-2268-0389)

Fax: [+886-2-2268-0639](tel:+886-2-2268-0639)

Web: <http://www.gwinstek.com>

Email: marketing@goodwill.com.tw

GOODWILL INSTRUMENT (SUZHOU) CO., LTD.

No. 521, Zhujiang Road, Snd, Suzhou Jiangsu 215011, China

Tel: [+86-512-6661-7177](tel:+86-512-6661-7177)

Fax: [+86-512-6661-7277](tel:+86-512-6661-7277)

Web: <http://www.instek.com.cn>

Email: marketing@instek.com.cn

GOODWILL INSTRUMENT EURO B.V.

De Run 5427A, 5504DG Veldhoven, The Netherlands

Tel: [+31-\(0\)40-2557790](tel:+31-(0)40-2557790)

Fax: [+31-\(0\)40-2541194](tel:+31-(0)40-2541194)

Email: sales@gw-instek.eu

INDEX

A

Accessories	208
Appendix.....	205
Auto mode selection.....	81

B

Basic Theory	21
Block Diagram	21

C

Caution symbol	6
Circuit breaker	33
Cleaning the instrument.....	8
Copy files to USB.....	95
Current selection.....	77

D

Declaration of conformity	213
Disposal Instructions	9

E

Earth leakage current definition.....	23
Earth leakage current operation	48
EN61010 measurement category	7
pollution degree	8
Enclosure and earth leakage current	

definition.....	24
Enclosure and enclosure leakage current definition.....	25
Enclosure and enclosure leakage current operation.....	51
Enclosure and enclosure leakage current operation.....	64
Enclosure and line leakage current operation.....	53
Enclosure leakage current operation.....	49
Environment operation.....	8
storage.....	8
Ethernet interface.....	119
EUT power terminal.....	33
EXT I/O connector	34

F

FAQ	204
Front panel.....	32
Fuse rating (power)	211
rating (T2)	211
replacement (power)	211
replacement (T2)	211
safety instruction	7
socket overview	35

G

GBIP connector.....	34
---------------------	----

Getting Started	38	Measuring Devices	209
Ground		Measuring mode	
symbol.....	6	selection.....	75
Grounding class		Measuring network	
selection	74	selection.....	71, 73
I		Measuring terminals.....	33
I/O		O	
cautions.....	198	Operation	
characteristics.....	202	date and time.....	110, 111, 113
circuit configuration.....	203	EUT current check	102
features	198	EUT voltage check	102
pinout.....	199	recall settings.....	90
K		save settings.....	87
Key features.....	17	screen capture.....	97
L		self test.....	105
LCD display.....	32	serial number.....	112
Leakage current modes		system initialization.....	104
table.....	29	system settings	98
Leakage current modes		tone settings.....	106
definition	23	touch screen settings.....	107
overview	11	USB connection	94
M		voltage measurement	99
Main display.....	66	Operation keys	70
Manual mode		Overview.....	10
selection	81	P	
MD	209	P1	46
MD standards.....	14	P2	46
Measurement		P3	47
save.....	85	Patient leakage current 1	
Measurement flow chart.....	31	connection.....	56
Measurement functions	205	Patient leakage current 2	
Measurement methods		operation.....	58
overview	14	Patient leakage current 3	
Measurement networks	209	operation.....	60, 61, 63
Measurement parameters		Patient leakage current I	
selection	80	definition.....	26
Measurement principals		Patient leakage current II	
overview	13	definition.....	27
Measuring devices		Patient Leakage Current III	
overview	14	definition.....	27, 28
		Power and probe connection....	39
		Power supply	
		socket overview	35
		Power switch	32

Power up 43
Preparation 38

R

Range
 selection 78
Recall settings 90
Remote control 115
 Command list 123, 183
 Command syntax 120
 RS232 117
 USB 116
Reset button 32
RS232 terminal 34

S

Save settings 87
Service operation
 about disassembly 7
Shut down 44

Single fault conditions
 overview 14
Specifications 207
Start button 32

T

Terminal determination table
 operation 46
Touch screen basics 37

U

USB connection 94
USB host port 33

W

Warning indicator 33
Warning symbol 6

