



DIGITAL ONE PIECE AIRFLOW METER WITH CFM DISPLAY

USER'S MANUAL



DCF8906

Please read this manual carefully and thoroughly before using this product.

TABLE OF CONTENTS

Introduction	3
Key Features	4
What's in the Case	4
Product Overview	4 – 8
Setup Instructions	9
Install Battery	9
Operating Instructions	9 – 23
Making Basic Air Speed Measurements	9 – 11
Recording Air Speeds at a Single Point	11 – 13
Displaying the Average Air Speed at Multiple Points	13 – 16
Converting to Airflow Volume Measurements	16 – 19
Switching Between Imperial and Metric Units	20 – 22
Disabling Auto Power Off	22 – 23
Specifications	24
Maintenance Tips	25
Warranty Information	25 – 26
Return for Repair Policy	26

INTRODUCTION

Thank you for purchasing General Tools & Instruments' DCFM8906 Digital One Piece Airflow Meter with CFM Display. Please read this user's manual carefully and thoroughly before using the instrument.

The DCFM8906 is a professional-grade vane anemometer that can not only measure air speeds exiting an HVAC/R system's or blower's grille or register, but also convert those readings to airflow volume measurements. The conversions are possible because the meter makes it easy for an installer or repairman to enter the free area dimensions of his system's output ductwork.

The meter can record air speed readings at one point or multiple points for up to two hours and convert those readings into displays of average, minimum and maximum air speed or airflow volume. The unit can hold measurements made in the dark for later viewing in a brighter area. It also measures ambient air temperature and displays it simultaneously with air speed or airflow volume on a large front-panel LCD.

The DCFM8906 can display its air speed and airflow volume measurements in Imperial or metric units and its temperature measurements in degrees Fahrenheit or Celsius. A 20-minute auto power off function (which can be disabled to enable long-term recordings of air speed) helps extend battery life.

The DCFM8906 is powered by one 9V battery (included).

KEY FEATURES

- Measures and displays air speed and airflow volume in Imperial or metric units
- Simultaneously displays temperature in °F or °C
- One-handed operation
- Records average, minimum and maximum air speed at a single point or multiple points
- Data hold
- Auto power off
- CE and RoHS approved

WHAT'S IN THE CASE

The DCFM8906 comes fully assembled in a custom molded plastic case along with a “9V” battery and this user’s manual.

PRODUCT OVERVIEW

Figure 1 shows the labels and positions of the six control buttons on the front of the DCFM8906. The figure also shows all possible indications on the LCD below the control panel. Familiarize yourself with the buttons’ functions and the meanings of the display indications before moving on to the Setup Instructions.

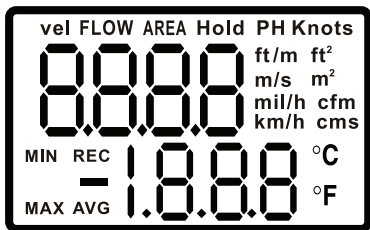
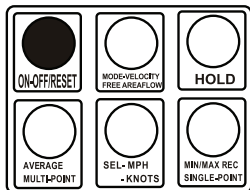
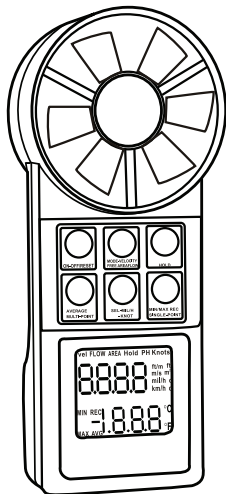

Fig. 1. The DCFM8906's controls and indicators

CONTROL BUTTONS

ON-OFF RESET

Turns meter on and off

When pressed with **AVERAGE** button, resets default air speed and temperature units

When pressed with **HOLD** button, disables auto power off function

MODE VELOCITY FREE AREA FLOW

When pressed, places meter in airflow volume measurement mode

Used with **HOLD** and **AVERAGE** buttons to enter free area dimensions

AVERAGE MULTI-POINT

When pressed, calculates and displays average of stored air speed measurements for up to eight points

Used with **HOLD** and **MODE** buttons to enter free area dimensions in airflow volume measurement mode

When pressed with **ON-OFF RESET** button, resets default air speed and temperature units

HOLD

When pressed, holds (freezes) upper display reading

Used with **MODE** and **AVERAGE** buttons to enter free area dimensions in airflow measurement mode

When pressed with **ON-OFF RESET** button, disables auto power off function

SEL: MPH KNOTS

In Imperial units mode, cycles through mil/h (mph), knots and ft/m default settings

In metric units mode, cycles through km/h, knots, and m/s default settings

MIN/MAX REC SINGLE-POINT

When pressed once, meter begins recording air speed at a single point. Default display is average air speed since recording began

Next press changes display to real-time air speed

Next two presses change display to minimum and maximum air speeds since recording began

Next press returns display to average air speed

All possible display indications and their meanings

vel	Upper reading is an air speed measurement
FLOW	Upper reading is an airflow volume measurement
AREA	Lit during entry of free area dimensions
Hold	Upper and lower readouts are locked (frozen)
PH	Reserved for future use
Knots	Air speed unit equal to 1.85 km/hr (kmph) or 1.15 miles/hr (mph). An upper display unit option in both Imperial and metric modes
ft/m	Feet per minute. An upper display air speed unit in Imperial mode
m/s	Meters per second. An upper display air speed unit in metric mode
mil/h	Miles per hour (mph). An upper display air speed unit in Imperial mode
km/h	Kilometers per hour (kmph). An upper display air speed in metric mode

ft²	Square feet. Lit during entry of free area dimensions in Imperial mode
m²	Square meters. Lit during entry of free area dimensions in metric mode
cfm	Cubic feet per minute. Unit of airflow volume readings in Imperial mode
cms	Cubic meters per second. Unit of airflow volume readings in metric mode
°C	Degrees Celsius. Temperature unit in metric mode
°F	Degrees Fahrenheit. Temperature unit in Imperial mode
REC	Meter is recording air speeds at a single point
AVG	Upper reading is average air speed recorded during session
MIN	Upper reading is minimum air speed recorded during session
MAX	Upper reading is maximum air speed recorded during session
—	Temperature reading on lower display is a negative number
8888 (upper reading)	Digits of air speed, airflow volume or free area value
1888 (lower reading)	Digits of temperature value. When recording air speeds at multiple points, indicates point number (from 1 to 8)

SETUP INSTRUCTIONS

INSTALL BATTERY

The meter's battery compartment is accessible from the back of the unit. Use a Philips-head screwdriver to remove the one screw holding the battery compartment cover in place. Remove the cover and set it aside. Then plug the included 9V battery into the wired socket inside the compartment. The terminals of the battery and the socket mate in only one way, with the smaller male terminal plugging into the larger female terminal. Replace the battery compartment cover and secure it with the Philips-head screw.

OPERATING INSTRUCTIONS

MAKING BASIC AIR SPEED MEASUREMENTS

To power on the meter, press the **ON-OFF RESET** button. The beeper (which cannot be disabled) will sound once and all display indications will appear briefly. After a few seconds, the readings on the upper and lower displays will stabilize. By default, the upper display reads out air speed in ft/m and the lower display reads out temperature in degrees Fahrenheit. These Imperial system defaults are reflected by three indications (Fig. 2): **vel** (at upper left), **ft/m** (to the right of the air speed digits) and **°F** (to the right of the temperature digits).



Fig. 2. The meter's default initial display after being powered on

To make an air speed measurement, place the meter in the airstream leaving the HVAC system duct or register. Be sure to orient the meter so its vanes are centered in the stream and its axes are as perpendicular to the stream as possible (Fig.3).

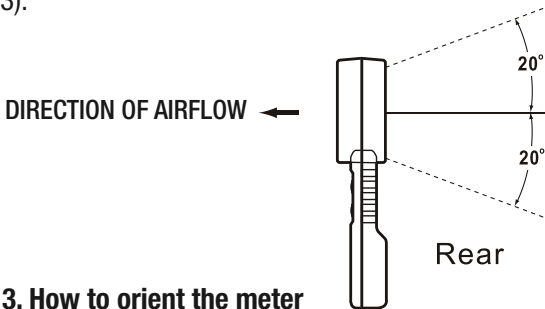

Fig. 3. How to orient the meter

The upper display will read out the real-time air speed in units of ft/m.

To change the Imperial air speed measurement unit from ft/m to miles per hour (mph) or knots, use the **SEL: MPH KNOTS** button. Press the button once and the on-screen display unit will change to **mil/h**. Press the button again and the on-screen text will change to **knots**. Press the **SEL: MPH KNOTS** button again to return to **ft/m** units.

Note: These display unit changes only remain in effect until the meter is powered off. If you wish to use mil/h or knots as your air speed units on a regular basis, you must make the change from ft/m each time you power on the meter.

To hold a measurement, press the **HOLD** button. This sounds the beeper, makes **Hold** appear on the top line of the upper display, and “freezes” both the upper (air speed) and lower (temperature) readings. Doing so makes it possible to make a measurement in a dark place, hold it, and display it later in a better-lighted area. **To release the hold**, press the **HOLD** button again. This sounds the beeper again.

Note: Held readings are deleted when the meter is powered off.

RECORDING AIR SPEEDS AT A SINGLE POINT

The DCFM8906 can record (store) air speeds at a single point during recording sessions lasting up to two hours. Based on these stored measurements, it can calculate and display:

- The average air speed over the duration of the recording session

- The minimum air speed recorded since the session began
- The maximum air speed recorded since the session began

These three air speed readings can be very helpful for comparing the effects of different equipment settings during an HVAC/R system installation or repair.

To initiate recording, place or secure the meter in the airstream and press the **MIN/MAX REC SINGLE-POINT** button. The **REC** and **AVG** indications will initially appear on the upper display to signify that the meter is now 1) recording air speeds and 2) calculating and displaying a continuous moving average of the readings (Fig. 4).

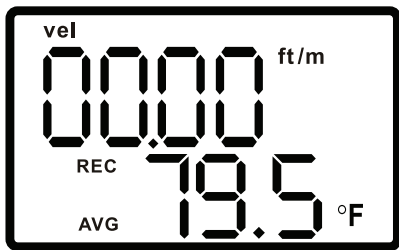

Fig. 4. The initial display after entering recording mode

To change the calculations and displays based on the recorded measurements, use the **MIN/MAX REC SINGLE-POINT** button. With **AVG** showing on the display, pressing the

MIN/MAX REC SINGLE-POINT button will delete that indication, but not **REC**. This signifies that the meter is still recording, but now displaying real-time air speed measurements.

Pressing the **MIN/MAX REC SINGLE-POINT** button again will cause the indication **MIN** to appear. Now the upper display will show the minimum (slowest) air speed recorded since the recording session began.

Pressing the **MIN/MAX REC SINGLE-POINT** button yet again will cause **MAX** to replace **MIN**. The upper display will now show the maximum (fastest) air speed recorded since the recording session began.

Pressing the **MIN/MAX REC SINGLE-POINT** button again will return the display to showing the average air speed, with the indications shown in Fig. 4.

To exit recording mode or clear the stored measurements, press and hold the **MIN/MAX REC SINGLE-POINT** button until the beeper sounds twice. The meter will then resume operating in its default mode: displaying real-time measurements without recording them.

DISPLAYING THE AVERAGE AIR SPEED AT MULTIPLE POINTS

The DCFM8906 can calculate and display the average of air speed measurements made at up to different points. This feature makes it unnecessary to determine the “best” place to

make a performance measurement inside an HVAC/R duct. A multi-point average air speed reading is inherently more representative of a system's output than any single-point reading, whether in the center of a duct or near one of its sides.

To make and store the multiple measurements, use the **HOLD** and **MIN/MAX REC SINGLE-POINT** buttons. Start by positioning the meter's vanes at the first point to be measured. When the reading is stable, press the **HOLD** button. This sounds the beeper, makes **Hold** appear on the top line of the upper display and freezes both readouts—the normal consequences of pressing the **HOLD** button.

Now press the **MIN/MAX REC SINGLE-POINT** button. The beeper will sound and the temperature reading in the lower display will temporarily change to the number 1 to signify that this is the first of several air speed readings stored (Fig. 5).

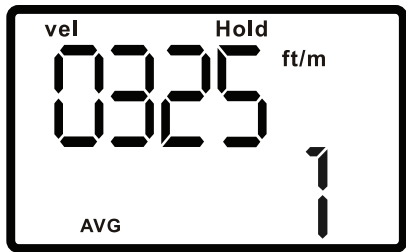

Fig. 5. The brief display indicating storage of a 325 ft/m air speed reading at point 1

Once the lower display resumes showing temperature and the Hold indication disappears, make and store another air speed measurement at a second point by pressing the **HOLD** and **MIN/MAX** buttons in order again. This will sound the beeper and briefly replace the temperature reading in the lower display by the number 2.

Repeat the above two-step sequence up to six more times to make and store up to eight measurements at eight different points. When you are finished, press the **AVERAGE MULTI-POINT** button to display the average of the measurements on the upper readout and the number of points sampled on the lower readout (Fig. 6).

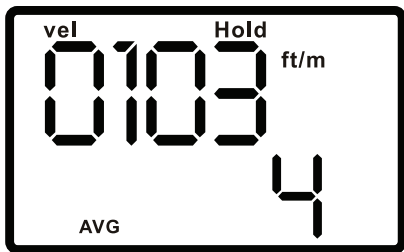

Fig. 6. A display indicating that the average air speed measured at four different points was 103 ft/m

Displays with the **AVG** indication remain on-screen until you clear them, unlike the brief displays created during multi-point measurement storage. **To return the meter to its default operating mode**—displaying real-time air speed

readings on the upper readout—without clearing the meter's multi-point memory, press the **HOLD** button. To clear the multi-point memory, press and hold the **AVERAGE MULTI-POINT** button until the beeper sounds twice.

CONVERTING TO AIRFLOW VOLUME MEASUREMENTS

The DCFM8906 can make and display real-time, maximum, minimum and average airflow volume measurements at a single point or multiple points. To enable the meter to make these measurements, you must enter the free area dimensions of the grille or register through which the air source flows. The meter then multiplies this area by air speed measurement(s) for that point or points to determine any airflow volume value (real-time, maximum, minimum, or average) desired.

As a practical matter, General recommends entering the free air dimensions of the grille or register whose output you are measuring before measuring the air speed through it. If you enter the area ahead of time, you can quickly display the airflow volume associated with any air speed by pressing one button, without having to stop to enter the target area.

To enter the free area dimensions of a grille or register, power the meter on and press the **MODE VELOCITY FREE AREA FLOW** button. The lower readout will go blank and the upper readout will display the value 1.111 ft² (with the first digit flashing) under the indication **AREA** (Fig. 7).

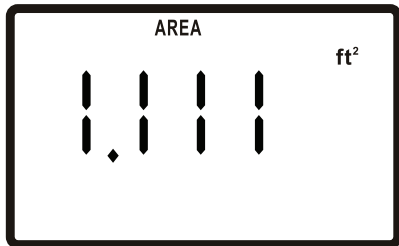

Fig. 7. The initial display produced by pressing the MODE button

The value you need to enter is the area of the grille or register. Inspect the grille or register to determine whether the manufacturer stamped its area somewhere on it. If you do not see a number followed by the unit ft^2 , measure the area yourself.

Enter the free area one digit at a time. The largest value you can enter is 9.999 ft^2 , and the smallest is 0.001 ft^2 .

To enter the first digit, press the **HOLD** as many times as needed until the first (flashing) digit on the display matches the first digit of the free area. Then press the **AVERAGE MULTI-POINT** button to move on to the next digit, which will begin flashing. Press the **HOLD** button repeatedly until the second digit matches, and then store that digit by pressing the **AVERAGE MULTI-POINT** button. Repeat the sequence twice more to finish entering the free area.

To display the real-time airflow volume measurement associated with a real-time air speed measurement at a single point, press the **MODE** button. Note that doing so 1) causes the word **FLOW** to appear on the top line of the upper readout and 2) changes the unit at the right of the displayed value from **fpm** to **cfm** (an abbreviation of cubic feet per minute, or ft³/min).

To return to displaying the air speed at the single point, press the **MODE** button again. Note that doing so 1) causes the indicator **vel** to replace **FLOW** on the top line and 2) changes the unit at the right of the displayed value from **cfm** to **fpm**.

To display the average, minimum or maximum airflow volume at a single point, follow the procedures in the section, Recording Air Speeds at a Single Point, on pp. 11 – 13 that ultimately produce the display shown in Fig. 4. Then press the **MODE** button to generate the free area display screen. If the area requires adjustment, now is the time to change its value using Fig. 7 and the procedures at the beginning of this section as guides.

Once the area is correct as displayed, press the **MODE** button again to convert the average air speed value in fpm to an average airflow volume value in cfm. Pressing the **MIN/MAX REC SINGLE-POINT** button again switches the display to showing real-time measurements—in this case, measurements of airflow volume. As with air speed measurements, each subsequent press of the **MIN/MAX REC**

SINGLE-POINT button advances the display to the next step in a four-step cycle comprising average, real-time, minimum and maximum measurements.

To exit recording mode or clear the stored measurements, press and hold the **MIN/MAX REC SINGLE-POINT** button until the beeper sounds twice. The meter will then resume displaying real-time airflow volume measurements without recording them.

To display the average airflow volume at multiple points, follow the procedures in the section, Displaying the Average Air Speed at Multiple Points, on pp. 13 – 16 that ultimately produce the display shown in Fig. 6. Then press the **MODE** button to generate the free area display screen. If the area requires adjustment, now is the time to change its value using Fig. 7 and the procedures at the beginning of this section as guides.

Once the area is correct as displayed, press the **MODE** button again to convert the average air speed value in fpm to an average airflow volume value in cfm. Note that the new display continues to show the number of points measured at bottom right.

SWITCHING BETWEEN IMPERIAL AND METRIC UNITS

If you prefer to display the meter's air speed and airflow volume measurements in metric units and its temperature readings in Celsius units, you can change the default settings for those values.

To change the default settings from Imperial and Fahrenheit (the factory defaults) to metric and Celsius, start by powering the meter off. Then power it on in a special way by pressing and holding the **AVERAGE MULTI-POINT** button while pressing the **ON-OFF RESET** button once. Continue pressing and holding the **AVERAGE** button until the beeper sounds and the meter powers on with the display shown in Fig. 8.

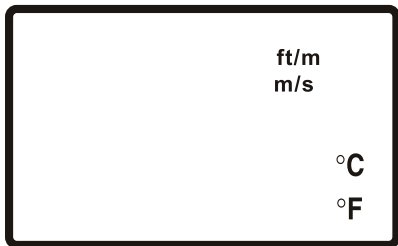

Fig. 8. The initial display for changing default units

As soon as you see this display, release the **AVERAGE** button. Pressing the **HOLD** button at this point makes the **ft/m** and **°F** indications disappear, leaving only **m/s** and **°C** on-screen.

To finish changing the default settings to metric and Celsius units:

- Press the **HOLD** button to make the **ft/m** and **°F** indications disappear, leaving only **m/s** and **°C** on-screen.
- Press the **MIN/MAX** button to make the letter **S** appear on-screen.
- Press the **HOLD** button to make the number **1200** appear on-screen.
- Press the **MIN/MAX** button again to make the letter **S** appear again.
- Press the **HOLD** button again to generate the display shown in Fig. 9.

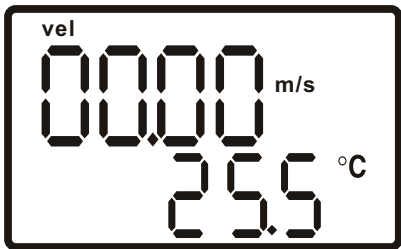

Fig. 9. The display indicating successful conversion to metric and Celsius units.

In metric mode, the only airflow volume unit available is **cms** (an abbreviation of cubic meters per second, or m³/sec). Pressing the **SEL: MPH KNOTS** button repeatedly cycles the air speed units through three available settings: **m/s** (the default), km/h and knots. **To change the default metric air speed measurement unit** from m/s to km/h (kilometers per hour or kmph), press the **SEL: MPH KNOTS** button once. Press it again to change the default air speed unit to knots.

To return to displaying measurements in Imperial and Fahrenheit units, power the meter off and repeat the bulleted procedure above, adding the following step: After pressing the **HOLD** button to make the **ft/m** and **°F** indications disappear, press the **HOLD** button again. This replaces the **m/s** and **°C** indications with the factory-default values **ft/m** and **°F**.

DISABLING AUTO POWER OFF

To avoid wasting battery charge, the DCFM8906 is programmed to power off automatically after 20 minutes of inactivity. Just before this function takes effect, the beeper will sound three times.

There are times when it is desirable to disable the auto power off function—for example, to enable recording of air speed or airflow volume readings for more than 20 minutes.

To disable the auto power off function, you must power the meter off and then power it on in the following special way. Press and hold the **HOLD** button while pressing the **ON-OFF RESET** button once. Continue pressing and holding the **HOLD** button until the beeper sounds and the meter powers on with the display shown in Fig. 10.



Fig. 10. The display indicating that the auto power off function has been disabled.

This display will last for only a few seconds. The meter will then switch to its “normal” operating mode: measuring and displaying real-time air speed values.

Bear in mind that with auto power off disabled, powering off the meter by pressing the **ON-OFF RESET** button undoes the disabling. The next time the meter is powered on, the auto power off function will be enabled.

SPECIFICATIONS

Air Speed Measurement Range	80 to 5900 ft/m (0.4 to 30 m/sec)
Air Speed Measurement Accuracy	±3% of full-scale reading
Sampling Period in Recording Mode	1 second
Airflow Volume Measurement Range	0 to 9,999 cfm (m ³ /min) or cmm (m ³ /min)
Temperature Measurement Range	14° to 122°F (-10° to 50°C)
Temperature Measurement Accuracy/Resolution	±2°F (±1°C)/0.1°
Auto Power Off	After 20 minutes of inactivity
Display Size	1.3 x 1.5 in. (33 x 38mm)
Vane Diameter	2.8 in. (70mm)
Dimensions	7.2 x 3.0 x 1.8 in. (183 x 76 x 45mm)
Weight (with battery)	7.2 oz. (204g)
Power Source	1 “9V” battery (included)

MAINTENANCE TIPS

If the display begins to flash or is blank in response to pressing the **ON-OFF RESET** button, replace the battery by following the Setup Instructions on p. 9.

Remove the battery before storing the meter for an extended period of time.

Do not drop or disassemble the meter or immerse it in water.

WARRANTY INFORMATION

General Tools & Instruments' (General's) DCFM8906 Digital One Piece Meter with CFM Display is warranted to the original purchaser to be free from defects in material and workmanship for a period of one year. Subject to certain restrictions, General will repair or replace this instrument if, after examination, the company determines it to be defective in material or workmanship.

This warranty does not apply to damages that General determines to be from an attempted repair by non-authorized personnel or misuse, alterations, normal wear and tear, or accidental damage. The defective unit must be returned to General Tools & Instruments or to a General-authorized service center, freight prepaid and insured.

Acceptance of the exclusive repair and replacement remedies described herein is a condition of the contract for purchase of this product. In no event shall General be liable for any incidental, special, consequential or punitive damages, or for any cost, attorneys' fees, expenses, or losses alleged to be a consequence of damage due to failure of, or defect in any product including, but not limited to, any claims for loss of profits.

RETURN FOR REPAIR POLICY

Every effort has been made to provide you with a reliable product of superior quality. However, in the event your instrument requires repair, please contact our Customer Service to obtain an RGA (Return Goods Authorization) number before forwarding the unit via prepaid freight to the attention of our Service Center at this address:

General Tools & Instruments
80 White Street
New York, NY 10013
212-431-6100

Remember to include a copy of your proof of purchase, your return address, and your phone number and/or e-mail address.



Specialty Tools & Instruments

GENERAL TOOLS & INSTRUMENTS

80 White Street

New York, NY 10013-3567

PHONE (212) 431-6100

FAX (212) 431-6499

TOLL FREE (800) 697-8665

e-mail: sales@generaltools.com

www.generaltools.com

DCFM8906 User's Manual

Specifications subject to change without notice

©2011 GENERAL TOOLS & INSTRUMENTS

NOTICE - WE ARE NOT RESPONSIBLE FOR TYPOGRAPHICAL ERRORS.

MAN#DCFM8906 7/13/11