



# Inspection and Retrieval Tools – 2015



RT2015

# Go For The Gold!

## Professional Inspection and Retrieval System



**91582**  
Telescoping  
Lighted Magnetic  
Pick-Up

**91555**  
Telescoping  
Lighted Magnetic  
Pick-Up with Small  
Round Mirror

**91557**  
Telescoping  
Lighted Magnetic  
Pick-Up with Large  
Round Mirror

**90557**  
Telescoping  
Round  
Inspection  
Mirror

**92557**  
Telescoping  
Lighted  
Round  
Inspection  
Mirror

The line consists of 13 different products that help professionals and DIYers alike to inspect hard-to-see areas and retrieve hard-to-reach objects. The tools range from inspection mirrors to mechanical and magnetic pick-ups with goose-neck heads in lighted or non-lighted telescoping styles.

**NEW!**

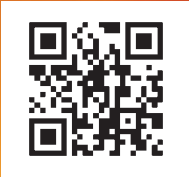

**92560**  
Telescoping  
Lighted  
Rectangular  
Inspection  
Mirror



**90560**  
Telescoping  
Rectangular  
Inspection  
Mirror



**91560**  
Telescoping  
Lighted  
Rectangular  
Inspection  
Mirror

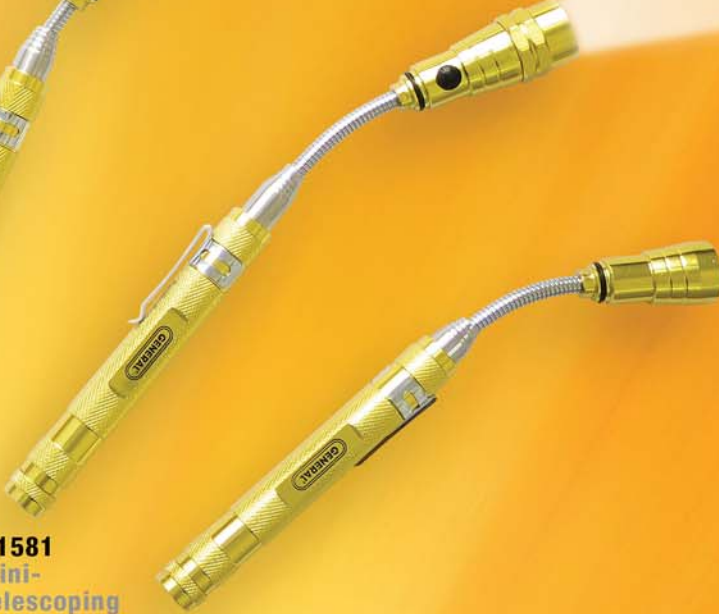

**91581**  
Mini-  
Telescoping  
Lighted  
Magnetic  
Pick-Up



**91383**  
Telescoping  
Magnetic  
Pick-Up

**ALL TOOLS FEATURE:**

- Heavy-duty anodized aluminum bodies for rugged worksite use (in a gold color)
- Grooved telescoping stainless steel shaft; design prevents rotational slipping to ensure secure positioning and pick-up
- Flexible-obedient gooseneck for access into hard-to-reach areas

# Inspection Mirrors



80560



### LIGHTED RECTANGULAR INSPECTION MIRROR – 80560

- 2 Extra bright LED lights facilitate the inspection of hard-to-see and hard-to-reach areas
- Ideal for toolmakers, machinists, inspectors and mechanics
- Fully polished glass mirror is shatter-resistant
- 2 “CF2032” batteries included
- 360° Swivel double ball joint

UPC	NO.	SIZE	OVERALL LENGTH
02146 5	<b>80560</b>	2" x 3"	12-1/4", extends to 33"

80557



### LIGHTED ROUND INSPECTION MIRROR – 80557

- Round head LED inspection mirror gets into tight places and its diffused LED bulbs spread light evenly over the viewing area.
- Ideal for toolmakers, machinists, inspectors and mechanics
- Fully polished glass mirror is shatter-resistant
- 2 “CF2032” batteries included
- 360° Swivel double ball joint

UPC	NO.	SIZE	OVERALL LENGTH
80557 7	<b>80557</b>	1.85" dia"	11-1/2", extends to 34"



70557



70555



### UTILITY TELESCOPING INSPECTION MIRRORS – 70555, 70557

- These mirrors facilitate inspection of inaccessible work pieces and machines by toolmakers, assemblers, inspectors and mechanics
- Fully polished mirrors are enclosed in plated holders which are attached to handles with a double ball and socket joint
- Double ball and socket joints adjust to any angle
- Nos. 70557 have telescoping arms and vinyl cushion grip handles

UPC	NO.	SIZE	OVERALL LENGTH
22344 9	<b>70555</b>	1-3/8" dia.	5" extends to 27-1/2"
22347 0	<b>70557</b>	2-1/4" dia.	9-3/4" extends to 14-3/4"

759570

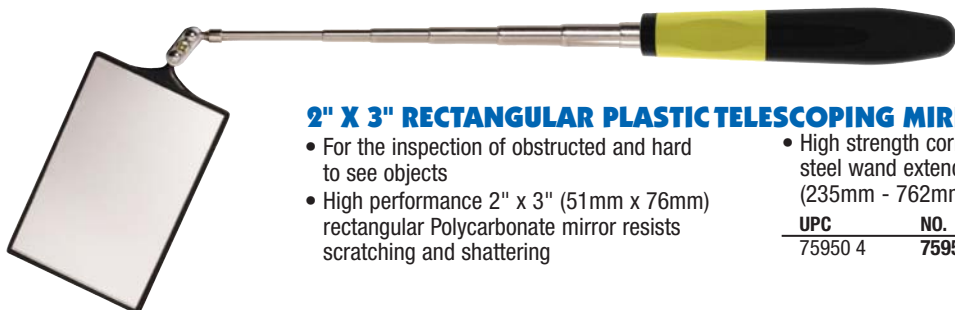

### 2" X 3" RECTANGULAR PLASTIC TELESCOPING MIRROR – 759570

- For the inspection of obstructed and hard to see objects
- High performance 2" x 3" (51mm x 76mm) rectangular Polycarbonate mirror resists scratching and shattering
- High strength corrosion resistant stainless steel wand extends from 9-1/4" to 30" (235mm - 762mm)

UPC	NO.	PKG.
75950 4	<b>759570</b>	Carded

**2-1/2" ROUND TELESCOPING 3X POWER MAGNIFYING MIRROR – 759563**

- For the inspection of obstructed and hard to see objects
- High quality 2-1/2" (64mm) diameter magnifying glass mirror improves visibility
- High strength corrosion resistant stainless steel wand extends from 8-1/2" to 29" (216mm – 737mm)



759563

UPC	NO.	PKG.
75959 7	759563	Carded

**GLASS INSPECTION MIRRORS – 555, 557, 558, 560**

- These mirrors facilitate inspection of inaccessible workpieces and machines by toolmakers, assemblers, inspectors and mechanics
- Fully polished glass mirrors are enclosed in plated holders which are attached to knurled handles with ball and socket joints
- Nos. 557, 577, 560, and 570 have telescoping arms and vinyl cushion grip handles

UPC	NO.	SIZE	OVERALL LENGTH
42465 5	555	1-1/4" dia.	8"
42468 6	557	2-1/4" dia.	10-1/2", extends to 15"
42471 6	558	1" x 2" oval	9"
42473 0	560	3-1/2" x 2" oblong	11-1/2", extends to 16"



560  
570

558

**ACRYLIC PLASTIC INSPECTION MIRRORS – 577, 570**

UPC	NO.	SIZE	OVERALL LENGTH
42480 8	577	2-1/4" dia.	10-1/2" – 15"
42477 8	570	3-1/2" x 2"	11-1/2" – 16"



557  
577

**REPLACEMENT GLASS MIRRORS WITH FRAMES – 557RMF, 560RMF**

UPC	NO.
42478 5	557RMF for No. 557
42484 6	560RMF for No. 560 and No. MB560



555

**MAGNETIC BASE INSPECTION MIRROR – MB560**

- Adjustable 3-1/2" x 2" oblong glass inspection mirror mounted to a permanent magnet
- Attaches to any steel or iron machine, tool, appliance or other equipment
- Has wing nut ball joint adjustment

UPC	NO.
42475 4	MB560



MB560

# INSPECTION AND RETRIEVAL TOOLS

## Inspection Mirrors & Magnifiers



### METAL INSPECTION "FLAME" MIRRORS – 5561, 5562, 5563

- Includes plastic protective sheath
- Heavy-duty construction

UPC	NO.	SIZE	OVERALL LENGTH
05531 3	5561	1-1/4" x 2"	9-3/4", extends to 26"
05562 0	5562	2" x 3-3/4"	10-3/4", extends to 26"
05563 7	5563	3-3/4" dia.	9-3/4", extends to 26"



### EXTRA-LONG TELESCOPING GLASS INSPECTION MIRROR – 559

- 36" telescoping
- Handle has black cushion grip
- Non-slip grip
- Mirror size: 2" diameter

UPC	NO.
05590 3	559

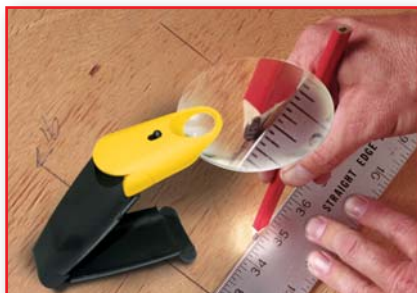

• Hands-Free Use



• 3x Magnification, 6x Inset Lens



• Extra-Bright LED



800543  
Patented

### LumiLENS™ LIGHTED MAGNIFIER – 800543

- Push On / Push Off Powerful LED light
  - Contoured Handle for Handheld Use
  - Integrated Stand for Hands-Free Use
  - Shatter-Resistant Lens
  - 3-1/2" Lens Diameter (89mm)
  - 3X Magnification (6X Inset lens)
  - Power Source: 2 "AA" batteries (included)
- Includes • Protective pouch

UPC	NO.
26001 7	800543

### 4" POWER POCKET ILLUMINATED MAGNIFIER – 553

- Handy 4 power magnifier has plastic body and lens
- Power Source: "AAA" batteries and No. 222 bulb (included)

UPC	NO.	POWER
42456 3	553	4



553

### 4" ILLUMINATED MAGNIFIER – 554

- 4" diameter with three power lens covers large areas of print
- Five power bifocal lens insert gives even greater magnification
- Bulb gives wide circle of illumination
- Plastic body and optical plastic lens
- Power Source: 2 "C" batteries (not included)

UPC	NO.	POWER	FOCAL LENGTH
42462 4	554	3.0	3-1/3"
	Bifocal	5.0	2"



554

### RECTANGULAR ILLUMINATED MAGNIFIER – 565

- Lens measures 2" x 4" for distortion-free magnification of large areas
- Reversible light reflector adapts for right- or left-hand use
- 2.5 power shatterproof lens, with 5 power bifocal insert
- Replaceable bulb
- 2 "AA" batteries (included)

UPC	NO.	POWER	FOCAL LENGTH
42509 6	565	2.5	4"
	Bifocal	5.0	2"



565

### GLASS MAGNIFIERS – 700540, 750542, 750544

- Polished optical glass lens with a metal frame
- Versa-Grip™ Handle with non-slip cushion grip
- Full range of sizes from 2" (50mm) to 4-1/2" (115mm)
- Round lens is distortion free
- A powerful magnifier for working in confined or obstructed spaces
- Designed for demanding jobs in laboratory quality control, inspection and assembly functions
- Used by engineers, mechanics, inspectors, lab technicians, toolmakers, instrument assemblers, jewelers, do-it-yourselfers, hobby and crafts people

UPC	NO.	DIAMETER	POWER	FOCAL LENGTH
00540 3	700540	2" (50mm)	1.6	6"
50542 2	750542	3" (75mm)	1.6	6"
50544 6	750544	4" (100mm)	1.25	8"



750542



700540

# Magnifiers



538

### 2" MAGNIFIER – 538

- Economical and versatile magnifier for laboratory and industrial uses, for do-it-yourselfers, mechanics and inspectors
- 2" diameter with four power lens
- Lightweight, durable 1-piece molded plastic frame

UPC	NO.	POWER	FOCAL LENGTH
42414 3	538	4	2"



532



### 2.5 POWER POCKET MAGNIFIER – 532

- Has 2.5 power ground and polished optical glass
- Folds into case for storage

UPC	NO.	POWER	FOCAL LENGTH
42400 6	532	2.5 Simulated	4"
		Black Leather case	



527



### EYE LOUPE – 527

- For toolmakers, jewelers, instrument assemblers and others who need sharp, clear magnification without eyestrain
- Clear optical glass lens is ground and polished
- 1" diameter lens

UPC	NO.	POWER	FOCAL LENGTH
42339 9	527	5.0	2"



533



536

### FOLDING POCKET MAGNIFIERS – 533, 536, 537

- Fine quality magnifiers for laboratory technicians, engineers, mechanics and inspectors
- Case and lens rims are made of black molded plastic
- Available in single lens and double lens models

UPC	NO.	IND. MOD.	TOT. POW.	LENS POW.	FOCAL DIA.	LENGTH
42403 7	533	Sing.	4.0	4.0	1"	2.5"
42409 9	536	Dble.	4.0	8.0	1"	1.25"
42412 9	537	Dble.	3.0	6.0	1-1/4"	1.6"



950-5



### BINOCULAR MAGNIFIER – 950-5

- For assemblers and inspectors of electronic and other small or subminiature parts, toolmakers, jewelers and engravers
- Leaves hands free to work
- Ground and polished optical lenses eliminate eyestrain
- Tilt-up lens frame
- Fits over prescription glasses

UPC	NO.	POWER	FOCAL LENGTH
43734 1	950-5	2.25	8"



**LIGHTED MECHANICAL & MECHANICAL/MAGNETIC PICK-UPS – 70390, 70391, 70396, 70399**

Lighted mechanical pick-ups are ideal for retrieving items from dark or hard-to-reach areas.

**FEATURES: 70390/70391**

- No. 70390, Lighted Magnetic/Mechanical Pick-Up, 24" (610mm) with Flexi-Shaft™
- No. 70391, Lighted Magnetic/Mechanical Pick-Up, 36" (914mm) with Flexi-Shaft™
- Push on powerful LED light
- Continued pushing opens strong spring steel retrieval claw
- Comfortable ergonomically designed hand control
- Flexible shaft
- Corrosion resistant black finish
- Sliding magnetic sleeve
- Includes 3 "LR41" batteries

UPC	NO.
00000 0	<b>70390</b> 24" (610mm) Patented
00000 0	<b>70391</b> 36" (914mm) Patented
	LR41 replacement battery

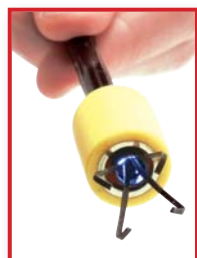

**No. 70390**  
24" (610 mm)

**No. 70391**  
36" (914 mm)

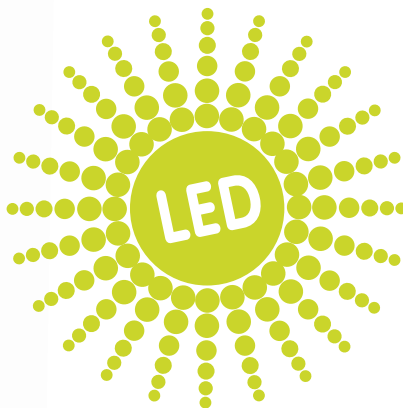

**FEATURES: 70396/70399**

- No. 70396, Lighted Mechanical Pick-Up 24" (610mm) with Flexi-Shaft™
- No. 70399, Lighted Mechanical Pick-Up 36" (914mm) with Flexi-Shaft™
- Push on powerful LED light
- Continued pushing opens strong spring steel retrieval claw
- Comfortable ergonomically designed hand control
- Flexible shaft
- Corrosion resistant black finish
- Includes 3 "LR41" batteries

UPC	NO.
26003 1	<b>70396</b> 24" (610mm) Patented
70393 4	<b>70399</b> 36" (914mm) Patented
	LR41 replacement battery

**No. 70396**  
24" (610 mm)

**No. 70399**  
36" (914 mm)

# Magnetic Pick-ups



759582

## TELESCOPING MINI-LIGHT – 759581 TELESCOPING MINI-LIGHT WITH MAGNETIC PICK-UP – 759582

- Telescoping Mini-light and Telescoping Mini-light with 2 lb. Neodymium magnetic pick-up are both fastened to a stainless steel telescoping wand molded into a rugged high-impact ABS plastic handle
- Both telescopes from 7-3/4" – 28-3/4" (197mm – 720mm)
- 4 Alkaline, "LR41", batteries with a battery life of 48 continuous hours
- LED bulb has a life of 100,000 hours of continuous use

- Mini-light is fastened to a chrome plated brass wand with a double ball joint
- Ball and socket feature for simple, positive adjustments

UPC	NO.	PKG.
75966 5	<b>759581</b>	Carded (light only)
75967 2	<b>759582</b>	Carded (light & magnetic pick-up)



582



## TELESCOPING MINI-LITE WITH MAGNETIC PICK-UP – 582

- A powerful permanent magnetic pick-up tool
- Ideal for retrieving steel and iron parts from hard-to-reach and see work areas
- Telescopes from 7-3/4" – 29" (140mm – 737mm)
- 2 lb. pull Nyodymium magnet is fitted in a 5-1/2" (140mm) long ergonomically designed handle
- 4 Alkaline, "LR41", batteries with a battery life of 48 continuous hours

- Light Bulb has a life of 100,000 hours of continuous use
- Mini-Light is fastened to a chrome plated brass wand with a double ball joint
- Ball and socket feature for simple, positive adjustments

UPC	NO.	PKG.
05820 1	<b>582</b>	Carded



759383  
759398

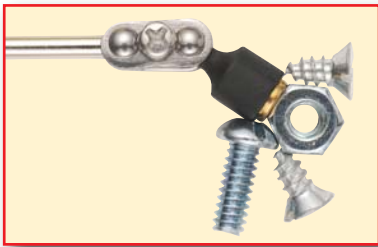

## TELESCOPING MAGNETIC PICK-UPS – 759383, 759398

- High powered 2 lb. and 10 lb. Neodymium magnets are 6 times stronger than standard Cobalt magnets
- Double ball joint connection permits infinite angle adjustments
- High strength corrosion resistant stainless steel wand extends from 6-1/2" - 27" (165mm – 686mm)

- Magnet holder is constructed of high-strength reinforced nylon

UPC	NO.	PULL	PKG.
75933 7	<b>759383</b>	2 lb.	Carded
75939 9	<b>759398</b>	10 lb.	Carded



394

## EXTRA-LONG, MAGNETIC PICK-UP WITH PIVOT JOINT – 394

- An excellent tool for retrieving steel parts from hard-to-reach places
- High-power neodymium magnet lifts up to five pounds and will never lose its magnetism
- Steel body measures 13" (330mm) and can be extended to 27" (686mm)

- Locking pivot joint allows user to pick up objects around corners
- Body is chrome plated, with a vinyl cushion grip handle

UPC	NO.	PULL
42228 6	<b>394</b>	5 lb. pull

### MAGNETIC PICK-UP WITH PIVOT JOINT – 392

- An excellent tool for retrieving small steel parts from hard-to-reach places
- High-power neodymium magnet lifts up to two pounds and will never lose its magnetism
- 8-3/4" (222mm) overall length
- Locking pivot joint allows user to pick up objects around corners
- Nickel plated steel body with cushion grip handle
- Pocket clip for convenient storage

UPC	NO.	PULL
42224 8	392	2 lb. pull



392

### POCKET MAGNETIC PICK-UP – 386

- Powerful permanent magnet in a knurled aluminum holder with handy pocket clip
- High-powered neodymium magnet is six times more powerful than standard magnet
- Ideal for retrieving small steel and iron parts from hard-to-reach areas
- Measures 5-1/2" (140mm) overall
- Pocket clip for convenient storage

UPC	NO.	MAGNET	PULL
42219 4	386	NEO	2 lb. pull



386

### FLEX-O-STIFF MAGNETIC PICK-UP – 384N

- An ideal tool for retrieving steel parts from hard-to-reach places
- High-powered neodymium magnet is six times more powerful than standard magnet
- Permanent magnetic power
- Magnet is fitted into an 18" (457mm) nickel plated holder, which can be extended to a 32" (813mm) flexible retriever

UPC	NO.	MAGNET	PULL
42210 1	384N	NEO	2 lb. pull

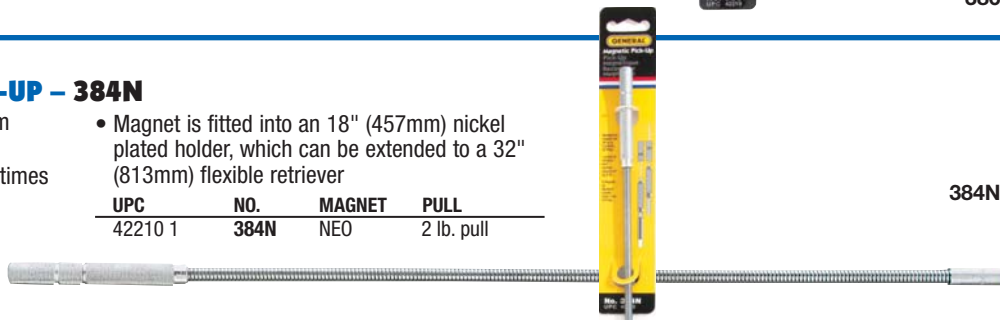

384N

### BENDABLE MAGNETIC PICK-UP – 395

- An excellent tool for retrieving steel parts from hard-to-reach places
- High-power neodymium magnet
- Knurled aluminum body with bendable 15" (381mm) wire
- Overall length is 20" (508mm)
- Lifts up to 2 pounds

UPC	NO.	PULL
42229 3	395	2 lb. pull



395

### TELESCOPING MAGNETIC PICK-UP – 383NX

- A powerful permanent magnetic pickup tool
- Ideal for retrieving steel and iron parts from hard-to-reach work areas
- Magnet is fitted in a 5-1/2" (140mm) long nickel plated steel handle that can extend up to 23-1/2" (597mm)
- Holder is fitted with a pocket-clip

UPC	NO.	PULL
42208 8	383NX	2 lb. pull



383NX

### PRECISION MAGNETIZER/DEMAGNETIZER – 3601

- Magnetize and demagnetize screwdrivers, tweezers, tool bits and other steel objects
- Magnetize by sliding the tool through the (+) opening
- Demagnetize by sliding the tool through the (-) opening
- Demagnetize tools for use in electronics
- Step design permits greater control of magnetism

UPC	NO.	DIMENSIONS
36010 6	3601	2" x 2" x 1-1/8" (58 x 58 x 29mm)



3601

360



### MAGNETIZER/DEMAGNETIZER – 360

- Specially designed for magnetizing and demagnetizing screwdrivers, nut drivers, wrenches, taps and small tools
- Converts any tool blade into a magnetic retriever for screws, nuts and metallic particles

UPC	NO.	DIMENSIONS
42021 3	360	1" x 1" x 1-3/4" (25 x 25 x 44mm)

396

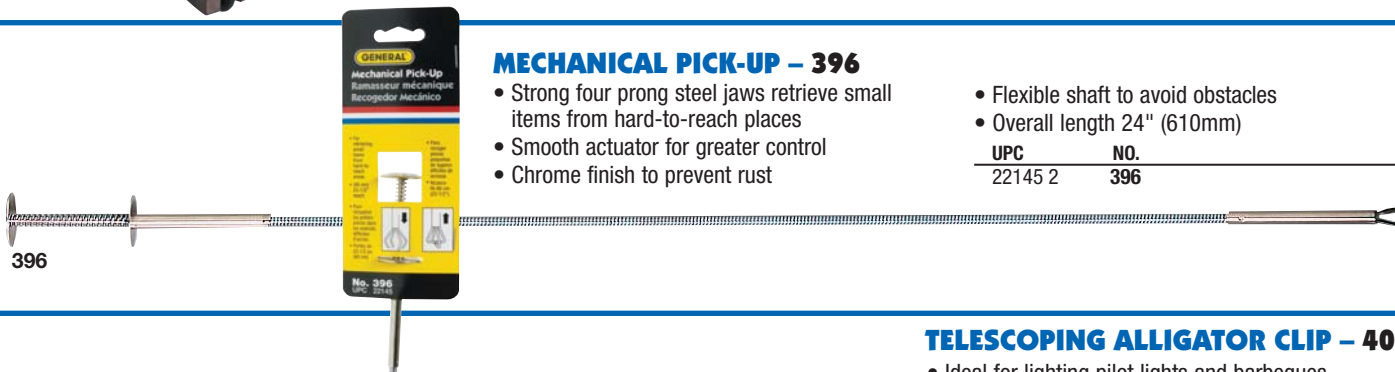

### MECHANICAL PICK-UP – 396

- Strong four prong steel jaws retrieve small items from hard-to-reach places
- Smooth actuator for greater control
- Chrome finish to prevent rust

- Flexible shaft to avoid obstacles
- Overall length 24" (610mm)

UPC	NO.
22145 2	396

400



### TELESCOPING ALLIGATOR CLIP – 400

- Ideal for lighting pilot lights and barbecues
- Jaw capacity: .170" (4.30mm)
- Chrome finish to prevent rust
- Telescopes from 6-1/4" to 24-1/2" (159 – 616mm)
- Convenient pocket-clip

UPC	NO.
42217 0	400

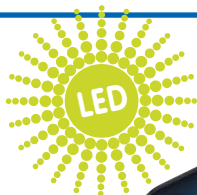

70401



### LIGHTED TWEEZERS – 70401

Allows you to retrieve items from dark, hard-to-reach places. Puts the light exactly where you need it. Pointed Smooth Tip.

#### FEATURES:

- Powerful LED Light
- Push ON / Push OFF Switch
- Non-slip Comfort Grips
- Corrosion Resistant Black Finish

- Overall Length - 4.2 (106mm)
- Includes 3 "LR41" batteries
- Patented

UPC	NO.
26004 8	70401

70403



### LIGHTED TWEEZERS – 70403

Allows you to retrieve items from dark, hard-to-reach places. Puts the light exactly where you need it. Blunt Serrated Tip.

#### FEATURES:

- Powerful LED Light
- Push ON / Push OFF Switch
- Non-slip Comfort Grips
- Corrosion Resistant Black Finish

- Overall Length - 4.2 (106mm)
- Includes 3 "LR41" batteries
- Patented

UPC	NO.
26005 5	70403

70408



### LIGHTED TWEEZERS – 70408

Allows you to retrieve items from dark, hard-to-reach places. Puts the light exactly where you need it. Bent Serrated Tip.

#### FEATURES:

- Powerful LED Light
- Push ON / Push OFF Switch
- Non-slip Comfort Grips
- Corrosion Resistant Black Finish

- Overall Length - 4.2 (106mm)
- Includes 3 "LR41" batteries
- Patented

UPC	NO.
26006 2	70408

