

Prest Wall Glassboard, Whiteboard, and Tack Board / PRW1, PRW6, PRW4



Installation Instructions

Tools Needed:

- Pencil
- 7/64" & 1/4" Drill Bits
- 4' Level
- Tape Measure
- Power Drill
- Phillips Head Driver Bit or Screwdriver
- Suction Cups (Optional)

Step 1: Prior to installation, ensure the wall is vertically and horizontally flat using a 4' level. If the wall has any bow, washers will need to be added in the valleys to allow the brackets to be installed straight.

Step 2: Remove and unpack the board and mounting hardware.

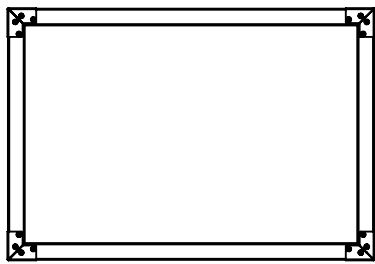

(1)
Glassboard,
Whiteboard, or
Tack Board.

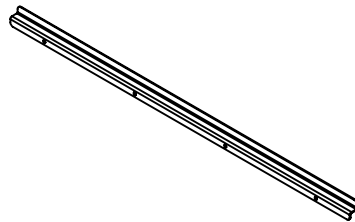

(1)
Top
Bracket

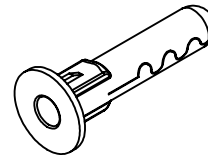

(14)
Wall Inserts

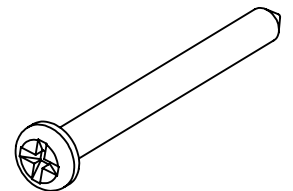

(14)
#10 X 2" Sheet
Metal Screw

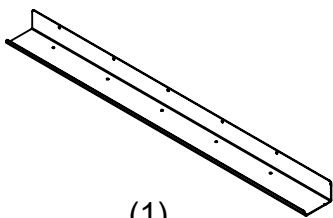

(1)
Marker Tray
(Glass or Whiteboard Only)

or

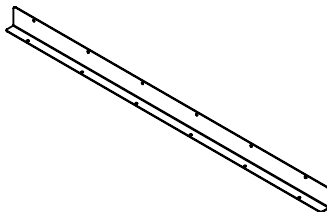

(1)
Bottom Bracket
(Tack Board Only)



(6)
#8 x 7/16" Wood Screw

Step 3: Locate and mark studs on the wall. If studs cannot be located, use provided Wall Inserts during installation.

Step 4: Determine desired height from the floor to the bottom of the board on the wall. Mark vertical centerline and bottom horizontal edge of glassboard.

Step 5: Determine and measure the positions of the top and bottom bracket using the horizontal scribed line (position A on the below diagram).

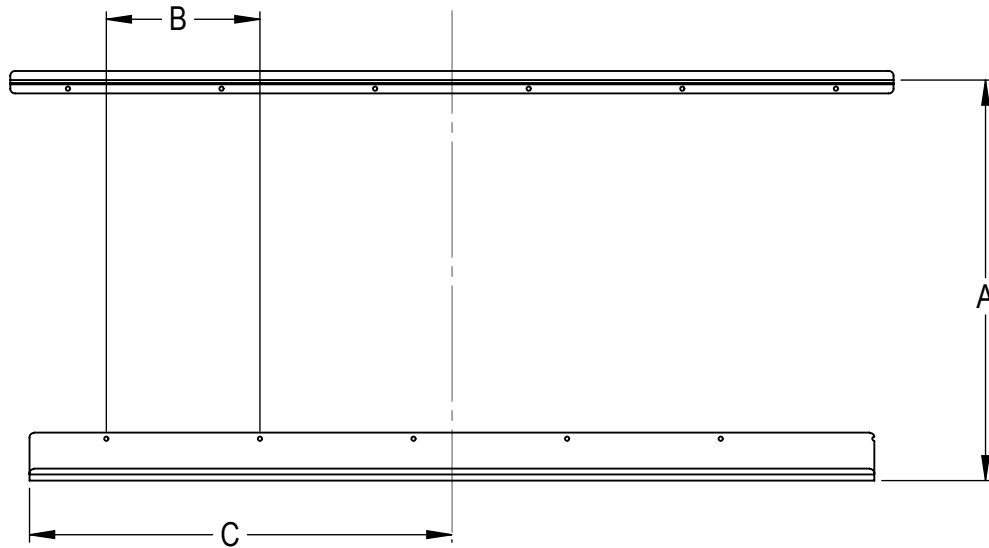

Board Size	A	B	C (Glass or Whiteboard Only)	C (Tack Board Only)
24" X 36"	24-1/2"	8"	10"	15"
36" X 48"	36-1/2"	8"	16"	15"
36" X 60"	36-1/2"	8"	22"	15"
36" X 72"	36-1/2"	8"	28"	23"
48" X 48"	48-1/2"	8"	16"	15"
48" X 60"	48-1/2"	8"	22"	15"
48" X 72"	48-1/2"	8"	28"	23"
48" X 96"	48-1/2"	8"	40"	23"

Step 6: Locate the holes for the brackets by drilling pilot holes in the wall with a 7/64" drill bit, use the bracket holes as a guide. If you do not hit studs, remove the bracket to install the provided wall anchors. Wall anchors require a 1/4" pilot hole for proper installation.

Step 7: Using the #10 x 2" sheet metal screws, affix the bottom bracket for tack board or the chalk rail for the glassboard and whiteboard to the wall.

Step 8: Measure position of top bracket using horizontal scribed line. Center the top bracket with center scribed line and lower (position A on the diagram above). Repeat Steps 6 and 7.

Step 9: Lift the board to the wall above the top bracket and slowly lower onto the marker tray or bottom bracket. Use suction cups, if available to handle the glassboard or whiteboard.

Step 10: Drill holes using a 7/64" drill bit 1/2" deep using the holes in the marker tray or bottom bracket as a guide, install #8 X 7/16" wood screws.

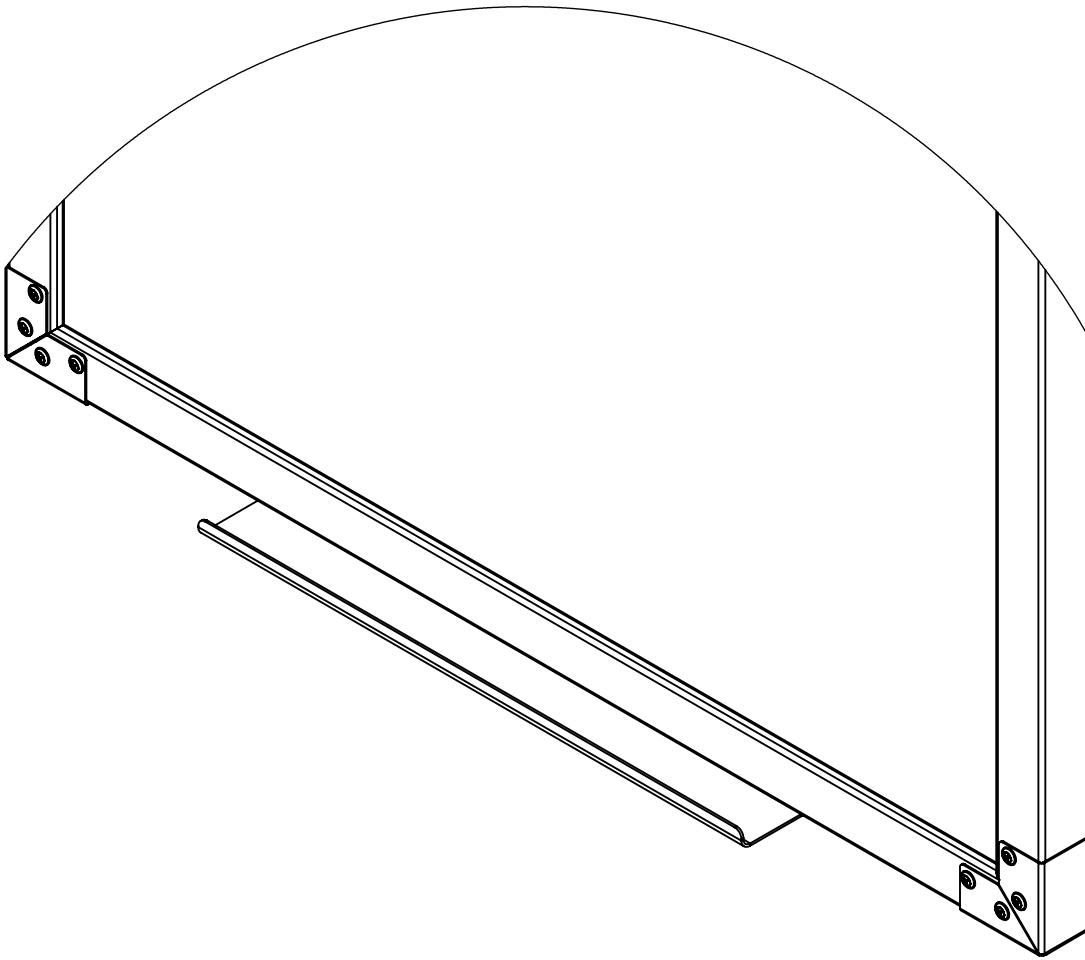

Step 11: Recycle all packaging in accordance with local regulations.