



PRODUCT COLLECTION
Visual Communication Products

WHAT'S **NEW**

PRODUCT ADDITIONS:

- Stroll Mobile Glassboards – see page 6
- New Standard Aria – see page 8
- New Harmony Glassboard Colors – see page 10
- LINK Premium Powder-Coated Whiteboard Color Additions – see page 12
- Pre-Printed Graphic Whiteboards – see page 33

Visit ghent.com for complete and up-to-date information on our product offering as well as:

- Glass quick ship information
- Spec sheets
- New features and additions
- Additional images
- Video library
- Symbol library

For quote request or to place your order, contact Ghent customer service at 800.543.0550 or contact your local Ghent representative.



STRIVING TO GIVE YOU **EXACTLY WHAT YOU WANT**

We're a family of companies with a single mission – delivering products and experiences that leave our customers with a feeling of “That’s Exactly What I Wanted!”

GMi Companies (Ghent, Waddell, and VividBoard) is headquartered in Lebanon, OH and proudly manufactures in the USA. Below are just a few of the ways we strive to go above and beyond for our customers. You can learn more about VividBoard on page 64 and Waddell on page 66.



MADE IN THE USA

With over 95% of GMi products manufactured in the USA, you can have confidence in the quality, reliability, and availability every time. Custom options are always available.



DROP-SHIP EXPERTS

We've been drop-shipping directly to end-users and dealers for over 30 years. Whether it's one item or a truck load, we make it easy.



CUSTOMIZATION STANDARD

Each order is produced on demand, just in time. That means we can customize products to your specifications.



ARRIVES AS EXPECTED

We are proud to claim the lowest freight damage in the industry, and we ship on time. Bottom line – we deliver on our promises, period.



QUALITY REPUTATION

We take quality seriously at GMi Companies. Many Ghent products are warranted for 50 years. We stand behind our products.



EASY TO DO BUSINESS WITH

Our goal is to make your life easier and hassle-free. From product information and quotes, to project management and easy invoicing, we are here for you.





Stroll mobile glassboard shown in 3/4 White glass and 1/4 Pistachio fabric. Also shown is Aria low profile glassboard in Green.

TABLE OF CONTENTS

FEATURED PRODUCTS

Stroll Mobile Glassboards.....	6
Aria Glassboards	8
Harmony Glassboards	10
LINK Premium Powder Coated Whiteboards	12
Roam Mobile Whiteboards.....	16
Nexus Mobile Collaboration Furniture	18
Simplicity Next Generation Whiteboard	20
Impression Premium Wood Framed Whiteboards & Bulletin Boards	22

GLASSBOARDS

Stroll.....	26
Aria	27
Harmony	27

WHITEBOARDS

Porcelain	30
Graphic Porcelain	31
Magnetic Steel.....	32
Non-Magnetic	33
Resurfacing Solutions.....	33
Graphic Boards	33
Communication Furniture	35
Horizontal Sliders	35

MOBILE WHITEBOARDS

Roam	38
Reversible	38
Nexus.....	39

BULLETIN BOARDS

Premium Cork	44
Traditional Cork	44
Cintra	45
Recycled Rubber.....	45
Vinyl	46
Fabric.....	46
Colored Cork	47
Combination Boards.....	47

ENCLOSED & LETTER BOARDS

Enclosed Bulletin.....	50
Designer Enclosed Boards.....	50
Traditional Enclosed Boards	50
Outdoor Enclosed.....	51
Customizable.....	52
Lighted	52
Letter Boards.....	53
Traditional	53
Customized	54

EASELS & DISPLAY RAILS

Display Easels	58
Presentation Easels	59
Display Rails.....	59

REFERENCES

Surface Guide	60
Finishes.....	61
VividBoard.....	64
Waddell	66

ICON KEY



Two Business Day Shipping



10 Business Day Shipping



15 Business Day Shipping



20 Business Day Shipping



Accepts Magnets



Projection Surface



Logo Application



Product Warranty



TAA Compliant



ADA Compliant



Customizable



Lighted Option Available



Tackable Surfaces Available



Green

STROLL

Mobile Glassboards

Mobilize Your Thoughts.

Mobile – powder-coated aluminum frame with built-in recessed handle makes it easy to move the glass mobile from tile to carpet.

Clutter-Free – recessed pocket keeps writing accessories within arms reach without taking up valuable writing space.

Configurable – choose from 13 glass colors and six optional fabric panels, as well as magnetic or non-magnetic writing surfaces.

Stylized – the modern aesthetic of a glassboard combined with a sleek frame blends with any interior.

Personal – brand your space with logos or add other graphical elements to your glassboard, making it one-of-a-kind.

Split panel Stroll with White glass and Highsea fabric next to full panel Stroll with Marigold glass.



Collaboration in Motion.

Brainstorm on-the-go with our new mobile glass offering, Stroll. Our latest addition is designed to brighten your space with 13 glass color options and six optional fabric panels. The powder-coated aluminum frame is sturdy, lightweight, and the addition of heavy-duty casters give Stroll the flexibility to move from carpet to tile with little effort. A recessed pocket acts as a handle that also ensures your markers and eraser are accessible. Use the glass mobile alone, or line up multiple units to divide an open office, making it easy to collaborate in motion.

1 Choose Your Style

SIDE ONE	SIDE TWO	ID #
Full Glass	Full Glass	1
3/4 Glass 1/4 Fabric	3/4 Glass 1/4 Fabric	2
Full Glass	3/4 Glass 1/4 Fabric	3
Full Glass	Full Fabric	4



Full Glass



3/4 Glass 1/4 Fabric

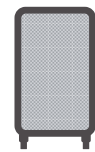

Fabric

2 Magnetic or Non-Magnetic

DESCRIPTION		ID #
Non-Magnetic		N
Magnetic		M

3 Frame

ID #	COLOR
	SIL Silver

4 Glass Color

ID #	COLOR	ID #	COLOR	ID #	COLOR	ID #	COLOR
	RS Rose		GN Green		BG Beige		WH White
	PH Peach		BE Blue		GY Gray		
	MR Marigold		DM Denim		SK Smoke		
	YW Yellow		LG Lilac Gray		BK Black		

*Black glassboards require fluorescent dry erase markers and are included with Black glassboard purchases. For an exact glass color match, request a sample.

5 Fabric Color

ID #	COLOR	ID #	COLOR	ID #	COLOR
	001 Calm		009 Pistachio		016 Raven
	004 Roe		012 Highsea		017 Aluminum

maharam For more information, or exact color matches, please visit ghent.com/finishes



A R I A

Low Profile Glassboards



The Most Secure Glassboard On The Market.

Most Secure – heavy-duty hanging system gives confidence the board will never bow, strain, or move from the wall, creating a safe user experience.

Low Profile – 1/4" tempered glass floats only 1/2" from the wall surface, giving the illusion of floating glass.

Integrated – no exposed hardware and a clutter-free marker solution creates a clean and frameless writing surface.

Limitless – design your space by choosing the vertical or horizontal orientation, singular, or as a glass wall.

Quality – non-porous glass surface works with standard dry erase markers and will not ghost or stain – guaranteed.

Bold - 13 color variations: seven bold, six neutral.

4' x 8' Aria low profile glassboard shown in Marigold.



A Striking Composition Of Function Meeting Elegance.

Aria low profile glassboards achieve the look of weightless, floating glass, creating a feeling of opulence from every angle. No visible hardware or standoffs allow the beauty of the glass to complement any décor. Our team of engineers developed a heavy-duty hanging system that promotes security and confidence that your board will never bow, strain, or move from the wall. With multiple orientation options, Aria can be used as a single board for personal offices and conference rooms, or designed as a glass wall, optimizing brainstorming and collaboration spaces.

Item No.	Description
Non-Magnetic-Horizontal	
ARIASN23xx	2' H x 3' W Non-Magnetic – Horizontal
ARIASN34xx	3' H x 4' W Non-Magnetic – Horizontal
ARIASN44xx	4' H x 4' W Non-Magnetic – Horizontal
ARIASN45xx	4' H x 5' W Non-Magnetic – Horizontal
ARIASN46xx	4' H x 6' W Non-Magnetic – Horizontal
ARIASN48xx	4' H x 8' W Non-Magnetic – Horizontal
ARIASN410xx	4' H x 10' W Non-Magnetic – Horizontal

Item No.	Description
Non-Magnetic-Vertical	
ARIASN32xx	3' H x 2' W Non-Magnetic – Vertical
ARIASN43xx	4' H x 3' W Non-Magnetic – Vertical
ARIASN54xx	5' H x 4' W Non-Magnetic – Vertical
ARIASN64xx	6' H x 4' W Non-Magnetic – Vertical
ARIASN84xx	8' H x 4' W Non-Magnetic – Vertical
ARIASN104xx	10' H x 4' W Non-Magnetic – Vertical

Item No.	Description
Magnetic-Horizontal	
ARIASM23xx	2' H x 3' W Magnetic – Horizontal
ARIASM34xx	3' H x 4' W Magnetic – Horizontal
ARIASM44xx	4' H x 4' W Magnetic – Horizontal
ARIASM45xx	4' H x 5' W Magnetic – Horizontal
ARIASM46xx	4' H x 6' W Magnetic – Horizontal
ARIASM48xx	4' H x 8' W Magnetic – Horizontal
ARIASM410xx	4' H x 10' W Magnetic – Horizontal

Item No.	Description
Magnetic-Vertical	
ARIASM32xx	3' H x 2' W Magnetic – Vertical
ARIASM43xx	4' H x 3' W Magnetic – Vertical
ARIASM54xx	5' H x 4' W Magnetic – Vertical
ARIASM64xx	6' H x 4' W Magnetic – Vertical
ARIASM84xx	8' H x 4' W Magnetic – Vertical
ARIASM104xx	10' H x 4' W Magnetic – Vertical

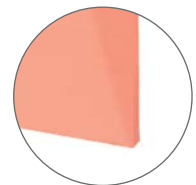

Square Corners

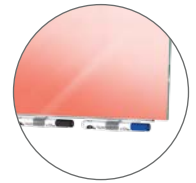

Integrated Marker Storage

i.e. **ARIASM23BK**

ARIA | **S** – Square Corners | **M** – Magnetic | **23** – Horizontal Board Size (2' H x 3' W) | **BK** – Black

i.e. **ARIASN43PH**

ARIA | **S** – Square Corners | **N** – Non-Magnetic | **43** – Vertical Board Size (4' H x 3' W) | **PH** – Peach

Each non-magnetic Aria glassboard includes four magnetic markers, and one magnetic eraser.

Each magnetic Aria glassboard includes four magnetic markers, one magnetic eraser, and four rare earth magnets.

*Black glassboards require fluorescent dry erase markers. Fluorescent dry erase markers are included with Black glassboard purchases. For an exact color match, request a sample.

RS Rose	MR Marigold	GN Green	DM Denim	BG Beige	SK Smoke	WH White
PH Peach	YW Yellow	BE Blue	LG Lilac Gray	GY Gray	BK Black*	CUSTOM COLORS AVAILABLE



HARMONY

Glassboards with Standoffs

Harmonize Your Thoughts.

Distinctive – with round or square corners and minimal exposed hardware, the frameless board sits one 1/4" from the wall.

Quality – 1/4" thick, non-porous glass surface will not ghost or stain and works with standard dry erase markers.

Bold – 13 color variations: seven bold, six neutral; also available in a traditional frosted finish.

Limitless – design your space by choosing to hang your board horizontally or vertically, magnetic, or non-magnetic.

Integrated – clear acrylic rear-mounted accessory holder allows for a clutter-free writing surface.

4' x 6' Harmony glass shown in Denim.



Brighten Your Brainstorm.

Harmonizing your thoughts has never looked so good. With 13 colors and 7 sizes to choose from, Harmony is a versatile and gorgeous way to brainstorm. Taking today's latest color trends and interior fashions into consideration, we've created the perfect palette of dry erase boards to choose from. Change the way you think about a whiteboard.

Item No.	Description
Non-Magnetic	
HMYxN23xx	2' H x 3' W Non-Magnetic Harmony
HMYxN34xx	3' H x 4' W Non-Magnetic Harmony
HMYxN44xx	4' H x 4' W Non-Magnetic Harmony
HMYxN45xx	4' H x 5' W Non-Magnetic Harmony
HMYxN46xx	4' H x 6' W Non-Magnetic Harmony
HMYxN48xx	4' H x 8' W Non-Magnetic Harmony
HMYxN410xx	4' H x 10' W Non-Magnetic Harmony

Item No.	Description
Magnetic	
HMYxM23xx	2' H x 3' W Magnetic Harmony
HMYxM34xx	3' H x 4' W Magnetic Harmony
HMYxM44xx	4' H x 4' W Magnetic Harmony
HMYxM45xx	4' H x 5' W Magnetic Harmony
HMYxM46xx	4' H x 6' W Magnetic Harmony
HMYxM48xx	4' H x 8' W Magnetic Harmony
HMYxM410xx	4' H x 10' W Magnetic Harmony

i.e. HMYRM23BK
HMY – Harmony | **R** – Radius Corners | **M** – Magnetic | **23** – Board Size (2' x 3') | **BK** – Black

i.e. HMYSN34PH
HMY – Harmony | **S** – Square Corners | **N** – Non-Magnetic | **34** – Board Size (3' x 4') | **PH** – Peach

Each non-magnetic Harmony glassboard includes four markers, one eraser, and an acrylic marker holder.
 Each magnetic Harmony glassboard includes four markers, one eraser, four rare earth magnets, and an acrylic marker holder.



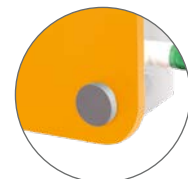



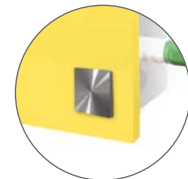

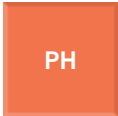

*Black glassboards require fluorescent dry erase markers. Fluorescent dry erase markers are included with Black glassboard purchases.
 For an exact color match, request a sample.



Radius



Square

 RS Rose	 PH Peach	 MR Marigold	 YW Yellow	 GN Green
 BE Blue	 DM Denim	 LG Lilac Gray	 BG Beige	 GY Gray
 SK Smoke	 BK Black*	 WH White	 FR Frosted	 CUSTOM COLORS AVAILABLE



LINK

Premium Powder Coated Whiteboards

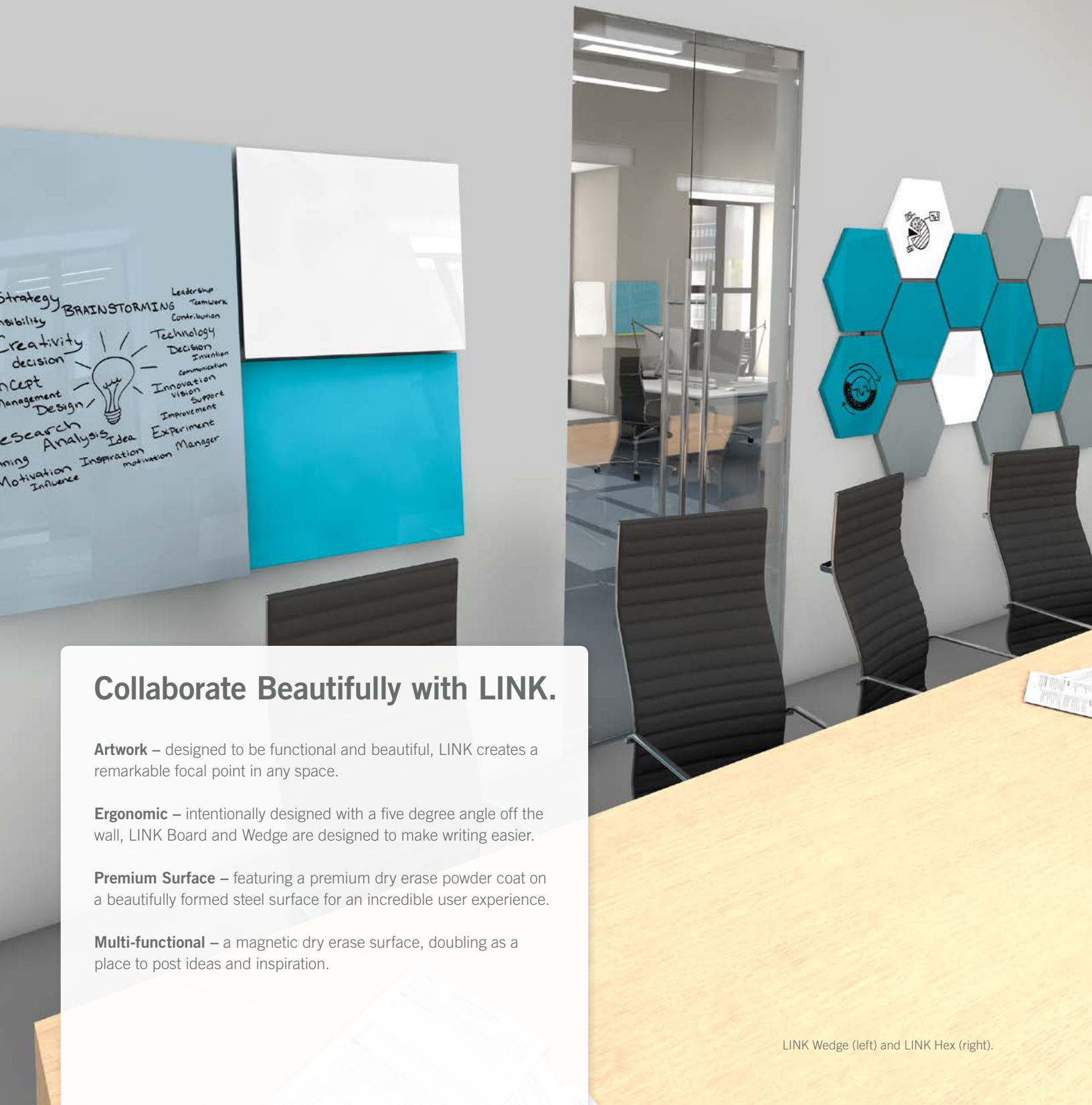

Collaborate Beautifully with LINK.

Artwork – designed to be functional and beautiful, LINK creates a remarkable focal point in any space.

Ergonomic – intentionally designed with a five degree angle off the wall, LINK Board and Wedge are designed to make writing easier.

Premium Surface – featuring a premium dry erase powder coat on a beautifully formed steel surface for an incredible user experience.

Multi-functional – a magnetic dry erase surface, doubling as a place to post ideas and inspiration.

LINK Wedge (left) and LINK Hex (right).



LINK Board, shown in various base and face colors.

LINK BOARD

Personal spaces need personality. LINK Board was designed to add color, productivity, and mobility to modern work spaces. The removable board can be easily transported for use in group settings, while the base remains in place as an additional writing surface. LINK Board is available in three face and two base colors. Custom colors also available.

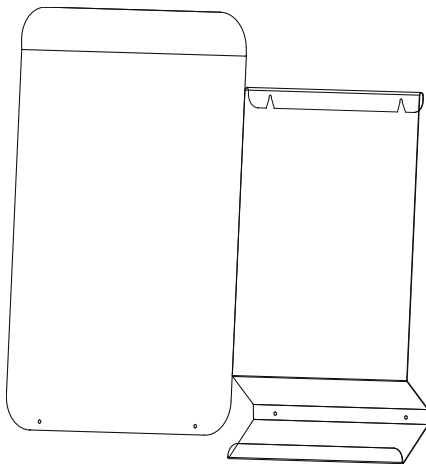

Item No.	Description	Face Color	Base Color
24" x 18"			
LWB2418BB	LINK Board 24" H x 18" W	Bright Blue	Soft Blue
LWB2418BG	LINK Board 24" H x 18" W	Gray	Soft Blue
LWB2418BW	LINK Board 24" H x 18" W	White	Soft Blue
LWB2418GB	LINK Board 24" H x 18" W	Bright Blue	Lime Green
LWB2418GG	LINK Board 24" H x 18" W	Gray	Lime Green
LWB2418GW	LINK Board 24" H x 18" W	White	Lime Green
24" x 30"			
LWB2430BB	LINK Board 24" H x 30" W	Bright Blue	Soft Blue
LWB2430BG	LINK Board 24" H x 30" W	Gray	Soft Blue
LWB2430BW	LINK Board 24" H x 30" W	White	Soft Blue
LWB2430GB	LINK Board 24" H x 30" W	Bright Blue	Lime Green
LWB2430GG	LINK Board 24" H x 30" W	Gray	Lime Green
LWB2430GW	LINK Board 24" H x 30" W	White	Lime Green

Each LINK Board comes with magnetic accessories, one marker, and one microfiber cloth, to allow for ultimate flexibility.

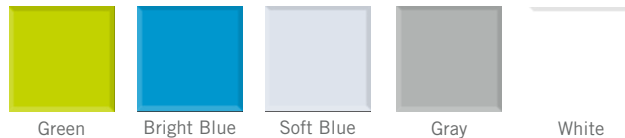



LINK Wedge shown in various size and color options.

LINK WEDGE

Conference rooms don't have to be boring anymore with LINK Wedge. Designed specifically to be magnetic, ergonomic, and configurable, LINK Wedge takes your dry erase board to the next level. The simple track-hanging system makes it easy to configure a design all on your own. Get creative with the layout by using the small and large sizes next to each other to create dynamic and functional artwork. Available in two sizes and seven standard colors. Custom colors also available.

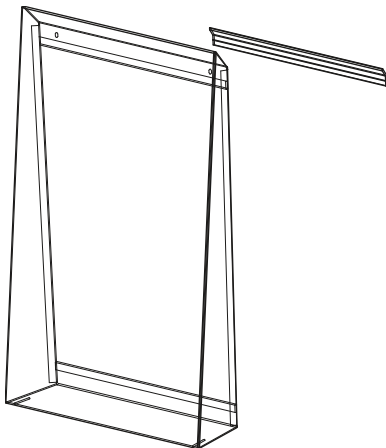

Item No.	Description	Wedge Color
Half Size 24" x 30"		
LW2430BB	LINK Wedge 24" H x 30" W	Bright Blue
LW2430GY	LINK Wedge 24" H x 30" W	Gray
LW2430WH	LINK Wedge 24" H x 30" W	White
LW2430SB	LINK Wedge 24" H x 30" W	Soft Blue
LW2430LG	LINK Wedge 24" H x 30" W	Lime Green
LW2430MG	LINK Wedge 24" H x 30" W	Marigold
LW2430RS	LINK Wedge 24" H x 30" W	Rose

Full Size 48" x 30"		
LW4830BB	LINK Wedge 48" H x 30" W	Bright Blue
LW4830GY	LINK Wedge 48" H x 30" W	Gray
LW4830WH	LINK Wedge 48" H x 30" W	White
LW4830SB	LINK Wedge 48" H x 30" W	Soft Blue
LW4830LG	LINK Wedge 48" H x 30" W	Lime Green
LW4830MR	LINK Wedge 48" H x 30" W	Marigold
LW4830RS	LINK Wedge 48" H x 30" W	Rose

Each LINK Wedge comes with magnetic accessories, one marker, and one microfiber cloth.





LINK Hex shown in various color options.

LINK HEX

When was the last time a whiteboard had some attitude? LINK Hex was designed to make public or private spaces more personal with configurable hexagonal magnetic whiteboards. Take a simple Hex and create a canvas to suit your needs. LINK Hex will make your common areas uncommon; lobbies become conversation centers and hallways become brainstorming-central. Available in seven standard colors. Custom colors also available.

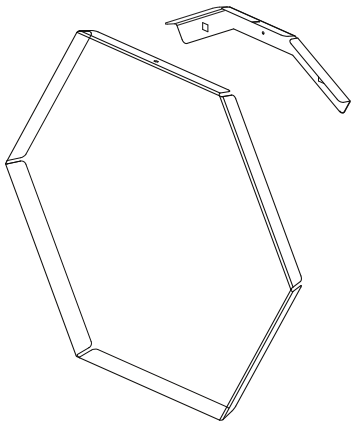

Item No.	Description	Hex Color
18" x 20.5"		
LH1821BB	LINK Hex – 18" H x 20.5" W	Bright Blue
LH1821GY	LINK Hex – 18" H x 20.5" W	Gray
LH1821WH	LINK Hex – 18" H x 20.5" W	White
LH1821SB	LINK Hex – 18" H x 20.5" W	Soft Blue
LH1821LG	LINK Hex – 18" H x 20.5" W	Lime Green
LH1821MR	LINK Hex – 18" H x 20.5" W	Marigold
LH1821RS	LINK Hex – 18" H x 20.5" W	Rose

Each LINK Hex comes with one magnetic marker, one microfiber cloth (optional).

Product is shipped with an easy "How-To" installation guide that can also be found by visiting ghent.com/hex.

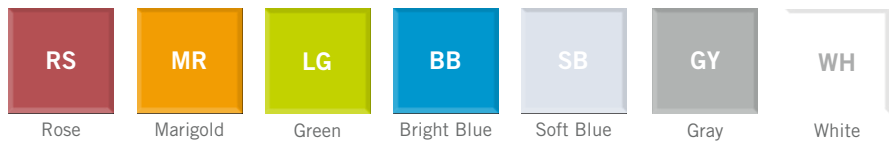

R O A M

Mobile Whiteboards



Roaming in Concert with You.

Functional – designed to be a simple product that embodies form and function.

Compact – the compact nesting feature allows multiple products to be used and stored in one footprint, maximizing space.

Mobile – heavy-duty casters allow for ease of use across multiple flooring surfaces, roaming easily throughout collaboration sessions.

All-in-one – the double-sided, edge-to-edge writing surface and accessory tray, allow multiple ideas to be shared in one common place.

Stability – Roam's low center of gravity creates stability for a steady writing surface and allows for ease of use when rolling to and from locations.



Why Stand Still When You Can Roam?

You shouldn't have to stand still to collaborate... Roam, a mobile whiteboard, allows for on-the-go collaboration. Designed to be simple and clean, Roam is a prime example of form meeting function. Line up multiple Roam whiteboards to create a larger dry erase surface for use during presentations, or move them around the room for breakout sessions. When at rest, the unique nesting feature allows multiple units to fit within a single footprint, maximizing your valuable space. You shouldn't have to be stationary during collaboration and brainstorming. Go ahead... Roam.

- Double-sided mobile whiteboard with edge-to-edge writing surface
- 42" H x 36" W writing surface constructed of non-ghosting, high pressure laminate
- Satin aluminum double-sided tray and legs complement any décor
- Constructed with 2.5" heavy-duty casters that allow for ease of use throughout any flooring surface
- Compact nesting allows for multiple units to fit within the same footprint
- Low center of gravity creates stability in use and while roaming
- Optimal for seated or standing positions
- Lightweight unit improves mobility; overall dimensions are 69" H x 36" W
- Backed by Ghent's 10-year warranty



Item No.	Description
Non-Magnetic	
RM36SAWHN	Roam Mobile, 69" H x 36" W Satin Aluminum base, whiteboard

Each Roam includes four markers and one eraser.

NEXUS

Mobile Collaboration Furniture



Promote Freer Thinking.

Collaborative – create a culture that supports collaboration, allowing you to share and build knowledge while empowering individuals within the small group dynamic.

Mobile – organizations can put a whiteboard at their employees' fingertips virtually anywhere they choose to work. It moves where you move. It works where you work.

Intuitive – the Nexus family of products interact with each other, contributing to open discussions and communications in a team environment.

Modern design for the modern office – designed to work in open office spaces where there are no fixed walls for traditional whiteboards, but people still need to collaborate.

Flexible – mobile double-sided magnetic whiteboards allow the user to configure their work space as needed without a permanent structure.



Focus the Conversation



“You cannot really appreciate the power and magic of Nexus until you use it. It’s not just one thing; it’s everything about it. The two distinct surface areas help separate

ideas or discussion topics, whether it be strategic and tactical, or visuals and task lists. I call the tablet my ‘laptop’ — I can sit down with a client and collaborate or share a concept together, then hang it up and use it as a reference when we work on the adjoining big board. All I can say is that this system just flat-out invites collaboration and engagement like no traditional whiteboard or flip chart ever could.”

– Paul Heagen, Founder & Executive Coach
DEFINING Moments™

Item No.	Description	Size
NEX101TM	Tablet – One	28" H x 28" W x .75" D
NEX104TM	Tablet – Four	28" H x 28" W x .75" D
NEX203ME	Easel	46" H x 34" W
NEX204EP	Easel+	39" H x 26" W
NEX206MW	IdeaWall	46" H x 70" W
NEX224MMP	Partition	65" H x 46" W
NEX223MMP	Jr. Partition	46" H x 34" W
NEX001XP	X-Pegs – One pair	1" from Wall
NEX004XP	X-Pegs – Four pair	1" from Wall
NEX011XHS	X-Hangers – One pair	Fits Partitions 1.5" to 2.5" thick
NEX014XHS	X-Hangers – Four pair	Fits Partitions 1.5" to 2.5" thick
NEX021XHL	X-Hangers – One pair	Fits Partitions 2.5" to 3.5" thick
NEX024XHL	X-Hangers – Four pair	Fits Partitions 2.5" to 3.5" thick
NEX134WMB	Wall Board	3' H x 4' W
NEX146WMB	Wall Board	4' H x 6' W

Custom Graphics, Colors, and Logos Available
Call VividBoard at 877.543.2999

S I M P L I C I T Y

Next Generation Whiteboard

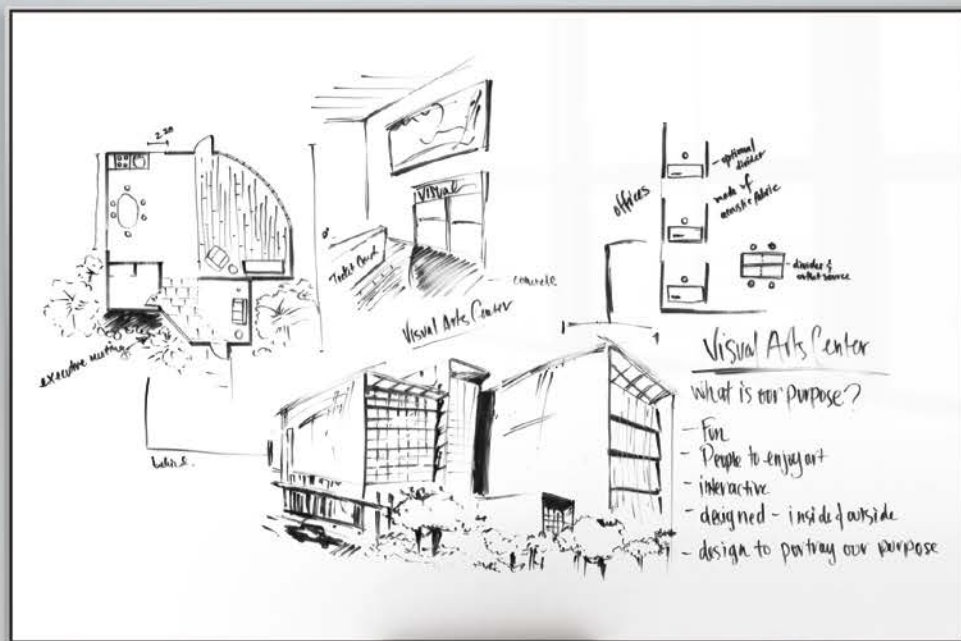

Keep it Simple.

Elegant – designed to coexist in the world of future systems and communication tools, the clean lines of Simplicity de-emphasize the impact of the frame, giving the board a virtually frameless feel.

Innovative – by incorporating a material never before used in a commercial whiteboard, Simplicity becomes a one-of-a-kind communication tool.

Durable – the patented Acrylite® surface has twice the scratch resistance of glass, but only half the weight. This means a more dependable board that is easier to handle.

Mountable – our invisible mounting system uses a z-bar hanging bracket to ensure a level hang with minimal work.

4' x 6' Simplicity whiteboard.

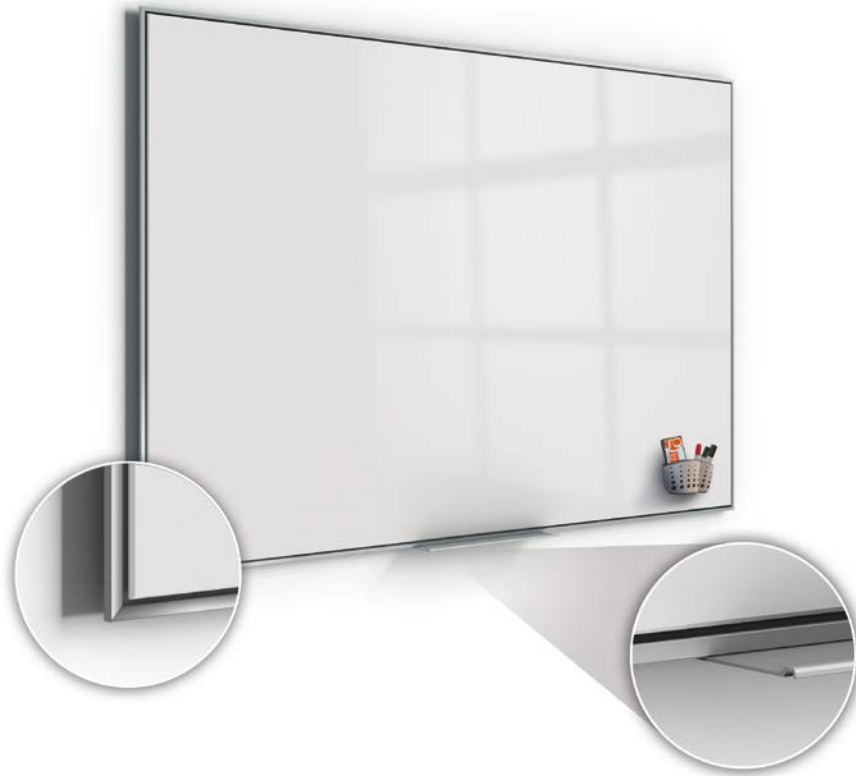

Let Your Ideas Float Freely.

Simplicity was designed to take the busyness out of your whiteboard. With big, bulky frames and obstructed views, traditional whiteboards aren't designed for modern spaces. Enter Simplicity. The seamless lines and shadow-reveal are intentionally crafted to make the ordinary, extraordinary. Couple these features with a next-generation Acrylite® (guaranteed to not ghost or stain for 50 years) writing surface, and Simplicity becomes a one-of-a-kind communication tool.

Item No.	Description
Non-Magnetic	
SI023A	2' H x 3' W Simplicity
SI034A	3' H x 4' W Simplicity
SI044A	4' H x 4' W Simplicity
SI045A	4' H x 5' W Simplicity
SI046A	4' H x 6' W Simplicity
SI048A	4' H x 8' W Simplicity
Magnetic	
SI023AM	2' H x 3' W Magnetic Simplicity
SI034AM	3' H x 4' W Magnetic Simplicity
SI044AM	4' H x 4' W Magnetic Simplicity
SI045AM	4' H x 5' W Magnetic Simplicity
SI046AM	4' H x 6' W Magnetic Simplicity
SI048AM	4' H x 8' W Magnetic Simplicity

Accessories Included: Four markers, one eraser, and one attachable aluminum tray
 Optional Accessories: Marker basket (pictured above)

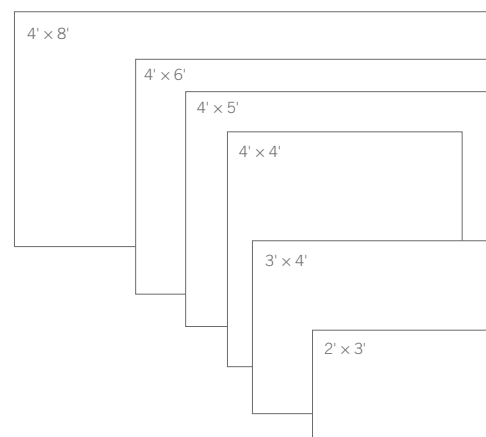

INFUSED WITH
ACRYLITE®



I M P R E S S I O N

Premium Wood Framed Whiteboards & Bulletin Boards



Communicate in Style.

Stylish – premium frames, functional surface options, and our hidden marker storage creates a polished and clean appearance.

Robust – Impression whiteboard surface is 28 gauge porcelain-on-steel for a superior writing experience.

Versatile – various wood framing and tackable fabric options allow you the flexibility to customize your dry erase or bulletin board for your space.

Timeless – classic and modern framing options allow your board to encompass any design style.

3' x 4' Impression Whiteboard (left) and Bulletin Board (right)
both shown in Cherry Modern frame.



Make a Lasting Impression.

When the things you communicate need to make a statement, Impression is the perfect choice. Impression whiteboards and bulletin boards are framed with premium wood and are available in an array of finishes and surfaces. Impression is designed for you to communicate beautifully.

Item No.	Description
Whiteboards	
IM_23W__	2' H x 3' W Impression Porcelain Whiteboard
IM_34W__	3' H x 4' W Impression Porcelain Whiteboard
IM_44W__	4' H x 4' W Impression Porcelain Whiteboard
IM_45W__	4' H x 5' W Impression Porcelain Whiteboard
IM_46W__	4' H x 6' W Impression Porcelain Whiteboard
IM_48W__	4' H x 8' W Impression Porcelain Whiteboard

Bulletin Boards	
IM_23__F__	2' H x 3' W Impression Fabric Bulletin Board
IM_34__F__	3' H x 4' W Impression Fabric Bulletin Board
IM_44__F__	4' H x 4' W Impression Fabric Bulletin Board
IM_45__F__	4' H x 5' W Impression Fabric Bulletin Board
IM_46__F__	4' H x 6' W Impression Fabric Bulletin Board
IM_48__F__	4' H x 8' W Impression Fabric Bulletin Board

i.e. IMM23WCH

M – Modern Style | 23 – Board Size (2 x 3) | W – Whiteboard | CH – Frame Color

i.e. IMC23CHF90

C – Classic Style | 23 – Board Size (2 x 3) | CH – Frame Color | F – Fabric | 90 – Fabric Color



Modern Frame



Classic Frame

Frame Finishes

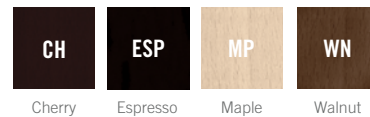

Fabric Options



For more fabric and finish options, visit www.ghent.com/finishes



1. Bulletin boards 2. Whiteboards

GLASSBOARDS

Premium Glassboards



“ Creativity begins
with color

Ghent's glass writing surfaces demonstrate the path to innovation in today's workplaces. With our wall-hanging or mobile glassboard options, we are confident that you will find the glass whiteboard that is right for you. The sleek, customizable surface offers a balance between form and function while offering versatility through colored writing surfaces and glass printing options.



Stroll Mobile glassboard shown in Rose.

STROLL

Stroll (SMG)

Mobile Glassboard

- Choose from full glass, 3/4 glass with 1/4 acoustical fabric, or full fabric panel
- Recessed handle makes the mobile easy to move and doubles as accessory storage, keeping the writing surface clutter-free; all Stroll units ship with magnetic markers and eraser
- Four locking casters keep Stroll in place when in use
- Available in magnetic or non-magnetic writing surface; magnetic surface includes rare earth magnets
- Choose from 13 standard colors for glass surface; custom colors, graphics, and logo printing available
- Fabric panel is available in six standard colors; the panel adds a pop of color and is acoustically rated. COM also available

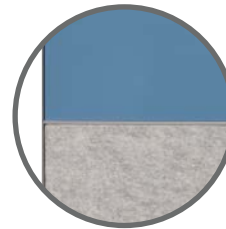

Fabric Panel

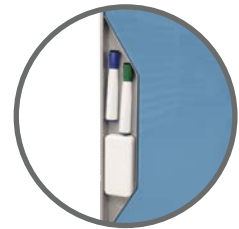

Recessed Handle

Stroll Glassboard Dimensions

- Overall dimensions: 72" H x 36" W
- Writing Surface (full glass): 67" H x 36" W
- Writing Surface (partial glass): 48" H x 36" W

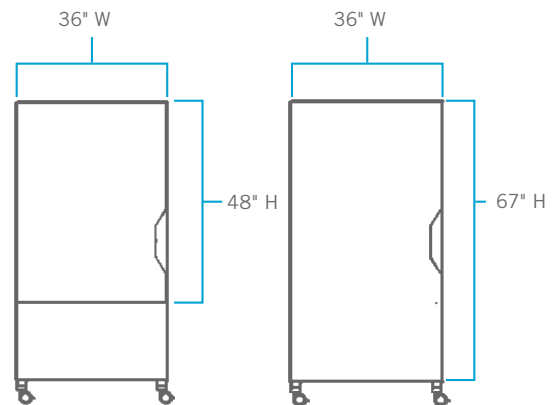

ARIA

Aria (ARIA)

Low profile glassboards with no exposed hardware.

- 1/4" tempered low profile glassboard floats only 1/2" from the wall surface
- Installed with heavy-duty aluminum cleating and a steel support bar that work together to safely secure the glassboard to the wall
- Steel support bar acts as an integrated marker solution, four markers and eraser included
- Available in square corners, magnetic, or non-magnetic writing surface
- Backed by Ghent's 50-year warranty; guaranteed not to ghost, stain, or scratch
- Choose from 13 standard colors; custom colors, graphic, and logo printing available



HARMONY

Harmony (HMY)

Premium glassboards with stand-offs.

- 1/4" tempered glass that sits 1 1/4" from the wall surface
- Pre-drilled mounting holes are inset into the glass: four holes for boards 4' x 4' and smaller, six holes for boards 4' x 5' – 4' x 8', and 8 holes for 4' x 10'
- Features a unique, clear acrylic rear-mounted accessory holder, complete with markers and eraser
- Available in square or round corners, magnetic, or non-magnetic writing surface
- 1" satin aluminum square or round standoffs that correspond with the shape of the board
- Backed by Ghent's 50-year warranty; guaranteed not to ghost, stain, or scratch
- Choose from 13 standard colors; custom colors, graphic, and logo printing available



WHITEBOARDS

Communicate. Collaborate. Learn.



“ Collaboration starts with an idea, a dream

People need to communicate, collaborate, and learn whether they're in schools, board rooms, hospitals, or at home. Our whiteboards are offered in an array of surfaces and frames to allow people to communicate, collaborate, and learn in the style and fashion they prefer.

Need help choosing the write surface?

Visit page 60 or check out www.ghent.com/writesurface to learn what makes our surfaces unique and choose the best solution for your needs.

How to Move Rankings Up On Older, Existing Content

Air Conditioners

- ① Competitor X
url
- ② Competitor Y
url
- ③ Competitor Z
url
- ④ Your A/C Page
url



④ Internal links + redirects

- Make sure the page is getting love from all the relevant URLs
- Consolidate! If you have lots of pages targeting the same term/phrase, consider 301'ing all to one place

① Point more external links to your existing URL

- Tough w/ commercial content, but easier w/ educational or non-promotional stuff
- Guest content, promotions, partnerships, testimonials (reviews, list inclusion, press/blog), social media pushes, and link reclamation have, in my experience, worked best
- Be really careful not to build the weak links

② Increase your click-through rate

- Supplement with PPC ads → 111=2.25
- Test modifications to title/description
- Add rich snippet data (Author/images/reviews/video)

③ Improve/re-vitalize on-page content

- Rich media - video, images, graphics
- Layout, design, UX, visual aesthetics
- Text content - not keywords, but unique VALUE!

⑤ Branding, Co-occurrence, + Mentions

Typical Infographic



PORCELAIN WHITEBOARDS

Magnetic Porcelain (M1 & M1W)

Traditional porcelain whiteboards with detachable marker tray.

- Heavy-duty porcelain-on-steel surface on a 3/8" backing
- Available in either a satin aluminum or a solid oak, natural finish
- Durable surface accepts magnets and resists scratches and stains
- Detached SmartPak blade-tray for easier installation and reduced potential for damage
- Available in 2' x 3', 3' x 4', 4' x 4', 4' x 5', 4' x 6', 4' x 8', 4' x 10', and 4' x 12'

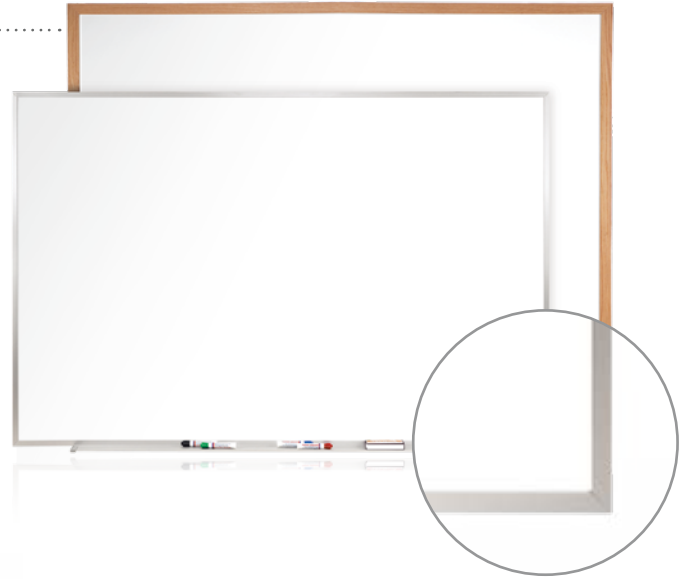

Magnetic Porcelain with Box-Tray (A2M)

Satin aluminum-framed traditional porcelain whiteboards with detachable box-tray.

- Detached SmartPak Box-Tray is heavy-duty and ideal for easier installation and reduced potential for damage (map rail optional)
- Heavy-duty porcelain-on-steel surface on a 3/8" backing for years of dependable service. Available with 1" map rail
- Durable surface accepts magnets and resists scratches and stains
- Available in 4' x 6', 4' x 8', 4' x 10', 4' x 12', and 4' x 16'



Proma Projection Surface (PRM1)

Porcelain whiteboard with ideal projection surface.

- Porcelain-on-steel projection surface in low luster finish minimizes "hot spots" and provides maximum color projection
- Magnetic surface resists scratches and stains
- SmartPak Tray is detached for easier installation and reduced potential for damage
- Satin aluminum frame with 1" map rail
- Available in 3' x 4', 4' x 4', 4' x 6', and 4' x 8'





Magnetic Porcelain Image Trim Frame (ITGM)

Porcelain whiteboard in our Image Trim frame – a stylish powder-coated graphite fleck finish on aluminum frame.

- Premium magnetic porcelain-on-steel marker surface accepts magnets and resists scratches and staining
- SmartPak Tray is detached for easier installation and reduced potential for damage
- Stylish frame with unsurpassed durability
- Available in 4' x 6', 4' x 8', 4' x 10', and 4' x 12'



DecoAurora (DFM)

Porcelain whiteboard with durable aluminum frame that features color customization capability.

- Porcelain-on-steel surface accepts magnets and resists scratches and stains
- Stylish multi-faceted corners and aluminum framing
- Wood-look or color strips coordinate with interior furnishings and conceal mounting hardware
- Available in 3' x 4', 4' x 4', 4' x 6', 4' x 8', 4' x 10', and 4' x 12'

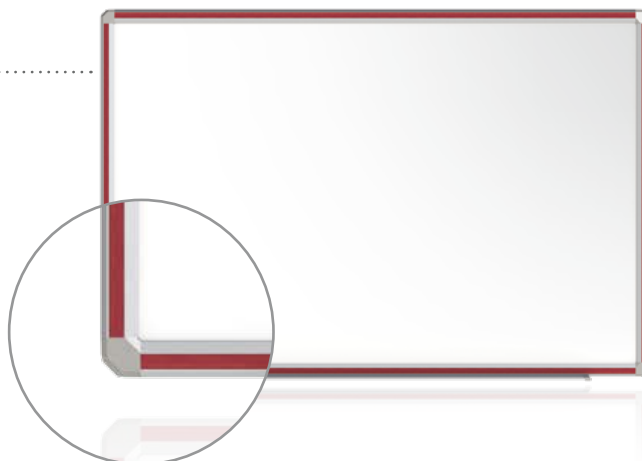

GRAPHIC PORCELAIN WHITEBOARDS

Penmanship Lined Boards (GM1P) & Music Staff Lined Boards (GM1M)

Functional porcelain whiteboard with a satin aluminum frame.

- Heavy-duty porcelain-on-steel surface on 3/8" backing
- Graphics available with either Penmanship lines or Music Staff
- Graphic surface accepts magnets and resists scratches and stains
- SmartPak Tray detached for easier installation, reduced damage potential – available with either marker tray (GM1) or premium box tray (GA2M) options
- Available in 4' x 6' and 4' x 8'
- GM1M – Distance between music staff lines = 1" and 4" between next set of staff lines
- GM1P – Distance between solid and dashed lines = 2"



MAGNETIC STEEL WHITEBOARDS

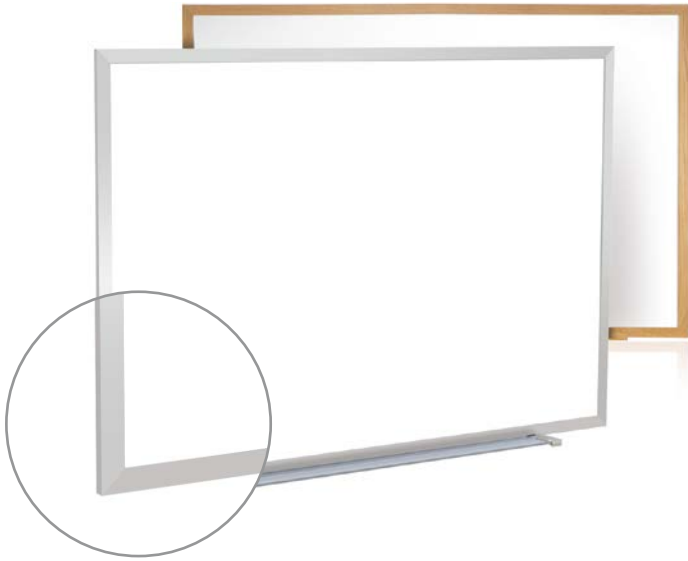

Magnetic Steel (M3 & M3W)

Traditional painted steel whiteboards with detachable marker tray, available in satin aluminum or wood frames.

- Durable acrylic enamel steel surface is built to last and perform
- High-quality surface accepts magnets and resists scratches and stains
- Available in either a satin-anodized aluminum or a solid oak frame
- SmartPak Tray is detached for easier installation and reduced potential for damage
- Available in 2' x 3', 3' x 4', 4' x 4', 4' x 5', 4' x 6', 4' x 8', 4' x 10', and 4' x 12'



Phantom – Magnetic Lined Boards (PLM3)

Painted steel whiteboard with faint grid lines only visible to user.

- 2" x 2" grid lines visible to the user, unseen by the audience
- Durable acrylic enamel steel surface priced to sell, last and perform
- High-quality magnetic steel resists scratches and stains and accepts magnets
- SmartPak Tray is detached for easier installation and reduced potential for damage
- Available in 2' x 3', 3' x 4', 4' x 4', 4' x 6', and 4' x 8'

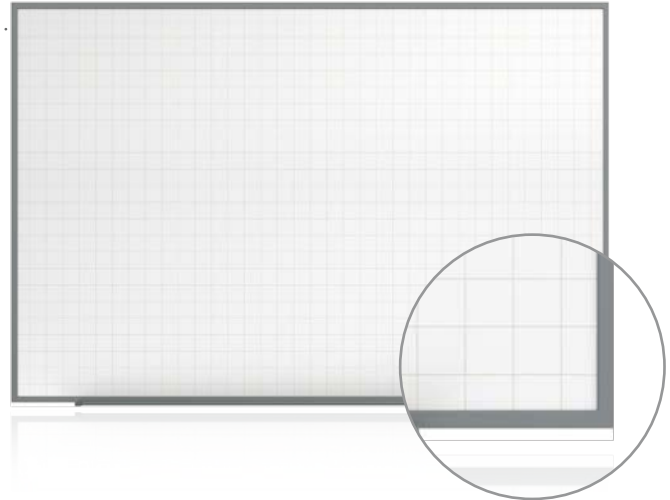

Magnetic Steel with Cintra Frame (CTSM3)

Painted steel whiteboard in our Cintra frame – a European-style aluminum frame.

- Stylish radius edged, Euro-style satin aluminum frame
- Acrylic enamel white magnetic steel marker surface erases easily and resists ghosting
- Attachable accessory tray allows for portrait or landscape mounting
- Concealed hanging system provides sleek look
- Available in 1.5' x 2', 2' x 3', 3' x 4', 4" x 6', and 4' x 8'



NON-MAGNETIC WHITEBOARDS

Non-Magnetic Whiteboards (M2 & M2W)

Non-Magnetic whiteboards are an affordable whiteboard with a surface that writes and erases beautifully.

- Satin Aluminum or Natural Oak, solid wood framing options
- 4' x 3' and smaller – 1/8" hardboard, attached marker tray
- 5' x 3' and larger – 1/4" hardboard, detached marker tray for easier installation and reduced damage potential
- Available in 2' x 3', 3' x 4', 4' x 4', 4' x 5', 4' x 6', 4' x 8', and 4' x 12' (aluminum frame only)

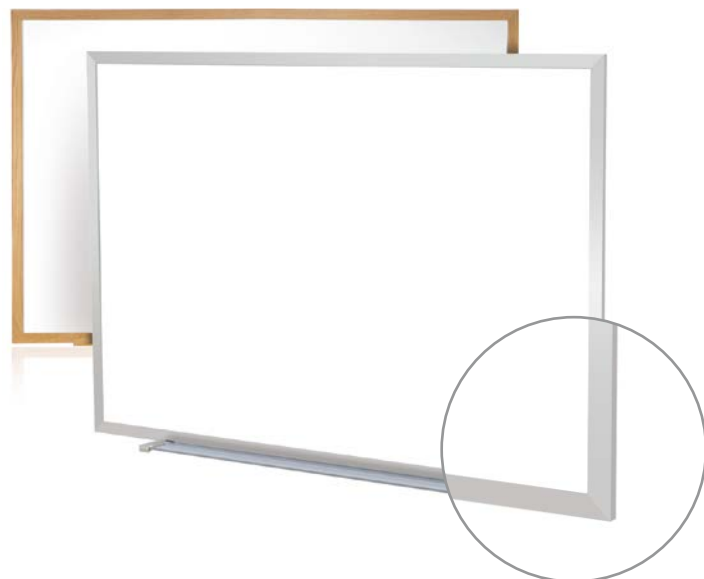

RESURFACING SOLUTIONS

Magnetic Porcelain Resurfacing (RNM1)

Renewal – Our custom-built porcelain whiteboards designed to fit exactly over existing framed boards.

- No need to remove old board – fits easily over existing framed board for installation cost savings
- Surface accepts magnets and resists scratches and stains
- Anodized satin aluminum frame with no marker tray
- Factory-drilled holes in aluminum frame for quick mounting; installs in minutes, includes mounting instructions and hardware
- Order exact size to be covered – includes frame, not tray



GHENT GRAPHICS (GRPM)

Healthcare Boards

Ghent's Healthcare Whiteboards can be used anywhere in your hospital with our specially designed Patient Room boards, Operating Room Time Out boards, and Operating Room Scheduling boards.

- Displays important information to patients and coworkers
- Choose between our patient room, schedule, and time out boards
- Improves communication throughout your healthcare facility



Manufacturing Boards

Ghent's Manufacturing Whiteboards can be used anywhere in your facility for tracking LEAN initiatives with our LEAN Manufacturing tracking board or employee attendance with an In/Out whiteboard.

- Quickly track changes throughout the day
- Choose between our in/out and lean boards
- Displays important information to employees and managers
- Improves communication in corporate and manufacturing environments

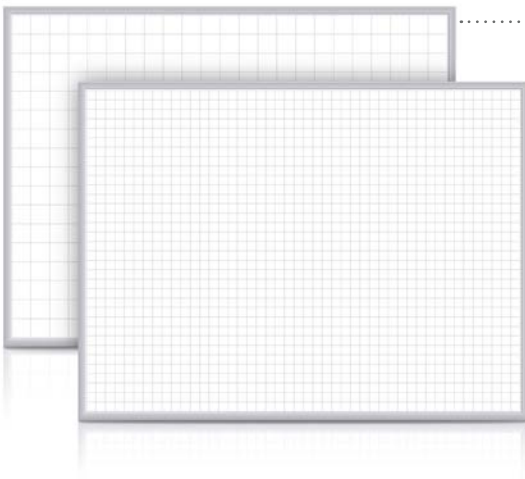
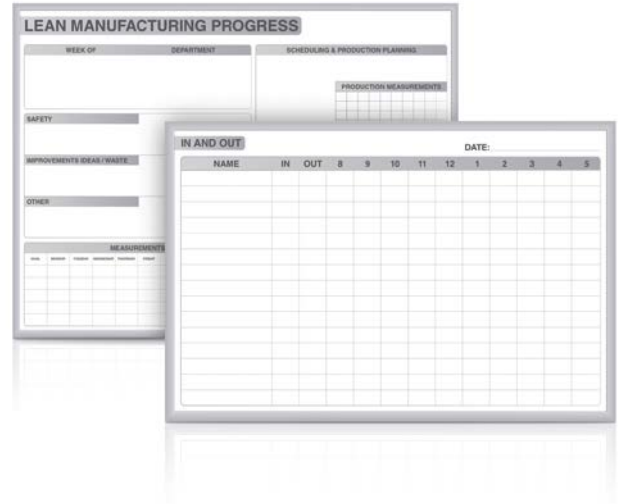

Grid Whiteboards

Ghent's dry erase boards can be used anywhere in your school or business with our specially designed 1" x 1" and 2" x 2" grid boards. The graphics on our erasable board encourage interaction in the classroom and provide important information to employees and customers in the office.

- Create quick graphs and sketches
- Choose between 1" x 1" and 2" x 2" grid
- Displays clean and clear information to an audience
- Improves communication in corporate and educational spaces



RESURFACING SOLUTIONS

PSC Skins

Porcelain sheets can be applied directly to wall or face of worn boards.

- Surface is white porcelain-on-steel
- PSC sheets accept magnets and resist stains
- Includes disposable board that protects metal edges, assists with handling, and prevents creases during installation
- Innovative installation method makes PSC sheets simple to apply
- Available in 4' x 4', 4' x 6', 4' x 8', 4' x 10', 4' x 12', and custom sizes

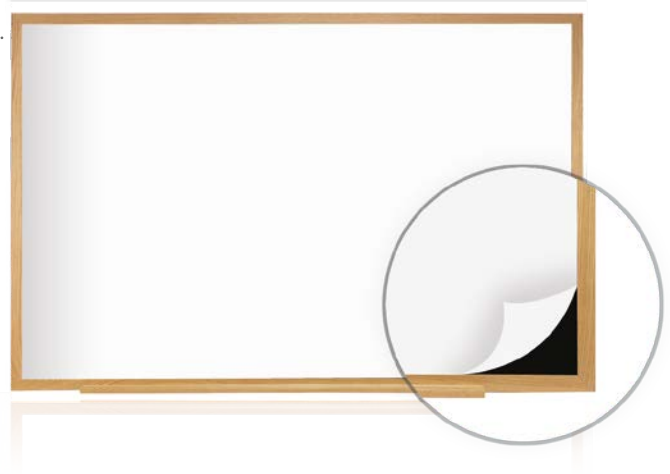

COMMUNICATION FURNITURE

VisuALL PC (413)

Combined whiteboard surface with a useful fabric bulletin board in an enclosed system for discretion.

- Opens to an ample 6' of whiteboard surface
- Closes to 3' of convenient fabric bulletin board
- Cabinet measures 2' x 3' closed
- Available in choice of Gray, Blue, or Beige fabric
- Comes complete with mounting accessories for easy attachment to walls or for hanging from divider panels

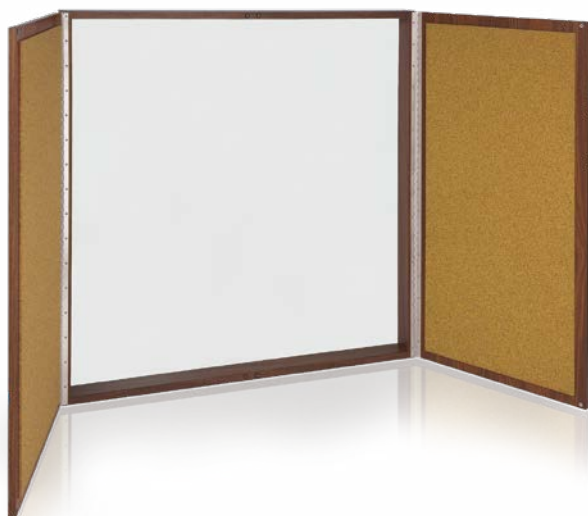
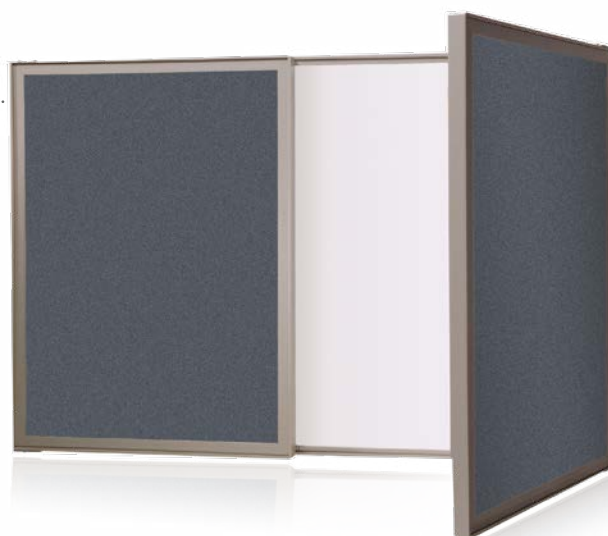

Conference Cabinets (C1)

Mahogany or Oak cabinets with magnetic porcelain whiteboard and tackable surfaces.

- These sturdy units feature top-quality Mahogany or Medium Oak laminate surface with hinged doors and magnetic door latches
- Self-healing natural cork bulletin boards line the inside of both doors
- Interior depth of 3" allows for marker and eraser storage when closed
- Cabinet measures 4' x 4' closed and extends 5" from the wall
- Doors can be customized with whiteboard surface



Horizontal Sliders (HSM)

Sliders provide multiple whiteboard panels to serve a multitude of needs.

- Horizontal Sliders uses a porcelain whiteboard surface creating a durable, high-performance board that resists scratches and stains
- Doubles amount of usable space with fixed back panel and two sliding panels – up to 24' of horizontal writing surface
- Top-suspended panels glide on nylon rollers for smooth operation
- Accepts magnets and magnetized accessories
- Constructed with heavy-duty anodized aluminum trim
- Available in 4' x 6', 4' x 8', 4' x 10', and 4' x 12'



MOBILE WHITEBOARDS

Mobile and Rolling Collaboration Products



“ Movement promotes brainstorming – why stand still?

Ghent's line of mobile, reversible, and rolling whiteboards allow for brainstorming and collaboration when wall space isn't available. Modern design meets durability for a mobile whiteboard solution that will fit into any space.



Link Selling vs Con Marketing

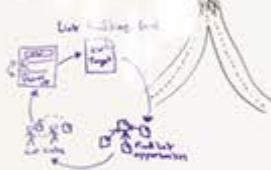

- What to check?
- Goals & Metrics
 - Long term vs. Short term
 - Multi-channel vs. Single
 - Breadth vs. Depth of reach

Contact Marketing Cycle



Nexus mobile whiteboard shown.

ROAM

Roam (RM)

- Double-sided mobile whiteboard with edge-to-edge writing surface workspace for personal use or group interaction
- 42" H x 36" W writing surface constructed of non-ghosting, high-pressure laminate
- Satin aluminum double-sided tray and legs complement any décor
- Constructed with 2.5" heavy-duty casters that allow for ease of use throughout any flooring surface
- Compact nesting allows for multiple units to fit within the same footprint
- Low center of gravity creates stability in use and while roaming
- Optimal for seated or standing positions
- Lightweight – complete unit only weighs 46 lbs, overall dimensions are 69" H x 36" W



REVERSIBLE BOARDS

Mobile Whiteboards (AR & R)

Double-sided mobile whiteboard, available in Satin Aluminum or wood frames in magnetic porcelain or non-magnetic writing surfaces.

- Reversing mechanism designed to make flipping to the other side easy
- Steel lock clamps adjust to secure board to preferred position
- Reinforced legs have added bracing for stability and security
- Satin finish anodized aluminum frame – four casters, two locking wheels included; Natural Oak finish solid wood frame – casters sold separately
- Available in marker/marker, marker/cork, cork/cork
- 4' x 3' and 6' x 4' options available



NEXUS

Tablet (NEX101TM)

The Nexus Tablet is a lightweight and portable solution that provides a markerboard workspace for use wherever it is needed.

- Right-sized – spacious 28" x 28" double-sided, high-pressure laminate whiteboard workspace for personal use or group interaction
- Compact – simple to move from room to room and pack away for storage
- Lightweight – weighing only 3 lbs, the tablet is perfect for break-out sessions
- Environmentally friendly – more durable, reusable, and greener solution than traditional chart pads



Easel+ (NEX204EP)

Nexus Easel+ combines the best parts of the Nexus family into one product. Featuring the usability and writing surface of the Easel, the tablet-storage space of the Caddy plus double the hanging space, the Easel+ is one of the most versatile whiteboards on the market.

- Double-sided 76" H x 40" W porcelain whiteboard – more durable, reusable, and green
- Angled foot design – allows units to be grouped for a more coordinated collaboration space
- Expandable workspace – attached side pegs give you the option of adding Tablets for additional room
- Sleek and contemporary frosted acrylic paneling, allows Nexus to cohesively fit with any decor
- Customizable surface options: marker/marker, marker/tack, and tack/tack

IdeaWall (NEX206MW)

The Nexus IdeaWall is a mobile-porcelain whiteboard with an extra-large 46" x 68.5" magnetic work surface and expandable presentation space.

- Double-sided, 46" H x 69" W porcelain whiteboard – more durable, reusable
- Angled foot design – allows units to be grouped for a more coordinated collaboration space
- Expandable workspace – attached side pegs give you the option of adding Tablets for additional room
- Sleek and contemporary frosted acrylic paneling, allows Nexus to cohesively fit with any decor
- Customizable surface options: marker/marker, marker/tack, and tack/tack



Easel (NEX203ME)

The Nexus Easel is a mobile, double-sided whiteboard that provides a flexible magnetic 46" x 34.5" writing area plus expandable workspace for tablets.

- Double-sided, 46" x 34.5" porcelain whiteboard – more durable, reusable, and green
- Angled foot design – allows units to be grouped for a more coordinated collaboration space
- Expandable workspace – attached side pegs give you the option of adding Tablets for additional writing space
- Sleek and contemporary frosted acrylic paneling, allows Nexus to cohesively fit with any decor
- Customizable surface options: marker/marker, marker/tack, and tack/tack



Partition (NEX224)

The Nexus Partition is a mobile whiteboard with an extra-large 65" x 46.5" whiteboard work surface and expandable presentation space.

- Double-sided, 65" x 46.5" magnetic porcelain marker surface – more durable, reusable, and green
- Angled foot design – allows units to be grouped for a more collaborative space
- Expandable workspace – attached side pegs give you the option of adding Tablets for additional room
- Divide and conquer – Nexus Partition allows small groups to partition off their space to collaborate on a beautiful writing surface while minimizing distractions
- Available in marker/marker, marker/tack, and tack/tack options (see page 60 for all surfaces)



Jr. Partition (NEX223)

The Nexus Jr. Partition is a mobile whiteboard with a compact 46" x 34.5" work surface and expandable presentation space – perfect for seated-height applications.

- Sized for seated comfort – the size of the Jr. Partition is perfect for small group collaboration, especially for the seated position and is ADA compliant
- Double-sided, 46" x 34.5" magnetic marker surface – more durable, reusable, and greener solution than traditional chart pads
- Expandable workspace – attachable easel pegs give you the option of adding Tablets for additional room
- Available in marker/marker, marker/tack, and tack/tack options (see page 60 for all surfaces)



WallBoard (NEX-WMB)

The Nexus WallBoard is a traditional stationary display panel with a porcelain whiteboard work surface.

- Stylish Nexus design allows the WallBoard to seamlessly match your other Nexus products
- Brings Nexus beyond wheels and onto walls, so all collaborators can enjoy the style, performance, and durability of Nexus
- Available in 36" x 48" and 48" x 72"



X-Pegs (NEX001XP- ONE PAIR, NEX004XP: FOUR PAIR)

X-Hangers:

Small (NEX011XHS - ONE PAIR, NEX014XHS - FOUR PAIR)

Large (NEX021XHL - ONE PAIR, NEX024XHL - FOUR PAIR)

Nexus X-Pegs are a flexible, low-profile display system for Tablet whiteboards that accommodate a variety of wall-mounting options. The Nexus X-Hangers adjust to fit snugly onto various thicknesses of dividers.

X-Pegs

- Low-profile wall visibility – requires only a single pair of X-Pegs per Tablet markerboard
- Flexible mounting options – X-Peg pairs can be mounted in a single row for presenting a line of multiple Tablets or in multiple rows for upper-level image display and lower-level writing
- Easy to hang – each X-Peg is easily attached to the wall with a single fastener

X-Hangers

- Panel hangers adjust to fit snugly onto various thicknesses of dividers
- Simple to use – Nexus Tablets fit easily into X-Hanger openings for intuitive connection and fit
- Easy to hang – attaches onto top of partition with thumb screws to secure into position



X-Pegs



X-Hangers



BULLETIN BOARDS

Premium Frame & Surface Selections



“ Share and post what matters with pride

Display your messages and announcements in style. With many frame options, and even more surface options, you'll find a bulletin board that's just right for you.

Tack on More Options

Many of our products can be customized with one of hundreds of different tack surfaces offered in a variety of colors. Visit page 62-63 or go to ghent.com/finishes to learn more.



3' x 4' Cork bulletin board with aluminum frame.

PREMIUM CORK BULLETIN BOARDS



Premium Aluminum (059) & Wood (066)

Cork bulletin board with premium frame and our thickest and most durable cork, available in aluminum or wood frames.

- Surface is smooth, resilient, and self-healing to remain soft and pliable for years
- Thicker, upscale frame available in smooth aluminum and wood
- 3/8" sealed back fiberboard for rigidity and stability
- Available in 1.5' x 2', 2' x 3', 2.5' x 3', 3' x 4', 4' x 4', 4' x 5', 4' x 6', and 4' x 8'



TRADITIONAL CORK BULLETIN BOARDS

Aluminum (AK, 13) & Wood (WK, 14)

Cork bulletin board available in aluminum or wood frames.

- Self-healing cork surface
- Framing available in Satin Aluminum or Natural
- Durable enough to provide years of service, even under the heaviest use
- Cork laminated on a 3/8" fiberboard for rigidity and stability
- Available in 1.5' x 2', 2' x 3', 2.5' x 3', 3' x 4', 4' x 4', 4' x 5', 4' x 6', 4' x 8', 4' x 10', and 4' x 12'

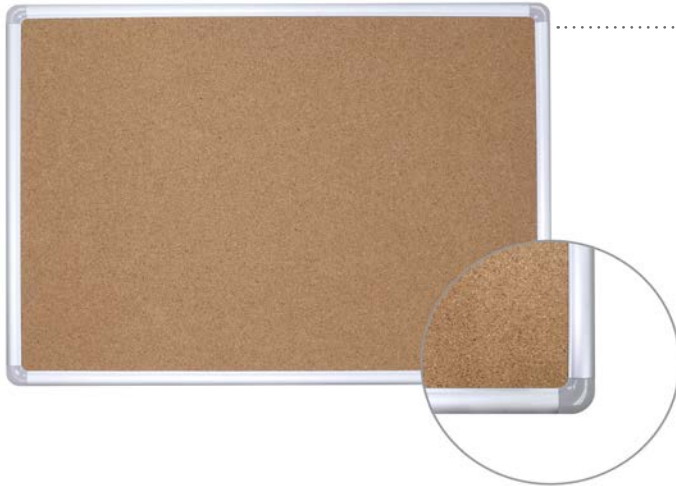

Image Trim (ITGK)

Cork bulletin board in stylish powder-coated frame.

- Self-healing cork surface
- Stylish powder-coated graphite fleck finish on aluminum frame
- Durable enough to provide years of service, even under the heaviest use
- Cork laminated on a 3/8" fiberboard for rigidity and stability
- Available in 4' x 6', 4' x 8', 4' x 10', and 4' x 12'





Cintra (CTSK)

Cork bulletin board in European-style aluminum frame.

- Premium self-healing natural cork surface
- Stylish radius edged, Euro-style satin aluminum frame
- Can be mounted either portrait or landscape
- Concealed hanging system for secure wall mounting
- Available in 1.5' x 2', 2' x 3', 3' x 4', 4' x 6', and 4' x 8'



RECYCLED RUBBER BULLETIN BOARDS

Aluminum (ATR)

Recycled rubber bulletin board with aluminum frame.

- Go "GREEN" – tack surface manufactured from 90% post-industrial material
- Satin Aluminum frame is 75% post-industrial material
- Tack surface is self-healing and will stand up under the heaviest of use
- Surfaces available in Confetti (CF), Tan Speckled (TN), and Black (BK)

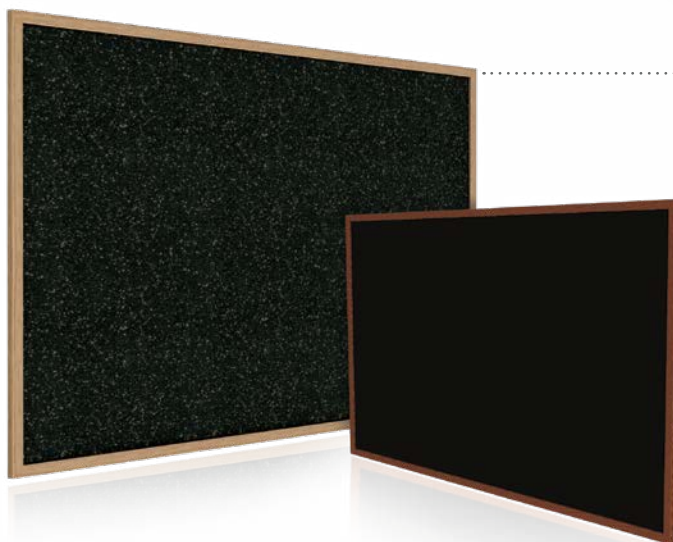

Oak (WTR)

Recycled rubber bulletin board with Cherry Oak and Natural Oak frame options.

- Go "GREEN" – tack surface manufactured from 90% post-industrial material
- Natural or Cherry framing options
- Tack surface is self-healing and will stand up under the heaviest of use
- Surfaces available in Confetti (CF), Tan Speckled (TN), and Black (BK)





VINYL BULLETIN BOARDS

Aluminum (AV, 16) & Wrapped (12UVW)

Vinyl bulletin board, aluminum framed, or wrapped edges.

- Fabric-backed 12 oz. vinyl laminated to 3/8" fiberboard
- Texture masks pin holes and vinyl is washable for areas where cleanliness is extra important
- Frame is anodized Satin Aluminum
- Choice of 10 contemporary colors (see page 62)
- Both aluminum frame and wrapped available in 1.5' x 2', 2' x 3', 2.5' x 3', 3' x 4', 3' x 5', 4' x 4', 4' x 5', 4' x 6', 4' x 8', 4' x 10', and 4' x 12'



DecoAurora (DFV)

Vinyl bulletin board in designer DecoAurora frame.

- Stylish multi-faceted corners and aluminum framing
- Frame inserts available in three rich wood looks and seven bold colors that coordinate with interior furnishings
- Vinyl Gray color surface is durable and washable
- Textured surface hides pinholes for added durability and product life
- Available in 3' x 4', 4' x 4', 4' x 6', 4' x 8', 4' x 10', and 4' x 12'

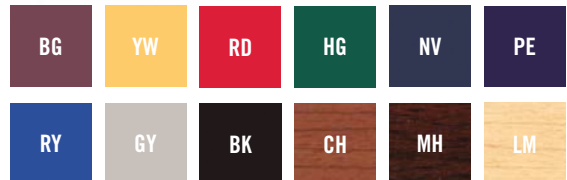
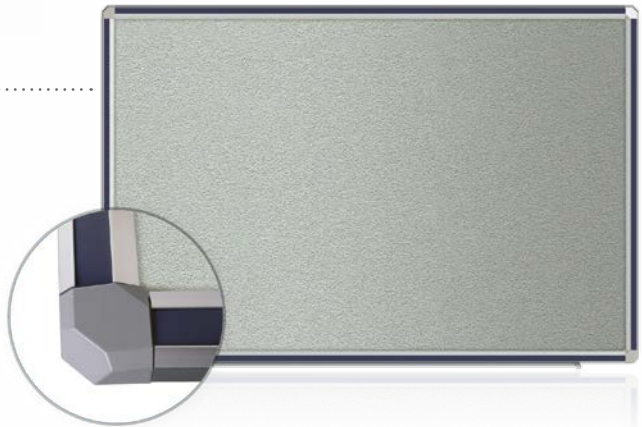

FABRIC BULLETIN BOARDS

Wrapped Edge (TF)

Wrapped-edge fabric boards add style to offices, conference rooms, classrooms, and corridors while providing a sturdy tack surface for posters, announcements, and other notices.

- The warm fabrics are colorfast and will remain free from damage even after years of repeated tacking
- The soft, radius corners and fabric edge design make a tasteful addition to any décor
- Available in five fashion colors: Gray, Beige, Blue, Black, and Merlot
- Available in 1' x 4', 1.5' x 2', 2' x 3', 3' x 4', and 4' x 6'





COLORED CORK BULLETIN BOARDS

Gemini Colored Cork (TG)

- Natural cork is self-healing and masks pin holes created by repeated tacking
- Available in premium Red, Blue, or Green cork
- Board can be hung horizontally or vertically
- Holds push pins, staples, and tacks firmly
- Available in 1.5' x 2', 2' x 3', and 3' x 4'



Aluminum Frame Gemini Colored Cork (AKG, 13xxG)

- Natural cork is self-healing and masks pin holes
- Available in Red, Blue, or Green cork
- Anodized Satin Aluminum frame
- Cork laminated on 3/8" fiberboard for rigidity and stability

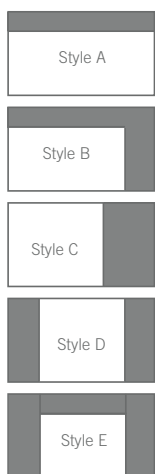

COMBINATION BOARDS

Combo Boards (SPC)

- Modular solution saves time and money
- Easily replaceable sections
- Porcelain surface will accept magnets, resists scratches and stains
- Tack surface – 10 vinyl colors, three recycled rubber colors (see page 62) and natural cork options to seamlessly match any classroom or office
- Frame is anodized Satin Aluminum
- Includes 1" map rail, tray with protective end caps
- SmartPak Tray detached for easier installation, reduced damage potential



ENCLOSED BULLETIN & LETTER BOARDS

Indoor, Outdoor, Lighted, Custom, & Economical



“ Showcasing what’s important

What you have to say is important, and it needs to be secure. We have a wide selection of enclosed message centers for any environment or purpose: Indoor, Outdoor, Custom, Designer, Economical. See for yourself why our enclosed message centers look nicer, perform better, and last longer.

Quality is What Sets Us Apart

Our enclosed bulletin boards are superior when compared to alternatives. With American craftsmanship using premium materials for longevity, our enclosed boards stand the test of time. Go to ghent.com/enclosedquality to learn more.



Indoor Enclosed Message Center.

DESIGNER ENCLOSED BOARDS

Silhouette (SILH)

Silhouette provides an upscale appearance for a wall-mounted enclosed bulletin board with a sleek, contemporary look that maximizes the viewing and display area.

- Unique size allows for nine letter-sized sheets of paper to be completely visible in the viewing area
- Unframed tempered glass door allows for full viewing of what is on display
- Can be mounted to open to either the left or the right
- Modular design allows the freedom to use one or multiple units side-by-side
- Frame options: Satin Aluminum and Black
- Size: 42" H x 28" W



Ovation (OVK & OVG)

Designer enclosed bulletin board with aluminum frame and radius corners.

- Enclosed bulletin boards feature stylish radius corners
- Powder-coated aluminum framing in Black (OVK) or Gray (OVG) matte finish
- Tack surface is fade-resistant and will hold up under the most demanding use
- Concealed corner brackets allow for easy and secure mounting
- Fabric available in Black, Gray, Merlot, Blue, or Beige
- Available with sliding or hinged doors; includes lock for added security
- Available in one, two, and three-door options



TRADITIONAL ENCLOSED BOARDS

Cork (PA, PB, PW, PN & PWC)

Traditional enclosed cork bulletin and dry erase boards in a variety of frame options.

- Available in Satin Aluminum (PA), Bronze (PB), Natural Oak (PW), Walnut (PN), and Cherry Oak (PWC) framing
- Doors feature shatter-resistant acrylic panels
- Flush-mount locks for added security
- Self-healing natural cork surface will withstand repeated tacking
- Concealed corner brackets for easy and secure mounting
- Available in one, two, and three-door options and tack or dry erase surface



Recycled Rubber (PA_TR, PB_TR, PW_TR, PN_TR & PWC_TR)

Recycled Rubber enclosed bulletin board in a variety of frame options.

- Go “GREEN” – tack surface manufactured from 90% post-industrial material
- Available in Satin Aluminum (PA), Bronze (PB), Natural Oak (PW), Walnut (PN), and Cherry Oak (PWC) framing
- Self-healing recycled rubber tack surface hides pin holes
- Available in three tack surface colors – Black (BK), Confetti (CF), and Tan Speckled (TN)
- Doors feature shatter-resistant acrylic panels, flush-mount locks for added security
- Concealed corner brackets for easy and secure mounting
- Available in one, two, and three-door options



Fabric (PA_F, PB_F, PW_F, PN_F & PWC_F) Vinyl (PA_VX, PB_VX, PW_VX, PN_VX & PWC_VX)

Traditional enclosed bulletin board in a variety of frame options, featuring a vinyl or fabric tackable surface.

- Available in Satin Aluminum (PA), Bronze (PB), Natural Oak (PW), Walnut (PN), and Cherry Oak (PWC) framing
- Doors feature full-length hinges and shatter-resistant acrylic panels
- Flush-mount locks for added security
- Available in five fabrics and 10 vinyl tack surface colors
- Concealed corner brackets for easy and secure mounting
- Available in one, two, and three-door options



OUTDOOR ENCLOSED BULLETIN BOARDS

Vinyl (PA_VX & PB_VX)

Outdoor vinyl enclosed bulletin board.

- Weather-resistant design to display and protect important information
- Frame available in Satin (PA) or Bronze (PB) finish anodized aluminum
- All units feature shatter-resistant acrylic doors
- Includes flush-mount locks for added security
- Concealed corner brackets for easy and secure mounting
- Available in one, two, and three-door options and 10 color options (see page 62)



NOTE: For outdoor use, unit should be mounted under an awning or overhang

CUSTOMIZED ENCLOSED



Indoor Headliner (PAK & PBK)

Indoor cork enclosed bulletin board with customizable header.

- Frame available in Satin (PA) or Bronze (PB) finish anodized aluminum
- All units feature shatter-resistant acrylic doors
- Include flush-mount locks for added security
- Natural cork surface is self-healing and will withstand repeated tacking
- Lighted header panel option available
- Concealed corner brackets for easy and secure mounting
- Available in one, two, and three-door options



Outdoor Headliner (PA-VX & PB-VX)

Outdoor vinyl enclosed bulletin board with customizable header.

- Weather-resistant design to display and protect important information
- Frame available in Satin (PA) or Bronze (PB) finish anodized aluminum
- All units feature shatter-resistant acrylic doors
- Include flush-mount locks and two keys for added security
- Vinyl fabric tack surface with sealed back for outdoor use (available in 10 colors)
- Lighted header panel option available
- Available in one, two, and three-door options



NOTE: For outdoor use; unit should be mounted under an awning or overhang



LIGHTED ENCLOSED BULLETIN BOARDS

Concealed Light (CPA)

- Concealed lighting to spotlight and attract attention to your display
- Satin-anodized aluminum frame
- Doors feature full-length hinges, shatter-resistant acrylic panels, and flush-mount locks
- Self-healing natural cork surface will withstand repeated tacking
- Concealed corner brackets for easy and secure mounting
- Available in one, two, and three-door options



ENCLOSED LETTER BOARDS



Indoor Letter Boards (PA_B, PB_B, PW_B, PN_B, PWC_B)

- Available in Satin Aluminum (PA), Bronze (PB), Natural Oak (PW), Walnut (PN), and Cherry Oak (PWC) framing options
- Doors feature shatter-resistant acrylic panels
- Flush-mount locks for added security
- Black or Burgundy flannel letter panel – 1/4" precision grooves for easy letter insertion
- Set of 3/4" Gothic font white letters, numbers and characters (327 pieces included)
- Concealed corner brackets for easy and secure mounting
- Available in one, two, and three-door options



Outdoor Letter Board (PA_BX & PB_BX)

- Weather-resistant durable anodized aluminum frame in Bronze or Satin finish
- Doors feature shatter-resistant acrylic panels
- Flush-mount locks for added security
- Black or Burgundy vinyl letter panel with 1/4" precision grooves for easy letter insertion
- Set of 3/4" Gothic font white letters, numbers, and characters (327 pieces included)
- Available in one, two, and three-door options



NOTE: For outdoor use; unit should be mounted under an awning or overhang

LETTER BOARDS



Ovation (OVG & OVK)

- Make changes easily and keep your message secure
- Detailed, stylish radius corners
- Frame is powder-coated aluminum available in Black (OVK) or Gray (OVG) matte finish
- Black or Burgundy flannel letter panel with 1/4" precision grooves for easy letter insertion
- Set of 3/4" Gothic font white letters, numbers, and characters (327 pieces)
- Available with sliding or hinged doors; includes lock and key for added security
- Concealed corner brackets allow for easy and secure mounting



CUSTOMIZED ENCLOSED LETTER BOARDS

Headliner Letter Board (PAB & PBB)

- Aluminum frame available in Satin (PA) or Bronze (PB) finish
- Available in both indoor and outdoor models
- Doors feature full-length hinges, shatter-resistant acrylic panels, and locks
- Black flannel (indoor) or vinyl (outdoor) letter panel with 1/4" precision grooves for easy letter insertion
- Set of 3/4" Gothic font white letters, numbers and characters (327 pieces included)
- 6" high opaque acrylic header panel, customized message, lighted option
- Concealed corner brackets for easy and secure mounting
- Available in one, two, and three-door options

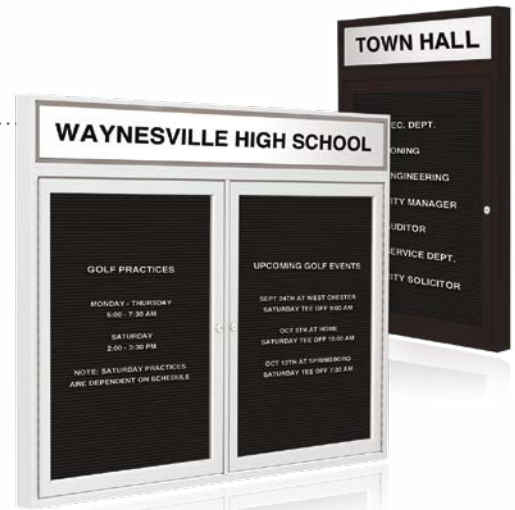

NOTE: For outdoor use, unit should be mounted under an awning or overhang



Ovation enclosed board with Black frame and Blue fabric.

EASELS & DISPLAY RAILS

Lobbies, Hotels, & Conference Centers



“
We all have something
to display

Sometimes your messages need to be displayed in multiple places. Our easels and display rails allow you to be versatile as you communicate wherever that may be.



DISPLAY EASELS

Telescoping Presentation Easel (1050 & 1060)

Presentation easels and accessories are a must for brainstorming sessions, meetings, and sales conferences.

- Available in Satin (1060) or Black (1050) finish anodized aluminum
- Telescoping legs adjust from 2.83' to 5.33' high
- Non-skid feet and adjustable board holders add to its versatility
- Can be used with a whiteboard



Triumph (19250)

- Constructed of ABS gray resin for a lightweight easel
- Holds up to 25 lbs, yet weighs just 3 lbs
- Adjustable to 3.08' table top or 5.17' full size
- Features retractable legs, adjustable placard/board holders, and non-marring feet
- Uses include displaying presentations, artwork, posters, and small boards



PRESENTATION EASELS

Magnetic Marker Easel (1040M3)

Aluminum-framed magnetic markerboard permanently attached to a telescoping easel.

- Can be used as either table top or full size – up to 5.42' tall
- Large steel markerboard measures 2.5' x 3' and accepts magnets
- Full-length flip chart bar and marker tray
- Skid-resistant, rubber-tipped legs



DISPLAY RAILS

Hold-Up (H)

Creative and safe solution to displaying memos, reminders, and artwork.

- No need for tape, tacks, or pushpins
- Allows the flexibility to post thick and thin items side by side
- Can be attached to the top of a board or mounted separately
- Clear front lets entire paper show while blending in with any surface
- Versatile enough for the school hallway, refrigerator, or office filing cabinet
- Available in 1', 1.5', 2', 3', 4', 5', 6', and 8'



CHOOSE THE **WRITE** SURFACE

We pride ourselves on being whiteboard experts. Different environments and applications require different solutions – and that’s what we are proud to offer our customers. Below is a simple guide to choosing the perfect writing surface for your world.

ACRYLITE™ WHITEBOARDS
High Performance Acrylic and will not ghost



- Half the weight of glass
- Twice the scratch resistance of glass
- Polished edges and superior performance



GLASS MARKERBOARDS
Tempered and will not ghost



- 1/4" tempered glass will not ghost
- Variety of styles, colors, and even magnetic
- The ultimate style statement



PORCELAIN
A classic; guaranteed to not ghost



- Non-porous surface will not ghost
- Writes clearly and erases cleanly
- Surface accepts magnets



POWDER COATED
Write in places like never before



- High performance powder coat on steel
- Multiple colors available
- Surface accepts magnets



PAINTED STEEL
A magnetic, durable option



- Multiple layers of coating on steel
- Good performance at a great price point
- Surface accepts magnets



NON-MAGNETIC
Collaborate on a budget



- Painted hardboard surface
- Good option for those on a budget
- Surface is non-magnetic



For more information about cleaning, marker removal, quality, and value of our surfaces visit

PICK THE **BRIGHT** SOLUTION

Want to customize Ghent products with fabric to complement your decor? It's easy with our Tiered Fabric Program! The program consists of three tiers, or options, that allow you to choose from top of the line textiles, along with the ability to customize with your own material. To learn more about our fabric options, visit www.ghent.com/finishes.

1 Tier One: Guilford of Maine

Tier One, consists of five fabric options from Guilford of Maine. Guilford of Maine, the open line brand of True Textiles, Inc., provides woven textile products focusing on the acoustic, healthcare, hospitality, education, and office markets, or any other application where high performance textiles are demanded.



2 Tier Two: Maharam

Together, Ghent and Maharam have developed our Tier Two fabric program containing 124 textile designs in four patterns: Messenger, Medium, Manner, and Metric. Founded in 1902, Maharam is recognized for its rigorous and holistic commitment to design as a leading provider of textiles to architects and interior designers.



3 Tier Three: Custom

Want to incorporate your own fabric into our products? You've come to the right place! With our Tier Three fabric program, you can match other fabrics in your interiors seamlessly by sending us your own fabric to be included in our products.



TACK ON EVEN MORE OPTIONS

We've proudly been making bulletin boards since 1976. Over time, we've developed hundreds of ways to help people get their messages across. Below is a snapshot of our tack surface guide. Most surfaces are available in all of our bulletin board products.

Tier One Fabrics



Cork

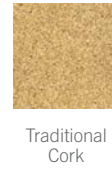

Letterboards

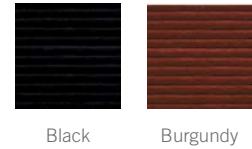

PremaTak Vinyls

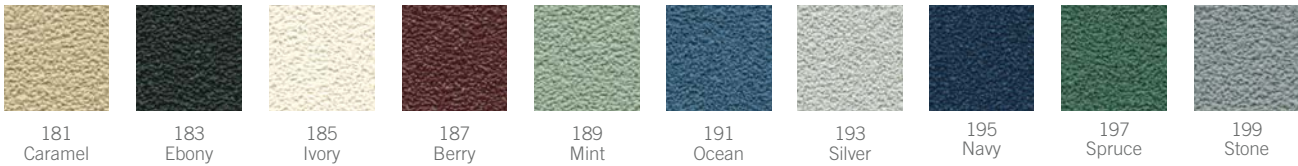

Colored Cork



Recycled Rubber

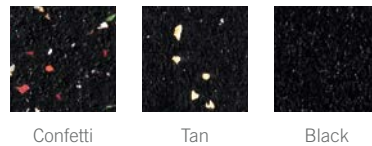

Flair Fabrics

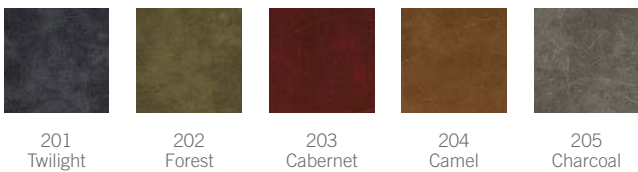

Stroll Fabric maharam

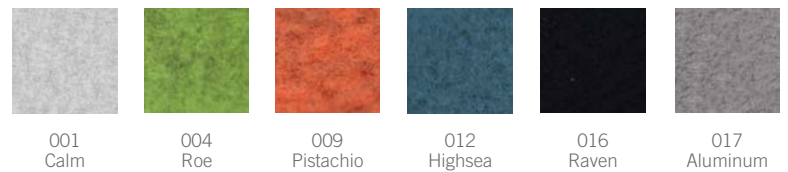

Glass Colors

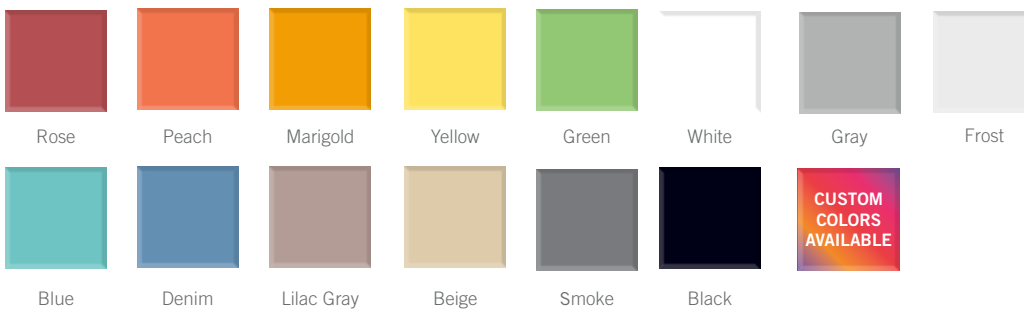

FRAMING THE CONVERSATION

We think we have a frame for everyone. Below is a quick reference guide for many of our frames styles for whiteboards, bulletin boards, and enclosed message centers.

Standard Whiteboard & Bulletin Board Frames



Satin Aluminum



Image Trim



Natural



Cherry



Walnut

Ovation Frames



Black



Gray

Enclosed Frames



Satin Aluminum



Bronze



Natural



Cherry



Walnut

Silhouette Frames

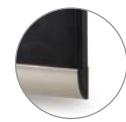

Satin



Black

DecoAurora Frame Colors



Gray

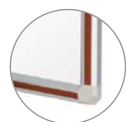

Cherry



Black



Burgundy

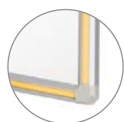

Yellow

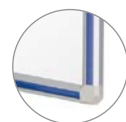

Royal Blue

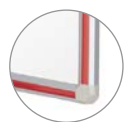

Red



Purple

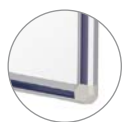

Navy Blue

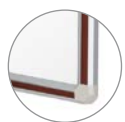

Mahogany

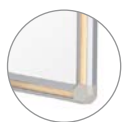

Light Maple

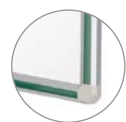

Hunter Green

Impression Classic Frames



Cherry



Espresso



Maple



Walnut

Impression Modern Frames



Cherry



Espresso

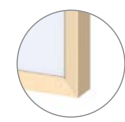

Maple



Walnut



a **GMI** company.

.....

Custom Dry Erase Boards



VividBoard, a sister company of GMI, offers graphically enhanced, custom, dry erase boards to communicate what matters most without sacrificing your brand. Take your generic whiteboard and transform it into an interactive communication tool. Using a patented process, VividBoard embeds brilliant graphics into a high gloss surface for premium quality and durability.

For more information, visit vividboard.com or call 877.543.2999



Nexus IdeaWall (left) with VividBoard custom printed graphic and custom MyHarmony Glassboard (right).

WADDELL®

a **GMI** company®

Display Solutions



For nearly 130 years, craftsmen have been carefully constructing Waddell display cases in the time-honored tradition of Waddell quality. The Waddell brand of display cases has been part of the GMI family of brands since 1986. The difference between a Waddell showcase and others is in the details. This distinctive level of quality can be touched and seen in the solid, well-constructed fit and finish of every case. We combine today's technology and designs with yesterday's personal commitment to constructing the finest USA made cases available.

For more information, visit waddellfurniture.com or call 800.622.1331



Vantage Display Case.



Communicate. Collaborate. Learn.