

Content

Brief Introduction	1
Chapter 1 Accidence	1
1.1 Accidence of Panel and Display Information	2
1.2 Function Checking	5
1.3 Probe	7
1.3.1 Probe Safety	7
1.3.2 Probe Attenuation Setting	7
1.3.3 Probe Compensation	8
Chapter 2 Functions Instruction and Operation	9
2.1 Menu and Control Button	10
2.2 Connector	12
2.3 Auto Setup	12
2.4 Default Setup	14
2.5 Universal Knob	15
2.6 Vertical System	15
2.6.1 CH1, CH2 Channel	16
2.6.2 Using Vertical “Position” Knob and “Volt/div” Knob	21
2.6.3 Math Functions	22
2.6.4 Using Ref	28
2.7 Horizontal System	30
2.7.1 Horizontal Control Knob	31
2.7.2 Window Zone	32
2.8 Trigger System	33
2.8.1 Signal Source	34
2.8.2 Trigger Type	34
2.8.3 Coupling	47
2.8.4 Position	48
2.8.5 Slope & Level	48
2.8.6 Trigger Holdoff	49
2.9 Acquiring Signals System	49
2.10 Display System	55
2.10.1 X-Y Format	59
2.11 Measure System	59
2.11.1 Scale Measurement	60
2.11.2 Cursor Measurement	60
2.11.3 Auto Measurement	66
2.12 Storage System	72
2.13 Utility System	85
2.13.1 System Status	88
2.13.2 Language	88
2.13.3 Self Calibration	89
2.13.4 Self Test	90
2.13.5 Updating the System Software	92
2.13.6 Pass/Fail	92
2.13.7 Waveform Record	96
2.13.8 Recorder	99
2.13.9 Remote Control	102

2.14 Online Help Function.....	109
Chapter 3 Prompting Messages and Troubleshooting	110
3.1 Prompting Messages:	110
3.2 Troubleshooting.....	112
Chapter 4 Service and Support	114
4.1 Maintain Summary	114
4.2 Contact GLOBAL SPECIALTIES	114
Appendix A: Default Setup	115
Appendix B: Daily Maintain and Cleaning	117

Chapter 1 Overview

DSC-5300 Series Digital Oscilloscope is mini-type and portable bench type instruments, which could be used for measuring as the GND voltage.

This Chapter shows you how to operate following tasks:

- Accidence of panel and Display information
- Simple checking of functions
- Matching probes attenuation coefficient
- Probe compensation

1.1 Overview of Panel and Display Information

1.1.1 Front Panel

It is important for you to understand the DSO's front panel before operating it. The following contents are the brief introduction for the front panel function, which is useful to be familiar with the operation of the DSC-5300 Digital Storage Oscilloscope in short time.

The oscilloscopes provides an easy-to-use front panel to convenience users to operate them, the panel contains knobs and buttons. There is a list of five ashen buttons as menu operational buttons on the right of display screen. You can set different options of the current menu in virtue of them. Other buttons are function buttons; you can enter different function menus or obtain given function application in virtue of them.

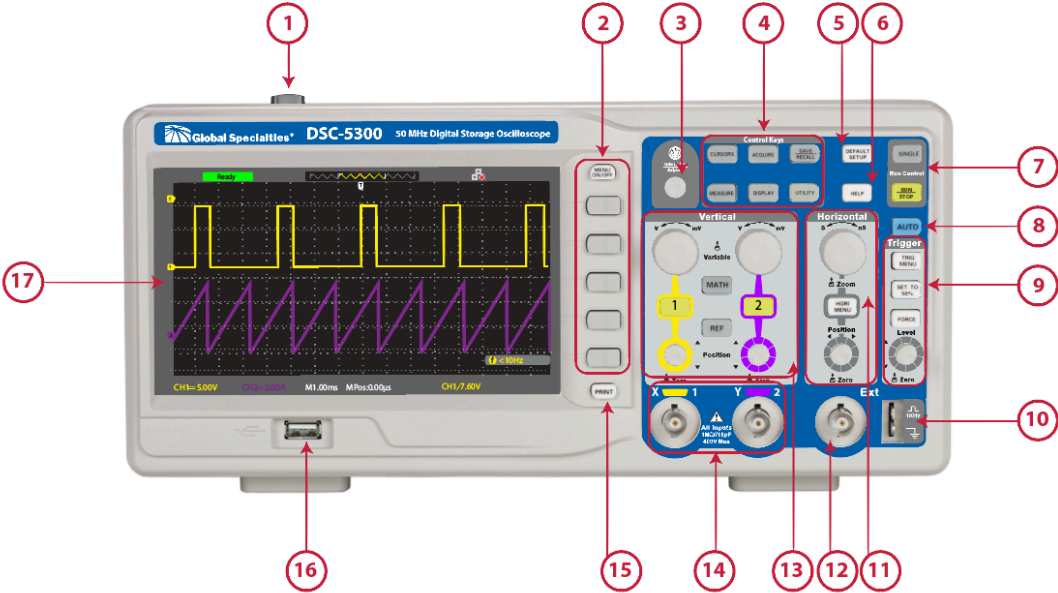

Picture 1.1-1 DSC-5300 Front Panel

No.	Description	No.	Description
1	On/Off Button	10	Probe Compensator
2	Menu On/Off, Menu Softkeys	11	Horizontal Controls
3	Intensity Adjustment	12	External Trigger Input
4	Control Keys	13	Vertical Controls
5	Default Setup Key	14	Input Channels
6	Help Key	15	Print Key
7	Run Control Panel	16	Front USB Connector
8	Autoset Key	17	Display
9	Trigger Control Panel		

1.1.2 Back and Side Connections

The following images show back and side panel connection locations.

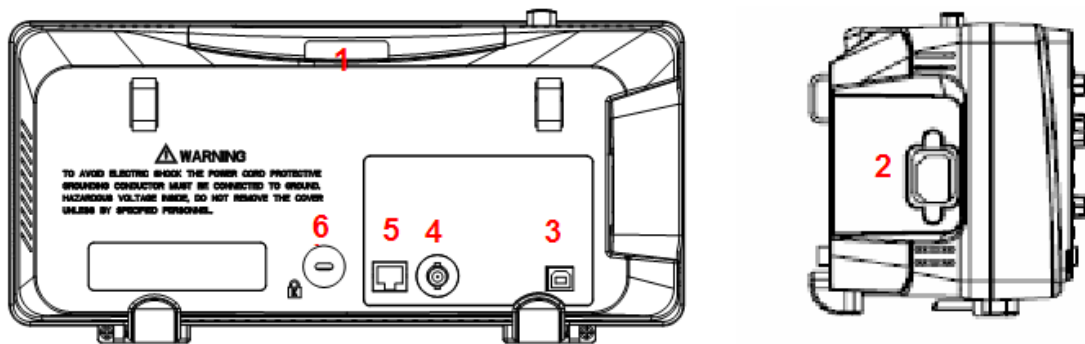

Picture 1.1-2 DSC-5300 Back and Side panel

1. Handle
2. AC Power Input Terminal
3. USB Device Connector
4. Pass/Fail Output Connector
5. LAN Port
6. Lock Hole

1.1.3 User display interface

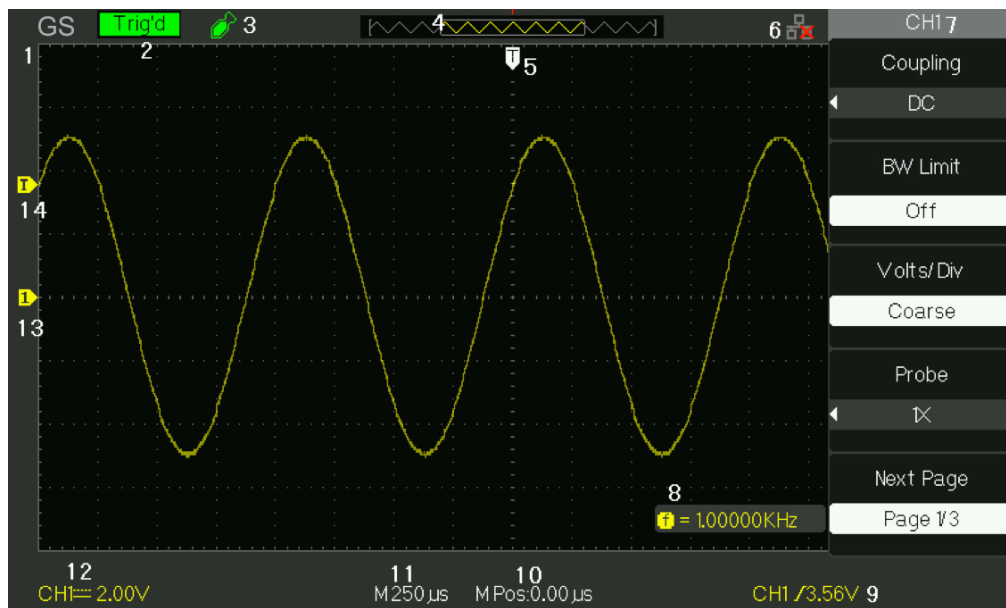

Picture 1.1-3

1. Product Logo

Global Specialties is the registered trademark of our company.

2. Trigger status

Armed. The oscilloscope is acquiring pre-trigger data. All triggers are ignored in this state.

Ready. All pre-trigger data has been acquired and the oscilloscope is ready to accept a trigger.

Trig'd. The oscilloscope has seen a trigger and is acquiring the posttrigger data.

Stop. The oscilloscope has stopped acquiring waveform data.

Auto. The oscilloscope is in auto mode and is acquiring waveforms in the absence of

triggers.

Scan. The oscilloscope is acquiring and displaying waveform data continuously in scan mode.

3. USB Host connected mark.

4. Waveform memory

Show the position of the current waveform in the memory of the oscilloscope.

5. Trigger position.

Turn the HORIZONTAL POSITION knob to adjust the trigger position of the waveform.

6. Show the LAN port.

 Indicates the LAN port is connected.

 Indicates the LAN port is disconnected.

7. Show the Channel symbol.

8. Readout shows trigger signal frequency..

9. Readout shows the trigger level value and trigger type..

10. Readout shows the trigger delay of waveform.

11. Readout shows the main time base setting.

12. Icon shows the channel setting.

13. Icon shows the channel offset position.

14. Icon shows the trigger level position

1.2 Function Checking

When you check whether or not the oscilloscope could work smoothly, please operate as following:

1. Power On the oscilloscope.

Press “DEFAULT SETUP” to show the result of the self check. The probe default attenuation is 1X.

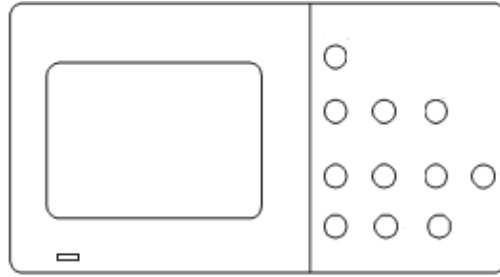

Picture 1.2- 1

2. Set the switch to 1X on the probe and connect the probe to channel 1 on the oscilloscope. To do this, align the slot in the probe connector with the key on the CH 1 BNC, push to connect, and twist to the right to lock the probe in place. Connect the probe tip and reference lead to the PROBE COMP connectors

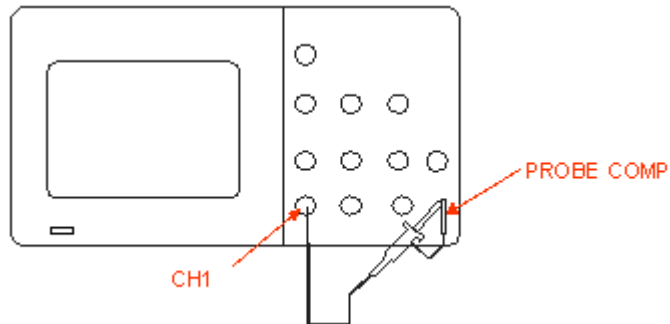

Picture 1.2-2

3. Press “AUTO” to show the 1 KHz frequency and about 3V peak-peak square wave in couple seconds

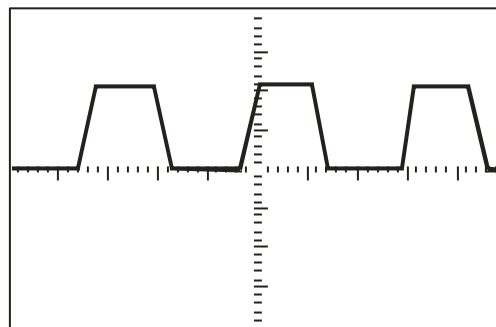

Picture 1.2-3

4. Press “CH1” two times to cancel the channel 1, Press“CH2” to change screen into channel 2, reset the channel 2 as step 2 and step 3.

1.3 Probe

1.3.1 Probe Safety

A guard around the probe body provides a finger barrier for protection from electric shock.

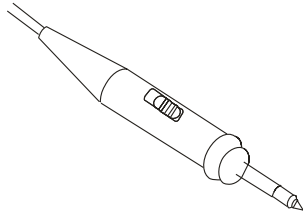

Picture 1.3-1

Connect the probe to the oscilloscope and connect the ground terminal to ground before you take any measurements.

- Note** □
- To avoid electric shock when using the probe, keep fingers behind the guard on the probe body.
 - To avoid electric shock while using the probe, do not touch metallic portions of the probe head while it is connected to a voltage source. Connect the probe to the oscilloscope and connect the ground terminal to ground before you take any measurements.

1.3.2 Probe Attenuation Setting

Probes are available with various attenuation factors which affect the vertical scale of the signal. The Probe Check function verifies that the Probe attenuation option matches the attenuation of the probe.

You can push a vertical menu button (such as the CH 1 MENU button), and select the Probe option that matches the attenuation factor of your probe.

Note: The default setting for the Probe option is 1X.

Be sure that the attenuation switch on the probe matches the Probe option in the oscilloscope. Switch settings are 1X and 10X.

Note: When the attenuation switch is set to 1X, the probe limits the bandwidth of the oscilloscope to 6MHz (according to Probe spec). To use the full bandwidth of the oscilloscope, be sure to set the switch to 10X

1.3.3 Probe Compensation

As an alternative method to Probe Check, you can manually perform this adjustment to match your probe to the input channel.

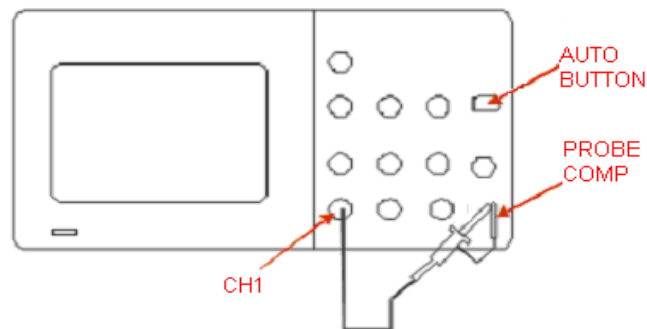

Picture1.3-2

1. Set the Probe option attenuation in the channel menu to 10X. Set the switch to 10X on the probe and connect the probe to channel 1 on the oscilloscope. If you use the probe hook-tip, ensure a proper connection by firmly inserting the tip onto the probe.
2. Attach the probe tip to the PROBE COMP 3V connector and the reference lead to the PROBE COMP Ground connector. Display the channel and then push the "AUTO" button.
3. Check the shape of the displayed waveform.

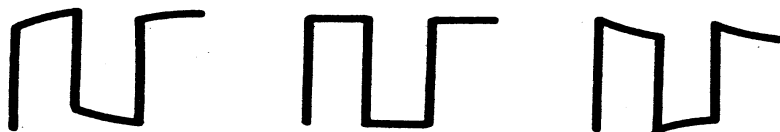

Over Compensated Under
Compensated Correctly Compensated

Picture 1.3-3

4. If necessary, adjust your probe. Repeat as necessary.

Chapter 2 Functions Instruction and Operation

To use your oscilloscope effectively, you need to learn about the following oscilloscope functions:

- Menu and control button
- Connector
- Auto Setup
- Default Setup
- Universal knob
- Vertical System
- Horizontal System
- Trigger System
- Acquiring signals System
- Display System
- Measuring waveforms System
- Utility System
- Storage System
- Online Help function

2.1 Menu and Control Button

Showing as the following picture:

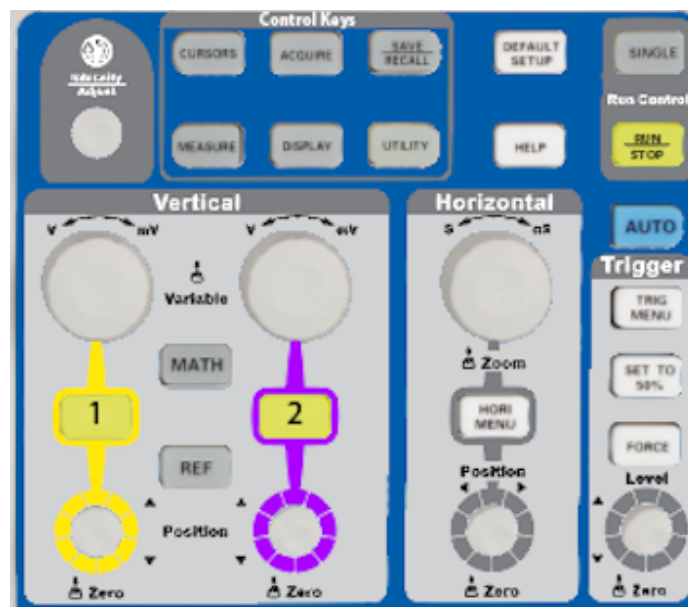

Picture 2-1

- **Channel buttons (1, 2):** Press a channel button to turn that channel ON or OFF and open the channel menu for that channel. You can use the channel menu to set up a channel. When the channel is on, the channel button is lit.
- **MATH:** Press to display the Math menu. You can use the MAH menu to use the oscilloscopes Math functions.
- **REF:** Press to display the Ref Wave menu. You can use this menu to save and recall four or two reference waveforms internal memory.

- **HORI MENU:** Press to display the Horizontal menu. You can use the Horizontal menu to display the waveform and zoom in a segment of a waveform.
- **TRIG MENU:** Press to display the Trigger menu. You can use the Trigger menu to set the trigger type (Edge, Pulse, Video, Slope, Alternative) and trigger settings.
- **SET TO 50%:** Press to stabilize a waveform quickly. The oscilloscope can set the trigger level to be halfway between the minimum and maximum voltage level automatically. This is useful when you connect a signal to the EXT TRIG connector and set the trigger source to Ext or Ext/5.
- **FORCE:** Use the FORCE button to complete the current waveform acquisition whether the oscilloscope detects a trigger or not. This is useful for Single acquisitions and Normal trigger mode.
- **SAVE/RECALL:** Press to display the Save/Recall menu. You can use the Save/Recall menu to save and recall up to 20 oscilloscope setups or waveforms in internal memory (up to 20 waveforms) or on a USB memory device (limited by memory capacity of USB device). You can also use it to recall the default factory settings, to save waveform data as a comma-delimited file (.CSV), and to save or print the displayed waveform image.
- **ACQUIRE:** Press to display Acquire menu. You can use the Acquire menu to set the acquisition Sampling Mode (Sampling, Peak Detect, Average).
- **MEASURE:** Press to display a menu of measurement parameters.
- **CURSORS:** Display the Cursor Menu. Vertical Position controls adjust cursor position while displaying the Cursor Menu and the cursors are activated. Cursors remain displayed (unless the “Type” option is set to “Off”) after leaving the Cursor Menu but are not adjustable.
- **DISPLAY:** Press to open the Display menu. You can use the Display menu to set grid and waveform display styles, and persistence.
- **UTILITY:** Press to open the Utility menu. You can use the Utility menu to configure oscilloscope features, such as sound, language, counter, etc. You can also view system status and update software.
- **DEFAULT SETUP:** Press to reset the oscilloscope’s settings to the default factory configuration.

- **HELP:** Enter the online help system.
- **AUTO:** Automatically sets the oscilloscope controls to produce a usable display of the input signals.
- **RUN/STOP:** Continuously acquires waveforms or stops the acquisition.
 Note □ If waveform acquisition is stopped (using the RUN/STOP or SINGLE button), the SEC/DIV control expands or compresses the waveform.
- **SINGLE:** Acquire a single waveform and then stops.

2.2 Connector



Picture 2-2

- **Channel Connector (CH1, CH2):** Input connectors for waveforms display.
- **EXT TRIG:** Input connector for an external trigger source. Use the Trigger Menu to select the “Ext” or “Ext/5” trigger source.
- **Probe Component:** Voltage probe compensation output and ground. Use to electrically match the probe to the oscilloscope input circuit.

Note: If you connect a voltage source to a ground terminal, you may damage the oscilloscope or the circuit under test. To avoid this, do not connect a voltage source to any ground terminals.

2.3 Auto Setup

The DSC-5300 Digital Storage Oscilloscopes have a Auto Setup function that identifies



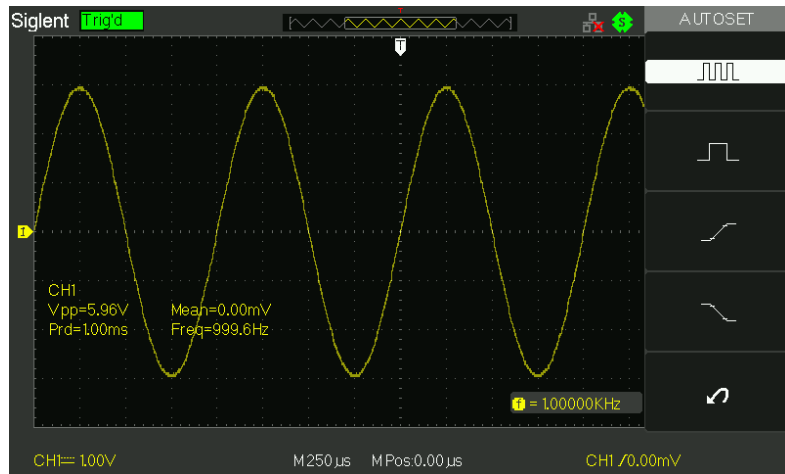

the waveform types and automatically adjusts controls to produce a usable display of the input signal.

Press the **AUTO** button, and then press the menu option button adjacent to the desired waveform as follows:



Picture 2-3

Table 2-1 Auto Set function Menu:

Option	Description
 Multi-cycle sine	Auto set the screen and display several cyc signal.
 Single-cycle sine	Set the screen and auto display single cyc signal.
 Rising edge	Auto set and show the rising time.
 Falling edge	Auto set and show the falling time.
 Undo Setup	Causes the oscilloscope to recall the previous setup.

Auto set determines the trigger source based on the following conditions:

- If multiple channels have signals, channel with the lowest frequency signal.
- No signals found, the lowest-numbered channel displayed when Auto set was invoked
- No signals found and no channels displayed, oscilloscope displays and uses channel 1.

Table 2-2 Auto set the function item

Function	Setting
----------	---------

Acquire Mode	Adjusted to Sampling
Display Format	Y-T
Display Type	Set to Dots for a video signal, set to Vectors for an FFT spectrum; otherwise, unchanged
Vertical Coupling	Adjusted to DC or AC according to the input signal
Bandwidth Limit	Off(full)
V/div	Adjusted
VOLTS/DIV adjustability	Coarse
Signal inverted	Off
Horizontal position	Center
S/div	Adjusted
Trigger type	Edge
Trigger source	Auto detect the channel which has the input signal
Trigger slope	Rising
Trigger mode	Auto
Trigger coupling	DC
Trigger holdoff	Minimum
Trigger level	Set to 50%

2.4 Default Setup

The oscilloscope is set up for normal operation when it is shipped from the factory. This is the default setup. To recall this setup, press the DEFAULT SETUP button. The options, buttons and controls that change settings when you press the DEFAULT SETUP button, refer to appendix B.

The DEFAULT SETUP button does not reset the following settings:

- Language option
- Saved reference waveform files
- Saved setup files
- Display contrast
- Calibration data

2.5 Universal Knob



Picture 2-5 Universal Knob

You can use the Universal knob with many functions, such as adjusting the holdoff time, moving cursors, setting the pulse width, Setting the Video Linage, adjusting the upper and lower frequency limit, adjust X and Y masks when using the pass/fail function etc. You can also turn the “Universal” knob to adjust the storage position of setups, waveforms, pictures when saving/recalling and to select menu options.

2.6 Vertical System

The vertical control could be used for displaying waveform, rectify scale and position.

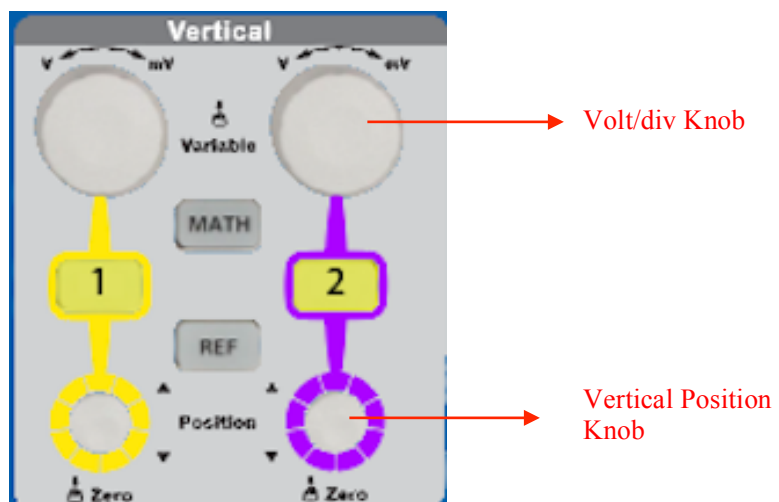

Picture 2.6-1

2.6.1 CH1, CH2 Channel

Table 2-1 CH1, CH2 function menu 1:

Option	Setting	Introduction
Coupling	DC	DC passes both AC and DC components of the input signal.
	AC	AC blocks the DC component of the input signal and attenuates signals below 10 Hz.
	GND	GND disconnects the input signal.
BW limit	On	Limits the bandwidth to reduce display noise; filters the signal to reduce noise and other unwanted high frequency components.
	Off	
Volts/Div	Coarse	Selects the resolution of the Volts/Div knob Coarse defines a 1-2-5 sequence. Fine changes the resolution to small steps between the coarse settings.
	Fine	
Probe	1X,5X 10X,50X 100X, 500X,1000X	Set to match the type of probe you are using to ensure correct vertical readouts.
Next Page	Page 1/3	Enter the second page of the menu.

Table 2-4 CH1, CH2 function menu 2:







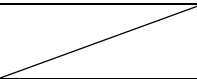

Option	Setting	Instruction
Invert	on	Turn on invert function.
	off	Turn off invert function.
Digital Filter		Press this button to enter the "Digital Filter menu".(See table 2-5)
Next Page	Page 2/3	Enter the second page of the menu.

Table 2-5 Digital Filter function menu:

Option	Setting	Introduction
Digital Filter	On	Turn on the digital filter.
	Off	Turn off the digital filter.
Type		Setup as LPF (Low Pass Filter).
		Setup as HPF (High Pass Filter).
		Setup as BPF (Band Pass Filter).
		Setup as BRF (Band Reject Filter).
Upper_limit		Turn the "Universal" knob to set upper limit.
Lower_limit		Turn the "Universal" knob to set lower limit.
Return		Return the digital filter main menu.

Setting CH1, CH2 Channels

Each channel has its own separate Menu. The items are set up separately according to each channel.

1. Choosing Coupling

Take the CH1 for example; the tested signal is a sine wave signal with DC deflection:

- Press “CH1” → “Coupling” → “AC”, Set to AC couple mode. It blocks the DC component of the input signal.
- Press “CH1” → “Coupling” → “DC”, Set to DC couple mode. Both DC and AC component could be obstructed.
- Press “CH1” → “Coupling” → “GND”, Set to GROUND mode. It disconnects the input signal.

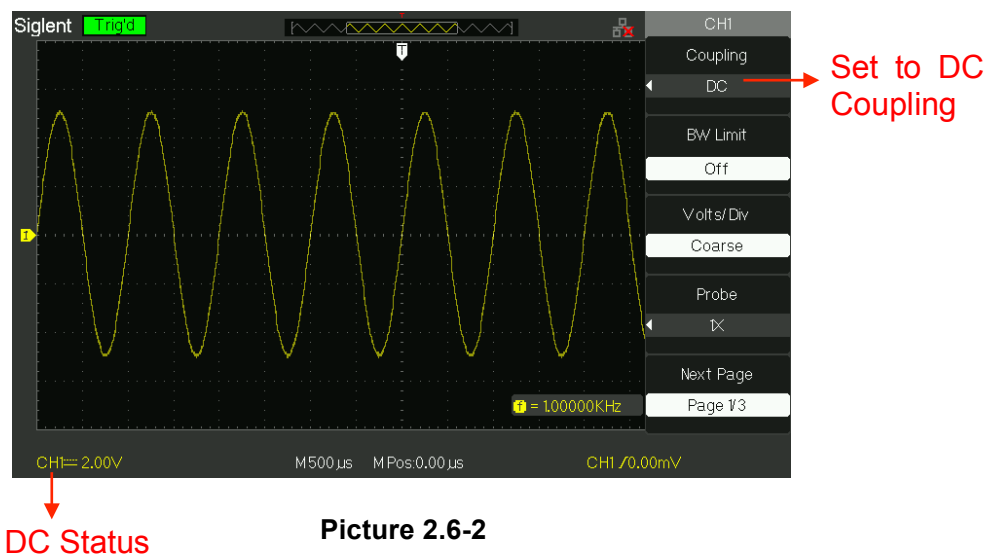

Picture 2.6-2

2. Bandwidth Limiting

Take the CH1 for example; the tested signal is a pulse signal with the high frequency surge:

- Press “CH1” → “BW Limit” → “On” □ Set the band width Limited to open state. The high frequency component which is higher than 20 MHz obstructed.
- Press “CH1” → “BW Limit” → “Off”, Set bandwidth Limited to close state, the High

Frequency component in the tested signal could pass.

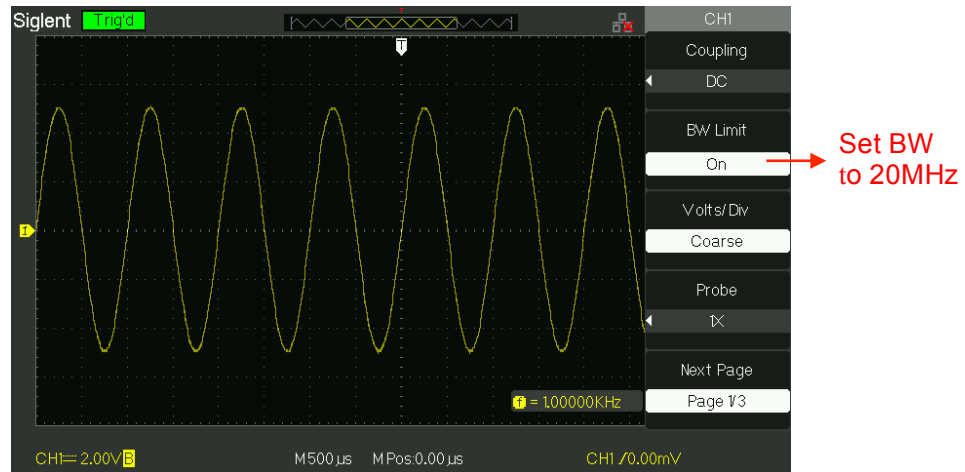

Picture 2.6-3

3. Adjust Sensitivity

Vertical scale adjusting has Coarse and Fine two modes, Vertical sensitivity range is 2mV/div□10V/div scale.

Take the CH1 for example:

- Press “CH1”→“Volts/Div”→“Coarse”. It is the default setting of Volts/Div, and it makes the vertical scaling in a 1-2-5-step sequence from 2mv/div, 5mv/div, 10mv/div to 10v/div.
- Press “CH1”→“Volts/Div”→“Fine”. This setting changes the vertical to small steps between the coarse settings. It will be helpful when you need to adjust the waveform vertical size in smooth steps.

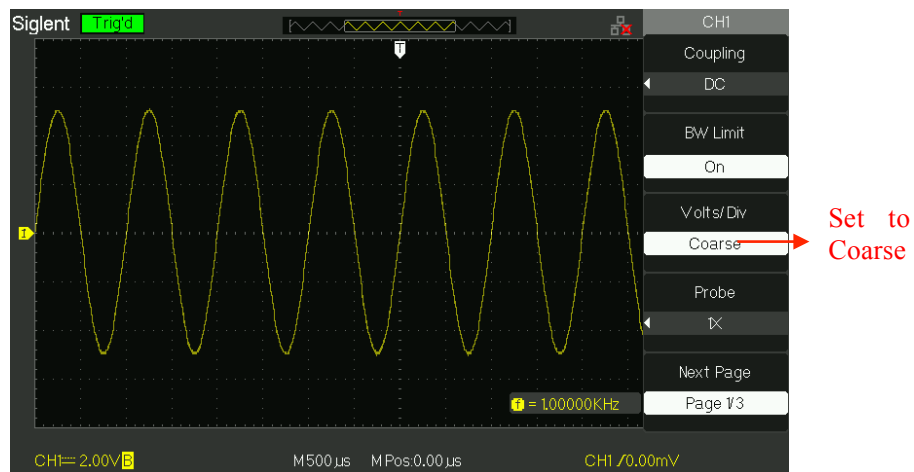

Picture 2.6-4

4. Setting Probe Attenuation

In order to assort the attenuation coefficient, you need to response in the channel operation Menu. If the attenuation coefficient is 10:1, the input coefficient should be set to 10X, so that the mistake of the Volts/div information and measure testing should be forbidden.

Take the CH1 for example, when you use the 100:1 probe:

- Press “CH1” → “Probe” → “100”

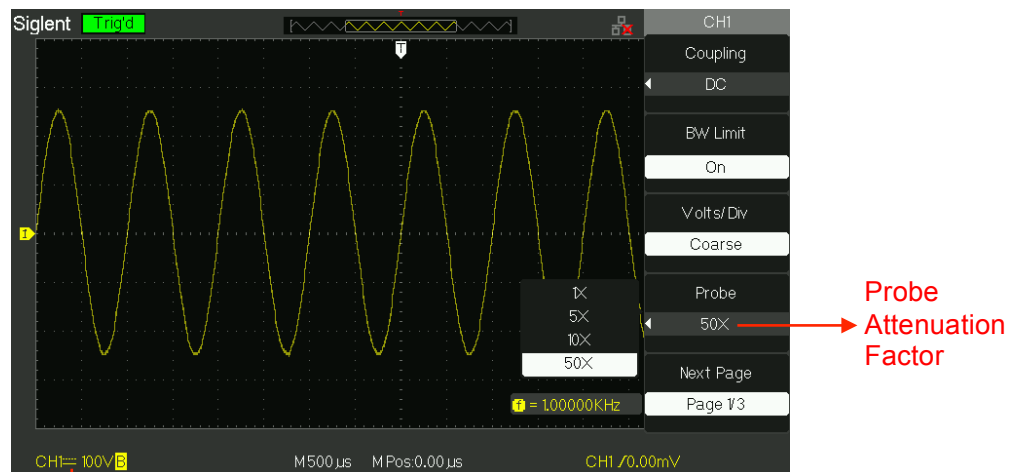

Picture 2.6-5

5. Inverting waveforms

Take the CH1 for example:

- Press “CH1” → Next Page “ page1/3” → “Invert” → “On”:

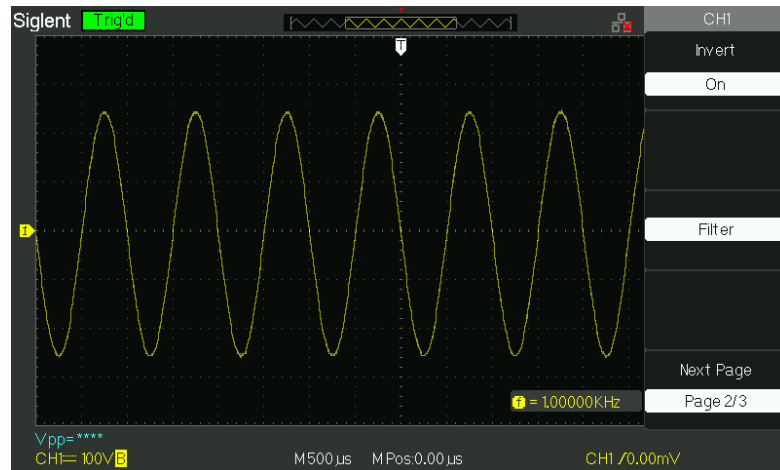

Picture 2.6-6

6. Using the Digital Filter

Press “CH1”→“Next Page page1/3”→ “Filter”, display the digital filter menu. Select “Filter Type”, then select “Upper Limit” or “Lower Limit” and turn the “Universal” knob to adjust them.

- Press “CH1”→“Next Page page1/3”→ “Filter” →“Off”. Turn off the Digital Filter function.

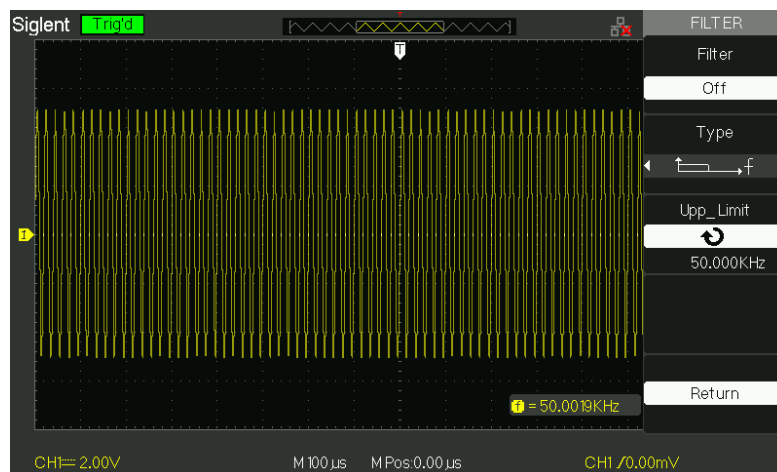

Picture 2.6-7

- Press “CH1”→ “Next Page page1/3”→ “Filter” → “On”. Turn on the Digital Filter

function.

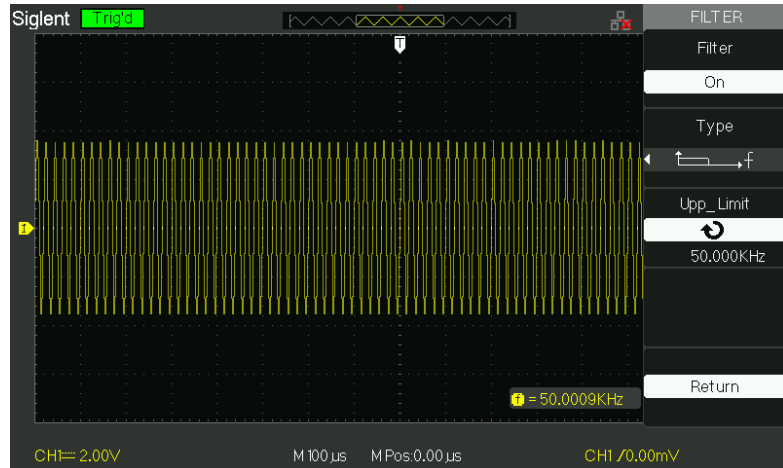

Picture 2.6-8

2.6.2 Using Vertical “Position” Knob and “Volt/div” Knob

■ Vertical “POSITION” Knob

1. Use the Vertical “POSITION” knobs to move the channel waveforms up or down on the screen. This button’s resolution is variety as per the vertical scale.
2. When you adjust the vertical position of channels waveforms, the vertical position information will display on the left bottom of screen. For example “Volts Pos=24.6mV”.
3. Press the vertical “POSITION” knob to set the vertical position to zero.

■ “Volts/div” Knob

1. Use the “Volts/div” knobs to control how the oscilloscope amplifies or attenuates the source signal of channel waveforms. When you turn the “volts/div” knob, the oscilloscope increases or decreases the vertical size of the waveform on the screen with respect to the ground level;
2. When you press the “Volt/div” Knob, you can switch “Volt/div” option between “Coarse”

and “Fine”. The vertical scale is made sure by the 1-2-5 step in the Coarse. Increase in the clockwise, reduce in the anticlockwise. In the fine mode, the knob changes the Volts/Div scale in small steps between the coarse settings. Increase in the clockwise, reduce in the anticlockwise.

2.6.3 Math Functions

Math shows the results after +, -, *, / and FFT operations of the CH1 and CH2. Press the **MATH** button to display the waveform math operations. Press the MATH button again to remove the math waveform display.

Table 2-6 MATH function menu:



Function	Setting	Introduction
Operation	+ - * / FFT	Math operates between signal source CH1 and CH2.
Invert	on off	Invert the MATH waveform. Turn off MATH Invert function.
		Adjust the vertical position of the math waveform by using universal knob.
		Adjust the range of the math waveform by using universal knob.

Table 2-7 MATH function instruction

Operation	Setting	Introduction
+	CH1+CH2	CH1 waveform adds CH2 waveform.
-	CH1-CH2	The channel 2 waveform is subtracted from the channel 1 waveform.
	CH2-CH1	The channel 1 waveform is subtracted from the channel 2 waveform.
*	CH1*CH2	Channel 1 multiply Channel 2.
/	CH1/CH2	Channel 1 divides Channel 2.
	CH2/CH1	Channel 2 divides Channel 1.
FFT	Fast Fourier Transform.	

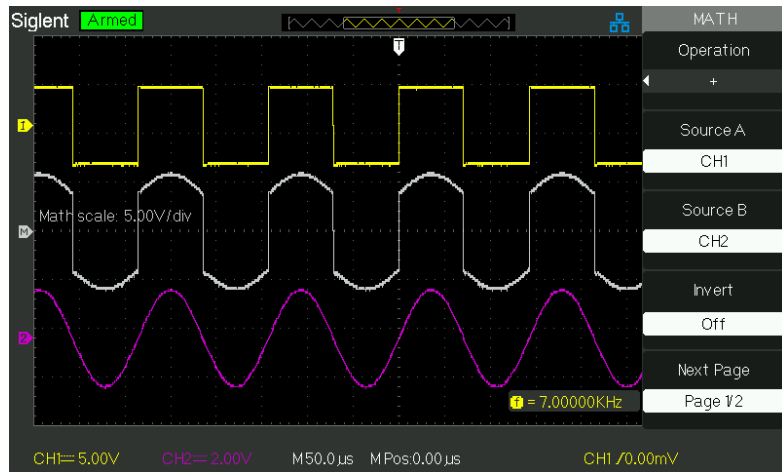

Picture 2.6-9 Math Waveform

1. FFT Spectrum Analyzer

The FFT process mathematically converts a time-domain signal into its frequency components. You can use the Math FFT mode to view the following types of signals:

- Analyze the Humorous wave in the Power cable.
- Test the Humorous content and distortion in the system
- Show the Noise in the DC Power supply
- Test the filter and pulse response in the system
- Analyze vibration

Table 2-8 FFT function menu 1:

FFT Option	Setting	Introduction
Source	CH1, CH2	Select this channel as the FFT source.
Window	Hanning Hamming Rectangular Blackman	Select FFT window types.

FFT ZOOM	1X 2X 5X 10X	Changes the horizontal magnification of the FFT display.
Next Page	Page 1/2	Enter the second page of FFT menu.

Table 2-9 FFT function menu 2:

FFT Option	Setting	Introduction
Scale	Vrms	Set Vrms to be the Vertical Scale unit.
	dBVrms	Set dBVrms to be the vertical Scale unit.
Display	Split	Display FFT waveform on half screen.
	Full screen	Display FFT waveform on full screen.
Next Page	Page 2/2	Return the first page of FFT menu.

To use the Math FFT mode, you need to perform the following tasks:

1. Set up the source (time-domain) waveform.
 - Press the AUTO button to display a YT waveform.
 - Turn the vertical “POSITION” knob to move the YT waveform to the center vertically (zero divisions).
 - Turn the horizontal “POSITION” knob to position the part of the YT waveform that you want to analyze in the center eight divisions of the screen.

The oscilloscope calculates the FFT spectrum using the center 1024 points of the time-domain waveform.

- Turn the “Volts/div” knob to ensure that the entire waveform remains on the screen.
- Turn the “S/div” knob to provide the resolution you want in the FFT spectrum.
- If possible, set the oscilloscope to display many signal cycles.

To display FFT correctly, follow these steps:

1. Push the “MATH” button.
2. Set the “Operation” option to FFT.
3. Press “Source” button to select “CH1” or “CH2” according to input signal channel.
4. According to Nyquist law, turn the “S/div” knob to adjust the sampling rate (This parameter is displayed behind the time base parameter) is at least double than input signal frequency.

2. Displaying the FFT Spectrum

Press the **MATH** button to display the Math Menu. Use the options to select the Source channel, Window algorithm, and FFT Zoom factor. You can display only one FFT spectrum at a time. You can select “Full screen” or “Split” in “Display” option to display FFT waveform on full screen or display channel waveform and its FFT waveform on half screen at a time.

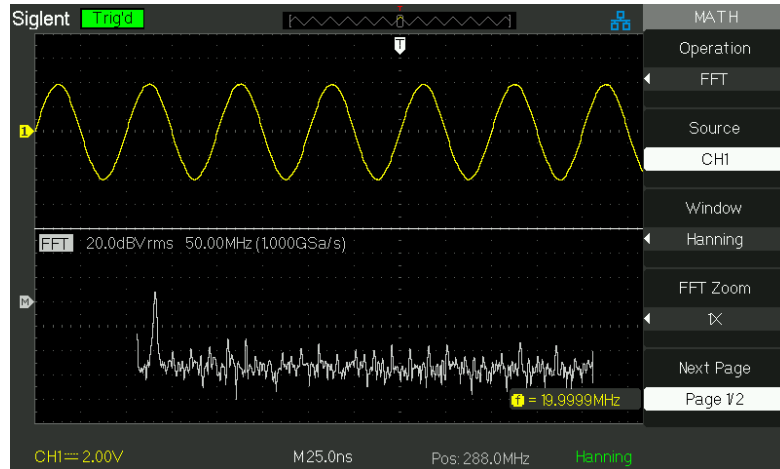

Picture2.6-10 FFT function

3. Select FFT window

Windows reduce spectral leakage in the FFT spectrum. The FFT assumes that the YT waveform repeats forever. With an integral number of cycles, the YT waveform starts and ends at the same amplitude and there are no discontinuities in the signal shape. A non-integral number of cycles in the YT waveform causes the signal start and end points to be at different amplitudes. The transitions between the start and end points cause discontinuities in the signal that introduce high-frequency transients.

According to the tested options and source speciality, make sure the window you need to use.

Table 2-10 FFT window instruction

Window	Speciality	Satisfied Test content
Rectangulr	Best frequency resolution, worst magnitude resolution. This is essentially the	Symmetric transients or bursts. Equal-amplitude sine waves with fixed frequencies. Broadband random noise with

	same as no window.	a relatively slowly varying spectrum.
Hanning Hamming	Better frequency, poorer magnitude accuracy than Rectangular. Hamming has slightly better frequency resolution than Hanning.	Sine, periodic, and narrow-band random noise. Asymmetric transients or bursts.
Blackman	Best magnitude, worst frequency resolution.	Single frequency waveforms, to find higher order harmonics.

4. Magnifying and Positioning an FFT Spectrum

You can magnify and use cursors to take measurements on the FFT spectrum. The oscilloscope includes an “FFT Zoom” option to magnify horizontally, press this option button to select “1X”, “2X”, “5X” or “10X”. Moreover, you also can turn the “Universal” knob to magnify FFT waveform horizontally in a 1-2-5 step. To magnify vertically; you can turn the “Volts/div” knob.

5. Measuring an FFT Spectrum Using Cursors

You can take two measurements on FFT spectrums: magnitude (in dB) and frequency (in Hz). Magnitude is referenced to 0 dB, where 0 dB equals 1 VRMS. You can use the cursors to take measurements at any zoom factor. (Refer to cursor measure2.11.2) Use horizontal cursors to measure amplitude and vertical cursors to measure frequency.

If you input a sine signal to channel 1, follow these steps:

- 1. Measure FFT Amplitude**
 - 1) Input a sine signal to channel 1, and press the “AUTO” button.

- 2) Press the “MATH” button to enter the “MATH” menu.
- 3) Press the “Operation” option button to select “FFT”.
- 4) Press the “Source” option button to select “CH1”.
- 5) Press CH1 button to display CH1 menu.
- 6) Turn the “S/div” knob to adjust sampling rate (at least double bigger than frequency of input signal).
- 7) If FFT display on full screen, press CH1 button again to remove channel waveform display.
- 8) Press the “CURSOR” button to enter “Cursor” menu.
- 9) Press the “Cursor Mode” button to select “Manual”.
- 10) Press the “Type” option button to select “Voltage”.
- 11) Press the “Source” option button to select “MATH”.
- 12) Press the “CurA” option button; turn the “Universal” knob to move Cursor A to the highest point of the FFT waveform.
- 13) Press the “CurB” option button, turn the “Universal” knob to move Cursor B to the lowest point of the FFT waveform.
- 14) The amplitude (ΔT) displays on the top of the left screen.

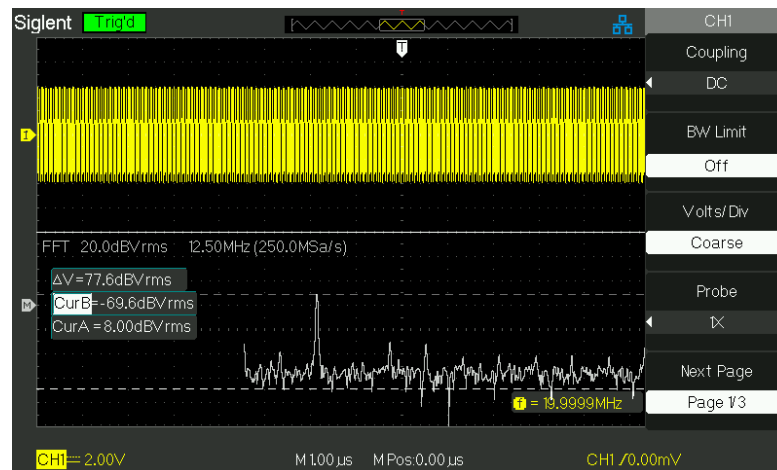

Picture 2.6-11

2. Measure FFT Frequency

- 1) Press the CURSOR button.
- 2) Press the “Cursor Mode” button to select “Manual”.
- 3) Press the “Type” option button to select “Time”.
- 4) Press the “Source” option button to select “MATH”.
- 5) Press the “CurA” option button, turn the “Universal” button to move Cursor A to the highest position of the FFT waveform.
- 6) The value of CurA displaying on the top of the left screen is FFT highs frequency. This frequency should be the same as input signal frequency.

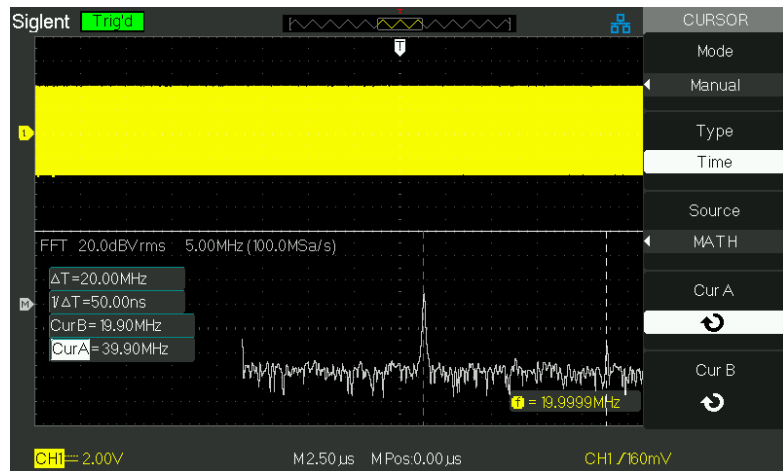

Picture 2.6-12

2.6.4 Using Ref

The reference control saves waveforms to a nonvolatile waveform memory. The reference function becomes available after a waveform has been saved.

Table 2-11 REF function menu

Option	Setting	Introduction
Source	CH1,CH2, CH1 off CH2 off	Choose the waveform display to store.
REFA REFB		Choose the reference location to store or recall a waveform.
Save		Stores source waveform to the chosen reference location.

REFA	on	Recall the reference waveform on the screen.
REFB	off	Turn off the reference waveform.

Press the Ref button to display the “Reference waveform menu”.

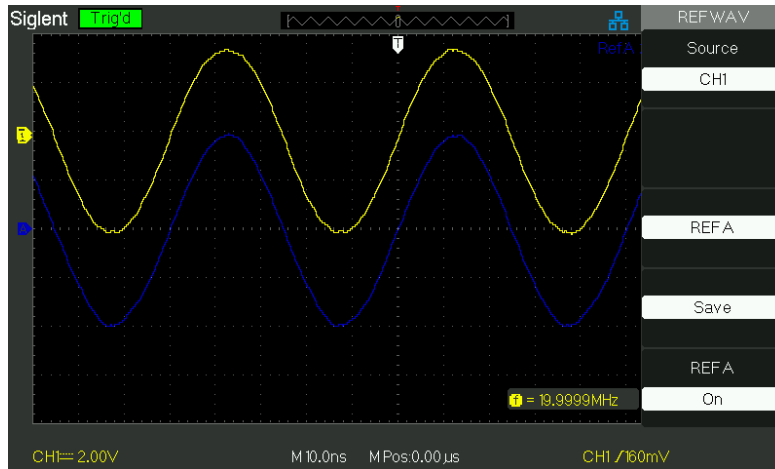

Picture 2.6-13

Operation step

1. Press the “REF” menu button to display the “Reference waveform menu”.
2. Press the “Source” option button to select input signal channel.
3. Turn the vertical “POSITION” knob and “Volt/div” knob to adjust the vertical position and scale to conformable positions.
4. Press the third option button to select “REFA” or “REFB” as storage position.
5. Press the “Save” option button.
6. Press the bottom option button to select “REFA On” or “REFB On” to recall the reference waveform.

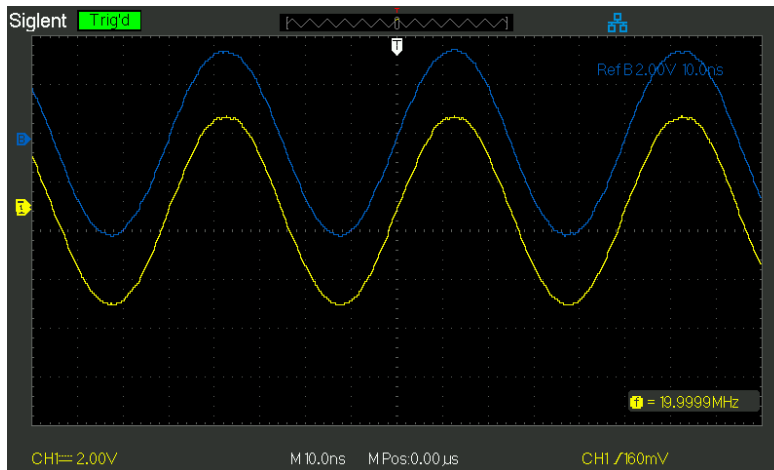

Picture 2.6-14

2.7 Horizontal System

As follow Picture, there are one button and two knobs in the HORIZONTAL area.

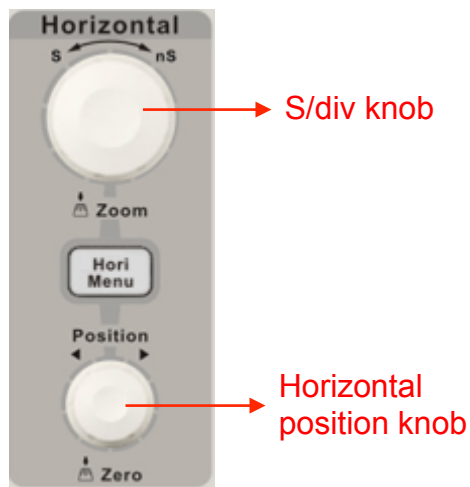

Picture 2.7-1

Table 2- 12 SDS1000CML Horizontal system function menu:

Option	Setting	Description
Delayed	On	Turn on this function that main timebase waveform display on the top half screen and window timebase waveform display on the below half screen at the same time.
	Off	Turn off this function that only display main

		timebase waveform on the screen.
MemDepth	Normal Long Mem	Set memory depth to normal. Set memory depth to long Memory depth in order to get more waveform dots.

Note: If Set memory depth to normal mode, the memory depth is 40Kpts
If Set memory depth to Long Mem mode, the memory depth is 2Mpts

MemDepth Detailed Specification

Memory Depth	Channel Mode	Sampling Rate	Short Memory	Long Memory
	Single Channel	1Gsa/s	40kpts	No Support
	Single Channel	500MSa/s or lower	20kpts	2Mpts
	Double Channels	500MSa/s or lower	20kpts	1Mpts

2.7.1 Horizontal Control Knob

You can use the horizontal controls to change the horizontal scale and position of waveforms. The horizontal position readout shows the time represented by the center of the screen, using the time of the trigger as zero. Changing the horizontal scale causes the waveform to expand or contract around the screen center.

■ Horizontal “POSITION” Knob

1. Adjust the horizontal position of all channels and math waveforms (the position of the trigger relative to the center of the screen). The resolution of this control varies with the time base setting.
2. When you press the horizontal “POSITION” Knob, you can set the horizontal position to zero.

■ “S/div” Knob

1. Using to change the horizontal time scale to magnify or compress the waveform. If waveform acquisition is stopped (using the RUN/STOP or SINGLE button), turn the S/div knob to expand or compress the waveform.

2. Select the horizontal time/div (scale factor) for the main or the window time base. When Window Zone is enabled, it changes the width of the window zone by changing the window time base.

■ Display Scan Mode

When the SEC/DIV control is set to 100 ms/div or slower and the trigger mode is set to Auto, the oscilloscope enters the scan acquisition mode. In this mode, the waveform display updates from left to right. There is no trigger or horizontal position control of waveforms during scan mode.

2.7.2 Window Zone

Use the Delayed option to define a segment of a waveform to see more detail. The Window time base setting cannot be set slower than the Main time base setting. You can turn the Horizontal Position and SEC/DIV controls to enlarge or diminish waveforms in the Window Zone.

“M” Mean main time base, “W” mean window time base.. It is also a arrow on the scale top to show the vertical position.

If you want to see a section of the waveform in detail, follow these steps:

- (1) Press the “HORI MENU” button to enter the “Horizontal menu”.
- (2) Turn the “S/div” knob to change the main timebase scale.
- (3) Press the “Delayed” option button to select “On”.

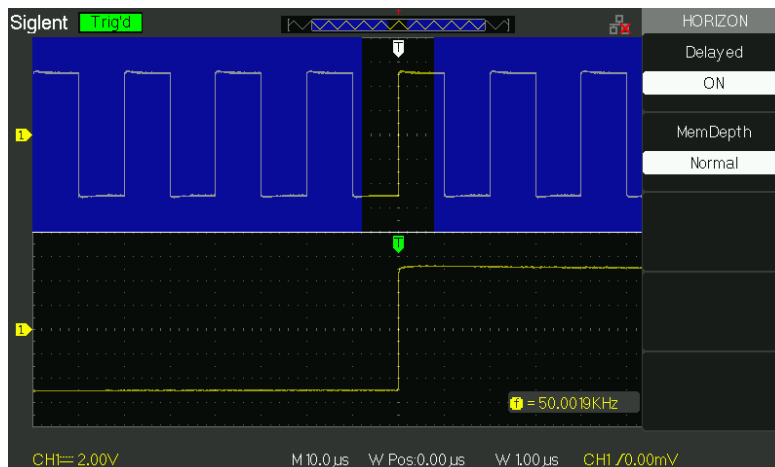

Picture2.7-2

- (4) Turn the “Horizontal Position” knob (adjust window’s position) to select the window that you need and expanded window waveform display on the below half screen at the same time.

2.8 Trigger System

The trigger determines when the oscilloscope starts to acquire data and display a waveform. When a trigger is set up properly, the oscilloscope converts unstable displays or blank screens into meaningful waveforms.

There are three buttons and one knob in the Trigger area. See picture.2-29:



Picture 2.8-1

- **“TRIG MENU” Button:** Press the “TRIG MENU” button to display “Trigger Menu”.
- **“LEVEL” Knob:** The LEVEL knob is to set the corresponding signal voltage of trigger point in order to sample. Press the “LEVEL” knob can set trigger level to zero.
- **“SET TO 50%” Button:** Use the “SET TO 50%” button to stabilize a waveform quickly. The oscilloscope can set the Trigger Level to be about halfway between the minimum and maximum voltage levels automatically. This is useful when you connect a signal to the EXT TRIG BNC and set the trigger source to Ext or Ext/5.
- **“FORCE” Button:** Use the FORCE button to complete the current waveform acquisition whether the oscilloscope detects a trigger or not. This is useful for SINGLE acquisitions and Normal trigger mode.

■ **Pre-trigger/Delayed trigger:** The data before and after trigger the trigger position is typically set at the horizontal center of the screen, in the full-screen display the 6div data of pre-trigger and delayed trigger can be surveyed. More data of pre-trigger and 1s delayed trigger can be surveyed by adjusting the horizontal position.

The feature is very useful because you can see the events that led up the trigger point everything to the right of the trigger point is called posttrigger information the amount of delay range (pre-trigger and posttrigger information) available is dependent on the sweep speed selected.

2.8.1 Signal Source

You can use the Trigger Source options to select the signal that the oscilloscope uses as a trigger. The source can be any signal connected to a channel BNC, to the EXT TRIG BNC or the AC power line (available only with Edge triggers).

2.8.2 Trigger Type

The scopes have five trigger types: Edge, Video, Pulse, Slope, and Alternative

□ Edge Trigger

Use Edge triggering to trigger on the edge of the oscilloscope input signal at the trigger threshold.

Table 2-13 Edge Trigger function Menu:

Option	Setting	Explain
Type	Edge	With Edge highlighted, the rising or falling edge of the input signal is used for the trigger.
Source	CH1 CH2	Triggers on a channel whether or not the waveform is displayed.





	EXT	Does not display the trigger signal; the Ext option uses the signal connected to the EXT TRIG front-panel BNC and allows a trigger level range of -1.2V to +1.2V.
	EXT/5	Same as Ext option, but attenuates the signal by a factor of five, and allows a trigger level range of +6V to -6V. This extends the trigger level range.
	AC Line	This selection uses a signal derived from the power line as the trigger source; trigger coupling is set to DC and the trigger level to 0 volts.
Slope	  	<p>Trigger on Rising edge of the trigger signal.</p> <p>Trigger on Falling edge of the trigger signal.</p> <p>Trigger on Rising edge and Falling edge of the trigger signal.</p>
Mode	Auto	Use this mode to let the acquisition free-run in the absence of a valid trigger; This mode allows an untriggered, scanning waveform at 100 ms/div or slower time base settings.
	Normal	Use this mode when you want to see only valid triggered waveforms; when you use this mode, the oscilloscope does not display a waveform until after the first trigger.
	Single	When you want the oscilloscope to acquire a single waveform, press the “SINGLE ”button.
Set up		Enter the “Trigger Setup Menu” (See table 2-14).

Table 2-14 Trigger Setup function menu

Option	Setting	Explain
Coupling	DC	Passes all components of the signal
	AC	Blocks DC components □attenuates signals below 50 Hz.
	HF Reject	Attenuates the high-frequency components above 150 kHz.
	LF Reject	Blocks the DC component , attenuates the low-frequency components below □ kHz.
Holdoff 		Using the “universal” knob to adjust holdoff time(sec)□the holdoff value is displayed.
Holdoff Reset		Reset holdoff time to 100ns.
Return		Return the first page of “Trigger main menu”.

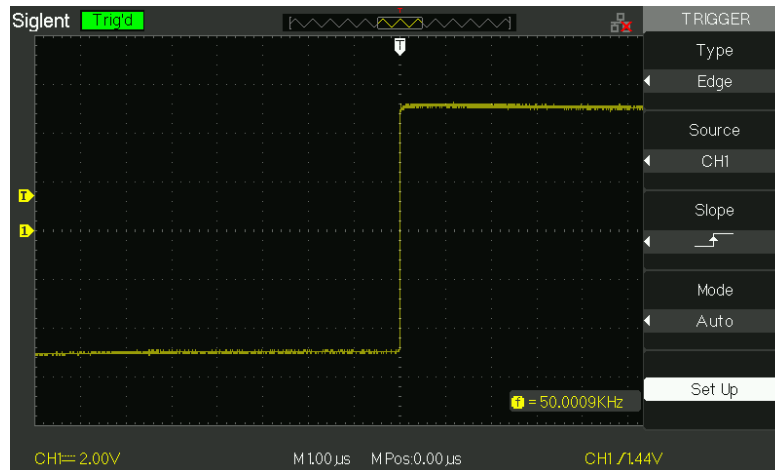

Picture2.8-2

Operate Instruction:



1. Set up Type

- 1) Press the “TRIG MENU” button to display “Trigger” menu.
- 2) Press the “Type” option button to select “Edge”.

2. Set up Source

According to input signal, press the “Source” option button to select “CH1”, “CH2”, “EXT”, “EXT/5” or “AC Line”.

3. Set up Slope

Press the “Slope” option button to select “”, “” or “.

4. Set up Trigger mode

Press the “Trigger mode” option button to select “Auto”, “Normal”, “Single”.

Auto: The waveform refresh at a high speed whether the trigger condition is satisfied or not.

Normal: The waveform refresh when the trigger condition is satisfied and waits for next trigger event occurring when the trigger condition is not satisfied.







Single: The oscilloscope acquire a waveform when the trigger condition is satisfied and then stops.

5. Set up Trigger coupling

- a. Press the “Set up” button to enter the “Trigger Setup Menu”.
- b. Press the “Coupling” option button to select “DC”, “AC”, “HF Reject” or “LF Reject”.

■ **Pulse Trigger:** Use Pulse Width triggering to trigger on aberrant pulses.

Table 2-15 Pulse Trigger function Menu 1

Option	Setting	Explain
Type	Pulse	Select the pulse to trigger the pulse match the trigger condition.
Source	CH1 CH2 EXT EXT/5	Select input signal source.
When	 (Positive pulse width less than pulse width setting)  (Positive pulse width larger than pulse width setting)  (Positive pulse width equal to pulse width setting)  (Negative pulse width less than pulse width setting)  (Negative pulse width larger than pulse width setting)  (Negative pulse width equal to pulse width setting)	Select how to compare the trigger pulse relative to the value selected in the Set Pulse Width option.
Set Width	20.0ns~10.0s	Selecting this option can turn the universal to set up the pulse width.
Next Page	Page 1/2	Press this button to enter the second page.

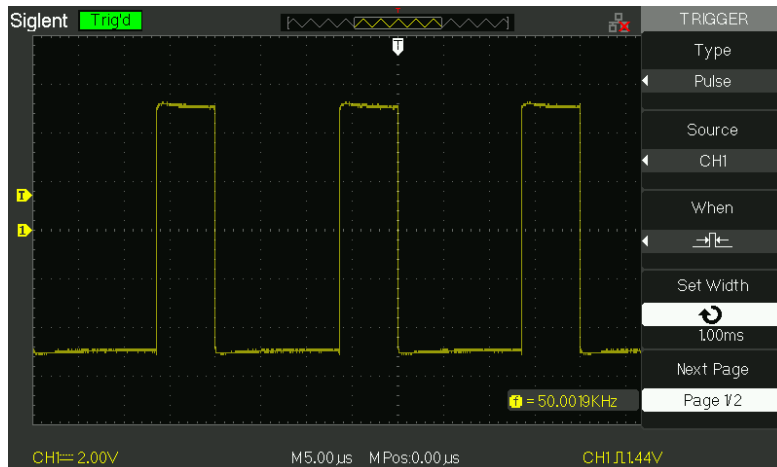

Picture 2.8-3

Table 2-16 Pulse Trigger function Menu 2

Option	Setting	Explain
Type	Pulse	Select the pulse to trigger the pulse match the trigger condition.
Mode	Auto Normal single	Select the type of triggering; Normal mode is best for most Pulse Width trigger applications.
Set up		Enter the “Trigger setup menu”.
Next Page	Page 2/2	Press this button to return the first page.

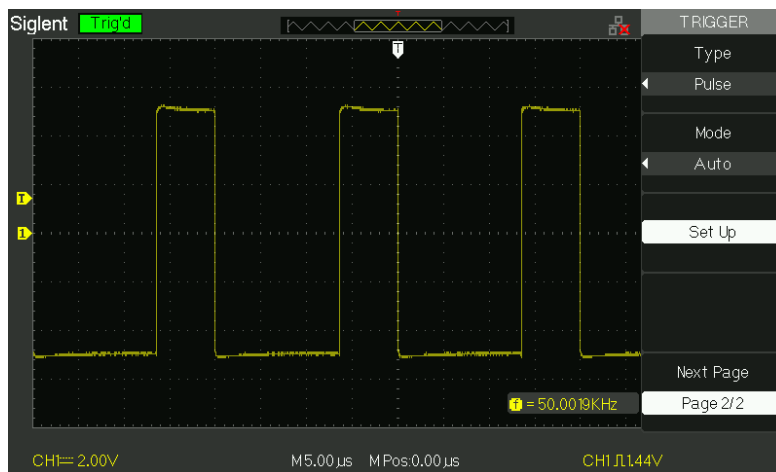





Picture 2.8-4

Operate Instruction:

1. Set up Type

- 1) Press the “TRIG MENU” button to display “Trigger menu”.
- 2) Press the “Type” option button to select “Pulse”.

2. Set up condition

Press the “When” option button to select “”, “”, “”, “” or “”

3. Set up pulse width

Turn the “Universal” knob to set up width.

- **Video Trigger** □ Trigger on fields or lines of standard video signals.

Table 2-17 Functional Menu of Video Trigger 1:



Option	Setting	Instruction
Type	Video	When you select the video type, put the couple set to the AC, then you could trigger the NTSC, PAL and SECAM video signal.
Source	CH1 CH2	Select the input source to be the trigger signal.
	EXT EXT/5	Ext and Ext/5 use the signal applied to the EXT TRIG connector as the source.
Polarity	 (Normal)	Normal triggers on the negative edge of the sync pulse.
	 (Inverted)	Inverted triggers on the positive edge of the sync pulse.
Sync	Line Num All lines Odd field Even Field	Select appropriate video sync.
Next Page	Page 1/2	Enter the second page of "Video trigger menu".

Table 2-18 Functional Menu of Video Trigger 2:

Option	Setting	Instruction
Type	Video	When you select the video type, put the couple set to the AC, then you could trigger the NTSC, PAL and SECAM video signal.
Standard	NTSC Pal/Secam	Select the video standard for sync and line number count.
Mode	Auto	Use this mode to let the acquisition free-run in the absence of a valid trigger; This mode allows an untriggered, scanning waveform at 100 ms/div or slower time base settings.

	Normal	Use this mode when you want to see only valid triggered waveforms; when you use this mode, the oscilloscope does not display a waveform until after the first trigger.
	Single	when you want the oscilloscope to acquire a single waveform, press the “SINGLE ”button.
Set up		Enter the “Trigger setup menu”.
Next Page	Page 2/2	Return the first page of “Video Trigger menu”.

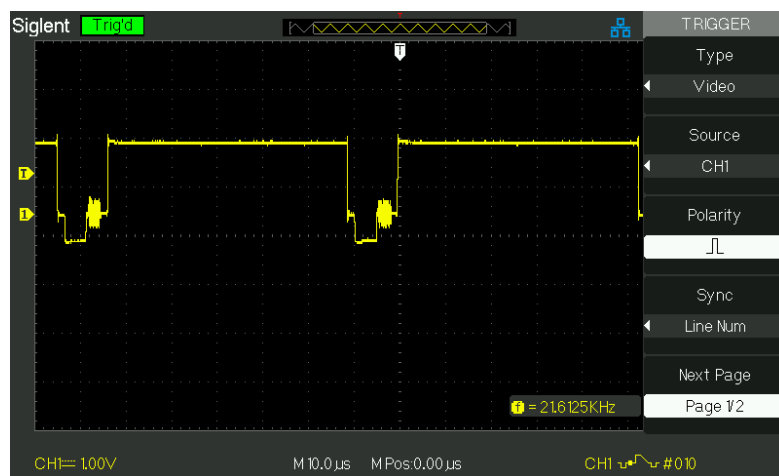

Picture 2.8-5

Operate Instruction

1. Set up Type

- 1) Press the “TRIG MENU” button to display “Trigger” menu.
- 2) Press the “Type” option button to select “Video”.

2. Set up Polarity

Press the “Polarity” option button to select “” or “”.

3. Set up synchronization



- 1) Press the “Sync” option button to select “All Lines”, “Line Num”, “Odd Field”, and “Even Field”.
- 2) If you select “Line Num”, you can turn the “Universal” knob to set the appointed line number.

4. Set up Standard

- 1) Press the “Next Page Page 2/2” option button.
- 2) Press the “Standard” option button to select “PAL/SECAM” or “NTSC”.

- Slope Trigger** Trigger on positive slope of negative slope according to setup time of the oscilloscope.

Table 2-19 Slope trigger function menu 1

Option	Setting	Instruction
Type	Slope	Trigger on positive slope of negative slope according to setup time of the oscilloscope.
Source	CH1 CH2 EXT EXT/5	Select trigger source.
When		Select trigger condition.
Time	 <input type="checkbox"/> Set time <input type="checkbox"/>	Turn the “Universal” knob to set slope time. Time setup range is 20ns-10s.
Next Page	Page 1/2	Enter the second page of slope trigger.

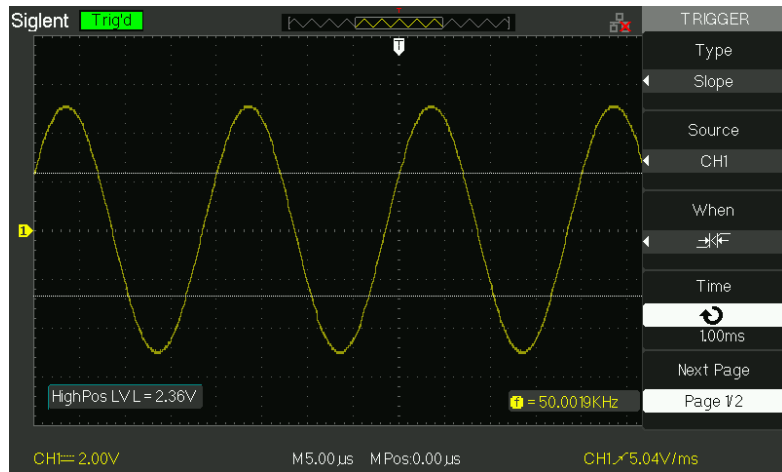

Picture 2.8-6

Table 2-20 Slope trigger function menu 2



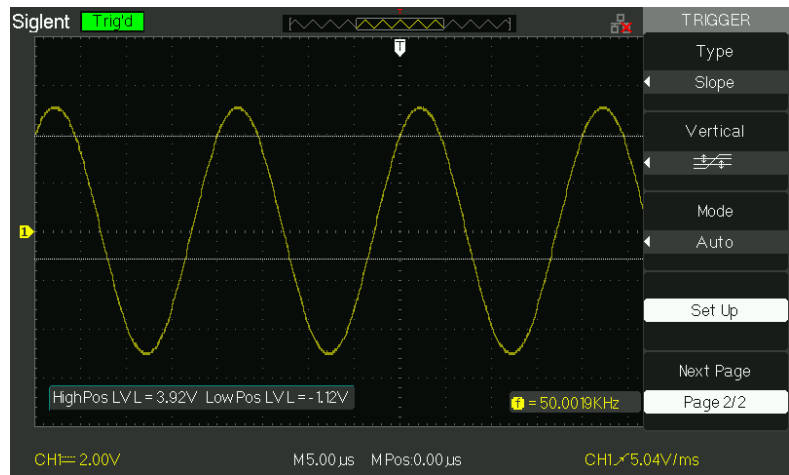



Option	Setting	Instruction
Type	Slope	Trigger on positive slope of negative slope according to setup time of the oscilloscope.
Vertical		Select the trigger level that can be adjusted by "LEVEL" knob. You can adjust "LEVEL A", "LEVEL B" or adjust them at the same time.
Mode	Auto	Use this mode to let the acquisition free-run in the absence of a valid trigger; This mode allows an untriggered, scanning waveform at 100 ms/div or slower time base settings.
	Normal	Use this mode when you want to see only valid triggered waveforms; when you use this mode, the oscilloscope does not display a waveform until after the first trigger.
	Single	When you want the oscilloscope to acquire a single waveform, press the "SINGLE" button.
Set up		Enter "Trigger setup menu" (See table 2-14).



Picture 2.8-7

Operate Instruction:

Follow the next steps if you select “Slope trigger”:

1. Input a signal to CH1 or CH2.
2. Press the “AUTO” button.
3. Press the “TRIG MENU” button to enter “Trigger menu”.
4. Press the “Type” option button to select “Slope”.
5. Press the “Source” option button to select “CH1” or “CH2”.
6. Press the “When” option button to select “”, “”, “”, “”,
 ” “ ”.
7. Press the “Time” button, turn the “Universal” knob to adjust slope time.
8. Press the “Next Page Page 1/2” option button to enter the second page of “Slope trigger menu”.
9. Press the “Vertical” option button to select trigger level that can be adjusted.
10. Turn the “LEVEL” knob.

□ Alternative trigger

The trigger signal comes from two vertical channels when you use alternative trigger. In this mode, you can observe two irrelative signals at the same time. You can select different trigger types for two vertical signals, and selected types cover edge, pulse, video and slope trigger. Trigger information of two channel signals display on the bottom right of the screen.

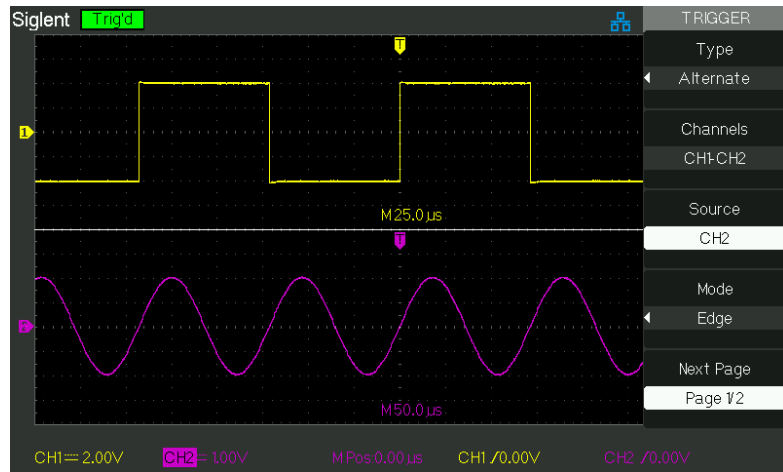

Picture 2.8-8

Table 2-21 Set trigger mode to edge trigger function menu 1:



Option	Setting	Instruction
Type	Alternative	When use alternative trigger, the trigger signal comes from two vertical channels. In the mode, you can observe two irrelative signals at a time.
Channels	CH1-CH2	Set the trigger channels
Source	CH1 CH2	Set trigger type information for CH1 signal Set trigger type information for CH2 signal
Mode	Edge	Set trigger type of vertical channel signal to edge
Slope	  	Triggering on rising edge. Triggering on falling edge. Triggering on rising edge and falling edge.
Set up		Enter "Trigger setup menu" (See table 2-14).

Table 2-22 Set trigger mode to pulse trigger function menu 1:

Option	Setting	Instruction
Type	Alternative	The trigger signal comes from two vertical channels when you use alternative trigger. In this mode, you can observe two irrelative signals at the same time.
Source	CH1 CH2	Set trigger type information for CH1 signal Set trigger type information for CH2 signal
Mode	Pulse	Set trigger type of the vertical channel signal to Pulse trigger.
When		Select how to compare the trigger pulse relative to the value selected in the Set Pulse Width option.
Next Page	Page 1/2	Enter the second page of Alternative trigger menu.

Table 2-23 Set trigger mode to pulse trigger function menu 2:

Option	Setting	Explain
Set Width	20.0ns <input type="checkbox"/> 10.0s	Selecting this option can turn the universal to set up the pulse width.
Set up		Enter the "Trigger Setup Menu"(see table 2-14).
Next Page	Page 2/2	Press this button to return the first page.

Table 2-24 Set trigger mode to video trigger function menu1:

Option	Setting	Instruction
Type	Alternative	The trigger signal comes from two vertical channels when you use alternative trigger. In this mode, you can observe two irrelative signals at the same time.
Source	CH1 CH2	Set trigger type information for CH1 signal Set trigger type information for CH2 signal
Mode	Video	Set trigger type of the vertical channel signal to Video trigger.

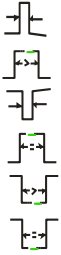

Polarity	 (Normal)  (Inverted)	Normal triggers on the negative edge of the sync pulse. Inverted triggers on the positive edge of the sync pulse.
Next Page	Page 1/2	Enter the second page of Alternative trigger menu.

Table 2-25 Set trigger mode to video trigger function menu 2:

Option	Setting	Instruction
Sync	Line Num All lines Odd field Even Field	Select appropriate video sync.
Standard	NTSC Pal/Secam	Select the video standard for sync and line number count.
Next Page	Page 1/2	Enter the second page of Alternative trigger menu.

Table 2-26 Set trigger mode to slope trigger function menu 1



Option	Setting	Instruction
Type	Alternative	The trigger signal comes from two vertical channels when you use alternative trigger. In this mode, you can observe two irrelative signals at the same time.
Source	CH1 CH2	Set trigger type informa tion for CH1 signal Set trigger type information for CH2signal
Mode	Slope	Set trigger type of the vertical channel signal to slope trigger.
When		Select slope trigger condition.
Next Page	Page 1/2	Enter the second page of the alternative trigger.

Table 2-27 Set trigger mode to slope trigger function menu 2

Option	Setting	Instruction
Time	 <input type="checkbox"/> Set time <input type="checkbox"/>	Turn the “Universal” knob to set the slope time. Time setup range is 20ns-10s.
Vertical		Select the trigger level that can be adjusted by

		<p>“LEVEL” knob. You can adjust “LEVEL A”, “LEVEL B” or adjust them at the same time.</p>
Set up		Enter “Trigger setup menu”(see table 2-14).
Next Page	Page 2/2	Return to the first page of “Alternative trigger menu”.

Operate Instruction:

Observe two irrelative channel signals, follow these steps□

1. Input two irrelative signals to channel 1and channel 2.
2. Press the AUTO button.
3. Press the TRIG MENU button to enter “trigger menu”.
4. Press the “Type” option button to select “Alternative”.
5. Press the “Channels” option button to select “CH1-CH2”
6. Press the “Source” option button to select “CH1”.
7. Press the CH1 button and turn the “S/div” knob to optimize waveform display.
8. Press “Mode” option button to select “Edge”, “Pulse”, “Slope” or “Video”.
9. Set the trigger according to trigger edge.
10. Press the “Source” option button to select “CH2”.
11. Press the CH2 button and turn the “S/div” knob to optimize waveform display.
12. Repeat steps 8 and 9.

2.8.3 Coupling

Use the “Coupling” to make sure the signal that passes the trigger circuit. It is useful for us to gather a steady wave form.

If you use the trigger coupling, you should press the “TRIGGER” button and then select “edge”, “Pulse”, “Video” or “Slope” trigger. Then select the “coupling” option in “Set up menu”.

2.8.4 Position

The horizontal position control establishes the time between the trigger position and the screen center. You can adjust the horizontal “POSITION” knob control to view waveform data before the trigger, after the trigger, or some of each. When you change the horizontal position of a waveform, you are changing the time between the trigger and the center of the display actually. (This appears to move the waveform to the right or left on the display.)

2.8.5 Slope & Level

The Slope and Level controls help to define the trigger. The Slope option (Edge trigger type only) determines whether the oscilloscope finds the trigger point on the rising or the falling edge of a signal.

The TRIGGER LEVEL knob controls where on the edge the trigger point occurs.

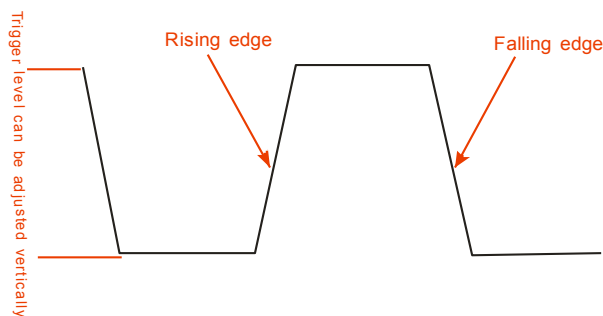

Picture 2.8-9

- Note:**
- Press the SINGLE button when you want the oscilloscope to acquire a single waveform.
 - Trigger coupling affects only the signal passed to the trigger system. It does not affect the bandwidth or coupling of the signal displayed on the screen.
 - Normal Polarity Sync triggers always occur on negative-going horizontal sync pulses. If the video waveform has positive-going horizontal sync pulses, use the Inverted Polarity selection.

2.8.6 Trigger Holdoff

You can use the Trigger Holdoff function to produce a stable display of complex waveforms. Holdoff is time between when the oscilloscope detects one trigger and when it is ready to detect another. The oscilloscope will not trigger during the holdoff time. For a pulse train, you can adjust the holdoff time so the oscilloscope triggers only on the first pulse in the train.

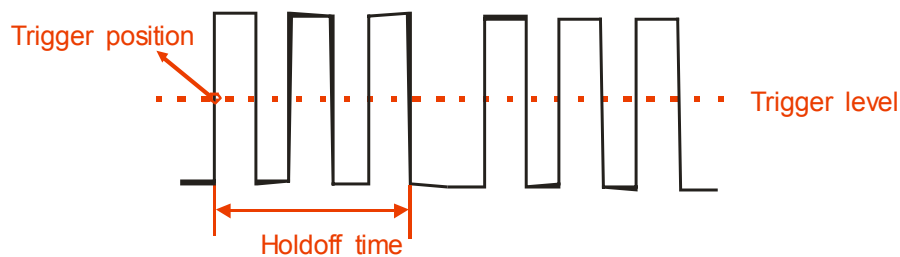

Picture 2.8-10

If you want to change holdoff time, please follow next operations:

1. Press the “TRIG MENU” button to show the “TRIG Menu”.
2. Press the “Type” option button to select trigger type.
3. Press the “Set up” option button to enter the “Trigger setup menu”.
4. Press the “Holdoff” option button □ turn the “Universal” knob to change the holdoff time until the waveform trigger steadily.

Note □ Use trigger holdoff to help stabilize the display of aperiodic waveforms.

2.9 Acquiring Signals System

Showing as the follow picture □ the “ACQUIRE” button for Acquiring Signals system is at the menu.

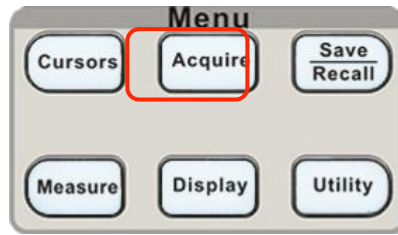

Picture 2.9-1

Table 2-28 The Function manual of Acquiring Signals:

Option	Setting	Introduction
Acquisition	Sampling	Use for sampling and accurately display most of the waveform.
	Peak Detect	Detect the noise and decrease the possibility of aliasing.
	Average	Use to reduce random or uncorrelated noise in the signal display.
	Averages □4, 16,32 ,64,128, 256□	Select number of averages.
Sinx/x	On off	Use sin interpolation Use linear interpolation
Mode	Equ time Real time	Set the Sampling mode to Equ time. Set the Sampling mode to Real time.
Sa Rate		Display system sampling rate.

When you acquire a signal, the oscilloscope converts it into a digital form and displays a waveform. The acquisition mode defines how the signal is digitized and the time base setting affects the time span and level of detail in the acquisition.

■ **Sampling:** In this acquisition mode, the oscilloscope samples the signal in evenly spaced intervals to construct the waveform. This mode accurately represents signals most of the time.

Advantage: You can use this mode to reduce random noise.

Disadvantage: This mode does not acquire rapid variations in the signal that may occur between samples. This can result in aliasing may cause narrow pulses to be missed. In these cases, you should use the Peak Detect mode to acquire data.

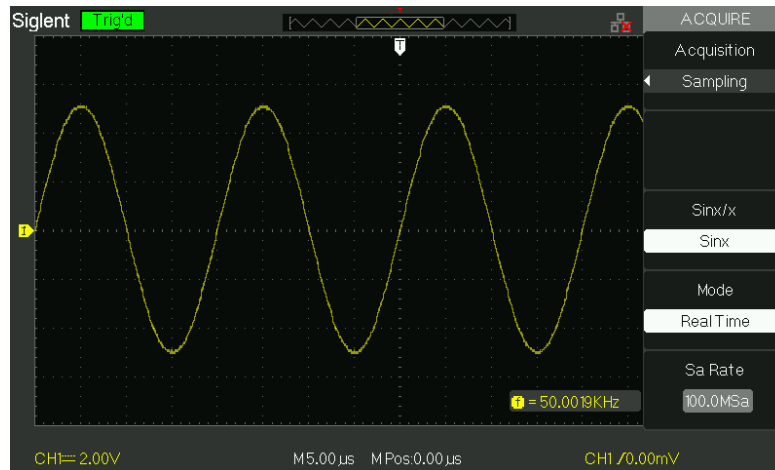

Picture 2.9-2 Sampling modes

■ **Peak Detect:** Peak Detect mode capture the maximum and minimum values of a signal Finds highest and lowest record points over many acquisitions.

Advantage: In this way, the oscilloscope can acquire and display narrow pulses, which may have otherwise been missed in Sample mode.

Disadvantage: Noise will appear to be higher in this mode.

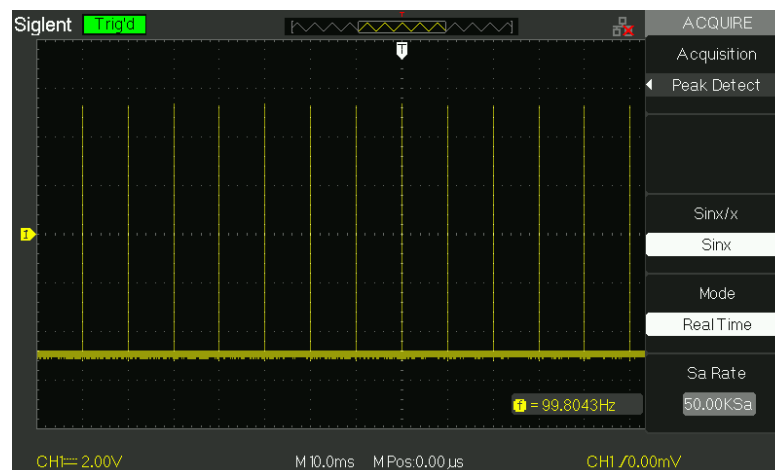

Picture 2.9-3 Peak Detect mode

■ **Average:** The oscilloscope acquires several waveforms, averages them, and

displays the resulting waveform.

Advantage: You can use this mode to reduce random noise.

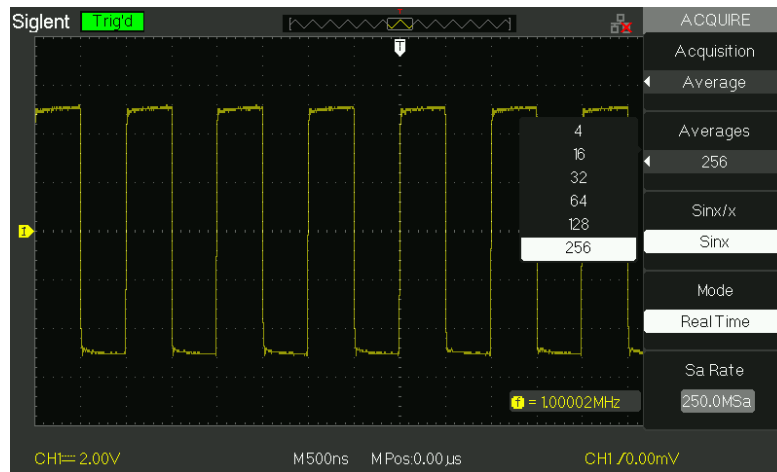

Picture 2.9-4 Average Mode

■ **Equivalent Time Sampling:**

The equivalent time sampling mode can achieve up to 20 ps of horizontal resolution (equivalent to 50GSa/s). This mode is good for observing repetitive waveforms.

■ **Real Time Sampling:** The scope has the highest Real-time sampling rate up to 1GSa/s.

■ **“RUN/STOP” Button:** Press the RUN/STOP button when you want the oscilloscope to acquire waveforms continuously. Press the button again to stop the acquisition.

■ **“SINGLE” Button:** Press the SINGLE button to acquire a single waveform. Each time you push the SINGLE button, the oscilloscope begins to acquire another waveform. After the oscilloscope detects a trigger it completes the acquisition and stops.

When you push the RUN/STOP or SINGLE buttons to start an acquisition, the oscilloscope goes through the following steps:

1. Acquire enough data to fill the portion of the waveform record to the left of the trigger point. This is also called the pre-trigger.
2. Continue to acquire data while waiting for the trigger condition to occur.
3. Detect the trigger condition.
4. Continue to acquire data until the waveform record is full.
5. Display the newly-acquired waveform.

■ **Time Base:** The oscilloscope digitizes waveforms by acquiring the value of an input signal at discrete points. The time base allows you to control how often the values are digitized.

Use S/div knob to adjust the time base to a horizontal scale suits your purpose,

■ Time Domain Aliasing

Aliasing occurs when the oscilloscope does not sample the signal fast enough to construct an accurate waveform record. When this happens, the oscilloscope displays a waveform with a frequency lower than the actual input waveform, or triggers and displays an unstable waveform.

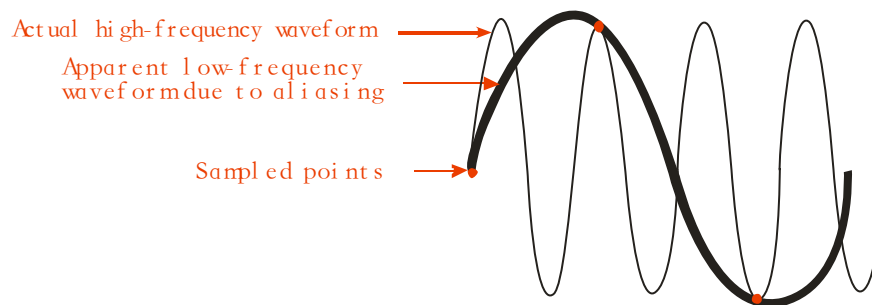

Picture 2.9-5

Operate Introduction:

Set up Sampling Format

You can press the “Acquisition” option button or turn the “Universal” knob to select “Sampling” mode, “Peak Detect” mode or “Average” mode..

Set up Averages

When you select “Average” format, you can press the “Averages” option button to select “4”, “16”, “32”, “64”, “128” or “256”.

Set up function interpolation

You can also turn Sins/x interpolation on or off. Press the corresponding option button to turn Sins/s on or off.

“Sinx” is sine interpolation

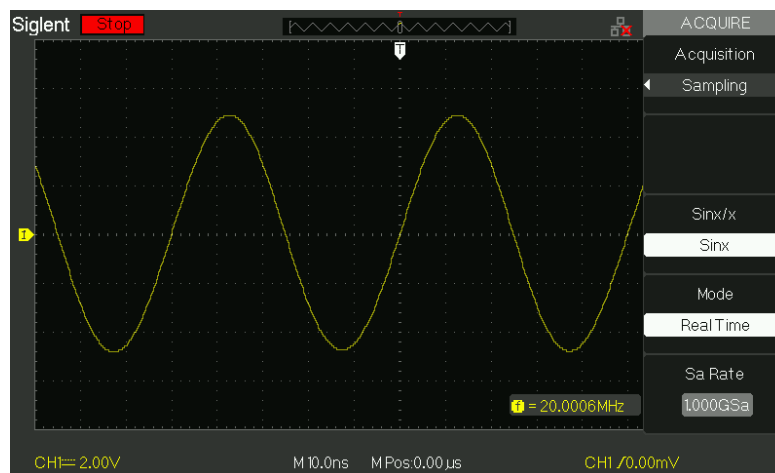

Picture 2.9-6

“X” is linear interpolation.

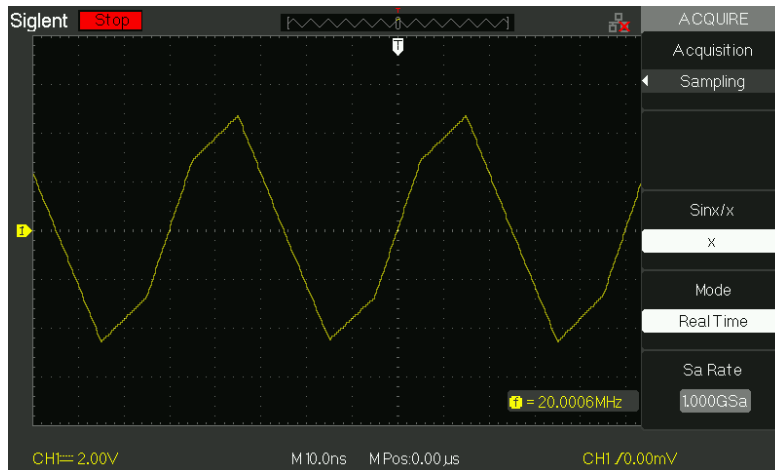

Picture 2.9-7

Set up Sampling Mode

Press the “Mode” option button to select “Real Time” or “Equ Time”.

Set up Sampling Rate

Adjust the sampling rate by pressing the “Sa Rate” option button and turning the Time/div front panel knob. The sampling rate is shown at the corresponding timebase scale.

2.10 Display System

The display function could be expressed by the “DISPLAY” Button.

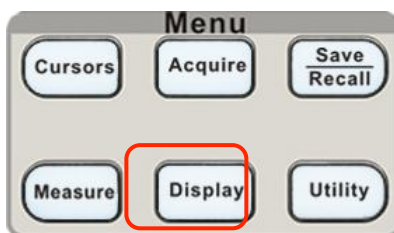

Picture 2.10-1

Table 2-29 Display system function menu 1:

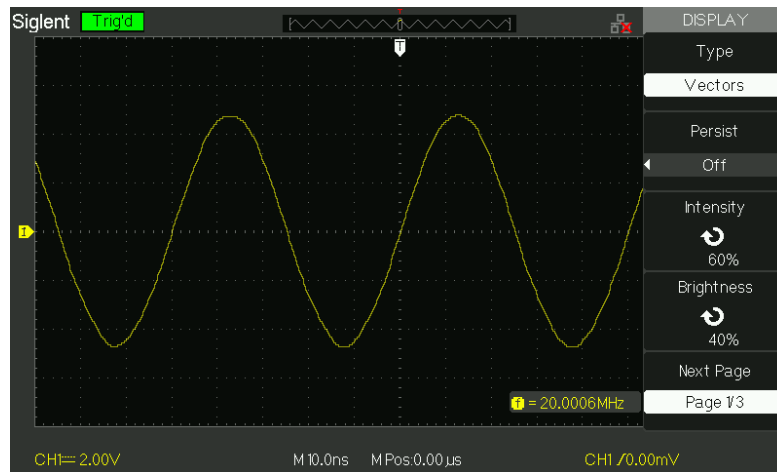

Option	Setting	Introduction
--------	---------	--------------

Type	Vectors Dots	Vectors fill the space between adjacent sample points in the display. There is no link between adjacent sample points.
Persist	Off 1 sec 2 sec 5 sec Infinite	Sets the length of time each displayed sample point remains displayed.
Intensity	↻ <Intensity>	Set waveforms' intensity.
Brightness	↻ <Brightness>	Set grid brightness.
Next Page	Page 1/3	Press this button to enter second page.



Picture 2.10-2

Table 2-30 Display system function menu 2:

Option	Setting	Introduction
Format	YT XY	YT format displays the vertical voltage in relation to time (horizontal scale). XY format displays a dot each time a sample is acquired on channel 1 and channel 2
Screen	Normal Inverted	Set to normal mode. Set to invert color display mode.
Grid	  	Display grids and axes on the screen. Turn off the grids. Turn off the grids and axes.
Menu Display	2sec	Set menu display time on screen.

	5sec 10sec 20sec Infinite	
Next Page	Page 2/3	Press this button to enter the second page of “Display menu”.

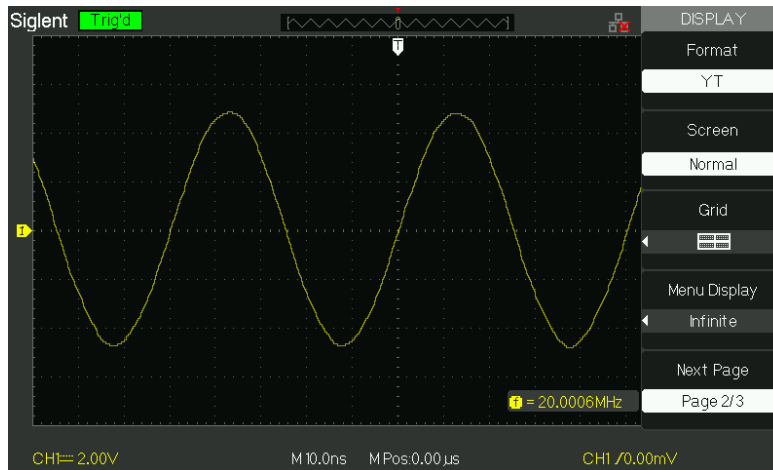

Picture 2.10-3

Table 2-31 Display system function menu3:

Option	Setting	Introduction
Skin	Classical Modern Tradition Succinct	Set up screen style.
Next Page	Page 3/3	Press this button to return the first page.

Operate Introduction:

1. Set up waveform display type

- 1) Press the “DISPLAY” button to enter the “Display” menu.
- 2) Press the “Type” option button to select “Vectors” or “Dots”.

2. Set up Persist

Press “Persist” option button to select “Off”, “1 Sec”, “2 Sec”, “5Sec” or “Infinite”.

You can use this option to observe some especial waveforms.

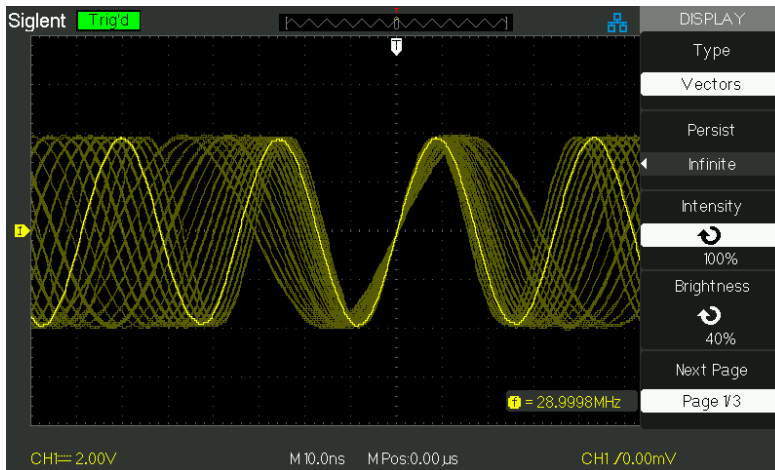

Picture 2.10-4

3. Set up Intensity

1) Press the “Intensity” option button and turn the “Universal” knob to adjust waveforms’ intensity.

4. Set up Brightness

1) Press the “Brightness” option button and turn the “Universal” knob to adjust grid brightness.

5. Set up display format

- 1) Press the “Next Page” option button to enter second display menu.
- 2) Press the “Format” option button to select “YT” or “XY”.

6. Set up Screen

Press the “Screen” option button to select “Normal” or “Inverted” to set the screen display color.

7. Set up Grid

Press the “Grid” option button to select “”, “” or “” to set the screen whether display grid or not.

8. Set up Menu Display

Press the “Menu Display” option button to select “2 sec”, “5sec”, “10sec”, “20sec” or “Infinite” to set menu display time on screen.

9. Set Skin

Press the “skin” option button or turn the “Universal” knob to select “Classical”,

“Modern”, “Traditional” or “Succinct”.

2.10.1 X-Y Format

Use the XY format to analyze phase differences, such as those represented by Lissajous patterns. The format plots the voltage on channel 1 against the voltage on channel 2, where channel 1 is the horizontal axis and channel 2 is the vertical axis. The oscilloscope uses the untriggered Sample acquisition mode and displays data as dots. XY mode has a breakthrough that traditional oscilloscopes restrict sampling rate at 1MSa/s

support 25KSa/s 250MSa/s (1-2.5-5 sequence) adjusted ;

Operation steps

- Channel 1 “Volt/div” and vertical “POSITION” set up the horizontal scale and position.
- Channel 2 “Volt/div” and vertical “POSITION” set up the horizontal scale and position.
- Turn the “S/div” knob to adjust the sampling rate
- The following functions are forbidden at XY display form:
 - Benchmark wave form and wave mathematic
 - Cursor
 - Auto resets display format to YT
 - Trigger Control
 - Horizontal Position Knob
 - Vector Display Type
 - Scan Display

2.11 Measure System

The Oscilloscope displays the voltage in relation to time and test the wave form

displayed. There are scale, Cursor and auto measure modes.

2.11.1 Scale Measurement

This method allows you to make a quick, visual estimate. For example, you might look at waveform amplitude and determine that it is a little more than 100 mV. You can take simple measurements by counting the major and minor graticule divisions involved and multiplying by the scale factor. For example, if you counted five major vertical graticule divisions between the minimum and maximum values of a waveform and knew you had a scale factor of 100mV/div, then you could easily calculate your peak-to-peak voltage as follows:

5 divisions x 100 mV/division = 500 mV.

2.11.2 Cursor Measurement

Picture 2-50 displays the cursor button on the front-panel for this menu.





Picture 2.11-1

Press the “CURSORS” button to display the “Cursor” Menu.

The cursor measurement has three modes: Manual, Track and Auto Measure.

Manual Mode

Table 2-32 Manual cursor function menu:

Option	Setting	Instruction
Cursor Mode	Manual	In this menu, set the manual cursor measure.
Type	Voltage Time	Use cursor to measure voltage parameters. Use cursor to measure time parameters.
Source	CH1 CH2 MATH REFA REFB	Select input signal channel.
Cur A 		Select this option □ use “Universal” knob to adjust cursor A.
Cur B 		Select this option □ use “Universal” knob to adjust cursor B.

In this mode, the screen displays two horizontal parallel cursors or vertical parallel cursors to measure voltage or time. You can move the cursor by turning the “Universal” knob. Before using cursors, you should make sure that you have set the signal source as the channel for measuring.

■ **Voltage Cursor:** Voltage cursors appear as horizontal lines on the display and measure the vertical parameters.

■ **Time Cursor:** Time cursors appear as vertical lines on the display and measure the horizontal parameters.

■ **Cursor Moving:** Use the “universal” knob to move cursor1 and cursor2 .They could be moved when the corresponding cursor option are selected, and cursor value will display on the bottom left and top left of the screen when you move the cursor.

To do manual cursor measurements, follow these steps:

1. Press CURSOR button to enter the cursor function menu.
2. Press the “Cursor Mode” option button to select “Manual”.
3. Press the “Type” option button to select “Voltage” or “Time”.
4. Press the “Source” option button to select “CH1”, “CH2”, “MATH”, “REFA”, “REFB” according to input signal channel.
5. Select “Cur A”, turn the “Universal” knob to adjust Cursor A.
6. Select “Cur B”, turn the “Universal” knob to adjust Cursor B.

7. The measurement values are displayed on the top of the left corner:

If the measurement type is set to “Voltage”, the values are:

The value of Cur A: CurA

The value of Cur B: Cur B

The voltage increment between Cursor A and Cursor B: ΔV

If the measurement type is set to “Time”, the values are:

The value of Cur A: CurA

The value of Cur B: Cur B

The time increment between Cursor A and Cursor B: ΔT

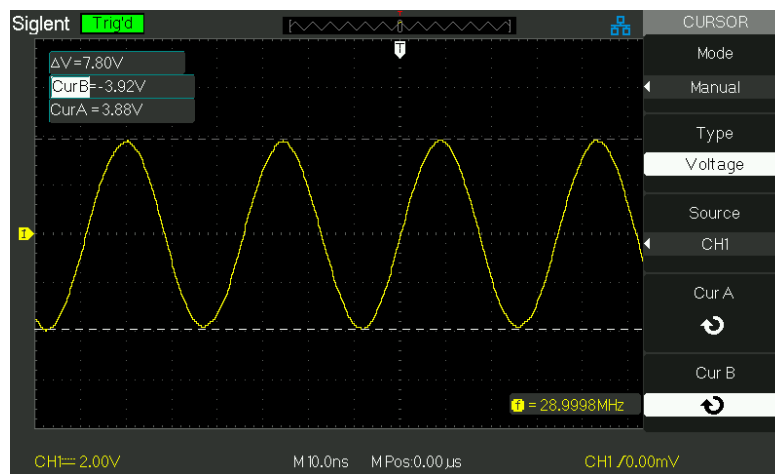

The reciprocal of time increment between Cursor A and Cursor B: $1/\Delta T$



Picture 2.11-2

Track mode

Table 2-33 Track mode function menu:

Option	Setting	Instruction
Cursor Mode	Track	In this mode, set track cursor measure.
Cursor A	CH1 CH2 NONE	Set the input signal channel that the Cursor A will measure.
Cursor B	CH1 CH2 NONE	Set the input signal channel that the Cursor B will measure.
Cur A 		Select this option, turn the “Universal” knob to adjust horizontal coordinate of Cursor A.
Cur B 		Select this option, turn the “Universal” knob to adjust horizontal coordinate of Cursor B.

In this mode, the screen displays two cross cursors. The cross cursor sets the position on the waveform automatically. You could adjust cursor’s horizontal position on the waveform by turning the “Universal” knob. The oscilloscope displays the values on the top of the right screen.

To do track cursor measurement, follow these steps:

1. Press CURSOR button to enter the cursor measure function menu.
2. Press the “Cursor Mode” option button to select “Track”.
3. Press the “Cursor A” option button to select the input signal channel.
4. Press the “Cursor B” option button to select the input signal channel.
5. Select “Cur A”, turn the “Universal” knob to move Cursor A horizontally.
6. Select “Cur B”, turn the “Universal” knob to move Cursor B horizontally.
7. The measurement values are displayed on the left of the top corner:
 - A□T: The horizontal position of Cursor A (Time cursor centered around the midpoint of screen).
 - A□V: The Vertical position of Cursor A (Voltage cursor centered around channel ground level).

- B□T: The horizontal position of Cursor B (Time cursor centered around the midpoint of screen).
- B□V: The Vertical position of Cursor B (Voltage cursor centered around channel ground level).
- T: Horizontal space between Cursor A and Cursor B (Time value between two cursors).
- 1/□T: The reciprocal of horizontal space between cursor A and cursor B.
- V: Vertical space between Cursor A and Cursor B (Voltage value between two cursors).

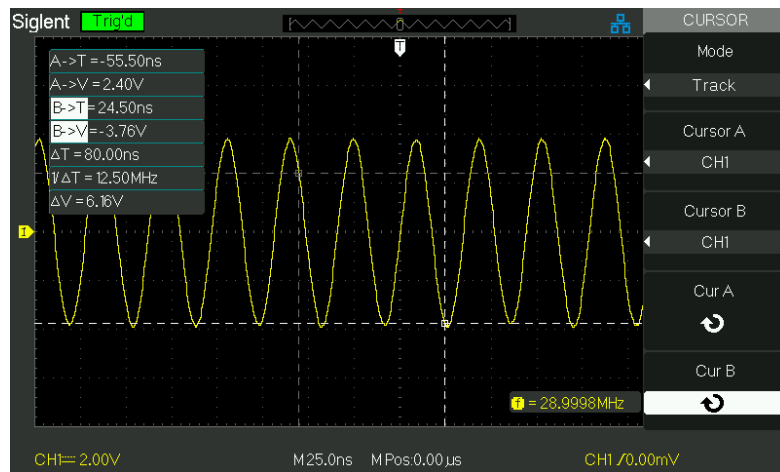

Picture 2.11-3

Auto mode

Table 2-34 Auto mode function menu:

Option	Setting	Instruction
Cursor Mode	Auto	Set to auto cursor measure mode.

This mode will take effect with automatic measurements. The instruments will display cursors while measuring parameters automatically. These cursors demonstrate the physical meanings of these measurements.

To do auto cursor measurements, follow these steps:

1. Press the CURSOR button to enter “Cursor measure menu”.
2. Press the “Cursor Mode” option button to select “Auto”.
3. Press the “MEASURE” button to enter “Auto cursor measure mode menu” to select the parameter that you want to measure.

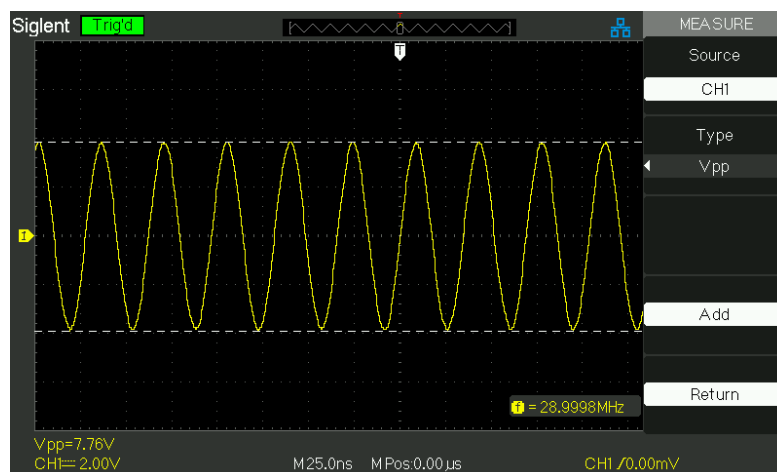

Picture 2.11-4

2.11.3 Auto Measurement

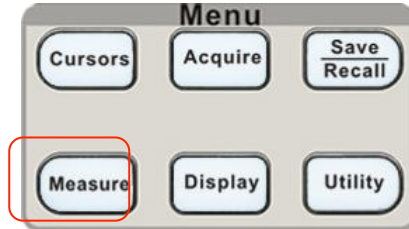

Picture 2.11-5

When you take automatic measurements, the oscilloscope does all the calculating for you. Because the measurements use the waveform record points, they are more accurate than the graticule or cursor measurements.

Press the 'MEASURE' for the Automatic Test.

There are three auto measurement types: Voltage Measure, Time Measure and Delay Measure. There are thirty two measure parameters in all.

Table 2-35 Auto measure function menu 1:

Option	Instruction
Voltage	Press this button to enter the Voltage measure menu.
Time	Press this button to enter the Time measure menu.
Delay	Press this button to enter the Delay measure menu.
All Mea	Press this button to enter the All Measurement menu.
Clear Measure	Press this button to clear all the measurement that you chose.

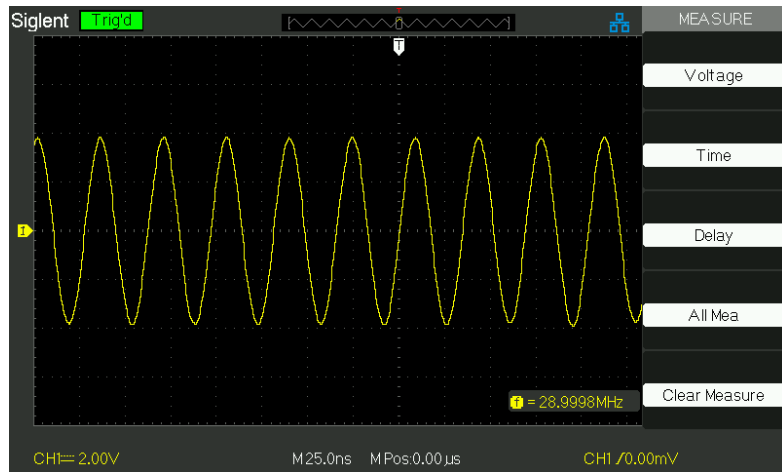

Picture 2.11-6

Table 2-36 Auto measure function 2-Voltage measure menu:

Option	Setting	Instruction
Source	CH1, CH2	Select input signal source for Voltage measure.
Type	Vmax, Vmin, Vpp, Vamp, Vtop, Vbase, Cycle Mean, Mean, Cycle Vrms, Vrms, ROVShoot, FOVShoot, RPRESshoot, FPRESshoot	Press the “Type” button or turn the “Universal” knob to select Voltage measure parameter.
Add		Choose the measurement, after pressing the button, the measurement value will be shown in the lower left of the screen
Return		Return to the first page of auto measurement menu.

Table 2-37 Auto measure function3-Time measure menu:

Option	Setting	Instruction
Source	CH1, CH2	Select input signal source for Time measure.
Type	Rise Time □ Fall Time □ Freq □ Period □ BWidth □ +Width -Width □ +Duty □ -Duty	Press the “Type” button or turn the “Universal” knob to select Time measure parameter.
Add		Choose the measurement, after pressing the button, the measurement value will be shown in the lower

		left of the screen
Return		Return to the first page of auto measurement menu.





Table 2-38 Auto measure function4-Delay measure menu:





















Option	Setting	Instruction
Source	CH1-CH2	Select any two input signal source for Delay measure.
Type	Phase <input type="checkbox"/> FRR <input type="checkbox"/> FRF <input type="checkbox"/> FFR <input type="checkbox"/> FFF <input type="checkbox"/> LRR <input type="checkbox"/> LRF <input type="checkbox"/> LFR <input type="checkbox"/> LFF	Press the “Type” button or turn the “Universal” knob to select Delay measure parameter.
Add		Choose the measurement, after pressing the button, the measurement value will be shown in the lower left of the screen
Return		Return to the first page of auto measurement menu.







Table 2-39 All Measurement function menu:

Option	Setting	Instruction
Source	CH1 CH2	Select input signal channel.
Voltage	On Off	Turn on the all measurement function to measure voltage parameters. Turn of the all measurement function to measure voltage parameters.
Time	On Off	Turn on the all measurement function to measure Time parameters. Turn of the all measurement function to measure Time parameters.
Return		Return to the “All Measure main menu”.

Table 2-40 Introduction of the Measure Type:

Measure Type	Introduction
 Vmax	The most positive peak voltage measured over the entire waveform.
 Vmin	The most negative peak voltage measured over the entire waveform.
 Vpp	Measures the absolute difference between the maximum and minimum peaks of the entire waveform.
 Vtop	Measures the highest voltage over the entire waveform.

 Vbase	Measures the lowest voltage over the entire waveform.
 Vamp	Voltage between Vhigh and Vlow of a waveform.
 Vavg	The arithmetic mean over the first cycle in the waveform.
 Mean	The arithmetic mean over the entire waveform.
 Crms	The true Root Mean Square voltage over the first cycle in the waveform.
 Vrms	The true Root Mean Square voltage over the entire waveform.
 ROVShoot	Defined as $(V_{max}-V_{high})/V_{amp}$ after the waveform rising.
 FOVShoot	Defined as $(V_{min}-V_{low})/V_{amp}$ after the waveform falling.
 RPREshoot	Defined as $(V_{min}-V_{low})/V_{amp}$ before the waveform rising.
 FPREshoot	Defined as $(V_{max}-V_{high})/V_{amp}$ before the waveform falling.
 Rise Time	Rise Time Measures the time between 10% and 90% of the first rising edge of the waveform.
 Fall Time	Fall Time Measures the time between 90% and 10% of the first falling edge of the waveform.
 BWid	The duration of a burst. Measured over the entire waveform.
 + Wid	+ Width Measures the time between the first rising edge and the next falling edge at the waveform 50% level.
 - Wid	-Width Measures the time between the first falling edge and the next rising edge at the waveform 50% level.
 + Duty	Measures the first cycle waveform. Positive Duty Cycle is the ratio between positive pulse width and period.
 - Duty	Measures the first cycle waveform. Negative Duty Cycle is the ratio between negative pulse width and period.
 Phase	The amount one waveform leads or lags another in time. Expressed in degrees, where 360 degrees comprise one waveform cycle.
 FRR	The time between the first rising edge of source X and the first rising edge of source Y.
 FRF	The time between the first rising edge of source X and the first falling edge of source Y.

 FFR	The time between the first falling edge of source X and the first rising edge of source Y.
 FFF	The time between the first falling edge of source X and the first falling edge of source Y.
 LRR	The time between the first rising edge of source 1 and the last rising edge of source 2.
 LRF	The time between the first rising edge of source X and the last falling edge of source Y.
 LFR	The time between the first falling edge of source X and the last rising edge of source Y.
 LFF	The time between the first falling edge of source X and the last falling edge of source Y.

If you want to measure voltage parameters, please follow next steps:

- 1□. Press the “MEASURE” button to enter the “Auto measurement” menu.
- 2□. Press the top first option button to enter the “second measurement menu”.
- 3□. Select measure type. If you press the “Voltage” option button, “Voltage measurement” menu will display on the screen.
- 4□. Press the “Source” option button to select “CH1”, “CH2” according to input signal channel.
- 5□. Press the “Type” option button to select the parameter type that you want to measure, then press the “add” option button to add the measurement . The corresponding icon and value will displayed in the lower left of the screen.

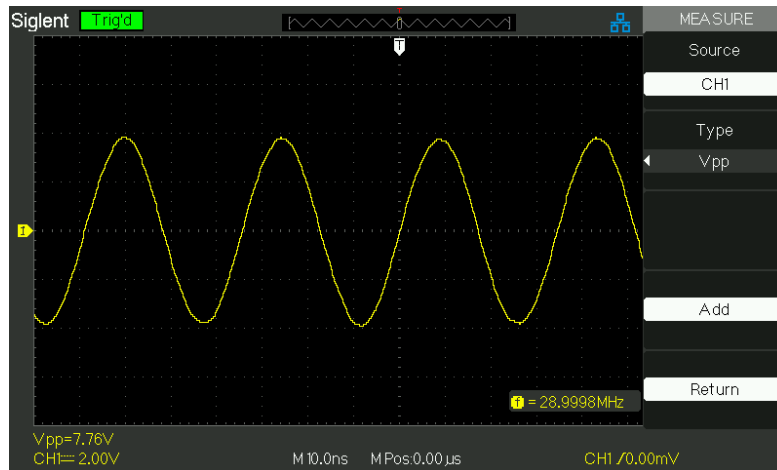

Picture 2.11-7

6□. Press the “Return” option button to return the home page of “Auto Measurement” menu. The selected parameter and the corresponding value will display on the top first position of the home page.

You can display the other parameters and its’ value on the corresponding position using the same way, and the screen can display five parameters at one time.

If you want to measure time parameters using all measure function, please follow next steps:

- 1□. Press the “MEASURE” button to enter the “Auto Measure menu”.
- 2□. Press the top option button to enter the second page of “Auto Measure menu”.
- 3□. Press “All Mea” option button to enter the “All Measure menu”.
- 4□. Press “Source” option button to select input signal channel.
- 5□. Press the “Time” option button to select “On”. Now all of time parameters value will display on the screen at the same time.□See Picture□

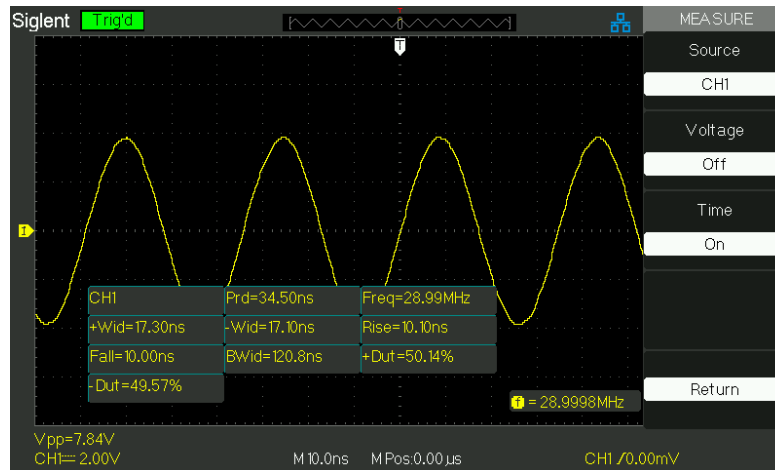

Picture 2.11-8

2.12 Storage System

Showing as following picture, The SAVE/RECALL is the Storage System Function Button.

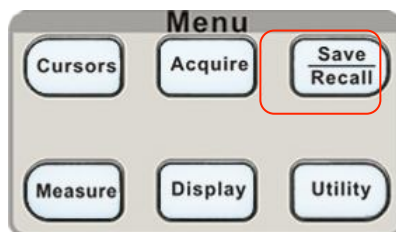

Picture 2.12-1

You can quickly save and recall up to 20 oscilloscope panel settings, 10 groups' waveforms in internal memory. There is a USB Host interface in the front panel of the oscilloscope and you can save setup data, waveform data, waveform interface image, CSV file to a USB flash drive furthest at a time. Setup data and waveform data can be recalled to the current oscilloscope or the other same model oscilloscopes. Picture data and CSV file can't be recalled to the oscilloscope, but it can be opened on the correlative computer software.

■ Using SAVE /RECALL Screen

The SAVE ALL screen is divided into functions based on Files or Directory.

Files shows option button for New File, Del File and Load.

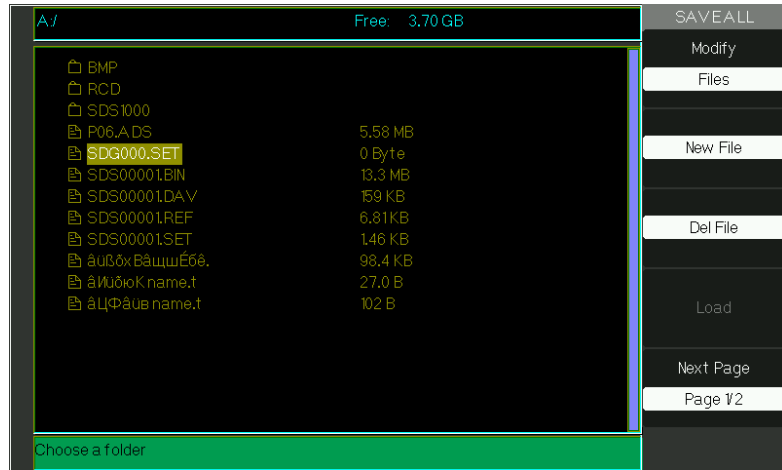

Picture 2.12-2

While Directory shows option buttons for New Dir., Del Folder.

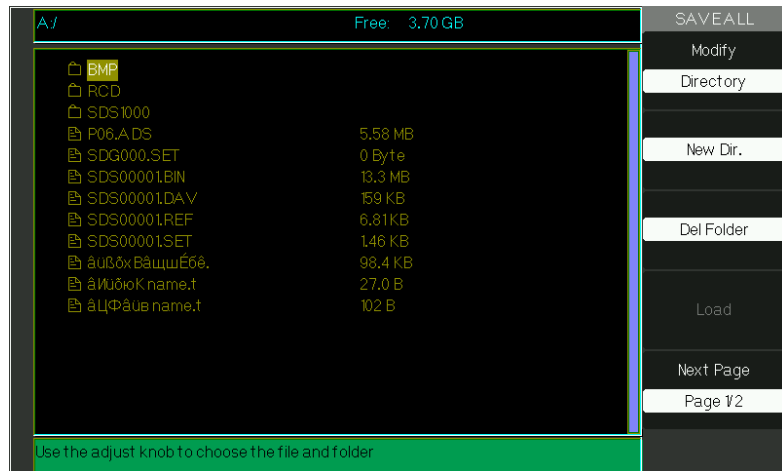

Picture 2.12-3

Recalling Files

The Load button is used to recall your setup files. Once you've navigated to the desired file and it's highlighted in the main screen area, press the Load option button and the setup is recalled from the USB flash drive.

Note: The Load button option is disabled when BMP or CSV file types are selected.

Both Directory and Files have Rename and Return option buttons on Page2/2. Use these buttons to give an existing folder of file a new name or to exit the SAVE/REC ALL screen, respectively.

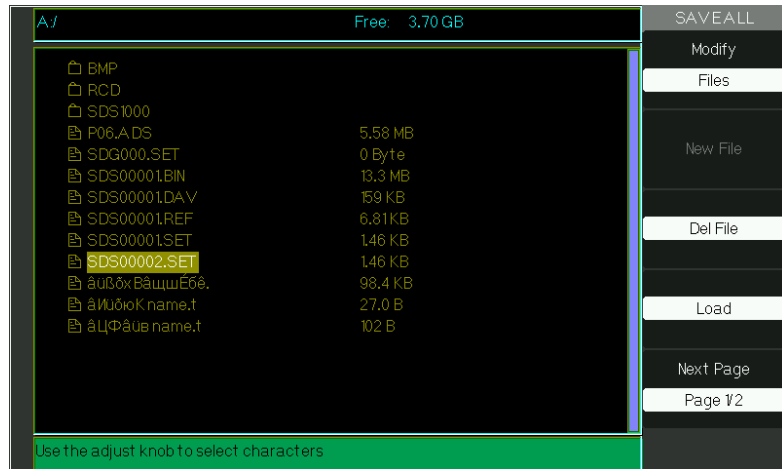

Picture 2.12-4

Creating Directory and File

Create new directory and file by pressing the New Dir or New File option button. The following screen is shown.

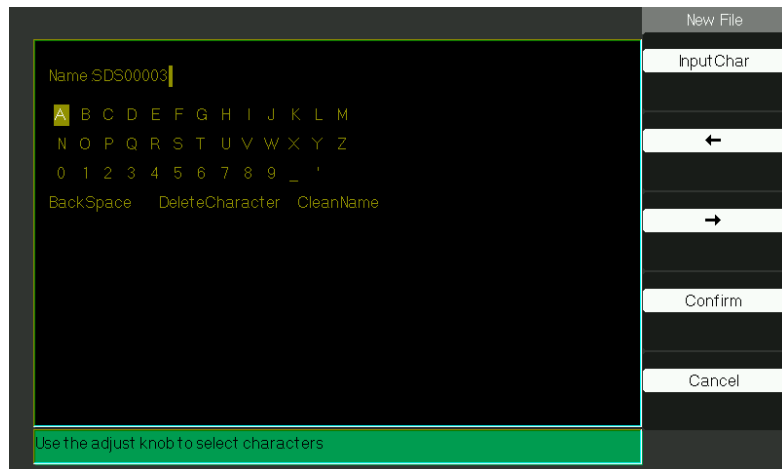

Picture 2.12-5

- The New File menu choices and behavior is the same as the New Folder menu. It just has a different heading. The InputChar option button adds the selected character to the cursor position in Name field.
- Move the cursor position in the name field using the “←” and “→” option buttons.
- Turn the Universal knob to move through character selections. When the desired character is highlighted, press the Universal knob or press the “InputChar” option button to add it to the specific position in the Name field.
- Additional selections for BackSpace, DeleteCharacter, and CleanName are available for convenience and are also accessed using the “Universal” knob in the same manner.
- Press the “Confirm” option button (when you have the Name field completed as desired) to save the file onto the memory device. After the “Confirm” option button is pressed, a “Data Store Success!” message is briefly shown and the new folder or file is shown on your USB flash drive.

SAVE/RECALL SETUP

■ **Save Setups to Device** □ The complete setup is stored in nonvolatile memory. When you recall the setup, the oscilloscope will be in the mode from which the setup was saved.

The oscilloscope saves the current setup if you wait three seconds after the last change before you power off the oscilloscope. The oscilloscope recalls this setup the next time you apply power.

Table 2-41 Save setup to device function menu:

Option	Setting	Introduction
Type	Setups	Menu for the Storage/Recall setting in the oscilloscope
Save to	Device	Save setup to the oscilloscope’s internal

		memorizer.
Setup	No.1 to No.20	Press the “Setup” option button or turn the “universal” knob to select storage position.
Save		Accomplish the storage
Recall		Recall the storage in the “Setup” operation

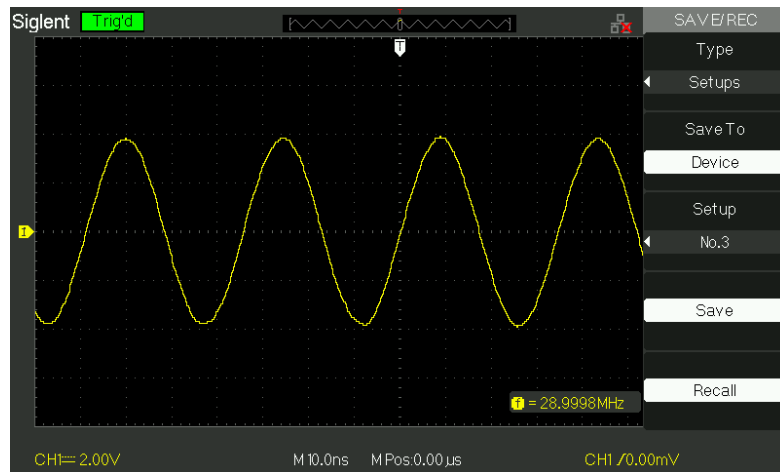

Picture 2.12-6

Save setups to the oscilloscope’s internal memorizer, follow next steps:

For example: Save setup that set waveform display type to “Dots” to internal memory.

- 1□ Press the “SAVE/RECALL” button to enter the “SAVE/RECALL” menu.
- 2□ Press the “Type” option button to select “setups”.
- 3□ Press the “Save to” option button to select “Device”.
- 4□ Press the “Setup” option button to select “No.1”.
- 5□ Press the “DISPLAY” button to enter the “Display” menu.
- 6□ Press the “Type” option button to select “Dots”.
- 7□ Press the “SAVE/RECALL” button to enter the “SAVE/RECALL” menu.
- 8□ Press the “Save” option button.

Recalling setup, follow next steps:

- 1□ Press the “SAVE/RECALL” button to enter the “SAVE/RECALL” display menu.
- 2□ Press the “Type” option button to select “Setups”.
- 3□ Press the “Save to” option button to select “Device”.
- 4□ Press the “Setup” option button or turn the “Universal” knob to select “No.1”.

5. Press the “Recall” option button.

■ Save Setup to USB flash drive

Table 2-42 Save setup to USB flash drive function menu:

Option	Setting	Introduction
Type	Setups	Menu for the Storage/Recall settings.
Save to	File	Save setup data to USB flash drive.
Save		Go to the Save/Recall interface and save the set file
Recall		Recall the saved set file

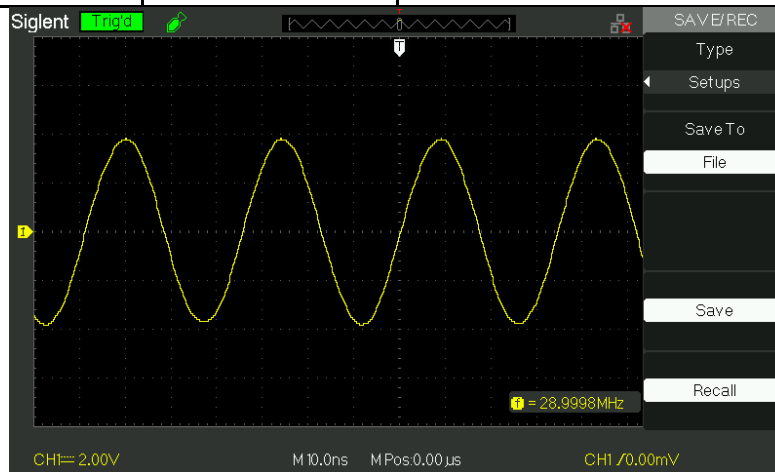

Picture 2.12-7

Save setup to USB flash drive, follow these steps

For example: Save setup that set waveform display type to “Dots” to USB flash drive. Press the “SAVE/RECALL” button to select “Setups”.

- 1) Insert USB flash drive to USB host port of the oscilloscope and wait that the oscilloscope has initialized USB flash drive (about five second).
- 2) Press the “Save to” option button to select “file”.
- 3) Press the “Save” option button then you’ll go into the Save/Recall interface.
- 4) Press the “New folder” button to create a new folder
- 5) Press the “Del folder” option button to delete a folder
- 6) Press the “Modify” option button to modify a folder.
- 7) Press the “New file” option button to create a new file
- 8) Press the “Del file” option button to delete a file

- 9) Press “the next page” option button and press the “Rename” option button to modify the name of the file or the folder.
- 10) Turn the “Universal” knob to select the folder and press the “Confirm” option button and you save the set to the USB drive.

Recall setup data from USB flash drive, follow next steps:

- 1) Press the “SAVE/RECALL” button.
- 2) Press the “Type” button to select “Setups”.
- 3) Insert USB flash drive to USB host port of the oscilloscope and wait that the oscilloscope has initialized USB flash drive (about five seconds).
- 4) Press the “Save to” option button to select “File”.
- 5) Press the “Save” option button then you’ll go into the Save/Recall interface .
- 6) Choose the file you want then press the “Load” option button (about five seconds, there is a prompting message that “Read data success”), now setup data have been recalled from USB flash drive.

■ RECALL FACTORY

You can use this option to recall the factory setup.

Table 2-43 Factory function menu:

Option	Setting	Instruction
Type	Factory	To view the Factory setup.
Update BW		Change the bandwidth of the oscilloscope.
Depth Recover		Recover the memory
Update cfg		Update the config file
Load		Recall the Factory setup.

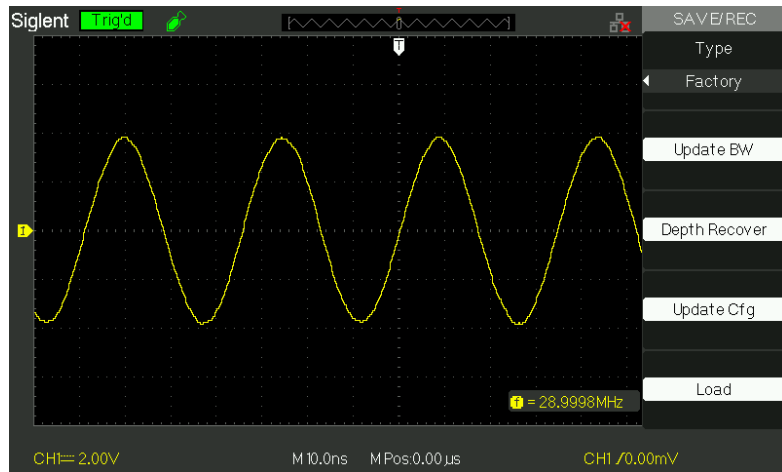

Picture 2.12-8

SAVE/RECALL WAVEFORM

■ Save waveforms to Device

Table 2-44 Save waveform to device function menu:

Option	Setup	Introduction
Type	waveforms	Menu for the Storage/Recall waveforms in the oscilloscope.
Save to	Device	Save waveforms to the oscilloscope's internal memorizer.
waveform	No.1 to No.10	Press the "waveform" option button or turn the "Universal" knob to select storage position.
Save		Accomplish the storage.
Recall		Recall the storage in the "waveform" operation

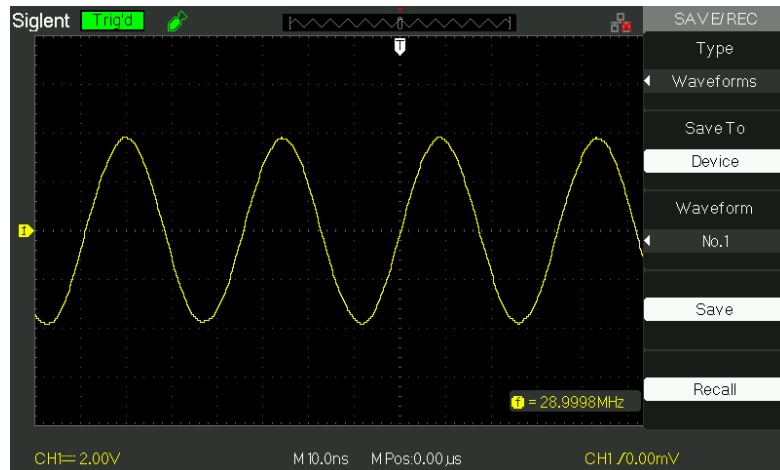

Picture 2.12-9

Save waveforms in internal memory, follow next steps:

- 1□. Input a sine signal to channel 1 and press the “Auto” button.
- 2□. Press the “SAVE/RECALL” button to enter “SAVE/RECALL” display menu.
- 3□. Press the “Type” option button to select “waveforms”.
- 4□. Press the “Save to” option button to select “Device”.
- 5□. Press the “waveform” option button or turn the “Universal” knob to select “No.1”.
- 6□. Turn the “Volts/div” knob or “S/div” knob to adjust the waveform that you want to need.
- 7□. Press the “Save” option button.

Recall waveforms, follow next steps:

- 1□. Press the “SAVE/RECALL” button to enter “SAVE/RECALL” display menu.
- 2□. Press the “Type” option button to select “waveforms”.
- 3□. Press the “Save to” option button to select “Device”.
- 4□. Press the “waveform” option button or turn the “Universal” knob to select “No.1”.
- 5□. Press the “Recall” option button.

■ Save waveforms to USB flash drive

Table 2-45 Save waveforms to USB flash drive function menu□

Option	Setup	Introduction
Type	Waveforms	Menu for the Storage/Recall waveforms.
Save to	File	Save waveforms to USB flash drive.
Save		Accomplish the storage.

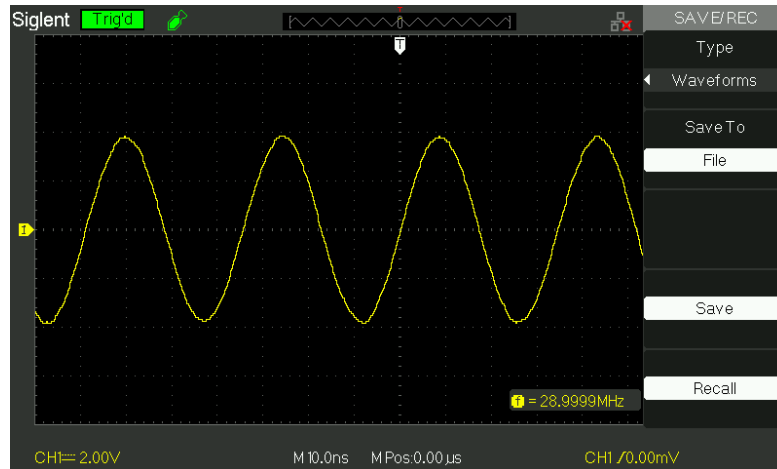

Picture 2.12-10

Save waveforms to USB flash drive, follow next steps:

- 1) Input a sine signal to channel 1, press the “AUTO” button.
- 2) Press the “SAVE/RECALL” button to enter the “SAVE/RECALL” display menu.
- 3) Press the “Type” option button to select “Waveforms”.
- 4) Insert USB flash drive to USB host port of the oscilloscope and wait that the oscilloscope has initialized USB flash drive (about five seconds).
- 5) Press the “Save to” option button to select “File”.
- 6) Press the “Save” option button then you’ll go into the Save/Recall interface.
- 7) Create a file then press the “Confirm” button (about five seconds, there is a prompting message that “Save data success” displaying on the screen), now waveform data have been saved to USB flash drive

Recall waveforms form USB flash drive, follow next steps:

- 1□. Press the “SAVE/RECALL” button.
- 2□. Press the “Type” button to select “Waveforms”.
- 3□. Insert USB flash drive to USB host port of the oscilloscope and wait that the oscilloscope has initialized USB flash drive (about five seconds).
- 4□. Press the “Save to” option button to select “File”.
- 5□. Press the “Save” option button then go into the Save/Recall interface.
- 6□. Choose the file you want then press the “Load” option button (about five seconds, there is a prompting message that “Recall data success” displaying on the screen), now waveform data have been recalled from USB flash drive.

■ Save Picture

Waveform interface image can be saved to USB flash drive, but they can't be recalled. You can open them on correlative computer software.

Table 2-46 Picture storage function menu:

Option	Setting	Introduction
Type	Pictures	Menu for the Storage/Recall waveform interface image.
Save		Go to the Save/Recall interface.

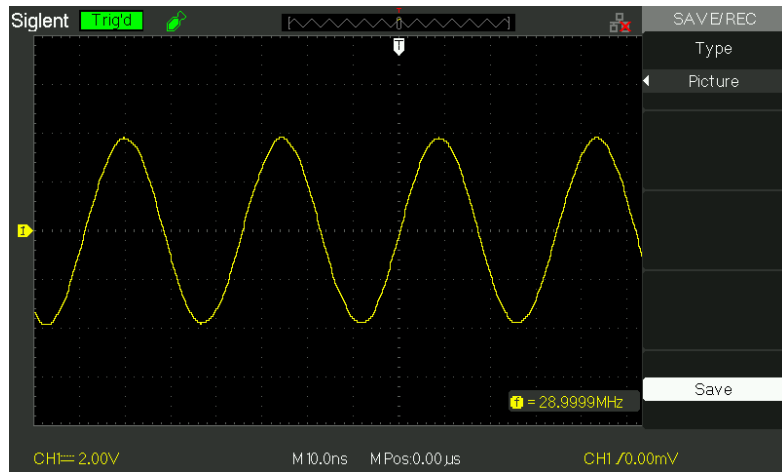

Picture 2.12-11

Save waveform image to USB flash drive, follow next steps:

- 1). Select the screen image that you want.
- 2). Press the “SAVE/RECALL” button to enter “SAVE/RECALL” menu.
- 3). Press the “Type” option button to select “Pictures”.
- 4). Insert USB flash drive to USB host port of the oscilloscope and wait that the oscilloscope has initialized USB flash drive (about five seconds).
- 5). Press the “Print Key” option button to select “Save Picture”.
- 6). Press the “Save” option button then go into the Save/Recall interface”.
- 7). Press the “Save” button then you’ll go into the Save/Recall interface
- 8). Create the picture name then press the “Confirm” button (about five seconds, there is a prompting message that “Save data success” displaying on the screen), now picture data have been saved to USB flash drive.

Save/Recall CSV

Table 2-47 CSV storage function menu:

Option	Setting	Introduction
--------	---------	--------------

Type	CSV	Menu for the Storage CSV file to USB flash drive.
Data Depth	Displayed Maximum	Set to store displayed waveform data to CSV file. Set to store maximum waveform data to CSV file.
Para Save	On Off	Set whether store parameters to CSV file or not.
Save		Go to the Save/Recall interface.

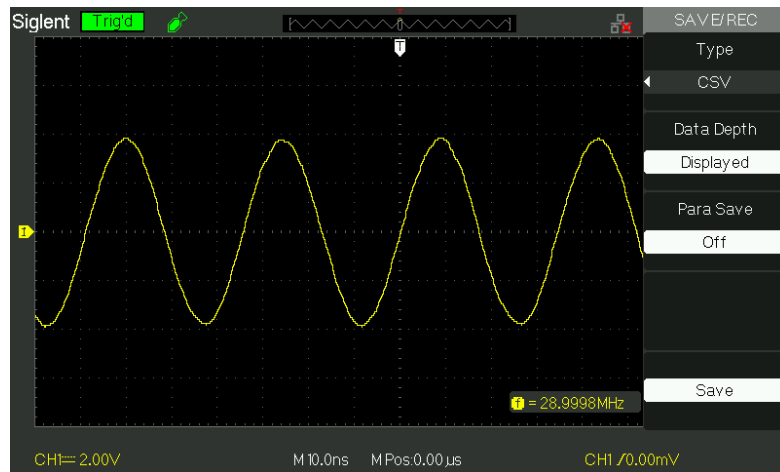

Picture 2.12-12

Save CSV file to USB flash drive, follow these steps:





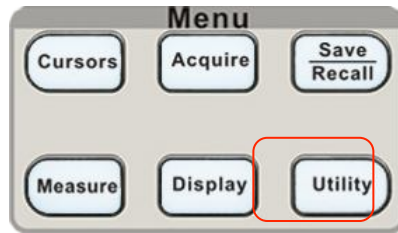

- 1). Press the “SAVE/RECALL” button to enter “SAVE/RECALL” menu.
- 2). Press the “Type” option button to select “CSV”.
- 3). Insert USB flash drive to USB host port of the oscilloscope and wait that the oscilloscope has initialized USB flash drive(about five seconds).
- 4). Press the “Data Depth” option button to select “Displayed” or “Maximum”.
- 5). Press the “Para Save” option button to select “On” or “Off”.
- 6). Press the “Save” option button then you’ll go into the Save/Recall interface
- 7). Create a file name then press the “Confirm” button (About five seconds, there is a prompting message that “Save data success” displaying on the screen), now CSV file has been saved to USB flash drive.

2.13 Utility System



Picture 2.13-1

Table 2-48 Utility System function menu 1:

Option	Setting	Introduction
System Status		Displays summaries of the oscilloscope settings.
Sound	 	Open the key-press voice. Close the key-press voice.
Counter	On Off	Turn on Frequency Counter Turn off Frequency Counter.
Language	  English العربية Français Deutsch Русский Español Português   Italian	Simplified Chinese Traditional Chinese English Arabic French German Russian Spanish Portuguese Japanese Korean Italian
Next Page	Page 1/4	Press this button to enter second page.

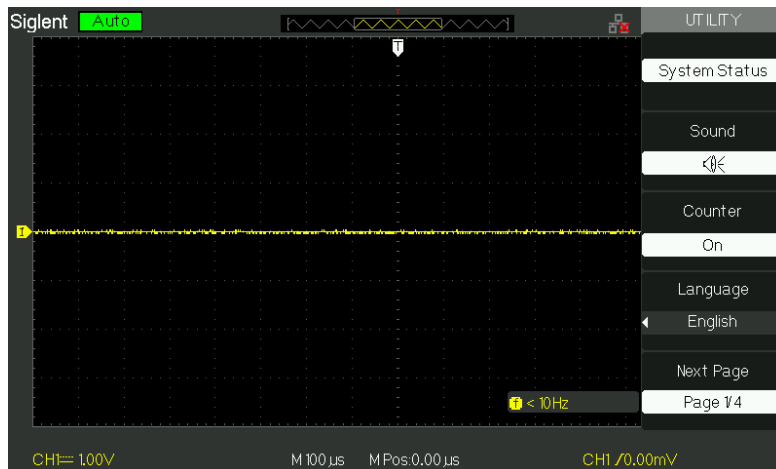

Picture 2.13-2

Table 2-49 Utility System function menu 2:

Option	Setting	Introduction
Do self cal		Auto self emendation.
Do Self Test	Screen Test Keyboard Test LED Test	Run the screen detect program Run the keyboard detect program Run the dot lighten detect program.
Back USB	USBTMC	The oscilloscope connects to the computer using USB cable. When you execute EasyScopeX software, please select “USBTMC”. Now the computer icon displays on the screen.
Next Page	Page 2/4	Press this button to enter third page.

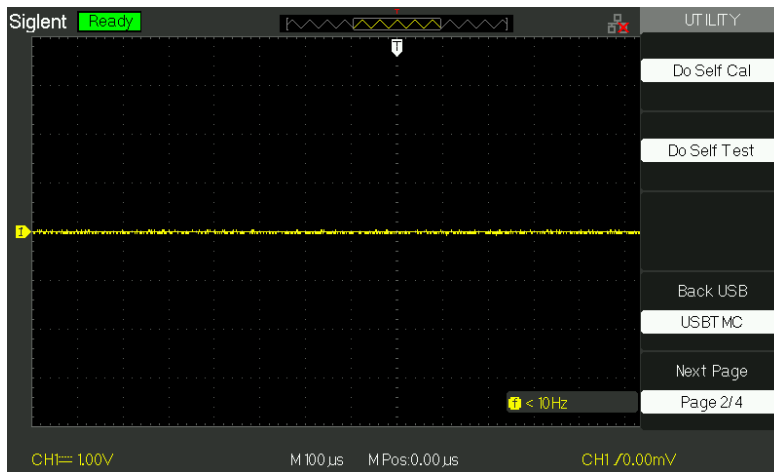

Picture 2.13-3

Table 2-50 Functional Menu of the Utility System 3:

Option	Setting	Introduction
Update firmware		You can update the oscilloscope use USB flash Driver (About need two minutes).
Pass/Fail		Pres this button to enter the “Pass/Fail menu”.
Record		Press this button to enter the waveform record menu.
IO Setting		IP Setting GPIB
Next Page	Page 3/4	Press this button to enter first page.

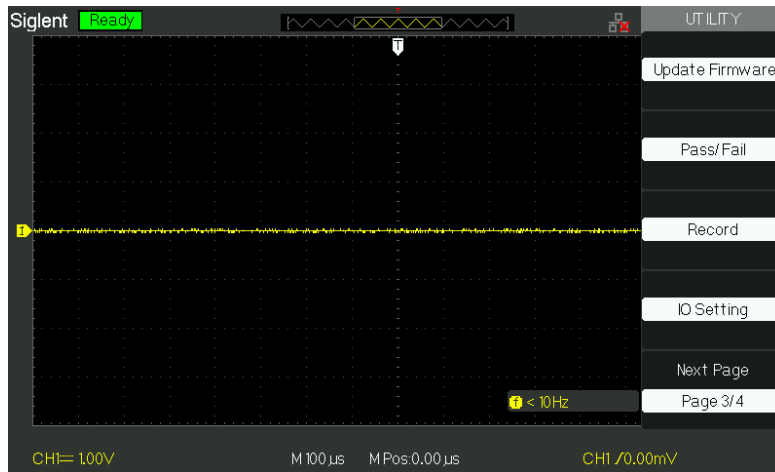

Picture 2.13-4

Table 2-52 Function Menu of the Utility System □

Option	Setting	Introduction
Screen-saver	1min, 2min, 5min, 10min 15min, 30min, 1hour, 2hour, 5hour ,Off	Set the time of Screen-saver
Recorder		Enter recorder function
Next Page		

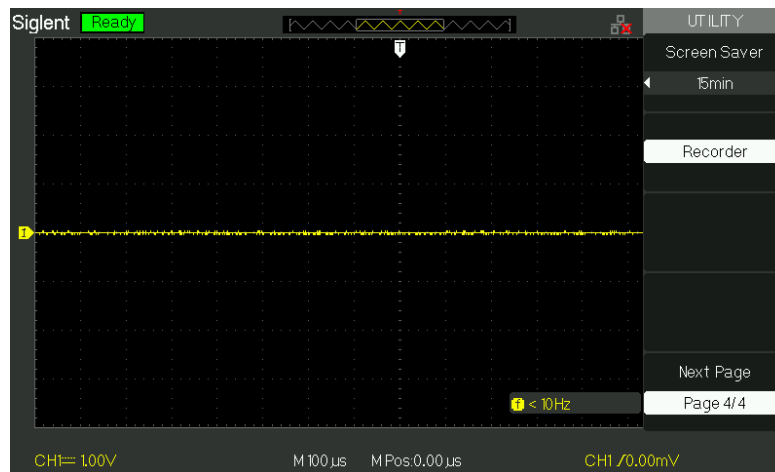

Picture 2.13-5

2.13.1 System Status

Press the “System Status” option button of the Utility Menu to view the oscilloscope’s hardware and software configuration.

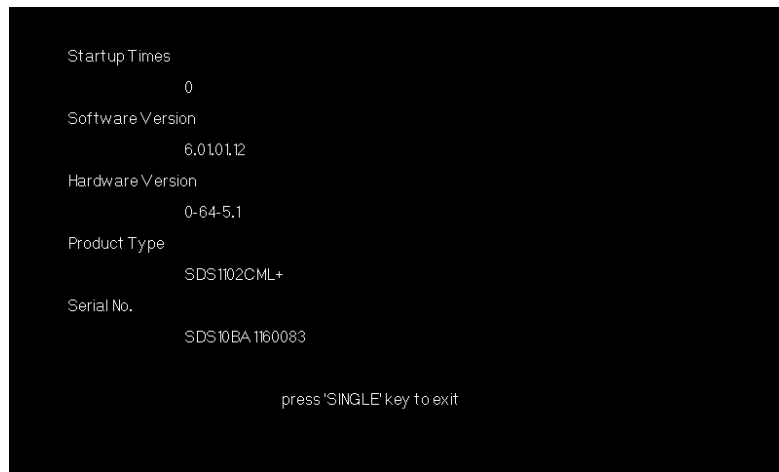

Picture2.13-6

Table 2-53 System status instruction:

Option	Introduction
Startup Times	List the boot-strap times.
Software version	List the software version.
Hardware Version	List the hardware version.
Product type	List the product type.
Serial No.	List the product serial number.

2.13.2 Language

The oscilloscopes have twelve languages’ user menu to be selected.

Press the “Utility” button □“language” to select language.

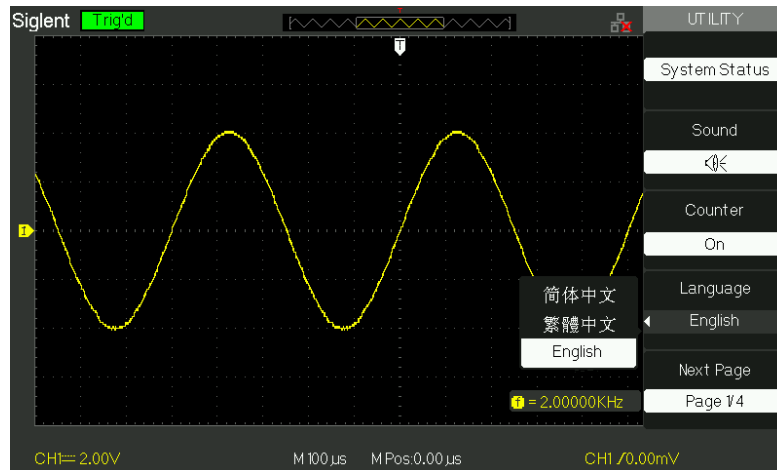

Picture 2.13-7

2.13.3 Self Calibration

Self Calibration procedure can optimize the signal path at the most measurement precision. You can run this procedure at any time. If the operating temperature changes by more than 5° C or the units run more than thirty minutes, you should do the self calibration.

When you run the self Calibration, you should cut off all the probes and lead. Then press the “Utility” button to choose the “Do self cal” to show the self Calibration Menu, and execute self calibration program according to the prompting on the screen.

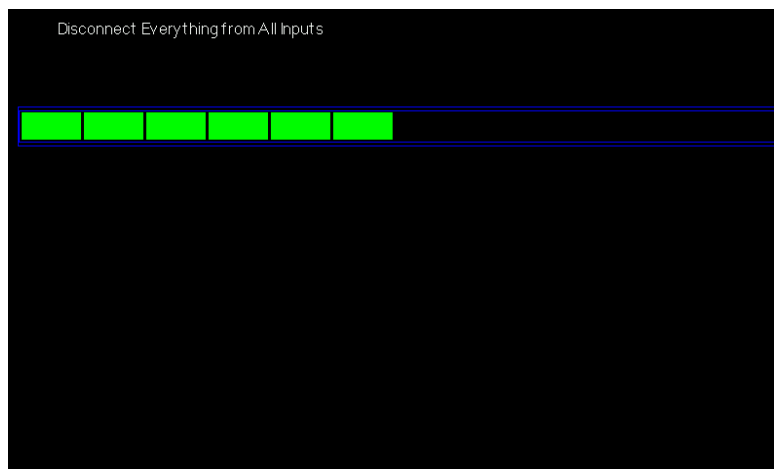

Picture 2.13-8

2.13.4 Self Test

Press “UTILITY”→ “Do Self Test”

Table2-54

Option	Introduction
Screen Test	Run Screen Test Program.
Keyboard Test	Run Keyboard Test Program.
LED Test	Run LED Test Program.

Operation Steps:

1. Screen Test:

Select “Screen Test” to enter the screen test interface. The clew words “Press ‘SINGLE’ Key to continue□Press ‘RUN/STOP’ Key to exit” is displayed, you could press the “Single” for test.

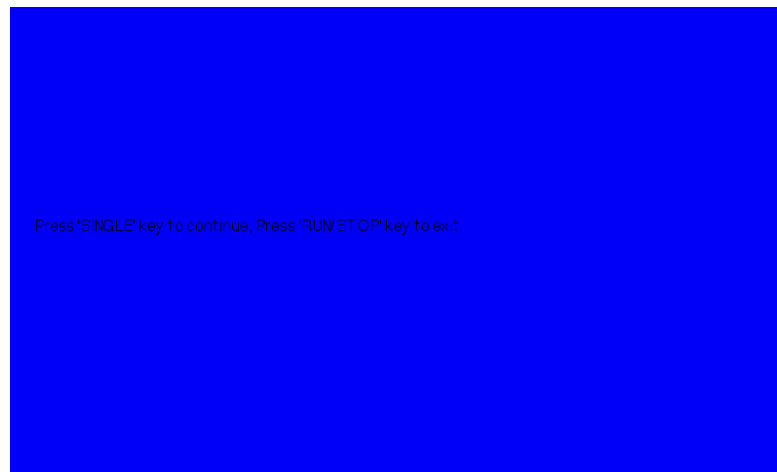

Picture 2.13-9

2. Keyboard Test

Select “keyboard Test” to enter the key test interface, the on-screen lathy rectangle shapes represent the front panel keys. The shapes with two arrows beside them represent the front panel knobs. The squares represent the knob presses for scale knobs. Test all keys and knobs and you should also verify that all the backlit buttons

illuminate correctly.

Note

- When you operate, the screen would display the white (Color LCD) and black (single LCD) repose.
- The tested button or knobs corresponding area would display green (Color LCD) or white (single LCD).
- At the bottom of the screen display “Press ‘ RUN/STOP’ Key Three Times to exit” information prompt to show that press “RUN/STOP” three times for quitting the test .

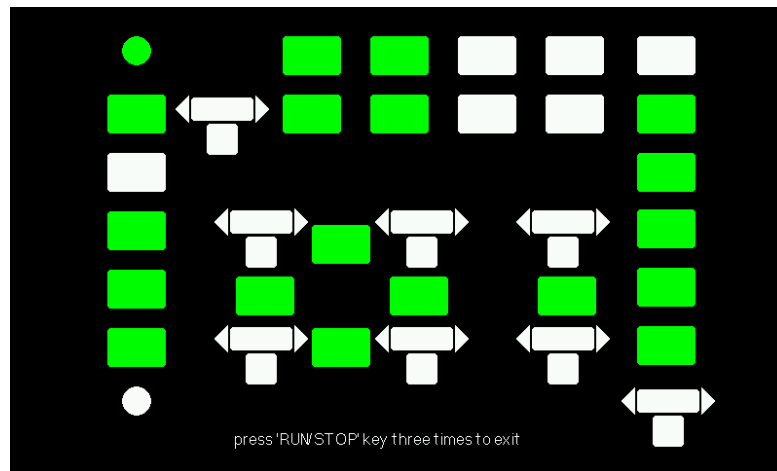

Picture 2.13-10

3. LED test

Select “LED Test” to enter the lighten interface, the on-screen lathy rectangle shapes represent the front panel keys; the lathy rectangle shapes represent the front panel knobs. The squares represent the knob presses for scale knobs. The clew words “Press ‘SINGLE’ Key to continue , Press ‘RUN/STOP’ Key to exit” is displayed, you could press the “Single” button continuously for testing, when buttons are lighted ,the corresponding area on the screen would display green(Color LCD) or white(Single LCD).

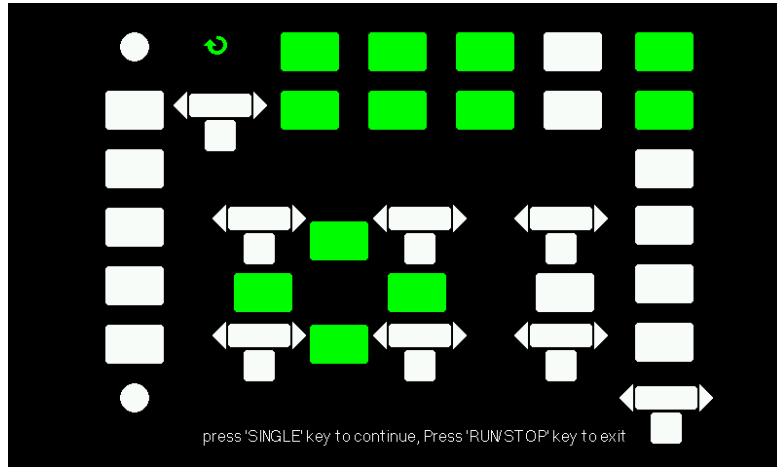

Picture 2.13-11

2.13.5 Updating the System Software

■ Using USB flash drive update firmware

The software of the oscilloscope can be updated directly via USB Flash drive, this process needs about two minutes. Follow next steps:

1. Insert USB Flash Drive with firmware procedure to USB Host interface on the front panel of the oscilloscope.
2. Press the “UTILITY” button to enter the “Utility menu”.
3. Press “Next Page” option button to enter the third page of “Utility menu”.
4. Press the “Update Firmware” option button.
5. Press the “SINGLE” button to start updating the software according to prompt on the screen.

Turn off the oscilloscope and turn on it again, the software has been updated. The oscilloscope needs to execute “Do Self Cal” after update.

Note: Don’t cut off the power while the oscilloscope is updating.

2.13.6 Pass/Fail

The Pass/Fail function can monitor changes of signals and output pass or fail signals by

judging the input signal is within the predefined mask or not.

Table 2-55 Pass/Fail function menu 1:

Option	Setting	Instruction
Enable	On	Turn on Pass/Fail function.
	Off	Turn off Pass/Fail function.
Source	CH1 CH2	Select signal input channel.
Operate	✗	Press to run the Pass/Fail test.
	✗	Press to stop the Pass/Fail test.
Msg Display	On	Turn on times information display of the waveform pass/fail.
	Off	Turn off times information display of the waveform pass/fail.
Next Page	Page 1/2	Press this button to enter second page of Pass/Fail menu.

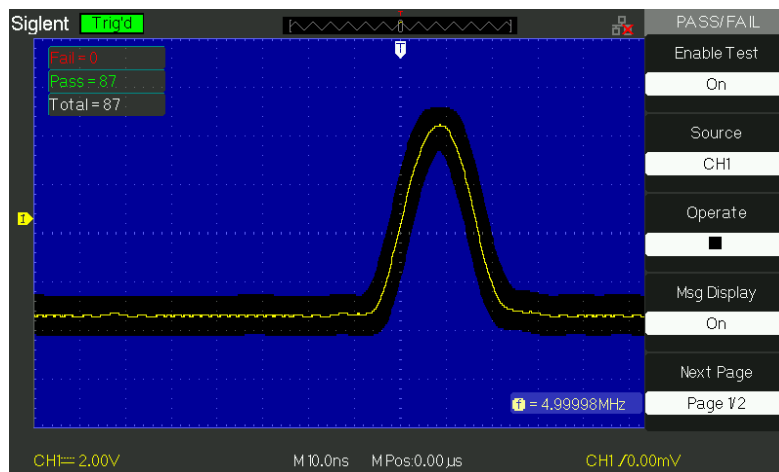

Picture 2.13-12

Table 2-56 Pass/Fail function menu 2:

Option	Setting	Instruction
Stop On Output	On	Stop test when output occur.
	Off	Continue test when output occur.
Mask Setting		Enter the "Mask Setting menu".
Return		Return to the Pass/Fail main menu.
Next Page	Page 2/2	Return to the first page of Pass/Fail menu.

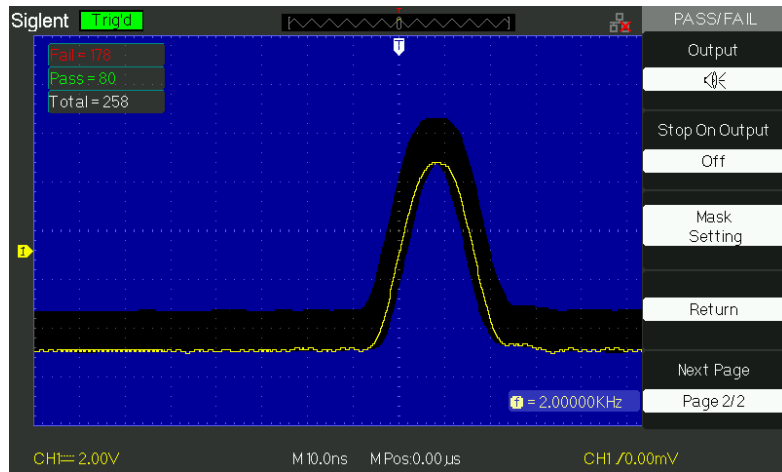

Picture 2.13-13

Table 2-57 Mask Setting function menu 1:

Option	Setting	Instruction
X Mask ↻ _{xdiv}		Turn the “Universal” knob to set the range of horizontal clearance to the waveform. <0.04div-4.00div>
Y Mask ↻ _{ydiv}		Turn the “Universal” knob to set the range of vertical clearance to the waveform. <0.04div-4.00div>
Create Mask		Create a test mask according to the above clearance.
Location	Internal External	Select position to store created mask.
Next Page	Page 1/2	Enter the second page of “Mask Setting menu”.

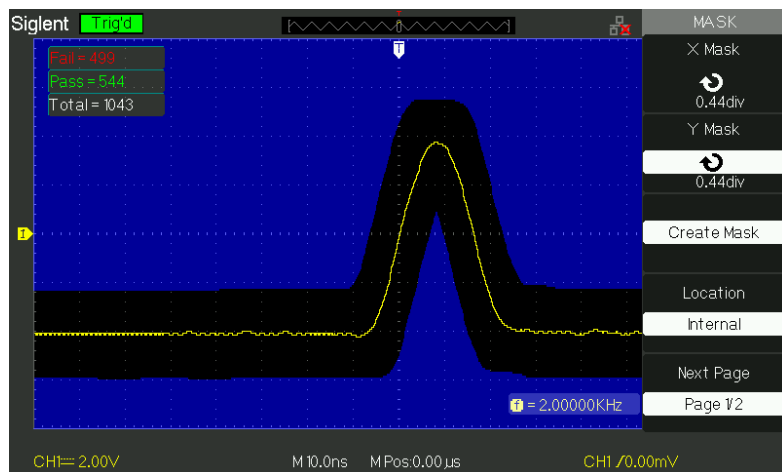

Picture2.13-14

Table 2-58 Mask Setting function menu 2:

Option	Setting	Instruction
Save		Store created mask setting.
Load		Recall stored mask setting.
Return		Return to the main menu of mask setting.
Last Page	Page 2/2	Return to the first page of “Mask Setting menu”.

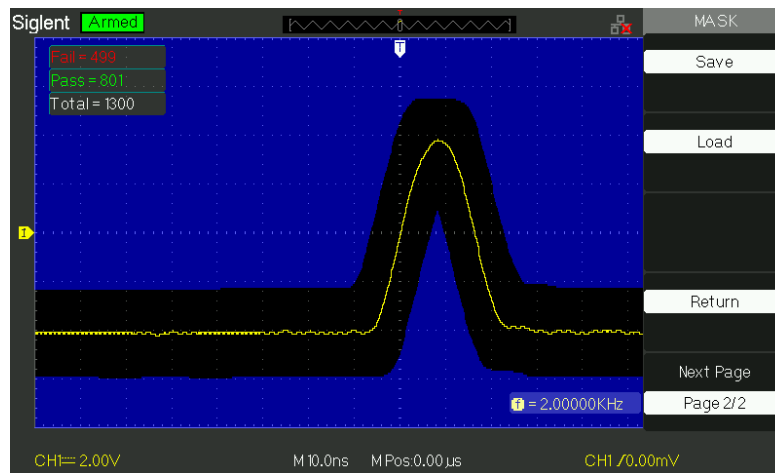

Picture 2.13-15

RUN Pass/Fail test, please follow next page:

- 1) Press UTILITY button to enter the “Utility menu”.
- 2) Press the “Next Page Page1/4” option button.
- 3) Press the “Next Page Page2/4” option button to enter the third page of “Utility menu”
- 4) Press the “Pass/Fail” option button to enter the “Pass/Fail” function menu.
- 5) Press the “Enable Test” option button to select “On”.
- 6) Press the “Source” option button to select input signal channel.
- 7) Press the “Next Page Page1/2” option button to enter the second page of the “Pass/Fail menu”.
- 8) Press the “Mask Setting” option button to enter the first page of “Mask menu”.
- 9) Press the “X Mask” button; turn the “Universal” knob to adjust the horizontal clearance.
- 10) Press the “Y Mask” button; turn the “Universal” knob to adjust the vertical clearance.

- 11) Press the “Create Mask” button to create mask and you also can enter the next page of “Mask menu” to recall the stored mask.
- 12) Enter the second page of “Pass/Fail function menu”, press the “Output” option button to set the output option.
- 13) Enter the first page of “Pass/Fail function menu”, press the “Operate” option button to select “X” to run the pass/fail test.

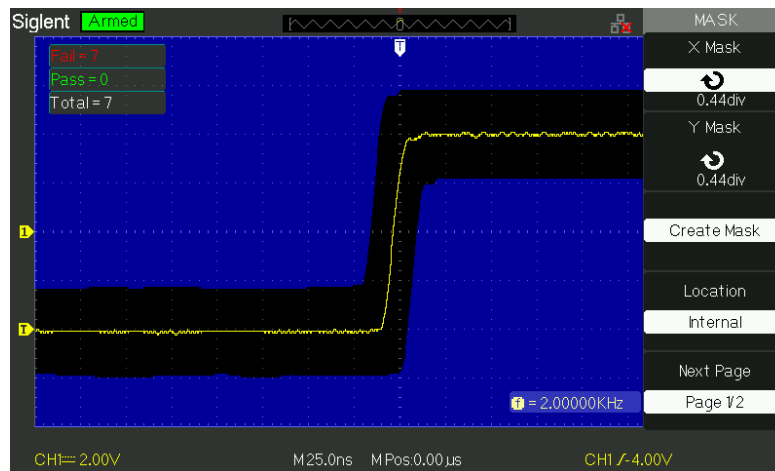

Picture 2.13-16





2.13.7 Waveform Record

Waveform record can record input waveform from CH1 and CH2 with a maximum record length of 2500 frames. This record behavior can also be activated by the pass/fail test output, which makes this function especially useful to capture abnormal signals in long term without keeping an eye watching it.

Waveform recorder: Record the waveforms with specified interval.

Table 2-59 Waveform recorder function menu:

Option	Setting	Instruction
Mode	Record	Set Record function menu.
	Play Back	Set Play Back function menu.
	Storage	Set Storage function menu.
	Off	Turn off waveform recorder menu.

Source	CH1 CH2 P/F-OUT	Select record source channel.
Interval		Set time interval between record frames.
End Frame		Set max number of record frames.
Operate	 <input type="checkbox"/> Record <input type="checkbox"/>  <input type="checkbox"/> Stop <input type="checkbox"/>	Press to start recording. Press to stop recording.

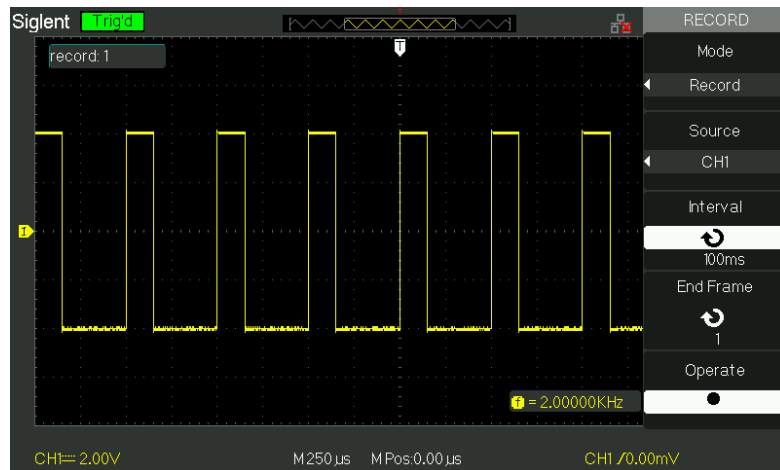



Picture2.13-17

To record waveforms, follow these steps:

1. Press the UTILITY button to enter “Utility menu”.
2. Press the “Next Page” option button to enter the third page of “Utility menu”.
3. Press the “Record” button to enter “Waveform Record Menu”.
4. Press the “Mode” option button to select “Record”.
5. Press the “Source” option button to select the input signal channel.
6. Select “Interval” option, turn the “Univeral” knob to adjust time interval between record frames.
7. Select “End Frame”, select the “Universal” knob to adjust the max record frame.
8. Press “”in “Operate” option to record waveform.

Play Back: Play back current record waveforms or saved record waveforms.

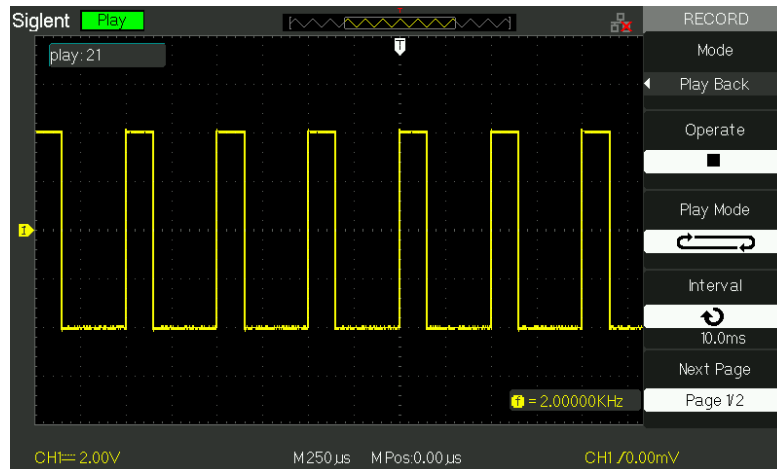

Table 2-60 Waveform play back function menu 1

Option	Setting	Instruction
Mode	Play Back	Set the Play Back function menu.
Operate	Run Stop	Press to start playback playing. Press to stop playing.
Play Mode	 	Set circular play mode. Set single time play mode.
Interval		Set time interval between frames.
Next Page	Page 1/2	Enter the second page of Play Back menu.



Picture 2.13-18

Table 2-61 Waveform play back function menu 2:

Option	Setting	Instruction
Start Frame		Set start frame.
Curr_Frame		Select current frame to be played.
End Frame		Set End frame.
Return		Press to return the waveform recorder main menu.
Next Page	Page 2/2	Return to the first page of Play Back function menu.

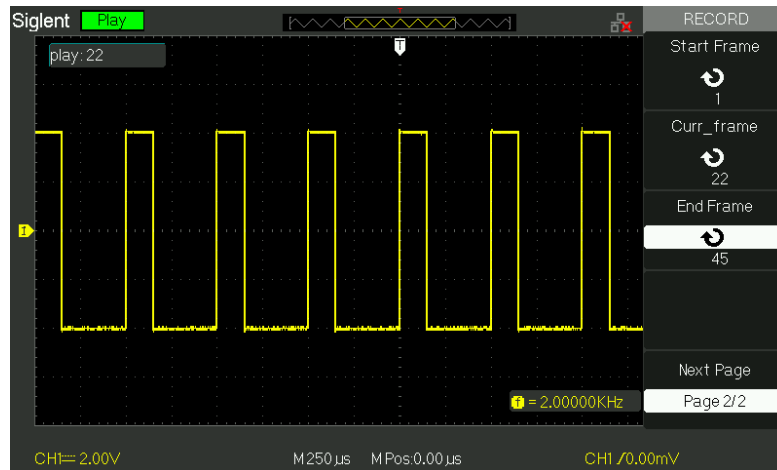

Picture 2.13-19

To play back current record waveforms, follow these steps:

1. Press UTILITY button to enter “Utility menu”.
2. Press the “Mode” option button to select “Play Back”.
3. Press the “Play Mode” option button to select “↺” or “▶▶”.
4. Press the “Interval” option button to select time interval between play back frames.
5. Press the “Next Page 1/2” to enter the second page of “Play Back function menu”.
6. Select the “Start Frame” option, turn the “Universal” knob to adjust the start frame of play back waveform.
7. Select the “End Frame” option, turn the “Universal” knob to adjust the end frame of play back waveform.
8. Press the “Next Page 2/2” option button to return the first page of “Play Back menu”.
9. Press the “✗” option button in “Operate” option to play back waveforms.

2.13.8 Recorder

The waveform recorder is a kind of seamless and no-gap real time recording of waveform, means oscilloscope can save and replay waveform every time it captured. It is similar to waveform recording instrument, and the biggest recording size of its internal memory is 6M

Table 2-62 waveform recording function menu

option	description
Record	record the waveform persistently
Replay	Replay recorded waveform, refer to table 2-64
Option	Set the recorder properly, refer to table 2-65
Return	Quit the recording function

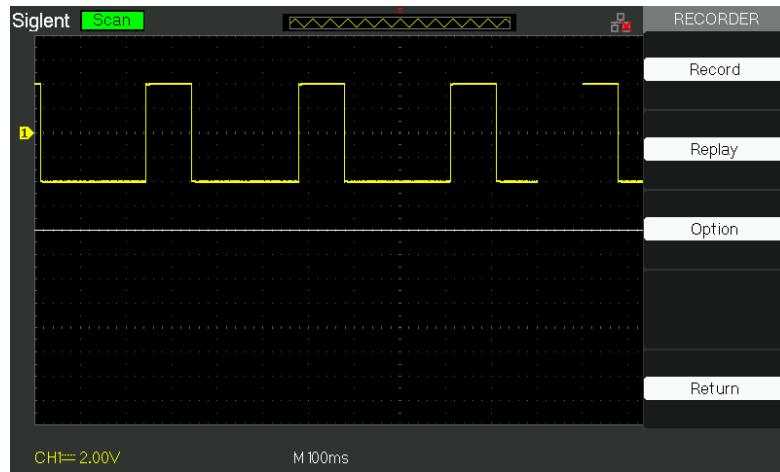

Picture 2.13-20

Table 2-63 waveform replay function menu

Option	Description
Pause	Pause the replay function
Restart	Restart the replay function
Previous	Recall the waveform again
Next	Fast forward play the recalled waveform again
Return	Quit the recalling interface

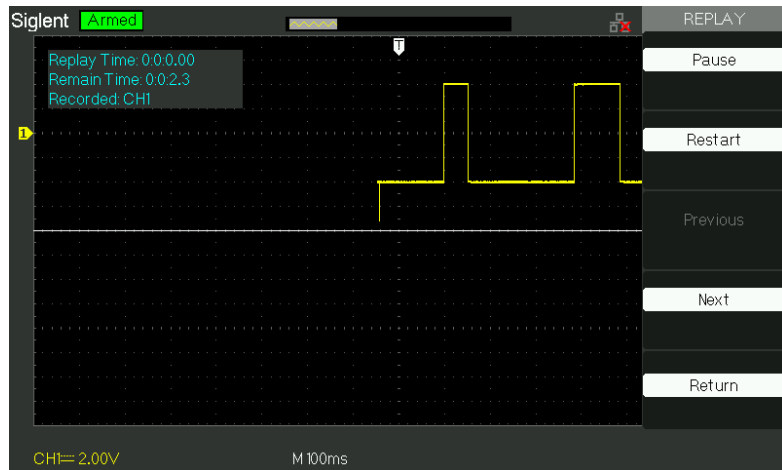

Picture 2.13-21

Table 2-64 recorder's setting menu

Option	Setting	Description
Viewer	Full Screen	Waveform of Full screen recording and channel recalling
	Split	Waveform of recording on split screen and channel recalling, CH1 is displayed in upper half-screen, CH2 is displayed in lower half-screen.
Record Mode	Continuous	Recorder saves the channel waveform persistently; the latter waveform will cover the former.
	Single	Recorder will stop waveform saving when its memory is up to 7M.
Replay Mode	By point	when recalling, the screen waveform refresh from left to right
	By frame	When recalling, screen waveform will refresh completely according to the capturing time of each frame
Return		quit the recording setting interface

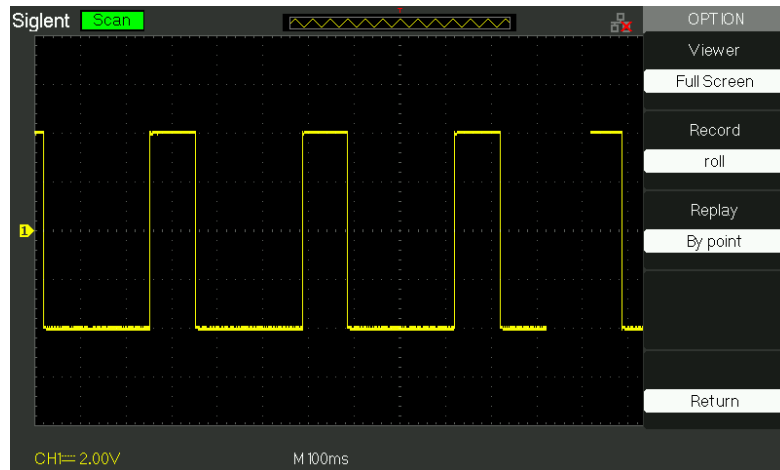

Picture 2.13-22

Recorder Operation step

1. Press the UTILITY button to enter “Utility menu”.
2. Press the “Next Page” option button to enter the four page of “Utility menu.
3. Press the “Recorder” button to enter the Recorder manual.
4. Press the “Option” button to select the parameter which you want by yourself
5. Press the “Recorder” button to enter the Record menu and then Press the “Start” button to start record waveform
6. After finished record waveform, then Press the “Replay” button to view the recorded waveform.

2.13.9 Remote Control

There are two means to remotely control the oscilloscope:

Use user-defined programming

User can control the oscilloscope by programming through standard SCPI (Standard Commands for Programmable Instruments) commands. For more details about commands and programming, Please refer to Programming Manual.

Use PC software offered by GLOBAL SPECIALTIES or other manufacturers

User can send command to remotely control the oscilloscope through PC software EasyScope which offered by GLOBAL SPECIALTIES. Besides, “Measurement & Automation Explorer” which provided by NI (National Instruments Corporation) also can be used to control the oscilloscope. This oscilloscope can communicate with a PC by a USB bus. This part will show how to use EasyScope to remotely control an oscilloscope by USB interface.

Control by USB

Connect Instrument

Use a USB data wire to connect the oscilloscope (USB Device) to a PC.

Installing USB Device

Set oscilloscope Back USB to USBTMC. If you have installed EasyScope or NI software, the PC will pop-up a hardware update guide dialogue box which shows below when you connect the oscilloscope to the computer correctly for the first time, and please install the “USB Test and Measurement Device” device program follow the prompting messages. Below are the steps:

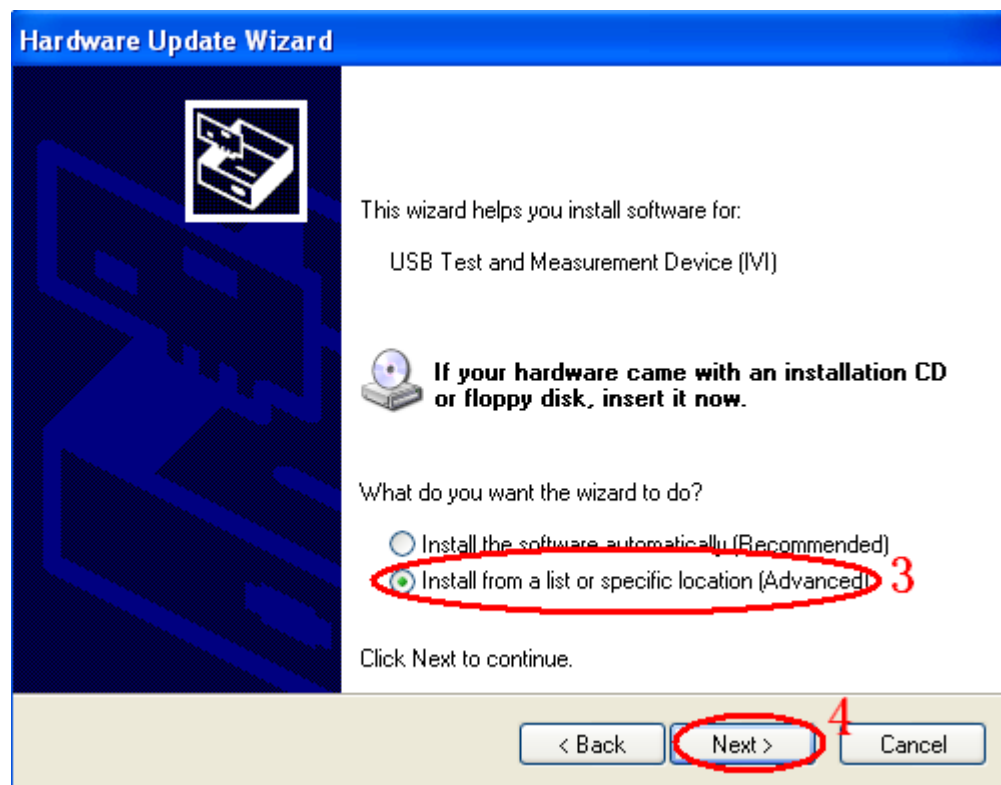
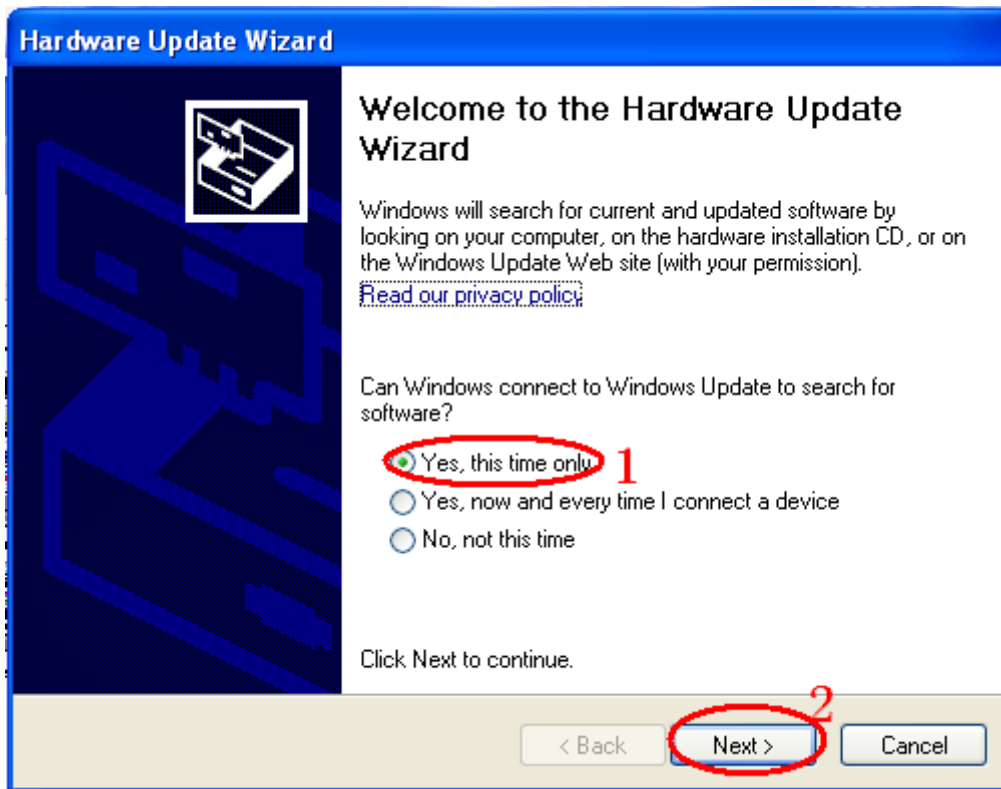

Hardware Update Wizard

Please choose your search and installation options.



Search for the best driver in these locations.

Use the check boxes below to limit or expand the default search, which includes local paths and removable media. The best driver found will be installed.

Search removable media (floppy, CD-ROM...)

Include this location in the search:

E:\

Browse

Don't search. I will choose the driver to install.

5

Choose this option to select the device driver from a list. Windows does not guarantee that the driver you choose will be the best match for your hardware.

< Back

Next >

Cancel

6

Hardware Update Wizard

Select the device driver you want to install for this hardware.



Select the manufacturer and model of your hardware device and then click Next. If you have a disk that contains the driver you want to install, click Have Disk.

Show compatible hardware

Model

- USB Test and Measurement Device (IVI)

This driver is digitally signed.
[Tell me why driver signing is important](#)

Have Disk...

< Back **Next >** Cancel

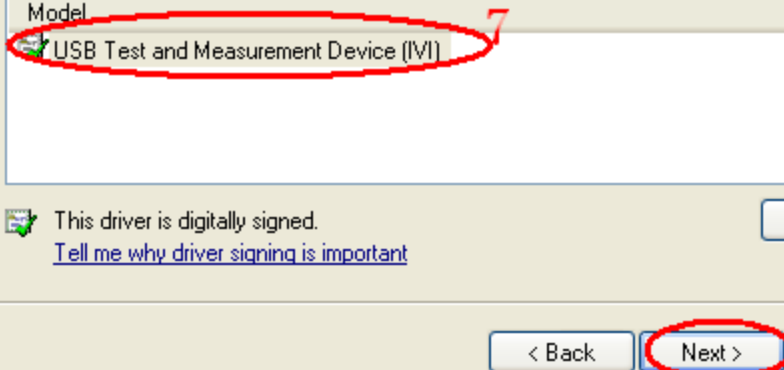

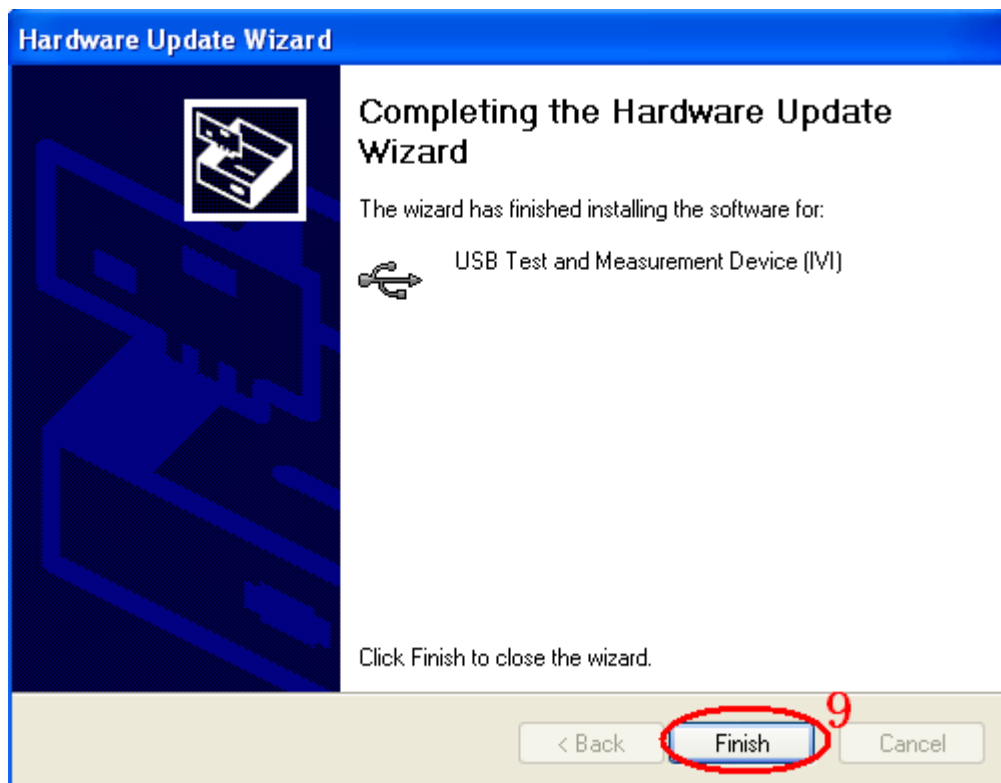
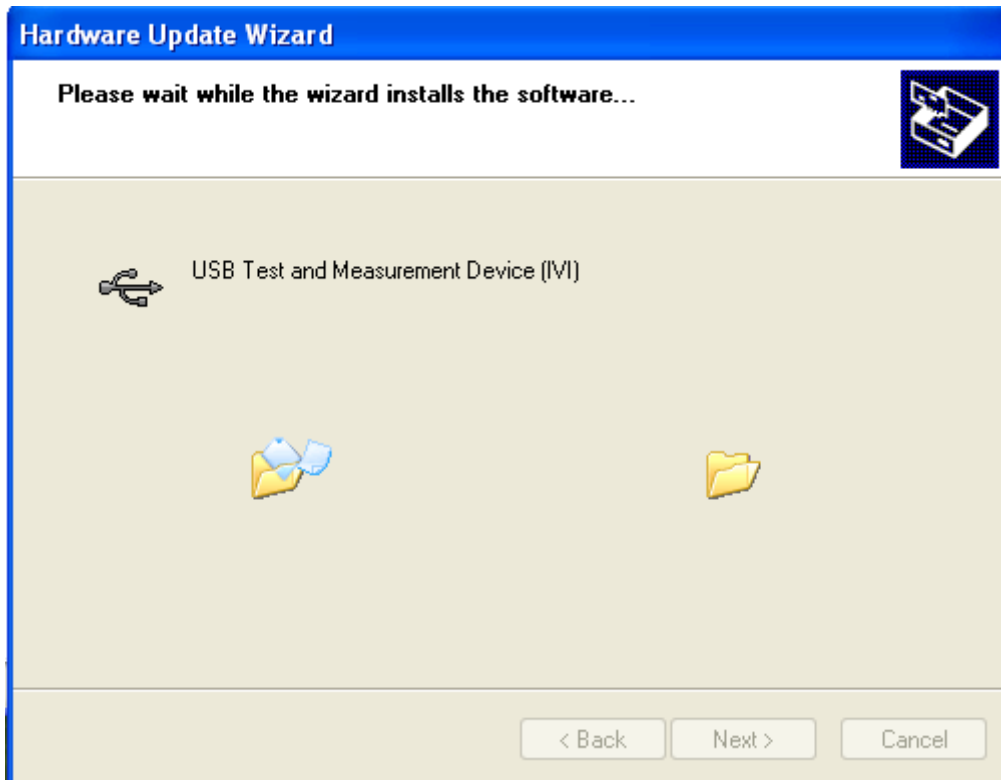

Research Device

Open EasyScope software; click “add device” to research, there will pop-up the following dialogue box, then click Add.

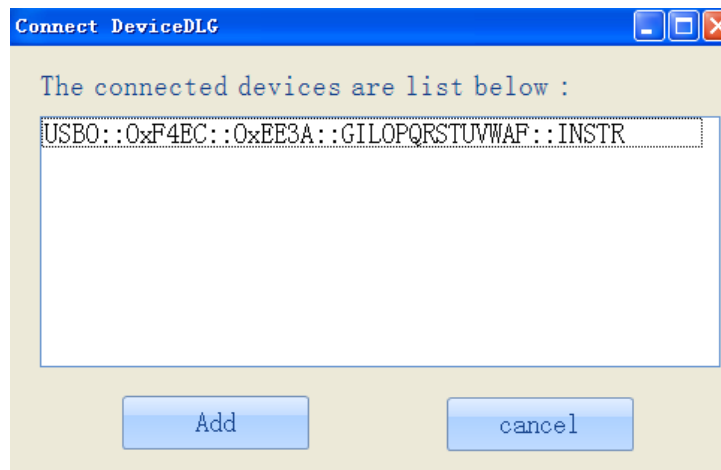

Check Instrument Resource

The instrument information which has been researched is as the picture below. It shows the instrument number and the USB interface information.



Communicate test

Click “SCPI control” and choose “common SCPI”: *IDN?, click Enter to send command. The software will accept the data and display the instrument information. See picture below.

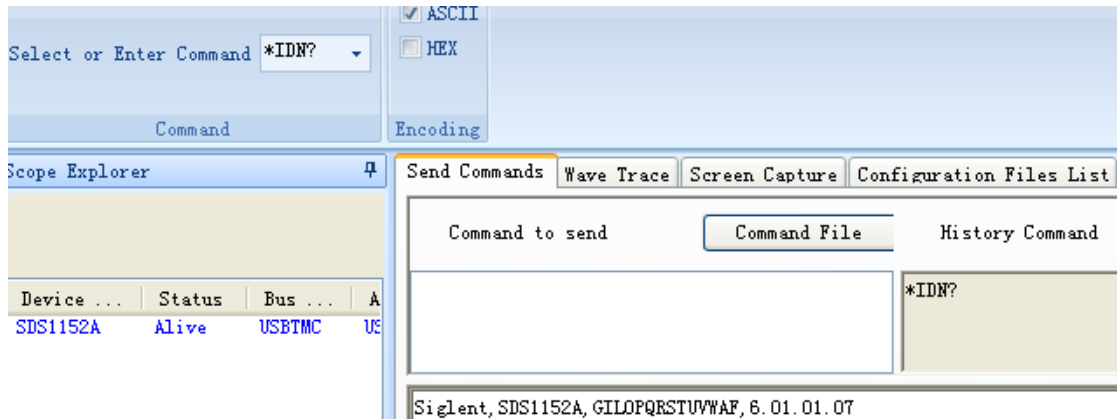

2.14 Online Help Function

The oscilloscope has an online help function that supplies multi-language help information, and you can recall them to help you operate the oscilloscope when you need.

Press the “HELP” button to enter the help status, then press every button to recall the corresponding help information. Note□If you want to see help information of SINGLE button and RUN/STOP button, you need to see them when you first enter the help status because you press the SINGLE button can enter next page of help information and Press the RUN/STOP button can return to the first page of help information when other button’s help information exceed one page.

All submenus of every main menu have their help information. Note: If you want to see help information of next page submenus, first you need to press the “HELP” button to exit the help status and switch to next page menu then press the “HELP” knob to enter the help status again and press the submenu option buttons to see its help information.

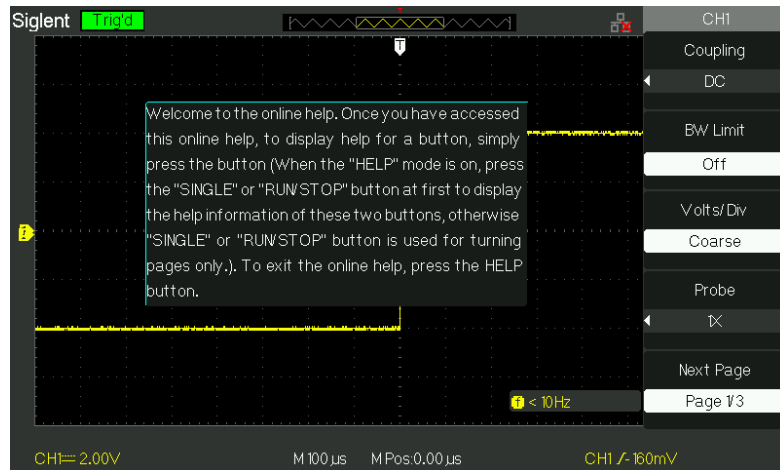

Picture 2.14-1

Chapter 3 Prompting Messages and Troubleshooting

3.1 Prompting Messages:

- **Trig level at limit!** : Mention you that the trigger Level is at a limit when you turn the Trig level knob.
- **Horizon position at limit!** : Mention you that the horizontal position is at a limit when you turn the horizon position knob.
- **Volts/Div at limit!** : Mention you that the vertical voltage have already touched the Min 2MV/div or the Max 10V/div.
- **Volts position at limit!** : The system would display this information when the vertical position is at a limit.
- **Sec/Div at limit!** : Prompts that the Volts/Div is at full range while turning the vertical scale knob.

- **Holdoff time at limit!** : Turn the “Universal” knob when holdoff time has been to max or min value, now the system will clew this information.
- **Functions isn’t useable!** : Under several special modes, the some functions could not be running.
- **No signal!** : The system would clew this information when the signal could not match the auto set condition. (Using in the auto set)
- **Adjust at limit!** : You could adjust the pulse width by the universal knob till the pulse width has reached min20.0ns or max 10.0s.
- **Location Empty!** : If you have no stored waveforms or setups on some location, the screen will display this information when you press the “Recall” button on this location.
- **USB Flash Drive Plug In!** : This information will appear when you invert the USB Flash Drive to the USB Host port.
- **USB Flash Drive Pull Out!** : This information will appear when you pull out the USB Flash Drive.
- **Store Data Success!** : Save setup data, waveform data or picture data to the internal of the oscilloscope or USB flash successful.
- **Ready Data Success!** : Read setup data or waveform data from the internal of the oscilloscope or USB flash successful.
- **Please set Back USB to printer!** : Press the “S/div” knob will appear this information on the screen when the “Print Key” option is set to “Print Picture” and the “Back USB” option is set to “USBTMC”.
- **USB Flash Drive isn’t connected!** : When the “Save To” option is set to “File” or the “Print Key” option is set to “Save Picture” in “Save/Recall” menu , Press the “Save” option button or the “S/div” knob before inverting the USB Flash Drive to the USB Host port will appear this information on the screen.
- **Record Wave Success!** □ This message will appear when you finish recording waveforms.

3.2 Troubleshooting

1. After the oscilloscope is powered on, the screen remains dark, please do as following steps:

- Check the power cable's connection.
- Ensure the power switch is turned on.
- After the inspections above, restart the oscilloscope.
- If the oscilloscope is still not used after the checking, please connect with Global Specialties

2. If there is no signal wave in the screen after gathering the signal, please do as following steps:

- (1) Check the probe connecting with the signal cable or not
- (2) Check the signal cable connecting with the BNC connector or not.

- (3) Check the probe whether connect with the goods tested or not.
- (4) Check the tested goods produce the signal or not.
- (5) Gather the signal again.

3. The value of the tested voltage is 10 times higher/lower than the real one , please do as following steps:

Check the attenuation quotient whether match the probe attenuation proportion or not.

4. Display the wave, but not steady, please do the following steps:

- (1) Check the signal source on the trigger interface whether or not matches the signal channel.
- (2) Check the trigger mode: normal signal should use the “edge” trigger mode. The video signal should use the “Video” Trigger mode. The signal would display steady, only using the matching trigger mode.
- (3) Attempt to change the “coupling” into “HF Reject” or “LF Reject” display, so that the High/low frequency noise disturb the trigger should be filtrated

5. Press “RUN/STOP” button, but no display.

Check the trigger mode on the trigger interface whether or not in the “normal” or “single”, and check the trigger level is whether or not over the wave range. If yes, please put the trigger level to the middle position or set the trigger mode to the “Auto” position. In another hand, you could choose the “Auto” button to set up automatically.

6. After the Acquisition is set to Averages or Display Persistence time is set too long, the waveform refreshes slowly.

It is normal in these settings

7. The signal is displayed as ladder like waveform

- (1) This phenomenon is normal. The time base maybe is too slow .you should turn the horizontal scale knob to increase horizontal resolution to improve the display.
- (2) Maybe the display Type is set to “Vectors”, You could set it to Dots mode to improve the display.

Appendix A: Default Setup

Menu or system	options <input type="checkbox"/> knobs or buttons	Default setup
CH1,CH2	Coupling	DC
	BW limit	Off
	Volts/div	Coarse
	Probe	1X
	Invert	Off
	Filter	Off
	Volts/div	1.00V
MATH	Operation	CH1+CH2
	CH1 Invert	Off
	CH2 Invert	Off
	FFT operation:	
	Source	CH1
	Window	Hanning
	FFT Zoom	1X
	Scale	dBVrms
Display	Split	
HORIZONTAL	Window	Main
	Position	0.00 μ s
	Sec/div	500 μ s
	Window Zone	50.0 μ s
	Trigger knob	level
CURSOR	Type	Off
	Source	CH1
	Horizontal (voltage)	+/-3.2divs
	Vertical (time)	+/-5divs
ACQUIRE	three mode options	Sampling
	Averages	16
	Sampling mode	Real Time
DISPLAY	Type	Vectors
	Persist	off
	Gird	

	Intensity	60%	
	Brightness	40%	
	Format	YT	
	Menu Display	infinite	
SAVE/RECALL	Type	Setups	
	Save To	Device	
	Setup	No.1	
REF	REFA/REFB	REFA	
	Source	CH1	
	REFA	off	
	REFB	off	
UTILITY	Sound	on	
	Counter	On	
	Back USB	USBTMC	
	Pass/Fail	off	
	Record	off	
	TRIGGER (edge)	Type	edge
		Source	CH1
		Slope	Rising
		Mode	Auto
		Coupling	DC
	LEVEL	0.00V	
TRIGGER (pulse)	Type	pulse	
	Source	CH1	
	When	=	
	Set Pulse Width	1.00ms	
	Mode	Auto	
	Coupling	DC	
TRIGGER (Video)	Type	Video	
	Source	CH1	
	Polarity	Normal	
	Sync	All Lines	
	Standard	NTSC	
	Mode	Auto	
TRIGGER (Slope)	Type	Slope	
	Source	CH1	
	Time	1.00ms	
	Mode	Auto	
TRIGGER (Alternative)	Type	Alternative	
	Source	CH1	

	Mode	Edge
	Coupling	DC

Appendix B: Daily Maintain and Cleaning

Daily Maintain

DO not store or leave the instrument in where the LCD display will be exposed to direct sunlight for long periods of time.

CAUTION: To avoid damage to the instrument or probes, do not expose them to sprays, liquids, or solvents

Cleaning

If this instrument requires cleaning, disconnect it from all power sources and clean it with a mild detergent and water. Make sure the instrument is completely dry before reconnecting it to a power source.

To clean the exterior surface, perform the following steps:

- 1). Remove loose dust on the outside of the instrument and probes with a lint-free cloth. Use care to avoid scratching the clear plastic display filter.
- 2). Use a soft cloth dampened with water to clean the instrument. Use an aqueous solution of 75% isopropyl alcohol for more efficient cleaning.

Note □

To avoid damage to the surface of the instrument or probes, do not use any abrasive or chemical cleaning agents.
